

**AT** MICROFICHE  
REFERENCE  
LIBRARY

A project of Volunteers in Asia

Management of Solid Wastes in Developing  
Countries WHO Southeast Asia Series No. 1

by: Frank Flintoff

Published by:  
World Health Organization  
Regional Office for  
South-East Asia  
Indraprastha Estate, Ring Road  
New Delhi 110-002, India

Paper copies are \$12.00.

Available from:  
World Health Organization  
Regional Office for  
South-East Asia  
Indraprastha Estate, Ring Road  
New Delhi 110-002, India

Reproduced by permission of the World Health  
Organization.

Reproduction of this microfiche document in any  
form is subject to the same restrictions as those  
of the original document.

WHO Regional Publications  
South-East Asia Series No. 1

# MANAGEMENT OF SOLID WASTES IN DEVELOPING COUNTRIES

by FRANK FLINTOFF



WORLD HEALTH ORGANIZATION  
NEW DELHI

© World Health Organization 1976

Publications of the World Health Organization enjoy copyright protection in accordance with the provisions of Protocol 2 of the Universal Copyright Convention. For rights of reproduction or translation of WHO publications, in part or *in toto*, application should be made to the Division of Publications and Translation, World Health Organization, Geneva, Switzerland. The World Health Organization welcomes such applications.

The designations employed and the presentation of the material in this publication do not imply the expression of any opinion whatsoever on the part of the Secretariat of the World Health Organization concerning the legal status of any country, territory, city or area or of its authorities, or concerning the delimitation of its frontiers or boundaries.

The mention of specific companies or of certain manufacturers' products does not imply that they are endorsed or recommended by the World Health Organization in preference to others of a similar nature that are not mentioned. Errors and omissions excepted, the names of proprietary products are distinguished by initial capital letters.

The author alone is responsible for the views expressed in this publication.

Printed by Anil Ahuja for Impressions at Sanjay Composers & Printers,  
Green Park, New Delhi-110016.

## FOREWORD

Wherever people live, wastes, both liquid and solid, are produced. While the disposal of liquid wastes more often receives priority attention, the management of solid wastes has generally been a neglected field. The aim in developing countries must not be to mimic the technology of industrialized countries, but rather to employ the technology appropriate to their own situations, while still meeting the basic needs of public health.

This book is intended to provide a reference source for engineers, municipal officers, administrators and other interested persons, and to fill a need for a training manual for technicians in a field of universal and growing importance.

It is hoped that this manual will be used widely and that it will be recognized as a contribution to an aspect of environmental health which has perhaps received inadequate attention in the past.

A handwritten signature in cursive script, reading "V.T.H. Gunaratne", is written over a horizontal line. There are three small dots centered below the line.

V.T.H. Gunaratne, F.R.C.P., D.P.H.  
Regional Director



## Author's Note

This book is designed primarily to guide Indian municipal officers who are responsible for the collection and disposal of solid wastes. Its orientation has been influenced, however, by experience gained during about twenty assignments in various developing countries. Most of these were undertaken as a short-term consultant to the World Health Organization and included the South-East Asia, Western Pacific, Pan-American and Eastern Mediterranean regions.

The writer has drawn freely on his own reports on these assignments, in particular "Solid Wastes Management in South-East Asia", which contains the report and working papers of a regional seminar held at Bangkok in 1974. "Solid Wastes Management in India", a report on a Government of India—WHO workshop, held at Ahmedabad (Gujarat) in 1975, has also been a valuable source. Other sources of material are acknowledged in the text.

A word of warning may be necessary with regard to costs. Because the comparative costs of alternative systems represent a most important criterion, there are frequent references in the text to capital and operating costs. These are thought to be reasonably accurate averages for India over the period 1975-76, but they conceal significant regional variations. It may be necessary, therefore, for readers to revise some of these figures in the light of known current unit costs for their areas. This applies particularly to readers from other countries who may also like to know that the average exchange rate during the period of data collection was about 8.5 Indian rupees to the US dollar. (For a rapid approximate conversion to US \$ during reading, simply move the decimal point one place to the left.)

The author wishes to place on record his acknowledgements to the many persons and organizations who have assisted him in the preparation

of this manual, who have reviewed and commented on the drafts and who have given freely of their advice and experience. Overall acknowledgement is due to the Government of India for sponsoring this manual, and to the South-East Asia Regional Office of WHO for executing it. It is not feasible to mention here by name all the individuals who have collaborated and contributed to this publication, but particular appreciation must be expressed of the input and guidance of the following:

Mr T. S. Swamy —Adviser (PHEE), Central Public Health and Environmental Engineering Organization, Ministry of Works and Housing, Government of India.

Mr A. K. Saraf—Assistant Adviser (PHEE), Central Public Health and Environmental Engineering Organization, Ministry of Works and Housing, Government of India.

Mr A. D. Bhide—Chief, Solid Wastes Division, National Environmental Engineering Research Institute, Nagpur.

## CONTENTS

CHAPTER 1. INTRODUCTION	1
1.1. Sources and Characteristics	4
1.2. Health and Environmental Implications	5
1.3. Economic Implications	6
1.4. Human Resources	6
CHAPTER 2. SAMPLING METHODS	7
2.1. Generation	7
2.1.1. Generation in relation to collection and disposal	7
2.1.2. Requirements for estimating domestic and trade wastes	8
2.1.3. Proposed method of collection of samples	8
2.1.4. Collection of samples from communal containers	9
2.2. Analysis and Projection	10
2.2.1. Collection of samples	10
2.2.2. Method of analysis	10
2.2.3. Information from analysis	11
2.2.4. Equipment required	12
2.2.5. Projections	12
CHAPTER 3. REFUSE STORAGE AND COLLECTION	14
3.1. Communal Storage	14
3.2. House-to-house Collection	15
3.3. Industrial Wastes	15
3.4. Re-cycling	17
3.5. Problems of Storage and Collection	17
3.6. Constraints	17
3.7. Deficiencies in Techniques	18
CHAPTER 4. ELEMENTS OF REFUSE COLLECTION	19
4.1. Refuse Characteristics and Sources	19
4.2. Work Components of Refuse Collection	21
CHAPTER 5. FREQUENCY OF COLLECTION	24
5.1. Communal Storage	24
5.2. Collection Direct from Premises	25
5.3. Cost	25
CHAPTER 6. REFUSE STORAGE METHODS	27
6.1. Domestic Premises and Shops	27
6.2. Communal Storage Methods	28
6.2.1. Depots	29
6.2.2. Enclosures	30
6.2.3. Fixed storage bins	31

6.2.4. Concrete pipe sections	31
6.2.5. 200-litre drums	32
6.2.6. Portable steel bins	33
6.2.7. Conclusions on communal wastes containers	34
6.3. Capacity Margins	35
<b>CHAPTER 7. REFUSE COLLECTION VEHICLES</b>	<b>37</b>
7.1. Basic Aims of Vehicle Design	38
7.2. Handcarts	38
7.3. Pedal Tricycles	40
7.4. Animal Carts	40
7.5. Pedestrian-electric Vehicles	40
7.6. Motor-tricycles	42
7.7. Tractors and Trailers	42
7.8. 5-7 Tonne Truck	44
7.9. 5-7 Tonne Low-loading Chassis	46
7.10. Barrier Loader	46
7.11. Fore and Aft Tipper	50
7.12. Container-hoist Vehicles	50
7.13. Vehicle Standardisation	52
<b>CHAPTER 8. ACCESS AND POINT OF COLLECTION</b>	<b>54</b>
8.1. Separate Dwellings	54
8.2. Terraced Dwellings	55
8.3. Dwellings-over Shops	55
8.4. Multi-storey Dwellings	56
8.5. One-room Dwellings	56
8.6. Markets	
8.7. Access for Trailer or Container Exchange	58
8.8. Narrow Lanes	59
<b>CHAPTER 9. BASIC COLLECTION SYSTEMS</b>	<b>60</b>
9.1. Collection from Communal Sites	60
9.2. Block Collection	61
9.3. Kerbside Collection	62
9.4. Door-to-door Collection	63
9.5. Comparative Productivity of Basic Systems	64
<b>CHAPTER 10. PRIMARY AND SECONDARY COLLECTION</b>	<b>65</b>
10.1 Short-range Transfer	65
10.1.1. Primary collection by handcart	65
10.1.2. Secondary collection by tractor-trailer	66
10.1.3. Primary collection by animal cart or motor-tricycle	68
10.1.4. Secondary collection from transfer station	69
10.1.5. Comparative labour and vehicle productivity	69
10.2. Short-range Transfer Stations	71
10.2.1. Level sites	72
10.2.2. Split-level sites	72
10.2.3. Static packers	72
10.2.4. Combined transfer stations and district depots	74

<b>CHAPTER 11. ECONOMICS OF REFUSE COLLECTION</b>	
11.1. Crew Collection	76
11.1.1. Door-to-door and kerbside collection	77
11.1.2. Operation of collection vehicles in relay	77
11.2. Vehicle Operating Costs	82
11.3. Comparative Costs of Alternative Systems	83
<b>CHAPTER 12. STREET CLEANSING</b>	86
12.1. Sources	86
12.1.1. Natural wastes	86
12.1.2. Road traffic wastes	87
12.1.3. Behavioural wastes	87
12.2. Manual Street Cleansing	87
12.2.1. Equipment	88
12.2.2. Sweeping methods	89
12.2.3. Vehicles and transfer facilities	89
12.2.4. Classification of streets	91
12.2.5. Organisation of manual sweepers	91
12.2.6. Transfer facility	91
12.3. Litter Bins	92
12.3.1. Design of litter bins	92
12.3.2. Siting and emptying	92
12.4. Mechanical Sweeping	93
12.5. Legislation	94
12.5.1. Enforcement	94
<b>CHAPTER 13. TREATMENT AND DISPOSAL</b>	95
13.1. Recycling	95
13.2. Pulverisation	96
13.3. Composting	98
13.4. Incineration	98
13.5. Costs	100
13.6. Environmental Aspects	101
13.7. Conclusions	102
<b>CHAPTER 14. SANITARY LANDFILL</b>	103
14.1. Introduction	103
14.2. Decomposition in a Sanitary Landfill	105
14.2.1. Temperature	105
14.2.2. Gases	106
14.2.3. Leachate	106
14.2.4. Conclusions	107
14.3. Control of Hazards	107
14.3.1. Pathogenic organisms	107
14.3.2. Insects	107
14.3.3. Rodents	108
14.3.4. Airborne dust	108
14.3.5. Airborne litter	110
14.3.6. Fire	110
14.3.7. Birds	112

14.3.8. Surface-water pollution	112
14.3.9. Ground-water pollution	113
14.4. Planning a Sanitary Landfill	115
14.4.1 Site selection and land-use policy	115
14.4.2. Location and access	116
14.4.3. Water authorities	116
14.4.4. Final selection of sites	116
14.4.5. Site acquisition	117
14.5. Design of Sites	117
14.5.1. Protective site engineering	120
14.5.2. Operational site engineering	120
14.5.3. Plan of operation	120
14.6. Criteria for Manual or Mechanised Methods	124
14.6.1. Density of wastes and compaction	124
14.6.2. Other forms of compaction	125
14.6.3. Covering material	126
14.7. Manual Operation	127
14.7.1. Access	127
14.7.2. Pegs	127
14.7.3. Formation of strips	127
14.7.4. All-weather operation	132
14.7.5. Labour required	132
14.7.6. Estimated costs	133
14.8. Mechanised Sanitary Landfill	134
14.8.1. Characteristics of machine types	134
14.8.2. Tracks or wheels	136
14.8.3. Machines for landfill	136
14.8.4. Mechanisation in relation to scale of operation	137
14.8.5. Possible operating costs	137
14.9. Particular Aspects of Landfills	141
14.9.1. Water-filled sites	141
14.9.2. Ravines	142
14.9.3. Desert sites and trenching method	142
14.9.4. Small communities	145
14.9.5. Salvage at landfill sites	145
14.10. Model Code of Practice	146
<b>CHAPTER 15. URBAN WASTES AS A SOURCE OF COMPOST</b>	<b>151</b>
15.1. Introduction	151
15.2. Character and Use of Compost	152
15.2.1. Qualities	152
15.2.2. Method of use	152
15.2.3. The place of compost in agriculture	153
15.2.4. The importance of the agricultural authorities	154
15.2.5. Solid wastes management and agricultural needs	154
15.3. Wastes Compost	155
15.3.1. Physical constituents	155

15.3.2. Potential compost production	156
15.3.3. Carbon-nitrogen ratio	156
CHAPTER 16. PRINCIPLES AND ECONOMICS OF COMPOSTING	157
16.1. Principles of Composting	157
16.1.1. Composting organisms	157
16.1.2. Moisture content	158
16.1.3. Sewage sludge as a source of moisture	159
16.1.4. Aeration	160
16.1.5. Health aspects	160
16.2. Compost Control	160
16.2.1. Uncontrolled decomposition	160
16.2.2. Minimum requirements for control	162
16.2.3. Composting systems	162
16.3. Economics of Composting	165
16.3.1. Alternative disposal methods	165
16.3.2. Size of a city	166
16.3.3. Wage levels	166
16.3.4. Energy	167
16.3.5. Indigenous equipment	167
CHAPTER 17. ELEMENTS OF COMPOST PLANTS	169
17.1. Storage and Elevation	169
17.1.1. Storage capacity	169
17.1.2. Reception capacity	171
17.1.3. Deep bunkers	171
17.1.4. Hoppers and slat conveyors	172
17.1.5. Ground storage	173
17.2. Salvage	173
17.2.1. Picking belts	174
17.2.2. Magnetic extraction	174
17.2.3. Salvage treatment	175
17.2.4. Health aspects of salvaging	177
17.3. Size Reduction	178
17.3.1. Hammermills	178
17.3.2. Rasps	179
17.3.3. Short-term drums	180
17.3.4. Long-term drums	181
17.3.5. Shears and cutters	182
17.4. Windrow Layout and Management	182
17.4.1. Transfer to windrow by conveyor	183
17.4.2. Transfer to windrow by tractor	184
17.4.3. Direct delivery to windrows	184
17.4.4. Windrow turning	184
17.4.5. Windrow layout	186
17.4.6. Water supply to windrows	188
17.4.7. Static aeration of windrows	188
17.4.8. Compost turning machines	190
17.5. Screening	190

17.5.1. When to screen	191
17.5.2. Rotary screens	191
17.5.3. Vibrating screens	192
17.6. Ballistic Separation	192
17.7. Storage Area	193
17.8. Weighbridge	193
CHAPTER 18. OUTLINE DESIGNS OF TYPICAL SYSTEMS	196
18.1. Manual Windrow Compost Plant	196
18.1.1. Capacity	196
18.1.2. Method	196
18.1.3. Area required	196
18.1.4. Staff required	197
18.1.5. Rotary screen	197
18.1.6. Cost	197
18.1.7. Bangalore pilot plant	198
18.2. Radial Windrow Compost Plant	200
18.2.1. Windrows	200
18.2.2. Volume to be handled in windrows daily	200
18.2.3. Transfer to treatment plant	202
18.2.4. Treatment plant	202
18.2.5. Transport of products	202
18.2.6. Area	204
18.2.7. Summary of labour and mobile plant required	204
18.3. Post-treatment by Rasp and Screen	204
18.4.1. Plant elements	210
18.4.2. Estimated costs	212
CHAPTER 19. FINANCIAL EVALUATION OF COMPOSTING METHODS	215
19.1. Standard Costs	215
19.1.1. Land, paving, administrative buildings	216
19.1.2. Pre-treatment plant	216
19.1.3. Windrowing plant performance and cost	217
19.1.4. Post-treatment plant	217
19.1.5. Internal transport	218
19.1.6. Manual workers	218
19.1.7. Administration	219
19.1.8. Other unit costs	219
19.1.9. Hours of operation	219
19.1.10. Amortisation	219
19.2. Post-treatment and Pre-treatment Plants, 200 Tonnes/Day	220
19.2.1. Estimated capital costs	220
19.2.2. Estimated operating costs	220
19.2.3. Summary of comparative costs	221
19.3. Post-treatment Plants of 3 and 50 Tonnes/Day	222
19.3.1. Estimated capital costs	222
19.3.2. Estimated operating costs	223
19.4. Summary of Comparative Costs	224
19.4.1. Conclusions	225



## ILLUSTRATIONS

	Page
1. Flow chart and decision areas for storage and collection	23
2. Enclosed masonry bin	35
3. Handcarts	39
4. Lightweight motor-tricycle	43
5. Agricultural tractor with refuse trailer	45
6. Pedestrian operated electric vehicle	45
7 (a) Specialist design of refuse collection vehicles	47
7 (b) Barrier Loader	48
7 (c) Fore and Aft Tipper	49
8. Layouts for trailer and container exchange	57
9. Flow chart, short-range transfer	67
10. Route layout for short-range transfer	67
11. Transfer stations	73
12. Crew collection, labour : transport relationship	78
13. Crew collection, labour : transport relationship	79
14. Relay systems, charts	85
15. Incineration, calorific values	97
16. Land space required for disposal	99
17. Control of airborne litter	109
18. Control of surface water pollution	111
19. Plan of operation for filling a deep quarry	118
20. Formation of one layer in a deep quarry	119
21. Plan of operation for a level site	123
22. Small manually operated sanitary landfill	128
23. Manual landfill : formation of first strip	130-131
24. Comparative costs of single and multiple machines	139
25. Trench method of sanitary landfill	143
26. Compost temperature curve	161
27. Vehicle arrival pattern at a treatment plant	170
28. Windrow area inhabited by fly larvae	185
29. Windrow turning procedure	186
30. Windrow layout	189
31. Layout of radial windrow plant	201
32. Windrow turning sequence	203
33. 50 tonnes/day treatment plant	205
34. 200 tonnes/day plant layout	209
35. Post-treatment plant for 200 tonnes/day wastes input	211
36. 400 tonnes/day pre-treatment plant	213

## PHOTOGRAPHS

1. Physical analysis of refuse	12
2. Manually portable communal container	16
3. Side-loading refuse collection vehicle	16
4. Delhi refuse enclosure	30
5. Handcart used for house-to-house collection	41
6. 3-Bin pedal-tricycle	41
7. Simple tractor-trailer unit	44
8. Standard commercial truck with extended side-boards	51
9. Mini-tractor and low-loading trailer	51
10. Container-hoist vehicle	52
11. Storage of market refuse	58
12. 4-bin handcart, used for house-to-house collection	61
13. District depot	75
14. Sweeper's handcart	75
15. Manually operated landfill	135
16. Steel plate track on landfill	135
17. Manual landfill	138
18. Tractor-trailer on uncovered landfill	138
19. Manual composting, pilot project	195
20. Manually formed windrows	195
21. Crude compost	199
22. Screened compost	199

Photographs are the copyright of the author except for nos. 4 and 9 which were provided by Mr. H. U. Bijlani, Municipal Engineer, Delhi Municipal Corporation, now Professor, Centre for Urban Studies, Indian Institute of Public Administration, and numbers 15 - 17 which were copied from photographs owned by Mr. John Skitt.

# MANAGEMENT OF SOLID WASTES IN DEVELOPING COUNTRIES

## CHAPTER 1

### INTRODUCTION

At all levels of development human beings produce domestic wastes: at the very minimum these comprise kitchen wastes, ashes from fires, broken utensils and worn-out clothing. In a small agricultural community nature readily accepts these wastes into her natural cycle: animals consume food residues and other materials are rapidly incorporated into the soil.

The industrial revolution in the temperate countries concentrated people in urban areas of very high population density and added new sources of wastes: shops, institutions and factories. Apart from any question of public health it was impossible to accommodate these wastes, arising at a rate of up to one tonne/family/year, within the urban areas. Thus, in those countries where industrialisation came early, services for the regular removal of domestic and trade wastes have been in operation for a hundred years or more.

Many changes have taken place during this period: the character of the wastes has altered in line with rising living standards, changes in retail distribution methods and fuel technology. The volume has greatly increased; storage methods have evolved from open heaps through portable containers to expendable containers; transport has changed from horses to motor vehicles and from open trucks to compactor vehicles. New problems have arisen—high-rise buildings, supermarkets, industrial wastes of many kinds—and usually efficient solutions have been devised.

At this stage in their development, most industrialised countries exhibit the following common features:

- a high level of national wealth which is still increasing;
- a taxation system which provides a reliable source of funds for public services such as refuse collection;

- a long tradition of regular and efficient removal of refuse direct from dwellings and other premises, and usually operated by a municipality;
- a high level of sensitivity to aesthetic standards within private premises (which does not always extend to standards in public places);
- willing acceptance by householders, shopkeepers and others of statutory duties such as providing and maintaining storage containers, sometimes of a specified type and size, and assisting in making containers available for emptying by municipal employees at prescribed times.

During the past twenty years the main thrust of technical development has been towards mechanisation, because of rising labour costs, even to the point of installing underground pneumatic transport systems at a few high-rise developments. Although manual emptying of containers continues to be employed almost everywhere, the ratio of vehicles to men is rising and the service is becoming more capital intensive with investment up to Rs. 400,000 per collector in some cities.

In the industrialised countries, therefore, basic health and environmental problems have been solved in the storage and collection of solid wastes, although major problems remain in the matters of resource recovery and disposal. Despite recurring conflicts over the allocation of national resources as between public and private expenditure, sufficient money is available normally to provide an efficient public service and the citizens co-operate well with the system. The technology of wastes handling is now highly developed; substantial sectors of industry are engaged in the production of equipment; there are established institutions for technical training; there is a wealth of technical literature much of which is devoted to the efficient deployment of labour in relation to capital equipment—another indicator of western pre-occupation with rising labour costs in the service industries.

By contrast, India and many other developing countries are suffering all the problems of urbanisation, often with population densities much higher than any western city, but without the financial resources needed to provide solutions of the kind used in the West.

The developing countries are not unaware of the importance of avoiding the environmental pollution which shadowed urbanisation and industrialisation in Europe and North America. The quality of urban environment is a matter of growing concern to them and the importance of efficient solid wastes management is increasingly recognised. The West has often been able to provide developing countries with technical guidance in environmental matters,

but solid wastes may prove to be an exception; there are too many climatic, economic and social differences for systems to be successfully transplanted. Even the technical literature of the West may be of little value for either training or operational guidance. Some of the impediments to the use of western methods in developing countries are indicated by constraints listed in the report of a seminar held at Bangkok in 1974 by a group of South East Asian countries under the auspices of the South East Asia Region of the World Health Organisation :

- climate and seasonal variation,
- budget and foreign exchange limitations,
- economy of the region,
- physical characteristics of the cities,
- social and religious customs,
- public health awareness,
- quality of management and technical capacity,
- the environmental standards required.

It was against this background that the Bangkok Seminar stressed the importance of the following issues :

- protection of health and the environment at a level of cost that can be sustained locally,
- development of systems based on local climatic, physical, economic and social factors,
- production of efficient, indigenous tools and equipment,
- the achievement of high productivity from labour and equipment, especially motor transport,
- education of the public,
- vocational or professional training for middle and top management.

This manual is aimed at both the latter groups. It was initiated by the Government of India to satisfy a need which was first voiced as a recommendation of a W.H.O. expert committee (Solid Wastes Disposal and Control, W.H.O. Technical Report Series No. 484) :

*"The function of the technician is the day-to-day supervision of refuse collection and disposal, which requires thorough training in applied technology and administration."*

This recommendation was echoed by the Bangkok Seminar:

*"A solid wastes technician's course should be a five to ten month course and should include characteristics and analysis of wastes, equipment, systems, planning and operation of street cleansing, refuse collection, refuse treatment plants and disposal systems, vehicle maintenance, stores and inventories and manpower management. An important requirement is the preparation of a manual or manuals covering the suggested syllabus in terms of regional or national need."*

**Sources  
and  
Characteristics**  
**1.1**

"Solid wastes" is the term now used internationally to describe non-liquid waste materials arising from domestic, trade, commercial, industrial, agricultural and mining activities, and from the public services. "Non-liquid" is a relative term because sludges of certain kinds fall within the scope of solid wastes management; these arise primarily from industrial sources and from sewage treatment plants.

Solid wastes comprise countless different materials: dust, food wastes, packaging in the form of paper, metals, plastics or glass, discarded clothing and furnishings, garden wastes, construction wastes, factory offcuts and process wastes, pathological wastes, hazardous and radioactive wastes.

Domestic wastes have three main characteristics: weight generated, density and constituents; these vary not only from country to country, but from town to town within a country, according to the level of industrial development and other factors:

- the range of weight generated/person/day usually lies between 250 and 1,000 gms, worldwide,
- density varies from 100 kg/cu metre to 600 kgs/cu metre,
- thus volume may range between 1/2 litre and 10 litres/person/day,

The main constituents of domestic wastes vary as follows:

- vegetable-putrescible matter, 20% to 75%,
- inert matter, 5% to 40%,
- paper, 2% to 60%,
- glass, 0 to 10%,
- metals, 0 to 15%.

No rational decisions on solid wastes systems are possible until data of this kind are available. The method and capacity of storage, the correct type of collection vehicle, the optimum size of crew and the frequency of collection depend mainly on volume and density; climate also has some influence. The disposal method may be conditioned by the proportions of saleable materials that could be recycled, the vegetable content which may be compostable, or the paper and plastics content which could be a source of energy.

Just as solid wastes comprise a vast number of materials, they arise from a multitude of separate sources: a city of a million inhabitants may have a quarter of a million separate sources, as well as many kilometres of streets upon which solid wastes accumulate. Thus the four main aspects of solid wastes management are:

- storage at or near the point of generation,
- collection,
- street cleansing,
- disposal.

An apt definition of solid wastes is "matter in the wrong place", implying that a material becomes waste only when a specific owner ceases to have a use for it. Yesterday's newspaper is waste to the man who bought it, but it could be the raw material for a paper mill. Current waste disposal philosophy is to endeavour to treat all wastes as resource materials: some for re-cycling; some for conversion to fertiliser or as a source of energy; and the balance for land reclamation.

There are potential risks to health and to the environment from improper handling of solid wastes. Direct health risks concern mainly the workers in this field, who need to be protected, as far as possible, from skin contact with wastes. (The National Environmental Engineering Research Institute, India, has carried out studies that show a higher incidence of intestinal parasites in collectors of domestic wastes than for the population as a whole.\*) There are also specific risks in handling wastes from hospitals and clinics.

For the general public, the main risks to health are indirect, and arise from the breeding of disease vectors, primarily flies and rats. Improper storage and disposal provide the conditions under which these risks arise.

The most obvious environmental damage caused by solid wastes is aesthetic: the ugliness of street litter and the destruction of the beauty of the countryside by uncontrolled dumping of city wastes. More serious, however, and often unrecognised, is the transfer of pollution to water, which occurs when the leachate from a refuse dump enters surface water or ground-water. Air pollution can be caused from the inefficient burning of wastes, either in the open air, or in plants that lack effective treatment facilities for the gaseous effluents.

Industrialisation introduces dangers of a different kind: hazardous wastes from industry present risks during transport and disposal. Traffic accidents can result in toxic wastes being spilled: they have caused death and injury to people in the vicinity. Improper disposal of such wastes has resulted in the death of humans and animals through contamination of crops or water supplies.

Finally, there is the specific danger of the concentration of heavy metals in the food chain, a problem that illustrates the relationship between solid and other wastes. It has sometimes happened that liquid industrial effluents containing heavy metals have been discharged to a drainage system and have contaminated the sludge leaving the treat-

\* "Short-term study of health status of refuse workers at Trivandrum", NEERI Report, 1970.

## **Health and Environmental Implications 1.2**

ment plant. These metals can be taken up by the plants growing on land on which sludge has been deposited, creating risks to the animals which graze and the humans who consume the animals.

**Economic Implications**

1.3

Labour and transport absorb the major part of the operating costs of solid wastes management services. It is usual for a city to employ between two and five workers for each 1,000 population. Three workers/1,000 population may represent about 1% of the total national workforce. Transport is required on a scale of about 1 heavy vehicle/15,000 population. Thus, solid wastes management services can absorb up to 1% of the gross national product, and is one of the most expensive of city services. Efficiency of systems and high labour productivity, therefore, are of vital importance.

The level of mechanisation that should be adopted for solid wastes management systems relates directly to the cost of labour, as compared to that of plant and energy. There is not much variation, worldwide, in energy or mechanical plant costs, but there is an astonishing range of labour costs:

	<i>Rs./hour</i>	<i>Optimum mechanisation policy</i>
USA	60	maximum capital intensive.
Europe	30	mainly capital intensive.
Latin America	10	critical evaluation necessary.
S. E. Asia	1.5	maximum labour intensive

Thus there are no universally applicable solid waste management systems: every country must evolve an indigenous technology based on the quantity and character of the wastes, the level of national wealth, wage rates, equipment manufacturing capacity, energy costs and the availability of foreign exchange for the purchase of imported plant.

**Human Resources**

1.4

A critical factor in the evaluation of alternative systems of solid wastes management and the establishment of efficient organisation is the quality of management. It is necessary to deploy a complex set of technical skills which derive from several professional disciplines. These include civil and mechanical engineering, chemical engineering, transport organisation, land-use planning and economics. Thus, solid wastes management is teamwork, and whatever the original discipline of the top manager, his prime qualification should be his specialised background in this field. A second requirement, no less important, is skilled "man-management", the purpose of which is to obtain high productivity from a contented staff at all levels.



## CHAPTER 2.

### SAMPLING METHODS

The generation of solid wastes varies in different types of dwelling as well as in different socio-economic groups.

**Generation  
2.1**

The following are the methods commonly used to estimate the total quantity of wastes to be collected and disposed of:

**generation  
in relation  
to collection  
and disposal  
2.1.1.**

- average loads collected/day multiplied by average volume/load ascertained by measuring a vehicle body, and converted to weight by using an average density obtained by sampling,
- sample vehicle weighings, using a weighbridge, the average being multiplied by the total loads/day.
- weighing of every load on a weighbridge at the disposal site; this is the only accurate method.

Measurement of the total weight of wastes delivered to a disposal site, however, is seldom an accurate indication of wastes generated, as distinct from collected, because of losses at various stages. The following may be a typical pattern:

<i>Stage</i>	<i>Handling phase</i>	<i>Losses</i>
	<b>Total Generated</b>	
1		minus salvage sold by householder
2		salvage by servants
3		salvage by scavengers
4		wastes disposed of by un- authorised means, e.g. on unused ground or in ditches.
	<b>Total Collected</b>	
5		minus salvage by collectors
	<b>Delivered for Disposal</b>	
6		minus salvage by disposal staff salvage by scavengers
	<b>Total Disposed of</b>	

For certain purposes, e.g. to determine the volume required for storage of domestic wastes, or to find the recycling potential of wastes, it is necessary to try to measure wastes actually generated. This can be done by sampling at source, i.e. at stages 1 or 2.

**requirements for estimating domestic and trade wastes**

**2.1.2.**

Because the cycle of domestic activity varies throughout the week, it is necessary to obtain samples that precisely cover one week. For India the following initial assumptions could be made:

350 gms/person/day,  
6 persons/family,  
= 2.1 kg/dwelling/day = 15 kg/dwelling/week.

(including natural moisture content)

However, there is a very wide range of wastes generation as between socio-economic groups and dwelling types, thus it is necessary to obtain samples from every identifiable group. The following is a typical classification:

<i>Code</i>	<i>Dwelling type</i>	<i>Socio-economic group</i>
A.1	Single unit	low
A.2	"	medium
A.3	"	high
B.1	Multiple, low rise	low
B.2	"	medium
B.3	"	high
C.1	Multiple, high rise	low
C.2	"	medium
C.3	"	high
D.	Shop and office wastes	

The classification must reflect the character of the city and in some cases it would be necessary to include slums, bustees and semi-rural areas.

The minimum size of a sample for a group of similar dwellings is about 200 kgs; thus the minimum number of dwellings required per group for a daily collection would be about 100, based on the assumed rate of generation above.

The minimum number of 200 kg samples required for a city is about 12. Thus, if the number of classified groups is less than 12, more than one sample should be obtained from the largest group or groups.

On the above assumptions, a generation test in an Indian city would involve about 12 samples/day, each from about 100 dwellings, and would cover 1,200 dwellings and a population of 7,200.

**proposed method of collection of samples**

**2.1.3.**

In cities where the storage of domestic wastes is in communal containers, it will be necessary to supply every dwelling with a container for the period of the tests; plastic bags offer the cheapest solution.

After selection of the sampling areas, each householder should be interviewed, to explain the purpose of the sampling project. It is desirable that this be done by social

workers who are better trained in communication. An explanatory leaflet should be left at each dwelling.

The sampling programme should extend over eight successive days. Wastes collected on the first day should be discarded as the period they represent may be doubtful; wastes collected from the 2nd to the 8th day will represent one week's production.

The collector should carry a supply of plastic bags, one of which should be handed in at each dwelling in replacement of the full one collected. Each full bag should be labelled with its appropriate classification before being taken to the depot where the contents are weighed and the volume measured.

For calculation of total weight and volume generated in the city, a multiplier is used for each coded group based on the proportion of the population represented by that group. For example, if the A.1 sample is from 600 persons and the total population in that classification is 40,000, then the multiplier would be 66.7.

In most cases, samples collected in this way would also be used for physical analysis, as described in the succeeding section, supplemented by samples representative of trade and commercial wastes.

The labour requirement for a programme of this kind is as follows :

Total calls/day for 1,200 dwellings	1,200
Calls/collector @ 20 calls/man/hour for 6 hour day	120
Number of collectors required per day	10
Period for which required	8 days

(A basic weakness of this method of estimating generation is that, despite explanations given in advance, the householder may vary the normal pattern of wastes disposal for personal reasons if he or she knows that the wastes are going to be examined. Greater accuracy is assured when samples can be obtained without the knowledge of the householder; this applies in Britain where the sampling collectors simply move in a little earlier than the normal house-to-house collectors. This is not practicable, however, in cities where the main storage methods are communal.)

For many purposes, such as deciding the design of refuse collection vehicles and the method of refuse disposal, collection of samples direct from source is unnecessary, and samples can be taken from communal containers or transfer stations. This is a much simpler procedure and requires merely the daily collection of at least 12 samples,

**collection  
of samples  
from communal  
containers  
2.1.4.**

each at least 200 kg or 500 litres, from areas which properly represent the selected socio-economic groups and trade sources.

The density of samples collected in this way will be higher than for samples collected direct from source because the density of the wastes increases at each stage of handling, partly through the removal of light constituents such as paper, and also by compaction of material at low level by pressure from the weight of wastes above, and lastly by the gradual filling of interstices by dust. (Thus for the calculation of domestic and trade wastes storage capacity at source, the density of communal wastes should be reduced by at least one third.)

**Analysis and  
Projection  
2.2.**

The physical analysis of wastes, using an accurate sampling method, enables the following information to be obtained.

- density of wastes,
- proportions of salvageable constituents,
- proportions of other constituents,
- proportion that could be incorporated in compost,
- combustible proportion,
- graded particle size.

Three or four analyses are needed over a period of one year in order to cover the seasonal variations that occur as a result of the climatic cycle and the food production cycle.

**collection  
of samples  
2.2.1.**

At least 12 samples and not more than 20 are required, each of at least 500 litres and not more than 1,000 litres. The samples should be selected to represent commercial and market wastes as well as the domestic wastes sources referred to in the preceding section. The number of samples from each group should be proportionate to the population represented by that group, or else mathematical weighting could be used. If the purpose is to obtain information on collected wastes, samples can be taken from vehicles as they arrive at disposal sites, so long as the source is known with accuracy, or from communal storage points.

**method  
of analysis  
2.2.2.**

Samples should be analysed within two hours of collection to minimise errors from moisture loss. The measuring box of 500 litres is filled by shovel; the contents should not be compressed but the box should be rocked back and forth three times during filling. The box is then weighed to find the density of the wastes. It is now necessary to sort the wastes by hand into the required constituents

and they are transferred in suitable amounts from the box to a sorting table. The surface of this table is formed by a wire mesh grid of 50 mm, so that all material below this size will fall through it. The oversize vegetable-putrescible wastes are left on the table but all the other constituents are picked out and put in a marked container for subsequent weighing. Small hoes are used to turn over the wastes during the sorting process. When sorting of the oversize material is finished the table is shaken to ensure that everything below 50 mm has fallen through. The matter remaining on the table is vegetable-putrescible over 50 mm.

The matter below 50 mm which has fallen to the ground is now shovelled up and passed over a hand screen of 10 mm mesh. The wastes remaining on this screen are now hand-sorted until only vegetable-putrescible matter remains; this is the 10 mm - 50 mm size.

By this time the wastes are completely sorted into the required constituents and sizes except that the fine matter below 10 mm will be a mixture of inert and organic matter, such as sand and food grains. The proportions can be established only in a laboratory by moisture and ignition tests, but with experience it is possible to make a fairly accurate estimate by visual examination.

The following example of a summary sheet shows the kind of information needed:

information from analysis  
2.2.3.

Constituent	Sample No. And % by Weight							
	1	2	3	4	etc	Max	Min	Average
Vegetable/putrescible								
above 50 mm								10
10 mm - 50 mm								35
below 10 mm								10
Total								55
Paper								15
Metals								5
Glass								4
Textiles								3
Plastics & rubber								2
Bones								—
Misc. combustible								2
Misc. incombustible								4
Inert matter below 10 mm								10
<b>TOTAL</b>								<b>100</b>
DENSITY kg/cu m								350
SOURCE OF SAMPLE	code letter							

**equipment  
required**  
2.2.4.

1 measuring box, 1 metre high x 1 metre long x 500 mm wide, with bottom. Weight should be minimised by using thin resin-bonded plywood for construction. A strong batten should be bolted along each side, projecting at the ends, to provide four lifting points for placing the box on a scale.

1 sorting table, about 1.5 metres wide x about 3 metres long, made from a stout softwood frame with corners halved and bolted, and entirely covered by wire mesh of 50 mm, carried round every side and securely fastened. The table can be supported on trestles or fitted with legs.

1 hand-screen of 10 mm mesh,

10 bins or boxes of about 60 litres to contain sorted materials,

3 large flat shovels,

6 hand-hoes to turn over wastes during sorting,

6 pairs plastic or rubber gloves for sorters,

1 platform weighing machine, preferably with capacity up to 500 kg.

**projections**  
2.2.5.

Analyses are often made as part of feasibility studies for refuse treatment such as composting and incineration. Such plants have lives of twenty years or more, and in



*1. Physical analysis  
of refuse*

Left foreground: partial view of a 0.5 cubic metre measuring box. Centre foreground: portable platform weighing machine. Centre: perforated sorting table below which can be seen the matter below 50 mm which passes through during the sorting process.

Right: boxes to contain materials removed from the table. The only matter remaining on the table after sorting is vegetable putrescible matter over 50 mm in size.

such cases it is vital that the design parameters should be based on projected and not current analyses if performance is to be reasonably uniform throughout the working life of the plant.

Over a long period it is likely that changes occur in the physical characteristics of wastes, from the following causes :

- a rising standard of living increases the production of solid wastes, particularly constituents other than vegetable-putrescible,
- changes in packaging technology and retail distribution methods tend to increase packaging materials and volume per capita,
- changes in domestic fuels, for example a reduction in the use of solid fuel, could cause falling ash content and a reduction in weight per capita.

In cities where annual analyses have been carried out for 15 years or more, changes of this kind appear on a graph as a smooth curve from which it is usually possible to extrapolate estimated analyses for up to ten years ahead. Where such information does not exist, it is possible to make projections based upon national and local forecasts of economic growth and industrialisation.

## CHAPTER 3. REFUSE STORAGE AND COLLECTION

India is the largest of a group of countries in South East Asia which have many problems in common. It may be useful, therefore, to begin with a description of the methods of refuse storage and collection which were in general use throughout the South East Asia Region of the World Health Organisation at the time of the 1974 Bangkok Seminar from the report of which the following information is derived.

The average wastes production from houses, shops, markets, offices, "cottage industries" and street litter is of the order of 350 gms/head/day throughout the region, and variations do not exceed 3/% either side of this figure except in Jakarta. This is about the same as the average for urban areas in India found by the National Environmental Engineering Research Institute, but less than half the comparable figure for Europe.

A substantial proportion of the wastes produced are never collected: uncollected wastes accumulate in courtyards and on waste ground, are thrown into rivers or ditches or blown away by the wind.

The normal performance of a worker in the region (total weight collected divided by total manual employees) is about 250 kg/day.

Average expenditure on solid wastes management, including street cleansing and refuse disposal is about R. 5/head/year, but in some cities approaches Rs. 17.

### **Communal Storage**

#### **3.1.**

Most domestic and shop wastes are stored in communal containers to which they have to be delivered by residents. Communal sites take many forms: portable steel bins of about 100 litres capacity with lids are used in Rangoon. The more common size for a communal container is from one to two cubic metres and these are made from steel, concrete or wood. In Delhi extremely large concrete structures have been built, holding several cu m. These are attractive in design, having curved screen walls to hide the contents. Spacing of communal containers is determined mainly by their capacity, thus the closest spacing



occurs in Rangoon and the widest in Delhi. The distance between containers in Delhi may explain the existence of private collectors who visit houses for a small fee. It may also explain the very large number of street sweepers who are employed.

Almost without exception communal containers cause problems: they were sometimes overfilled, or refuse thrown around them; they were disturbed by birds, dogs, cattle, and pigs as well as scavengers searching for saleable materials. Official sites were often supplemented by random heaps on verges.

Trucks used for collection from communal sites were usually open bodies on standard commercial chassis without tipping gear. Loading was a tedious process of filling baskets, carrying them to the vehicle and handing them to a man inside it. Hand unloading took a long time and caused congestion of vehicles at the disposal sites.

House-to-house collection is a comparative rarity and standardised bins were never seen. In Colombo and parts of Jakarta the bin is usually improvised from an oil drum or a similar container. Often the bins are kept permanently on the verge outside the house, even when there is space in a garden. In Bangkok baskets and plastic bins are used and are put outside only during the period when a kerbside collection is expected.

Vehicles used in Colombo, Rangoon, Central Delhi and Bangkok are side-loaders with curved sliding shutters and hydraulic tipping gear. Only in Colombo are low-loading chassis used; these eliminate the need for a man in the vehicle. A very cheap and useful vehicle used in Colombo is a low-loading, side-loading, shuttered, two-wheel trailer towed by a very small farm tractor.

Another system of house-to-house collection, used in Jakarta, is by handcarts of about 1½ cu m capacity. These rendezvous with motor trucks to which the contents of the carts are transferred for transport to disposal.

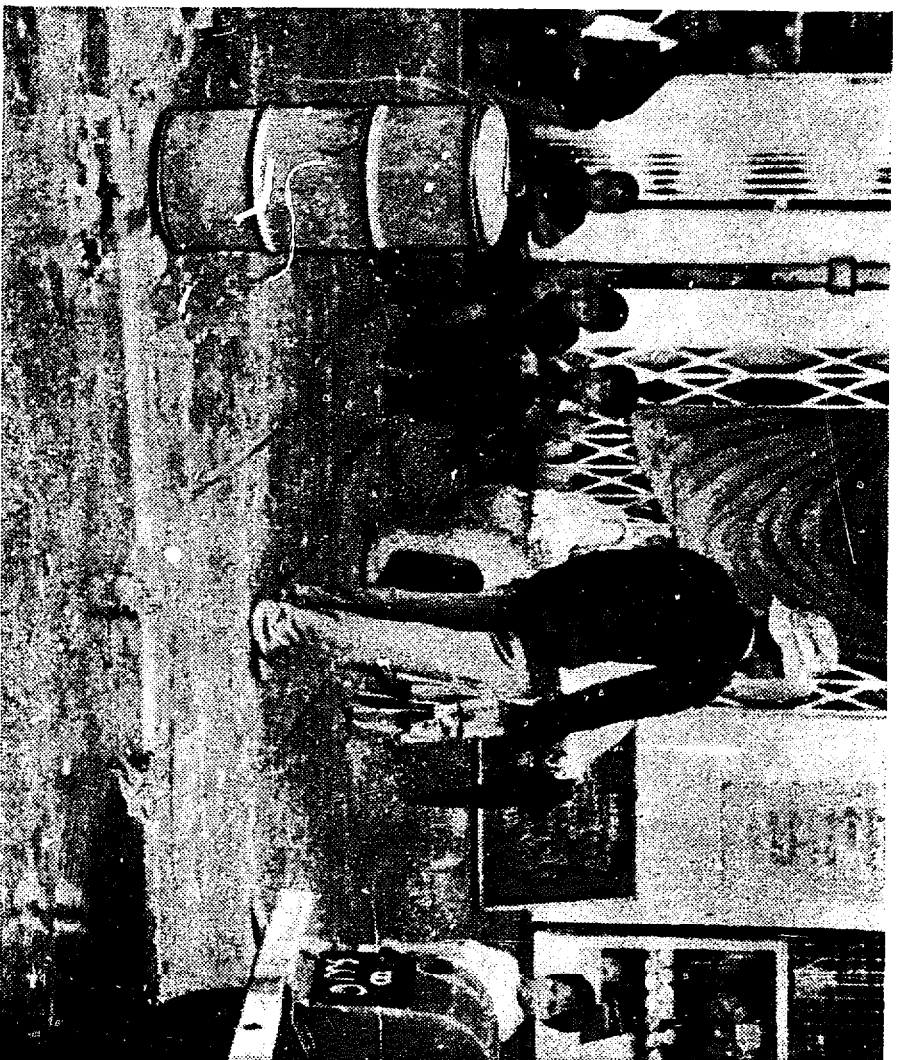
Compactor vehicles are not in general use anywhere, but Dacca has a number of rotating body vehicles, Colombo two compression-plate vehicles, and Jakarta one.

Industrial wastes in the main cities does not appear to be significant in amount compared with domestic and shop wastes. Much of the industry operates on a small scale and these wastes are caught in the net of ordinary municipal services. The larger factories are often outside the cities: their wastes are usually offcuts, spoilage and packaging materials.

**House-to-house  
Collection  
3.2.**

**Industrial  
Wastes  
3.3.**

2. Manually portable  
communal container  
used for a group  
of dwellings  
in central Rangoon



3. Side-loading vehicle  
with curved sliding  
shutters mounted  
on a low chassis and  
equipped with  
hydraulic tipping  
gear. (Colombo)



Throughout the region, labour-intensive re-cycling operates on a vast scale. Householders keep newspapers, bottles, etc., separate and sell them to collectors. Communal bins are searched by scavengers and the process is continued by refuse collectors and disposal site scavengers.

### **Re-cycling 3.4.**

The large numbers of open communal storage sites and unofficial dumps encourages the breeding of flies and rodents.

### **Problems of Storage and Collection 3.5.**

Methods of collection often result in workers being exposed to regular skin contact with wastes which sometimes contain faecal matter. This may be the cause of the higher incidence of certain diseases found by NEERI to occur among refuse collectors.

Almost everywhere in the region motor vehicles are too old and too few in number. This problem is a compound of poor maintenance and the frequent lack of a vehicle replacement policy supported by a sinking fund.

The work of refuse collection vehicles other than hand-carts is impeded in many cities by dense traffic in the city centre. In most of the large cities there are certain areas where the roads are too narrow to admit motor vehicles. The solution to this problem, which has been adopted at Bangkok, is for single collectors to take a basket on a trolley down the lanes and to stack the full baskets in the nearest main street where they are emptied into motor vehicles. It is not uncommon, however, for the residents of these alleys to be ignored, causing rotting accumulations in yards or on the banks of streams.

In most of the region there was some evidence of public dissatisfaction with refuse collection services; equally many officials complained of lack of co-operation from the public.

Solutions to these problems have to be sought within the limitations imposed by a number of constraints. The most important single factor is whether the community can afford to pay for a good standard of service.

### **Constraints 3.6.**

Most of the cost of refuse collection is incurred in the form of manual labour and motor vehicles. Asia has the advantage of low wage rates and it is reasonable to suggest that the cost of manual labour can be sustained. Motor vehicles, however, present a formidable problem. Imported vehicles may have a relative cost, in terms of GNP/head, twenty times that of Europe\*. Even when it is desired to

\*For example, a vehicle costing US \$20,000 in a country with a GNP/head of \$4,000 requires 5 man-years to pay for it; in a country with a GNP/head of \$200 the man-years absorbed is 100.

import vehicles, this may not be possible because limited foreign exchange is required for more important services.

The climate often predicates certain standards of service, daily collection of refuse, for example. This is more costly to operate than the weekly service which is usual in Europe.

There are social and religious constraints too: many families live in crowded conditions in one room, where they cannot store refuse; there are religious taboos which forbid the storage of refuse within a dwelling.

**Deficiencies  
in Techniques**

**3.7.**

Many cities lack a network of district depots to serve as mustering points, offices for district supervisors, and transfer points for wastes collected in small vehicles.

Handcarts are usually emptied on the ground; they should have portable containers to be emptied into a transfer vehicle.

Many of the motor vehicles in use are 2 metres high or more; men have to stand in them to receive baskets passed up. Refuse collection vehicles should have a loading height not more than 1.6 metres.

Many vehicles have no tipping gear; this causes loss of time by manual unloading. Most vehicles are open and should be covered, at the very least by a tarpaulin sheet.

From this brief review of present standards of refuse collection in S. E. Asia the following needs emerge:

- more efficient vehicle design, based as far as possible on local manufacturing capacity,
- enclosure of wastes at all stages of storage and collection to reduce health risks to residents and workers,
- the use of labour-intensive systems,
- to employ motor vehicles in the manner that achieves highest productivity, so as to minimise the number required,
- provision of decentralised control through district depots with offices and enclosed transfer points,
- an efficient management structure supported by trained personnel.

## CHAPTER 4.

### ELEMENTS OF REFUSE COLLECTION

#### **Refuse Characteristics and Sources 4.1.**

The generation of domestic and trade wastes is a remorseless and continuing process. Throughout the day a housewife is performing such tasks as sweeping floors and trimming vegetables; the shopkeeper is discarding packing materials and spoiled goods; the shoemaker is paring leather; almost every member of the population is continuously creating wastes of one kind or another. In the case of human body wastes, a sewage system provides facilities for transfer from the production point to the disposal place by a continuous flow process in pipes containing water. Despite the successful use of pneumatic transfer in underground pipes at a few residential developments in Europe, no such method is generally practicable for solid wastes. Thus refuse collection must be a batch process, or a series of batch processes, whereby wastes are stored at the point of origin for a given period, before being transferred to a vehicle, the contents of which represent one batch of many arriving each day at the disposal point.

The main sources of those solid wastes for which a municipality normally assumes responsibility are domestic premises, shops, offices, hotels, institutions, and small factories, together with refuse swept from the streets. Domestic wastes often account for about 75% of the total.

The main constituents of solid wastes are similar throughout the world, but the proportions vary widely from country to country and even within a city, because the variations are closely related to income levels. The analyses on the next page, carried out in accordance with the systems described in 2.2.3, show this relationship very clearly. The figures relate to two specific cities and are not national averages. All weights include initial moisture content.

As personal income rises, paper increases, kitchen wastes decline, metals and glass increase, total weight generated rises and the density of the wastes declines.

There are often local variations in wastes generation

and constituent proportions over weekly and seasonal cycles; the former is related to the pattern of work and leisure and the latter to seasonal food products and sometimes to fuel residues arising from space heating in winter.

	<i>Indian city</i>	<i>N. European city</i>
Paper	2%	27%
Vegetable-putrescible matter	75%	30%
Dust etc., under 10 mm	12%	16%
Metals	0.1%	7%
Glass	0.2%	11%
Textiles	3%	3%
Plastics	1%	3%
Other, stones, ceramics etc.	7%	3%
Weight/person/day	414 gms	845 gms
Weight/dwelling/day	2.5 kg (6 persons)	2.5 kg(3)
Density kg/cu m	570	132

Clearly, the amount of work involved in refuse collection depends upon the weight and volume of wastes generated and the number of collection points from which the wastes have to be removed. The extent to which these factors may vary is shown in the following table:

	<i>Indian city</i>	<i>N. European city</i>
Generation :		
Volume/person/day	0.72 litres	6.4 litres
Volume/dwelling/day	(6) 4.32 litres	(3) 19.2 litres
Sources/1,000 population	166	333
Collection points : (per million population)		
House-to-house collection daily	166,000	
House-to-house twice weekly, per day	56,000	111,000
House-to-house weekly, per day		56,000
Communal storage points (per mil. pop.) (for average contents 1 cu m)		
Points to be visited daily	720	

The following important issues emerge from these figures:

- the importance of density in determining the volume to be stored and collected: about 4 litres from an Indian dwelling with a daily collection compared with about 130 litres from a European dwelling (many houses have two 70-litre bins) for a weekly collection;
- the higher rate of occupancy in India helps to reduce the number of sources, but this is far outweighed by the need for more frequent collection,

— the use of communal containers can reduce the total number of collection points to only 0.5% of the total sources; this enormously simplifies the organisation of the work, but may cause serious environmental problems.

A refuse collection service requires vehicles and labour. For their efficient deployment, it is necessary to have a clear understanding of the three main components of refuse collection :

## **Work Components of Refuse Collection 4.2.**

- travel to and from the work area;
- the collection process, which includes: transfer of the wastes from storage to the vehicle and travel between successive collection points;
- the delivery process whereby the contents of the vehicle are transported to the disposal site.

During non-working hours vehicles will be kept at a depot with enclosed parking space. The distance between the depot and the collection area should be kept to a minimum because time spent travelling is unproductive. In the case of motor vehicles this requirement may have to be balanced against the need to centralise facilities for maintenance and stores, particularly fuel supplies, and to centralise the allocation and control of drivers and vehicles.

The slower speed of animal carts and hand-carts requires the provision of closely spaced district depots and these are also much more efficient for the control of the collectors, who can book on and off within a short distance of the area where they will be working.

The many methods of transferring wastes from storage to a collection vehicle fall into three main categories :

- the direct emptying of a portable storage container into the vehicle, normally used when the vehicle can be positioned close to the containers;
- the emptying of a portable storage container into a transfer container (usually a large basket) which is then emptied into the vehicle, normally used when the storage container is some distance from the vehicle, in order to avoid the return walk with the empty container;
- the transfer of wastes stored at ground level, which usually requires that the wastes be raked or shovelled into the vehicle.

These three categories have been set out in ascending order of work content, thus the first is the most efficient in terms of labour and vehicle productivity; it is also the method that minimises human contact with the wastes.

Travel between successive collection points depends first upon the spacing. When these are some distance apart, as with large communal storage sites, travel by motor vehicle, although it represents lost time, will be at normal road speed and the collectors will ride on the vehicle. It is thus an efficient method of transporting the workers between sites.

When collection is from house-to-house, however, the collectors will walk the short distances between containers and the vehicle will move slowly and at intervals. For this element of travel the motor vehicle is very ineffectively employed, it incurs heavy transmission wear and high fuel consumption. Handcarts and animal carts are much more efficient: they operate at their optimum speeds and no energy is used while they are stationary.

For collectors walking from house-to-house, the distance to be walked is proportional to the number of men in a team. One man alone walks from one house to the next; in a three-man team each man collects from every third house, thus labour productivity declines as team size increases. Vehicle productivity, however, increases with team size as it is loaded more quickly.

The delivery process, when a full vehicle travels at normal road speed from the collection area to the disposal site represents maximum productivity for the vehicle, but lost time for the collectors if they accompany it. Handcarts and animal carts are very inefficient for this operation because of their slow speeds and limited capacity.

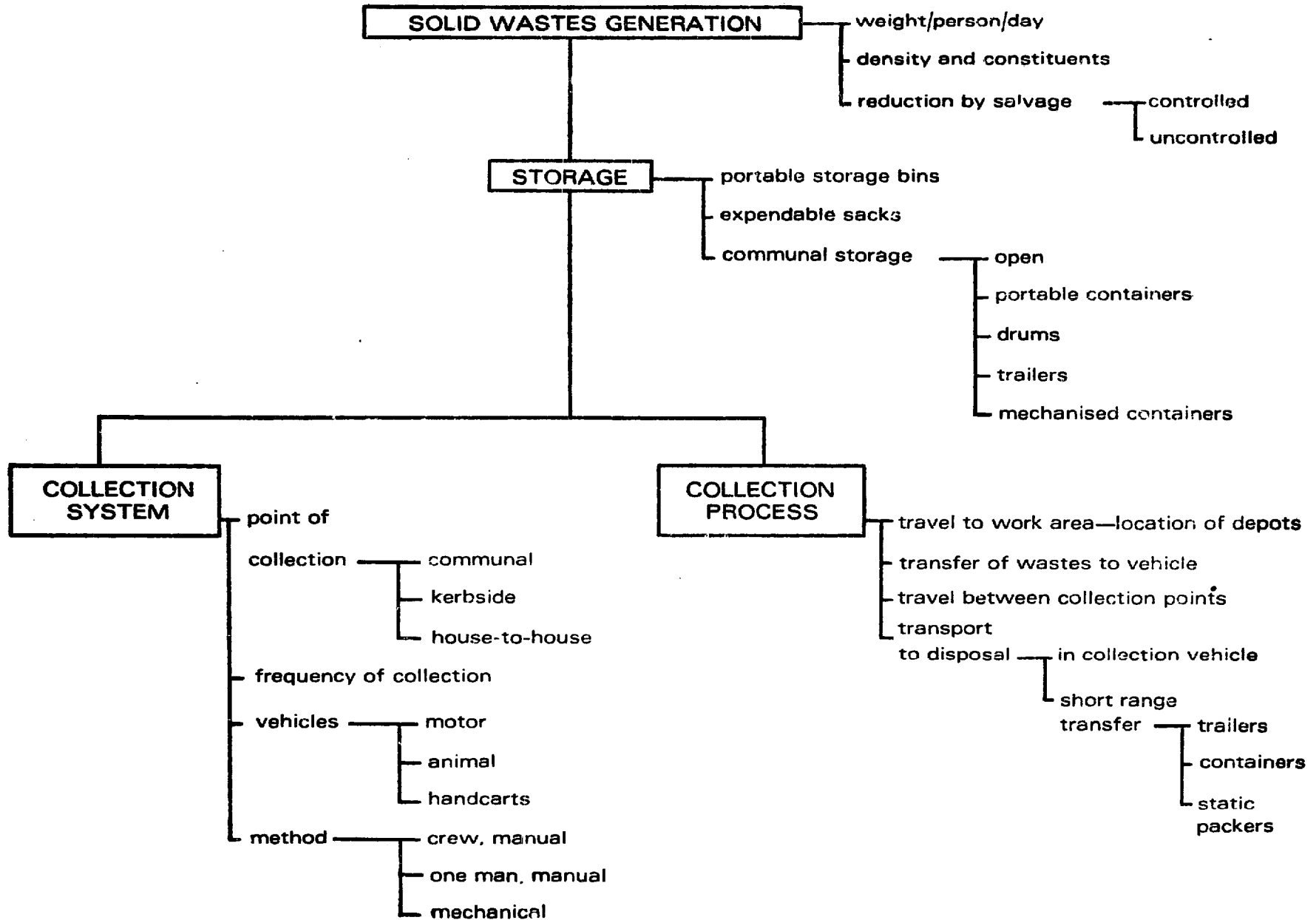
The following conclusions can now be drawn:

- minimum physical infrastructure requirements are a central workshop with parking space for motor vehicles, and district depots for mustering and controlling collectors, handcarts and animal carts; the locations of depots should minimise travel time between depot and working area;
- systems which provide for the direct emptying of portable storage containers into a vehicle offer the highest productivity and the lowest health risks to workers;
- for the collection of wastes direct from houses, large teams give low labour productivity and higher vehicle productivity;
- handcarts and animal carts may be more efficient than motor vehicles for the house-to-house collection phase;
- motor vehicles are the most efficient for transport of complete loads from the collection area to the disposal site.

Figure 1 is a flow chart of the refuse storage and collection process and indicates the main areas of decision which will be discussed in succeeding chapters.



Figure 1 FLOW CHART AND DECISION AREAS



## CHAPTER 5. FREQUENCY OF COLLECTION

The main factors which concern frequency of collection are :

- character of the wastes,
- climate,
- communal or home storage,
- characteristics of the dwelling or shop,
- duties of householders,
- cost.

The wastes of developing countries are high in vegetable-putrescible matter which serves as a breeding medium for flies and is a source of offensive odours. The eggs of the housefly hatch in as little as one day, but the larvae feed for about five days before pupation, which then takes a further three days. A weekly collection, therefore, prevents the production of adult flies in the stored wastes, provided that the larvae are unable to migrate from the container. Decomposition of the wastes, however, becomes apparent during the first two days, thus aesthetic standards may be of greater practical significance than the life cycle of the fly in this context.

**Communal Storage**      Climate is important, because decomposition proceeds more rapidly in tropical countries than in the temperate ones.  
**5.1.**

When communal storage is used, there is no problem of space or hygiene in the home or the shop, because the resident can deliver his wastes to the communal site as frequently as he wishes. Potential problems, however, are transferred to the communal storage place because there is no control over the age of the wastes deposited there and, if they have been kept at the house for several days, they may be infested with fly larvae. Controlling the migration of larvae from a communal site may be a much more difficult problem than in a small container with a lid. This factor really determines the frequency of collection, which should preferably be daily, otherwise at least three times weekly.

The character of a dwelling or shop exerts a strong influence upon the collection frequency. The house which stands in a garden, or the shop with an open storage area behind it, rarely has any problems in the storage of wastes in enclosed containers for periods of up to a week. There are large areas of the U.S.A. which have a sub-tropical climate and where weekly collection is quite common, but this is acceptable only because two conditions are satisfied: space for storing the container in the open air and the provision of containers with well-fitting lids which prevent odour emission as well as access by insects.

At the other extreme is the small apartment where the only space in which a wastes container can be sited is in the working area of the kitchen. Aesthetic standards and space limitation combine here to impose a maximum storage period of 24 hours. In such conditions it is necessary to provide a daily collection from each apartment, or to provide a communal container.

Small lock-up shops and large markets with rented stalls present a similar problem: a daily collection is necessary for the former, while market stalls may need to be visited several times a day.

In developing countries the population density of large areas (i.e. the major cities) is much higher than in the industrialised countries and in these areas external sites for home storage of wastes will usually be lacking; collection frequency, therefore, will often have to be daily.

The extent to which statutory duties are imposed upon residents may affect frequency of collection. Where there is a duty to place the domestic container at the kerbside, frequency must be high enough to limit the weight and size of container to the capacity of an old person. Where a "block collection" is operated (whereby residents have to deliver their wastes to the vehicle, which stops for a short time at each road intersection) the constraint on weight and volume assumes greater importance because of the longer distance the wastes have to be carried. Two days is often the maximum interval for this system.

For the collection of wastes direct from premises, cost/tonne rises rapidly as frequency of collection is increased. This is because the main determinant of work content of a collection route is the number of containers to be emptied and the distance to be walked between them. These factors are almost constant for frequencies between one and seven days. What does vary is the weight in the container, hence the greater the frequency the less the weight collected and the higher the cost/tonne. This is illustrated by the follow-

**Collection  
Direct from  
Premises  
5.2.**

**Cost  
5.3.**

ing productivity data for two American cities, one collecting weekly and one twice weekly, using similar systems\*.

	<i>Weekly</i>	<i>Twice weekly</i>
Collection points/day number	410	410
Weight/collection point kgs.	21	13
Total cost/tonne US\$	8.29	13.48

While the figures quoted above may have little direct relevance to developing countries, because of differences in wastes generation and vehicle and labour costs, the conclusion that cost rises with frequency is certainly valid.

When all the factors are taken into consideration, the following general conclusions emerge :

- communal storage sites should be cleared daily or at least three times weekly,
- for dwellings with gardens and buildings having outside storage space a twice weekly collection is adequate *provided a closed portable container is used.*
- in the case of homes and buildings that lack outside storage sites, collection should be daily, unless communal containers are provided.
- because frequent collection appears to imply high cost, unconventional systems and transport methods may have to be employed to bring expenditure within local capacity.

\* Adapted from "Residential Collection Systems" (EPA, 1975); from much other data the authors conclude: "Increasing the frequency from once a week to twice a week required approximately 50% more crews and equipment..."

## CHAPTER 6.

### REFUSE STORAGE METHODS

The storage volume which it is necessary to provide for domestic wastes is a function of generation, family size and frequency of collection. Based on six persons/family, the probable range required in S. E. Asia is as follows:

<i>Collection frequency</i>	<i>Minimum volume</i>	<i>Maximum volume</i>
Daily	4 litres	10 litres
Twice weekly (maximum 4 days)	20 "	50 "

#### Domestic Premises and Shops 6.1.

The following types of storage containers are available in most countries.

*Plastic buckets with lids* have capacities from 7 to 10 litres, sufficient for the domestic wastes of a family of six for a daily collection.

*Plastic bins with lids*, having capacities from 20 to 30 litres, with steel drop-down semicircular carrying handle, or a rectangular handle which allows the lid to be lifted, but prevents its removal, are suitable for a twice weekly collection for the majority of dwellings in S. E. Asia.

*Galvanised steel, or plastic bins with lids*, capacity 50 to 70 litres, are necessary when collection is twice weekly from a high income group, or for daily collection from shops. Bins of this size are relatively more expensive than smaller sizes because, if they are to give long service, they should be manufactured to a high specification. Steel bins should be galvanised after manufacture by hot dipping, not made from pre-galvanised sheet which rapidly corrodes at the rivetted seams. Plastic bins of this size should be of high-density polythene or plastics of similar characteristics.

*Expendable plastic sacks* have a number of obvious advantages but in Asia, where annual expenditure/family on refuse collection may be less than Rs. 50, the supply of, say 150 sacks/year, even at the very low cost of Rs. 0.20/sack, would cost thirty rupees/family/year,

adding 60% to normal expenditure. The annual cost of providing plastic bins would be very much less.

The problems of providing or enforcing the provision of standard bins in the densely populated poorer areas should not be under-estimated. Difficulties include:

- the organisation and recording of distribution and of replacements if the bins are supplied by the municipality;
- diversion of bins from their intended use, for example they could be used for the storage of food or water;
- loss of containers by theft and when residents move house.

It is likely that in some areas these problems are insuperable and that the only solution is in the form of improved standards of communal storage.

There should, however, be no difficulty in enforcing the use of standard bins of 50 to 60 litres capacity at premises of the following types, which are often subject to inspection and control for other purposes:

- at most shops and market stalls;
- for multiple dwelling units, as communal containers;
- in appropriate numbers at schools, hotels, offices and small industrial premises.

One of the strongest arguments for imposing a standard bin in these circumstances, where its volume is justified by the rate of generation, is that it is a necessary foundation for the achievement of maximum productivity of labour and transport in manual collection.

The following general conclusions emerge:

- in the densely populated areas of the poorer cities, the enforced use of standard containers may not be practicable;
- a bucket with a lid may be a suitable wastes container for most families, but the provision of buckets may have to be voluntary, encouraged by propaganda;
- when the volume of wastes generated reaches a level which requires bins exceeding about 25 litres of daily capacity, it is probable that the financial and organisational capacity exists to enforce the use of standard bins;
- the use of bins of maximum size, probably from 50 to 60 litres for high density wastes because of a man's limited lifting capacity, should be enforced for trade, institutional and multi-dwelling wastes, because they combine hygienic storage with low collection cost, except where total generation is so great as to justify mobile storage containers of very large capacity.

## **Communal Storage Methods**

### **6.2**

The development pattern of a refuse collection service is as follows: first all wastes are thrown indiscriminately in the street, later specific locations at which householders deposit their wastes evolve or are imposed. These communal storage sites are a nuisance to the people who live adjacent to them, but they could be eliminated only by the universal use of household bins, a solution which may not be practicable in some areas. In their attempts to alleviate

the problems of communal storage, local authorities throughout the world have devised many different methods of partially or wholly enclosing wastes:

- depots, known as "dalaos",
- enclosures of timber, steel, brick or concrete,
- fixed storage bins,
- concrete pipe sections,
- 200-litre drums,
- portable steel bins.

## depots 6.2.1.

Depots which consist of a single-storey building about the size of a large garage, or the ground floor of a multi-purpose building, are commonly used for the storage of wastes at large markets; they have also been adopted for the storage of domestic and trade wastes in a number of Asian cities. Delhi, for example, has about 150 of these buildings, some of which have rooms above which house manual or supervisory staff. Many are sited on the perimeter of the densely populated walled city, and the wastes are delivered to them, through a maze of narrow lanes, by residents, shopkeepers, sweepers and private collectors. The capacity of such a depot, which has a concrete floor and often tiled walls, may be as great as 25 cu m, but the average throughput in Delhi is about 12 cu m/day, probably equivalent to a population of 10,000 or more at the present local rate of generation. Thus, such large storage places are suitable only for areas of very high population density, otherwise the distance between them would be far too great. Even a density of 40,000 persons/sq km implies an average walk of 150 metres if storage places of this size are perfectly spaced, which is unlikely to be possible.

Such depots do, however, solve some of the problems normally associated with communal storage:

- the wastes are protected from rain;
- domestic animals and scavengers can be prevented from gaining access to them because the size of the installation is sufficient to justify placing a labourer to exercise continuous control over it.

The most difficult problem, and one that has to be squarely faced, is that of acquiring sites for storage depots; the area occupied by those described is equivalent to a large shop, and the location must be on a road wide enough for vehicle access. Such sites are often very costly to acquire.

The major criticism of the depots that have been observed is the manner in which they are operated: usually all wastes are dumped on the ground, thus the process of collection involves filling baskets which are then carried to a vehicle. This is a dirty and unhealthy procedure for the collectors, who are brought into close and continuous

contact with the wastes, and also for people who are passing the depot during loading, on whom dust often falls.

The solution to this is to adapt the depots to house trailers or exchangeable containers into which wastes could be emptied directly.

**enclosures**  
**6.2.2.**

An enclosure is probably the most common communal storage method: its essential feature is a wall of timber, corrugated iron, brick or concrete, which screens and contains the wastes. They have been observed with capacities from 1 to 10 cu m. One having an average throughput of 2 cu m/day would serve 2,000 people at the minimum rate of generation. They are usually sited on a roadside verge, or at the boundary of an open space.

The screen is usually designed to have one or more openings through which people walk to throw their wastes on the ground, and through which the wastes are removed, in baskets, by the collectors. The objections to this type of storage are:

- wastes tend to be thrown just inside the entrance where a heap builds up, ultimately blocking access to the main area, while wastes overflow from the entrance;
- rain, animals, flies and scavengers have free access;
- the collection process is dirty and unhygienic;
- the enclosures are sometimes used for urination and defecation, increasing the risks to the health of workers.



*4. A typical refuse enclosure in Delhi*

The system in Delhi has been more successful than in most cities. In some areas these masonry structures are known as "vats".



This type of container is usually built from concrete blocks. It differs from the screened enclosure by having no entrance: the walls are of a suitable height for wastes to be dropped inside over the wall (1.2-1.5 m.). Capacity is rarely more than about 2 cu m. In one wall an opening, covered by a flap, is provided through which the wastes are raked out by the collectors.

Similar structures of steel, rectangular or cylindrical, have been observed, the smallest ones, of about 300 litres, having hinged lids on top and an extraction opening at the bottom. These latter go a long way towards meeting the main objections to communal storage: animals, insects and rain are excluded; not scavengers, however.

The real objection to all these containers is the extraction by rake through an opening at ground level. If the material was free-flowing like coal this would work well, but wastes tangle together and in practice it is often impossible to remove them through a relatively small aperture in the way the designer intended: the collectors have to climb inside and fill their baskets from the top of the heap, so exposing large areas of their bodies to contact with the wastes. It has also been observed that flaps covering the bottom opening tend to break off and disappear, so that the contents overflow at that point. This encourages people to dump their wastes on top of the overflow and the result is storage by the side of the container, not inside it.

One of the problems of communal storage is that of balancing storage volume, which is a function of population density, against an acceptable walking distance for residents. It is reasonable to assume that unless sites are spaced at a reasonable distance, say about 250 m apart, people will be tempted to dispose of their wastes in an unauthorised location which is nearer to their homes. For areas of low population density, therefore, there is a need for containers of comparatively small volume and low cost. Some cities have adapted short lengths of concrete pipe to this purpose.

The most common size is about one metre diameter, the length being of similar or shorter dimensions. This provides a volume of about 300 litres when the pipe is placed upright on a pavement or a grass verge. Although such a container is almost indestructible and satisfies the basic need to provide a specific location for wastes, it fails almost every other test:

- the wastes are exposed to view;
- they are accessible to flies, rats, domestic animals and scavengers;

**fixed storage bins**  
**6.2.3.**

**concrete**  
**pipe sections**  
**6.2.4.**

— when the pipes are sited on unpaved surfaces, fly larvae can migrate, pupate and hatch;

— the wastes have to be dug out by means of a short rake, this is very hard work in an uncomfortable position, and puts the worker in intimate contact with the wastes.

## 200-litre drums

### 6.2.5.

It is probable that the type of wastes container which is most widely used throughout the world is itself a waste product: the 200-litre drum used for the distribution of oil, liquid fuels and similar products. There are two strong arguments in its favour: it is cheap, and, within limits, it is portable.

The extent to which a drum is portable depends upon the nature of the contents: for refuse with a density of 500 kg/cu m, not uncommon in poor areas, the total weight would be about 115 kgs. In the case of light packaging wastes, gross weight may be under 35 kgs. Even at the lower of these extremes, handling should always be by two men, because of the awkward size of the drum and its lack of lifting handles. At the maximum weight it cannot be carried, but it can be rolled on the bottom rim and emptied into a low vehicle. At the minimum weight it is easily carried and emptied by two men. 200-litre drums have been strongly condemned by the E.P.A. of U.S.A.\*:

*"Their use causes health and safety problems to the collectors as well as to the general public, and they contribute to lower collection efficiency and higher costs. Most of the difficulty stems from their weight and absence of lids. The drums themselves weigh 35 to 40 pounds (15.9-18.2 kgs.) and so can nearly double the normal weight lifted by collectors. This increases the risk of back injury and muscle strain. The size and shape of the drums also contribute to difficulty in handling; a drum that slips or is dropped can cause serious injury. Also, the drums are rarely covered and so collect rain...adding even more weight. This moisture causes the waste to stick to the drum, requiring manual handling of the waste itself.*

*"Coverless drums also cause health, safety, and odor problems. During the summer months, insects can breed in the waste. If rain water works its way to the bottom of the drum, the metal eventually rusts through, allowing rodents to feed from the containers. As the rust progresses, sharp edges are formed which can injure the collectors as well as others."*

These observations are addressed primarily to American

\*"Decision Maker's Guide in Solid Waste Management", United States Environmental Protection Agency, 1976.

local authorities; they do not necessarily apply in their entirety to other parts of the world. Injury risks, of course are common to all countries; but if such containers are emptied daily most of the health objections disappear or are reduced. On the issue of collection efficiency and cost, smaller portable containers would be better in U.S.A. or Europe, but there are many countries where 200-litre drums would greatly increase efficiency and may offer the following advantages over present methods:

- labour cost would be less than loading by basket;
- vehicle cost would be reduced as a result of a faster rate of loading;
- health risks to residents would be reduced by preventing migration of fly larvae;
- health risks to workers would be reduced by minimising skin contact with wastes, but at the cost of a greater risk from injury.

Where 200-litre drums are used as communal containers the problems spring mainly from human behaviour.

- wastes are thrown around, not inside;
- drums are deliberately overturned by scavengers who want to search the contents for saleable materials, or by herdsmen who want to expose the food wastes to their goats.

A possible solution to the latter problem is to attach the drums to a post driven into the ground in such a way that they can be released only by the authorised collector. This was usually successful in Britain during World War II when communal kitchen waste bins were placed in the streets as a source of feed for pigs and poultry.

A few cities have demonstrated that it is possible to use 200-litre drums with reasonable success and in all these cases the standard of management by the local authority has been very high:

- the drums have been painted inside with bitumin paint to preserve them and on the outside with high gloss paint in a bright colour;
- locations have been carefully selected and where necessary paved and provided with partial fencing;
- excess capacity has been provided to avoid overflow at peak periods of wastes generation;
- damaged bins are quickly replaced,
- collection is at a daily frequency.

In all these cases the standard of human behaviour was also above average and this indicates that where local authorities set a high standard of service, not necessarily at high cost, residents respond by co-operating with the system.

The traditional steel (or plastic) bin of 70-100 litres, used in the industrialised countries for domestic storage at home, can also be applied to communal use where generation is low and collection frequency high. Galvanised bins of

**portable steel bins**  
**6.2.6.**

about 100 litres capacity with well fitting lids, have been observed in the central area of Rangoon, where each serves up to 10 families. This, of course, appears to be the perfect solution in terms of hygienic storage, collection efficiency and the health of residents and workers, but it requires a significant initial expenditure by the local authority and very high standards of human behaviour. The sort of problem likely to be encountered is :

- loss of bins by theft;
- failure to replace lids and their subsequent disappearance;
- interference by men or animals, including mischievous behaviour;
- traffic accidents caused by bins rolling into the road;
- two men would be required to lift 100 litres of high-density wastes.

This cannot be recommended as a universal solution, but it may have good prospects in enclosed areas, such as the courtyard of an apartment block—if people can be persuaded to replace the lids !

**conclusions  
on communal  
wastes containers  
6.2.7.**

It should be stressed that, lacking control over the age of wastes deposited in any communal container, a local authority should operate a daily collection, and that thorough cleansing of every kind of communal storage (as distinct from routine collection of the contents) is also a municipal responsibility.

Systems that do not permit of thorough cleansing, such as storage in concrete pipes on unmade ground should not be adopted.

In looking over the methods just described, it is apparent that human ingenuity has failed so far to arrive at a complete solution to the problem of communal storage. Of all the methods considered, the only one that is cheap to install and maintain, offers low collection cost and provides a tolerable level of health protection to residents and workers (qualified by the risk of injury) is the 200-litre bin. But in the manner which it is normally used, the indiscriminate scattering of rusting, dented drums, it is an ugly solution which is often scorned by the residents.

As a stimulus to others to pursue the tantalising problem of the perfect communal container, the author has included Figure 2 which illustrates an imperfect solution at which he arrived after studying this problem in India. This is a fixed bin of concrete and steel which satisfies the following requirements in some measure :

- capacity about 2 cu m, equivalent to 500-2,000 persons/day;
- contents totally enclosed from view and rain;
- access denied to insects, animals, rodents and scavengers;
- apertures closed when not in use by hinged flaps, and at

- a height accessible to children;
- top aperture, which could be locked, through which bins from sweepers' handcarts could be emptied;
- steel doors at both ends, of the full width and height of the container, for removal purposes;
- contents removed by means of long rakes, say 2 m, into rectangular trays or baskets, without falling on the ground.

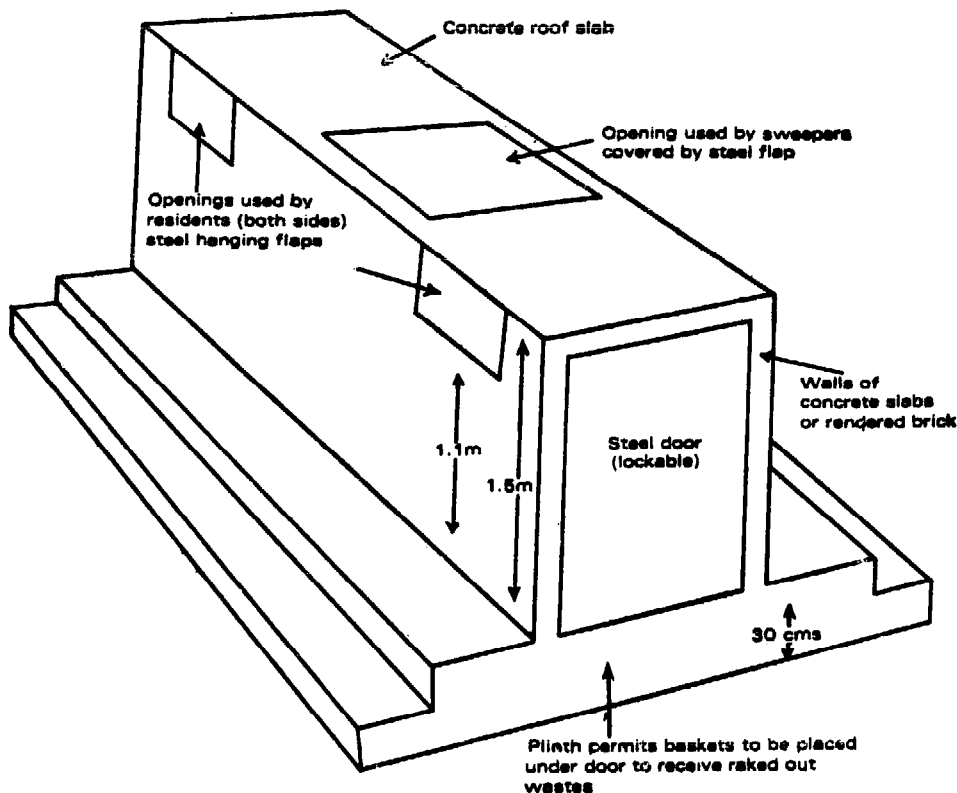
The plinth has a double purpose: it provides access for children and it provides space for trays into which the contents are raked.

This design fails to eliminate the need for hand raking of the contents into portable containers to be emptied into a vehicle, but it has some advantages over most of the existing methods and may be acceptable where wage rates are low and sites are available at appropriate intervals.

For all kinds of wastes containers it is necessary to allow a margin of capacity over the average rate of wastes generation because the cycle of production may vary from day to day. Trade wastes may be much greater on Saturdays when people have more time for shopping than on

### Capacity Margins 6.3.

Figure 2 ENCLOSED MASONRY BIN



Dimensions 2m long x 1.5m high x 1.5m wide  
Effective capacity 1.8m x 1m x 1.2m = 2cu m approximate

other days. Domestic wastes may be more on Sundays than on weekdays. Holidays and feast days may give rise to significant surges in wastes generation.

To avoid containers overflowing, it is advisable to allow up to 50% excess capacity above average generation rate when collection takes place every day of the week. If the collection service operates only six days/week at least 100% over-capacity is necessary to contain 2 days' wastes production.

In the case of communal containers it may be prudent to provide a 100% margin even for a 7 days/week service. Such a policy is particularly helpful where 200-litre drums are used, because the average drum will then be only half full on most of the occasions that it is emptied. This reduces the effort required of the collectors, and it also minimises exposure of the wastes to view or to interference.

## CHAPTER 7.

### REFUSE COLLECTION VEHICLES

Refuse collection is the process of transferring solid wastes from the storage receptacle to the place of disposal. Essentially this involves emptying the storage container into a vehicle in which the wastes are transported, but it is possible to organise this service in many different ways and to employ transport methods ranging from handcarts to 30-tonne vehicles. Refuse collection is a very costly service and every city should evaluate both vehicles and methods in order to find the system which is most appropriate to local conditions in terms of quality of service and cost of operation.

Local conditions may vary enormously; for example, a tonne of Indian wastes may occupy a volume of 2 cubic metres, a tonne of British wastes 8 cubic metres. A daily collection in many developing countries involves a volume/dwelling of less than 8 litres; the normal weekly collection in Europe requires the removal of over 100 litres/dwelling. In USA wages are so high that it costs more to employ a man than to operate a compactor vehicle, including amortisation and excluding driver. In much of Asia the cost of operating a simple five tonne tipper may be ten or fifteen times the cost of employing one man. For these reasons, vehicles, and systems used in the West may be entirely inapplicable to most developing countries.

This chapter is a kind of catalogue of refuse vehicle types. Most of the vehicles now being manufactured for this purpose are designed for conditions in the industrialised countries; in particular for low density wastes which have to be compacted 4:1 to achieve a reasonable payload; for big pick-ups, 100 litres or more; and for high labour rates where maximum mechanisation is profitable. But to meet the conditions of developing countries the catalogue includes many kinds of vehicle not used in the West. Some of these vehicles were used in Europe 20 to 40 years ago, but are no longer manufactured. They do, however, represent a period when some western cities had wastes of high density, not dissimilar to the wastes of some

developing countries at present; and when western labour costs were much lower, and mechanisation of less importance. Some of these designs may be relevant to the needs of developing countries.

### **Basic Aims of Vehicle Design**

The following aims are applicable to vehicles of all types :

#### **7.1.**

- the load should be covered during transport; this is imperative for motor vehicles travelling at 30 kph or more, less important for very slow moving vehicles;
- the loading height of vehicles receiving the contents of manually emptied containers should not exceed 1.6 metres;
- unless the load is carried in portable containers, the body of a vehicle should have hand-operated or power-operated tipping gear, or a power-operated ejection plate;
- the transfer of wastes from a primary collection vehicle to a larger vehicle should never involve dumping the load on the ground and both vehicle designs should take account of this;
- there are many situations in which the most suitable vehicle will be a handcart or one drawn by an animal; these vehicles should receive the same standards of mechanical design as motor vehicles, particularly as to ball or roller bearings for wheels, and rubber or pneumatic tyres.

### **Handcarts**

#### **7.2.**

Handcarts are conventionally used in Europe for street sweepings because they cause minimum obstruction and their capacity is enough to keep a sweeper busy for up to two hours. They are also used in parts of Asia for daily house-to-house collection, especially in very narrow streets inaccessible to motor vehicles. But Asian handcarts are often open boxes, and the only means of transferring the contents to a larger vehicle is to dump them on the ground and use a shovel or a basket for re-loading. This is wasteful of labour and increases vehicle standing-time.

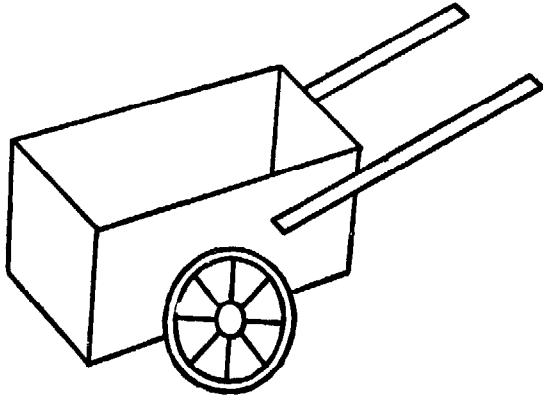
Thus the most important design feature is to ensure that the load is carried in a number of containers which can be lifted off the cart and emptied directly into a larger vehicle. This requirement can be met by constructing the cart in the form of a light framework of tubular steel or angle with a platform on which four or six bins of about 70 litres volume can be carried. In Mexico handcarts are used that comprise a platform supported by four small wheels and carrying two 200-litre (oil) drums, but a problem with containers of this capacity is that two men are needed to empty the drums into a vehicle.

For the daily collection of refuse house-to-house, one 6-bin handcart load would be equivalent to about 50 dwellings at 8 litres/dwelling/day, and one collector would be able to serve from 200 to 300 dwellings/day. At a density of 500 kg/cu metre, the weight per load would be

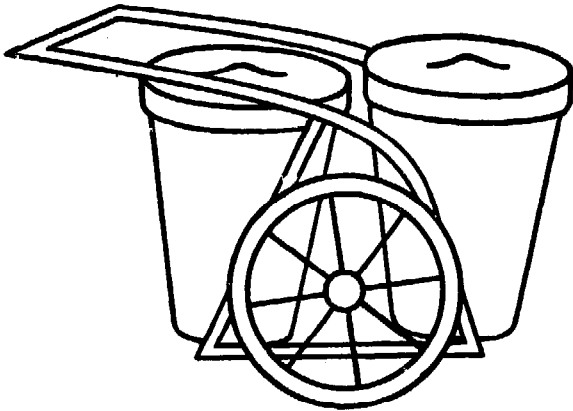


Figure 3

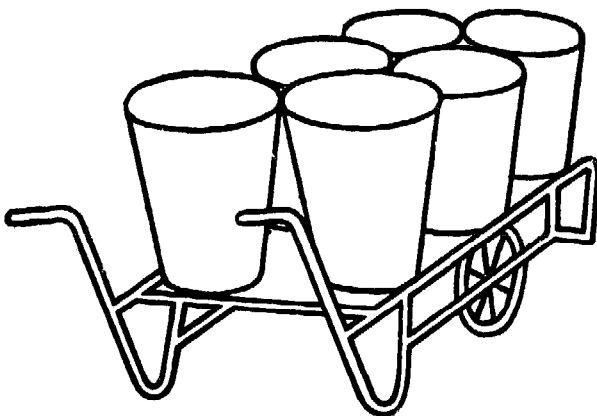
## HANDCARTS



Handcart with box body, a type widely used in Asia by sweepers and sometimes for refuse collection. Capacity from 200-500 litres. Emptied by dumping contents on the ground.



Two-bin handcart in general use throughout Europe by sweepers, total capacity 120-200 litres according to bin size. The bins are emptied directly into a transfer facility.



Six-bin handcart suitable for daily collection of domestic wastes where generation is low. The total capacity can be from 300-500 litres. Bins emptied directly into a transfer facility. Handcarts of this type have been used in Britain for collection of kitchen waste separately, for conversion to animal feed.

about 200 kgs, excluding the cart, and this is well within the capacity of the average man to push, unless there are very steep hills, provided that wheels and bearings are of good design. The radius of operation of a handcart is only about one km, thus frequent transfer points are needed. This question is discussed later under the heading of "Short-range transfer".

### **Pedal Tricycles**

7.3.

Pedal-tricycles with a box carrier in front, still used by errand boys in parts of Europe, and common in Asia, can be adapted to carry wastes, but their volumetric capacity is less than a handcart. They do reduce travelling time and can, therefore operate over a larger radius than a handcart. They were used in Saigon by self-employed refuse collectors who served about 200 dwellings/day.

### **Animal Carts**

7.4.

Until World War II, horses were widely used in Europe for door-to-door collection; horses, mules and bullocks are still used in many parts of the world. The capacity of draught animal carts ranges from two to four cubic metres and they often have tipping bodies, either by pivoting the body or the use of a manually operated worm and nut. Animal carts have these advantages:

- no consumption of fossil fuels,
- very low cost compared with motor vehicles,
- almost silent in operation,
- the driver can leave the vehicle and assist in loading.

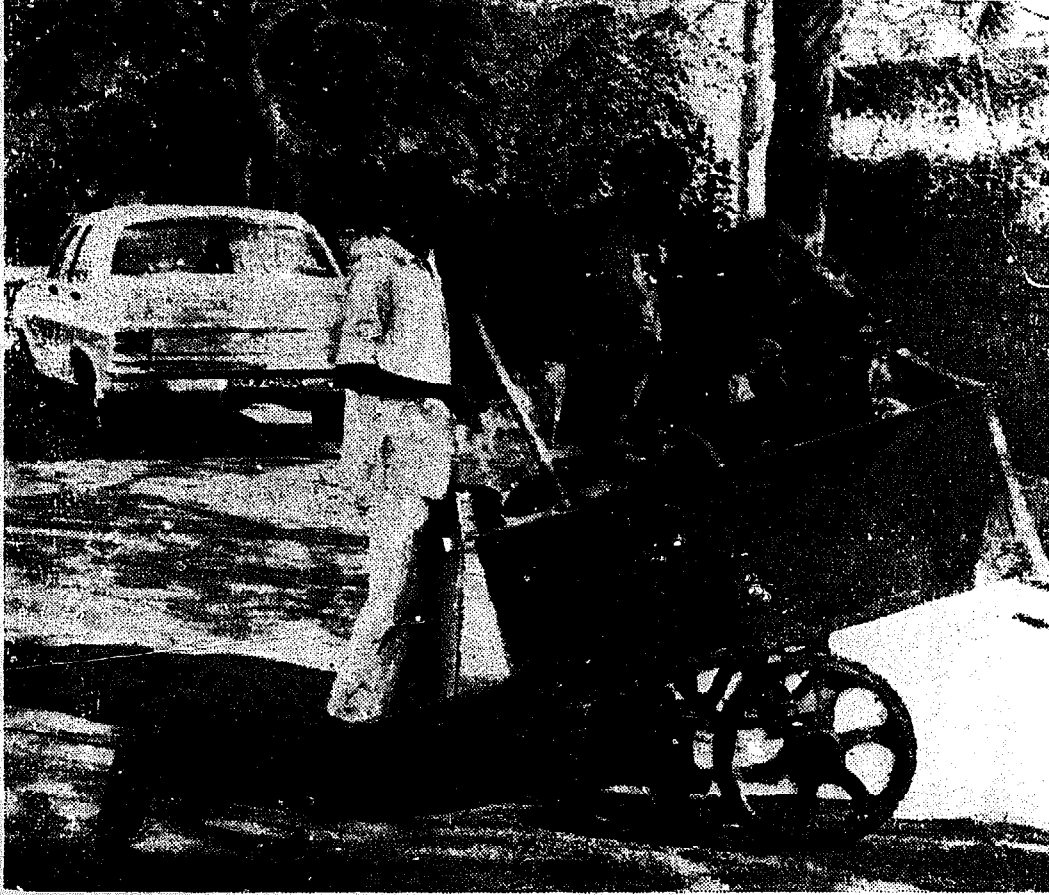
Their slow speed limits their effective radius of operation to about 3 kms, and in busy streets they may interfere with motor traffic. This point is valid while they are travelling; during collection, however, a stationary motor vehicle is equally obstructive. Animal carts normally operate from a two-level transfer station at which they tip their loads directly into a large motor vehicle at lower level. Madras successfully operates this system and enjoys the advantages of both methods of transport: bullocks for the slow "stop-go" element and motor vehicles for high-speed transport over the relatively greater distance from the city to the disposal site.

There is a need to give much greater attention to the design of animal carts; they should be low-loading steel bodies mounted on pneumatic tyres, and fitted with sliding shutters and manually operated tipping gear.

### **Pedestrian-electric Vehicles**

7.5.

These electric-powered vehicles, the driver of which walks in front, are employed in Britain for team-sweeping, but their capacity of two to three cu metres gives them a potential for refuse collection as an alternative to animals.



5. Handcart  
used for house-to-house  
collection on a private  
estate in Delhi



6. 3-Bin pedal-tricycle  
(Amsterdam 1949)

The speed is 5-6 k.p.h., thus the radius of operation is only about 2 kms. The battery can be charged overnight from a 13 amp outlet.

Its silent operation and lack of emission makes it an ideal vehicle for night collection in narrow streets, but the capital cost is very high and restricts its adoption to the wealthier developing countries.

### **Motor-tricycles**

7.6.

The two-stroke, three-wheel motor cycle is a much cheaper alternative to the electric vehicle. It can be fitted with a high-level tipping body of about two cubic metres capacity while retaining a low loading line. It is in common use in several cities in Asia and West Asia, particularly in old city centres where the streets are too narrow to admit larger vehicles. Its relatively high speed gives it an operating radius of about 10 kms, but it does not operate well on the rough roads of a sanitary landfill, thus, unless a refuse disposal plant is available, it should discharge at a transfer facility.

### **Tractors and Trailers**

7.7.

One kind of motor vehicle which is almost universally available in developing countries is the agricultural tractor. It has a number of attractions :

- maintenance facilities are more readily available than for most other types of vehicle;
- together with a trailer, the capital cost may be only half that of a 5-tonne truck;
- it is capable of hauling a large load relative to its h.p.;
- it is an ideal vehicle for operating on a sanitary landfill because of its large tyres and high torque;
- it has a power take-off from which hydraulic tipping gear on a trailer can be operated.

Despite its slow road speed, about 20 k.p.h., it probably offers the cheapest method of motor transport for solid wastes up to a trailer capacity of about 6 cubic metres.

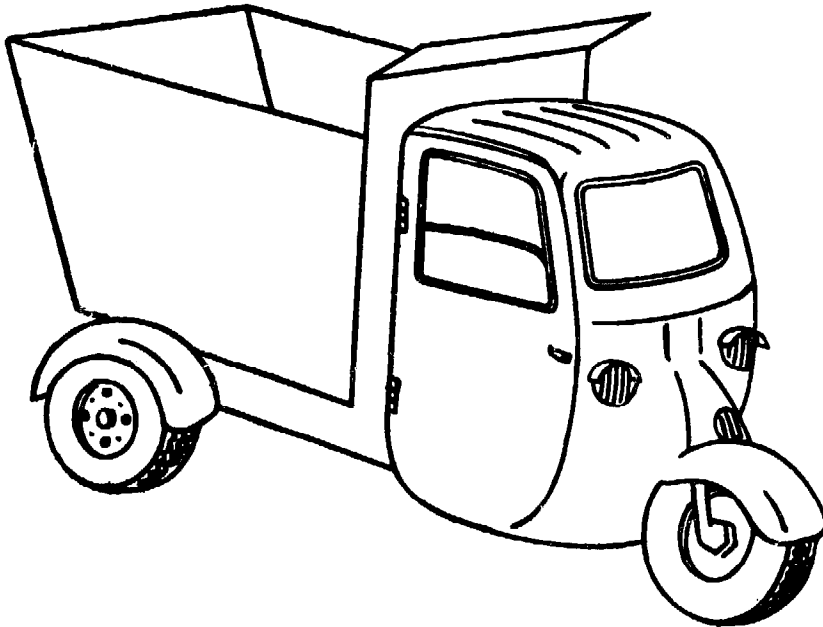
There are a number of variants of tractor-trailer systems. Mini-agricultural tractors or jeeps can be used with shuttered side-loading trailers up to 4 cu m.; agricultural tractors up to 6 cu m.; articulated semi-trailers are available with capacities up to 30 tonnes for long distance transfer.

The agricultural tractor and trailer is often used as a continuously coupled unit for the collection of refuse from houses or communal storage points, but it also has great potential as a transfer unit because of the ease with which the prime mover and the "body" can be separated.

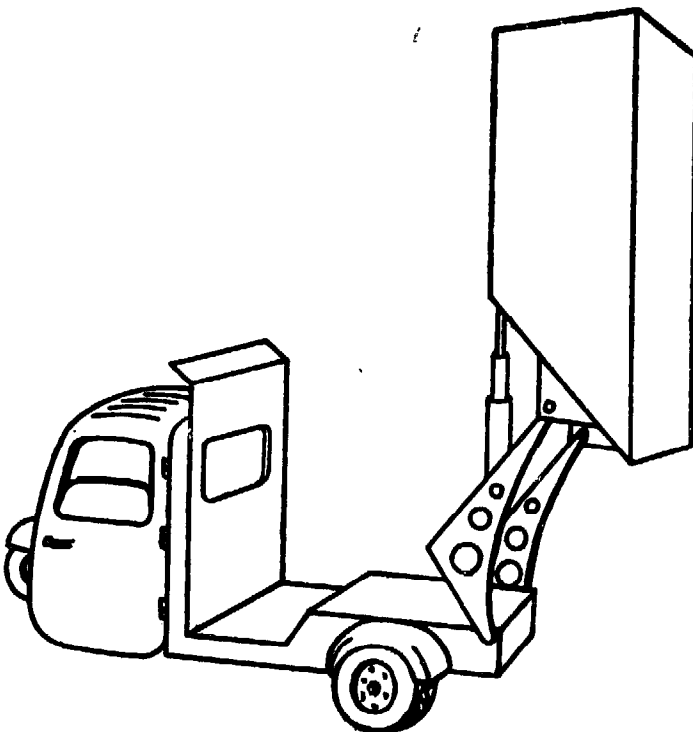
The work performed by a refuse vehicle can be divided into two parts: the period while it is stationary during loading represents lost time for the prime mover; the

Figure 4

LIGHTWEIGHT MOTOR TRICYCLE



Body capacity  
about 2 cubic  
metres.



The hydraulic tipping  
gear is cleverly designed  
to permit discharge at  
about 1.5 metres above  
ground level-direct into  
a transfer facility. This  
could be the hopper of  
a compactor vehicle, or  
a skip.

other period which is spent travelling at normal road speed with a full load represents efficient use of the prime mover. Thus for maximum productivity in terms of tonne/kms transported, loading time must be reduced to a minimum. If the vehicle can be split into the two parts, the prime mover and the body, loading time can even be eliminated by providing an extra body which can be loaded while the first one is being taken to disposal. If the tractor, the prime mover, can be used solely for the transport of full trailers loaded in its absence, it will be fully employed in travelling and in suitable conditions it is possible to transport double or treble the weight/day that could be achieved by a rigid vehicle. Those conditions can be:

- at large sources, such as markets, where a trailer can be stationed permanently and used as the communal container for the market,
- where the wastes from multiple small sources, such as dwellings, are collected by other means, such as handcarts, and brought to the trailer.

This method of using tractor trailer units will be further considered under short-range-transfer.



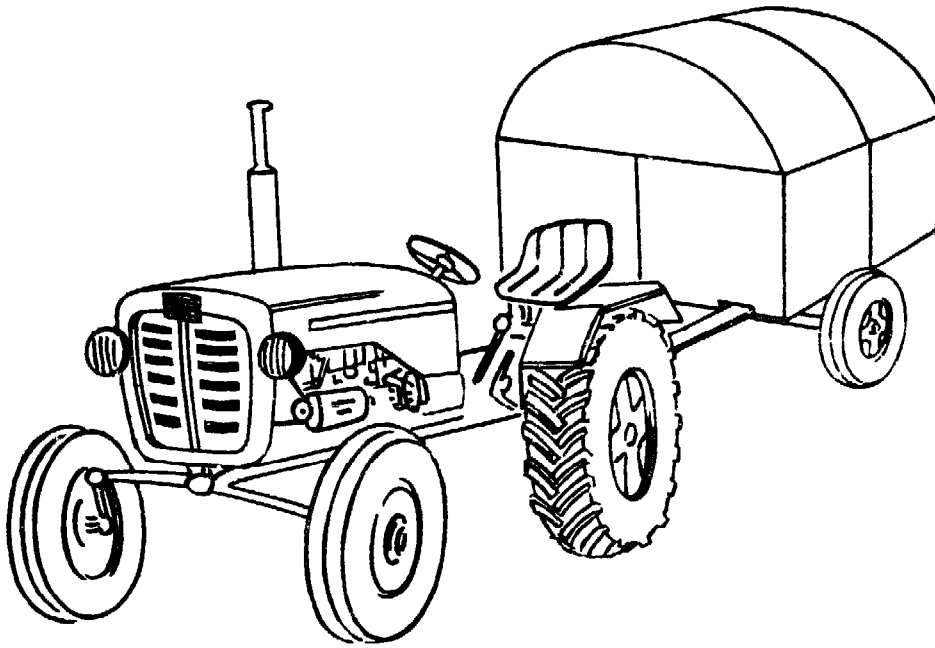
*7. The simple tractor and trailer, used for secondary collection in Kathmandu, has hydraulic tipping gear. It was manufactured in India.*

**5-7 Tonne Truck**  
**7.8.**

This is a type of vehicle available throughout the world and widely used for the collection of wastes from communal sites. It is designed primarily for the transport of building materials; the body, usually of steel, comprises a flat platform with hinged side and tail-boards 40-60 cms high. The volume is usually about 5-6 cu metres, very suitable for high density materials such as bricks and aggregates. In its standard form this vehicle is rarely able to

Figure 5

AGRICULTURAL TRACTOR

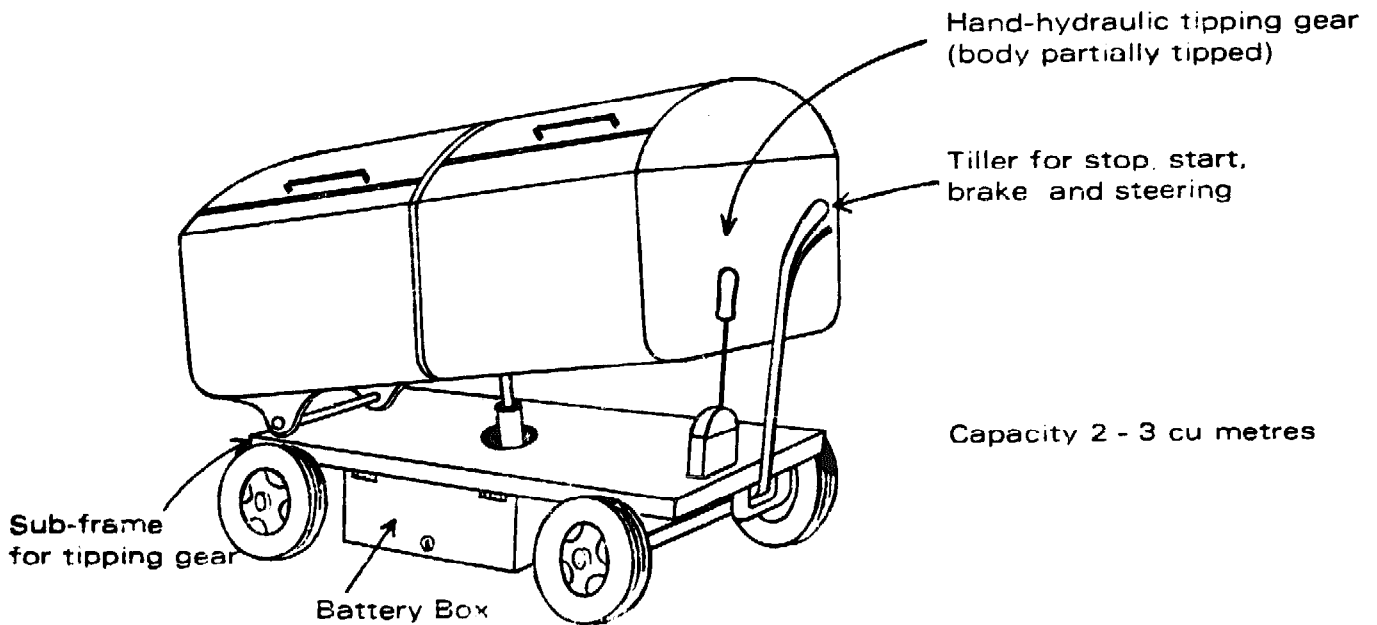


An agricultural mini-tractor can tow a 3 cu metre side-loading trailer with sliding shutters. Hydraulic tipping gear is operated by a power take-off.

A bullock could be used to tow a trailer of this design if hand-operated worm and nut tipping gear was substituted for hydraulic.

Figure 6

PEDESTRIAN OPERATED ELECTRIC VEHICLE



carry its rated payload of solid wastes; even high density wastes heaped on the vehicle would be unlikely to exceed four tonnes. It is a common practice, therefore, to extend the height of the sideboards in order to increase the cubic capacity. This makes it necessary to use ladders to load the vehicle, or to place men inside the body to receive baskets of wastes handed up to them by the collectors.

The commercial truck, however, has the following advantages:

- it is cheap, robust and easily obtainable,
- it has good ground clearance and performs well on rough ground.

**5-7 Tonne  
Low-loading Chassis  
7.9.**

It is desirable that a refuse collection vehicle should have:

- large volume, at least 2 cu m/tonne of rated carrying capacity, because of the low density of the wastes compared with most commercial loads;
- a loading height not exceeding 1.6 metres.

There are four design features that enable these requirements to be met without complex mechanisation of the body:

- reduction in the height of the chassis by the use of wheels of smaller than standard diameter\*; this does, of course reduce ground clearance;
- use of full forward control ("cab-over-engine") to increase space on the chassis for the body;
- extension of rear overhang;
- use of a long wheelbase.

By these means it is possible to provide an enclosed body of about 8 cubic metres without exceeding the desired loading height of 1.6 metres. The most common type of body having these features is the side-loader. This has three or four loading apertures along each side and these can be closed by means of sliding shutters, usually plain sheets of metal running in grooves. The load can be trimmed within the body by the use of long-handled drags and during the final stages of loading can be heaped against closed shutters along one side. These vehicles should be fitted with hydraulic tipping gear.

**Barrier Loader  
7.10.**

The barrier-loader has a van type body, loaded from the rear. Hanging from roof-fixed rails is a movable

\* A reduction in the maximum permissible load results from the use of smaller than standard wheels and tyres. But the conventional 7-tonne truck will rarely accommodate more than 6 cu metres, weighing about 3½ tonnes, and is normally under-loaded. A low-loading vehicle could be designed on the 7-tonne chassis to have a body of about 8 cu metres for which a tyre rating of 5 tonnes payload would be adequate.



Figure 7 (a)

SPECIALIST DESIGN OF REFUSE COLLECTION VEHICLES TO LOWER THE LOADING LINE, ENCLOSE THE LOAD, AND INCREASE CAPACITY

STANDARD COMMERCIAL TIPPER

REFUSE COLLECTION VEHICLE ON MODIFIED CHASSIS

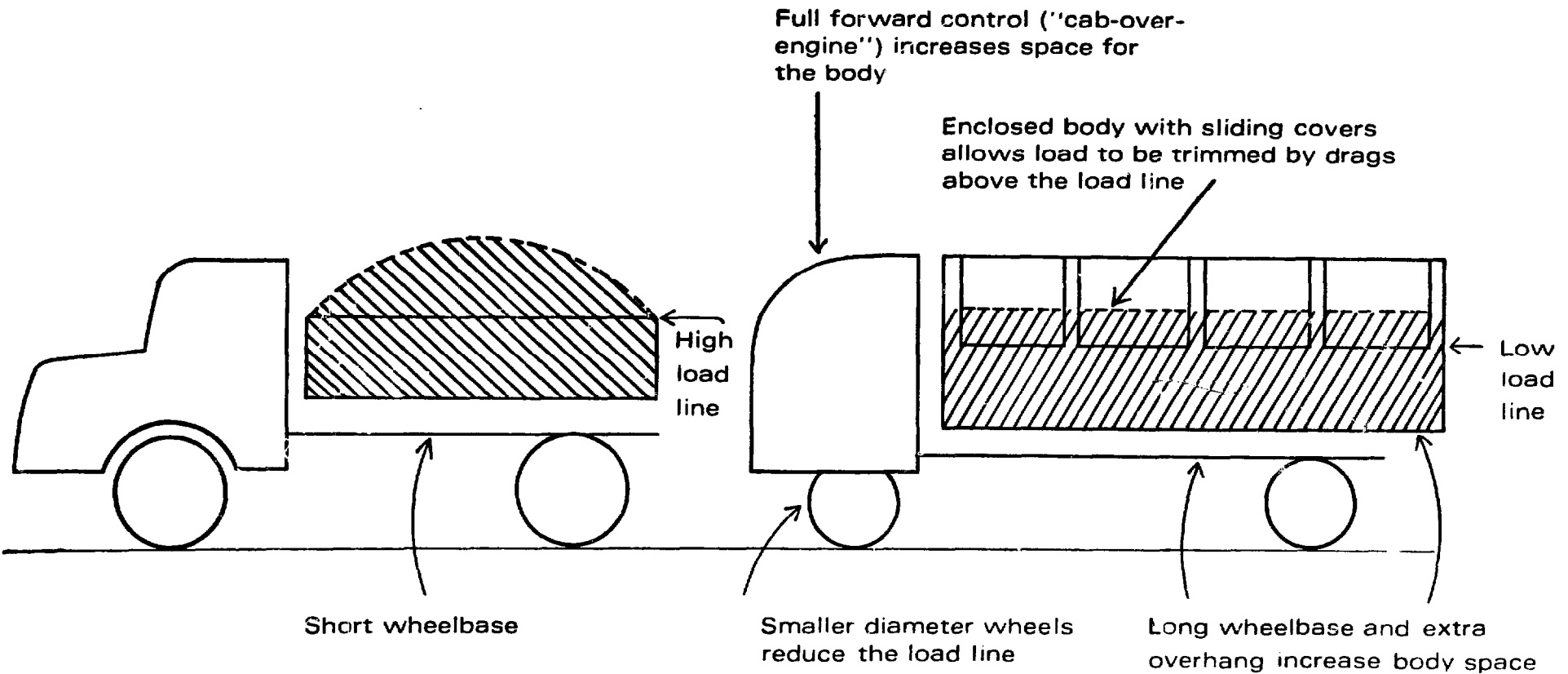
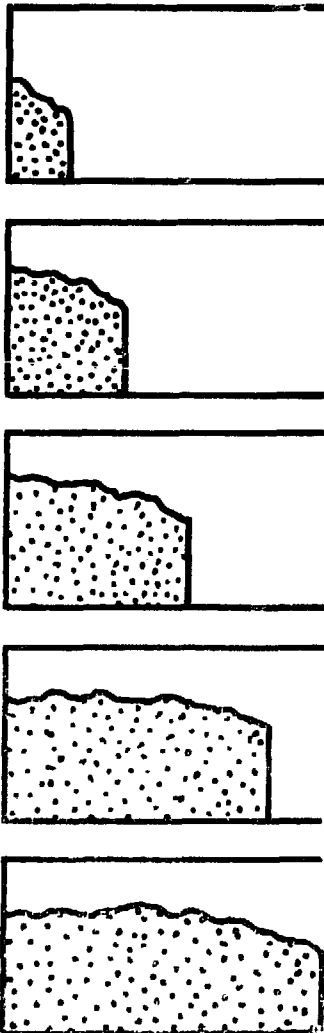
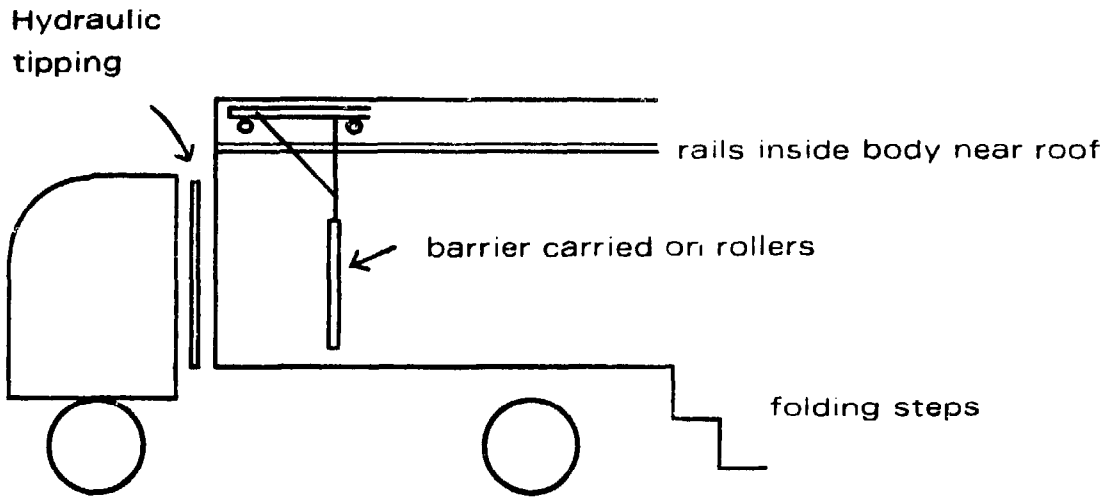


Figure 7 (b)

### BARRIER LOADER



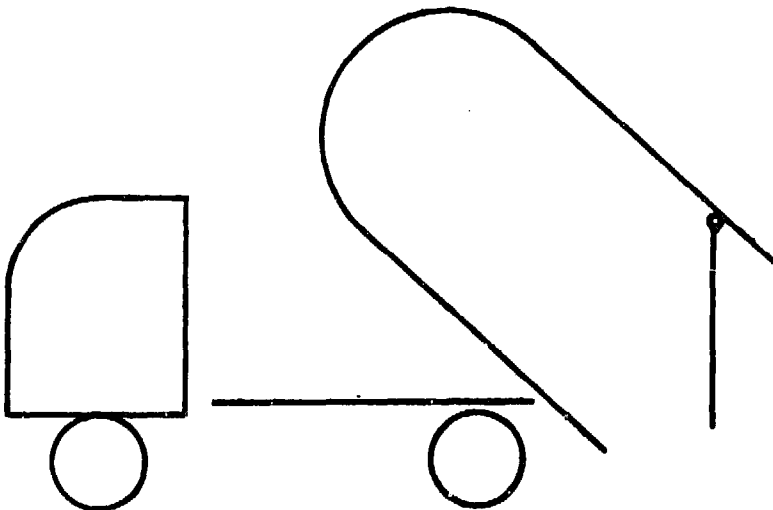
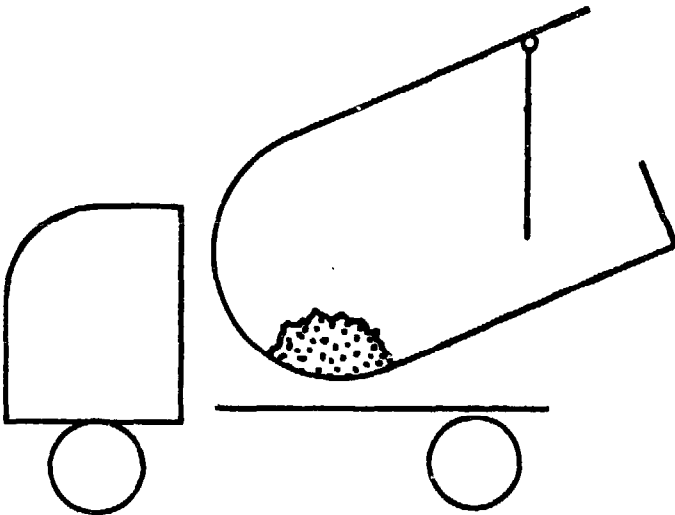
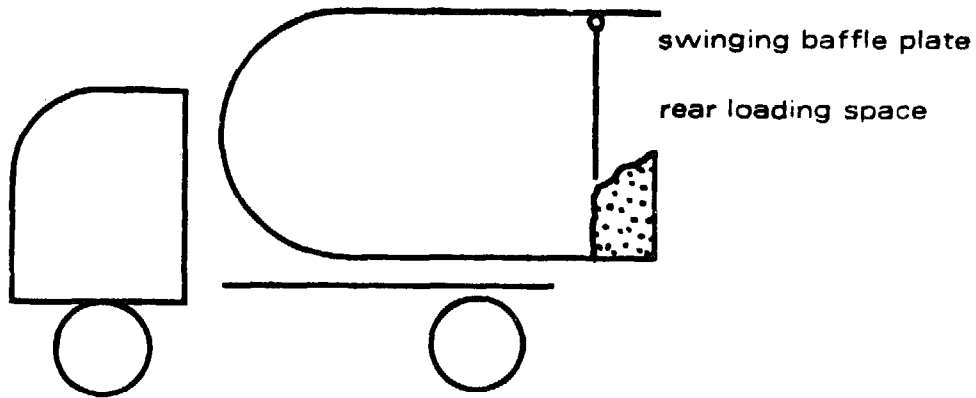
#### STAGES IN FILLING VEHICLE

Collectors walk inside and empty bins over barrier. Barrier is moved manually towards the rear when available space has been filled

For high density wastes the barrier loader achieves a similar result to the compactor vehicle without employing costly hydraulic mechanisms, but it is more labour-intensive as the collectors have to walk inside the vehicle

Figure 7 (C)

FORE AND AFT TIPPER



When rear space is full, the body is tipped forwards to transfer wastes to the front end.

The baffle plate prevents wastes from falling towards the rear when the body is returned to horizontal.

The load is discharged by normal tipping to the rear.

For high density wastes the fore-and-aft tipper performs similarly to a compactor, but with a simpler mechanism. The operator must be careful not to elevate the body in a street with overhead power lines

barrier which extends across the body to a height of 1.6 metres above the floor. Loading begins with the barrier close to the front of the body and the collectors walk inside, using hinged steps at the rear, and deposit the refuse behind the barrier. When that space has been filled, the barrier is moved towards the rear of the vehicle. This is repeated in about six stages until the vehicle is full.

The contents are discharged by hydraulic tipping gear, the barrier swinging clear during this operation. Side loaders and barrier loaders were in common use in Britain from 1925 onwards, a period when domestic wastes had a density of 300 kg/cum or over, similar to that of many developing countries today.

**Fore and Aft  
Tipper  
7.11.**

This is a design that appeared in the mid-thirties and was widely used in Britain until quite recently. Its main feature is that the body can be tipped two ways: towards the rear for unloading, and towards the front for the transfer of wastes loaded at the rear to the front end of the body. In a simple and rather clumsy way it achieves the same result as the hydraulic ram at the rear of a compactor vehicle, but the compression effect is much less positive. The forward tipping operation may be required about 12 times per load; a suspended barrier prevents the wastes from falling back after elevation of the body. Body capacities of about 12 cubic metres were normal with this type of vehicle.

It represents a halfway stage towards compactor vehicles and is suitable for densities from 250 kg/cu metre upward. It can be built on a standard chassis with normal wheel diameter, and presents few maintenance problems.

**Container-hoist  
7.12.**

This vehicle comprises a standard commercial chassis in the 5-10 tonne range which is equipped with a pair of hydraulically operated lifting arms which are used to lift a detachable body on or off the flat floor of the vehicle. The detachable body is a metal box, called a "skip" in Britain, having a capacity from 3 cubic metres upward. The skip can be tipped, to discharge its load, while in position on the parent vehicle.

The container-hoist is an alternative to tractor-trailer units and has the following advantages:

- a skip is much cheaper than a trailer;
- a skip is much less liable to damage by fire, vandalism or loss by theft than a trailer;
- the speed of a container vehicle is much higher than that of an agricultural tractor.

barrier which extends across the body to a height of 1.6 metres above the floor. Loading begins with the barrier close to the front of the body and the collectors walk inside, using hinged steps at the rear, and deposit the refuse behind the barrier. When that space has been filled, the barrier is moved towards the rear of the vehicle. This is repeated in about six stages until the vehicle is full.

The contents are discharged by hydraulic tipping gear, the barrier swinging clear during this operation. Side loaders and barrier loaders were in common use in Britain from 1925 onwards, a period when domestic wastes had a density of 300 kg/cum or over, similar to that of many developing countries today.

**Fore and Aft  
Tipper  
7.11.**

This is a design that appeared in the mid-thirties and was widely used in Britain until quite recently. Its main feature is that the body can be tipped two ways: towards the rear for unloading, and towards the front for the transfer of wastes loaded at the rear to the front end of the body. In a simple and rather clumsy way it achieves the same result as the hydraulic ram at the rear of a compactor vehicle, but the compression effect is much less positive. The forward tipping operation may be required about 12 times per load; a suspended barrier prevents the wastes from falling back after elevation of the body. Body capacities of about 12 cubic metres were normal with this type of vehicle.

It represents a halfway stage towards compactor vehicles and is suitable for densities from 250 kg/cu metre upward. It can be built on a standard chassis with normal wheel diameter, and presents few maintenance problems.

**Container-hoist  
7.12.**

This vehicle comprises a standard commercial chassis in the 5-10 tonne range which is equipped with a pair of hydraulically operated lifting arms which are used to lift a detachable body on or off the flat floor of the vehicle. The detachable body is a metal box, called a "skip" in Britain, having a capacity from 3 cubic metres upward. The skip can be tipped, to discharge its load, while in position on the parent vehicle.

The container-hoist is an alternative to tractor-trailer units and has the following advantages:

- a skip is much cheaper than a trailer;
- a skip is much less liable to damage by fire, vandalism or loss by theft than a trailer;
- the speed of a container vehicle is much higher than that of an agricultural tractor.



8. Standard commercial truck with extended sideboards to increase capacity. (Saigon)



9. Mini-tractor with low-loading trailer and hydraulic tipping gear. (Colombo)

The disadvantages are :

- the cost of a container vehicle is double that of an agricultural tractor;
- in many cases it transports a smaller weight than a tractor-trailer.

10. Container-hoist vehicle, sometimes called a "dumper-placer" as used in Delhi.



The source of this last problem is that the manufacturers of skips appear to aim primarily at the handling of demolition wastes which may go more than a tonne to the cubic metre. For example the standard skip made in India is of 3 cu metres, equivalent to about 1.5 tonnes of Indian wastes. For a 4-tonne payload the Indian skip needs to be of 8 cu m.

There is no problem in the manufacture of skips of these sizes: they are available in Europe for waste-handling and could be made in most countries. Meanwhile it is not recommended that developing countries should embark on skip systems based on capacities as small as three or four cu metres.

**Vehicle  
Standardization  
7.13.**

It has been observed that some developing countries have very mixed vehicle fleets and very low vehicle serviceability, down to 60% in some cases. These two things may be connected. If many different vehicle models are operated, it is virtually impossible to carry adequate stocks of spares, thus vehicles may be off the road for long periods while spares are purchased, sometimes through a centralised purchasing organisation which causes additional delay by requiring competitive tendering for even minor items.

Stores control can be simplified and spares availability improved by fleet standardization. Furthermore, major spare units (engines, transmissions, axles and hydraulics) can be held. These spare units are used to replace defective units in a vehicle which can then be put back on the road within a few hours and the units which have been removed can be repaired at leisure.

NOTE: Compactor vehicles have not been considered here, for the following reasons:

- (a) Compaction ratios achieved with western wastes of 100-150 kg/cu m initial density range from 2:1 to 4:1, the final density in the vehicle being about 400-500 kg/cu m. Most South Asian wastes have an initial density similar to that of compacted western wastes.
- (b) The compaction mechanism imposes a need for additional maintenance facilities which some cities may find difficult to provide.
- (c) Compactor vehicles would usually have to be imported; there may be problems of foreign exchange and spare parts.
- (d) The compaction mechanism greatly increases fuel consumption.
- (e) The capital cost of a compactor vehicle is significantly greater than that of a conventional tipper.



## CHAPTER 8.

### ACCESS AND POINT OF COLLECTION

Thus far, the two main elements of a refuse collection service have been considered: storage of the wastes, and vehicles for collection. These elements are linked at the collection point, the location of which is conditioned by several factors:

- the physical characteristics of buildings;
- the access to the buildings and the width of roads;
- the proportion of the work of refuse collection which is carried out by the householder.

The storage system for solid wastes and the provision of access to the storage point for the refuse collectors should be given careful consideration at the design stage of any building. Town planning and building regulations in some countries deal with this matter and often require that plans for all new buildings be submitted to the department responsible for solid wastes services for their approval. But in most countries there has been little, if any, regulation of this kind, and every city contains numerous structures for which it is almost impossible to devise a satisfactory storage and collection method. This chapter reviews the main problems of access for refuse collection and it will be found that building construction and dwelling standards can be the main determinants of:

- frequency of collection,
- vehicle type and size,
- the duties which have to be imposed upon the householder.

#### **Separate Dwellings 8.1.**

The separate dwelling surrounded by a garden or a walled courtyard is ideal in most respects:

- the bin can be kept outside the house, in the open air,
- provided that the bin is impervious and has a lid, collection frequency is not critical: a twice-weekly collection would certainly be adequate;
- it is unnecessary (except for financial reasons, such as labour cost) to impose duties on the householder: the collector can enter the garden, carry out and empty the bin, and return it to its normal position.

On the question of collection frequency, it seems to be generally assumed that the low frequency in Europe and USA—once or twice weekly—is because of temperate climate, and that it is essential for tropical countries to have a daily collection because of the more rapid decomposition of food wastes. But some parts of Europe and USA can have very hot climates. It is arguable that low collection frequency in Europe and USA is acceptable primarily because of the high standards of domestic storage which prevent obvious odour emission and access by insects, and also because a high proportion of dwellings have yards or gardens. It is possible that a weekly interval would usually interrupt the life cycle of the housefly. This suggests that the most important single problem for some of the developing countries is that of nuisance-free domestic storage.

Separate dwellings can range in size from a small cottage to a luxury villa; in every case there is almost complete flexibility of collection method. Cost is likely to be the main criterion in the selection of vehicles and methods.

This term is used to describe single or two-storey dwellings which are built as a continuous block. If such houses have a yard at the back which gives on to a secondary means of access which can be used for refuse collection, they have all the essential characteristics of single dwellings and a full "carry-out" service is practicable.

Many terrace blocks, however, have only front entrances and it is then necessary to impose on the householder part of the refuse collection process. At the very least this could be to place the bin outside his dwelling at a point accessible to the collectors.

At all terraced dwellings in tropical countries a daily collection may be desirable because of limited external storage area.

Apartments over shops are the equivalent of terrace blocks in most respects. If the shops have a secondary access via a yard at the rear, domestic as well as shop refuse could be stored and a full "carry-out" service could be operated.

When access is only from the front, the minimum requirement would be for shop owners and apartment dwellers to place their bins in front of the premises prior to the arrival of the collectors and to remove them afterwards (a "kerbside" collection). This applies also to "lock-up" shops, kiosks, etc.

Collection frequency should be daily because of limited storage capacity and also because bins may be shared by

### **Terraced Dwellings 8.2.**

### **Dwellings over Shops 8.3.**

more than one family which reduces the standard of care.

**Multi-storey  
Dwellings**

8.4.

Sometimes apartment blocks of three or four storeys have balconies at the rear, reached by an external staircase, and in these circumstances a full collection service is possible if the bin is kept on the rear balcony.

When apartments have only one entrance it is possible to provide a door-to-door service. Collectors in Beirut were observed to carry large, strong, plastic sacks for apartment collections. The man went to the door of each apartment, knocked, and waited until the housewife brought out her kitchen bin. This he emptied into his plastic sack, which was large enough to contain the wastes from several apartments, thus reducing the number of occasions on which he had to leave the building to deliver wastes to the vehicle.

The alternatives are either batteries of small bins or a large container for communal use. In either case, the frequency of collection from apartment blocks should be daily because of limited storage space in the apartments and the likelihood that communal storage, if used, may be operated to a low standard.

**One-room  
Dwellings**

8.5.

In the poorer areas of many large cities a family may cook, eat and sleep in one room. This may be part of a much larger dwelling unit, or one of a large group of temporary or permanent shacks. In either case storage of wastes on the premises for more than a few hours is very difficult.

In the absence of any private space where a waste bin can be kept, public space must be made available. Thus in these conditions there seems no alternative to the provision of communal containers in the streets. These should be emptied daily.

Small communal containers closely spaced (not more than 100 m apart) are better than large ones at greater intervals because they are more likely to be used. Ideally, communal containers should be on a paved street wide enough for a motor vehicle, but small containers can be moved through narrow alleys on hand trolleys to the nearest road.

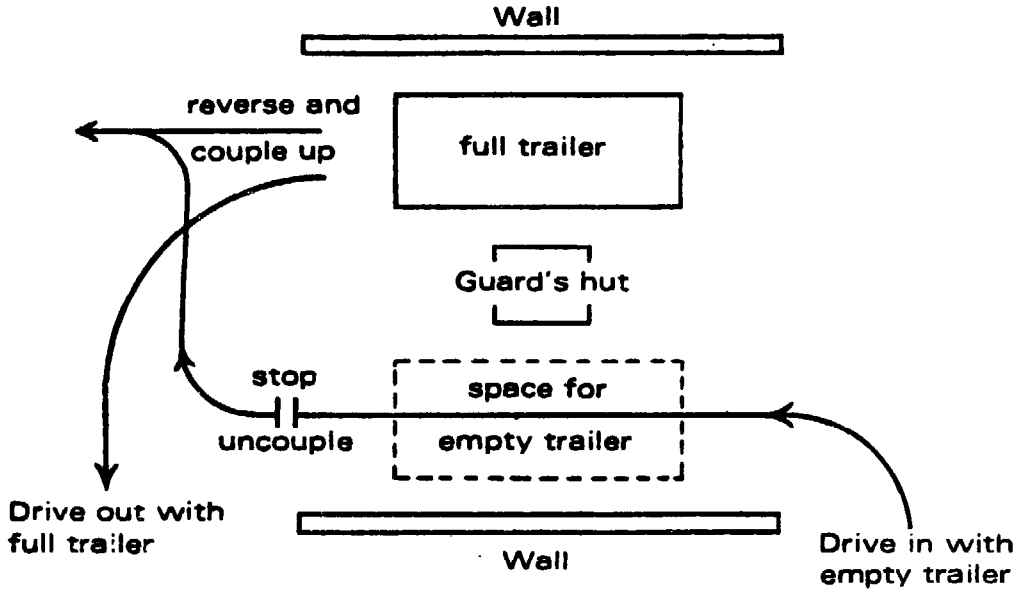
**Markets**

8.6.

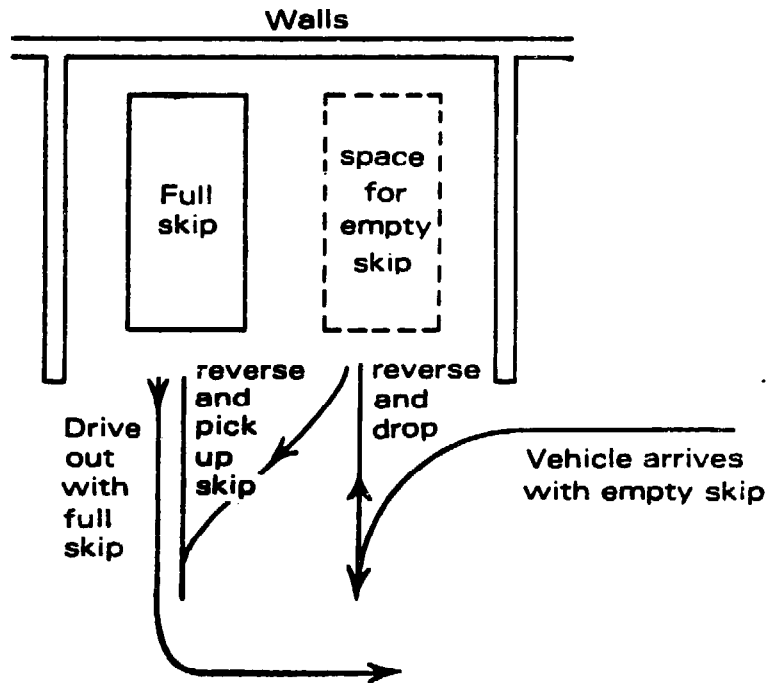
A common feature of most developing countries is the large market with stalls jammed closely together, fronting on narrow passages which are usually thronged with pedestrians and littered with wastes. Sweepers are usually employed to bring the wastes from the passages to a central storage point which is too often a large heap on the ground. This is removed from time to time by a motor vehicle and a collection crew.

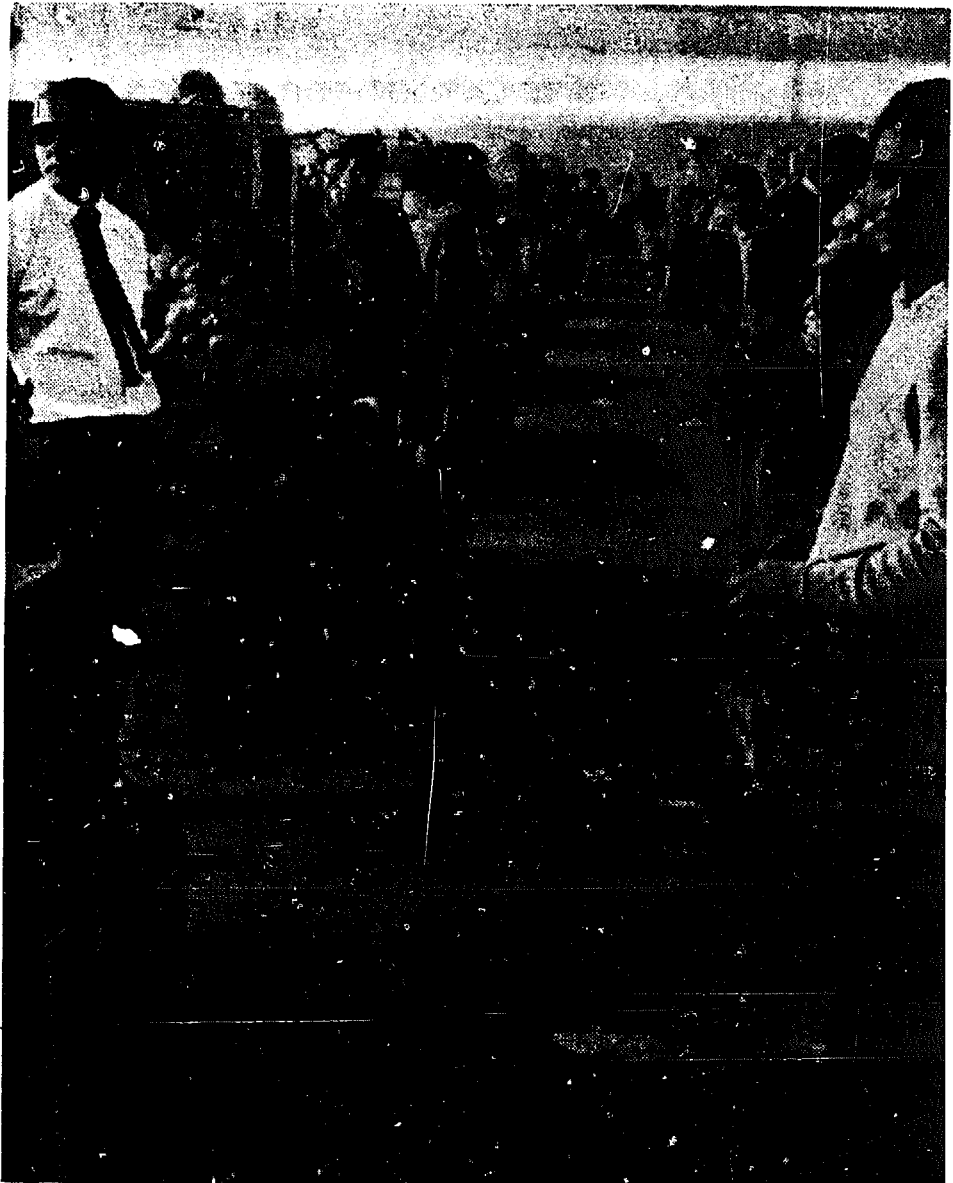
Figure 8

SITE LAYOUT FOR TRAILER EXCHANGE



LAYOUT FOR CONTAINER EXCHANGE





10. *An ideal method of storing market refuse. Every stall has its own bin which is emptied from time to time into a trailer in a yard. The trailer is towed by a Land-Rover (Doha)*

At Doha (Qatar) a market was observed which provides a model system. Every stall has a steel bin of about 70 litres, and is visited by a sweeper with a trolley who exchanges full bins and empties them into a shuttered trailer of about 3 cu metres capacity stationed in a yard immediately adjacent to the market. When the trailer is full it is exchanged for an empty one by a Land-Rover.

**Access  
for Trailer  
or Container  
Exchange**  
8.7.

There are usually several kinds of premises that produce wastes in quantities sufficiently great to justify the use of a trailer or a large container for central wastes storage. Typical buildings would be hospitals (for domestic, not pathological wastes), barracks, very large hotels, large factories and office complexes, in addition to the markets already referred to.

The layout and the location of these storage points needs

careful planning, to enable the exchange to be effected with minimum effort and to avoid interfering with local traffic flow. The following are the main issues :

The site should be located on an internal road of the premises to avoid complex vehicle manoeuvres on a main road.

One extra space is required on which the empty trailer or container can be placed.

For trailer exchange it is a great advantage to be able to drive right through the area; this avoids the need to reverse trailers into position.

If only one space is available the following time-consuming exchange procedure is necessary :

On approaching the site drop off container at a convenient place.

Pick up full container from site, drop it off at a convenient place.

Pick up empty container and drop on site.

Return to full container, pick up and proceed to disposal.

The simple procedure of one drop and one pickup (or one uncouple and one couple), which is possible with a spare space, is illustrated in the sketches.

There are many ancient city centres where lanes are too narrow to allow access by motor vehicles, and this has been one reason for the continuing use of large communal sites in some Asian and Arab cities.

## **Narrow lanes 8.8.**

Narrow alleys, sometimes only a metre wide, are also a characteristic of slum areas that spring up to house refugees from war or natural disasters. Their inaccessibility to conventional collection methods has sometimes caused such areas to be entirely denied collection services, with the consequence that wastes are disposed of in ditches and rivers.

A daily collection from areas such as these, where population density is usually very high, is essential not only for the protection of the people who dwell there, but out of concern for the health of the city as a whole, because vectors know no boundaries.

The use of handcarts is the obvious solution to the access problem; they could be used for a door-to-door service, or for exchanging small communal containers. Sometimes, however, such communities are established on steep hillsides; in Lebanon a problem of this kind was solved by the use of donkeys with steel panniers in which the collected wastes were carried. Mules would be even more suitable.

## CHAPTER 9. BASIC COLLECTION SYSTEMS

Four basic collection systems have been evolved in relation to the amount of work imposed upon the householder :

- communal storage which may require delivery of the wastes by the householder over a considerable distance;
- block collection, where the householder delivers the wastes to the vehicle at the time of collection;
- kerbside collection, where the householder puts out and later retrieves the bin;
- door-to-door collection where the collector enters the premises and the householder is not involved in the collection process.

### **Collection from Communal Sites** 9.1.

The organisation of refuse collection is greatly simplified by the use of large communal storage sites. The city of Delhi, for example, is served by about 1,250 sites having capacities from 0.5 to 10 tonnes for a population which exceeds 4 millions. Delhi probably has about 800,000 separate sources of wastes (dwellings and shops) and a frequent collection direct from every source would require a much more complex organisation and possibly greater expenditure. However, when sites are widely spaced, a great deal of domestic wastes are deposited in the streets by householders too lazy to carry it to the depot or masonry enclosure. It is significant, therefore, that only by employing about 10,000 sweepers Delhi is kept in a tolerable standard of cleanliness.

While the use of large communal sites may appear to be a fairly cheap and simple solution, it may transfer much of the burden of refuse collection on to the street cleansing service and actually increase total costs, because it is cheaper to collect refuse direct from a house than to sweep it up from the streets. In Delhi, in the year 1974 Rs 31,000,000 were spent on sweeping, only Rs 7,330,000 on refuse collection.

The use of large, widely spaced communal storage sites is usually a failure because the demand placed on the householder goes beyond his willingness to co-operate. Communal storage points should, therefore, be at frequent

intervals. Madras, Bangalore and Manila provide fixed concrete receptacles with capacities between 100 and 500 litres on footways or verges at intervals of 50 to 200 metres. The objections to these have been stressed earlier, but they are fairly successful because they place a reasonable and acceptable duty on the residents, thus very little domestic wastes is thrown in the street.

Both the large masonry enclosure and the smaller concrete bin are inefficient in the use of manpower and vehicles. Wastes have to be removed by rake or shovel and basket; it is a slow process and vehicle waiting time during the loading process is excessive. Vehicles employed on this work tend to interfere with other traffic in the street. The following work performances have been recorded:

Delhi, masonry			
enclosures	1.4 tonnes/man/day	7 tonnes/vehicle/day.	
Bangalore, concrete			
pipes	1.2	6	„

Drums of 200 litre capacity are far from an ideal solution, but the fact that two men can usually empty them directly into a vehicle with a low load line greatly increases daily performance: probably to about 5 tonnes/man/day and 10 tonnes/vehicle/day.

In this system, a collection vehicle travels a regular route at prescribed intervals, usually every two days or every

**Block Collection  
9.2.**



*12. 4-Bin handcart made locally for a pilot test of house-to-house collection in Kathmandu. Baskets were chosen as containers to avoid importing galvanised steel bins.*

A design error was the use of bicycle wheels which broke up after a few months. Rickshaw wheels which have stronger spokes and rims would have been more satisfactory.



three days, and it stops at every street intersection, where a bell is rung. At this signal the residents of all the streets leading from that intersection bring their wastes containers to the vehicle and hand them to the crew to be emptied. A crew of one or two men is adequate in number as they do not need to leave the vehicle.

Block collection should be operated frequently, otherwise the weight of wastes to be carried to the vehicle may be beyond the capacity of some of the residents. It has a significant advantage over a kerbside collection in that bins are not left out on the street for long periods.

This system is operated in Mexico City and during a study carried out by the Solid Wastes Division of the Sub-Secretariat for Environmental Protection the following data was collected. It represents the average of four routes :

Collection route, total length	2.74 kms.
Number of stops on route	25
Average distance between stops	110 metres
Bins emptied per stop	33
Total bins emptied on route	858
Average load, total weight	3,653 kgs
Dwellings on route	841
Average weight/dwelling	4.34 kg.
Total time for load	2 hours 27 mins.
Average travel time point to point	1.15 mins.
Average loading time per point	7.10 mins.

The daily performance achieved by this system is about 3.5 tonnes/man/day and 7.0 tonnes/vehicle/day.

### **Kerbside Collection**

#### **9.3.**

This, like the block collection, requires a regular service and a fairly precise timetable. Residents must place their bins on the footway in advance of the collection time and remove them after they have been emptied. It is very important that bins of a standard type should be used, otherwise it is likely that wastes will be put out in improvised containers, such as cardboard boxes, or even in loose heaps; when this occurs some of the wastes are inevitably scattered by animals and wind, thus increasing the work of street cleansing.

Kerbside collection is never entirely satisfactory. Problems include :

- bins sorted through by scavengers,
- bins stolen,
- traffic accidents caused by bins rolling on the road,
- bins turned over by goats or cattle,
- failure of the householder to retrieve the bin quickly.

The worst example of this last problem is when the bins

are kept permanently on the footway; this is not uncommon in high income residential areas of certain Asian cities.

However, kerbside collection is unavoidable with some types of house construction, and it is the cheapest method of house-to-house collection. When the rate of wastes generation is high and collection infrequent very high labour productivity can be achieved. For example, in one city in USA a one-man crew collects up to 10 tonnes/day—400 dwellings at an average of 25 kg/dwelling. In all developing countries, however, the wage-rate to vehicle-cost ratio would be much less than in USA and it would be profitable to employ a crew of at least four men. Productivity would also be reduced as the weight collected per dwelling would be much less.

This is the system in which the householder does no work: the collector enters the garden or courtyard, carries the bin to the vehicle, empties it, and returns it to its usual place. It is costly in labour because of the high proportion of working time spent walking in and out of premises and from one dwelling to the next, but it is the only really satisfactory system. A USA study showed that this system costs about twice that of kerbside collection, but this ratio would be greatly reduced in countries where labour cost is low.

#### **Door-to-door Collection 9.4.**

The problem with door-to-door collection in developing countries is that vehicle productivity would be very much less than in Europe or USA if collection was at high frequency. High vehicle productivity must be the main aim of developing countries, thus door-to-door collection by the conventional western method of heavy motor vehicle and crew is very unlikely to be a viable system unless the interval between collections was extended to a week. This is unlikely to be acceptable in tropical countries as a principle and in any case the majority of dwellings in most cities need a daily collection (or communal storage).

The broad conclusions that can be reached are as follows:

Communal storage systems based on manually portable containers probably offer the lowest collection cost.

Block collection at two-day intervals appears to offer a low collection cost and avoids all the problems that arise with communal storage or kerbside collection.

Door-to-door collection by a heavy motor vehicle and crew would be by far the most expensive system for a developing country if a daily service is required. It may be at an acceptable cost level in selected areas if a twice weekly service was adopted.

The conventional western approach may have to be ruled out. There are other effective possibilities. One of these is described in the next chapter.

## Comparative Productivity of Basic Systems\*

### 9.5

In the following table performance in terms of tonnes/day and dwelling/day by men and vehicles are compared. Weight generated/dwelling/day is assumed to be 2 kg in every case, equivalent to 333 gms/person/day for a family of six people. This is about the current average for much of South East and Central America (but generation in much of West Asia and North Africa may be twice this)

Collection method	Frequency of coln.	Kg/pickup point	Crew no.	Tonnes/		Dwellings/	
				man/day	veh/day	man/day	veh/day
<b>Communal :</b>							
Enclosures	daily	3,000	5	1.4	7.0	700	3,500
Concrete bins	"	300	5	1.2	6.0	600	3,000
200 l. drums	"	50	2	5.0	10.0	2,500	5,000
<b>Block</b>	<b>2 days</b>	<b>4**</b>	<b>2</b>	<b>3.5</b>	<b>7.0</b>	<b>850</b>	<b>1,700</b>
<b>Kerbside</b>	daily	2	4	0.6	2.4	300	1,200
	4 days	7	4	1.8	7.0	250	1,000
	weekly	14	4	2.8	11.0	200	800
<b>Door-to-door</b>	daily	2	6	0.3	2.0	160	960
	4 days	7	6	1.0	6.0	140	850
	weekly	14	6	1.7	10.0	120	720

The four most productive methods are as follows:

	Tonnes/	
	man/day	vehicle/day
Communal 200-litre drums, daily	5.0	10.0
Block collection every 2 days	3.5	7.0
Kerbside collection every 4 days	1.8	7.0
Communal masonry enclosures, daily	1.4	7.0

Figures for weekly collection have not been included, having little practical significance for most developing countries.

\* some figures are actual, others are writer's estimates.

\*\* per house.

## CHAPTER 10.

### PRIMARY AND SECONDARY COLLECTION

Short-range transfer is a system which divides refuse collection into two phases, primary and secondary collection. Primary collection, from door-to-door, is performed by a small non-motorised vehicle, such as a handcart or animal cart. When full the primary collection vehicle is emptied directly into a large motor vehicle which is employed solely on the high speed transport of full loads. The principles behind this were explained in detail when tractor-trailer systems were discussed in the chapter on vehicles.

**Short-range  
Transfer  
10.1.**

The recommended type of handcart is that with up to six detachable bins described in Chapter 7. Carts of this design were used in Dagenham, England, in the late "forties" for the door-to-door collection of kitchen waste which was separately stored and collected so that it could be processed into food for pigs and poultry. About 10 rounds were operated and the average dwellings visited/man/day was 388. The operation comprised entering the front garden, picking up the kitchen waste bucket, which was normally placed on the front door-step by the housewife, emptying it into one of the bins on the handcart, and returning the bucket. The weight/dwelling/day was less than one kg, however, whereas a daily collection from most households in developing countries would yield about 2 kgs.

**primary  
collection  
by handcart  
10.1.1.**

Handcarts with two and four bins were used during a pilot project in Kathmandu, during which three rounds were operated. Although the two-bin cart had very small capacity, and therefore required frequent trips to the trailer which formed the secondary collection, the average performance of the three collectors was about 250 dwellings/man/day. The wastes were not put out on the footway, but each collector had a handbell which he rang at intervals. Housewives brought their wastes to the front door on hearing the signal, and handed their bin (often an old petrol tin) to the collector who emptied it and handed it back. Many of the streets served were very narrow, some little

more than a metre, thus this was the only kind of door-to-door service possible.

A typical performance calculation for handcart collection would be as follows:

Assume that the handcart carries six bins of 50 litres capacity, the small size being dictated by high density wastes. When full the handcarts would be pushed to trailers of 6 cu m capacity, spaced about one km apart. Thus the collectors operating from each trailer would be within a radius of about 700 metres and their average distance from the trailer would be about 400 metres.

Handcart capacity, 6 bins x 50 litres      300 litres

Therefore, one handcart load

@ density 330 kg/cu m =                      100 kgs

If generation of wastes is 2 kg/dwelling/day,

one handcart load is equivalent to              50 dwellings

Time per load:

collection, 1.5 minutes/dwelling              75 mins

travel, 400 metres x 2 @ 3 k.p.h.              16 "

unload    5 "

delay allowance                                      10 "

Total time/load                                      106 minutes

Working time/shift      420 minutes      =      4 loads/shift

Production per shift                                      200 dwellings

or 400 kgs.

**secondary  
collection  
by tractor-trailer  
10.1.2.**

Assume that trailers have a capacity of 6 cu m and that they are exchanged when full by an agricultural tractor which takes them to the disposal site.

Assume an average round trip to the disposal site of 12 kms at an average speed of 15 k.p.h.

Time travelling per trip                              48 minutes

Exchanging trailers                                      5 "

Unloading    10 "

Total trip time    63 minutes

If 7 minutes/trip is allowed for delay, then average trip time would be 70 minutes, equivalent to 6 trips/day in a working day of 7 hours.

If the average trailer load is 2.4 tonnes (equivalent to a loaded density of 400 kg/cu m), then

Tractor production/shift                                      = 14 tonnes

The number of trailers required depends primarily upon population density. One trailer exchanged 6 times/day could support 36 collectors serving a population of 43,000,

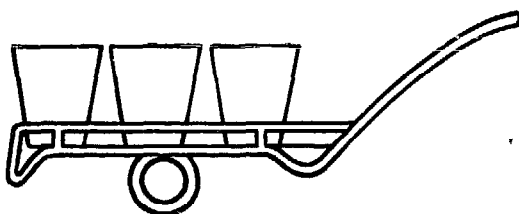
Figure 9

### SHORT-RANGE TRANSFER

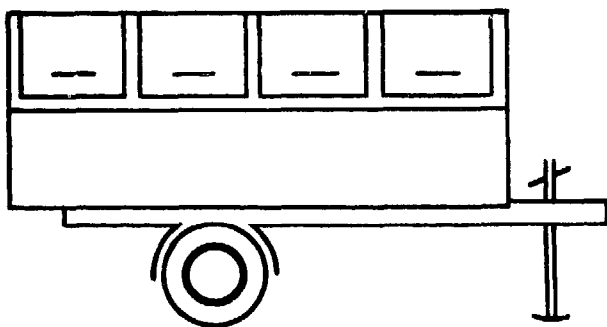
Flow diagram for handcart and trailer system.



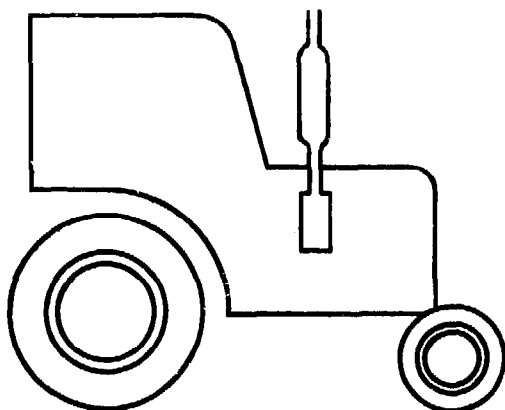
1,200 people live in 200 dwellings. Each dwelling produces 2kg/day of domestic wastes which are stored in a 6-litre bucket. Initial density is assumed to be 330 kg/cu metre but density tends to increase at each stage of collection due to natural compaction in the container or vehicle.



One refuse collector with a handcart of 300 litres (6 bins x 50 litres) calls at 200 dwellings/day, collecting a total weight of 400 kg/day.



Bins from the handcarts are emptied into a trailer of 6,000 litres, equivalent to one day's wastes from 6 handcarts. One trailer load of 2.4 tonnes serves 1,200 dwellings and 7,200 people.



Full trailers are towed to the disposal site by an agricultural tractor. One tractor can exchange up to six trailers/day under average conditions, 14 tonnes/day, from 36 collectors, serving 7,200 dwellings and a population of over 43,000.

but because of the limited operating range of a handcart, this 36-man unit must be contained within an area of one square kilometre. Thus, in this example, if the population density is less than 43,000/sq km, more than one trailer transfer point will be required. Two transfer points, each having a trailer exchanged 3 times/day would enable the tractor and 36 collectors to cover an area of 2 sq kms with a population density of 21,500/sq km

In the first instance the theoretical trailer requirement would be two per tractor, one stationary at the transfer point, the other being towed. In the second the number would be three per tractor, one at each of the two transfer points and one being towed. In practice it is usually necessary to provide surge capacity at a transfer point, because the rates of handcart collection and trailer exchange are not continuously in balance. Trailer numbers should, therefore be on the following scale:

Optimum population density	3 trailers/tractor, 2 at transfer.
Half optimum population density	5 trailers/tractor, 2 at each transfer point.

The minimum population density for which handcarts could be used is 7,200/sq km, when each sq km would require six collectors and one trailer/transfer point. Surge capacity would not be necessary, thus the ratio of trailers to tractors would be 7 : 1, 6 trailers at transfer points and one being towed.

All these figures are based on the assumed basic data given at the beginning of this chapter and for any specific city corrections must be made in accordance with local data. In general the use of short-range transfer based on handcarts is relevant to the following conditions:

- low per-capita generation of wastes,
- high density wastes,
- high population density,
- low wage rates.

Where one or more of these conditions is absent, the principle of transfer may still be valid, but it may be necessary to employ larger vehicles.

**primary collection by animal cart or motor-tricycle**  
10.1.3.

The following assumptions are made:

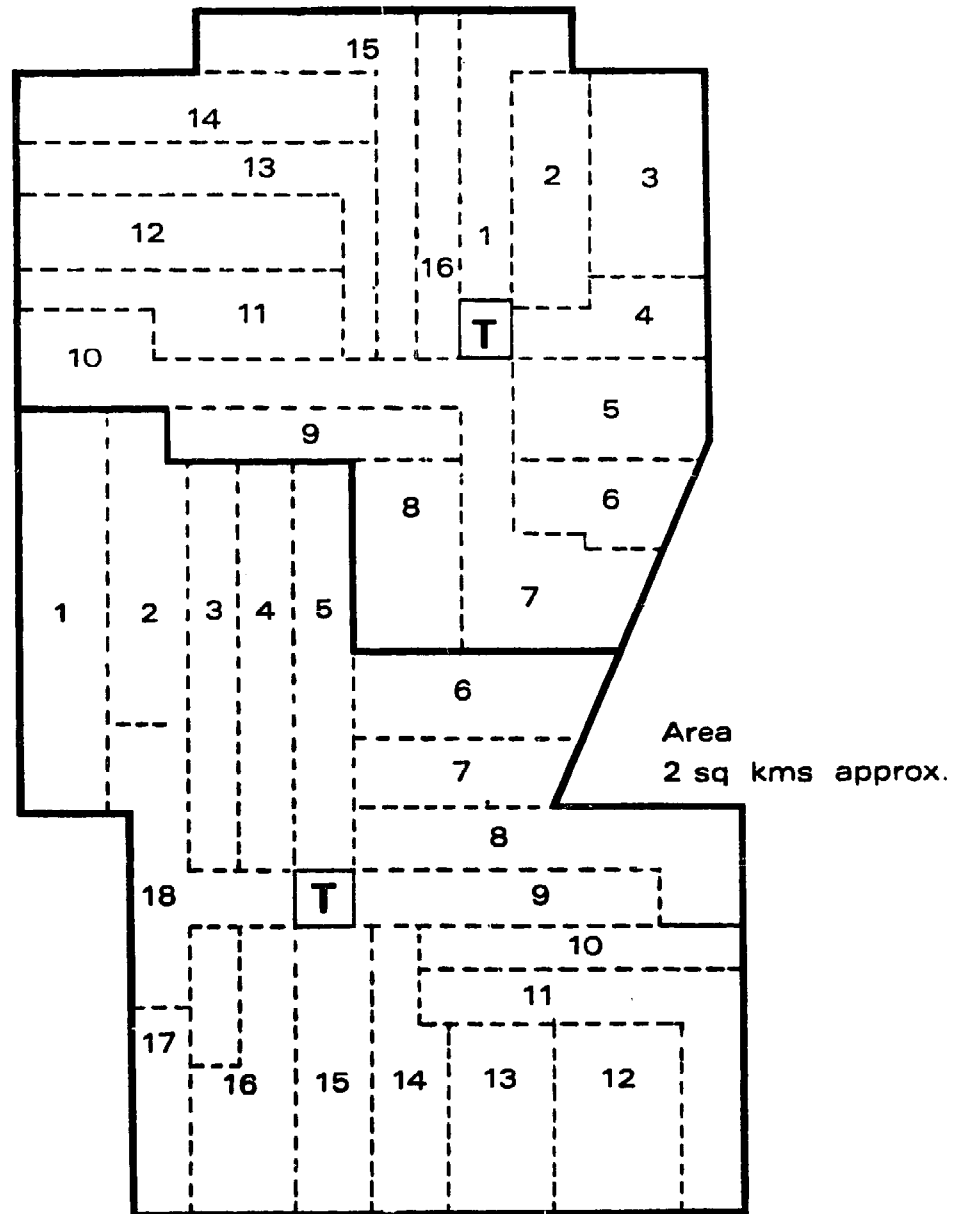
Vehicle capacity	2,000 litres
	or, 700 kg.
one vehicle load =	350 dwellings
Time per load:	
2 crew x 40 dwellings/man/hour	4 hours 22 mins.
Travel 2 kms: animal cart (3 k.p.h.)	40 "
: motor tricycle (20 k.p.h.)	6 "





Figure 10

TYPICAL ROUTE LAYOUT FOR SHORT-RANGE  
TRANSFER DISTRICT



Population 43,000. Dwellings 7,200. Total 14 tonnes/day.

- 1 Tractor. 2 Transfer points each having 2 trailers (3 exchanges/day at each).
- 36 collectors each with handcart. Each transfer point serves 18 collectors.
- Collection routes are arranged, as far as possible, radial to transfer points, shown as T.

the criterion in countries with low wage levels, the revised table is as follows :

	<i>Tonnes</i>	
	<i>Man/day</i>	<i>Vehicle/day</i>
Short-range transfer :		
motor-tricycles *	0.53	25
animal carts *	0.44	25
handcarts *	0.40	14
Communal 200 litre drums	5.0	10
Block collection	3.5	7
Kerbside collection	1.8	7
Communal masonry enclosures	1.4	7

It is necessary to warn that, although the figures used for illustration in this and the preceding chapter are based on actual experience, the reader is unlikely to find them valid for his city because of the very wide variations which occur throughout the world in the determining factors.

The most important factors are :

- wastes generation/capita x average family size,
- density of wastes at source,
- population density,
- wage rates,
- comparative costs of animal carts and motor vehicles,
- motor fuel cost,
- cost of land for transfer stations.

Short-range transfer stations fall into two main categories :

- level sites, where transfer is usually effected by manually emptying small containers;
- split-level sites, where small vehicles are unloaded directly into large vehicles by gravity.

Vehicles used for secondary collection at transfer stations fall into the following main groups :

- trailers, usually about 4 cu m, towed by an agricultural tractor, but smaller trailers towed by jeeps may also be used;
- semi trailers of 15 cu m capacity upward;
- rigid open-top vehicles with extended sides to provide capacities from 12 cu m upward;
- skips of 8 cu m upward, carried by rigid vehicles of 5 tonnes capacity or more;
- roll-on containers of 15 cu m upward, carried by winch-on vehicles.

\* The provision and operating costs of primary collection vehicles represent additional costs over and above the costs of the systems with which short-range transfer is being compared. The addition is negligible for handcarts, small for animal carts, but substantial for motor tricycles. In some cases this additional cost would offset any advantage arising from the higher productivity of the heavy motor vehicles used for secondary collection.

## **Short-range Transfer Stations 10.2.**

Where the wastes are of low density, skips, roll-on containers and semi-trailers can be fed by means of a static-packer which compresses the wastes inside the body.

**level sites** In its simplest form, this type of transfer station may  
**10.2.1.** be no more than a parking space on which a trailer or skip is located, but it is most desirable to enclose such a space for reasons of tidiness and security.

Site layout could follow the pattern suggested for markets and illustrated in Chapter 8. If space is very limited, the layout illustrated here satisfies the essential requirements, but it suffers two disadvantages:

- a trailer would have to be reversed into position,
- exchange involves four operations compared with two when a spare space is available.

When handcarts are used for primary collection—or motor-tricycles the bodies of which can be tipped at a discharge height of a metre or more—static packers can be used at level sites. They are considered later in this chapter.

**split-level sites** Whenever the direct discharge from the body of one  
**10.2.2.** vehicle into another is necessary, a two-level site must be created unless plant is installed in the form of a below-ground hopper which feeds an elevating conveyor.

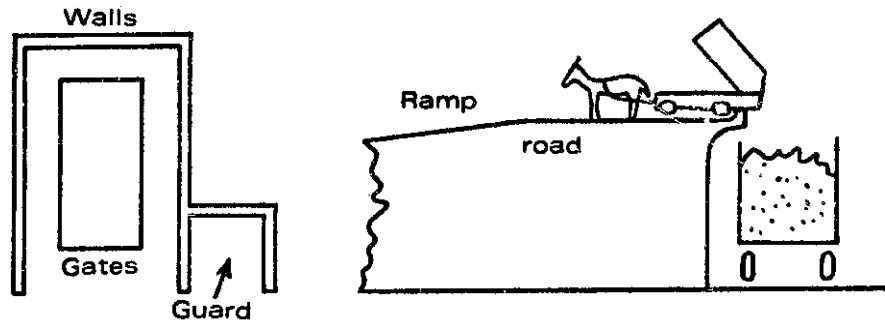
The traditional form of a split-level transfer station is a loading quay (about 3 metres above ground level) which is reached by an inclined road having a gradient suitable for the smaller vehicles: 1:12 is usually acceptable and this requires an approach road about 40 metres long. If one-way traffic movement is desired, two ramp roads must be provided.

**static packers** Large static packers are widely used in the industrialised countries at long-range transfer stations designed to  
**10.2.3.** receive loads from compactor vehicles of about 5 tonnes for transfer to vehicles with carrying capacities up to 18 tonnes, for transport to disposal sites which may be as far away as 80 kms. In order to achieve loads of this weight the wastes must be compressed and the system employed is to discharge the incoming wastes into a hopper at lower level from which they are fed into the receiving vehicle by a hydraulically operated pressure plate. These are usually two-level sites.

Small static packers which operate on a level site are commonly used at factories to fill containers of 8 cu m upward with low-density industrial wastes, and these can readily be adapted to short-range transfer stations when

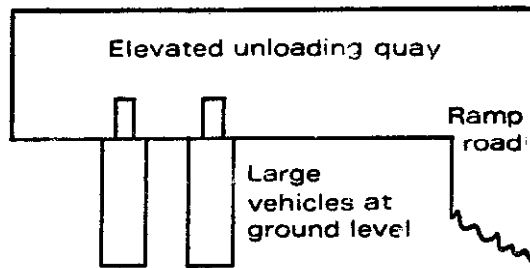
Figure 11

TRANSFER STATIONS

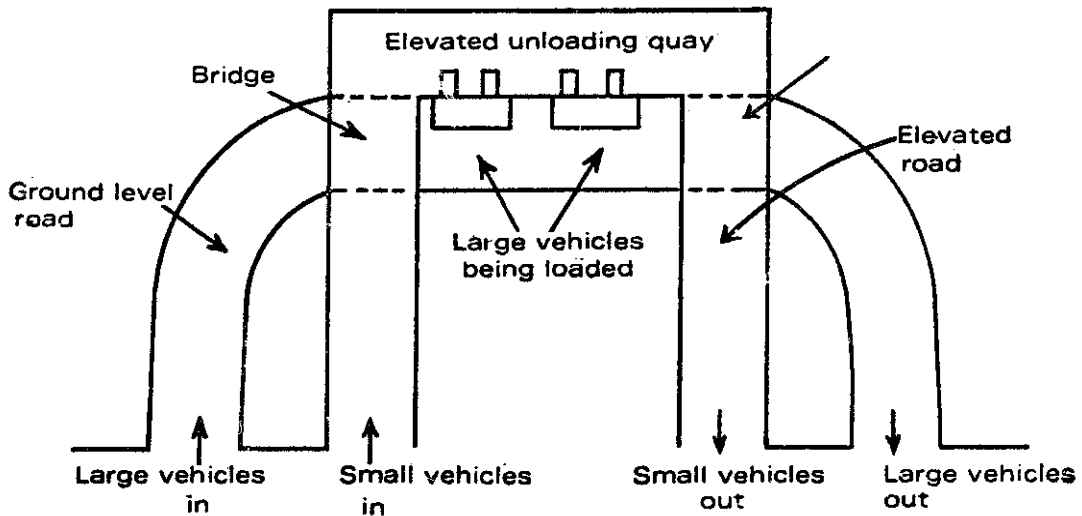


1. Simplest form of trailer or skip housing on level site

2. Two-level transfer by gravity



3. Plan of simple two-level transfer station



4. Plan of large two-level transfer station

their cost can be justified. This is most likely to be in the wealthier developing countries where packaging materials form a significant element of domestic wastes so that the densities of these wastes often approximate to those of Europe or USA. Static packers have been proposed for a series of transfer stations, which will be served partly by handcarts and partly by small motor vehicles, in a system devised by consultants for Riyadh, Saudi Arabia.

The potential throughput of a static packer is very high. One serving a container of 15 cu m volume, and achieving a compaction ratio of 2:1, where the containers are exchanged five times/day, has a theoretical throughput of 150 cu m/day, equivalent to 30 tonnes at a density of 200 kg/cu m. Such high capacity can be extremely valuable in a densely populated area, or one where there is a very high production of wastes from markets, by reducing the number of transfer stations required, because it is in just such areas that sites for transfer stations are most difficult to find.

**combined  
transfer stations  
and district  
depots  
10.2.4.**

Where a transfer station serves a population in the range 20,000 to 50,000, there are many advantages in building a combined transfer station and depot.

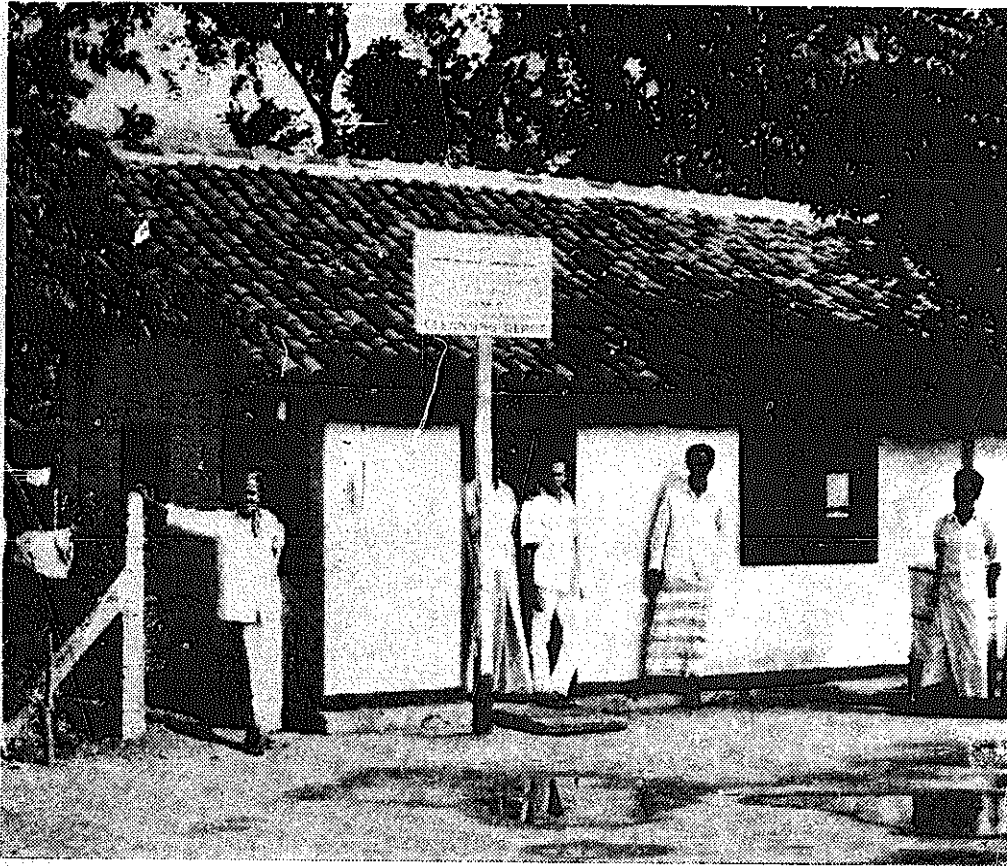
For a population in this range there would probably be between 40 and 150 manual workers employed on refuse collection, street cleansing, and ancilliary services. This represents a work unit of convenient size for the most junior level of qualified management, the district inspector.

A district depot should provide the following facilities:

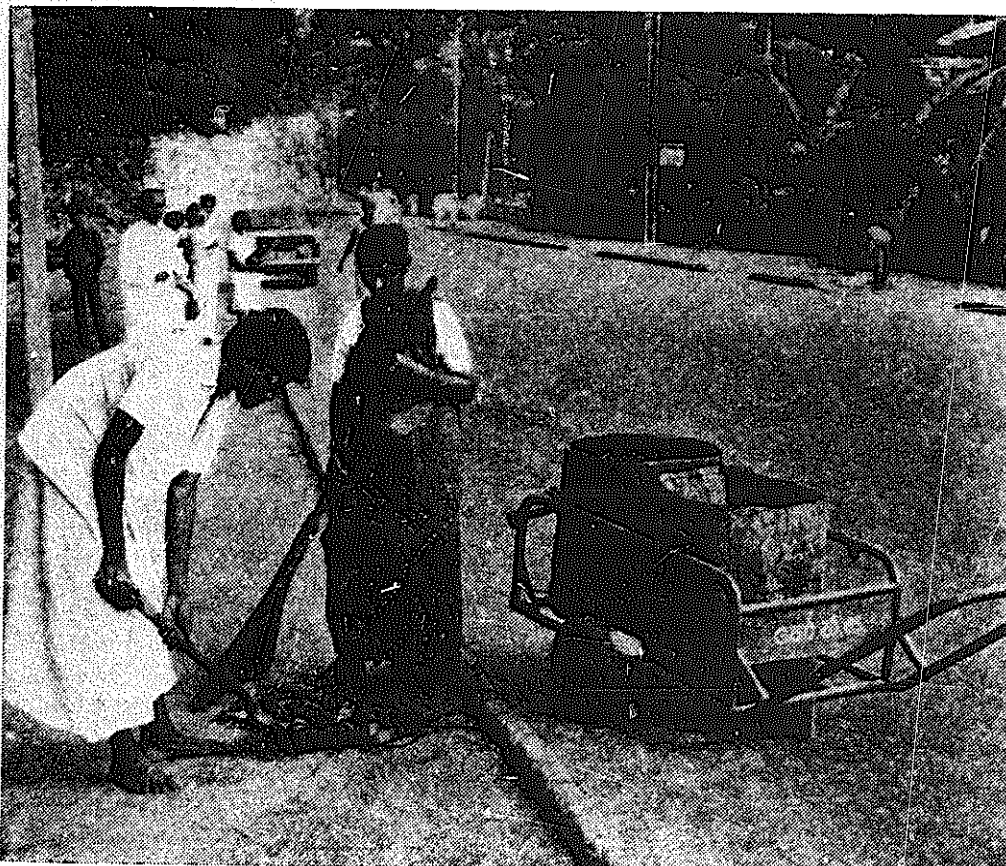
- welfare facilities for workers: lockers, toilets, showers,
- small stores: brooms, shovels, cleaning materials, lubricants etc.,
- parking facilities for hand trucks for sweepers, and if appropriate, refuse collectors.
- office and telephone for the district inspector.

A good basic design for a combined district depot/transfer station would be:

Ground floor	transfer and parking facilities.
First floor	office and stores.
Second floor	locker room, toilets, showers.



13. A small district depot in Colombo which provides a parking area for handcarts and a transfer facility for sweepings in a yard at the rear of the building.



14. An efficient locally-made handcart. Each container is made from half a 200-litre oil drum. After rolling the cut edges the final volume of each bin is about 80 litres. (Colombo)

## CHAPTER 11. ECONOMICS OF REFUSE COLLECTION

### **Crew Collection**

#### **11.1.**

Crews numbering two to eight are used for collection from communal storage sites, for kerbside and for door-to-door collection. In this chapter the factors that determine optimum crew size are considered.

In the case of collection from masonry enclosures each containing from half a tonne to five tonnes of wastes at ground level, which are transferred to the vehicle by rakes and baskets, the limit on crew size is imposed only by the number of men who can simultaneously empty a basket into the vehicle. Within that limit every additional increment of labour adds an equal amount of productivity. It is customary to employ about 6 men in these teams, but situations have often been observed in which up to 12 men could be effectively employed with one vehicle: 4 men filling baskets and 8 men carrying baskets to and from the vehicle. But such sites are usually several hundred metres apart, and it is necessary to transport the collectors between sites; in practice, therefore, space on the vehicle for transport of the crew could be the main constraint on crew size.

Where cylindrical concrete bins are fixed to the footway the number of men who can work simultaneously transferring wastes from the bins to baskets is limited by the small diameter of the bin. Usually only one or two men can work at the same time, thus the largest number that can be effectively employed lies between three and six, according to the relative work content of basket filling and basket carrying.

If 200 litre drums are placed at intervals on the footway or verge, singly, the maximum useful crew size is two men, unless the vehicle is an open one of excessive height, in which case one or two men may be required in the body of the vehicle, to assist with emptying.

In the case of block collection it is never necessary to employ more than two men as their only task is to stand at the rear of the vehicle and empty bins handed to them by residents.

In all these cases there is an obvious crew size dictated by the nature of the task or there is a constraint on crew size imposed by an external factor, such as transport facilities for the crew.

For these two systems the choice of the most economical crew size is more complex. For door-to-door collection in a suburban area of single dwellings, the work elements for a two-man crew, where both sides of the road are being worked simultaneously, are as follows:

**door-to-door  
and kerbside  
collection  
11.1.1.**

- 1st — walk into garden and pick up bin,
- 2nd — carry full bin to vehicle and empty it,
- 3rd — walk into garden to return empty bin to normal position,
- 4th — walk to footway,
- 5th — walk to the next house on the same side of the road.

For a four-man crew, with two men on each side of the road, the time required for the 5th work element is doubled as both men must walk the frontage distance of two houses, instead of one. For an eight-man crew the 5th element increases to four frontages.

A second factor is that the greater the crew size the longer the distance over which the crew is spread at any one time; but the vehicle can be in only one place. Thus the larger the crew the more time will be spent waiting with a bin for the vehicle to come within reasonable distance, or walking towards the vehicle.

When collection is from one side only, which is necessary when traffic is heavy or the street very wide, every labour increment above a single collector causes an increase in work content, a decline in productivity per labour unit, and a rise in labour cost/bin emptied. For two-side working, this applies to every pair of men above two.

In the case of kerbside collection, the frontage walked forms a much greater proportion of total work content, thus incremental decline in labour productivity is more rapid than in the case of door-to-door collection.

Vehicle productivity, however, follows the reverse pattern: the greater the crew size the larger the number of bins emptied/hour and the heavier the weight of wastes collected/hour.

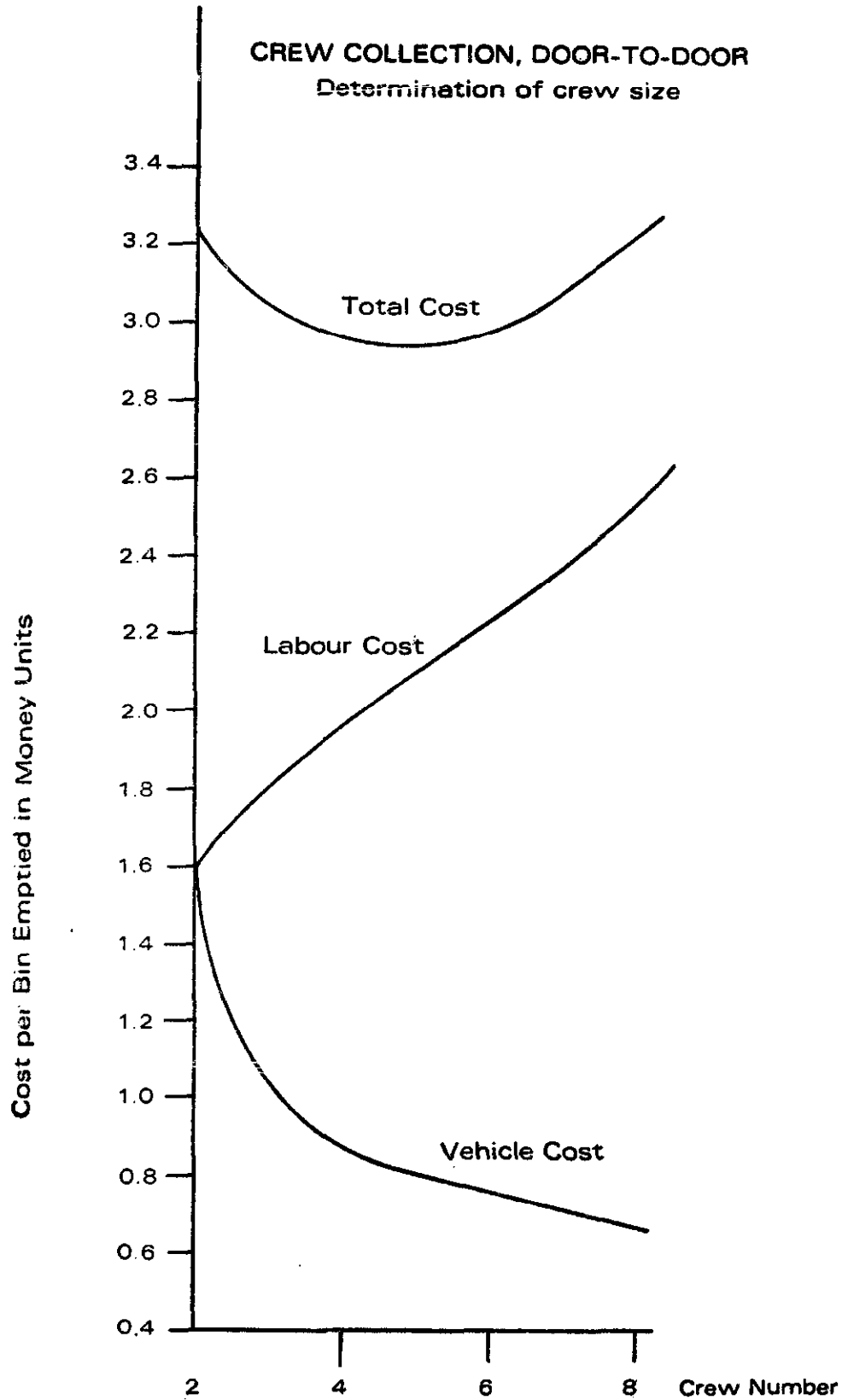
Thus for every situation there is an optimum crew size which achieves the lowest total cost of labour and vehicle. The factors that determine this are primarily:

- physical layout of the area; distances to be walked for the various elements,
- the system used, door-to-door or kerbside,
- the relative hourly costs of labour and vehicles.

In most cities it is possible to define several different

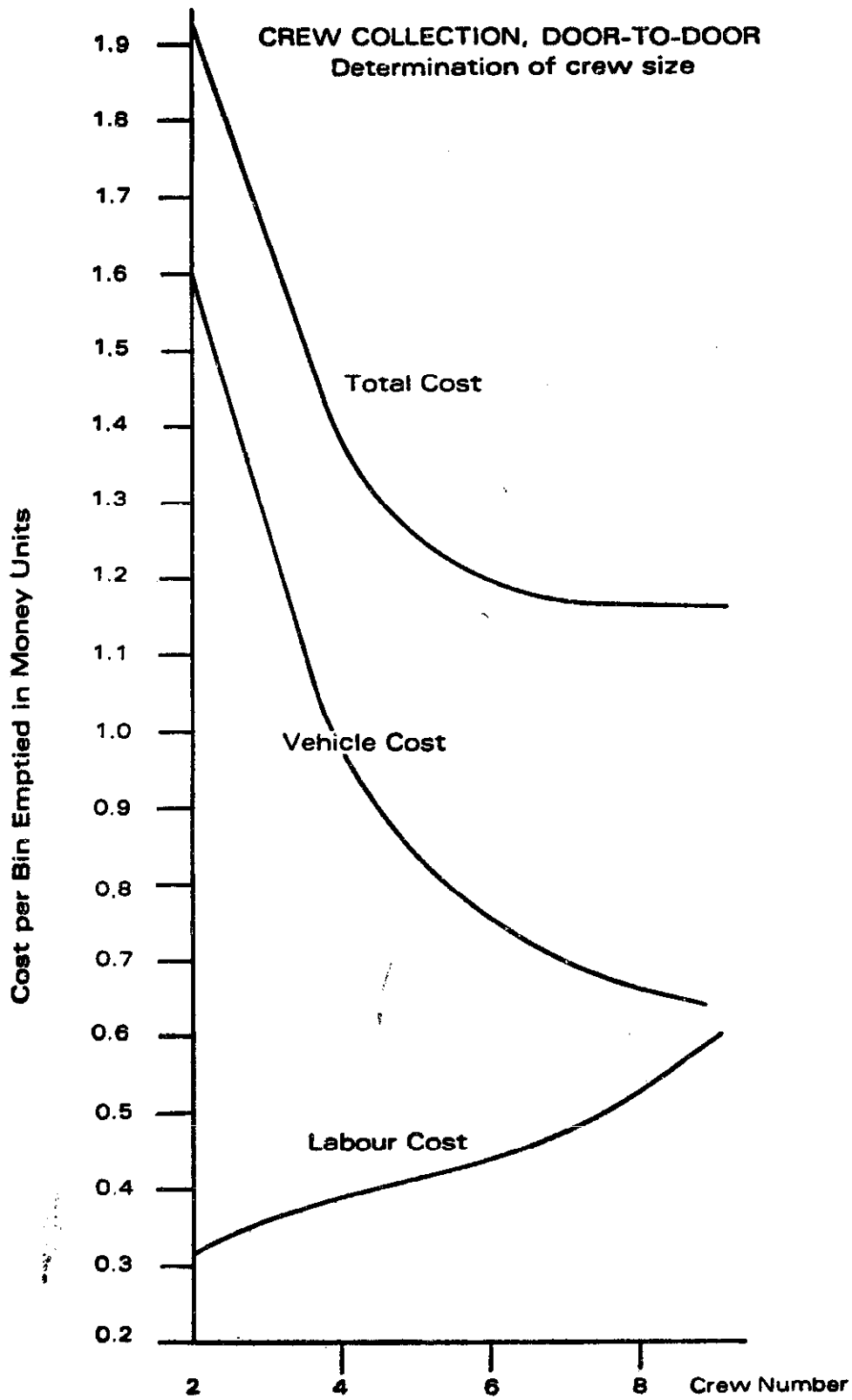


Figure 12



For a high ratio of wage rate to vehicle cost, 1:2, a small team achieves the lowest cost.

Figure 13



For a low ratio of wage rate to vehicle cost, 1:10, the largest team achieves the lowest cost.

types of area, the physical construction of which vary sufficiently to demand different crew sizes. Relative vehicle and labour costs are usually constant for a city, but may vary within a country, and worldwide they vary enormously. For these reasons it is necessary to carry out time studies in every city in order to determine optimum crew size for typical areas.

The piece of route selected for test purposes should be long enough to provide work for between one and two hours and during each test the crew should be accompanied by a supervisor who will record the total number of bins emptied and the elapsed time between the starting and finishing points. For single side working, crews of 1, 2, 3 and 4 should be used on successive occasions, and for double side working crews of 2, 4, 6 and 8. Each test is repeated at least four times, varying the members of the crew to balance out personal characteristics.

The result of a test of this kind which was carried out by the writer in an area of detached houses, standing in gardens, and receiving a full door-to-door service was as follows :

<i>Crew number</i>	<i>Bins/man/hour</i>	<i>Bins/crew/hour</i>
2	30	60
4	25	100
6	22	132
8	19	152

This clearly shows the decline in labour productivity which occurs with each additional labour increment; that decline is, however, accompanied by rising vehicle productivity which is proportionate to the number of bins emptied/team/hour. (It should be noted that for all crew sizes the labour productivity in this example is very low, because the area selected for test represents the worst conditions: long frontages, and long walks within private gardens.)

To determine optimum crew size from this kind of test it is next necessary to apply unit cost for labour and the vehicle. To demonstrate this, imaginary currency called "money units" has been used, and the performances above have been applied to two tables in order to illustrate the importance of labour: vehicle cost ratios.

The first table is for low wage rates; the hourly wage is 10 money units, the hourly vehicle cost is 100 money units. This would be fairly typical for much of Asia. The second table is for high wage rates; the hourly wage is 50 money units and the vehicle cost is again 100 money units/hour.

Low wage rate: 1 man/hour = 10% of 1 vehicle/hour

Crew no.	Bins man/hr	Labour cost per bin	Bins/vehicle hour	Vehicle cost per bin	Total cost per bin
2	30	0.33	60	1.60	1.93
4	25	0.40	100	1.00	1.40
6	22	0.45	132	0.75	1.20
8	19	0.53	152	0.66	1.19

High wage rate: 1 man/hour = 50% of 1 vehicle hour

2	30	1.66	60	1.60	3.26
4	25	2.00	100	1.00	3.00
6	22	2.27	132	0.75	3.02
8	19	2.63	152	0.66	3.29

The ultimate effect of a high ratio of wage cost to vehicle cost occurs in USA where one man-day may cost 140% of one vehicle-day, the consequence being that in some cities optimum crew size with a 15 cu m compactor vehicle is a single driver-collector.

The use of more than one vehicle per collection crew may be economical when the period of absence of the vehicle from the collection round, while it is delivering a full load to the disposal site, is lengthy. This can occur if the vehicle is very slow, as in the case of an animal cart, or when the disposal site is at considerable distance.

**operation  
of collection  
vehicles  
in relay  
11.1.2.**

When the time required to deliver a load to disposal and return to the working area is approximately equal to the time required to load a vehicle, then a 2:1 relay, i.e. two vehicles to one crew, enables the crew to be continuously employed throughout the working day, whereas with only one vehicle they would be employed for only half their time. A 2:1 relay requires staggered starting times for the drivers of the vehicles.

When transport time is approximately half of the time required to collect a full load, a 3:2 relay, three vehicles serving two crews, can be used. In this case it is necessary to stagger the starting times of the crews, unless half loads at the beginning and end of the day are acceptable.

Relay working achieves maximum labour productivity but some of this advantage is lost by a reduction in output towards the end of the day as a result of fatigue. Crews working with a single vehicle benefit by rest periods between loads and this is reflected in a higher average rate of working during the smaller number of hours during which they are effectively employed.

One advantage of relay systems is that in the event of a sudden breakdown of one vehicle work can proceed using

a single vehicle and by working overtime the day's task can be completed; it helps, therefore, in maintaining reliability of the service.

However, because a relay must be operated to a precise timetable if it is to achieve its aim of continuous employment for the collectors, it requires high standards of supervision and of discipline.

**Vehicle  
Operating Costs  
11.2.**

The following cost estimates are derived from actual operating cost supplied by several Indian cities and updated where necessary. The fuel costs used are: diesel Rs. 1.16/litre, petrol, Rs. 3.50 (1975)

*5 tonne diesel truck, 6 cu m, 60 kms/day*

Capital cost Rs. 140,000, 10 year life : Rs. annual

Depreciation annual	Rs. 14,000	
Interest 10% reducing loan	7,000	
Amortisation		21,000
Fuel and lubrication		9,500
Repairs and maintenance		14,000
Tyres etc		4,000
Wages		5,300
<b>Total annual cost</b>		<b>53,800</b>

Daily cost, 310 days/year\* 174

*10 tonnes diesel truck, 10 cu m, 150 kms/day*

(used for secondary collection from a transfer station)

Capital cost Rs. 160,000, 10 year life :

Depreciation annual	Rs. 16,000	
Interest, 10% reducing loan	8,000	
Amortisation		24,000
Fuel and lubrication		20,000
Repairs and maintenance		20,000
Tyres etc		7,000
Wages		6,000
<b>Total annual cost</b>		<b>77,000</b>

Daily cost, 310 days/year 248

(Equivalent to Rs. 10/tonne for 5 loads/day x 5 tonnes)

*Diesel tractor/trailers, 6 cu m, 150 kms/day*

(used for secondary collection from a transfer station)

Capital cost tractor Rs. 60,000, trailers (5) Rs. 100,000.

Depreciation annual	Rs. 16,000	
Interest 10% reducing loan	8,000	
Amortisation		Rs. annual 24,000
Repairs and maintenance		12,000
Fuel and lubrication		18,000

\*NEERI suggest that 300 days/year is more commonly used in India for costing purposes.

Tyres etc.,	5,000
Wages	5,300
Total annual cost	64,000
Daily cost, 310 days/year	206
(Equivalent to Rs. 14/tonne for 6 loads x 2½ tonnes/day)	
<i>Bullock cart, 3 cu m, 1 tonne</i>	
Capital cost cart Rs. 20,000, 10 year life.	
Amortisation	3,000
Repairs and maintenance	500
Tyres	1,000
Hire of bullock @ Rs. 20/day	6,200
Wages	3,000
Total annual cost	13,700
Daily cost, 310 days/year	45
<i>Handcart, 300 litres, 150 kgm.</i>	
Capital cost Rs. 800, 10 year life.	
Amortisation	120
Repairs, maintenance, tyres	300
Total annual cost	400
Daily cost, 310 days/year	1.35

#### TRANSFER COST

Capital cost transfer depot Rs. 150,000, amortised 20 years,	15,000
2 attendants	6,000
Electricity and water	4,000
	25,000

For a throughput of 20 tonnes/day, cost/tonne would be Rs. 4.

The attempt is made here to compare cost/tonne for various systems employing some of the vehicles above. Because of variations in wage rates and in performance levels arising from city structure these estimates can serve only to indicate probable differences in the scale of cost for the various collection methods. Calculations are based on a generation rate of 2 kgs/dwelling/day, crew wage rates of Rs. 10/day, the vehicle operating costs of the preceding section, and the performances that appear in Chapter 9.5.

#### Comparative Costs of Alternative Systems

11.3.

#### Communal Storage, Daily

<i>Masonry bins.</i>	
7 tonnes/day	Cost/tonne Rs.
5-tonne motor truck, Rs. 174/day	25
Crew, 5	7
Total	32

*200 litre drums.*  
10 tonnes/day

5-tonne motor truck, Rs. 174/day	18
Crew, 2	2
<b>Total</b>	<b>20</b>

**House-to-House Collection, Twice Weekly**

(Practicable only for dwellings with yards or gardens)

*Motor truck, 8 crew.*

(20 dwellings/man/hour x 8 men x 5 hours x 8 kg, say 6 tonnes/day.)

5-tonne motor truck, Rs. 174/day	29
Crew, 8	12
<b>Total</b>	<b>41</b>

*2 Bullock carts in relay*

(20 dwellings/man/hour x 4 men x 6 hours x 8 kg, say 4 tonnes/day.)

	Rs./tonne
2 bullock carts, x Rs. 45 = Rs. 90/day	22
Crew, 4	10
<b>If within 3 kms of disposal site, Total</b>	<b>32</b>

If outside 3 kms radius of disposal site add:

Transfer cost	4
Secondary collection, 10-tonne trucks	10
<b>Total</b>	<b>46</b>

**House-to-House Collection, Daily**

*Handcarts*

Handcart	3
Collector, 0.4 tonnes/man/day	25
Transfer	4
Secondary collection by tractor-trailers	14
<b>Total</b>	<b>46</b>

*Single bullock cart*

(25 dwellings/man/hour x 6 men x 6 hours x 2 kg, say 1.8 tonnes/day)

Bullock cart, Rs. 45/day	25
Crew, 6	33
Transfer	4
Secondary collection by 10-tonne truck	10
<b>Total</b>	<b>72</b>

*Motor truck*

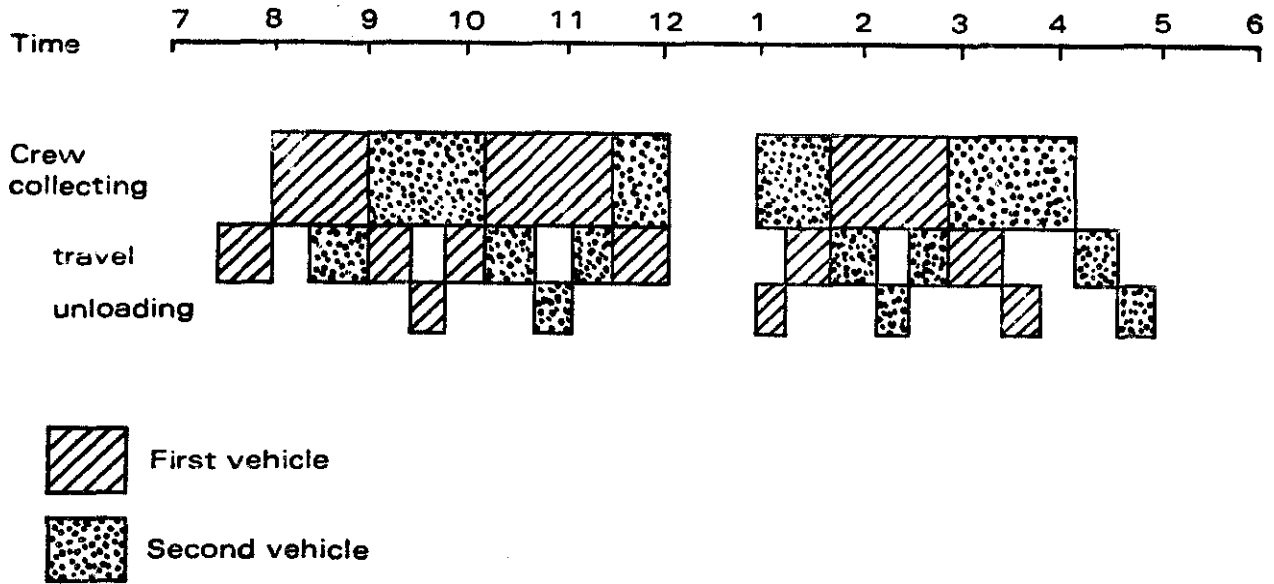
(25 dwellings/man/hour x 8 men x 6 hours x 2 kg, say 2.4 tonnes/day)

5-tonne motor truck, Rs. 174/day	73
Crew, 8	33
<b>Total</b>	<b>106</b>

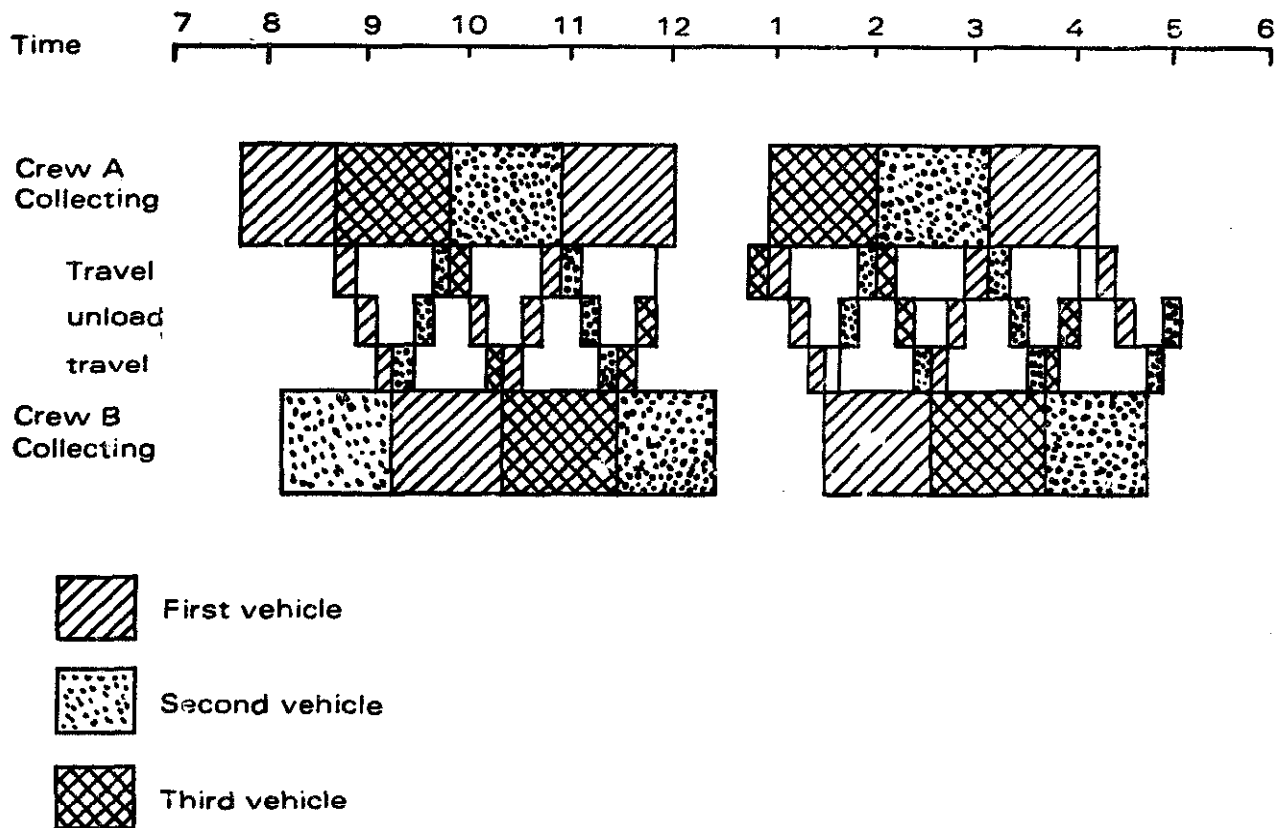
Figure 14

RELAY SYSTEMS

2:1 RELAY TIMETABLE



3:2 RELAY TIMETABLE





## CHAPTER 12. STREET CLEANSING.

The sweeping of streets is such a simple and humble occupation that it rarely attracts technical interest. However, many cities spend between a third and a half of their solid wastes budgets on street cleansing. It is a service for which a wide variety of tools, equipment and methods, both manual and mechanical, are available, and it is one in which there is often great scope for financial saving by the introduction of more efficient methods.

This is an area in which public relations are very important. Much of the work arises directly from shortcomings in public behaviour, such as throwing litter in the street. In some cities, however, a high proportion of street wastes arises from deficiencies in the refuse collection service as a result of which residents dispose of domestic and shop wastes in the streets. The cost of removing wastes which have been scattered in the streets is very much higher than the cost of collecting similar wastes which have been placed in containers such as domestic wastes bins or litter containers.

Thus street cleansing policies should have the following objectives :

- the provision of services for the collection of wastes from source, i.e. efficient refuse collection,
- reduction of street litter by public education,
- the use of systems which achieve high labour productivity,
- the design and use of effective tools and equipment.

**Sources** For purposes of solid wastes management all street wastes fall into three main categories:

**12.1. natural wastes** These include dust blown from unpaved areas, sometimes from within the city and sometimes from a great distance, and decaying vegetation such as fallen leaves, blossoms and seeds which originate from trees and plants in the city. Natural wastes cannot be avoided, but may be controlled by such measures as the careful selection of the types of tree planted in the city.

**12.1.1.**

Motor vehicles deposit oil, rubber and mud; in addition, there is sometimes accidental spillage of a vehicle's load. Animals drawing vehicles deposit excrement on the road surface. At large construction sites mud is often carried out by motor vehicles and deposited on adjacent roads; in wet weather this can cause danger to other traffic by skidding.

**road traffic  
wastes  
12.1.2.**

Traffic wastes are largely unavoidable but some legislative control is possible in the cases of load spillage and construction sites.

The main source of wastes is litter thrown down by pedestrians and house or shop wastes swept or thrown out of private premises instead of being placed in the correct container. Human spittle and the excrement of domestic pets also fall into this category and together provide the main health risk which arises from street wastes: the inhalation of dust contaminated by dried spittle and excrement.

**behavioural  
wastes  
12.1.3.**

Behavioural wastes are largely avoidable provided that an efficient refuse collection service is in operation and that litter bins are provided for the use of pedestrians, but success requires a continuing programme of public education backed up by legislation and rapidly operating enforcement procedures.

A street normally comprises three distinct paved surfaces: a highway for motor traffic, and a footway on both sides for pedestrians. The footways are slightly elevated and are separated from the highway by a kerb and channel. The channel is the lowest part of the road structure and serves as a drainage channel during rainfall; at regular intervals it is provided with outlets for this surface water to the main drainage system.

**Manual Street Cleansing  
12.2.**

It is rarely necessary to sweep the surface of the highway because motor traffic creates a turbulence which carries dust and litter away from the crown of the road and concentrates it in the channels at the sides. Thus, street sweeping usually has two components: footways and channels.

Footway wastes are mainly light litter and a little dust; in the channels the proportion of dust and heavy wastes is usually greater. The tasks tend to be different, therefore. Footways are large areas with a low concentration of wastes; channels are narrow strips with a high concentration of wastes which tend to be heavy.

Although these principles apply to most streets of a city, the amount of wastes generated varies in proportion to the level of human activity; thus the necessary frequency

of sweeping can range from several times a day to once or twice weekly.

**equipment**  
**12.2.1.**

(a) *Brooms.* Brooms are of two main types: those formed from a bunch of long fibres, and those which are based on a wooden stock into which are inserted numerous tufts of short filaments. The methods of using these two types of broom are fundamentally different. The bunch broom, which is long and flexible, is swept across the body in long strokes and the fibres exert very little pressure on the ground, a fact that makes it an excellent tool for sweeping litter and leaves from unpaved surfaces where minimum ground friction is desirable. The stock broom is pushed ahead of the sweeper with frequent short strokes to which much of the weight of the body can be applied. Thus, having shorter and stiffer filaments, it is more effective in dislodging adhering matter and in collecting dust, partly because of the probing action of the springy filaments and partly because of the sweeper's weight applied to it.

Bunch brooms are in general use in tropical and sub-tropical countries because they are very cheap to manufacture and use local fibres. They cover the ground fast, but do not remove heavy fine wastes effectively.

For channel sweeping, stock brooms of about 30 cms filled with a natural fibre (Bahia or Calabar base) have been widely used in Europe, but in recent years man-made fibres such as polypropylene have tended to replace natural fibres as they have a longer life. Split cane would be satisfactory and economical in many countries.

For the sweeping of footways and other large paved areas, stock brooms of 40 to 50 cms, filled with soft fibres, are successful in removing both litter and fine dust.

Thus the normal equipment of a sweeper should be a channel broom and a pavement broom. If unpaved areas are included in his beat, he will also require a long-fibre bunch broom for this part of his work.

(b) *Shovels.* The function of the broom is to gather the street wastes into small heaps which then have to be picked up completely and placed in a receptacle. The conventional tool for this purpose is a large straight-blade shovel. However, when the wastes comprise large quantities of very light materials such as leaves a shovel is ineffective because dried leaves fall off or are blown away during transfer. A good solution to this problem is to use a pair of flat boards, usually plywood, between which the wastes are retained by hand-pressure.

(c) *Handcarts*. See section 12.2.3.

In the normal sweeping situation of footway and channel there is an established work method for a single operator which has been designed to minimise unproductive walking:

**sweeping methods  
12.2.2.**

1. Park receptacle (normally a handcart) at commencement of section to be swept.
2. Using wide broom, sweep wastes off footway into channel for a convenient distance, say 20-50 metres.
3. Sweep channel in reverse direction, ending at parked receptacle; make intermediate heaps if quantity so requires; *do not sweep across drainage grids*.
4. Move receptacle up to next section to be swept, picking up heaps on the way.

When sweeping is done by a team of men, the division of labour follows a similar functional pattern:

1. First man (or 2 men) Sweep footway into channel.
2. Second man Sweep channel wastes into heaps.
3. Third man (with vehicle) Pick up heaps.

The preferred system is single operators, each responsible for his own length or beat. The main application of team sweeping is when a task must be completed within a limited time or when quantities of wastes are very great, for example, market areas at the end of the day, or prestige areas at the beginning of the day.

The work of a sweeper falls into two main parts:

- sweeping, and transferring wastes to receptacle,
- transporting full receptacle to a transfer point where it can be emptied.

**vehicles  
and transfer  
facilities  
12.2.3.**

In terms of sweeping, the first activity is productive, the second unproductive because it represents loss of sweeping time. The aim, therefore, should be to reduce to the minimum the proportion of time spent on transport. This can be achieved in two ways:

- minimising the distance over which the collected wastes have to be transported,
- providing the maximum size of receptacle for swept wastes.

The first of these is discussed in 12.2.6. The second is a question which has been seriously neglected in many developing countries. Often sweepers are given baskets for the transport of street wastes, as a result of which they spend most of their day walking to empty the basket instead of sweeping. The best solution is a handcart, the gross weight of which may be as much as 250 kg in level areas, less in hilly districts.

The handcart design should avoid the need to empty the cart on to the ground at the transfer place, because this would create the unnecessary task of shovelling wastes into another vehicle when the time came to deliver them to the disposal site. A good method is to equip the handcart with a number of portable receptacles that can be lifted off and emptied by one man into a transfer facility serving a number of sweepers. The desirable features of a handcart for use by a single sweeper are as follows:

- frame of light tubular steel, or angle, supporting a platform on which are placed two or more portable bins,
- wheels of large diameter, with rubber tyres, preferably pneumatic, ball or roller bearings,
- the portable bins should have a capacity of 50-80 litres each, according to the density of the wastes,
- brackets should be mounted on the frame of the handcart to carry three brooms and a shovel.

When sweepers are employed in teams of three to five men a much larger vehicle capacity is necessary. This can be provided in the form of a horse-drawn cart or a bullock-cart, or a small motor vehicle. It is important that the vehicle following a sweeping team should be in close attendance; heaps of sweepings that have been left for several minutes are likely to have been scattered by the wind or by traffic.

**classification of streets**  
**12.2.4.**

For the effective planning of manual sweeping it is necessary to classify streets, or sections of streets, according to the required frequency of sweeping. The following is a typical method of classification:

<i>Class</i>	<i>Character of street</i>	<i>Frequency of sweeping</i>
A	City centre shopping	5 x daily
B	Market areas	5 x daily
C	City centre main streets	2 x daily
	Suburban shopping streets	2 x daily
D	City centre minor streets	1 x daily
	Suburban main streets	1 x daily
E	Residential streets, low income	3 x weekly
F	Residential, high income	1 x weekly

Each city should determine its own frequency requirements and develop an appropriate classification system. Time studies should then be carried out for each class of street and the results of these will indicate the length of street that a man can sweep at the required frequency. For example time studies may show that for Class A streets one man can be allocated between 250 and 300 metres, while for Class F the length may be as great as 10 kms. In measuring work content, sub-classification may be necessary

to take account of variation in wastes generation within a given class.

On the basis of this information a city can be divided into sweepers' beats which contain fairly uniform workloads, despite great differences in the lengths to be covered.

For the effective management of sweepers, and for the transfer of their collected wastes, depots are required with the following facilities:

- office for the district supervisor, where sweepers book on and off,
- parking area for handcarts,
- tool and equipment store,
- transfer facility for sweepings,
- toilet and welfare facilities.

Each depot should be located, as far as possible, at the centre of a sweeping district, the area of which will be determined by the number of sweepers and the lengths of their beats. In a city centre beats will be short and there may be more than 40 sweepers employed per square km; thus depots may be required on a grid of 1 km. In this case the average walking distance from beat to depot would be less than 500 metres. In a suburban residential area the number of sweepers per square km may be one or even less, thus the depots would be more widely spaced. For example a depot employing 20 sweepers may serve a district with an area of 25 sq km equivalent to a grid of 5 kms. In this case the average walking distance between the depot and a beat could be 2 km, thus the beats should be planned radially, to permit working on an outward and return basis each day.

An essential feature of the organisation for street sweeping is the provision of a transfer facility within reasonable distance of each beat. The ideal arrangement is for this to be located in the district depot where it is under continuous supervision. It can take many different forms, but it must not be a dump on the ground which would be unhygienic and costly in manpower for re-loading. The following are systems in common use, and the capacities are based on 40 sweepers each of whom brings in 500 litres/day, a total for the district of 20 cu m/day:

- a side-loaded trailer of 7 cu m, exchanged three times a day,
- a steel skip of 4 cu m exchanged five times/day by a skip-hoist vehicle.

An alternative to either of these would be an exchange-bin system. The depot would hold a supply of bins similar to those on the handcarts, so that a sweeper could exchange

**organisation of manual sweepers**  
**12.2.5.**

**transfer facility**  
**12.2.6.**

his full bins for empty ones at each visit to the depot. At suitable intervals throughout the day the depot would be visited by a vehicle into which the full bins would be emptied.

The example given earlier of a district with an area of 25 sq km probably represents the maximum area which could be served by the depot. For larger districts it would be necessary to establish sub-depots at which exchange-bins were available for sweepers. It is often possible to arrange for full bins left at sub-depots to be emptied daily by a refuse collection round.

There is an alternative to the provision of transfer facilities for sweepers: this is to arrange for every sweeper to be visited about four times a day by a vehicle into which his full bins are emptied. The system requires very careful routing and the observance of precise timetables by sweepers and vehicles to ensure rendezvous without tedious searches. It has the advantage that the sweeper is able to devote the whole of his time to sweeping, but it does not eliminate the need for the other depot facilities such as welfare and handcart parking.

**Litter Bins**  
**12.3.**

The provision of litter bins is an essential requirement if behavioural wastes are to be controlled. Bins should be of practical design, spaced at standard intervals, and should be emptied frequently.

**design of litter bins**  
**12.3.1.**

Materials should be non-inflammable because cigarette ends are often thrown into litter bins; this rules out certain plastics.

Litter bins should comprise an outer casing of standard colour and lettering, and an inner container which is easily removed by authorised persons for emptying. Size should relate to spacing and frequency of emptying, but the normal maximum should be about 100 litres which represents the upper limit for one man to lift and empty, even when the wastes are of low density. Large litter bins must be pavement mounted; this can be expensive and they also form obstructions. The smaller sizes, from 30-50 litres can be mounted on street lighting columns by means of steel bands and many cities have found this a good and cheap system. The top aperture of a litter bin should be partly shielded to minimise loss of contents in high winds.

**siting and emptying**  
**12.3.2.**

The siting of litter bins could be based on the streets classification referred to in 12.2.4. For example: Class A, 1 bin to each lighting column; Class B, one to every second column; Class C, one to every fourth column. If the bins

were emptied by a sweeper every time he passed, the frequency would be Class A, 5 times daily; Class B, twice daily; Class C, once daily.

It is rarely possible for the larger sizes of litter container to be emptied by a sweeper owing to the limited capacity of a handcart. Such bins could be included on the routes of the refuse collection service unless more frequent emptying was needed, in which case special vehicles would have to be employed.

Most mechanical sweepers are suction machines, usually assisted by one or more revolving "scarifying" brushes for dislodging adhering matter. They range in size from small pedestrian-controlled pavement sweepers to large channel sweepers which often have an auxiliary engine to provide suction. The smallest machines operate at about 3 k.p.h., the largest at 8 k.p.h. or faster. Some of the latter can be fitted with a wander-hose which can be controlled by an attendant and used to pick up refuse from inaccessible places; for example dry leaves from a drainage ditch.

Pavement sweepers are not usually practicable for cleaning normal footways because of obstructions such as lamp-columns, and the presence of pedestrians. Their main application is for very large paved areas such as central reservations and car parks. When they can be deployed effectively, they are very efficient for the removal of fine dust.

Channel sweepers have the same virtue, but they also have serious limitations, in particular:

- no car parking can be allowed on mechanical sweeper routes,
- well-engineered roads are essential, particularly channel and kerb alignment,
- the serviceability of mechanical sweepers is low compared with most other vehicles,
- they are subject to damage by heavy objects lying in the road, or during travel over rough ground at disposal sites.

One function for which channel sweepers are supreme is the cleansing of urban clearways on which the employment of manual sweepers may be dangerous. For this purpose, and also for one-way streets, the machine must be capable of working in either the left or the right-hand channel.

The constraints which apply to mechanical sweepers limit their role to supplementing manual sweeping. The extent to which they are employed should be determined primarily by the comparative costs of mechanical and manual sweeping. By this criterion there can be very few cities in South East Asia where they could be justified. In any

## **Mechanical Sweeping 12.4.**



case they should not be acquired until there are good maintenance facilities for vehicles of this kind and an efficient service is available for the re-filling of worn brush-stocks.

**Legislation** Because of the behavioural origins of a large part of street wastes, legislation can often assist in achieving higher standards of cleanliness, and reducing the total work load. The following kinds of legislation have sometimes been effective:

**12.5.**

*Road vehicles:* penalties can be provided for failure to secure a load, resulting in partial spillage.

*Construction sites:* Contractors should be required to provide facilities for wheel cleaning of vehicles leaving the site, to avoid deposit of mud on adjacent roads.

*Sweeping out:* It can be prohibited to sweep refuse from a house, shop, or other premises on to the public pavement.

*Litter:* Penalties can be provided for dropping litter in a public place.

*Misuse of litter bins:* residents can be prohibited from using litter bins for the deposit of domestic or trade wastes.

**enforcement** To be successful legislation must be broadly acceptable in principle to the majority of the public. To reach this point there are two essential preceding phases:

**12.5.1.**

- the introduction of good systems and efficient services,
- education of the public in the way these services operate and the part the public must play to make them effective.

Only then should law enforcement be used, and because these are mainly minor offences, the procedure should be as rapid and simple as possible. Some cities have found that "on-the-spot" fines are effective in controlling sweeping-out, dropping litter and misuse of litter bins.

## CHAPTER 13.

### TREATMENT AND DISPOSAL

Over 90% of the world's solid wastes are disposed of in landfills. Sanitary landfilling is the main method used in the west: crude dumping is very common in the developing countries.

There is no form of treatment that can entirely avoid the need for land for final deposit. Treatment often enables a proportion of the wastes to be utilised in some way, but there are residues from all forms of treatment and the need for land space is rarely reduced by more than 70%. (See Figure 16). Thus sanitary landfilling is usually necessary, although on a reduced scale, whatever form of treatment may be adopted. The most common forms of treatment are:

- size-reduction of the wastes by shredding or pulverisation, in order to improve the land-filling qualities of the wastes, or as a stage in a composting process;
- composting, a system for controlling the natural decomposition process to produce an organic fertiliser;
- incineration, the primary purpose of which is to render the wastes inert, but which also reduces volume, and may sometimes provide a source of energy.

All these forms of treatment provide opportunities for recycling, because facilities for the extraction of saleable materials can be incorporated in the plants.

The constituents which are commonly extracted from domestic-trade wastes for industrial use are:

#### **Recycling 13.1.**

- paper, for re-pulping;
- textiles for paper-making, machinery wipers, etc.;
- metals for re-smelting;
- glass for re-melting or abrasives manufacture etc.;
- rubber for a downgraded use;
- plastics for the production of an inferior grade.

Extreme poverty may lead to the extraction of some kinds of wastes for personal use:

- cinders, fragments of coal, coconut shells etc., for use as fuel;
- metal cans for use as domestic vessels;
- vegetable wastes for animal feed.

The paradox of re-cycling is that in the wealthy nations, where saleable constituents may comprise 50% of the collected wastes, wages are often too high to permit the recovery, sorting and processing of these materials to be carried out profitably, whereas in the poorer countries the proportion of saleable materials may be negligible. This is partly because of low consumption of paper, metal, glass and plastic, packaging materials, and also because scavengers and refuse-handling workers extract almost everything which is of use before the wastes reach the disposal site.

In most developing countries, therefore, there is very little scope for re-cycling to be embodied as a planned stage of wastes disposal, because of intensive private scavenging. This can be a serious problem at landfill sites, which are often invaded, and sometimes permanently inhabited, by families of scavengers who support themselves in this way.

Planned re-cycling may, however, be profitable in countries where the high value of recovered materials and the low wage cost of recovery and re-cycling compensate for the relatively small proportions present in the wastes. This appears to be the case in India at present. Ways in which re-cycling can be operated in association with sanitary landfilling and composting will be discussed later.

### **Pulverisation 13.2.**

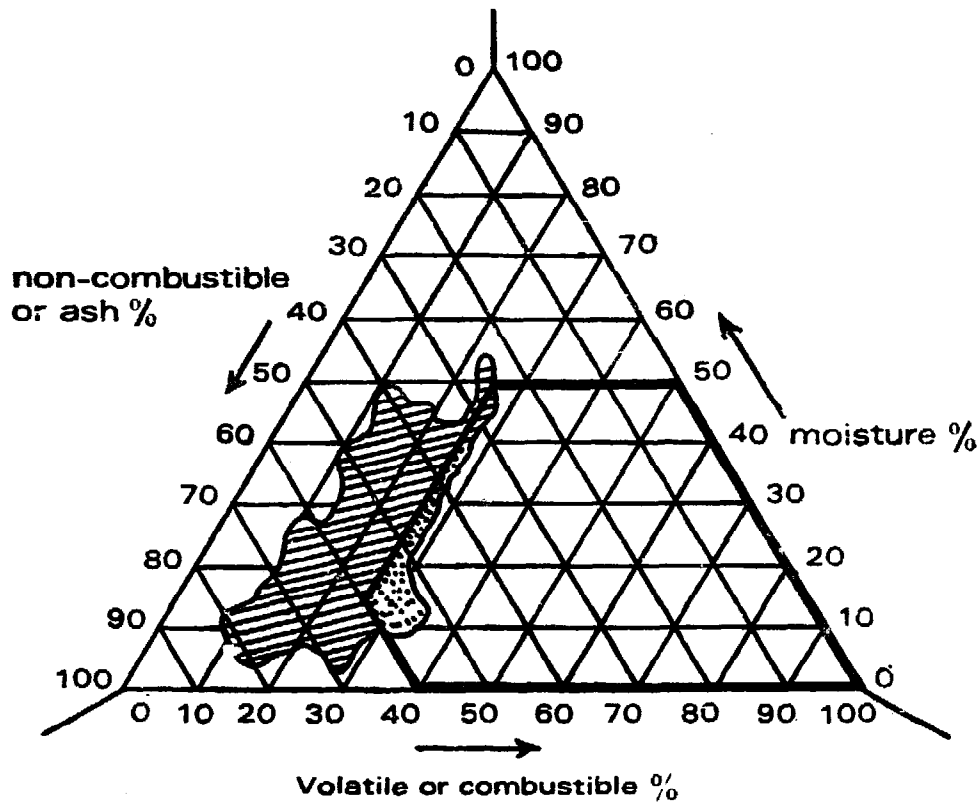
Because the wastes of the industrialised countries contain many bulky and hollow articles, even pieces of furniture, pulverisation is sometimes used as a preliminary treatment before landfilling. By shredding cartons, breaking bottles and crushing cans in a hammermill, a fairly homogeneous mixture of wastes, of reduced particle size, is produced; this occupies less space at the time of deposit and ultimately decomposes to form a consolidated fill without voids, which could cause a protracted period of settlement.

The wastes of most developing countries, however, do not require this form of treatment for landfill purposes: they contain few hollow articles and in some countries up to 80 per cent of the crude wastes, as collected, would pass a 50 mm screen; this is almost as good as the average product of a hammermill in Europe. The most common bulky article in the wastes of the intermediate countries is the fibreboard carton; these can usually be extracted and sold. In tropical countries there may be bulky items of vegetable wastes, but these will ultimately decompose without pre-treatment.

Figure 15

**THREE COMPONENT DIAGRAM ILLUSTRATING THE UNSUITABILITY OF INDIAN WASTES FOR INCINERATION**

(Adapted from "Solid Wastes Management in India", W.H.O., SEA/ Env San/167, 1976; p. 34, Mr. A.D. Bhide, NEERI.)



Zone in which self-sustaining combustion reaction can be obtained



Zone in which values from 33 Indian cities lie



Zone in which values from some Indian cities lie giving self-sustaining combustion reaction

## **Composting**

### **13.3.**

The wastes of S.E. Asian countries are often ideal for conversion into organic fertiliser because of their high vegetable-putrescible content. Economic forces also favour composting in those countries where high food production is of great importance, while fertiliser imports are limited by foreign exchange constraints.

There are five pre-conditions for successful composting:

- suitability of the wastes;
- a market for the product within 25 kms of the city;
- the support of the agricultural authorities, particularly the Ministry of Agriculture;
- a price for the product which is acceptable to most farmers;
- a net disposal cost (plant costs minus income from sales) which can be sustained by the local authority.

When these conditions can be met, a developing country should closely study the possibility of composting because town wastes are a significant potential source of nitrogen, phosphate and potash as well as an organic soil supplement.

## **Incineration**

### **13.4**

Modern incineration plants have the following features:

- automatic feeding of the wastes through a vertical chute which is always full of refuse;
- automatic stoking of the burning wastes by mechanical grates;
- ash discharge into a water-sealed pit.

The furnace is never opened for feeding, stoking or ashing, thus smoke emission is avoided by this total control over combustion air. The gaseous effluent of these plants is usually treated by an electrostatic precipitator in order to extract dust and grit.

The weight of ash is between 25 and 40% that of the incoming wastes and the volume between 10 and 15%. The high density of the ash makes it an economical material to transport and it can sometimes be used for landfilling at sites where crude wastes would be unacceptable; however, it does contain soluble inorganic salts which could cause water pollution.

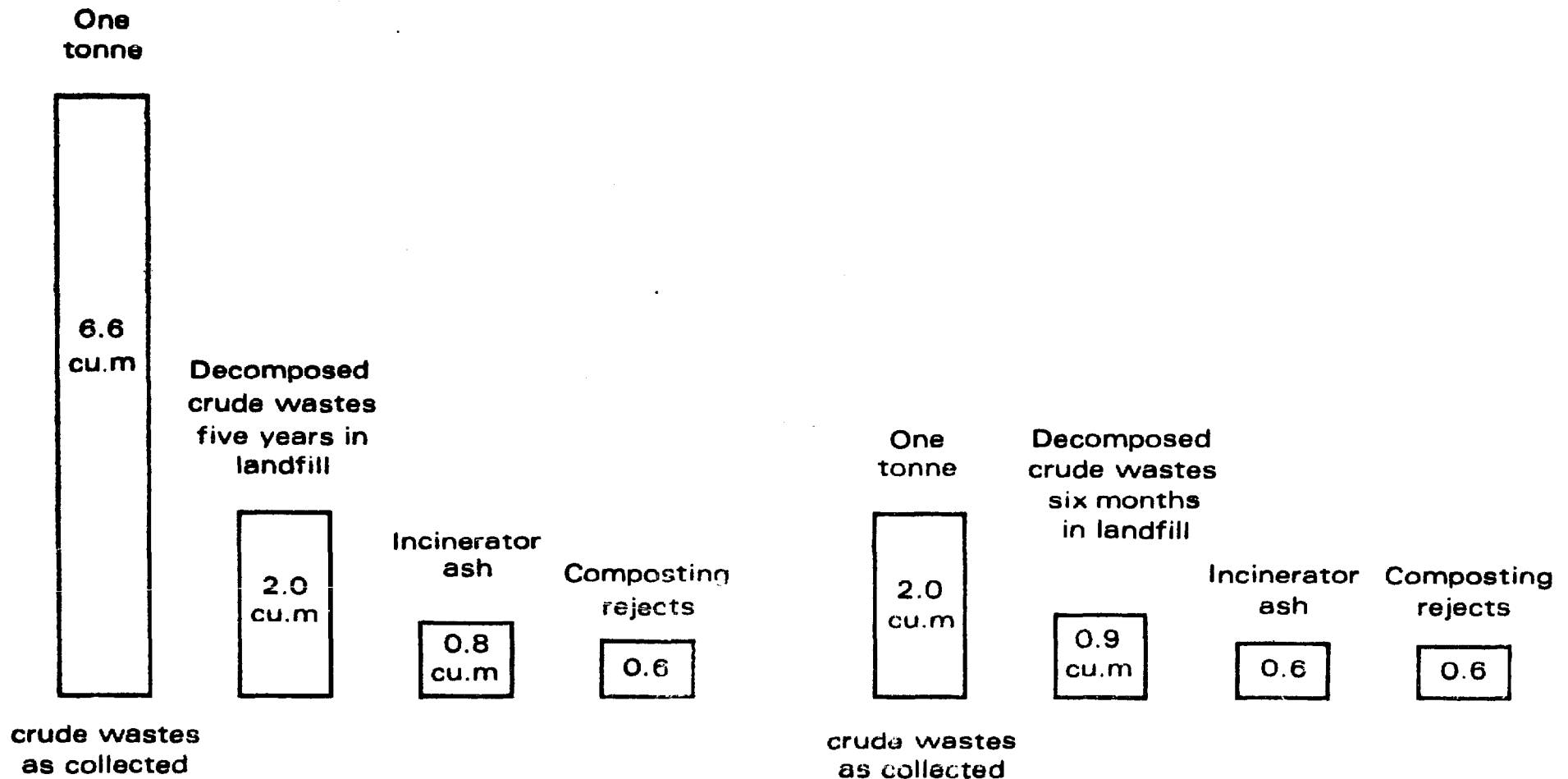
In many European incinerators boilers are installed and the steam is used for the generation of electricity, district heating, sewage pumping, or sold to industry. This is possible because the wastes are of high calorific value, often one-third that of coal, and fairly low moisture content. As an energy source, however, solid wastes are of little significance. It has been calculated that if all British wastes were utilised for this purpose (which is impracticable), total energy production would be less than two per cent of current national consumption. Furthermore, it has rarely been demonstrated that heat recuperation is profitable; in

Figure 16

PROBABLE LAND SPACE REQUIRED FOR SANITARY LANDFILLING OF UNTREATED WASTES COMPARED WITH SPACE REQUIRED FOR RESIDUES OF TREATMENT

LOW DENSITY WASTES  
(high GNP/head)

HIGH DENSITY WASTES  
(low GNP/head)



many cases the value of the steam is offset by a large increase in the capital cost of the plant and in maintenance costs.

For most developing countries incineration can be dismissed firmly as a rational solution to the problems of wastes disposal on the following grounds:

- wastes are too low in calorific value;
- they are probably high in moisture content;
- capital and operating costs are likely to be beyond the means of most cities.

In many countries calorific value is so low that, far from there being any possibility of recovering energy by burning wastes, supplementary fuel may be necessary for at least part of the incineration process. This is demonstrated in the three-component diagram which shows that most Indian wastes are unable to sustain their own combustion.

An argument which is used in Europe to justify the high cost of incineration is that it reduces land space requirements and thus conserves land in the vicinity of the city, thereby deferring the time when the wastes, or the residues of treatment, have to be transported to much more distant landfill sites. It is true that space required for final deposit is reduced by a factor of about three, compared with the decomposed volume of crude wastes in sanitary landfill. However, it is likely that countries having wastes of high density would not benefit to the same extent and that this factor may be two or less. This is shown graphically in the bar chart which tries to compare land space needs for low and high densities and for the main disposal methods.

**Cost** Given satisfactory standards for the protection of health and the environment, cost will always be the criterion of choice of a waste disposal method. It is necessary, therefore, to consider the probable comparative costs of the main systems. There are dangers in suggesting comparative costs except for a specific city because of wide variations in labour cost and other influences such as site conditions, economy of scale, and the standards of buildings used to house treatment plant.

When it is considered that current total expenditure on solid wastes management, including collection of wastes and street cleansing, ranges between Rs. 5 and Rs. 15/person/year in many developing countries, incineration is ruled out simply on the ground that it would more than double annual budget requirements.

Thus the following table cannot pretend to do more than indicate the likely differences in scale of cost as between

one method and another. It is assumed that all transport operations take place within a radius of 8 kms.

Sanitary landfill	1	unit of cost
Pulverisation/landfill	5	"
Incineration	15	"
Composting :		
minimum		
mechanisation	5	" minus income, say 2 net
full mechanisation	10	" " " say 7 net

At the time of writing, the cost unit for much of Asia could be taken to be about Rs. 10. This assumption makes it possible to measure the cost impact of a disposal method in the following way.

At a low rate of wastes generation, 400 gms/person/day, the weight to be disposed of/person/year would be 150 kgs. The comparative costs per person/year are, therefore :

Sanitary landfill	Rs. 1.5
Manual composting	3.0
Incineration	22.5

(a) *Landfill*. Every crude dump is an environmental disaster causing health risks from flies and rats, air pollution from deliberate or accidental burning and water pollution through leaching by rainfall.

At a sanitary landfill vectors are controlled by the operating method. Groundwater pollution is avoided by careful site selection and surface water pollution is avoided by preliminary site engineering. Thus a well-managed site involves no risks of pollution transfer to water or atmosphere. Some short-term environmental degradation may be unavoidable in the form of traffic to and from the site, a scarred landscape caused by earthmoving operations, some visible refuse at most times, wind-borne litter during gales, and the noise of tractors.

If a sanitary landfill site provides restoration of a former surface mineral excavation, or improves a natural feature by creating a park on estuarial mud, then it confers long-term environmental benefits which heavily outweigh the short-term problems.

(b) *Composting*. Composting systems, both manual and mechanised can be designed and operated so as to provide effective control over disease vectors, but it is rarely possible entirely to avoid occasional offensive odours. The solution to this lies in careful site selection. The possible economic importance of composting to certain developing countries has already been stressed. There may also be significant advantages to public health because it is often the

## Environmental Aspects 13.6.



custom for farmers to collect crude wastes and to use them as fertilisers without any proper treatment or control, thus causing risks which would be avoided if the wastes were processed into a hygienic product by the local authority.

(c) *Incineration*. Incineration has no obvious environmental advantages and it sometimes presents environmental problems. A very tall chimney is necessary to ensure that the effluent gases do not descend over the surrounding area; water consumption for gas cooling and clinker quenching may be very high; particle emission can seldom be controlled to better than 99%, and even this is inadequate; large plants generate a very high level of traffic.

## **Conclusions**

### **13.7.**

In terms of both cost and environmental protection, sanitary landfill and composting emerge as the most suitable methods of solid wastes disposal for developing countries. In the case of sanitary landfill, this conclusion is the same as that reached by the great majority of cities in the industrialised countries. Composting, however, has been rejected in most of Europe and USA because of high production cost, due to high wages; high cost of application on the farm, again due to high wages; but primarily because of the ready availability, at acceptable cost, of artificial fertilisers of guaranteed analysis. None of these factors apply at present in many of the developing countries. Thus in most cases both sanitary landfill and composting may be equally worthy of consideration. In succeeding chapters these two disposal methods are described in much greater detail.

## CHAPTER 14.

### SANITARY LANDFILL

Sanitary landfill can be defined very simply as the use of solid wastes for land-reclamation, a typical example being the restoration, by filling to the original level, of man-made surface dereliction such as a disused surface mineral excavation. Solid wastes may also be used to improve natural features by raising the level of low-lying land to enable it to be used for cultivation or industrial development. Described in this way, sanitary landfilling has the virtue of being a method of refuse disposal which confers environmental improvement by restoring dereliction or improving natural contours.

Most solid wastes, however, are very offensive materials which provide an attractive habitat for such disease vectors as flies and rodents, and which pass through a lengthy process of decomposition the products of which can cause serious water pollution. Thus sanitary landfilling has two essential features which differentiate it from crude dumping:

- only sites that will be improved, not degraded, by a change of level, are selected;
- simple engineering techniques are used to control the manner in which the wastes are deposited, so that dangers to public health and the environment are avoided.

The methods of control include two classical requirements:

- wastes must be deposited and levelled in layers not exceeding about 2 metres in depth;
- the whole of the surface of each layer of wastes is covered with soil or other suitable material to a depth of 15-25 cms on the same day as the wastes are delivered to the site.

Limiting the depth of a layer is required partly because of the instability of newly deposited wastes over which vehicles must pass; also to limit the fire risks which arise from various causes. Covering the wastes serves several purposes: it is no longer accessible to flies; attempts by rats to penetrate the covering material are immediately apparent; odours are avoided; and, most important, the heat resulting from decomposition of organic matter is re-

#### 14.1. Introduction

tained, and assists in the destruction of fly larvae and pathogenic organisms in the wastes.

Sanitary landfill is usually by far the cheapest method of refuse disposal. Because of this, and its comparative simplicity of operation, one would expect that it would have been adopted the world over, except for the rare case of a city having no suitable site within reasonable distance, but this is not the case.

Unfortunately most of the world's solid wastes are disposed of by uncontrolled dumping which blights the land for any future use and causes serious risks of water pollution and vector breeding. In some cases, wastes are levelled by a bulldozer so that ultimately the land can be used for another purpose, but this does not prevent pollution occurring throughout the filling operation and for some time afterwards. Very few cities operate sanitary landfilling to standards which totally control health and environmental dangers; most of those that do are in the industrialised countries.

The record of the wealthier nations, however, is by no means a good one. Numerous landfill sites have been so badly operated as to cause devaluation of property in their vicinity, and bitter criticism from the public.

*"Bad practices of the past have often created a climate of public opinion that leads property owners to oppose the location of any kind of treatment plant or disposal site in their vicinity, and renders the acquisition of sites extremely difficult, even when high standards of operation are promised. Even professional urban planners are often reluctant to allocate land for solid wastes disposal". (Solid Wastes Disposal and Control, WHO Technical Report Series No. 484).*

Paradoxically, many municipalities in the industrialised countries which avoided paying that extra Rs. 10/tonne needed to provide good management and operation of a sanitary landfill site have ultimately found themselves paying Rs. 150/tonne for incineration, not through any lack of suitable landfill sites, but because public opinion has been outraged by poor landfill standards.

The record of the developing countries is even worse; crude dumping is still the most common method of disposal and causes the following hazards :

- fly generation,
- encouragement of rodents,
- static water pollution and aerial nuisance,
- surface water pollution,
- river pollution,
- sea pollution,
- fire and smoke pollution,

**Decomposition in Sanitary  
Landfill  
14.2.**

Decomposition in a sanitary landfill arises from chemical changes which are brought about by bacteria which are present in the organic content of the wastes when they are collected, and which multiply rapidly, particularly when the wastes are effectively sealed. There are three main types of bacteria which are found in a landfill: the saprogenic, the agent of decomposition; the zymogenic, which are agents of fermentation (they are used in commercial processes such as brewing); and the pathogenic, which are associated with human diseases.

Both the saprogenic and the zymogenic bacteria are found in forms which vary according to the supply of oxygen. There are aerobic types to which oxygen is a necessity. There are obligate anaerobes for which oxygen is a disadvantage, and facultative anaerobes which can adapt themselves to varying supplies of oxygen.

During the first stage of decomposition, aerobic bacteria are dominant, but as the available oxygen declines their work is taken over by anaerobic bacteria; facultative anaerobes will be present at all times.

The bacteria have the ability to create certain colloidal solutions known as enzymes which have the power to break up stable compounds. The enzymes are used by the bacteria to reduce organic matter to a form of nourishment for them and it is this process of breaking down, and making soluble, relatively stable compounds that we know as decomposition.

The consequences of all these complex changes include:

- temperature changes within the landfill;
- the production of gases: hydrogen, oxygen, nitrogen carbon-dioxide, carbon-monoxide, methane, and sulphuretted hydrogen;
- the production of soluble and particulate, decomposition products which can be carried away from the site as a leachate when water passes through the landfill.

Irrespective of ambient temperature, the internal temperature of a landfill rises soon after the deposit of the wastes as a result of heat emitted by the activities of aerobic bacteria.

**temperature  
14.2.1.**

The main significance of this rise in temperature is its possible significance in the destruction of pathogens. The conclusions reached by two British investigators, Jones and Owen ("Some Notes on the Scientific Aspects of Controlled Tipping", City of Manchester, 1934) were as follows:

*"...it is highly improbable that pathogenic bacteria can multiply and continue to live in a tip.*

*"The factors to be taken into account when considering the likelihood of danger arising from pathogenic bacteria are as follows:*

*"The temperature inside a tip rises during the early period of decomposition to a point, in most cases, higher than the thermal death points of pathogenic germs.*

*"Pathogenic germs are difficult to keep alive even in the laboratory.*

*"The saprogenic organisms will tend to outnumber and exterminate them.*

*"Unless the organisms are spore formers they will perish rapidly under ordinary conditions of earth burial; all the common pathogenic bacteria likely to be found in a controlled tip are non-spore formers."*

**gases**      **Four** gases are of significance: sulphuretted hydrogen, carbon-monoxide, carbon-dioxide and methane. Sulphuretted hydrogen is toxic, but only small traces have been found, and any large concentration would give ample warning of its presence by its extremely offensive odour. Carbon-monoxide, which is present in large amounts is diffused very slowly and offers no risk on the surface; in excavations on sanitary landfills it has been found that at a level of one per cent it could cause unconsciousness and death if a person were to be trapped.

**14.2.2.**

Because methane is diffused very slowly from the site, in concentrations very much below the level at which ignition would occur, it rarely presents any risk. Conditions have arisen, however, where methane has seeped through fissures in the soil into buildings adjoining the landfill site, in such cases a dangerous concentration could occur.

**leachate**      Organic and inorganic matter present in crude refuse, and the products of decomposition, can be leached by water; either rainfall or groundwater, passing through the wastes. This is a potential cause of serious water pollution. In a series of experiments it was found that a layer of refuse 1.5 metres deep, compacted and covered with soil, would absorb rainfall for several weeks and thereafter produce a leachate equivalent to about one third the annual rainfall in that area, which was 635 mm. This leachate was 20-30 times as strong as settled sewage, having a BOD of 6,000-7,000 mg/litre, and contained organic carbon, ammoniacal and organic nitrogen, ammonia, chloride and sulphate. The leachate continued for several years, but within less than three years pollutants had declined to a very low level except for the sulphate.

**14.2.3.**

It follows that wastes should not be deposited in such a way that water can pass through them to a stream, nor to an underground water supply.

The broad conclusions which emerge from consideration of the decomposition processes within a sanitary landfill are :

**conclusions**  
**14.2.4.**

Wastes of S.E. Asian countries are likely to undergo a rapid rise in temperature within a few days of deposit, because they are high in organic matter. This provides re-assurance as to the destruction of pathogens, but in any case the environment of a sanitary landfill, is unlikely to encourage their survival and multiplication.

If a deep excavation is made in a sanitary landfill there may be some risk that persons entering the excavation could be overcome by gas, and appropriate precautions should be taken.

At most sanitary landfill sites (the writer would say 99.9%) there is no risk from methane, which slowly diffuses at a low concentration through the covering material. In rare cases and unusual site conditions, methane may concentrate in buildings near the site.

The most serious risk from sanitary landfilling is that of surface or groundwater pollution. This must be avoided by careful site selection, appropriate site engineering, and good operating methods.

There are a number of hazards—such as pathogenic organisms insects, rodents, birds, airborne litter, fire and water pollution—which have to be controlled in a sanitary landfill.

**Control**  
**of Hazards**  
**14.3.**

Control over pathogens is dependent upon a rigorous policy of covering the wastes, soon after deposit, with a layer of soil or other suitable material at least 15 cms in thickness. This serves both to isolate the wastes and to retain the heat which is quickly generated during aerobic decomposition.

**pathogenic**  
**organisms**  
**14.3.1.**

It is probable, however, that workers at the site will be exposed to the wastes before they are covered. In developing countries the risks to workers by skin contact with wastes may be greater than in the industrialised countries because street sweepings may contain human faecal matter. Protective clothing is a necessity, therefore, and should include rubber boots, gloves, and overalls which are exchanged and washed regularly. The provision of personal hygiene facilities at the site is also important.

The main source of insects will be the eggs of flies which have been deposited in the wastes before they arrive at the site. Most of these will be buried deep in the wastes and will succumb to the temperature increase. Near the

**insects**  
**14.3.2.**

surface, however, the rise in temperature will not be so great and the eggs will hatch into larvae; only the provision of an adequate layer of suitable covering material, well compacted, will prevent their emergence and pupation. It is the importance of providing an effective barrier of this kind which has caused the British Government to recommend a covering thickness of 25 cms.

Another obvious advantage of covering is that it denies access to the wastes to flies that are already at the site and thus avoids a major problem of open dumping: continuous cycles of breeding in exposed wastes at the site.

One of the recommended precautions in sanitary landfill is not to permit cans and motor tyres to lie about on the surface. They not only spoil the appearance but when filled with water they encourage the breeding of mosquitos. Depressions in the surface of the site which permit ponding after rain should be avoided for the same reason.

If for any reason these methods of control are not adequate it will be necessary to have recourse to insecticides. They should be used daily as long as is necessary. The rate of application recommended in "Sanitary Landfill Design and Operation" (U.S., E.P.A., 1972) is as follows:

<i>Insecticide</i>	<i>Approximate qms/Ha</i>
Malathion	672
Dichlorvos	336
Naled	111 - 222
Dimethoate	111 - 222
Diazinon	336
Fenthion	450
Ronnel	450

It is the writer's experience that the need for insecticides arises only because of some failure of the normal control measures such as allowing a large surface area of wastes to remain uncovered, or the use of a very porous or thin cover which allows larvae to reach the surface.

#### **rodents**

##### **14.3.3.**

Rodents may be attracted from surrounding farms, or they may be delivered to the site in a load of wastes. A clean, unbroken and relatively smooth surface of covering material allows a burrow to be instantly detected and recognised. Regular inspection should be made and if the beginning of rat infestation is observed, a baiting programme should be carried out by an experienced exterminator. It is normal practice to use an anti-coagulant poison.

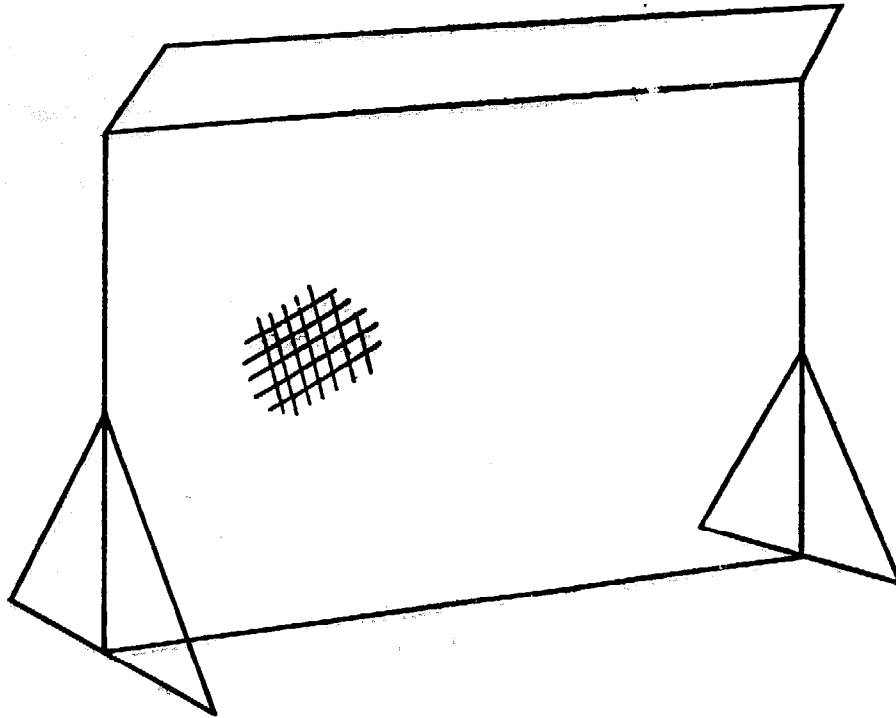
#### **airborne dust**

##### **14.3.4.**

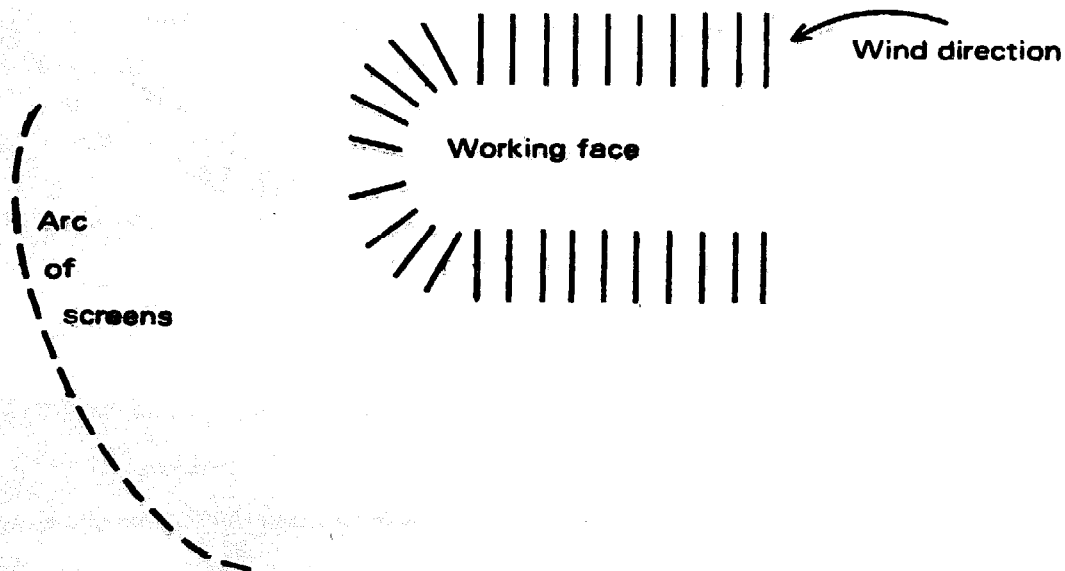
During long dry periods the surface of a sanitary landfill can become very dusty, causing unpleasant working conditions for the men, and excessive wear of vehicles and

Figure 17

CONTROL OF AIRBORNE LITTER



Portable litter screen about 2½ metres high, 2½-3 metres long, covered with chicken wire, 20mm - 40mm mesh



A number of screens are used to form an arc the position of which is changed in accordance with wind direction



plant. Watering carts are frequently used to reduce this nuisance; and waste oils are suggested in "Sanitary Land-fill Design and Operation":

*"Periodic treatment or multiple sprayings at a rate of 1-4 litres per sq metre may be necessary. After several treatments, a packed, oily, soil crust usually develops that has good resistance to traffic abrasion and is moderately resistant to water. Good penetration by the oil can be expected in more permeable soils. Clayey soils or tightly knit surfaces may resist penetration, in which case it may be desirable to lightly scarify the surface, apply...oil...and compact the surface."*

**airborne litter**  
**14.3.5.**

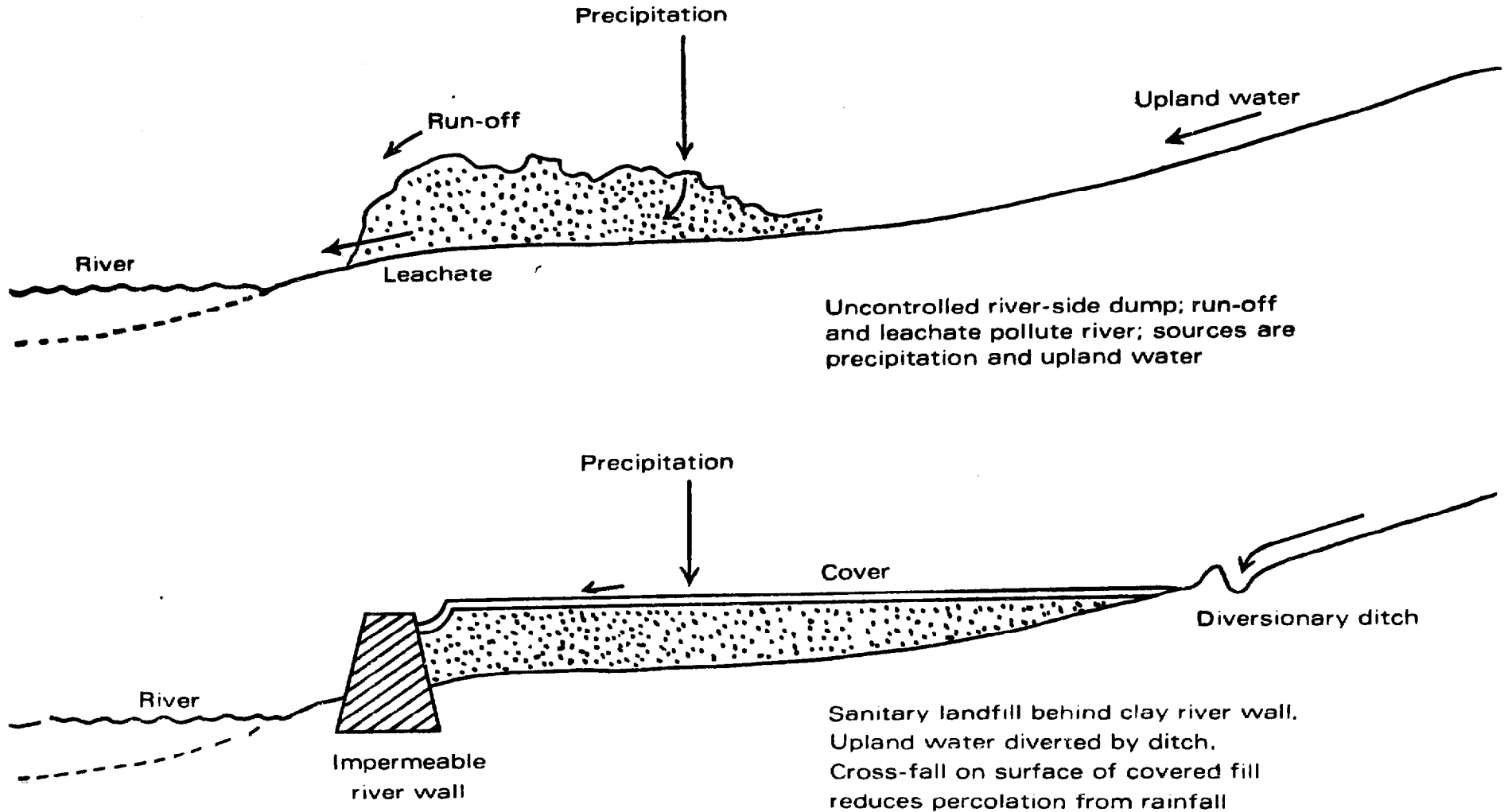
Airborne litter is often a major nuisance in the industrialised countries, and during gales at desert sites in countries having a significant paper and plastic content in the wastes. In the latter case environmental degradation of this kind has been observed extending over many square kms. It is helpful to keep the size of the working face to a minimum, but this does not prevent litter being carried away during the period when the wastes are being discharged from a vehicle. It is necessary, therefore, to employ a movable barrier of perforated screens to prevent litter being blown off the site. Convenient dimensions for a screen are  $2\frac{1}{2}$  metres long and about the same in height. The frame can be made from timber or light steel angle. To enable the screen to stand unsupported horizontal transverse members are attached by brackets to each bottom corner; these should be about 1 metre long. The whole area of the screen is covered with wire netting (chicken wire) of 20 mm to 40 mm gauge. Enough screens are necessary to form an arc sufficiently long to catch everything blown from the working area. They must be cleaned regularly if they are to remain effective, and in very high winds they may require to be temporarily supported by guy ropes secured to pegs driven into the ground.

**fire**  
**14.3.6.**

Fire at a sanitary landfill can arise from innumerable causes: hot ashes in a vehicle delivering wastes; a cigarette thrown down by a worker; the sun's rays through a fragment of glass on the surface. With some kinds of wastes the consequence of fire may be very serious and underground fires have been known that ultimately caused the collapse of the surface into voids caused by the fire. The high density, high vegetable, wastes of developing countries are unlikely to give rise to risks of this kind but it is important to try to avoid fires and to be prepared to

Figure 18

CONTROL OF SURFACE WATER POLLUTION



deal with them if they arise. Workers should not be allowed to start fires to dispose of bulky wastes such as tree loppings, and private scavengers, who may use open fires for cooking, should be prevented from obtaining access, especially outside normal working hours.

It is useful to have a supply of water on the site: the water cart used for laying dust could serve a double purpose. Once a fire takes hold, however, it is usually necessary to dig out the material which is burning before water can be applied effectively. In the early stages this can be done by long rakes but once a fire becomes deep-seated the excavation of a large area by bulldozer may become necessary.

It is important to add that the writer has never seen a deep-seated fire outside Europe. The wastes of tropical and developing countries have often been seen on fire, but the fires have invariably been on the surface and have never presented the problems of control that occur in Europe where wastes sometimes contain a high proportion of solid fuel such as cinder and coal fragments.

**birds**  
**14.3.7.**

Birds are normally attracted to landfill sites and may cause risk to aircraft if there is an airport in the vicinity. This problem is exacerbated if the birds have a routine flight path between the sanitary landfill site and another source of attraction, such as a body of water, and their flight path crosses the approaches to a landing ground. Many methods of discouraging birds have been tried, from cannon to falcons, but none has been entirely successful.

This problem is one that does not appear to be controllable and the solution lies in the selection of sites which avoid creating the risk of bird-strikes on aircraft.

**Surface-water**  
**pollution**  
**14.3.8.**

The pollution of static water, ditches, rivers, or the sea can occur when a sanitary landfill adjoins a body of water. The normal source of the leachate causing this pollution is rain falling on the surface of the fill, percolating through it, and passing over an impermeable base to water at a lower level. Only a proportion of total precipitation emerges as leachate; some is lost by evaporation and transpiration. In the British experiments of 1961 an annual rainfall of 635 mm produced a leachate equivalent to 200 mm. In arid areas there may be insufficient rainfall to create a leachate, but in all other cases the production of leachate from rainfall is unavoidable during the early stages of filling. The quantity of leachate can be substantially increased when upland water drains across the site of the landfill, but the worst case is when a stream crosses

the site. The solutions to these problems lie in appropriate site engineering, such as :

- diversion or culverting of all watercourses which flow across the site,
- diversion of upland water by means of drainage ditches along appropriate contours,
- containment of leachate arising from precipitation by the construction of an impermeable barrier where necessary, such as a clay embankment adjoining a river,
- grading the final level of the site so that part of the precipitation is drained across the surface, thereby reducing percolation below the level needed to produce a leachate.

Works of this nature will obviously add to the cost of a sanitary landfill project, but it is usual to find that when capital expenditure is spread over the life of the project the cost/tonne is still very much cheaper than for any alternative method of disposal. Furthermore, some of these forms of expenditure, such as culverts or river walls, represent capital assets of continuing value when the reclaimed land is handed over for its final use, perhaps agriculture or recreation.

Every proposed landfill site should be the subject of survey and evaluation by a hydro-geologist and where there is a risk of leachate passing directly to underground water which is the source of a public supply, or to wells, the site must be rejected. The following comments are designed only to indicate the nature of this problem and do not pre-empt the judgement of the local hydro-geologist.

**ground-water  
pollution  
14.3.9.**

Potential sites can be divided into three main groups :

- impermeable sites,
- sites on which subsoils such as sand and gravel, may provide a measure of filtration,
- fissured sites from which a leachate may be able to travel many kilometres.

The classic impermeable site is a clay pit from which there are no pollution risks because the leachate cannot escape.

On sites which provide filtration the British Technical Committee reported as follows :

*"Experimental filtration at a rate of about 30 cms per day of the polluted percolates through anaerobic filters of graded sand and gravel produced remarkable results. In a distance of about 7.3 metres practically all bacterial pollution and most of the organic pollution was removed. This was confirmed in full scale tipping . . . .*

*"The experiments . . . indicated that sub-soils such as sand and gravel would act as an effective filter for*

*bacterial and organic contaminants. For such contaminants as chloride and sulphate, reliance would mainly have to be placed on dilution but generally it is considered this will be sufficient in many cases when the quantity of water abstracted from an underground source of water supply thought to be at risk is related to the quantity of percolate ..."*

On this question the following observations are made in "Sanitary Landfill Design and Operation" (EPA, 1972):

*"It is a basic premise that groundwater and the deposited solid waste not be allowed to interact. It is unwise to assume that a leachate will be diluted in groundwater because very little mixing occurs in an aquifer since the groundwater flow there is usually laminar.*

*"When issuing permits ... many States require that groundwater and deposited solid wastes be 0.6 to 10 metres apart. Generally a 1.5 metre separation will remove enough readily decomposed organics and coliform bacteria to make the liquid bacteriologically safe. On the other hand, mineral pollutants can travel long distances through soil or rock formations. In addition to other considerations, the sanitary landfill designer must evaluate the: (1) current and projected use of the water resources of the area; (2) effect of the leachate on groundwater quality; (3) direction of groundwater movement; (4) inter-relationship of this aquifer with other aquifers and surface waters."*

Where there is doubt as to the characteristics of a proposed site the British Technical Committee suggests the following precautions:

a) *Waterproofing the base of a pit prior to tipping, i.e. with puddled clay (or chalk), collection of the percolate and its disposal ...*

b) *Rapid tipping of successive layers of refuse in order to utilise its capacity to absorb rainfall and to cover the final layer with a waterproof earth cover with a good cross-fall to provide a ready run-off of rainfall."*

Similar advice is given in "Sanitary Landfill Design and Operation":

*"An impermeable liner may be used to control the movement of fluids. One of the most commonly used is a well-compacted natural clay soil, usually constructed as a membrane 30 to 90 cms thick. It must, however, be kept moist.*

*"The use of an impermeable barrier requires that some method be provided for removal of the contained fluid."*

The writer would question whether the provision of an impermeable liner must always involve collection of the percolate. Many naturally impermeable sites have been filled without any attempt at percolate collection; after all, grading of the final surface should avoid, or greatly reduce, percolation of rainfall after the first two years.

Many developing countries may find the collection and treatment of leachate a difficult and costly procedure and one which has no residual value in relation to the ultimate use of the land. To put this matter into perspective: the writer knows of only three sites in Britain, out of many thousands of landfills, where measures of this kind were necessary.

The recommended approach is to reject sites at which problems are revealed by hydro-geological survey. The major pollution problem in the developing countries appears to be the contamination of surface water by run-off and this can be controlled by relatively simple site engineering.

Crude dumping is a policy of despair; it is the appropriation of land on which to dump solid wastes without any control measures and without any concern for the ultimate effect on that site and on the environment.

Sanitary landfill is a philosophy of conservation; it is the use of solid wastes in a planned and controlled land reclamation project which results in environmental improvement.

There are three parties involved in the procedure for choosing sanitary landfill sites:

- land-use planners, of the Town and Country Planning Department,
- the water authority,
- the solid wastes management authority.

The first stage should be for the land-use planners, who are familiar with the detailed physical characteristics of a wide area, to draw up a list of possible sites all of which could be improved by raising the level, and which lie within a few kilometres of the built-up area of the city. They will give high priority to the restoration of man-made dereliction, where this exists, thus the list is likely to include disused surface mineral extraction sites, such as sand and gravel pits, clay pits, quarries, and brick-earth excavations.

**Planning  
a Sanitary  
Landfill  
14.4.**

**site selection  
and land-use  
policy  
14.4.1.**

Natural features that can often be improved by land-filling include: marshland, river or estuarial foreshore and ravines. Filling, however, would not be recommended on such sites if it was thought to be ecologically undesirable.

The land-use planners should also decide the long-term use of the landfill site after reclamation, and the level to which it is to be filled. From this information it is possible to calculate the approximate volume of the site, and to estimate its landfill life, on which depends the amount of capital expenditure that could reasonably be incurred to prepare it for use.

**location  
and access**  
14.4.2.

The solid wastes management authority can then evaluate the sites proposed by the town planners, using the following criteria:

1. The location should be as close as possible to the built-up city area in order to reduce transport cost. (At Rs. 0.60/tonne/km, an extra 3 kms further from the city would add 6 kms to every journey, equivalent to Rs. 3.60/ tonne of wastes.)
2. The site should be close to a road which is capable of handling the traffic generated by the landfill site.
3. Sites will be preferred at which the nearest dwelling is at least 200 metres distant. However, there are many examples of nuisance-free filling much closer to buildings when operating standards are high.
4. Large sites enable capital expenditure to be spread over a greater tonnage of wastes, thereby reducing unit cost.

**water  
authorities**  
14.4.3.

The sites which have been selected by the solid wastes management authority must now be submitted to the water supply authority, and also to the rivers authority if that is a separate body, for hydro-geological evaluation. The judgements of the water authority are likely to fall into three categories: approval, disapproval, or qualified approval. Qualifications are likely to relate to site engineering of a protective nature, such as drainage, or to the operating method, or even the nature of wastes that may be deposited.

**final selection  
of sites**  
14.4.4.

The final choice of a site or sites will probably be based on cost which will comprise three main elements:

- site engineering to avoid water pollution,
- capital works for site operation, such as a site office,
- operating costs: labour, purchase of covering material and road material, stores, and plant operation if mechanised.

When comparative costs of alternative sites are being

judged. it is important to take into account the inter-relationship with refuse collection transport cost, for example, transport savings by using a near site may outweigh a higher expenditure on site engineering. For the same reason, the diseconomy of scale arising from multiple small sites as against one large one may be more than offset by transport cost savings.

It is implicit in sanitary landfilling that a site will be of very limited utility, if any, before reclamation, and will be capable of fulfilling its planned ultimate use afterwards. Thus the land value of a potential site should be low and the value should rise after reclamation. For this reason it is highly desirable that the local authority should buy the land outright in order to profit directly from the ultimate increase in value. Many useful sports fields have been acquired in this way at very low cost, and reclaimed land has sometimes been sold at a good profit for agricultural use.

When this is not possible, the next move should be to try to convince the owner of the land that its value would be improved after filling, in the hope of securing a long lease at a nominal rent. In some countries local authorities have powers of compulsory purchase in cases where they are unreasonably denied possession of land required for a purpose of this kind.

Before a sanitary landfill site is opened it is necessary to design the engineering features in detail and to prepare an outline plan of the method of operation. The following is a typical checklist :

- |                             |  |
|-----------------------------|--|
| Protective site engineering | as defined by the water authority.   |
| Operational engineering     | main services<br>entrance<br>office<br>welfare<br>storage of plant and tools<br>storage of salvage |
| Plan of operation           | main site road<br>layers<br>strips<br>cells<br>covering material<br>phased planting programme      |

site acquisition  
14.4.5.

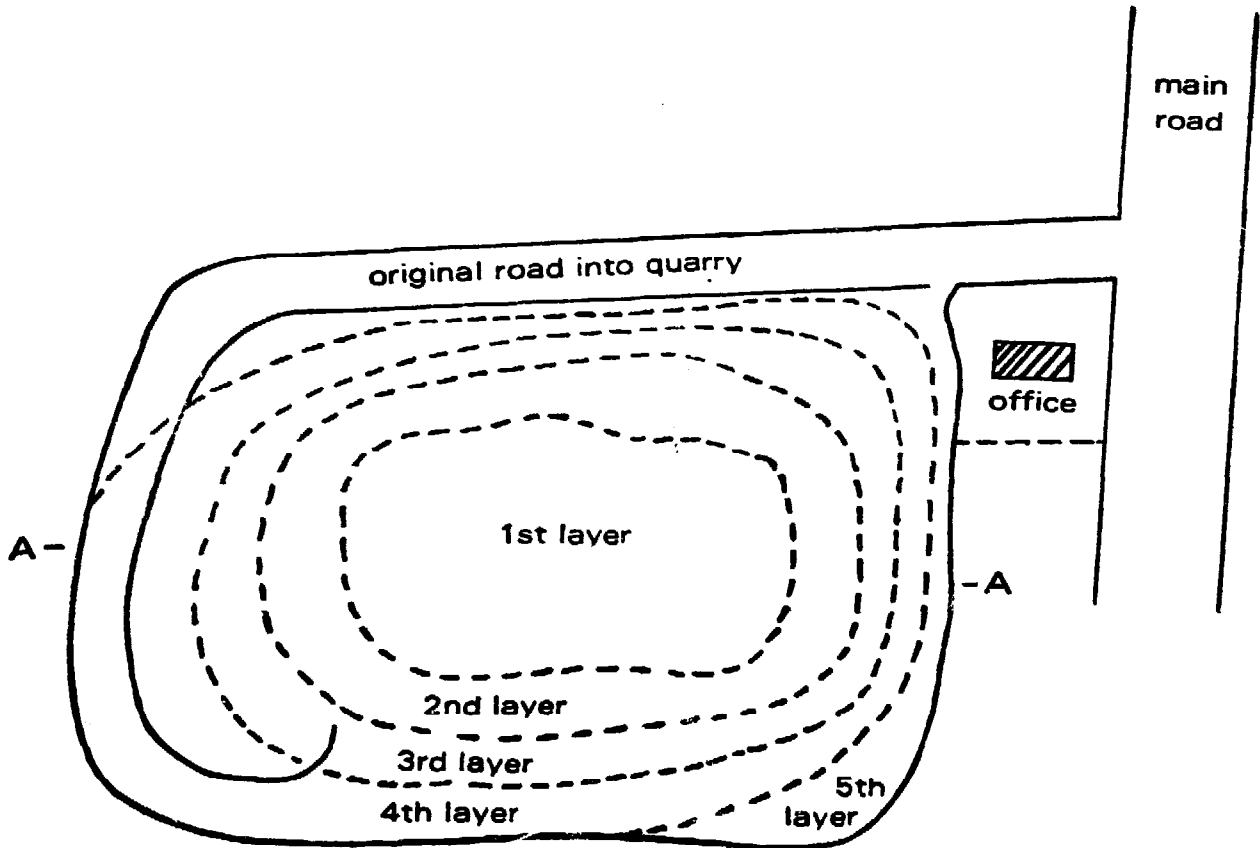
Design of Sites  
14.5.

The sophistication of design must be relevant to the scale

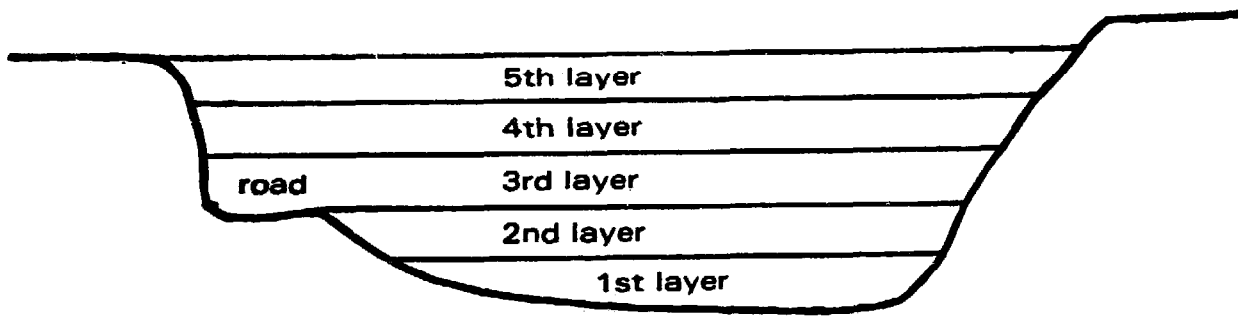


Figure 19

OPERATION PLAN FOR DEEP QUARRY



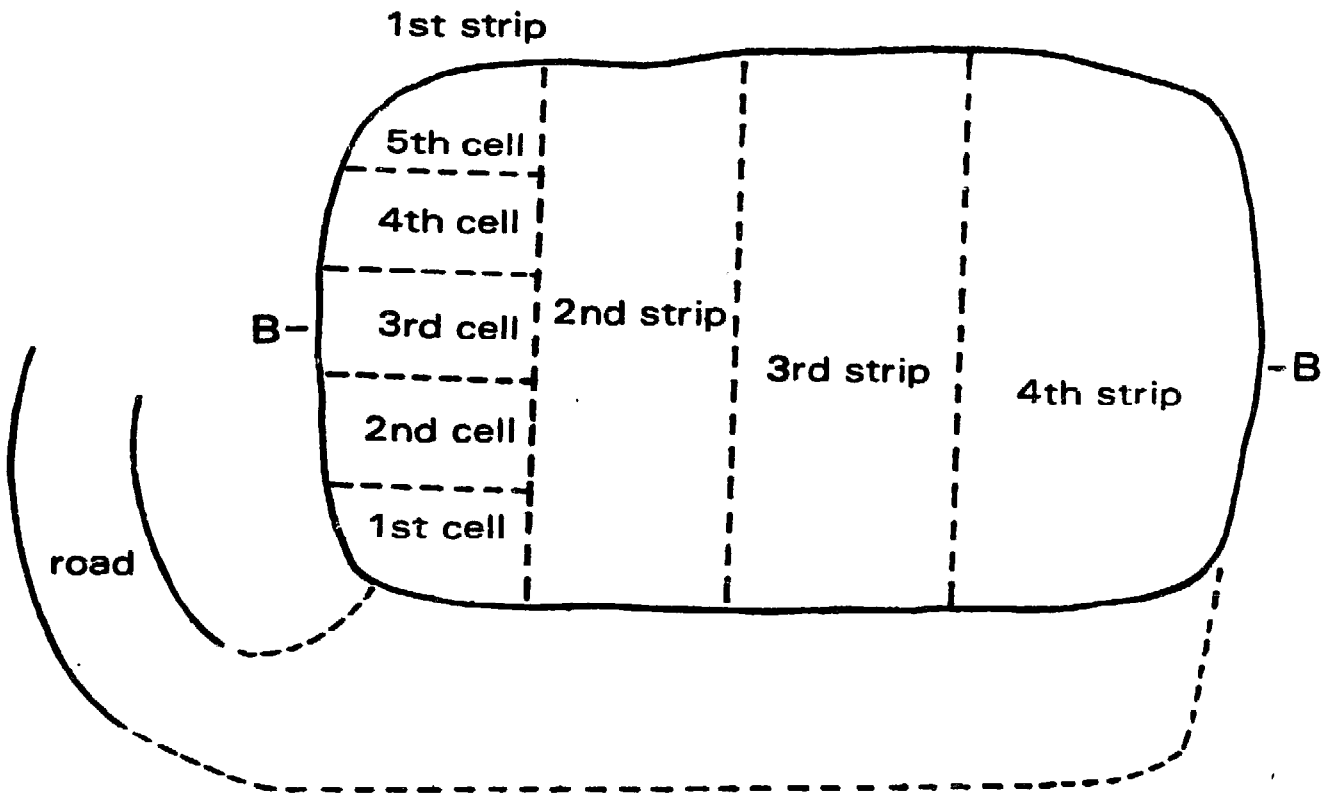
PLAN , 2 metre contours



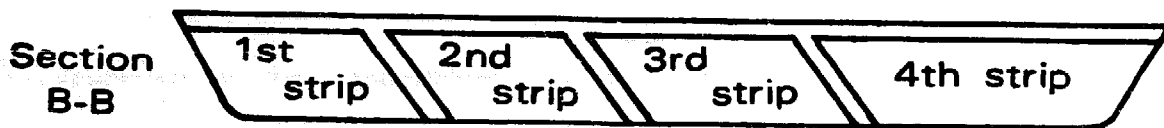
SECTION A-A

Figure 20

FORMATION OF LAYER IN DEEP QUARRY



PLAN



SECTION

of operation. A town of 50,000 people, producing 20 tonnes/day, could not support, and would not need, the same standards of entrance control and site road construction as a site receiving 200 tonnes/day from half a million people. Nevertheless, many of the design factors described below apply in principle, and on an appropriate scale, to small, manually operated, sites.

**protective  
site engineering  
14.5.1.**

The kind of site engineering required for the prevention of water pollution have been described earlier, in general terms, and includes diversion ditches, culverts and river or sea walls.

**operational  
site engineering  
14.5.2.**

Where the services are readily available, it is very useful to bring mains water, main drainage, and electricity into the site. If this is not possible then water can be supplied by means of a tanker-trailer, oil or butane can be used for lighting, heating and, if necessary, cooking, and pail closets can be provided.

A control area should be provided at the entrance to a site, the main features being :

- maneouvring and parking space for vehicles,
- cabin or office for site control,
- toilet facilities,
- shed for small stores, tools etc.,
- garage for earthmoving plant, if used,
- shed for salvage, if recovered on site,
- site identification board.

This area, or at least that part of it on which the temporary buildings will be located, should be formed from inert materials if it is at raised level.

At small sites having relatively short lives the erection of temporary buildings for such purposes as office, toilet and small stores can be avoided by using a caravan which can be towed from one site to another.

**plan of operation  
14.5.3.**

The most important feature of the plan will be the main site road which should permit access to the most distant part of the site in any kind of weather. This could be a spine road crossing the centre of the site, or it could follow one of the boundaries. In the case of a former quarry, a road to the bottom level is likely to be in existence. On a level site, the road must be constructed at raised level. In a valley site or a deep natural depression, the road must be taken to the lowest two metre contour to gain access to the lowest level where the first layer will be formed. This road is normally formed from wastes which are topped, after normal covering, with hardcore (broken bricks) old road metal, or similar material. When it is

brought into use this road requires to be continuously repaired as it settles, and after about a year it can be water-proofed with a layer of bitumin.

A deep site should be surveyed and a contour plan prepared; two metre contour lines would indicate each successive layer of wastes.

To ensure the orderly progress of filling and covering, each layer should be constructed from a number of side-by-side strips (sometimes called fingers), the width of a strip depending upon the number of trucks which would have to unload simultaneously at the working face. The width of the working face, which is the same as that of a strip, is calculated in the following way :

At a 250 tonnes/day site it has been estimated that 70 loads will arrive over a period of 8 hours.

This is equivalent to 9 vehicles/hour, or one every 7 minutes.

If unloading time is 10 minutes, 1.5 trucks discharge simultaneously.

But this is the average rate and allowance has to be made for peak periods. This can be determined locally by examining vehicle times.

Assume it is necessary to allow for 4 trucks at peak periods, then the width of the working face should be  $4 \times 6$  metres = 24 metres.

In practice the necessary width of a strip is likely to range between the minimum of 6 metres at a site handling a very small tonnage to about 30 metres for 200-300 tonnes/day. When the input to a site exceeds this amount multiple working faces are recommended to minimise traffic congestion.

This is an appropriate point at which to refer to the importance of using vehicles with tipping gear, either hydraulically operated or manually operated by worm and nut. Vehicles which have to be unloaded by means of rakes and shovels occupy space at the working face for excessive periods and prevent orderly operation. Furthermore, the time saved by mechanical tipping may be equivalent to an extra load collected every day. This could be very important to the economics of refuse collection in a developing country, where maximum vehicle productivity should be a major objective.

The classical method of sanitary landfill requires that each strip is formed of a number of cells, each of which

represents a day's or a week's work. The importance of a daily cell is stressed in "Sanitary Landfill Design and Operation" (EPA):

*"At the end of each working day, or more frequently, it is covered with a thin, continuous layer of soil which is then also compacted. The compacted wastes and soil cover constitute a cell."*

The British Working Party makes a similar recommendation:

*"The tipped material should be covered progressively so that all surfaces including the tip face and flanks are covered at the end of each working day with a layer of suitable sealing material spread so that it is not less than 22 cms thick."*

In the writer's view it is important to differentiate between the obvious necessity of covering the top surface and side slopes (or flanks) progressively, every day, and the need to cover the forward slope, or working face, at the end of every working day, if in any case, it is to be covered within a few hours by the following day's wastes.

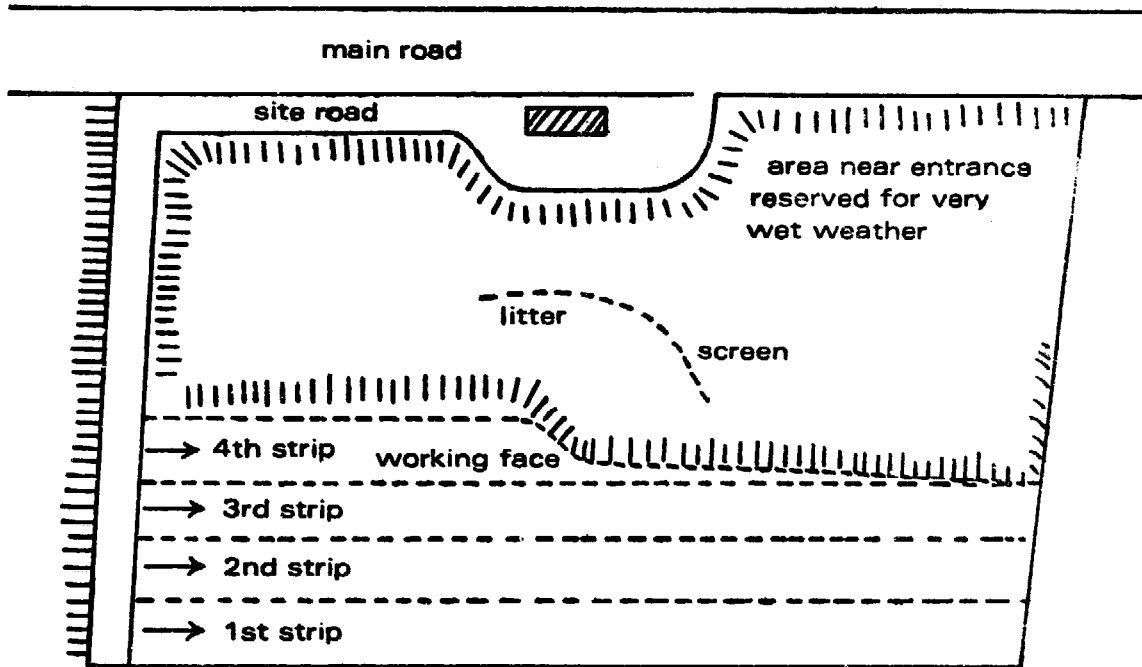
Thus, while immediate covering of the top surface and flank or flanks is a matter of absolute priority, cellular construction may be much less important than is usually supposed. Daily covering of the forward slope of the working face is rarely carried out at British sites; this does not appear to have harmful consequences, and it economises in covering material. Weekly covering of this part of the working area was practiced in Britain when sanitary landfill was a totally manual operation, and would appear to be a suitable policy for most developing countries to follow now.

The source of covering material is a vital issue and the plan of operation for a site should resolve this question clearly. Because the answers to this question may be very different as between manual and mechanised operation, discussion is deferred until these topics are reached.

At large sites, and especially those filled in a single layer, the plan of operation should provide for phased cultivation, for if cultivation is not commenced fairly quickly weeds will soon establish themselves. Cultivation is facilitated if filling commences at the most distant part of the site as there will be no traffic over completed sections. However, if a road adjoins the site, there are public relations advantages in quickly reclaiming an area which is visible to the public and bringing it into cultivation; this could be grass, for recreation, or a marketable crop.

Figure 21

PLAN OF OPERATION FOR A LEVEL SITE



- STAGES**
1. Entrance area and site of building filled with inert wastes
  2. Site road formed from wastes, covered 25 cms soil plus 30 cms hardcore; waterproofed after 1 year.
  3. First strip; wastes covered 25 cms
  4. Subsequent strips formed
  5. Cultivate strips 1 and 2 when work commences on 4th strip

a flat plateau is ugly and interrupts the landscape

section

a smooth contour blends with the landscape

section

**Criteria  
for Manual  
or Mechanised  
Methods**

**14.6.**

When the operators of crude dumps are asked why they do not use sanitary landfill methods the invariable answer is that they do not possess a bulldozer, or that it is broken down and awaiting repair. Everywhere one finds the assumption that sanitary landfill is impossible without earthmoving plant. Few people seem to know that sanitary landfill was developed many years before bulldozers were invented.

In essence sanitary landfill is the formation of a number of contiguous embankments, which were referred to earlier as strips. The task is virtually the same as the construction of a railway embankment 2 metres high: the filling material is dumped in heaps which are then spread out to form a level road and the flanks formed to the required slope. There are two differences: one is the need for a layer of covering material; the other is in the nature of the filling material used at the sanitary landfill.

The reasons why sanitary landfill has been mechanised from the very beginning in USA, and why Britain abandoned manual methods from about 1950 onward, are as follows:

- the very low density of the filling material, which initially occupies a very large volume; this can be reduced at the time of deposit by the use of heavy plant, thereby enabling more wastes to be disposed of at that site;
- bulky wastes such as furniture and boxes are quickly broken up by heavy plant;
- at suitable sites it was possible by using machines to excavate covering material from the site instead of importing it;
- because of high wage rates, the use of mechanical plant reduced unit cost of operation.

The development of sanitary landfilling by mechanised methods relates, therefore, almost entirely to conditions which apply to the industrialised countries. Because the source of almost all technical literature has been USA and Europe, there has been great emphasis placed on compaction. There is also a vast amount of commercial literature for the purpose of selling mechanical equipment and in much of this the importance of compaction is exaggerated.

**density  
of wastes  
and compaction  
14.6.1.**

The range of initial density of wastes in the industrialised countries is usually from 50 - 150 kg/cu m, and in the developing countries, from 300 - 500 kg/cu m. It is interesting to compare the consequences of these differences after the wastes have been deposited in landfill.

From "Sanitary Landfill Design and Operation" (EPA USA):

The field density of most compacted wastes within the cell should be at least 472 kg/cu m...

The density of solid wastes in landfill is quite variable. One that is well constructed can have an in-place density as great as 885 kg/cu m.....generally 472 - 590 can be achieved with moderate compaction effort.

From "Controlled Tipping" (Bevan, Institute of Solid Wastes Management, London):

In density tests, excluding covering material, at Sunderland in May 1963 Jackson, D.W., recorded the following:

Density as tipped from vehicle and after pushing over, but before compression by traffic:	270 kg/cu m
Density after 3 days	628 "
Density after 1 year	760 "

From "Garbage Disposal for Calcutta City" (National Environmental Engineering Research Institute, India, 1970):

..... a number of scattered sites where dumping was done six months earlier were chosen... where a one cu metre trench was excavated. The material taken out was then weighed to get the density... The average is adopted... the table indicates that even without any compaction equipment it is possible to get a good density within six months. This is essentially due to... the typical characteristics of the material....

Density of refuse arriving at various disposal sites:	range, 518 - 573 kg/cu m
Density of dumped refuse (6 months old)	average 1,128 kg/cu m

From the figures quoted above it would appear that high density wastes which are typical of developing countries do not require deliberate initial compaction. (In the few developing countries where wastes are low in density, compaction equipment may be desirable but in these countries the cost of the equipment does not present a problem.)

In any case compaction takes place in other ways. One is by the repeated passage of wheeled traffic over the strip being constructed.

The process of decomposition is the main agent of compaction and stabilisation. Bevan describes this in terms of wastes which have about 40% vegetable-putrescible

**other forms  
of compaction  
14.6.2.**



matter and about 40% paper, but his argument is equally valid for the wastes of developing countries where vegetable-putrescible matter may range from 50 to 80%.

*"The statement has often been made that lighter, bulkier refuse takes up more tip space. While this is true in the short term . . . . this assumption ignores the natural phenomenon of decomposition — the reduction of complicated substances to simple elements and the reduction in volume achieved . . . . . 80% or so of the refuse will be in a form which will decompose to gases, water and humus. Jones and Owen assessed that the organic content of refuse by chemical and biological change reached a final irreducible residue . . . . . of about 10% of the original weight . . . . . Decay is a process of combustion and chemical change which, although slow, is as certain and definite as fast burning . . . . . The conditions within a tip do not create an ideal environment for bacteria, mainly because of pockets, large and small, of dry inert material, but if there is an increase in vegetable and putrescible matter the breakdown rate overall is likely to increase if only because there will be more physical contact between dry and wet refuse . . ."*

One further compaction agency is rainfall which, as it percolates through the landfill, carries fine material from the upper levels into voids at a lower level.

It is reasonable to conclude, therefore, that in developing countries the employment of mechanical plant to achieve initial compaction of wastes is unnecessary and that a high in-place density will normally be achieved by natural processes within a comparatively short time.

#### **covering material**

##### **14.6.3.**

The advent of the bulldozer, front-end-loader and the scraper opened up the possibility of obtaining covering material from the site being raised. If the site has a layer of good topsoil this should be stripped and stockpiled and used for final cover of the completed fill. If below this there is a subsoil which is suitable for use as primary cover, this can be stripped from day to day and applied to the levelled wastes as they are formed. In these conditions mechanical plant confers the following advantages:

- conservation of valuable topsoil,
- immediate availability of primary covering material,
- no transport cost for bringing covering materials to the site,
- the maximum space is available for disposal of wastes because no covering material is imported.

Theoretically it would be possible to perform all the above operations manually, but the writer has never seen this attempted, and for this kind of work mechanical methods would almost certainly be cheaper than manual ones even in areas of very low wages.

There are, however, many sites at which it is impossible to win covering material, such as ravines, rocky ground and marshland. In these situations covering material must be imported to the site in trucks, tipped on the formed wastes and spread. Manual labour is very efficient for this last task; the manually operated sites in Britain in the "thirties" were always more carefully covered, and much better in appearance than most mechanised sites are today.

Thus, the character of the site will usually determine whether mechanisation is necessary for soil stripping purposes. There will be many intermediate cases where earth-moving plant is required only before and after filling: first to strip the topsoil and later to replace it at higher level; because few subsoils are entirely suitable for primary covering over which vehicles have to be driven.

Manual operation—that is, without the use of earth-moving equipment—could be fairly effective if proper care is taken in the selection of the site and in the formation of strips.

**Manual Operation**  
**14.7.**

As with all other methods of operation an all-weather access road must be provided first, from the nearest point on a main road to the point at which filling by wastes is to commence. This road is usually built from waste materials such as construction wastes, broken and rejected bricks or old road metal on a bed of ash or clinker to provide drainage. After the road has been made, a small stock of these materials must be kept available for day-to-day repairs such as filling depression caused by traffic.

**access**  
**14.7.1.**

The position of the first strip to be raised should be defined by two rows of pegs driven into the ground, and the final level of the first layer should be indicated by occasional posts with cross pieces which can be used for sighting. Unless guidance of this kind is provided it will be found that operators allow the depth of the fill to increase as the strip extends.

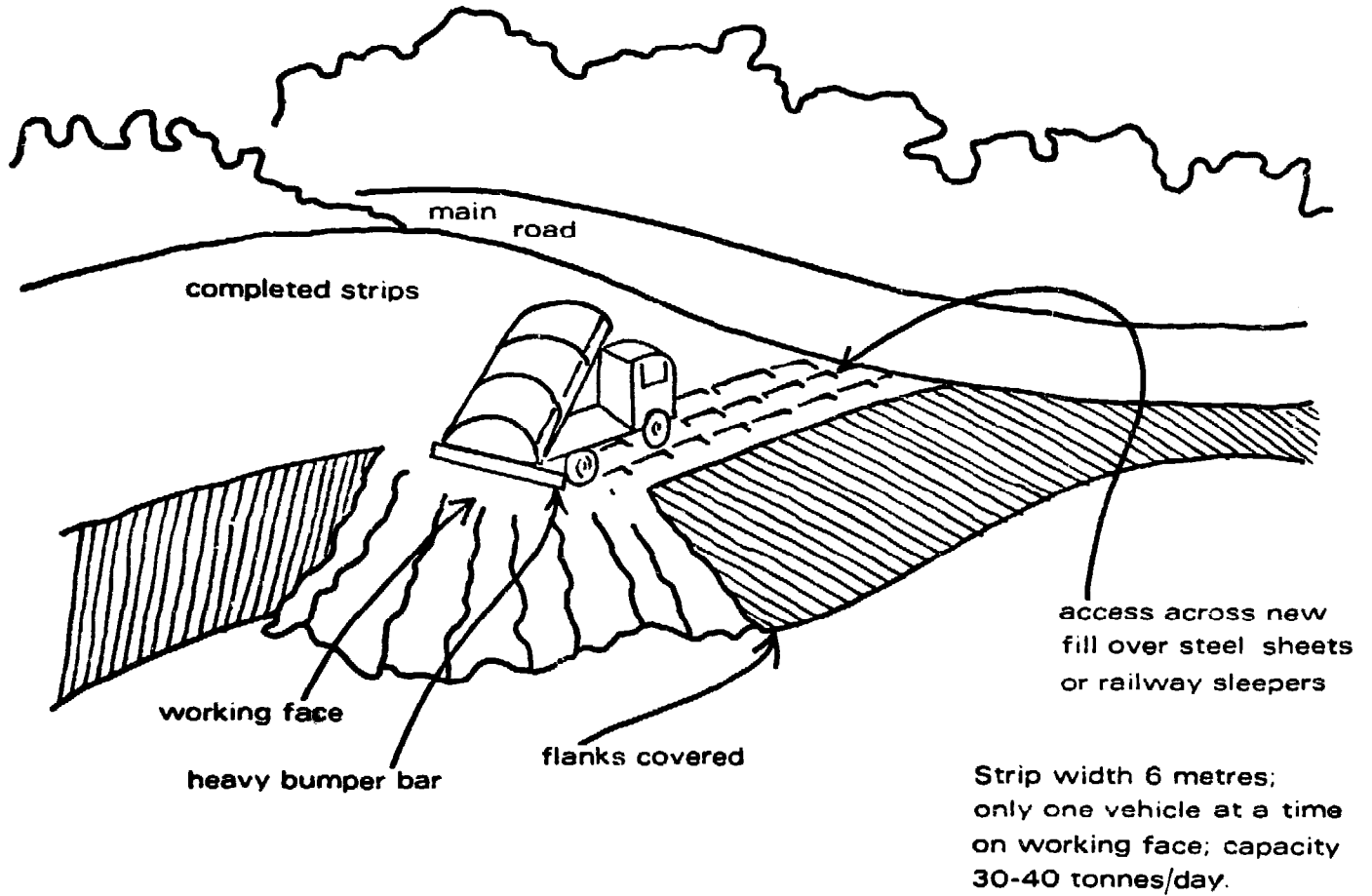
**pegs**  
**14.7.2.**

The most effective tool for forming an embankment from wastes is a three-tine "drag", or rake, with a handle up to two metres in length. The size and form of the tines is

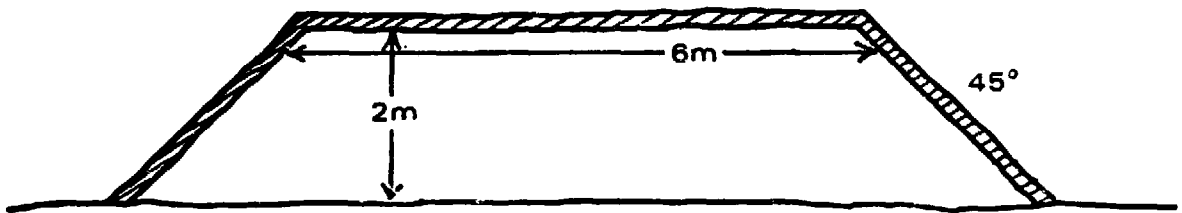
**formation of strips**  
**14.7.3.**

Figure 22

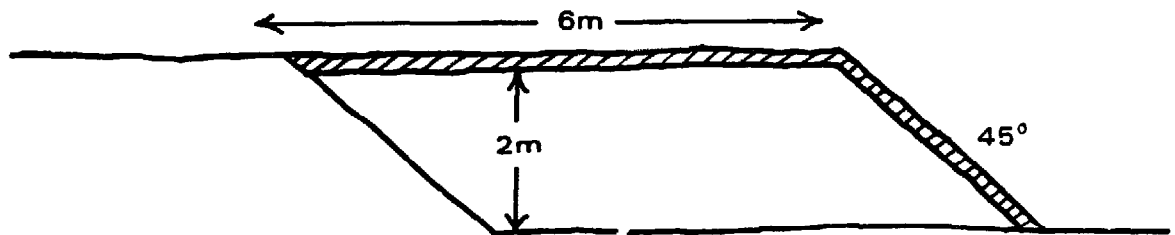
SMALL MANUALLY OPERATED SANITARY LANDFILL



COVERING MATERIAL, top and flanks



First strips : cross-section of fill 12 sq. m  
cross-section of cover 12mx20cms 2.4 sq. m.  
Ratio by volume, about 1:6



Subsequent strips : cross-section of fill 16 sq. m  
cross-section of cover, 9mx20cms 1.8 sq. m  
Ratio by volume, about 1:6

similar to those of a fork used for digging, but the tines are at right-angles to the socket for the handle. These tools are easily forged by a blacksmith and the handles, which should be light, yet strong, can be made from a wide variety of natural materials; ash is preferred in Britain, but cane may be suitable too.

The vehicle delivering the wastes should be reversed to a point as close as possible to the working face, to minimise the distance over which the wastes have to be moved by hand. (The importance of vehicles being equipped with tipping gear has been stressed earlier). To reduce the risk of the vehicle reversing too far, a strong, heavy, bumper bar should be placed at the point where the rear wheels are intended to stop. This is usually a baulk of timber such as two railway sleepers bolted together.

To avoid the rear wheels of vehicles sinking into the newly deposited wastes near the working face, it will probably be necessary to cover a small area with steel sheets or old railway sleepers.

If the wastes are well placed, they will form a heap above the filling level, but immediately adjacent to the working face. Very little lateral movement will be necessary, and most of the heap can be dragged down by the men on the face, a comparatively easy task assisted by gravity. To accomplish this, however, they need to stand in the wastes and protective clothing should be provided.

If there are hollow containers such as old oil drums in the wastes, these should be placed at the toe of the face in an upright position and filled with wastes; otherwise they would cause voids and the risk of uneven settlement.

As the face advances, the flanks are formed by dragging the wastes to an angle of about  $45^{\circ}$ . The only occasion on which it is necessary to form the working face to a specific angle is when it is about to be covered, which could be at the end of each working day or at less frequent intervals. The angle of the face at the time of covering should be as steep as possible in order to minimise the amount of covering material used.

From time to time during the day covering material should be delivered to the site, the volume required being between one fifth and one seventh of the volume of the wastes after formation in the fill. The density of the wastes at this stage will be at least 50 per cent higher than when delivered to the site even if the initial density is high.

If the new wastes have been covered by steel sheets, these are temporarily removed while covering material is

Figure 23

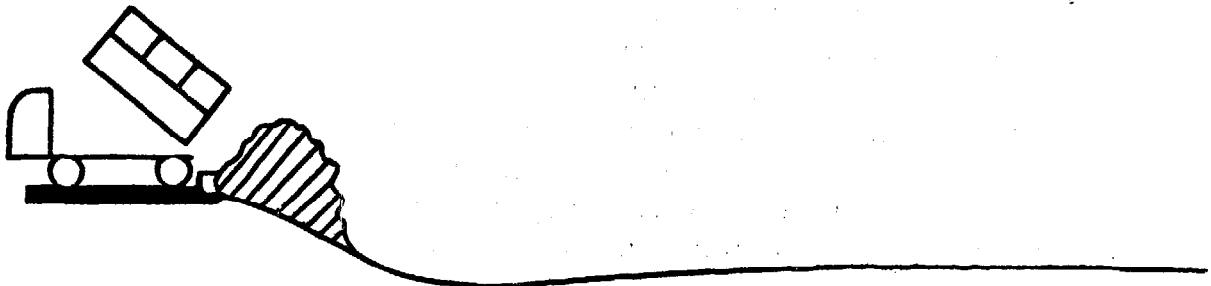
MANUAL LANDFILL, FORMATION OF FIRST STRIP



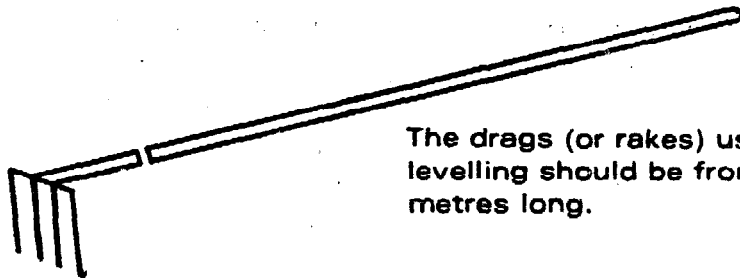
1. Section through original site which is about two metres below the level of the surrounding area.



2. A hardcore road is built from the nearest main road to the point where filling is to commence. Drive in pegs to indicate width of strip to be formed and the levelling of filling



3. Commence tipping wastes at this point.

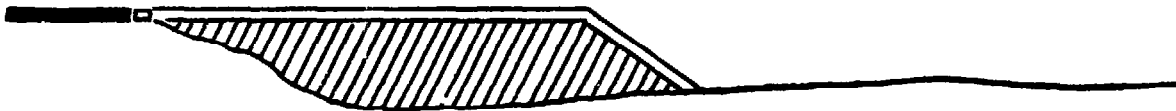


The drags (or rakes) used for manual levelling should be from 1.8 to 2 metres long.

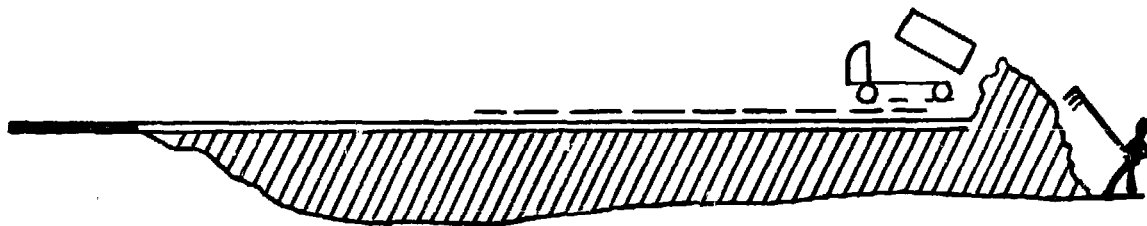
Figure 23 continued



4. The heaps of wastes are levelled by a three-tine drag (or rake) with a handle about 2 metres long, and the flanks are formed to an angle of about  $45^\circ$ . Levels and strip width are guided by pegs driven earlier.



5. Every day the levelled wastes and the flanks are covered by between 15 cms and 25 cms of soil, sand, ash or composted wastes etc. Daily, or weekly, the working face is covered to form an enclosed cell of wastes.



6. Always take the vehicle right up to the working face to avoid dumping wastes on covered areas. If vehicles sink in, extend the hardcore road as far as possible, then use railway sleepers laid transversely, or steel sheets, to form a track over the newly deposited wastes. Always provide a heavy bumper bar at the point where vehicles unload.

being spread to a thickness of at least 15 cms and preferably up to 25 cms. The best tools for this work are shovels and wide garden rakes with short tines. The flanks are also covered to a similar thickness, and this covering should be beaten down by the backs of shovels or by specially fabricated wooden beaters with long handles.

**all-weather  
operation  
14.7.4.**

Prolonged heavy rain is the only real obstacle to the smooth operation of the procedure that has been described; if the surface of the embankment becomes waterlogged then there is a risk that vehicles will sink in. When periods of heavy rainfall are a feature of the climate, it is advisable to provide a portable roadway across the strip in the form of old railway sleepers or steel sheets. Alternatively, and provided that this does not inhibit the ultimate use of the reclaimed site for its planned purpose, a hardcore road can be laid to within about 50 metres of the working face. Portable road surfacing can then be used only for the final approach.

It is the custom at many sites to reserve an area close to the original access road for emergency use during periods when, despite all the other precautions, it is temporarily difficult to cross the site. This can happen if a vehicle breaks down on a single track roadway.

It is necessary to be prepared to recover vehicles one or more wheels of which have sunk up to the axles. Heavy jacks and timbers are necessary. The vehicle is jacked up, using the timbers to spread the load; the cavities caused by sinking of the wheels are then filled with hardcore. It is then usually possible to drive the vehicle out, with towing assistance from another vehicle if necessary.

**labour required  
14.7.5.**

The writer has clear recollections of three sites which were operated in the above manner and the staffing ratios were as follows :

Site 1	30 tonnes/day	2 men	15 tonnes/man/day
Site 2	50        ,,	6 men	8        ,,        ,,
Site 3	100       ,,	10 men	10       ,,        ,,

The density of the wastes delivered to these sites fell in the range 250-400 kg/cu m, thus for a given tonnage received the volume to be handled would be similar or greater than in the developing countries.

The table on the opposite page indicates the probable scale of requirement for labour and covering material at typical rate of generation and density :

Population	Tonnes/day @ 500 gms/ person/day	Cu m/day @ 330 kg/ cu m	In-place volume cu m	Covering material, cu m/day	Men
20,000	10	30	20	4	2
50,000	25	75	50	10	3
100,000	50	150	100	20	6

Accurate cost estimates are possible only for a specific case, but it is useful to try to indicate the probable scale of cost.

**estimated costs  
14.7.6.**

The two main cost elements are labour and the transportation of covering materials. The former is assumed to be Rs. 15/day including oncosts, and the latter Rs. 15/cu m.

	Rs.
Population 20,000	
2 men	30
cover, 4 cu m	60
total, for 10 t.	90
Cost/tonne	9
Cost/tonne if cover delivered free of charge	3
	Rs.
Population 100,000	
6 men	90
cover, 20 cu m	300
total, for 50 tonnes	390
Cost/tonne	7.8
Cost/tonne if cover delivered without cost	1.8

Perhaps the most important thing demonstrated by these tentative estimates is the significance of transportation cost when covering material is imported to the site. This can account for up to two-thirds of total cost where wage rates are very low and one-third of the cost in intermediate countries. Hence the importance of seeking sources of covering material that can be obtained without cost, such as ash from power stations, soil from excavation, and other kinds of inert industrial wastes. In Britain it has often been found that if free disposal facilities are offered to the producers of these useful kinds of wastes, the level of expenditure on the importation of covering material can be greatly reduced.

Also of significance is that a disposal cost at the higher figure of Rs. 7.8/tonne represents only Rs. 1.17/inhabitant/year at the given rate of wastes generation. This is about 15% of current average expenditure on solid wastes



management services in the South East Asia Region of the World Health Organisation; it is a level of expenditure that could be sustained in the poorest countries.

**Mechanised  
Sanitary Landfill  
14.8.**

Earth-moving machines are tractors (i.e. motor vehicles which are designed to operate over unmade ground by means of low ground-loading and high torque) which are equipped with devices for excavating, pushing, lifting and carrying solid materials. They can be classified in two ways: the distance over which they can operate economically and whether they are wheeled or tracked vehicles.

**characteristics  
of machine types  
14.8.1.**

The blade of a bulldozer is designed for pushing: it is concave so that the lower edge of the blade will excavate when depressed below ground level. The blade can be raised above ground for levelling a thin layer of covering material. Because of its very slow speed it is economical only when operated over very short distances, never more than 100 metres.

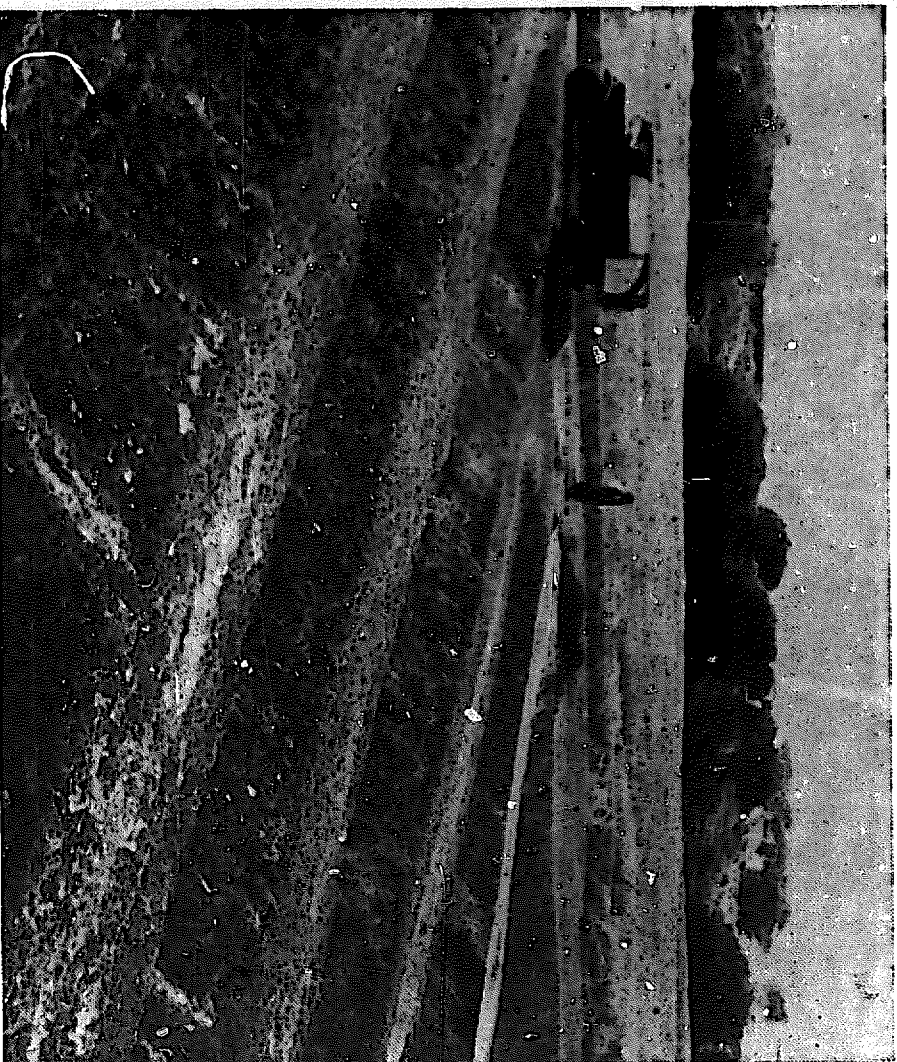
The front-end-loader is a machine with a hydraulically operated bucket, having a capacity between 0.5 and 3 cu m, which is used for excavating, lifting and carrying; it can also be used for pushing, although it is less efficient than the bulldozer. The economical transport range of a tracked front-end-loader is less than 100 metres, but a wheeled loader may be economical up to twice this distance because of its higher speed. At greater distances the front-end-loader is used to load vehicles which shuttle between the point of excavation and the working face.

The scraper, which may be self-propelled or towed by a tractor, is a form of bowl mounted on wheels; the cutting edge of the bowl can be adjusted to operate below the level of the ground over which it is travelling. The material sliced off gradually fills the bowl; the contents can be discharged as a thin layer for covering purposes, or built up into a large heap for storage. Scraper capacities range from 2 to 30 cu m and the economical range of operation is up to 300 metres.

The dragline is a cable-operated bucket carried on a boom. The basic machine is tracked but operates from a stationary position. It is often used for excavating wet material; for example, in the reclamation of marshland the machine would be sited on the raised area and would excavate from the low level, lifting and depositing the excavated material behind it at the upper level. The operating distance of this machine is a function of its boom length.



15. Manually operated sanitary landfill (Britain, 1935). Note the strip formation and the bumper bag at the face.



16. This landfill site shows the steel plates laid on the strip in use.

## tracks or wheels

### 14.8.2.

A track-laying machine has better flotation and traction capacity because its weight is spread over a much greater ground area than a wheeled machine. The latter usually performs well on a landfill site, however, provided it has been fitted with tyres having a protective steel device to reduce the risk of puncture. A wheeled machine has a higher speed than a tracked vehicle and is able to perform more work cycles in a given period.

For bulldozing, tracked machines are preferred; they are more efficient than wheeled bulldozers in excavating and in accurate grading, because of the better flotation.

Wheeled front-end-loaders are very popular because they can transport material in the bucket up to 200 metres; they are also fast and efficient for loading trucks when materials have to be transported over greater distances.

## machines for landfill

### 14.8.3.

The following table shows the probable scale of work to be performed by machines at a sanitary landfill:

*For 100 tonnes/day at initial density 330 kg/cu m*

Essential tasks at all sites:

Formation of delivered wastes*	300 cu m.
Spreading primary cover on wastes	40 cu m.

Additional tasks when cover obtained within site:

Excavating and transporting primary cover	40 cu m.
Excavating and storing topsoil, say	30 cu m.
Total volume to be handled	410 cu m.

Out of a total of 410 cu m to be handled, 340 cu m is short-distance pushing and grading. Thus for 80% or more of the total work a bulldozer is the most suitable machine.

When all covering material, including topsoil, is to be delivered to the site from an external source, then only a bulldozer will be needed. The capacity of a bulldozer for the essential tasks is of the following order:

40 h.p.	100 tonnes/day wastes input
80 h.p.	200 " "
180 h.p.	400 " "

When covering material is to be excavated from the site, it is usually necessary to employ a second type of machine. For heavy duty excavation a tracked front-end-loader is preferred but if vehicles have to be loaded a wheeled loader is better. The performances of these machines vary widely, but the following is an indication of the rate at which vehicles can be loaded:

\* The only significant difference compared with manual methods is that flanks are formed to a slope of 1:3 to permit the machine to drive up and down them in spreading cover.

*Equivalent wastes  
input*

---

0.5 cu m bucket	100 cu m/day	150 t./day
2.0 cu m bucket	360 „	500 „

If a front-end-loader is used to transport excavated material in the bucket, direct to the working face, then output declines in proportion to the distance travelled.

The chart on page 139 has been adapted from a guide to sanitary landfilling prepared by New York State. It is interesting for two reasons: the first is that rising economy of scale appears to cease after about 250 tonnes/day; the second is that until cost rockets below about 50 tonnes/day.

The costs shown on the chart cannot be applied to other countries because of wide differences in labour cost. But the main conclusions are valid for all countries because the capital and operating costs of earth-moving machines, excluding the operator's wages, vary little from one country to another. Thus, for developing countries it would be reasonable to regard 250 tonnes/day as a normal maximum for a sanitary landfill site and, when the wastes production of a city exceeds this level, multiple sites, which are likely to reduce refuse collection cost, could be operated without raising unit cost of disposal. It could also be inferred from the chart that where labour costs are low mechanisation is unlikely to be profitable for intakes under 50 tonnes/day.

At the smaller sites, where the advantages of mechanisation may be marginal, it may be quite practicable to employ a small (0.5 cu m bucket) wheeled front-end-loader as a multi-purpose machine. It is capable of pushing, excavating in light soil, transporting and spreading. It does none of these things as efficiently as specialised machines, but a number of European sites in the 50-100 tonnes/day range have been operated in this way to a tolerable, if not perfect, standard.

The tracked front-end-loader would be a more efficient all-purpose machine, but at a somewhat greater capital and operating cost. The main performance limitation of this machine is in the distance over which bucket loads can be transported, because of its slow rate of travel.

There are too many national and local variations in wages, wastes, energy costs and site conditions to be able to suggest firm costs, but it will be useful to indicate possible cost scale in given situations. The plant operating costs used below are typical for India in 1976 and include

**mechanisation  
in relation to  
scale of operation  
14.8.4.**

**possible  
operating costs  
14.8.5.**

*17. This British site is of interest because the vehicle has very small solid-tyred wheels (1935) but has successfully negotiated the track formed from steel plates.*



*18. Tractors and Trailers in the dry season have no difficulty in travelling over level uncovered wastes. (Colombo)*

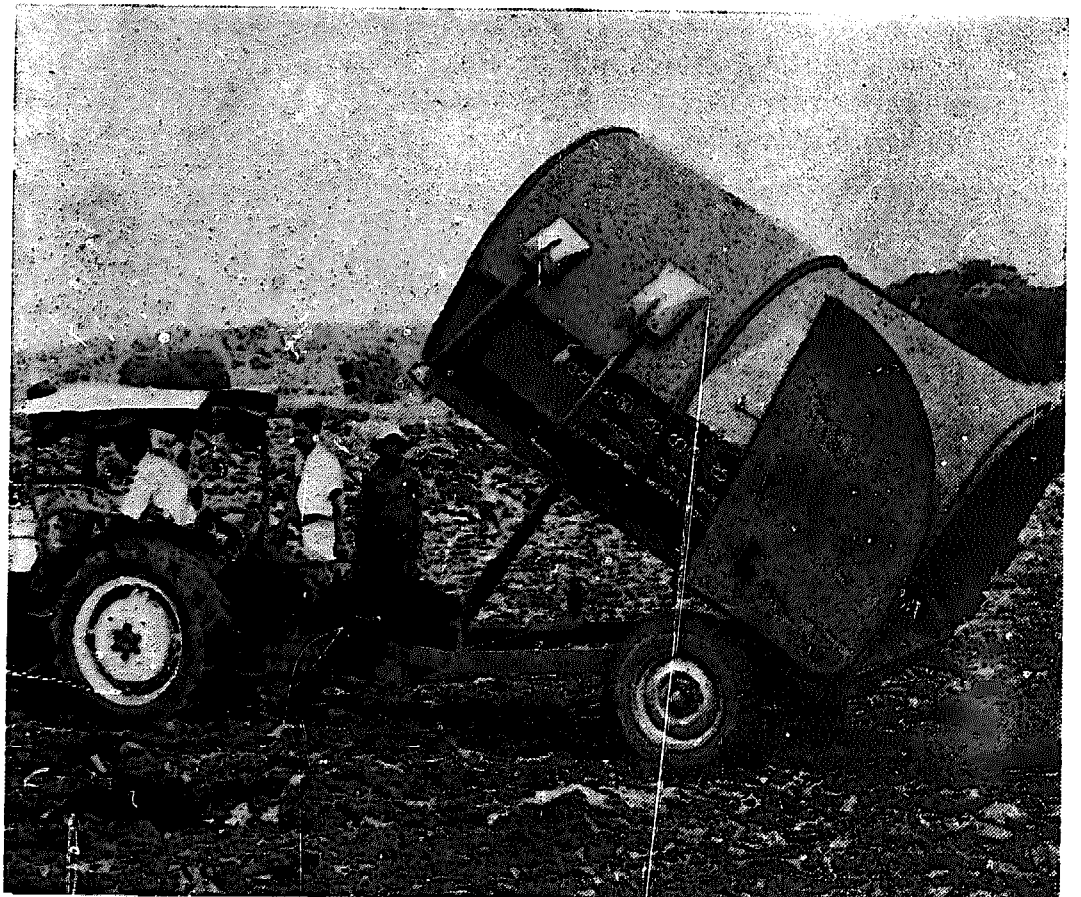
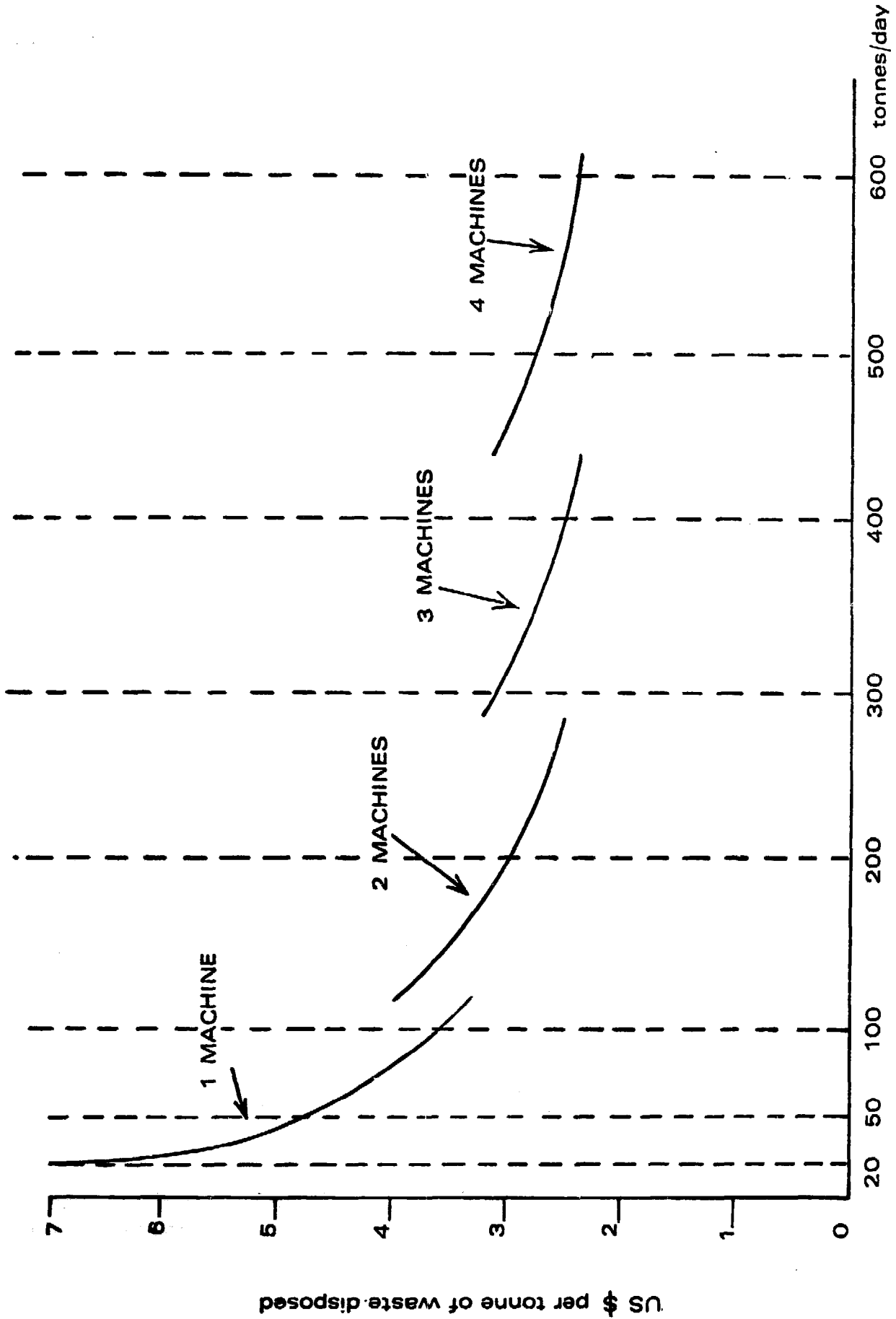


Figure 24

SANITARY LANDFILL, SINGLE OR MULTIPLE MACHINES



Adapted from "Sanitary Landfill", New York State Department of Environmental Conservation. (1971)



amortisation, repairs, fuel and operator. Labour costs are taken as Rs. 15/day inclusive of oncosts.

*250 tonnes/day site* (all cover obtained from within site at a distance not exceeding 600 metres from working face:

	Rs./day
1 — 180 h.p. bulldozer (2.85 lakh/yr.)	950
1 — 2 cu m wheeled f.e. loader (2 lakh)	660
2 — transport vehicles (2 x 50,000)	330
Labourers 10	150
Total cost/day	2,090
Cost/tonne	Rs. 8.36

*50 tonnes/day site* (Ideal conditions such as deep sandy soil which can be excavated for cover immediately in front of face.)

	Rs./day
1 - 0.5 cu m wheeled f.e. loader (80,000/year)	266
Labourers, 3	45
Total cost/day	311
Cost/tonne	6.22
,, ,, if only 20 t./day (1 labourer)	14.05

It is now possible to make a rough comparison between the cost of manual operation given in the preceding chapter and these estimates of mechanised costs.

*Comparative costs summary*      *Cost/tonne*  
(*plant and labour only*)

	Rs.
<b>250 tonnes day :</b>	
Full mechanisation, typical site	8.36
<b>50 tonnes/day :</b>	
Simple mechanisation, easy site	6.22
Manual, cover imported at full cost	7.80
Manual, cover supplied free of charge	1.80
<b>20 tonnes/day :</b>	
Simple mechanisation, easy site	14.05
Manual, cover imported at full cost	9.00
Manual, cover supplied without charge	3.00

What emerges most strongly from these figures is the very high cost increment which has to be added to manual operation when the full cost of importing cover is included. This emphasises the importance of seeking sources of free cover in the form of inert industrial wastes.

The figures also suggest that mechanisation, in good site conditions, may be attractive at 50 tonnes/day or less, under low or high wage rates, provided that a light, cheap, multipurpose machine is employed.

In general it appears that the breakeven point for mechanisation may range between 40 and 100 tonnes/day, according to wage rates and the availability of free cover. In a marginal situation manual operation is recommended on account of its greater operational reliability and higher standard of finish.

Short of an epidemic, manual operation is totally reliable; mechanised sanitary landfills are very unreliable unless spare machines are immediately available to replace those undergoing repair. For large cities operating multiple landfill sites this is no problem because spare machines can be held in a ratio of about 1 : 5. Where only one landfill is operated it may be possible to buy a secondhand machine to hold in reserve, or to retain a machine that has been replaced by a new one. It is often possible to hire machines from a contractor or another public authority. Nevertheless, the most common cause of a sanitary landfill which has gone out of control, in Europe or elsewhere, is a broken-down bulldozer that has not been replaced. Tracked machines being moved from site to site or to repair shops must not be allowed to traverse surfaced roads as the cleats do irreparable damage. Therefore a low-loading trailer is required.

The costs which have been used above are not all-embracing. According to the scale of operation and the characteristics of the site, there will be charges for protective engineering measures, site development costs such as access road, control area and buildings, materials such as hardcore, paper screens and tools, and overheads.

For a site having a long life, engineering cost can have a surprisingly small impact. For example a site receiving 100 tonnes/day over a period of 10 years would dispose of 300,000 tonnes of wastes. If an initial capital expenditure of Rs. 500,000 was necessary, this would be equivalent to only Rs. 1.60/tonne of wastes disposed of. In most cases a substantial proportion of expenditure of this kind is of continuing value in the ultimate use of the reclaimed site.

In this section some particular aspects of sanitary landfill—such as problems of water-filled sites, trenching methods in desert soil and organization of salvaging—are discussed.

It is quite common to find that a low-lying site which is hydro-geologically safe because of impermeability contains a body of static water caused by precipitation and surface drainage. It has been accepted that only inert wastes should be deposited in water because of aerial pollu-

#### **Particular Aspects of Landfills 14.9.**

##### **water-filled sites 14.9.1.**



tion from hydrogen sulphide which would be caused by the deposit of water of organic wastes.

Experiments to control aerial pollution caused by decomposition of wastes deposited in water have shown that the problem increases in relation to ambient temperature; the risks are probably much greater, therefore, in tropical than in temperate countries.

Impermeable water-filled depressions can be pumped dry after which filling can proceed as for a normal site. When the water area is very large, lagooning is recommended. The water-filled area is divided by bunds formed from inert wastes into areas of 0.5 Ha or less. Each lagoon in turn is pumped dry and filled.

**ravines**

**14.9.2.**

Sometimes it is desired to fill narrow, deep ravines. Conventionally a road should be cut to within 2 m. of the lowest level, but the cost may be excessive in solid rock. One site was seen where a ravine 30 m wide by 20 m deep was filled in a single layer. The top surface of the wastes was covered with 20 cms of soil at the end of each day, but it was impossible to cover the working face. The rate of input, however, was high enough to advance the face several metres/day so that all wastes were covered daily by new wastes. The prevailing temperature was about 22°C, but there was no evidence of fly breeding on the site, presumably because the sides of the fill were enclosed by rock and the top by earth, and the period of exposure of wastes on the face was too short for larvae to emerge. This appears to be a situation in which some of the rules can safely be broken. Care should be taken to ensure that water supplies are not endangered by fissures in the rock. More than the usual amount of long-term settlement should be expected in such deep fills.

**desert sites  
and trenching method**

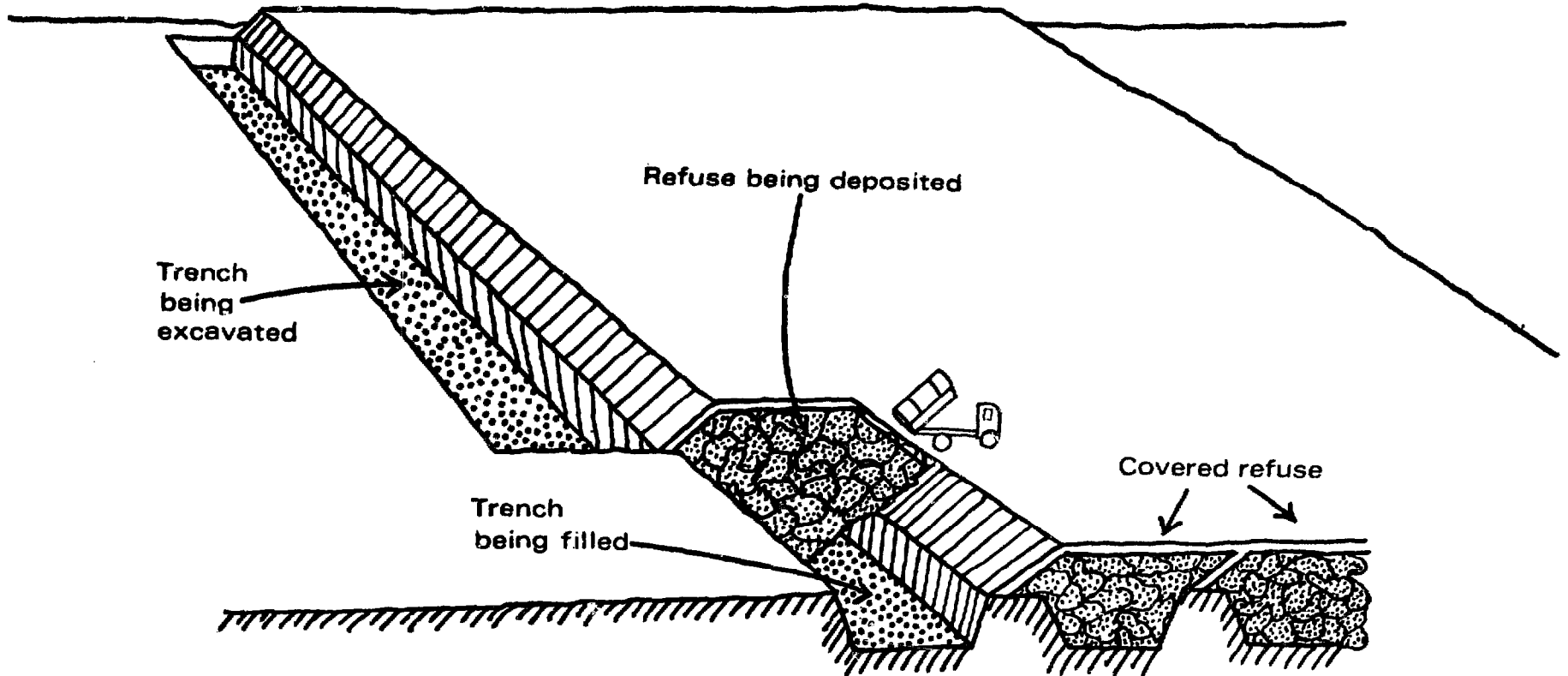
**14.9.3.**

Deserts where the soil is very deep and is free of rock out-crops lend themselves to sanitary landfill by trenching. The writer has no practical experience of this method, which was developed and widely used in USA, and the following description is taken from "Sanitary Landfill" (American Society of Civil Engineers, Manual No. 39, 1959).

*"The trench method is most often used when flat or gently sloping land areas are available. It is adapted for use on terrain which can be trenched by normal earth-moving equipment, preferably without intersecting groundwater...."*

*"Construction of a trench fill is begun by digging a trench along one side of the area to be used for the*

Figure 25



TRENCH METHOD OF CONSTRUCTING A SANITARY LANDFILL  
Adapted from "Sanitary Landfill", ASCE Manual on. 39

sanitary landfill, and placing the excavated earth as a berm adjacent to the trench on its limited side. It is desirable that the trenches should be dug so as to be self-draining. Refuse is deposited and compacted in sufficient quantity to fill the trench and to extend somewhat like an area fill to the elevation of the top of the berm. The exposed, or dumping face, stands at the angle of repose of the refuse.

"The fill begins at one end of the trench and develops progressively along its length. It is covered daily with earth dug from an immediately adjacent parallel trench in which the next fill is to be made. The top is given a heavy cover, while the working face is merely closed for the night with a light covering of soil approximately 15 cms thick. When completed, a sanitary landfill constructed by the trench method consists of a series of long, narrow, refuse cells. Below the original ground level the cells are separated longitudinally by ridges or ribs of undisturbed soil, while above the original ground surface sloped or wedge-shaped diaphragms of cover material serve as separators. The top of the finished fill appears as a plane surface of earth at an elevation somewhat higher than the original or surrounding terrain.....

"In cases where trenches and fills are both shallow and the volume of refuse is not large, all operations involved in constructing a sanitary landfill by the trench method may be performed by use of a crawler-type tractor equipped with a front-end shovel attachment. In Columbus, Ga., such equipment is used in digging trenches 1 metre deep and in placing and covering a 1.3 metre refuse fill....

"There is no uniformity of practice regarding the depth and the width of the trench used. .... In some literature it is suggested that trenches be 1 metre or more in depth and from 2 metres to 5 metres wide. However, some cities use much deeper and somewhat wider trenches....cities in California use trenches from 2 m to 4 m deep and from 4 m to 7 m wide. Separating ridges vary from 1 m to 4 m.....

"It is general practice to use all of the soil excavated from a trench to cover the refuse deposited in the previous adjacent trench. ....available cover material is usually sufficient to provide a final cover of from 1 m to 1.3 m of compacted soil on the top of the refuse cell, and from 0.6 m to 1 m on the slope which forms the transverse wall of the cell.... excess cover material

may be used...to cover an area full of rubbish at a separate site."

The manual method of operating sanitary landfill as described earlier is usually appropriate to the needs of villages and small towns. For example one man could operate the system on a scale of 3-5 tonnes/day, digging all necessary covering material from the toe of the flanks; this would be equivalent to a population of 5,000 to 10,000.

It has sometimes been suggested that a regional authority could serve the needs of scattered communities by operating a trench digging service if the terrain was suitable. An excavator would be taken from site to site on a low-loader, it would excavate a trench at each site with a capacity sufficient to contain the wastes of the community until it returned, perhaps several weeks later. At each site a man would be employed full-time or part-time, according to need, and he would use the excavated material at the side of the trench for covering wastes tipped into it.

Scavengers are usually attracted in large numbers to uncontrolled dumps where the wastes are exposed and easily picked over. At sanitary landfill sites, however, only the wastes on the working face are accessible, and it is much easier to prevent scavengers from operating.

Salvaging by employees, however, is still practicable, and if they are permitted to sell the recovered materials on their own behalf salvaging may take precedence over other aspects of work and the situation may get out of hand. The following extracts from a report on a sanitary landfill site illustrate this problem:

*"..the project has been excellently conceived and planned....the first section has been filled in two layers....the surface was level and totally covered.....(but) the site was heavily littered with wind-borne litter....Enormous exposed heaps of salvaged materials were stored on the raised section: tins, cardboard, bottles, dirty mixed paper, and mattresses. These materials were heavily infested with houseflies, and the tins and dirty paper contained large amounts of putrescing matter which would encourage oviposition. Fly breeding was occurring on a large scale...."*  
*"Incoming refuse was being deposited in a series of heaps on the covered surface extending backward 50 m or more from the face. This was apparently done deliberately in order to spread the refuse over a large area to expose it to the maximum extent for hand-picking of salvage. The disadvantages of this are:*

**small communities  
14.9.4.**

**salvage  
at landfill sites  
14.9.5.**

- work of the bulldozer is increased as refuse has to be moved over a greater distance,
- fine organic matter containing fly larvae are left behind on the covered surface, and pupate,
- litter such as plastic sheet is left behind and spoils the appearance of the covered surface.”

This situation is not at all uncommon and the best way to avoid it is to organise the salvaging as part of the operation. A system which worked well in Britain with manual landfill operation was as follows :

All recovered materials were sold by the city and 25% of the income was distributed between the men employed at the site as a bonus to encourage their co-operation.

All salvaging took place on the sloping working face during the process of levelling the wastes by drag. All the materials picked out were immediately placed in boxes at the toe of the face, and full boxes were taken to a salvage store.

In this store, paper was immediately baled in a hand baling press, making bales of 60-100 kg.

A trailer was provided for the storage of cans and this was towed to a merchant every 3 days, before flies could breed.

If necessary the salvaged materials were sprayed with insecticide.

Salvage was sold only to approved outlets, for example rag merchants or bottle merchants having satisfactory cleansing facilities.

**Model Code of Practice 14.10.** With a master plan for disposal sites, a plan of operation and a detailed schedule of operating practice, a fairly effective model code of practice could be laid down.

#### A. MASTER PLAN FOR WASTES DISPOSAL SITES

1. *The solid wastes management agency* should identify:

- sources of solid wastes within its area,
- rates of wastes generation,
- constituent analyses and densities of wastes,
- projections for at least 10 years for population growth, wastes generation and characteristics,

and should make outline plans and comparative cost estimates for viable alternative disposal methods.

2. *The land-use planning agency* should review the area within the city boundary, and up to 10 kms outside

the boundary where necessary, and identify sites, man-made or natural, which would be *improved* by landfilling. The planning agency will evaluate potential sites in terms of:

- ultimate use after filling: parks, playgrounds, sports grounds, agriculture, industry,
- the quality of environmental improvement which would result from filling,
- risks of pollution transfer during filling,
- ecology of the area,
- social and economic factors,

and will submit selected sites to the water and river authorities.

3. *The water supply and river authorities* will evaluate potential sites in relation to the hydro-geology and drainage of the area, and will reject sites where underground sources of water would be at risk. Where appropriate the water and rivers authority will define the measures that must be taken to avoid pollution of surface water and to control the production of leachate

4. The solid wastes management, land-use planning, and water and river authorities should maintain a continuing relationship with the aim of ensuring a 10-year rolling programme of landfill sites.

## B. PLAN OF OPERATION

1. *Site survey.* Each selected site should be surveyed and a plan prepared on a scale of about 1:2,500 showing:

- water courses,
- 2 m contour lines,
- boundaries,
- buildings within 200 m of the area to be filled,
- approach routes,
- prevailing wind direction

2. *Site protection plan.* Detailed plans will be prepared for the execution of (inter alia) the following engineering works:

- diversion of surface drainage,
- culverts,
- formation of bunds,
- pumping out of static water.

3. *Site operation plan.* The site operating plan will designate:

- area to be filled,
- depth of fill and total volume,
- grading of final levels,

- depth and quality of final covering material, in relation to the ultimate use of the site,
- any necessary improvement of external roads,
- location and specifications for internal roads,
- where appropriate, a specification for fencing and gates,
- the design of the control area and facilities which may include:
  - office,
  - welfare,
  - garage,
  - stores,
  - site designation and information board,
- soil stripping programme and stockpile areas,
- sources of covering materials, internal and imported,
- filling programme in precise terms such as numbered strips and direction of filling for each layer,
- fire control measures,
- rodent control measures,
- use of insecticides,
- designation of reserved area near entrance for deposit of wastes during emergencies.

### C. OPERATING PRACTICE.

1. *Unloading wastes.* Wastes should be delivered in tipping vehicles and they should unload only at a defined "working face". For manual operation the unloading point should be immediately over the working face or within 2 metres; during mechanised operation an unloading area up to 15 metres back from the face is necessary to permit a bulldozer to operate.

2. *Approach to the working face.* The approach to the working face should be made safe for vehicles by covering the necessary area with steel sheets, old railway sleepers, or a sufficient thickness of "hardcore", unless the character of the wastes is such that they can support a vehicle without these measures. The width of a prepared approach should be single or multiple track according to the frequency of traffic movements.

3. *Formation of wastes.* Wastes unloaded at the working face should be formed into a continuous embankment 2 metres high, and having a width of approximately 6 metres per vehicle when more than one vehicle has to unload at the same time. The side slopes (or flanks) of the strip being filled should be 45° for manual operation or 30°, or less, for mechanised operation.

4. *Covering of formed wastes.* The top surface and the flank(s) of the strip being formed should be covered progressively with a layer of soil or other suitable sealing material not less than 20 cms thick. This should be beaten flat and smooth if applied manually, or consolidated by repeated traverses if a machine is used. At the end of every working day, covering should be completed on the top and flank(s) of the fill. At intervals, which may be daily, or not less frequent than weekly, the forward slope of the working face is to be formed and covered in the same manner as described for the flanks, in order to achieve a cellular construction.

5. *Deep sites.* If the required total depth of fill exceeds 2 metres, then the site will be filled in multiple layers, and to facilitate natural settlement and the dispersal of gases, a long interval, never less than three months, should be allowed to elapse before one layer of wastes is covered by another.

6. *Hollow articles.* Articles such as large hollow containers should be crushed by being placed in the path of a tracked machine, or should be put at the toe of the working face, in an upright position, and filled with other wastes. This is to minimise the creation of voids within the fill, which would lead to uneven settlement.

7. *Offensive wastes.* Any load which consists mainly of fish wastes, abattoir wastes, carcasses of animals or medical wastes\*, should be deposited at the lower level, immediately in centre front of the advancing face, and should be covered with other wastes so that no part of the offensive wastes is within one metre of the top surface of the fill, and is not less than 2 metres from a flank.

8. *Litter control.* Portable wire mesh screens should be erected in an arc of sufficient length to trap airborne litter blown from the working face.

9. *Manning levels.* Adequate staff should be provided to ensure compliance with all requirements of this Code. For manual formation of the fill, and the spreading of covering material delivered to the working area, not less than 2 labourers for the first 10 tonnes/day and one labour-

\* Hospitals and clinics should be equipped with properly designed incinerators for the treatment of pathological wastes and sanitary landfill should not be regarded as a normally acceptable disposal method for such wastes. In the absence of proper facilities the above method may be used provided that the wastes are delivered to the site in impermeable disposable packages which are not opened. Hypodermic springes should always be broken before being discarded.



er for each further increment of 10 tonnes/day are necessary. Additional staff must be provided to keep the whole of the site clean, including the removal of litter from screens and the daily removal from the surface of all hollow articles such as cans and motor tyres which may have been dropped accidentally. Further staff are needed for traffic control, inspection for rodents etc.

10. *Welfare facilities.* Staff required to stand in wastes should be supplied with protective clothing: boots, gloves and overalls, for which suitable laundry arrangements should be made. Washing and toilet facilities should be maintained in clean condition.

11. *Salvage.* Only organised and controlled salvaging should be permitted and must be confined to the sloping forward surface of the working face. Portable containers are to be provided to contain salvage which has been picked out of the wastes, and full containers should be immediately transferred to an enclosed store or to a vehicle.

12. *Fire.* No fires are to be started deliberately. An emergency supply of water should be available and staff must be trained in fire control.

13. *Dust control.* When necessary, dusty roads will be sprayed with water or an alternative treatment, such as the application of used engine oil, will be adopted.

14. *Vector control.* A daily inspection will be made and the location of rodent burrows or insect infestations will be recorded and appropriate control measures taken. Salvage stored on a site for periods exceeding two days will be sprayed with insecticide daily.

15. *Progressive cultivation.* As soon as a convenient area has been raised to the final level and covered with topsoil, it will be brought into cultivation by sowing grass or another suitable crop, in order to prevent the establishment of weeds, and also to preserve the visual amenities of the area.

## CHAPTER 15.

### URBAN WASTES AS A SOURCE OF COMPOST

In nature, dead vegetable and animal matter is decomposed, where it happens to fall, by bacteria; the products of decomposition add to the fertility of the soil by improving its physical properties for the support of plants, and by the provision of plant nutrients. A similar process takes place with animal excrement, and throughout history, until the invention of artificial fertilisers, farmers have been dependent upon organic manures, derived from animal excrement and decayed vegetation, for the maintenance of soil fertility. There are many parts of the world, particularly villages in tropical and sub-tropical regions, where farmers still rely almost entirely on organic manures.

#### Introduction 15.1.

A major constituent of domestic solid wastes is dead animal and vegetable matter, mainly in the form of kitchen wastes and garden wastes. Urban areas generate domestic and shop wastes on a large scale, between 300 and 800 gms/person/day. At the mean of this range, a city with a population of one million would generate over 500 tonnes/day. At least 25% and up to 75% of this weight comprises vegetable and putrescible matter.

Over the past 50 years the disposal of such urban wastes has become an increasingly difficult problem: landfill has always been the most common disposal method and is likely to remain so, but when sites close to a city have been filled up additional expenditure is necessary to transport the wastes to more distant sites. Thus it has become more and more important to discover treatment methods which reduce the volume of wastes to be accommodated on scarce landfill sites. Incineration is an effective solution, but it is expensive for any kind of waste and it is most expensive for wastes having a high proportion of vegetable and putrescible matter, because this implies a high moisture content and a low calorific value.

It is natural, therefore, that the possibility of converting urban wastes, or a substantial proportion of them, into organic manures, should have attracted interest over

many years. Such a process is known as composting and has two essential features:

- the use of methods and equipment which facilitate decomposition of the organic content under controlled conditions, so as to avoid risks to health or the environment, and
- the extraction of constituents of the wastes which would be undesirable in the compost; some of these may be saleable.

Thus a composting process usually has three products:

- compost for use as an organic fertiliser,
- salvaged materials which can be sold for re-cycling,
- "contraries", which are of no value and must be disposed of by landfill, but which rarely exceed 20% of the original weight.

If composting can be operated successfully, and this requires a number of pre-conditions which will be discussed later, it achieves the following highly desirable results:

- conservation of resources by re-cycling,
- support for nature's cycle by returning to the earth dead animal and vegetable products,
- reduction of landfill space requirement.

**Character and Use  
of Compost**  
15.2.

The aim of composting is to convert a major proportion of solid wastes into a marketable product. It is necessary to begin, therefore, with some understanding of the properties, and the limitations, of compost.

**qualities**  
15.2.1.

Compost is a brown, peaty material the main constituent of which is humus. It has the following physical properties when applied to the soil:

- the lightening of heavy soil,
- improvement of the texture of light sandy soil,
- increased water retention,
- enlarging root systems of plants.

Compost also makes available additional plant nutrients in three ways:

- it contains N, P and K, typical percentages being N, 1.2%; P, 0.7%; K, 1.2%; but with fairly wide variations,
- when used in conjunction with artificial fertilisers it makes the phosphorus more readily available and prolongs the period over which the nitrogen is available, thus improving nutrient take-up by plants;
- all trace elements (micro-nutrients) required by plants are available in compost.

**method of use**  
15.2.2.

Compost is applied to land at a rate of between 20 and 100 tonnes/Ha./year. It is commonly used at 40 tonnes/Ha. and for most composts this is equivalent to between 400 and 500 kg N/Ha. Usually it is applied between harvesting one crop and sowing the next and ploughed in; it can also

be used as much to assist moisture retention and inhibit weeds, in which case it is not ploughed in until the harvest.

Forty tonnes of compost may occupy a volume of 60 cu metres, thus its application to farmland involves substantial labour cost. Where mechanised farming is practiced, manure-spreading machines have been found to operate effectively with compost.

Because the time of applying compost is determined by the cropping cycle, demand is usually seasonal, thus a compost plant may require storage capacity for its product for several months.

There are two situations in which the production and use of compost may be of great importance to the agriculture of an area :

- for bringing into cultivation marginal land suffering from organic deficiency; such areas are most common in tropical climates where hot sunshine tends to destroy organic matter;
- in areas where artificial fertilisers are in short supply or are very expensive.

In relation to agriculture as a whole, these situations are exceptional. (Examples of the former can be found in West Asia where composted urban wastes, usually in combination with irrigation schemes, have been used as a source of humus to aid cultivation of former desert areas; India and China provide examples of countries which tend to use composts primarily, but not exclusively, as a source of nutrients.)

In most agricultural situations, however, organic soil deficiency is not apparent, and farmers are conditioned to the use of artificial fertilisers, the nutrient content of which is known with certainty, unlike composts which may vary widely from batch to batch. Thus, although compost has different properties from artificial fertilisers and is, in fact, complementary to them, it usually has to be marketed in competition with them, for farmers have a limited budget for fertilisers.

It is necessary, therefore, to satisfy two requirements before compost will be accepted into regular use by a farming community :

- it must be demonstrated beyond question that the use of compost produces larger crops of better quality than is possible by the use of artificials alone;
- the price of the compost must be low enough to compensate for its higher transport cost and the greater labour cost of applying it to the land, but the price can also reflect at least part of the value of the nutrients in terms of equivalent artificials.

**place of compost  
in agriculture  
15.2.3.**

**importance  
of agricultural  
authorities  
15.2.4.**

It will now be apparent that there are two parties involved in a policy of composting urban wastes :

— the agricultural authorities who should determine the extent to which compost may be required for organically deficient areas, or as a primary source of nutrients, or for agricultural use in general;

— the solid wastes management authority whose function is to collect the wastes and produce from them the necessary quantity of compost.

It follows, therefore, that composting should never be undertaken by a city without detailed consultation with, and strong support from, the appropriate agricultural authorities, who may be federal or state ministries, or a farming co-operative. It is they who should carry out market research, judge the compost in relation to soil characteristics and agricultural methods, run demonstration projects, and give practical assistance with distribution and sales.

Success or otherwise is dependent upon agricultural support. For example, in Britain composting is of negligible significance in the disposal of solid wastes because the Ministry of Agriculture has stated that urban composts are not required: adequate amounts of organic manures are produced within the farming industry itself. In contrast, the Indian Ministry of Agriculture is subsidising city compost plants and assisting a strenuous marketing policy primarily because it wishes to reduce expenditure of scarce foreign exchange on imported artificials, although it also recognises the value of the organic properties of compost.

**solid wastes  
management  
and agricultural  
needs  
15.2.5.**

The objective of the solid wastes management authority is to dispose of the collected wastes; it will seek to minimise the cost of treatment and to limit the extraction of "contrary" materials to those which are actually harmful (as distinct from those, such as sand, which are merely adulterants). The agricultural authorities seek the best product for soil conditioning and plant nutrition; they would prefer to exclude inert matter, and perhaps to supplement N, P and K proportions to a guaranteed level, all of which would increase the cost of treatment. Thus, although it is essential that both parties co-operate closely if composting is to succeed there is a potential area of conflict between their individual objectives.

It is not possible to lay down any rules on this issue, but experience tends to show that the most consistently successful plants are those that produce a low-cost product by simple methods, always provided that harmful elements are eliminated and that the compost is attractive in appearance.

The character of the constituents of solid wastes have to be analysed to determine how suitable they are for composting.

**physical  
constituents  
15.3.1.**

Before considering a composting project it is necessary to carry out a physical analysis of the wastes, using reliable sampling methods. Although similar constituents occur in solid wastes throughout the world, there are wide variations in relative proportions, not only as between countries, but even between regions within a country. The following table, which compares Indian wastes with those of Europe and Central America illustrates the importance of adapting composting systems to match wastes characteristics :

<i>Constituents</i>	<i>% by weight</i>		
	<i>Indian</i>	<i>Mexican</i>	<i>British</i>
<b>Essential to compost :</b>			
vegetable-putrescible	75	55	28
<b>Acceptable for composting :</b>			
paper	2	15	37
inert below 10 mm	12	0	9
<b>Compostable total</b>	<b>89</b>	<b>70</b>	<b>74</b>
<b>Salvageable constituents :</b>			
paper (also included above)	2	15	37
metals	0	6	9
glass	0	4	9
textiles	3	6	3
plastics	1	4	3
<b>Total of potential salvage</b>	<b>6</b>	<b>35</b>	<b>61</b>
<b>Contraries :</b>			
misc. combustible	0	2	1
misc. incombustible	7	6	1
<b>Total of contraries</b>	<b>7</b>	<b>8</b>	<b>2</b>

In this table paper has been included in both the compostable and salvageable categories; it is likely that some proportion of it would be salvaged. The practical recovery rate for saleable constituents ranges between 20% and 60% of the potential figures above. When a correction is made for these factors, the following realistic summary emerges :

<i>Final destination of constituents</i>	<i>Indian</i>	<i>Mexican</i>	<i>British</i>
<b>Compostable*</b>	<b>88</b>	<b>65</b>	<b>64</b>
<b>Salvageable</b>	<b>2 or less</b>	<b>15</b>	<b>22</b>
<b>Contraries, including salvage not recovered</b>	<b>10</b>	<b>18</b>	<b>14</b>

\* in terms of essential and acceptable constituents

**potential  
compost production**  
15.3.2.

From the physical analysis described in the preceding section it is possible to arrive at an estimate of the weight of compost which could be produced from each tonne of wastes. For the Indian wastes the estimate would be as follows:

Each tonne of wastes received contains	880 kgs compostable matter.
@ 50% moisture content	= 440 kgs dry matter
Loss of volatiles during decomposition	45 kgs
	= 395 kgs dry matter in compost
Assume an extraction efficiency of 90% for the 120 kgs of other wastes	= 12 kgs contraries and salvage in compost
	= 407 kgs dry compost.
Assume 25% moisture content of compost at time of sale	136 kgs water
Compost produced/tonne waste	= 543 kgs.
	say 50% of intake.

**carbon-nitrogen  
ratio**  
15.3.3.

On the analysis depends the initial carbon/nitrogen ratio. Bacteria use carbon as an energy source and nitrogen for cell building, thus the process of decomposition involves the reduction of the relative proportions of these elements, known as the C/N ratio, from an original level which may range from 20:1 to 70:1, to a point where the available carbon has been consumed and activity ceases. The final C/N ratio usually lies between 15:1 and 20:1, but may be higher if the initial ratio was near the top of the range.

The initial C/N ratio is a deciding factor in the speed at which decomposition takes place. The ideal initial ratio is between 30:1 and 35:1; if it exceeds 40 the time required increases considerably. Ratios below 30:1 are undesirable for a different reason: there may be excessive nitrogen losses.

In the solid wastes analyses above, the main source of nitrogen is the vegetable/putrescible matter which has a C/N ratio of about 24:1, and paper is the main source of carbon. Thus the higher the ratio of paper to vegetable/putrescible matter the higher the C/N ratio. For composting purposes the Indian wastes are probably below optimum C/N ratio and would be improved by the addition of carbonaceous material. The British wastes are considerably above the optimum level and their composting time will be excessive unless nitrogenous matter can be added (sewage sludge has been used for this purpose).

## CHAPTER 16.

### PRINCIPLES AND ECONOMICS OF COMPOSTING

A composting process seeks to harness the natural forces of decomposition to secure the conversion of organic wastes into organic manure. The purposes of controlling the process are:

- to make it aesthetically acceptable;
- to minimise the production of offensive odours;
- to avoid the propagation of insects or odours;
- to destroy pathogenic organisms present in the original wastes;
- to destroy weed seeds;
- to retain the maximum nutrient content, N, P and K;
- to minimise the time required to complete the process;
- to minimise the land area required for the process.

**Principles  
of Composting  
16.1.**

There are two main groups of organisms which decompose organic matter:

- anaerobic bacteria which perform their work in the absence of oxygen,
- aerobic bacteria which require oxygen.

**composting  
organisms  
16.1.1.**

(There are also some facultative organisms than can adapt to either environment.)

Thus two alternative natural processes are available as bases for composting plants. The main characteristics of anaerobic composting are:

- the process is a lengthy one extending over a period of 4-12 months.
- it is a low temperature process and the destruction of pathogens is accomplished by their exposure to an unfavourable environment over a long period.
- the gaseous products of reduction are methane, hydrogen sulphide and other gases with offensive odours.

The main use of anaerobic composting has been in India where for many years it has provided, usually on a small scale, a cheap solution to the combined disposal of solid wastes and nightsoil. These materials are placed in alternate layers in small trenches which are sealed and left undisturbed for many months; the contents are then dug



out and used as compost. This, the Bangalore system, is now being abandoned in favour of aerobic methods because of the very large land area required owing to the long retention period. In other respects, however, it is a low cost system as the amount of materials handling required is much less than for aerobic methods.

Aerobic composting is characterised by :

- rapid decomposition, normally completed within two to four weeks,
- during this period high temperatures are attained which achieve speedy destruction of pathogens, insect eggs, and weed seeds,
- so long as aerobic conditions are maintained, no offensive odours are produced.

All current composting systems aim to maintain aerobic conditions throughout the process. Many types of organism assist: bacteria, which predominate at all stages; fungi, which often appear after the first week; and actinomycetes, which assist during the final stages.

The process begins at ambient temperature by the activity of mesophilic bacteria which oxidise carbon to  $\text{CO}_2$ , thus liberating large amounts of heat. Usually the temperature of the wastes reaches  $45^\circ\text{C}$  within two days, and this represents the limit of temperature tolerance of the mesophilic organisms. At this point the process is taken over by thermophilic bacteria and the temperature continues to rise. Most of the thermophilic phase, which lasts about two weeks, takes place in the temperature range  $55^\circ\text{C}$  to  $70^\circ\text{C}$ ; should the temperature increase beyond  $70^\circ$  activity temporarily declines. This process is dependent, of course, on the provision of a suitable environment for the bacteria; in addition to the nutrients provided by the wastes the main requirements are adequate supplies of air and moisture.

*It is important to stress that urban solid wastes, of the character described above, already contain at the time of collection all the organisms required for every phase of aerobic composting. Inoculants, whether of selected bacteria or nutrients, are totally unnecessary; numerous comparative tests by universities have revealed no differences in either the speed of composting, or the quality of the product as between inoculated and untreated wastes.*

## **moisture content**

### **16.1.2.**

Moisture content is a critical factor in aerobic composting: for the type of wastes now being considered the following are the main requirements:

- if water content falls below 40% the speed of the process declines,
- if it falls below about 20% decomposition ceases,
- if it exceeds 55% water begins to fill the interstices bet-

ween the particles of wastes, reducing interstitial oxygen and causing anaerobic conditions; this results in a rapid fall in temperature and the production of offensive odours.

Indian wastes of the analysis given earlier probably fall within the optimum range of initial moisture content and are unlikely to require the addition of moisture during the first few days. During the thermophilic stage, however, the high temperature causes rapid loss of water and this must be replaced from time to time until the final fall in temperature. At this point it is desirable to allow the moisture content to decline to 25% in order to minimise the weight of material to be transported to the farm.

Should the moisture content accidentally exceed the maximum required level, for example, as a result of continuous heavy rain on exposed wastes, it is necessary to provide conditions under which the excess moisture will evaporate rapidly, and to aerate the wastes more frequently. This can be achieved by more frequent turning.

The initial moisture content of European wastes may be as low as 30% because of the high proportion of paper in relation to vegetable/putrescible wastes, thus the addition of moisture is necessary before composting can commence at full speed. For many years it has been a common practice to employ sewage sludge instead of water for the following reasons:

**sewage sludge  
as a source  
of moisture  
16.1.3.**

- the sludge is a source of additional nutrients, particularly nitrogen,
- the low C/N ratio of sludge, 6:1, helps to reduce the very high initial C/N ratio of European wastes, thus speeding up the process,
- this was an attractive solution to an otherwise difficult problem of disposing of sewage sludge.

The use of sewage sludge for this purpose is now being seriously questioned because of the possibility of transferring heavy metal toxicity to the compost, the source of these heavy metals being industrial effluents.

Even if it is certain that there is no risk of toxicity from sewage sludge, its use has disadvantages under the following conditions:

- when the initial C/N ratio is within the optimum range, because if the ratio is unduly depressed, there will be increased nitrogen loss during composting,
- when composting is carried out in the open air, because the sludge will give rise to offensive odours, and if raw, may cause health risks to workers.

In general it would appear that the use of sludge in Indian composting is unlikely to confer any measurable advantage, and may give rise to some undesirable consequences.

**aeration**  
**16.1.4.** Although a vast amount of research has been carried out to determine the quantity of air required by decomposing solid wastes, little of practical value has emerged. It has been demonstrated that oxygen demand is greatest at the beginning and declines as the process nears completion, and that an increase in moisture content imposes a need for more oxygen. But attempts to quantify oxygen requirements have provided such diverse results as to suggest that there is a wide range of oxygen need depending upon such factors as the detailed composition of the wastes and the average particle size.

Thus in most composting plants it is necessary to rely upon the experience of the operator, rather than any form of scientific monitoring, to determine the adequacy of aeration. Perhaps it is fortunate that the onset of anaerobic conditions is immediately signalled by offensive odours; should they appear, remedial action is seldom difficult.

**health aspects**  
**16.1.5.** Although there is some evidence to suggest that mesophilic composting, below 45°C, is more rapid and efficient than the thermophilic stage, which may reach 70°C, there are practical difficulties in trying to limit the process to the former type of organism. Of greater importance, however, is the fact that the high temperatures of the thermophilic phase are necessary to achieve the destruction of pathogens, insect eggs and larvae, and weed seeds. This is accomplished, with an adequate margin of safety, provided that every particle of the wastes is exposed to a temperature of 60°C for a few hours.

To attain such a temperature in the centre of the mass present no difficulty; but to ensure that it applies to every particle does present problems except when the wastes are being treated within a totally enclosed vessel. Thus an important aspect of the management of a composting process is to ensure that such problems are overcome; this will be discussed in some detail later.

**Compost Control**  
**16.2.** There are a number of physical requirements for the control of the composting process.

**uncontrolled decomposition**  
**16.2.1.** The need for close control of the process of decomposition is best illustrated by the sequence of events in an uncontrolled heap of urban solid wastes:

(1) For several days it undergoes a mesophilic stage based on the original supply of interstitial air, and as the temperature rises insect eggs hatch.

(2) For a short period it may enter the thermophilic stage and the internal heat causes insect larvae to migrate to the cooler outer layer.

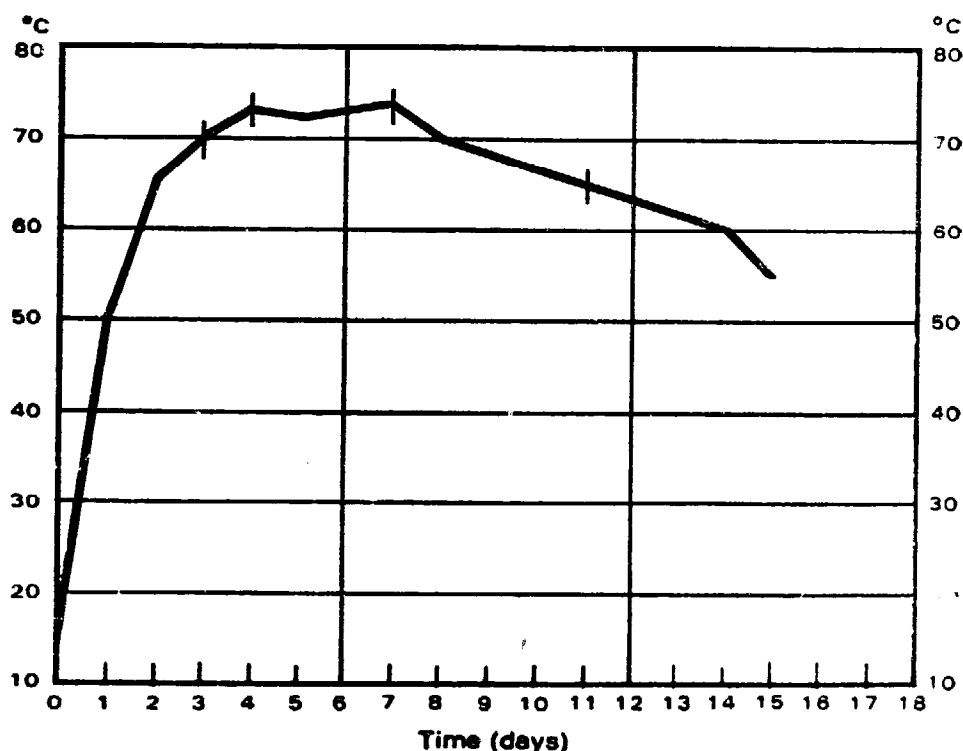
(3) The interstitial air is soon exhausted, however, and aerobic bacteria give way to anaerobic ones; the temperature of the heap declines to ambient.

(4) Meanwhile the larvae in the outer layer hatch into insects and begin to lay more eggs in the exposed wastes.

(5) Rodents enter the heap in search of food and nesting conditions.

Figure 26

TYPICAL TEMPERATURE CURVE FOR A LARGE MASS OF AEROBICALLY COMPOSTING URBAN SOLID WASTES\*



\* Days on which pile was turned

From University of California studies

Reproduced from WHO Monograph No. 31, Gotass

(6) Decomposition is now very slow in the anaerobic centre and may cease in the outer layer because of dehydration. If the heap is disturbed the odour will be offensive; if it is a large heap odour will be apparent at all times.

(7) After many months the centre of the heap will have been reduced to a form of compost. It will be of very low value to a farmer, however, because it is adulterated by bottles, plastics, metals, stones and coarse fibrous materials, some of which may be large enough to interfere with cultivation; others will be dangerous to animals. The outer layers are likely to contain

viable weed seeds and there is no certainty that pathogenic organisms have been eliminated.

(It is worth noting that this is precisely the process that occurs when a city disposes of its wastes by uncontrolled dumping !)

**minimum  
requirements  
for control  
16.2.2.**

From this it follows that the essential features of control are :

- to maintain aerobic conditions; this reduces the period needed for complete decomposition, and provides the high temperatures required to eliminate pathogens etc., and to discourage rodents,
- the removal of all contrary materials.

Thus the following are the minimum requirements for controlled composting :

- (1) Form the wastes into a heap of manageable size; such heaps are called "windrows".
- (2) Break down and reform the windrows at intervals (usually 3 to 7 days) to introduce a new supply of oxygen.
- (3) In the process of rebuilding the windrows place the former outer layer, the temperature of which will be low, in the centre of the new windrow, so that every particle is exposed to high temperature at some stage in the operation.
- (4) Replace lost moisture by sprinkling the wastes with water during the turning process.
- (5) Continue this procedure, usually for 15 to 20 days, until a steady fall in temperature signals the end of the process.
- (6) Should the moisture content accidentally rise above the required level, increase the frequency of turning.
- (7) When the process is complete, separate the contraries from the compost by hand-picking, hand-screening, or mechanical screening, according to the scale of the operation.

**composting systems  
16.2.3.**

The minimum requirements which have been listed form the basis for all composting systems, although additional processes may be added and the order of some of the activities may be changed. Whatever the level of mechanisation and sophistication, almost all current composting systems rely on windrowing for all or part of the decomposition process. They fall into four main categories, set out in order of rising cost :

- windrowing of untreated wastes, followed by separation of contraries;
- windrowing of size-reduced wastes, preceded by separation processes;
- windrowing of size-reduced, separated wastes, which have been partially decomposed within an enclosed vessel;
- total, or almost total, decomposition of pre-treated wastes within a digester.

(a) *Windrowing of crude wastes* : This comprises only the minimum requirements already described. The wastes

are delivered in the collection vehicle direct to the windrow area, which should be paved. The windrows are turned by hand or machine, and watered by a hose. The decomposed wastes are passed through a post-treatment process for removal of contraries before being stacked in a storage area to await sale. The system is practicable only when the initial particle size is relatively small, say 60% under 50 mm, but it has the following advantages :

- the incorporation of coarse materials in the windrows increases the amount of interstitial air;
- both capital cost and energy consumption are greatly reduced by avoiding the size reduction process,
- the removal of contraries after decomposition is cheaper because decomposition reduces the volume of material to be handled by about one third, and the size of plant required is proportionately smaller,
- separation of contraries when the compost has a low moisture content after decomposition is much more efficient than with raw wastes with a high moisture content,
- the contraries, and any salvage that may be recovered at this stage are free of pathogens and present no problems in disposal.

(b) *Windrowing of size-reduced wastes* : This is the most common type of plant in use today and has the following main features :

- (1) Reception and storage; this can take the form of a deep bunker with a grab crane, or a hopper with slat conveyor.
- (2) Elevation to attain sufficient height to enable subsequent processes to be fed by gravity; this usually takes the form of an inclined elevator belt, but sometimes the hopper slat conveyor is inclined and extended outside the hopper.
- (3) Picking belt for the removal of salvage and contraries.
- (4) Overband magnet, for the extraction of ferrous metal.
- (5) Size reduction, normally a hammermill.
- (6) Transport of the shredded wastes to the windrows; this can be by overhead conveyor belts or tractors and trailers.
- (7) Windrow turning system; usually front-end loaders are used, but other machines are available.
- (8) Storage area.

The heart of this type of plant, and the main justification for its added cost, is the hammermill, which reduces the size of the wastes to about 80% below 50 mm. This increases the surface area exposed to bacterial attack and may assist in speeding up the process of decomposition. It also mixes the wastes, destroys most of the fly larvae, reduces the attraction of the wastes to insects, and grinds glass to the equivalent of sand.

Shredding is certainly an essential treatment for the wastes of temperate, industrialised countries, for such wastes contain many objects which would be highly resistant to decomposition, but it may be a questionable re-

quirement in countries where the proportion of vegetable/putrescible matter is very high, and where lower living standards and intensive private salvaging tend to minimise the proportions of salvageable materials and contraries in the wastes.

(c) *Windrowing of partly fermented wastes*: This type of system has all the features of the preceding type, except that instead of a hammermill a very large rotating drum is employed; this has a capacity of several hundred tonnes and the wastes are retained within it for up to 7 days during which the following functions are performed:

- size reduction of most of the constituents is achieved by slow attrition as materials of differing hardness rub together in the rotating drum,
- the wastes are mixed and achieve homogeneity,
- the initial moisture content is adjusted and subsequently the drum is supplied with air under pressure to maintain aerobic conditions,
- the gaseous products of decomposition are withdrawn from the drum and passed through a filter to minimise odours,
- provided that the retention time is adequate, the wastes enter the thermophilic stage so that pathogens are eliminated before the contents of the drum are discharged and delivered to windrows.

Size reduction in the drum is less efficient than in a hammermill and most plants of this type now incorporate screening and pulverisation after the wastes leave the drum, but screening efficiency is low owing to the high moisture content, resulting in some loss of compostible material in the screen rejects.

It is the custom to windrow drum-treated wastes for at least two weeks during which it is turned at intervals.

(d) *Digesters*: The aim of this type of system is to complete the decomposition process within a totally enclosed vessel after passing the wastes through all the separation and size reduction treatments described in (b) above. The vessel can take the form of a vertical silo with multiple floors, the wastes being fed in at the top and being kept in motion by revolving arms. Apertures in the floors allow the wastes to descend through the silo over a retention period of about a week, during which period they are supplied with forced air and the required moisture level is maintained. It is usual to provide post-treatment in order to break up clumps and to remove dense particles. Finally the product is partially dried to prevent further decomposition and it may be supplemented by artificial fertilisers to provide a guaranteed nutrient content before being bagged by machine.

For most cities the capital and operating cost of plants of this kind would be prohibitive. If operated on a commercial basis the selling price of the compost would be so high as to exclude its use for agriculture and the market would therefore be restricted to domestic horticulture. There is an impressive list of failures of such enterprises.

The financial implications of composting is a determining factor in municipal decisions on disposal systems. No city likes to provide a a service which might prove comparatively expensive.

Composting, which combines the recycling of raw materials with the production of organic manure, has a strong ecological appeal. But it is a municipal service, paid for from taxes, and a city will naturally seek to employ the disposal method which offers the lowest cost. Every composting proposal must, therefore, be able to stand comparison on financial grounds with alternative methods of equivalent hygienic standard. The following is a convenient way of setting out a summary of the cost of composting. (The figures used are for example only and have no specific significance.)

<i>Expenditure/income</i>	<i>Rs./tonne of wastes received</i>
Compost plant operating costs including amortisation	50
Disposal of contraries (20% of input x Rs. 10.00/tonne)	2
Transport of compost (50% of input x 20 kms x Rs. 0.7/tonne km.)	7
<b>Total cost of operation</b>	<b>59</b>
<b>Income:</b>	
Sale of salvage (2% of input x average value of Rs. 250/tonne)	5.00
Sale of compost (50 % of input x Rs. 50/t.)	25.00
<b>Total income</b>	<b>30</b>
<b>Net disposal cost of wastes</b>	<b>Rs. 29/tonne</b>

In this hypothetical situation, if the only alternative to composting was incineration at a net cost of Rs. 150/tonne, then composting would be the obvious choice, given adequate assurances on marketing. If, however, sites were available at which sanitary landfill to high standards could be operated at Rs. 10/tonne, composting would impose an unnecessary financial burden upon the city, however great its attractions may be from the agricultural standpoint.

### Economics of Composting 16.3.

#### alternative disposal methods 16.3.1.



**size of a city**  
**16.3.2.**

In an earlier section, the importance of securing a market for all compost was stressed. At the farm, compost must be applied in very large quantities, thus transport between the compost plant and the farm is an important cost element; in most situations this cost limits the marketing range to about 25 kms. If the potential marketing area for compost is a circle of 25 kms diameter and if the plant is in a very large city, much of that circle will be occupied by urban areas; therefore, the larger the city the smaller the potential market for compost. The larger the city, however, the greater the quantity of wastes. Thus composting as a policy suffers the paradox that the potential market is in inverse ratio to potential wastes production.

The consequence is that no major city has ever been able to base its waste disposal policy entirely on composting. The most successful composting plants have been those which serve small towns in agricultural areas and the widest application of composting in the past has been in the form of simple manual methods in villages.

**wage levels**  
**16.3.3.**

Wage rates have a profound effect on two aspects of compost plants :

- the viability of salvage extraction,
- the selection of mechanical or manual handling methods.

The history of the industrialised countries shows that wage rates steadily increase, mainly because of rising productivity and partly by inflation; the market values of salvaged materials, however, rise at a much slower rate and sometimes do not rise at all. For example, in Britain before World War II many municipalities operated salvage plants for the recovery of paper, metals, bottles, textiles, rubber and cinder, and the income from the sale of these materials exceeded the cost of providing conveyor belts, electro-magnets, and baling presses, as well as the labour cost of extracting, sorting and packing the salvage. Thus at that time salvaging on a partly mechanised scale helped to reduce total disposal costs. This is no longer the case, however, because wage levels have risen much faster than salvage values: 1976 wages are probably 15 times pre-war levels, but the selling price of paper has increased only 5 times and the price of glass is unchanged: for most British cities, salvage is no longer profitable.

For every community the viability of salvage extraction at any given time is a function of wage rates and salvage values; these may change significantly over the life of a plant which is normally about 20 years.

On the question of mechanical v. manual methods of operation, the choice is limited to certain specific work

areas. Some level of capital investment is unavoidable: land, paving, and drainage, for example. Some processes are practicable only by mechanical means: pulverisation and ballistic separation in particular. On the other hand there are certain processes for which manual methods may be superior or even essential, for example the sorting of non-ferrous metals. But there are some work areas in which the amount of mechanisation has to be decided in the light of current and forecast wage levels, plant and energy costs, and comparative performances. Windrows can be turned manually or by front-end loaders. If it is known that one man can turn 5 tonnes/day and a front-end loader of a certain size 120 tonnes/day, the comparative costs of 24 men against 1 loader provide the information on which the decision can be made. In making such comparisons allowance is always necessary for the cost of standby equipment required during plant maintenance as well as for labour oncosts arising from welfare facilities and fringe benefits.

It is important to recognise that there may be constraints on energy consumption of two kinds :

- rising energy costs,
- uncertainty of continuous supply.

In a high energy cost area it may be possible to modify plant design to minimise energy consumption. Hammermills of 10 tonnes/hour capacity require at least 150 hp, and up to 350 hp for 20 tonnes/hour capacity, when used for the treatment of raw wastes. However, if hammermills or rasps are used only as a final treatment after decomposition, power requirement is greatly reduced as a result of the structural changes which occur in the wastes during decomposition. Rasping after decomposition was a feature of the V.A.M. process which was used in Holland for many years. If the decomposed wastes are first screened, and only the oversize material passed through a hammermill, the energy requirement may be reduced to 20% or less of that needed for fresh unscreened wastes.

When a large capital investment is made in a composting plant it is vital to ensure that the public power supply is 99% reliable. Cases have been known where seasonal power cuts occur for long periods and this can be intolerable if the compost plant provides the only means of refuse disposal for a city. In some circumstances diesel engines may offer a more reliable energy source.

Mechanised refuse disposal methods were first developed in the industrialised countries and these are still the main suppliers of equipment, particularly items of patented

**energy**  
**16.3.4.**

**indigenous equipment**  
**16.3.5.**

design. Composting plants erected in developing or partly industrialised countries are usually of foreign manufacture and this can involve risks to long-term reliable operation through dependence upon imported spare parts, and may add to maintenance costs if heavy items have to be transported to great distances.

It is recommended, therefore, that a plant should be designed in the country in which it is to be erected and that the design should be based as far as possible on indigenous equipment. Where patents are involved, the possibility should be explored of local manufacture under licence. This applies with special force to items which are rapidly consumed, such as hammers for hammermills, or are subject to sudden damage and require immediate replacement, such as conveyor belts.

## CHAPTER 17.

### ELEMENTS OF COMPOST PLANTS

Storage of wastes has to be related to pre-treatment and collection to provide a continuous flow required for the efficient of operation of a compost plant.

**Storage  
and Elevation  
17.1.**

Whenever wastes are subjected to pre-treatment before entering the decomposition process it is necessary to provide a storage facility to convert batch deliveries of wastes into the continuous flow required for efficient operation of the plant. The storage capacity needed depends primarily upon the relationship between the hours of operation of the collection service and those of the compost plant.

**storage  
capacity  
17.1.1.**

The simplest pattern is when both services operate during a single daily shift and when working hours coincide; in this case storage capacity is decided by the working cycle of the collection vehicles. Unless staggered starting times are used, the whole collection fleet tends to arrive over a short period which occurs two, three or more times a day according to the average number of loads collected per vehicle/day. If the time interval between the arrival of successive waves of vehicles is say two hours, this represents the minimum storage capacity required to contain the wastes delivered by one wave of vehicles; alternatively it represents the minimum store of wastes which will keep the plant in continuous operation. Some allowance is necessary, however, for other factors such as higher delivery rates after public holidays, and temporary plant stoppages. In practice no plant should have less than 4 hours storage capacity; for a plant of 20 tonnes/hour the storage volume should be equivalent to 80 tonnes. For wastes of a density of 330 kg/cu m this would be about 240 cu m.

At the other extreme is the plant which operates continuously, three shifts per day for seven days a week, while the collection service works only a single shift for five or six days a week. In this situation, if allowance is made for public holidays, storage capacity may have to be equivalent to three or even four day's throughput: for a

plant of 20 tonnes/hour capacity this could be as much as 2,000 tonnes. The attraction of such highly intensive plant operation is the reduction of unit operating cost by spreading the capital cost over the maximum throughput. For this reason continuous operation is now normal practice for large incinerators, especially when heat recuperation is practiced. Compost plants, however, rarely operate over more than two shifts for six days a week, and it is seldom necessary to provide more than 10 hours storage capacity.

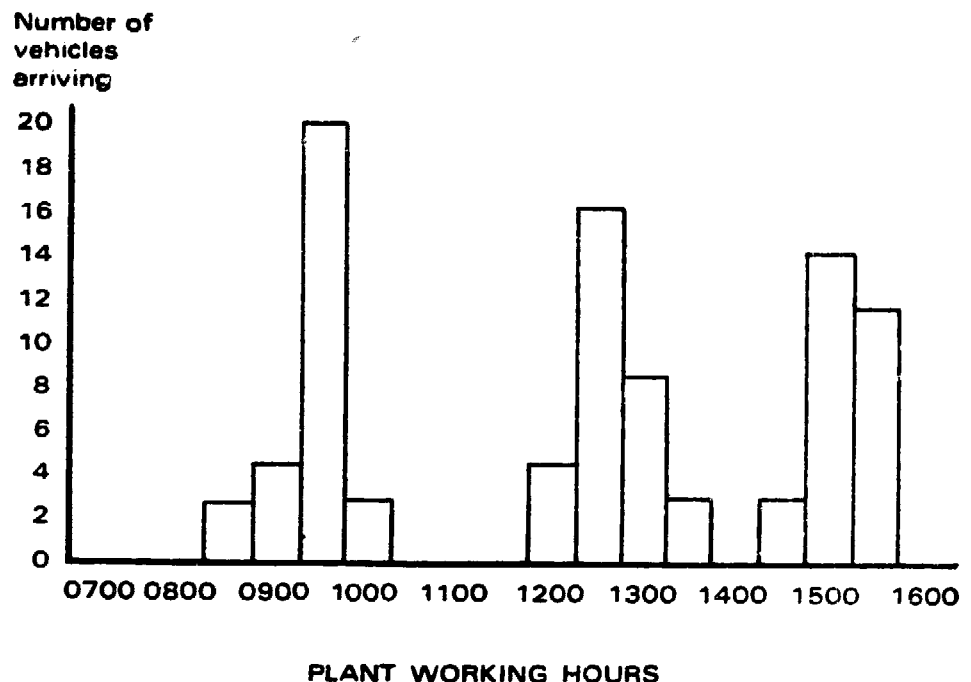
The vehicles in which the wastes are delivered discharge their loads from ground level by gravity, so unless an elevated road is provided, or a split-level site is available, the storage method must be combined with an elevating facility; this permits the use of gravity transfer between subsequent elements of the treatment process. Storage-elevation systems are of three main kinds, the choice depending on required capacity and cost :

- a deep concrete bunker with overhead grab-crane,
- a large steel hopper containing a steel slat conveyor feeding an elevator belt,
- direct dumping on a concrete floor from which the wastes are pushed by a bulldozer into an elevator.

One factor common to all these methods is the need to provide adequate reception space for vehicles at the discharge point.

Figure 27

TYPICAL PATTERN OF VEHICLE ARRIVALS  
AT A TREATMENT PLANT



This can be defined as the necessary provision for the simultaneous discharge of a number of vehicles. First it is necessary to ascertain the average pattern of vehicle arrivals from time records. This will reveal the peak delivery period. If, for example, this is 20 vehicles over a period of 30 minutes, and if the average time required for a vehicle to enter the reception area, manoeuvre, discharge its load, and leave, is five minutes, then 100 vehicle-minutes must be accommodated within that 30 minutes period, equivalent to four vehicles discharging simultaneously.

**reception  
capacity  
17.1.2.**

Thus one dimension of the storage capacity is determined by the required reception capacity and in the case quoted above the minimum length of the bunker or the steel hopper would need to be sufficient to allow four vehicles to stand side-by-side with reasonable space between them. The width of the apron fronting the bunker or hopper is determined by the turning circles of the vehicles in use, or likely to be used in future, and should permit them to drive in and reverse for discharge without complex and time-wasting manoeuvring.

It will be apparent that the time during which a vehicle occupies a discharging space is critical to this aspect of plant design, and that all vehicles should be equipped with hydraulic tipping gear; no hand-unloading of vehicles should be permitted normally.

Deep concrete bunkers are usually used only when the required storage capacity exceeds four hours of operation. The walls are vertical in order to allow the grab to work close to the sides, and sometimes incorporate steel protective strips to minimise damage from a swinging grab. The side along which the vehicles discharge has a strong kerb or "bumper bar" to serve as a stop for the rear wheels. The width of the bunker must be great enough to accommodate that part of the vehicle which overhangs the bunker during unloading, plus the width required for operation of the grab. The total usable width, however, is limited by the fact that solid wastes have no natural angle of repose and tend to heap on the vehicle discharge side.

**deep bunkers  
17.1.3.**

The capacity of the grab crane is determined by the volume of the grab and the average time cycle. The operator of the grab can be located in a cabin on the crane or in a control room which gives a total view of the bunker from above as well as a good view of the grab discharge point. Working conditions for the operator are better in a control room. Grabs may be of either clamshell or tulip pattern. A spare grab should be located in a position which

enables a quick exchange to be made when repairs are needed.

Handling by grab is a batch process which cannot be used for direct transfer to a conveyor belt. A grab usually discharges into a surge hopper which can take the form of a plate conveyor or a vibrating feeder; these can provide a smooth feed to a conveyor belt.

The bunker and its equipment are enclosed by a building and the side at which vehicles unload is divided into apertures of convenient size which can be closed by swing doors when not in use. An alternative method of closure, or partial closure, and one which is less subject to accidental damage, is a suspended rubber curtain, formed from strips about 30 cms wide, which is merely pushed aside as the vehicle reverses into position.

The provision of dust extraction is possible by placing vents in the wall of the bunker opposite the vehicle unloading points, withdrawing the dust-laden air by means of a fan, and passing it through an air-cleaning plant, but the energy requirement is very high. A solution that satisfies most situations is the provision of atomised water sprays in the upper part of the building; water consumption is very small, but the water supply must be well filtered.

A disadvantage of this storage method is that the grab is unable to remove the wastes in the order in which they arrive; it takes the newest wastes from the top of the mass and old wastes tend to remain at the bottom where they putrify. It is usually necessary to empty the bunker completely at least once weekly and this involves lowering men to the bottom to clean out corners, loosen adhering matter, sweep up and hose down. It is useful to provide a sump in the base of the bunker into which washing water can drain, and a portable pump for emptying the sump.

**hoppers  
and slat  
conveyors  
17.1.4.**

When the required storage capacity is equivalent to four hours or less, it is usually possible to provide it in the form of one or more rectangular steel hoppers, two metres or more in depth, mounted over steel slat conveyors. Such conveyors, which are usually between two and three metres wide, are of simple and robust construction comprising a heavy continuous chain on each side, driven by sprockets. Each chain link carried a steel slat interlocked with its neighbours. The non-driven sprockets are adjustable for chain wear.

The range of capacity normally provided in this way is from 50 cu metres to 200 cubic metres. The required speed

of such a conveyor is very slow: for example, a cross sectional area of two square metres discharged at a conveyor speed of 1 metre/minute equals a volume of 120 cubic metres/hour, or 40 tonnes/hour at a density of 330 kgs/cubic metre. It is usually necessary to provide an adjustable choke beam to control the rate of discharge; these sometimes cause blockages.

Horizontal slat conveyors normally feed a rubber/canvas elevator belt the inclination of which should not exceed 25°, and which usually runs at a speed of 20 - 30 metres/minute. The belt should be mounted on trough-idlers with sealed bearings. The volume to be handled per minute, divided by the belt speed, gives the average cross sectional area of the load to be carried, e.g. 2 cu metres divided by a speed of 20 metres = 0.10 square metres. This could be carried on a belt one metre wide at an average depth of 100 mm.

Conveyor belts for solid wastes should be to a high specification, preferably neoprene/nylon. For troughed belts the nylon canvas should be of stepped ply construction to aid flexibility. Driving drums should be crowned 5 mm/metre of width to assist the true running of the belt.

When conveyor belts leave buildings and travel in the open air, they should be covered to prevent loss of wastes in but the covers should be accessible from a walkway and readily detachable.

This method of storage requires a concrete floor of adequate size, preferably within a building, on which vehicles dump their loads. Adjacent to this storage area there is a small hopper from the base of which an inclined slat conveyor operates. This type of slat conveyor is usually less than 1 metre wide, has cleated slats to minimise slip, and travels between high, tapered, steel sides, at somewhat higher speeds than slat conveyors used in storage hoppers. Inclined slat conveyors have very little storage capacity and are continuously fed by a bulldozer, usually on a rubber-tired tractor.

Although aesthetically less attractive, this method is often the least costly in capital expenditure, and provides a very flexible storage arrangement. The operating cost of a bulldozer, however, may be greater than that of the electric motors, about 10 h.p., required to run a storage slat conveyor and rubber elevator.

Solid wastes contain considerable amounts of material which could be sold after cleaning or treatment and some like paper, textiles, glass and plastics can be re-cycled.

**ground  
storage  
17.1.5.**

**Salvage  
17.2.**



**picking belts**  
**17.2.1.**

The saleable materials in urban solid wastes are usually paper, textiles, glass, non-ferrous metals, and ferrous metal. All except the last have to be extracted by hand. Hand-sorting also permits the extraction of some contrary materials; it is a good thing to remove heavy pieces of masonry or metal which could cause damage during some later treatment process. Plastics can be hand-picked if there is a sale for them; otherwise it is easier to remove them by screening at a later stage.

The work of hand sorting is not a pleasant occupation and the best possible conditions should be provided for the workers. Usually the picking belt will be the first process after elevation and will be placed in the upper part of the building; it should be shut off from other processes by partitions to minimise dust and noise, and it should be well lit and ventilated. For dry wastes with a high dust-content it will be necessary to provide dust extraction hoods over the picking belt.

The speed of the belt should not exceed 15 metres/minute and its width should be not more than one metre unless it is to be worked from both sides. It should be flat, not troughed, and spillage should be prevented by retaining boards of wood or metal along both sides. Its height above floor level should be the average elbow height of the workers.

Chutes should be provided for the main categories of materials to be extracted. They should be adjacent to the belt, and must be on the same side as the workers. These chutes should lead to a room on the ground floor where the salvaged materials can be prepared for sale. Chutes are not suitable for bottles that will be sold intact, and it will be necessary to provide boxes for these. Boxes can also be used for materials which arise in very small quantities, such as non-ferrous metals.

Salvage pickers should be supplied with gloves to protect their hands from cuts and infection, and with face-masks if dust cannot be controlled by other means.

**magnetic extraction**  
**17.2.2.**

Electro-magnets are used for the extraction of ferrous metals when the quantity present in the wastes justifies such an installation. They require direct current, usually supplied by means of a rectifier. There are two common methods of magnetic extraction :

- magnetic head pulley,
- overband magnet.

The top (driving) pulley of an elevator belt can be fitted with internal magnets which cause light ferrous objects to cling to the belt during the period when other wastes are

falling into the short chute which links the elevator to the next stage, usually the picking belt. As the ferrous metal is carried away, clinging to the underside of the belt, it passes outside the influence of the magnetic field and falls from the belt. A chute located at this point transfers the metal to a baling press on the ground floor. Magnetic head pulleys are not recommended for the following reasons:

- extraction efficiency is low, usually under 60%,
- small objects such as nails are pulled over the edge of the belt and cling to the drum itself, ultimately causing serious damage to the conveyor belt.

An overband magnet is a separate unit, usually located about 500 mm above a picking belt and at right-angles to it. It is a very short rubber conveyor belt. Magnets are installed between the top and the return sides of the belt and attract light ferrous objects from the wastes passing beneath. Most of this metal is in the form of tin cans; they cling to the underside of the rubber belt and are carried away, across the direction of travel of the picking belt, until they are outside the magnetic field, when they fall into a chute. There is a tendency for round objects to be retained within the magnetic field by rolling backwards while clinging to the belt; this problem is largely overcome by fitting rubber cleats to the belt.

The effective extraction rate is about 80% at best; it depends on the thickness of the wastes on the picking belt, and the height of the overband magnet over the picking belt; this is adjustable. If maximum extraction rate is sought, there will be a significant proportion of other wastes carried over with the metal and this will have to be removed by hand before sale. If clean metal is required this can be achieved by reducing field strength, but the extraction rate will fall to 60% or less. To achieve a high extraction rate of clean metal it is usually necessary to employ two overband magnets in series.

The chutes from the salvage extraction room will deliver the salvaged materials to the ground floor where they will be subjected to some further sorting and packaged for sale. The extent of this work will depend upon local conditions, particularly whether the materials are sold to a scrap merchant who will perform the final sorting, or direct to a factory for which they are the raw material. The following are the kinds of treatment that may be necessary:

(a) *Paper*: Paper which is to go to a paper mill for repulping usually has to be sorted into several grades, e.g.: newspaper, fibreboard cartons, books and magazines, and mixed paper, each grade being used for a different product.

**salvage  
treatment  
17.2.3.**

Paper can be sold packed in sacks, but where large quantities are produced baling will be necessary. Baling machines range from simple hand-operated ratchet balers, which produce bales weighing about 100 kgs, to large continuous reciprocating presses suitable to high rates of feed and which produce bales of 500 kgs or more.

(b) *Ferrous metals* : There are many grades of ferrous metal, the main categories being thin sheet steel, heavy machinery scrap and cast iron. The main ferrous constituent of solid wastes is tin cans and other hollow articles; these need to be baled if they are to be transported to a steel works. The chute from an overband magnet can be arranged to provide direct feed to a hydraulic two-way metal press. The press operator should have access for the extraction of any contrary matter which contaminates the metal.

Complete recovery of the constituents of tin cans is practicable : the solder can be recovered by heat treatment and the tin by electrolytic baths, leaving the pure steel for re-melting. Factories which operate this kind of process usually prefer to receive the tin cans loose, not baled.

(c) *Non-ferrous metals* : The sorting and cleaning of non-ferrous metals is a skilled manual operation. The common metals are rolled aluminium, cast aluminium, copper, brass, zinc, and lead, but in many cases they are in the form of household articles which contain more than one metal and often some non-metallic constituents. For example a kettle may be made from rolled aluminium and have a cast aluminium handle, which must be separated, and the kettle may contain mineral adhesions which need to be removed by beating it. A brass lampholder contains porcelain insulators which have to be removed; copper cable must be separated from rubber or plastic insulation, usually by burning off.

Cleaned non-ferrous metals are extremely valuable and good security is essential while they are being stored awaiting sale.

(d) *Textiles* : There are numerous potential uses for salvaged textiles. Woollen garments can be recycled into a lower grade of usage; they make excellent blankets. At the other end of the scale, carpet and gunny have been used to make bituminous roofing felt. Other uses include paper making and machinery wipers. It is usually possible to sell textiles mixed to a rag merchant who will carry out the sorting. They should be disposed of quickly; if left in heaps, or in bags or bales, they tend to heat up and decompose and their value is lost or reduced.

Salvaged textiles now contain a high proportion of man-

made textiles and this has reduced their value in comparison with the time when they comprised mainly wool and cotton.

(e) *Bottles*: For bottles of a standard type there is often a wide market for re-use. For proprietary bottles, the only potential purchaser is the original producer, but he may be prepared to buy them back if they have been carefully sorted and washed. Bottles extracted from solid wastes are usually sold to bottle merchants who perform this function.

(f) *Broken glass*: Unsaleable bottles can be added to the broken glass which must be carefully sorted into grades: clear, amber and green, and must be free of contraries such as metal tops. A proportion of broken glass is used in the manufacture of all new bottles; some broken glass is used by the abrasives industry in the manufacture of glass-paper.

(g) *Plastics*: In some areas there is a market for salvaged plastics, usually plastics film is the easiest to dispose of. Processes are now being developed for the manufacture of various products, such as building boards, in which recycled mixed plastics are used as a bonding material. Thus the market for plastics of most kinds may expand in future.

Where salvage has been carried out under controlled conditions in plants designed for the purpose there has been no evidence of adverse effects on the health of the sorters. There could, however, be risks to public health if the subsequent use of the salvaged materials is not carefully controlled. The main areas of risk concern paper, textiles, bottles and plastics film.

**health aspects  
of salvaging  
17.2.4.**

— Paper must always be sold for re-pulping, in which it undergoes heat treatment. It must never be sold for direct re-use, as sometimes happens in the case of cartons and newspaper which can be used for wrapping food.

— Salvaged textiles must never be used as fillings for mattresses and furniture.

— During the salvage process any bottles that appear to have been used for a secondary purpose, such as containers for kerosene, should be broken. At the bottle factory the cleansing process must provide effective sterilisation.

— Plastics film should be sold only for melting and recycling never for re-use as wrappers.

This is a complex area of control which requires legislation on manufacturing standards for certain products and enforcement by health inspectors, together with vigilance and control by the solid waste management authority in the disposal of such materials. The best policy would be to sell paper only to re-pulping mills, plastics only to plastics manufacturers or extruders, and bottles and tex-

tiles to reputable merchants whose methods are open to inspection.

## **Size Reduction**

### **17.3.**

Size reduction is an advantage when a high proportion of the compostable wastes exceeds about 50 mm in size. It is particularly necessary when the paper content, after salvage, still includes cartons and thick publications, and when much of the vegetable content is in the form of large fibrous leaves and rinds. All size reduction processes confer a secondary benefit by mixing the wastes into a more homogeneous material. Five methods of size reduction will be considered :

- hammermills,
- rasps,
- short-term drums,
- long-term drums,
- shears and cutters.

## **hammermills**

### **17.3.1.**

A hammermill is a strong steel casing in which is mounted a rotating shaft, with a speed of several hundred revolutions/minute, which carries one or more rows of swing hammers. Wastes are fed into the top opening of the machine and are reduced in size by being struck repeatedly by the hammers. Some mills have a grid at the base for the retention of resistant matter until it has been sufficiently reduced in size.

There are two main types of hammermill, vertical shaft and horizontal shaft, and both are widely used. Vertical shaft machines tend to be lower in cost because they are of simpler design; they are effective because the wastes pass through successive rows of hammers with reducing clearances, thus avoiding the need for a grid. The horizontal shaft machines tend to employ heavier hammers and because of their large rectangular feed openings are favoured for "consumer society" wastes containing large items such as furniture.

The capacity range for hammermills used for solid wastes is from about 10 to 40 tonnes/hour and motor sizes range from 120 to over 400 hp. All hammermills are provided with an arrangement which permits them to reject an intractable object. This may take the form of a spring-loaded section of the casing which would yield and trap a heavy object. A more common arrangement is to provide an opening through which dense or resilient objects are projected by centrifugal force. The path of projection is vertical for a horizontal machine and horizontal for a vertical shaft mill.

The main cause of blockage in a hammermill is textiles, usually a bundle of sacks or a piece of carpet, but

this problem is unlikely to arise if the mill is preceded by a picking belt. Explosions have occurred in hammermills and one known cause is butane containers; this, too, is an unlikely contingency and can be guarded against in two ways:

- vigilance by the pickers, and
- a casing design that permits the controlled absorption of explosive energy, for example by arranging for a heavy upper segment of the casing to be only lightly attached, but fitted with chain restraints.

It is not possible to avoid a hammermill becoming overloaded from time to time and it is usual to fit an electrical overload device which will halt in proper sequence the train of handling elements which supply it.

For the reduction of urban wastes a hammermill has limited efficiency; a common level of performance would be 85% below about 50 mm, and efficiency declines as the hammers become worn. For complete size reduction it would be necessary to provide two-stage milling and screening, but it is rare to find this type of installation today. Thus it is usually necessary to accept that shredded wastes will contain oversize matter; this is often in the form of plastics, rubber and textiles and implies a need for screening at some later stage of treatment.

The main operating costs of a hammermill are energy and hammer wear. (Paper is thought to be the main cause of hammer wear.) Hammers are of two main kinds: shaped steel castings the working faces of which are rebuilt daily or less frequently, by welding; and rectangular hammers cut from standard sizes of steel bar. The second type costs less and is expendable after having been reversed end-to-end and top-to-bottom, so utilising four cutting edges. The life of this kind of hammer can be extended if it is originally tipped with hard weld-metal. A local source of replacement hammers is important if expenditure is to be kept to the minimum.

Size reduction in a hammermill is achieved by heavy blows from a high-speed hammer; a rasp operates on a similar principle to a perforated vegetable grater used in the kitchen. The wastes are shredded by being pushed under pressure across hard protrusions between which are perforations which allow size-reduced particles to pass.

The Dorr-Oliver rasp comprises a cylinder more than five metres in diameter which is divided into an upper and lower chamber. Wastes are delivered by conveyor to the upper section which is the rasping chamber and the floor of which is formed by segmented perforated plates bet-

**rasps**  
**17.3.2.**

ween which are fitted unperforated sections on which cast manganese pins are mounted for abrasive purposes. A central shaft carries 8 rotating rasping arms which force the wastes across the manganese pins. The arms are pivoted to permit them to ride over an intractable object.

Wastes which have been sufficiently reduced to size fall through the perforations (which can be from 25 mm upward in diameter according to requirements) to the lower collecting chamber. Here the central shaft carries four sweeping arms which push the wastes to a discharge opening below which is a conveyor.

Wastes which resist size reduction accumulate in the rasping chamber from which they are removed from time to time through an opening and chute.

A machine of this type has a capacity of 10-12 tonnes/hour of raw refuse and the installed power is 2 x 40 h.p. motors. When used for the treatment of wastes that have already been decomposed in windrows, capacity may be much greater than this because a high proportion of the crude compost will be small enough to pass straight through the machine while the strength of the oversize fibrous matter will have been reduced by partial decomposition.

The rasp was used for the V.A.M. process in Holland and has the following advantages :

- positive size reduction, thus screening is not necessary except for grading purposes,
- energy consumption and maintenance frequency are less than for a hammermill.

**short-term  
drums  
17.3.3.**

An alternative to the hammermill or rasp is to tumble the wastes in a revolving drum for between one and two hours. For this to be effective in achieving size reduction the initial moisture content must exceed about 50% in order to reduce the strength of the paper in the wastes; if necessary, water is added to the wastes as they enter the drum. Excessive moisture content, however, may result in the formation of large balls of wastes. One type of drum consists of two concentric cylinders. The inner one, into which the wastes are fed, is perforated, so that as the wastes are reduced in size they pass into the space between the two cylinders. The inner cylinder is fitted with baffles to assist agitation of the contents.

The wastes are discharged in two streams : size-reduced screenings and oversize rejects. However, size reduction is less effective than a hammermill, thus the proportion of rejects may be quite high and may contain a proportion of desirable compostable material. The appearance of the

screened material is good; despite the short retention time it loses most of the visible characteristics of fresh wastes. Although such drums have a much lower energy requirement than a hammermill, they have not achieved popularity, probably because their low throughput, usually about 5 tonnes/hour, limits their application to small-scale projects.

Judged by the number of plants built and operated successfully, this has been one of the most notable composting systems of the post-war period. After a salvaging stage the wastes enter a long steel cylinder, resembling a cement kiln, which has a capacity of up to 300 tonnes and is rotated at speeds from two to seven revolutions/minute. At the point of entry the wastes are brought up to the required moisture level, if necessary, by the addition of water or sewage sludge. Air is supplied to the interior and the CO<sub>2</sub> and other gaseous products are vented. At some of the earlier plants these gases were found to cause offensive odours in the vicinity and it is now customary to exhaust them through trunking to an underground filter of sand, gravel, and sometimes charcoal.

The drum is slightly inclined to the horizontal and the wastes slowly pass along its length. Initially the retention period was about 5 days and most drums had a daily capacity of about 50 tonnes. Tests under these conditions always confirmed the destruction of pathogens.

The drum is a costly feature, however, and at many plants the contents are retained for only three days in order to achieve a greater throughput for a given level of capital expenditure. At one recently erected plant the retention period is only two days and a further reduction of this period is being contemplated in the hope of attaining a throughput approaching 200 tonnes/day. Under such conditions it is important to recognise that:

- there is no certainty of the destruction of pathogens, insects and weed seeds during this phase,
- physical reduction is less and the proportion of oversize contrary matter is greater,
- decomposition has only just begun when the wastes are discharged, thus the retention period in windrows and the number of turns for aeration will be similar to the requirement for shredded or crude wastes.

The interior of the drum is fitted with wear plates. Maintenance is not a frequent need as with a hammermill, and occurs only at long intervals during which the plant must be shut down while re-lining is carried out.

Whatever the retention period in the drum, the material emerging contains contrary materials such as broken glass,

**long-term  
drums  
17.3.4.**



plastics, textiles and stones. Thus further treatment is required before or after windrowing. This normally includes screening and ballistic separation, and treatment by hammermill is sometimes provided.

**shears  
and cutters  
17.3.5.**

The methods of size reduction which have been considered so far are normally applied to 100% of wastes input, less salvage extracted, the justification for this being the physical character of the wastes, in terms of constituents and size, as established by analysis. There are some situations, however, in which size reduction is necessary only for certain specific wastes which form a small percentage of the total. For example:

- if it is desired to add straw, or similar material in order to increase the C : N ratio,
- if it is desired to return to the windrows the undecomposed fibrous vegetable matter which is usually screened out of wastes which have been composted in their crude state.

It may be necessary to chop such wastes to facilitate mixing and decomposition, and a simple machine may be adequate for such a purpose. The chaff-cutter, with rotary blades turned by hand or a small motor is an effective tool of low cost. A rapid reciprocating shear operating over a flat bed is another alternative; the blade, on which a heavy weight should be mounted, can be operated by a pair of cams.

**Windrow Layout  
and Management  
17.4.**

The windrowing stage is the most important part of every composting system except for those rare plants in which a digester is employed. The area occupied by the windrows should be paved, drained, and provided with a water supply. The capital cost of this is proportionate to its area, which should, therefore, be kept to a minimum by careful design of layout and operation. The other main cost element is that of turning the windrows to aerate them, and the choice of method to perform this work requires equal care.

For all systems except that of static aeration, described later, it has been found that the optimum height for a windrow is between 1.6 and 2.0 metres. The reasons for this are:

- at lower heights the temperatures achieved are less,
- at greater heights anaerobic pockets are more likely and manual trimming is difficult.

Width is less critical: 1.5 to 2.0 metres has worked well in small operations; 3.0 to 4.0 metres is normal, and it is possible that greater width would be acceptable if conditions so required. The length of a windrow has no effect on

its biological operation, but the most convenient length is usually that which contains one day's production, in order to simplify the turning rota.

The main aspects of plant design for the windrowing phase are :

- transfer of wastes to windrows,
- aeration of windrows,
- layout of windrows.

The use of a conveyor system to carry the wastes from the treatment plant and distribute them in windrows is low in operating cost and fairly reliable. It is necessary for the conveyor to be able to discharge continuously at any point along its length. This is achieved by passing the conveyor belt through a movable tripper carriage. The tripper is fitted with a short transverse belt on to which the main conveyor discharges. The transverse belt discharges at the side of the main belt, and, if necessary, is reversible, so that continuous windrows can be formed on both sides.

Tripping conveyors employed are of two types: fixed and radial. A fixed conveyor is not very practical; it can form only two windrows, one on each side. As the space between the windrows is occupied by the supporting structure of the conveyor system, the windrows are accessible only from the outside and turning is extremely difficult. This method is used normally only with static aeration systems which avoid turning.

The supporting structure of a radial conveyor is mounted on rails. The tripper is fixed at a given point while the conveyor system travels slowly round its axis and in this way windrows are formed in concentric arcs. Each arc can be a continuous windrow provided that markers are inserted to indicate the date of deposit. Such windrows tend to be triangular in section, and thus occupy more ground for a given volume than those formed by some other methods. It may be that this is why designers of such systems usually make the error of creating windrows of excessive height; this reduces the capital cost of the system but can lead to anaerobic problems.

In both fixed and radial systems the height of the windrow can be controlled by a probe suspended near the discharge point. When the wastes reach a sufficient height to move the probe, either the tripper carriage or the radial carriage is moved forward by electrical contact.

In both systems the retention time of the windrows is fixed and at the end of that time the compost is removed to a storage area, or a post-treatment plant, so that new wastes can enter the cycle.

**transfer  
to windrow  
by conveyor  
17.4.1.**

**transfer  
to windrow  
by tractor  
17.4.2.**

The most common method of transfer is by tractor and trailer. It is the more flexible system, and very reliable, for while the failure of a conveyor system would stop the plant completely, a plant is unlikely to employ only one tractor. It is more costly in operation, however, because there are three handling elements involved:

- loading a trailer,
- transport and unloading trailer,
- stacking unloaded wastes in windrow.

The first of these can be avoided if the treated wastes are discharged by gravity directly into a trailer. However, if discharge is at ground level, as has frequently been observed, a front-end loader is required to fill the trailer.

Stacking wastes in the windrow incurs the cost of a front-end loader or manual labour, but the shape of the windrow can be made to economise ground space by forming it with a gently rounded top instead of the conical shape which results from conveyor discharge.

**direct delivery  
to windrows  
17.4.3.**

Where the character of wastes makes it possible to windrow them without prior treatment a significant cost advantage is achieved because delivery to the windrow is made in the collection vehicle. But these vehicles arrive in waves and it is necessary to make provision for peak periods. Layout should permit, therefore, of delivery to both ends of a windrow which is under formation, and in this way it may be possible to discharge four vehicles simultaneously. These peak periods will tend to interfere with the work of the front-end loader which is engaged on windrow building.

**windrow turning  
17.4.4.**

There is a positive relationship between the frequency of turning and the speed of decomposition. Under the most perfect conditions, in a digester, the period may be as short as 7 days, but it is unlikely to exceed 20 days in a windrow which is turned about 4 times and is unlikely to be less than 14 days in a windrow turned daily. Turning is a costly process and should not be employed unnecessarily. For wastes of optimum C: N ratio/in warm or temperate climates, it has been found that three turns over a 20 day period (the fourth turn being removal to a post-treatment plant, or to a storage area) are sufficient.

The method of turning however, is of very great importance for the elimination of pathogens, insect larvae and weed seeds. This requires that the original outer layer should always form the centre of the new windrow after turning.

The area inhabited by fly larvae is shown in Figure 28.

The required turning procedure to transfer the infested portion of the wastes is shown in Figure 29.

Turning and re-forming a windrow requires adjacent space:

- for a front-end loader, or men, to work,
- for formation of the new windrow.

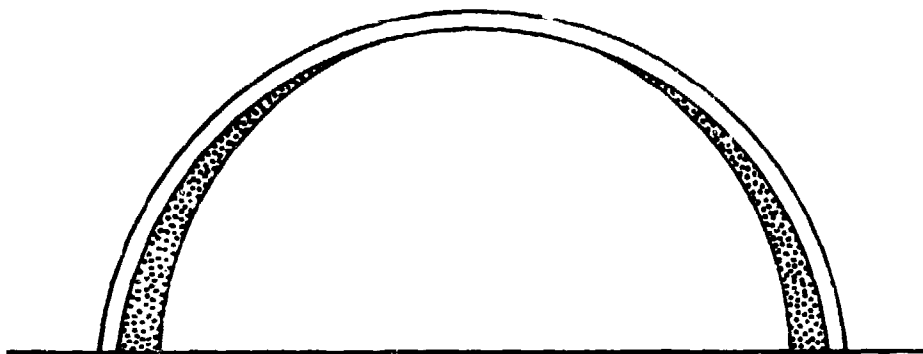
This space can be provided in two ways:

- as an extension of windrow length, to provide for longitudinal turning, or
- vacant space at the side of the windrow, for transverse turning.

Longitudinal turning requires less ground space and for manual operation the transfer distance is minimised. It is not practicable for a front-end loader, however, and if mechanised turning is required it is necessary to employ a shovel in which the bucket is loaded at the front after which the loaded bucket passes over the machine from front to back and discharges at the rear. Accurate placing of the material, as is required for insect control, is difficult with such a machine. There is also the problem that during most of the turning procedure the machine is locked between the old and the new parts of the windrow, and in the event of breakdown it would be difficult to move it.

Figure 28

WINDROW AREA INHABITED BY FLY LARVAE



Dark area is that inhabited by fly larvae on the fifth day  
(adapted from WHO Monograph No. 31, "Composting", Gotaas)

Transverse turning manually is possible if the space between the old and the new windrow site is kept to a minimum, say one metre, but transfer of the far side of the old windrow to the centre of the new one may require double handling owing to the distance. Procedure with a

front-end loader is straightforward, but requires that the whole windrow is turned end-to-end (see Figure 30). Thus it is desirable to keep the length of a windrow to the minimum and this is one case when the width of the windrows should be allowed to exceed the customary four metres.

Tools used for manual turning include a drag (a kind of fork with four tines at right-angles to a long, two metre handle); a pitchfork; shovel and broom for tidying up.

The best shape for a windrow is probably an approximate semi-circular cross-section. This makes the best use of ground space, is easy to form, and sheds the rain.

**windrow layout**  
17.4.5.

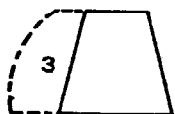
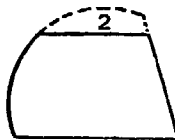
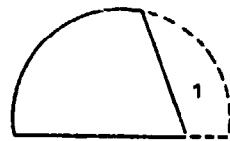
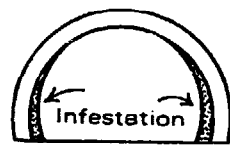
The number of windrow spaces required will be based upon the retention period; if each windrow is to contain one day's wastes and the retention period is 15 days, at least 15 spaces, usually more, will be needed.

Figure 29

WINDROW TURNING PROCEDURE

Section through old windrow

Section through new windrow



The size of a windrow space is determined by daily volume and the cross-sectional area of the windrow. For example :

For an input of 100 tonnes/day at a density of 400 kg/cu metre,	
the total daily volume would be	250 cu metres
For a windrow width of 4 metres and an average cross section of 6 square metres, the length	
of a windrow would be	42 metres
+ safety margin of 20% =	50 metres

The total space required will comprise :

- basic windrow spaces,
- spaces between windrows,
- road access along all sides of windrow site,
- additional windrow length if turning is longitudinal,
- additional windrow spaces if turning is transverse.

For the above example the required windrow area would be as follows :

(a) Longitudinal turning :

Basic windrow length	50 metres
Allow for turning	5
10 metre road at each end	20
	= 75
Windrow width	4 metres
Space between	1
	= 5
X 15 windrows	75
+ 5 metre road at each end	10
	= 85

Site required : 85 m x 75 m = 6,375 square metres  
equivalent to 64 square metres/tonne/day

(b) Transverse turning :

Basic windrow length	50 metres
10 metre road at each end	20
	= 70
Windrow width	4
Space between	1
	= 5
x 19 (15 windrows + 4 spare for turning in rotation)	95
+ 5 metre road at each end	10
	= 105

Site required: 70 m x 105 m = 7,350 square metres  
equivalent to 74 square metres/tonne/day.

To these areas it would be necessary to add space for the other treatment phases: reception, plant, storage; as well as for administration and maintenance facilities.

Rectangular sites usually occupy the minimum space,

but two circular layouts are also possible. One is the system of concentric windrows formed by a radial conveyor, which has already been described.

The second is the use of radial windrows round a central treatment plant. The most likely application of this arrangement would be when crude, not treated, wastes are windrowed, after which they must pass through a plant for the removal of contraries. The radial arrangement permits the use of portable conveyors which can be placed by the side of a windrow, and loaded manually, for transfer of the compost to the plant. The portable conveyors would feed a portable elevator pivoted at the point where it discharges into the plant. The whole conveyor and elevator system would be moved each day from one windrow to the next. In areas of low labour cost this method of transfer is likely to be cheaper to operate than the usual system of trailers loaded by front-end-loader and towed by tractors.

**water supply  
to windrows  
17.4.6.**

During the turning of windrows by hand or machine, the addition of water is usually necessary. For this purpose an underground water main should be laid through the windrow area and hose connection points provided at convenient intervals. These points should be below ground level and covered by metal flaps when not in use, to avoid damage by vehicles or plant.

The whole of the windrow area should be drained so that surplus water, or leachate from windrows after heavy rain, can be collected. This liquid which may be rich in nutrients, should not be discharged to the main drainage system, but collected in tanks so that it can be pumped back to the windrows as an alternative to the use of fresh water.

**static aeration  
of windrows  
17.4.7.**

Because of the high cost of turning, whether manual or mechanised, systems have been devised which seek to eliminate the need for turning by forcing air through a windrow. A typical arrangement is to provide large air jets at ground level, at intervals of a few metres, along the length of each windrow space. The jets are supplied with air under pressure, by a system of underground pipes. Shredded wastes are deposited on these windrow spaces, by either a fixed or radial conveyor system, to a height of about four metres, about double the normal windrow height. Advocates of the system claim that the increased height is made possible because of the large volume of air which passes through the windrow from the jets at the base. The retention period is usually 18-21 days.

Some problems have been encountered with this system.

The most obvious ones are :

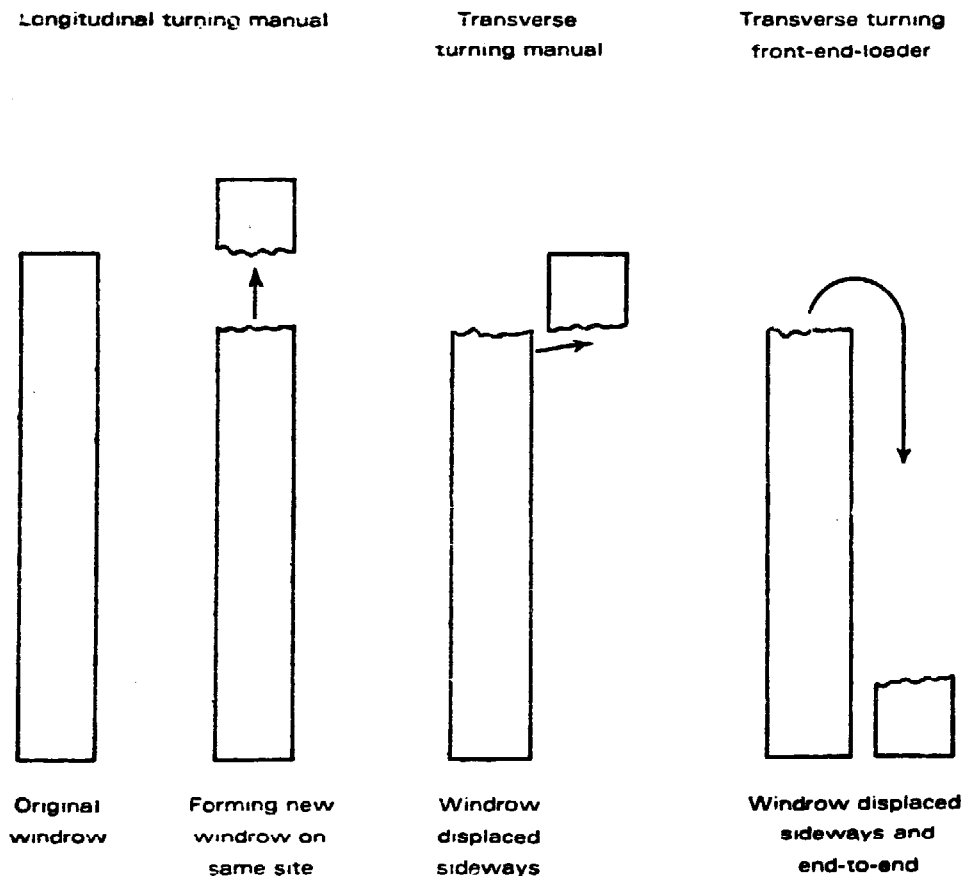
- tracking of the air supply through the less dense areas of the wastes,
- anaerobic pockets,
- rapid loss of moisture and the drying-out of some areas,
- no decomposition of wastes at the outer surface.

Attempts to replace lost moisture by overhead sprinkling have not generally been successful as most of the water runs down the sides of the triangular windrow and fails to penetrate the mass.

Some plants have been built in which the air is drawn through the windrow from outside and exhausted through the jets in the base, through a ground filter, by means of an exhaust pump. Theoretically this should assist in moisture control, if atomised sprinklers are in use, by drawing moisture-laden air through the windrow. In practice, however, a black liquid of high BOD collected in the suction system, causes corrosion and damage to most of the components.

Figure 30

WINDROW LAYOUT





**compost  
turning machines**  
17.4.8.

The front-end loader, which is normally employed for the mechanised turning of windrows, is not ideal for this purpose. Much of its operating time is spent in manoeuvring in a limited space: positioning for attack at the correct point in the old windrow, reversing away, then travelling forward to the correct place to empty the bucket in forming the new windrow. Some final manual trimming is usually necessary. The ideal would be a machine which could travel continuously through a windrow, reforming it in a manner which would displace the original contents so as to achieve insect control, and perhaps add water at the same time.

A machine of this kind is being developed in India. It comprises a bridge at a height of 2.5 metres, supported by vertical columns, carried on four pneumatic tyres, at each end. Suspended from the bridge are four augers, contra-rotating in pairs, which penetrate the windrows to within 50 mm of ground level. The machine spans a windrow and travels very slowly throughout its length; the rotating augers transfer matter from the base to the outside of the windrow at all levels, and with overhead sprinklers for adding moisture. It is driven by electric motors through a variable speed gearbox, and is connected to the supply by means of a wander-lead. This machine is mobile, requires no fixed overhead structure or rails, and can be steered by the operator. It is possible that the operating cost for windrow turning could be less than that for front-end loaders. The latter would still be required, in reduced numbers for windrow formation and removal. As this type of machine turns the wastes *in situ*, the need for spare windrow spaces for sideways turning would be avoided.

**Screening**  
17.5.

There are only two processes which are absolutely essential for the successful composting of wastes of every kind; decomposition is the first and screening the second. To be readily saleable the compost must have a maximum particle size; it cannot command a good price if it contains sheet plastics, old boots and coconut shells. For general agricultural use the screened size is likely to be in the range 25mm to 40mm. Fragments of inert matter such as stones, plastics and man-made textiles which are below this size are unlikely to interfere with cultivation, or to mar the other qualities of the compost. Screening provides a total solution to the removal of contrary materials, within commercially practicable limits, except for fragments of glass; this problem will be considered later.

The size reduction processes described earlier, such as hammermills and long-term drums, do not avoid the need

for screening because both these methods pass a proportion of oversize materials, but rasps and short-term drums, which incorporate perforated plates, eliminate the need for screening other than for grading purposes.

Screening can be applied at one or more stages of treatment:

- before size reduction,
- after size reduction and before windrowing,
- after windrowing.

The usual purpose of screening before size reduction is to provide some measure of protection against oversize material to a hammermill. The type of screen used for this purpose could be vibrating bars spaced at about 100 mms. It is now customary to install hammermills of sufficient volume and power to avoid the need for this kind of protection.

**when to screen  
17.5.1.**

At most compost plants screening is performed after the size reduction process and immediately before windrowing. The cost of installation is reduced when processes can be linked together, each feeding by gravity the one that succeeds it. However, the effectiveness of screening is inversely proportional to the moisture content and at this stage the wastes are likely to be high in moisture; either because they are fresh or are emerging from a drum. Thus screening at this stage usually results in a higher proportion of rejects which include some oversize compostable material and compostable matter which is carried over as they are attached to contraries. Screened rejects produced at this stage present disposal problems as they contain insect eggs and larvae (unless they have been retained in a drum for an adequate period).

Although it requires the provision of a separate feeding and handling process, the screening of compost after windrowing has several advantages:

- efficient screening because of low moisture content,
- minimum proportion of rejects (or maximum compost production)
- the rejects are free of pathogens and insects, and can be disposed of without problems.

Rotary screens are the most efficient in extraction, and reliable in operation, for solid wastes. Their efficiency stems from a relatively long retention period during which the wastes are tumbled and separated from each other. There are two methods of transporting the material through a screen: by inclining the screen from the horizontal or by fitting it with an internal spiral.

**rotary screens  
17.5.2.**

The wastes occupy a cross-sectional area enclosed by a chord and part of the circumference; the capacity of the screen is a function of this area and the speed at which the wastes pass through the screen. A rotary screen is usually carried on rubber idlers and driven through a gear ring at one end. Small rotary screens may be mounted on a central shaft driven by a belt and pulley, but internal supports must be kept to a minimum as they soon collect rags and wire.

When installed in a building, the whole screen assembly should be contained within a steel casing to prevent dust dissemination.

Screen plates are detachable and renewable. A screen may be fitted with more than one size of mesh if it is required to produce two or more sizes of product, provided that separate chutes are fitted below each stage.

**vibrating  
screens**  
**17.5.3.**

A vibrating screen is in the form of a slightly inclined, perforated, table across which the wastes are propelled by rapid vibration. Grading of the product can be achieved by placing tables in series. Because of lower capital cost and smaller space required, compared with rotary screens, it is now customary to use vibrating screens in compost plants. They have the following disadvantages, however, for the treatment of both wastes and compost:

- blockage of apertures occurs much more rapidly than with a rotary screen,
- there is insufficient agitation to break up clumps of materials,
- constant attendance is needed by one or more men to clear blocked perforations and assist the passage of the materials across the screen.

By contrast the rotary screen needs no manual assistance, thus the higher capital cost may be more than offset by much lower operating cost.

**Ballistic  
Separation**  
**17.6.**

Screening does not achieve the total removal of glass fragments; there are two ways of solving this problem:

- final grinding in a hammermill which reduces glass to the equivalent of sand,
- ballistic separation, which also removes other dense particles such as small stones.

The principle of ballistic separation of dense particles is the projection of the compost at high speed; the trajectories of the particles will vary according to their densities, the path of the high density particles being much longer than that of those with low density, and this provides a basis for separating them mechanically.

There are at least two methods of applying the

principle of ballistic separation :

- to arrange for the compost to fall on to a rotating drum to which fins are attached; as the fins strike the particles differing velocities are imparted to them,
- to discharge the compost over the end of a very high speed conveyor belt.

The need to provide either of these facilities is dependent upon :

- the initial proportion of glass in the wastes,
- the efficiency of preceding extraction processes,
- the extent to which the glass may have been already ground by a preceding hammermill treatment,
- the relative importance to the farmer of the presence of glass fragments in the compost.

Ballistic separation is not of very high efficiency and, as with magnetic extraction of ferrous metals, it is necessary to compromise between maximum extraction with some loss of compost, and maximum compost production with some adulteration.

The demand for compost is almost certain to be seasonal, and the storage area required is likely to be in the range of three months to six months' production. (This fact makes nonsense of the argument often put forward by manufacturers of expensive and sophisticated plant that their system reduces the area of land required by shortening the decomposition process by several days.) The storage area also serves a secondary purpose as a maturing stage. After transfer from the windrows or post-treatment plant, the compost is likely to have a final and limited rise in temperature before the slow decline to ambient commences. The process of transfer and stacking will entrain sufficient air for this phase.

**Storage Area  
17.7.**

It would not be economical to store such large quantities under cover, and in any case there is little risk of the loss of nutrients by leaching. During periods when heavy rain occurs the compost should be stored in triangular windrows so that the rain is shed; compost has some self-thatching characteristics which help it to resist water penetration. In dry areas there is no special requirement for stacking, and continuous flat heaps provide the best use of ground space.

Except in the case of very small plants the provision of a weighbridge is recommended for the following reasons :

**Weighbridge  
17.8.**

- the input of wastes can be measured,
- the weight of all plant products: salvage, rejects and compost, will be known,
- plant efficiency can, therefore, be monitored with accuracy,

— it is seldom practicable to sell salvaged materials other than by weight,

— it is desirable to sell compost by weight owing to the difficulty in calculating volume in vehicles of varying types.

The size of a weighbridge, in terms of platform length and weight capacity should allow for possible future increases in the sizes of vehicles in use.

When a weighbridge is to be used for sales, there is a risk of fraud by employees; various recording devices are available which help to reduce such risks.

For large plants, say 300 tonnes/day upward, the weighbridge office should be located on an island site with a platform on each side, to enable ingoing and outgoing vehicles to be weighed without causing traffic problems.



19. Pilot project for manual composting at Bangalore. Input is about three tonnes/day and the processing time up to 20 days.



20. Each windrow holds about three tonnes and is turned by hand at least twice.

## CHAPTER 18.

### OUTLINE DESIGNS OF TYPICAL SYSTEMS

**Manual Windrow  
Compost Plant  
18.1**

Manual windrow composting with post-fermentation treatment has three possible applications :

- as the wastes disposal method for a town of about 10,000 population, having a production of 300 gms/person/day at a density of about 330 kg/cu m,
- as a pilot project for a larger city which is planning the construction of a compost plant,
- as a source of covering material for a landfill site serving a population of 20,000 or more.

**capacity**      The capacity is based on three tonnes wastes/day incom-  
**18.1.1.**      ing and a daily compost production rate of  $1\frac{1}{2}$  tonnes.

**method**      Refuse would be delivered direct to one of 20 windrow  
**18.1.2.**      spaces on unpaved but level and well-drained land. Each day's wastes would be formed into a windrow about 3 m long x 2 m wide x 1.5 m high; the total volume in a windrow would be about 9 cu m.

Each windrow would be turned on the 6th and the 11th days, the outside to the centre, to destroy insect larvae and to provide aeration. On the 16th day the windrow would be broken down and passed through a manually operated rotary screen of about 25 mm square mesh to remove oversize contrary materials. The screened compost would be stored for about 30 days in a maturing heap about 2 m wide x 1.5 m high, and up to 20 m long, to ensure that it was stabilised before sale.

**area required**      For such a plant which produces compost at the rate of  
**18.1.3.**      1.5 tonnes a day the area required would be :

20 windrow spaces, 3 m x 2 m, + 0.5 m	150 sq m
space between	
Central roadway for delivery of wastes,	
25 m x 4 m	100 sq m
Maturing (storage area), 25 m x 2 m	50 sq m
Entrance area 15 m x 4 m	60 sq m
total	360 sq m
say,	400 sq m

The staff required for manual windrows compost plant of the type described here would be : **staff required 18.1.4.**

Daily tasks:

1 windrow to be stacked from new wastes	9 cu m
2 windrows to be turned (volume declines during decomposition)	15
1 windrow to be broken down and screened	6
total	30 cu m

1 man can turn 5 tonnes (up to 15 cu m) a day, therefore 2 men would be required; plus 1-1½ men for screening etc.

The rotary screen could be a simple, inclined, perforated drum, hand operated through a geared drive. The height at which it is mounted should be low enough to permit direct loading by hand (from a small platform if necessary). Discharge of the screened material could be to ground level, but it is preferable to provide a low hand-cart to receive the screened compost. **rotary screen 18.1.5.**

Costing of the plant could be calculated under the three heads—capital costs, operating costs and production costs : **cost 18.1.6.**

(a) Capital costs :

Hand operated screen	3,000
Fencing and gates, say 80 m., 5 strands barbed wire, Rs. 400, + Rs. 400 posts and erection	300
say	4,000

(b) Annual operating cost :

Amortisation, say 20% of capital	800
3½ men @ Rs. 5/day = Rs. 13/day	5,400
Tools and equipment	200
Boots and gloves	350
Disinfectant etc.	50
	= 6,800

(c) Compost production cost :

if 300 tonnes produced/year, cost/tonne =	23
add for supervision and administration	10

Total production cost Rs 33/tonne

The probable selling price is Rs. 50/tonne, thus at this scale of operation and assuming no cost for rental of land, income may exceed expenditure and refuse disposal cost would be



nil. The unit costs and performance figures used here are based on the Hebbal Pilot Plant at Bangalore.

**bangalore**  
**pilot plant**  
**18.1.7.**

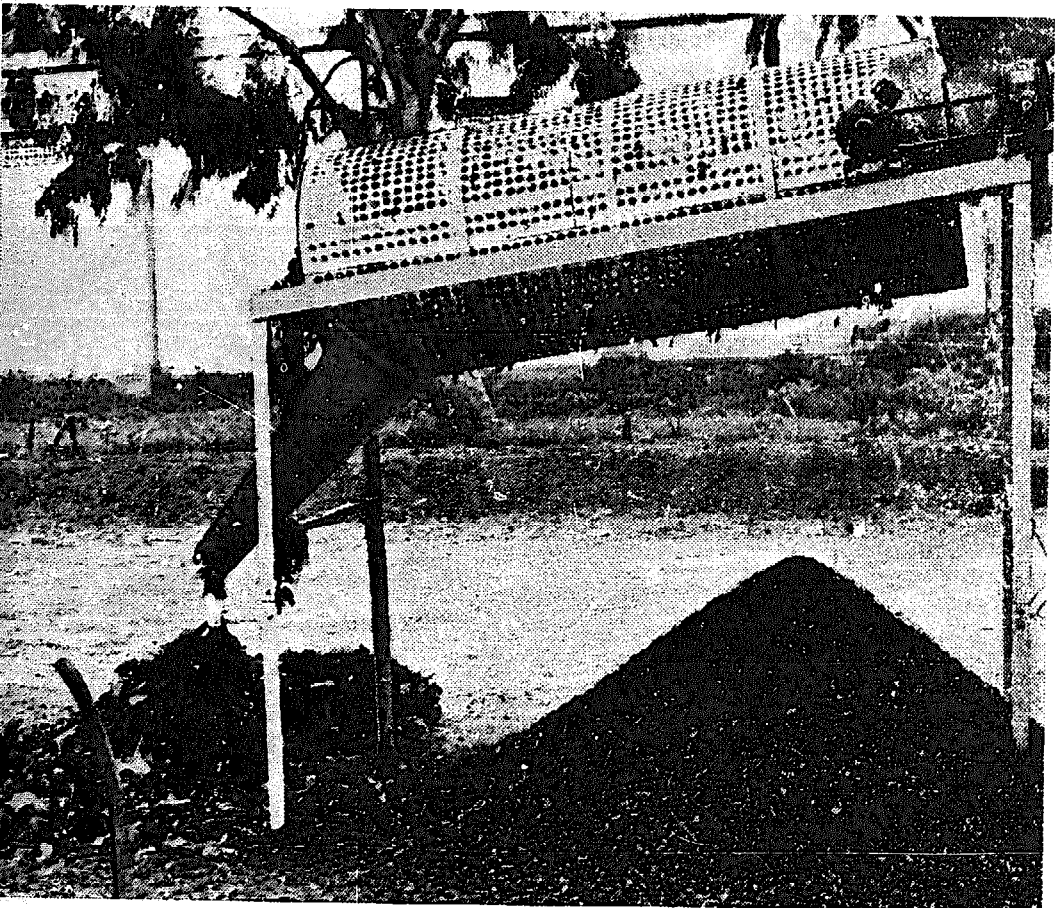
The Hebbal Pilot Plant was commenced in 1975 by the Karnataka Agro-Industries Corporation as a pilot operation for a proposed major plant. There are 20 windrows, each of about 5 cu metres, formed at the rate of one per day, and turned on the 5th, 10th and 15th days. On the 20th day the windrow is broken down and fed by means of an elevator belt to an inclined rotary screen of 25 mm mesh for the removal of oversize contrary matter. All the work is performed by three men; an electric powered elevator and screen were fabricated in Agro-Industries' workshops at a cost of Rs. 9,000. The project has been well managed and the results carefully documented. The main findings are:

- (1) Normal house refuse or a mixture of house and market refuse attains a maximum temperature of about 70°C, usually maintained for several days. Market refuse alone, however, is sometimes too high in moisture content and slow to ferment. It is important, therefore, to mix refuse from the various sources.
- (2) A significant fall in temperature by about the 15th to 20th day suggests that the thermophilic stage, which accomplishes the destruction of pathogens, has been completed.
- (3) On or about the third day, fly larvae sometimes emerge at the base of the windrow and can be collected.
- (4) The site is virtually free from flies.
- (5) There are no offensive odours, except during the unloading of newly delivered refuse.
- (6) Less than the theoretical water requirement has been used.
- (7) The screening system works efficiently. Rejects comprise two main elements: large stones and fibrous materials.
- (8) The temperature of the screened compost stored in maturing heaps sometimes rises to 60°C, but shows little sign of anaerobic activity.
- (9) Tests of the compost show a very low survival rate for seeds contained in the original wastes; those that do survive are mainly tomatoes.

The pilot project has effectively demonstrated that wastes of these kinds can be decomposed in 15-20 days by windrow composting without any prior treatment. Provided that



21. Crude compost being transferred to the elevator belt which feeds the rotary screen. At this stage some salvage is recovered.



22. After screening the compost is ready for transfer to the stockpile where it matures. The rejects must be disposed of in a landfill.

turning is carried out at the correct frequency and moisture added when necessary the method is hygienic and aesthetic.

The importance of screening when decomposition is complete is shown by the vast improvement in content and appearance after screening.

By January 1977 this pilot project had been expanded to about 30 tonnes/day wastes input and two mobile screens were in use. Compost was being graded 10 mm and 25 mm and the prices charged were Rs. 55 and Rs. 50/tonne respectively. All compost production had been sold.

**Radial Windrow  
Compost Plant  
18.2.1.**

This design is based on the following characteristics:

- capacity 50 tonnes wastes/day at a density of 330 kg/cu m.
- product 25 tonnes compost/day, density 600 kg/cu m.,
- operation 8 hours/day, 300 days/year,
- windrow retention period 15 days,
- windrow layout radial to central post-treatment plant.

No plant precisely of this design has been built, but all the elements of which it is composed have been tested in practice.

**windrows  
18.2.**

Nineteen windrows are needed, each of 150 cu m (50 tonnes) capacity, arranged radially to the central plant. At any one time 16 would be in use; the remaining three are needed to permit turning in rotation. Crude wastes would be delivered in tipping vehicles direct to the windrows which would be formed manually, with some assistance from a mechanical shovel. Each windrow would be turned on the 6th and the 11th days and removed to the treatment plant on the 16th day. A planned turning sequence is very important, see Figures 5 and 6.

The average dimensions of a windrow would be 25 m long x 3 m wide on the inner radius and 5 m wide on the outer radius; average height 1.5 m. A space of about 1.5 m should be provided between windrows.

**volume  
to be handled  
in windrows  
daily  
18.2.2.**

The volume to be handled in windrows every day:

1 windrow to be stacked	150 cu m.
2 windrows to be turned (volume declines)	250 cu m
daily total	400 cu m

With a manual performance of 15 cu m/man/day, up to 30 men would be required if no mechanical assistance was available.

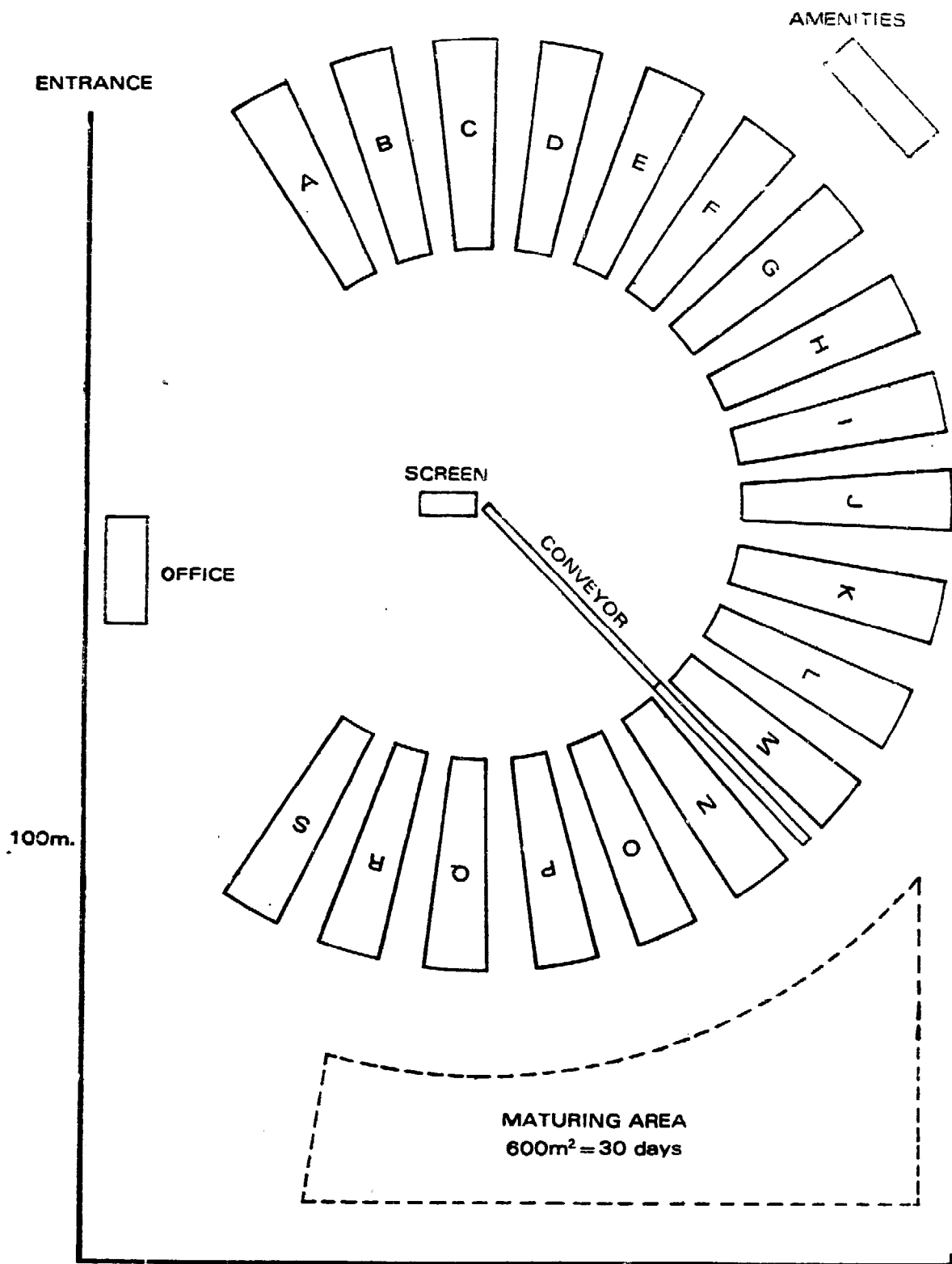
A mechanical shovel with a 0.7 cu m bucket, operating at 60 cycles/hour for 6 hours/day would have a daily capacity of 250 cu m.

For estimating purposes it is proposed to allow for 30 men as well as about 4 hours/day attendance by the mechanical shovel.

Figure 31

LAYOUT OF RADIAL WINDROW PLANT

70m



Site Area 0.7 Ha = 1.7 acres

**transfer to treatment plant**  
**18.2.3.** The daily task of feeding the treatment plant is the breaking down and transfer of one windrow, the volume of which will have been reduced to about 100 cu m during decomposition. It is proposed to effect this transfer by means of one or more portable conveyor belts. About eight men would be required for loading the belts.

The capacity needed for the conveyor system is about 20 cu m/hour. A belt width of 300 mm at a speed of 20 m/minute would have a theoretical capacity of about 30 cu m/hour, thus providing a 50% margin for uneven loading. The total length required is 25 m.

This conveyor would discharge to a radial elevator, pivoted at the feed chute of the treatment plant. The length, width and speed would be similar to the preceding horizontal conveyor, but the height of discharge would be determined by the treatment plant, probably about 4 m.

**treatment plant**  
**18.2.4.** This would comprise a rotary screen and a ballistic separator. The screen could be horizontal, about 4 m long x 1.2 m diameter with an internal spiral having a pitch of 1.5 m. At a speed of 10 r.p.m. the capacity would be about 20 cu m/hour.

The screen drum could be attached to, and enclosed within, an unperforated drum about 3.5 m long and 1.8 m diameter; this would contain screenings and facilitate their discharge to a ballistic separator.

The ballistic separator could take the form of a belt of 300 mm width travelling at high speed; a variable speed range of 200-400 m/minute is suggested.

**transport of products**  
**18.2.5.** The ballistic separator would discharge refined compost direct to a trailer at a rate of 25 tonnes/day, say 5 tonnes/hour, or 8 cu m. This would be about 3 trailer-loads/hour and it would be necessary to exchange the trailer once every 20 minutes.

Screen rejects would also discharge directly to a second trailer at the rate of about 1 tonne/hour; trailer exchange would not be necessary more frequently than once an hour.

Ballistic rejects would be discharged almost horizontally across the compost trailer and would fall at the foot of a safety screen. The daily quantity would be quite small, perhaps 2 cu m, and they could be removed from time to time in a wheelbarrow.

One tractor and three trailers would, therefore, have adequate capacity for internal transport of the treatment plant products.

Figure 32

WINDROW TURNING SEQUENCE

This table should be read in conjunction with the preceding diagram which shows 19 spaces, A to S, of which 15 contain stacked windrows and 4 are spare for turning purposes. The first day's delivery of wastes is stacked in Windrow C, where it remains for five days, being transferred to Windrow B on Day 6. The second day's delivery is stacked in Windrow D, remains for five days and, on Day 7, is transferred to Windrow C, vacated the day before. By Day 17 the last Windrow, S, is stacked, and the third day's delivery has been restacked twice, has been five days in windrow C, and is ready for removal, making room for the 18th day's delivery, again into Windrow C, and so the process continues.

Windrow	A	B	C	D	E	F	G	H	I	J	K	L	M	N	O	P	Q	R	S
Day 1			1																
2			1	2															
3			1	2	3														
4			1	2	3	4													
5			1	2	3	4	5												
6		1		2	3	4	5	6											
7		1	2		3	4	5	6	7										
8		1	2	3		4	5	6	7	8									
9		1	2	3	4		5	6	7	8	9								
10		1	2	3	4	5		6	7	8	9	10							
11	1		2	3	4	5	6		7	8	9	10	11						
12	1	2		3	4	5	6	7		8	9	10	11	12					
13	1	2	3		4	5	6	7	8		9	10	11	12	13				
14	1	2	3	4		5	6	7	8	9		10	11	12	13	14			
15	<u>1</u>	2	3	4	5		6	7	8	9	10		11	12	13	14	15		
16		<u>2</u>	3	4	5	6		7	8	9	10	11		12	13	14	15	16	
17			<u>3</u>	4	5	6	7		8	9	10	11	12		13	14	15	16	17
18			18	<u>4</u>	5	6	7	8		9	10	11	12	13		14	15	16	17
19			18	19	<u>5</u>	6	7	8	9		10	11	12	13	14		15	16	17
20			18	19	20	<u>6</u>	7	8	9	10		11	12	13	14	15		16	17
21			18	19	20	21	<u>7</u>	8	9	10	11		12	13	14	15	16		17
22			18	19	20	21	22	<u>8</u>	9	10	11	12		13	14	15	16	17	
23		18		19	20	21	22	23	<u>9</u>	10	11	12	13		14	15	16	17	
24		18	19		20	21	22	23	24	<u>10</u>	11	12	13	14		15	16	17	
25		18	19	20		21	22	23	24	25	<u>11</u>	12	13	14	15		16	17	
26		18	19	20	21		22	23	24	25	26	<u>12</u>	13	14	15	16		17	
27		18	19	20	21	22		23	24	25	26	27	<u>13</u>	14	15	16	17		
28	18		19	20	21	22	23		24	25	26	27	28	<u>14</u>	15	16	17		
29	18	19		20	21	22	23	24		25	26	27	28	29	<u>15</u>	16	17		
30	18	19	20		21	22	23	24	25		26	27	28	29	30	<u>16</u>	17		
31	18	19	20	21		22	23	24	25	26		27	28	29	30	31	<u>17</u>		
32	<u>18</u>	19	20	21	22		23	24	25	26	27		28	29	30	31	32		
33		<u>19</u>	20	21	22	23		24	25	26	27	28		29	30	31	32	33	
34			20	21	22	23	24		25	26	27	28	29		30	31	32	33	34
35			35	<u>21</u>	22	23	24	25		26	27	28	29	30		31	32	33	34

NOTE : Underlining means removed to treatment plant.

**area** If storage of the compost is needed only for the minimum  
**18.2.6.** maturing period of 30 days, the total site area would be about 0.7 Ha. A site area of one Ha. would allow sufficient storage space for at least 4,000 cu m of compost, i.e. 100 days' production.

**summary  
of labour  
and mobile plant  
required**  
**18.2.7.**

A summary of labour and mobile plant required is given below :

Labour :

stacking and turning windrows	30 men
removing windrows	8 men
plant operation	5
cleaners	5
mechanics	1
drivers	2
<b>total</b>	<b>60 including 9 spare men.</b>

Mobile plant :

mechanical shovels; windrows, 4 hours/day, storage and loading for sale, 2 hours/day	1
tractors	1
trailers, 4 cu m tippers	3

The operating cost of this system is estimated to be about Rs. 70/tonne of compost produced. Details are provided in Chapter 19.

**Post-Treatment  
by Rasp and Screen**  
**18.3.**

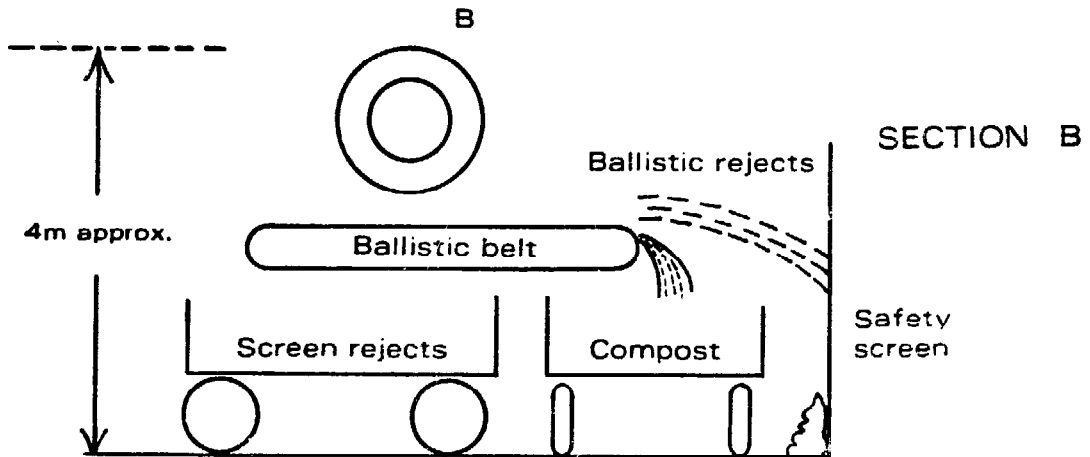
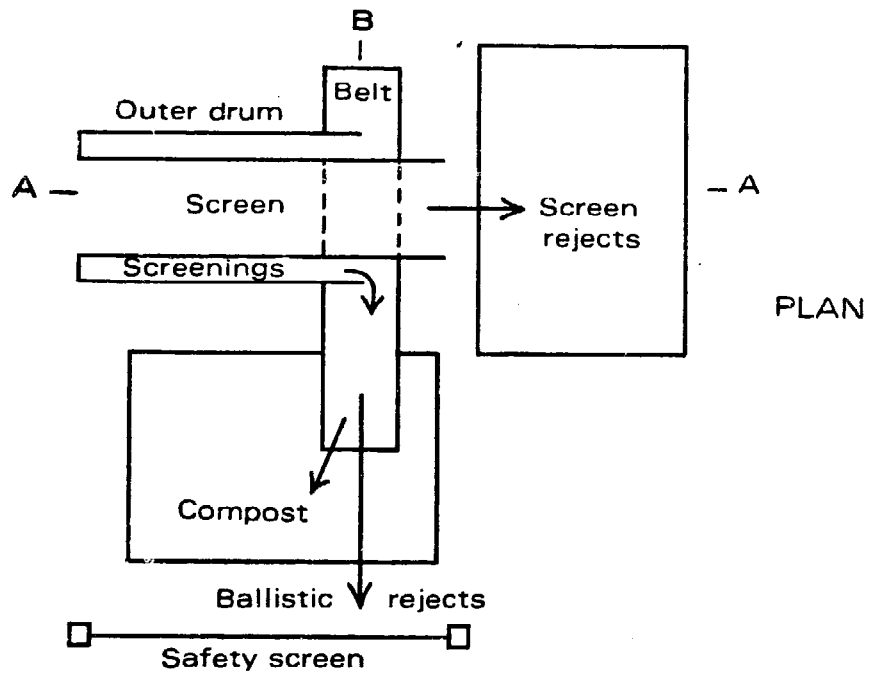
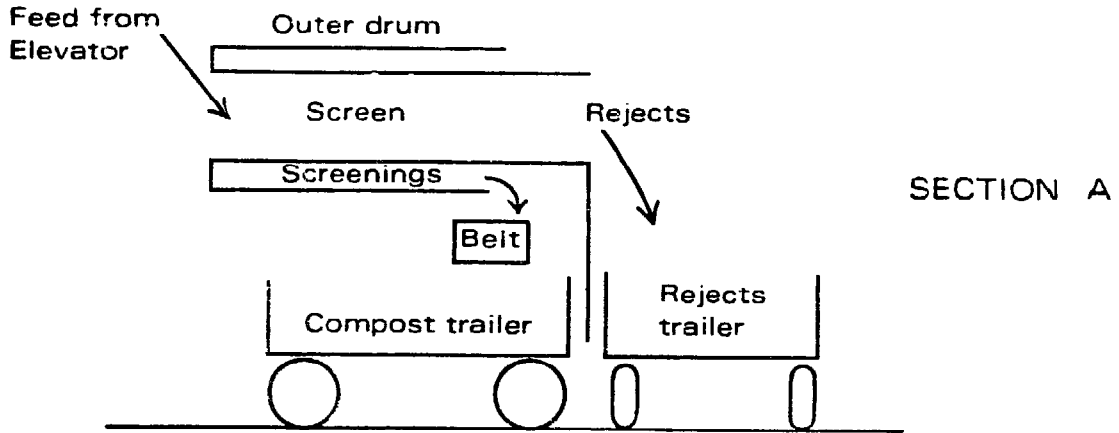
This windrow compost plant with post-treatment by rasp and screen, built at Bangalore by the Karnataka Compost Development Corporation, 1976/77, has the following characteristics :

- input capacity 200 tonnes/day mixed wastes from markets and communal containers,
- density as delivered 400 kg/cu m = 500 cu m/day,
- density after windrowing estimated to be 600 kg/cu m,
- daily volume after windrowing and moisture loss, 250 cu m.,
- daily operating period, minimum 7 hours, maximum 10 hours.

The plant provides for incoming wastes to be weighed after which they are delivered direct to the windrow site, thus the vehicles which deliver the wastes must have tipping gear. The crude wastes are formed into windrows by a front-end-loader and will be turned three times during a retention period of 20 days. Turning may be done by a front-end loader or by an auger machine. On the 20th day the wastes are removed from the windrow by a front-end loader and transported by tractor-trailer to a treatment

Figure 33

50 TONNES/DAY TREATMENT PLANT







## Turning programme

1st day	Stacking
5th day	Turn
10th day	Turn
15th day	Turn
20th day	Remove to treatment plant.

## Treatment plant

Weight/day 150 tonnes  
Volume/day 250 cu m.

Hopper capacity 50 cu m having a discharge side (for vehicles) at least 12 m long to permit two vehicles to discharge simultaneously.

Slat conveyor to run full length of hopper and elevate to feed picking belt in salvage room. Slat conveyor 1 m wide with speed variation 2-4 m/minute.

Picking belt speed 10 m/minute; chutes for transfer of salvage to ground level containers; overband magnet.

Rasp fed by picking belt, perforated plates available in 25 mm and 35 mm sizes.

Rasp discharges to troughed conveyor belt which delivers to a separate screen building. The open air section of the conveyor will have a walkway and the belt will be protected by detachable covers.

The screen will comprise three sections capable of grading from 10 mm upward; it will be totally enclosed to minimise dust but easy access will be provided for cleaning and maintenance. At the entrance to the screen will be a bi-furcated chute to permit the screen to be by-passed. Trailers will be provided to receive materials from by-pass chute and screen sections.

Plant products	Compost, maximum 120 tonnes/day. Rejects, by hand-sorting and rasp, up to 30 tonnes/day.
Storage area	Daily volume, say 200 cu m. Storage up to 150 days = 30,000 cu m. Storage pattern: continuous flat heap about 2 m high = 15,000 sq m area.
Minimum land required	Entrance, weighbridge, administration and other buildings 0.20 Ha. Windrow area 0.72 Treatment plant, workshops, plant park etc. 0.30 Roads 0.50 Storage 1.50 3.22 Ha.

(Actual site area at Bangalore is 6 Ha.)

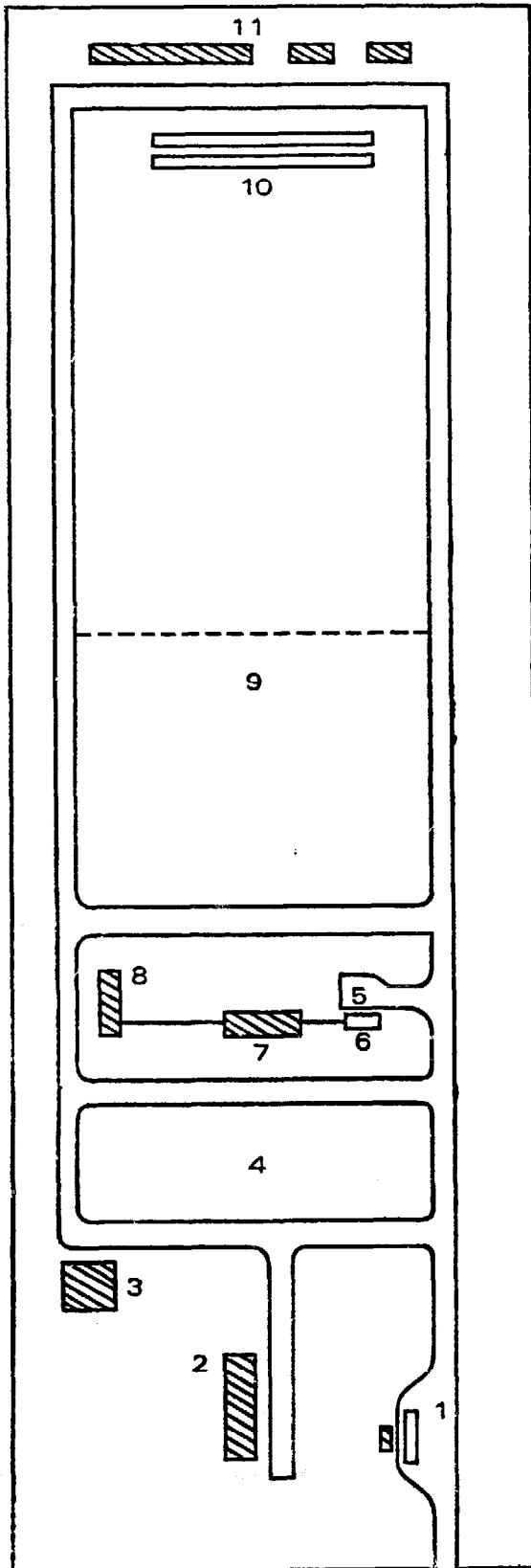
The logistics and cost estimates for this plant are dealt with in Chapter 19, in comparison with alternative methods.

NOTE: An interesting design aspect of this plant concerns the relationship between rasing and screening. The pilot tests showed that, after windrowing, the proportion of oversize compostable matter was not more than 10% by weight and about 20% by volume. It would have been possible, therefore, to eliminate the rasing process and to have used screening alone. In this case it would have been necessary to return compostable screen rejects to the windrows for a second composting cycle. The capital cost would have been reduced by about Rs. 1,000,000. The argument in favour of the rasing stage is that it increases the weight of plant output for direct delivery to the maturing area and it separates intractable rejects such as bricks.

The decision to include the rasing process having been made, the question then arises as to whether screening is necessary. This is an issue which depends upon rasing performance. Known rasp performance with crude refuse is 10-12 tonnes/hour, only half what is required at Bangalore. It is certain to be much higher with composted wastes, but the multiplying factor is unknown, and the problem will be solved by trial and error; 25 mm segments will be fitted initially and if these pass the wastes at the required rate the product could go straight to the maturing area unless it is necessary to screen out a 10 mm horticultural grade of compost. If, however, it proves necessary to increase perforation size to achieve the necessary

Figure 34

POST-FERMENTATION PLANT 200 Tonnes/Day  
KARNATAKA COMPOST DEVELOPMENT CORPORATION, BANGALORE



1. Weighbridge
2. Administration
3. Welfare
4. Reserve area
5. Ramp road to receiving hopper
6. Hopper
7. Salvage and Rasp building
8. Screen house
9. Compost storage area
10. Windrow area,  
2 windrows are shown
11. Stores and maintenance buildings

Roads are 7m wide  
The site has a bore well and a water storage tower

throughput 25 mm screening will be necessary, and for this plant, the first of its type, the inclusion of the screen is prudent.

A final question is whether screening should take place before or after rasping. If the crude compost was screened first, the rasp would receive only oversize matter, the volume of which would be unlikely to exceed 25% of plant intake. In these circumstances the required capacity of the rasp would be greatly reduced and a smaller machine would suffice with a consequent reduction in capital cost and energy consumption.

**Pre-treatment Plant**  
**400 Tonnes/Day**  
**18.4.**

The plant, has a capacity of 24 tonnes/hour divided between two independent lines and is representative of the type of compost plant which has been most popular since about 1960. It comprises bunker storage to facilitate multiple—shift operation, salvage recovery, size reduction by hammermills, screening, magnetic extraction, windrowing in the open and post-fermentation treatment. Each numbered element is described below:

**plant elements**  
**18.4.1.**

(1) Wastes are delivered in vehicles with hydraulic ejector plates.

(2) & (3) A weighbridge is provided at which all materials entering or leaving the plant are weighed and recorded.

(4) Because of the nature of the site, deep excavation for the storage bunker was not practicable and its base is at ground level. The necessary height for storage capacity has been achieved by building an inclined road up which the vehicles are driven to an unloading apron at the top.

(5) The tulip pattern grab has a clearance of 6.8 metres and a capacity of 1.5 cubic metres. It is controlled from a fixed cabin.

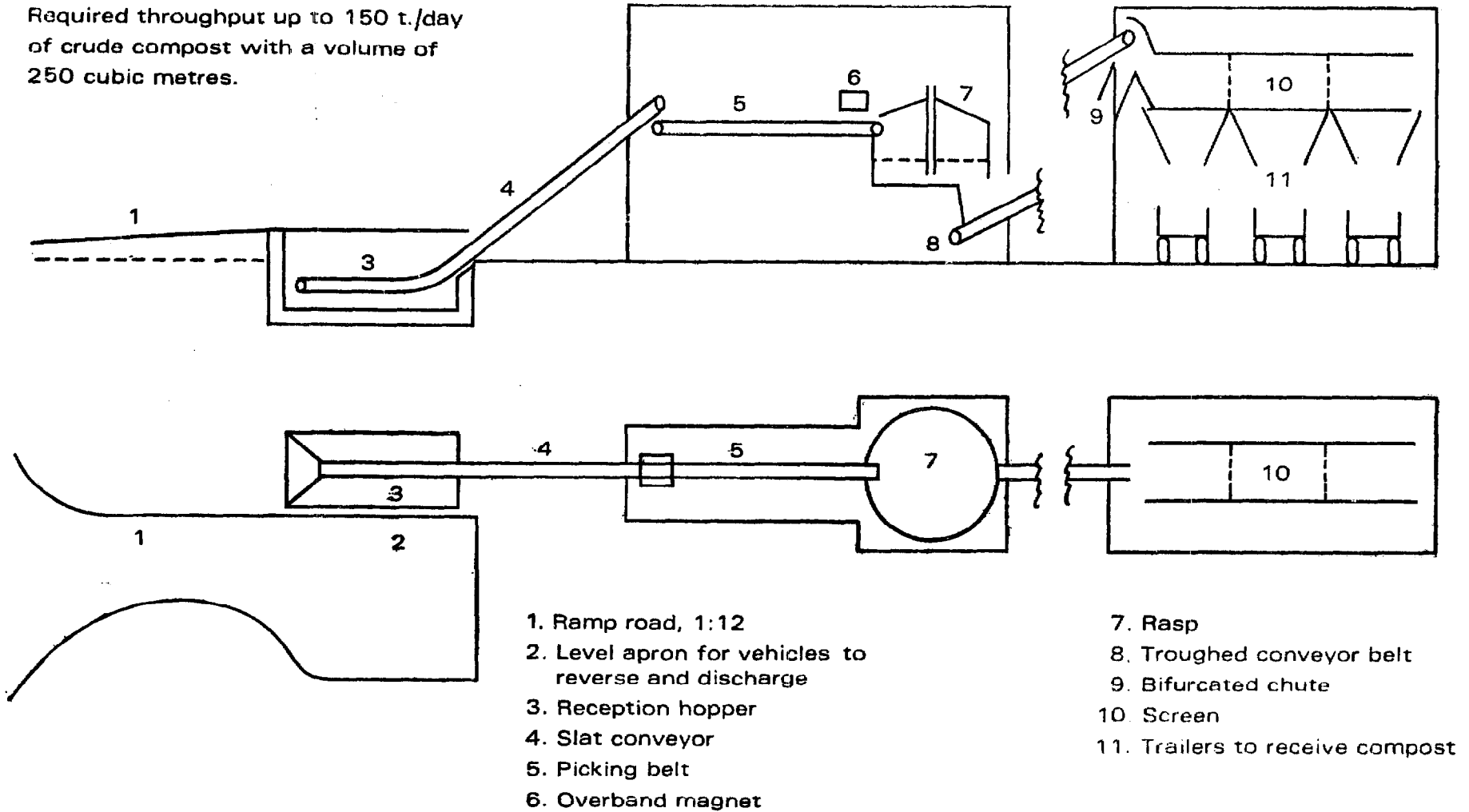
(6) The capacity of the bunker is 1,700 cu metres gross. Part of this capacity is not usable normally because the wastes form a heap on the open side of the bunker. If necessary the grab could be used to move the wastes to the rear of the bunker which would then hold (at the current density of 280 kg/cu metre) about 450 tonnes, but as normally operated the capacity is about 300 tonnes, say 15 hours of operation.

(7) Wastes are transferred from the bunker to one of two elevators. These are steel plate conveyors (slat conveyors), inclined at an angle of 25°, and driven by variable speed motors in order that the rate of feed to the hammermills can be regulated.

Figure 35

KARNATAKA POST-TREATMENT PLANT 200 tonnes/day

Required throughput up to 150 t./day  
of crude compost with a volume of  
250 cubic metres.



(8) Each elevator discharges directly to a picking belt with stations for 18 men, 8 of whom pick paper; 2, metal; 2, glass; 2, plastics; and the remainder deal with rejects or are mobile.

(9) Chutes are provided on both sides of the belts for products of the picking belt.

(10) The chutes discharge to conveyor belts which transport each product to a container or trailer at ground level. Full trailers are taken to the appropriate area for further sorting, as in the case of textiles, or to a baling press as in the case of paper.

(11) The wastes which remain after hand-sorting are discharged to a feed chute leading to a hammermill.

(12) Each hammermill has a capacity of 12 tonnes/hour and is of the horizontal shaft type with expendable hammers. These can be turned and changed side to side to prolong their lives. Initially hammer life was 48 hours, equivalent to about 600 tonnes of wastes, but by the use of improved steel and heat treatment this has been extended considerably.

(13) As the pulverised wastes leave the hammermill they are transferred to a separate building by means of an enclosed chain conveyor.

(14) Ferrous metals are extracted first by a magnetic head pulley and later by an overband magnet.

(15) The vibrating screen is fitted with plates having circular perforations of 100 mm diameter. Other sizes could be used if necessary.

(16) Screen rejects are carried away by a conveyor belt.

(17) The treated wastes are conveyed by an elevator belt to the distribution system in the windrow area.

(18) Formation of the windrows, 25 metres long x 6 m. wide x 3.5 m. high, is performed automatically by a system of overhead conveyors on travelling carriages.

(19) After several days these windrows are removed by front-end loader (20) to an adjacent area. This operation provides the first turn.

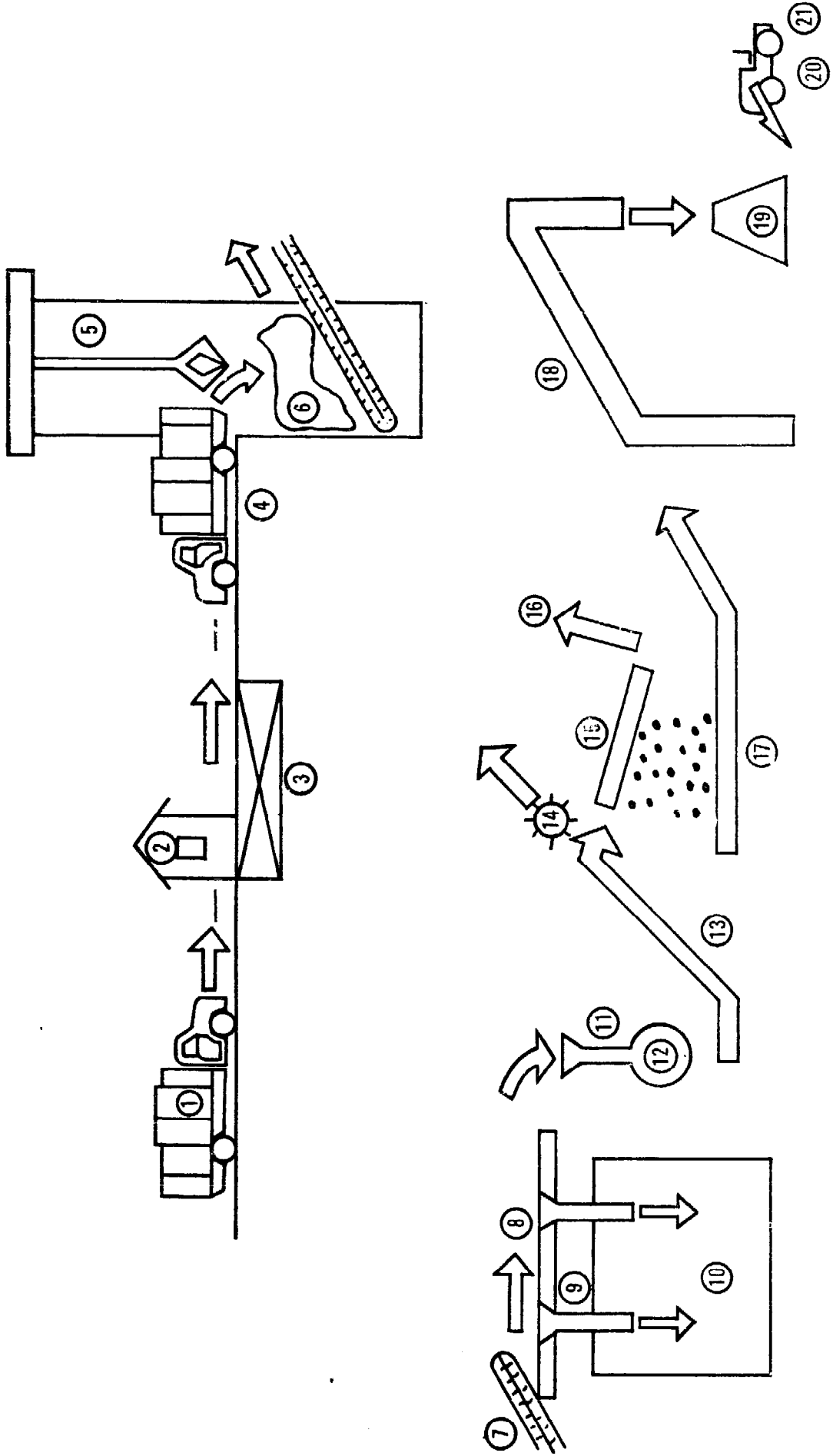
(20) When fermentation in the windrows is completed, the coarse compost, which still contains much oversize and contrary matter, receives post-fermentation treatment in a separate building; this comprises a hammermill and a vibrating screen the mesh of which is normally 20 mm.

**estimated  
costs  
18.4.2.**

In the following estimate, capital costs and labour and administrative staff numbers are factual. All other figures are the writer's estimates, based on the actual performance that may be expected over the total life of the project, expressed in average unit costs for India, 1975.

Figure 36

PRE-TREATMENT PLANT, 400 tonnes/day  
(Mexico Federal District)





This plant is of particular interest in that it is operated over three shifts, effectively about 20 operating hours/day. This has the advantage of spreading fixed costs over a much greater tonnage, but to make it possible some extra capital cost had to be incurred in the form of bunker storage and increased windrow area. Labour costs and maintenance costs are, of course, proportional to the number of shifts worked, and mobile plant must be depreciated over a much shorter period compared with single shift working.

The annual throughput is calculated on a three-shift basis for 5 days a week, less four hours/day for maintenance and shift changing :

2 lines x 10 tonnes/hour x 20 hours/day x 250 days/year = 100,000 tonnes of wastes entering the plant; compost production 50,000 tonnes/year.

	<i>Rupees</i>	
	<i>Annual cost</i>	<i>Cost/tonne compost</i>
<b>FIXED PLANT</b>		
Capital cost actual at 1972 prices :		
Mechanical	Rs 10,000,000	
Civil	Rs 16,000,000	
	= Rs 26,000,000	
Depreciation, 15 years	1,730,000	
Interest 10% on outstanding loan, = average 5%	1,300,000	
	= 3,030,000	60.6
Mechanical repairs 3% x 3 shifts	900,000	
Civil repairs, 1%	160,000	
	= 1,060,000	21.2
Energy, Rs. 2/tonne wastes received	200,000	4.0
<b>MOBILE PLANT</b>		
Capital cost 2,000,000, life 3 years,	660,000	
Interest average 5%	100,000	
Maintenance, 33% (3 shifts)	660,000	
Fuel	60,000	
	= 1,480,000	29.6
<b>LABOUR &amp; ADMINISTRATION, 3 shifts</b>		
205 men x Rs. 3,000/year	615,000	
85 skilled or admin. workers x Rs. 7,000	595,000	
	= 1,210,000	24.2
<b>Total Annual Expenditure</b>	<b>6,980,000</b>	<b>139.6</b>
<b>INCOME</b>		
Salvage 1% of intake = 1,000 t. x Rs. 250	250,000	5.0
<b>NET COST</b>	<b>6,730,000</b>	<b>134.6</b>

If total compost production of 50,000 tonnes/year was sold at Rs. 50 a tonne, income would be Rs. 2,500,000, and the net cost of refuse disposal Rs. 4,230,000, equivalent to Rs. 42/tonne of wastes received. For most Indian cities this would be an unacceptable level of expenditure.

## CHAPTER 19.

### FINANCIAL EVALUATION OF COMPOSTING METHODS

The four examples of composting plants described in the preceding chapter range in capacity from 3 to 400 tonnes/day, in capital intensiveness from Rs. 1,300 to Rs. 65,000/tonne of capacity/day, and in method from simple post-treatment to full pre-treatment.

It is probable that compost produced by any of these methods would be similar in essential characteristics, but the cost/tonne of compost produced appears to range from Rs. 33 to Rs. 135/tonne based on Indian unit costs. It is not easy to produce accurate comparative costs of the many alternatives and variations which are possible in plant size and extent of mechanisation which occur throughout the world. Thus it is necessary to design a standard method based on the unit costs of a city or region, by which systems could be compared in cost.

This requires that all variables other than those arising from the system itself should be excluded by applying standard costs for land and equipment, rates of interest, depreciation etc. Analysis of the composting process reveals that there are seven easily defined elements, most of which are common to all systems, and for which standard costs could be calculated.

The separation of these elements for costing purposes facilitates their application to a wide variety of plant sizes and composting systems.

Section 19.1 defines these elements and suggests performances and costs. In sections 19.2 and 19.3 these standard costs are applied to plants of 3, 50 and 200 tonnes/day capacity, and for the largest plants pre- and post treatment are compared.

The parameters and costs in the following pages have been derived from many sources: projects prepared by Indian cities, discussions with Indian engineers, and the writer's general experience in India and other countries.

#### **Standard Costs 19.1.**

Readers should substitute current costs for their own areas when applying the system to a proposed project.

**land, paving,  
admin.  
buildings  
19.1.1.**

This is a cost which is common to all types of plant and is roughly proportional to capacity, as most of the space is occupied by windrows and stored compost.

(1) Land: 200 square metres/tonne of refuse intake, cost Rs. 100,000/Ha.

(2) Site preparation: all sites to be levelled and fenced, and 37.5% of total area paved and drained; inclusive cost Rs. 50/square metre of paved area.

(3) Electricity supply to site: for 200 tonnes/day is based on 100 outlets and 20 exterior lighting columns, it does not include a supply to a treatment plant which is included in plant costs.

(4) Administrative buildings: construction cost of offices and an amenity block, Rs. 540/square metre, provision of 25 tonne weighbridge with office, Rs. 250,000.

(5) Water supply: assumes the provision of a storage tank and 25 mm distribution system (400 metres of pipe for the 200 tonnes/day plant).

(6) Miscellaneous: includes office furniture, laboratory equipment, hand tools etc., at the rate of Rs. 100,000 for 100 tonnes/day.

Depreciation of all these items is at 5%/year, except light fitting and miscellaneous which are 10%.

Annual maintenance cost of all items is 1½%.

**pre-treatment  
plant  
19.1.2.**

These costs are not universally applicable; they are usually an alternative to post-treatment.

The traditional pre-treatment plant would be composed of the following stages:

- storage hopper with slat conveyor, or bunker with grab-crane,
- elevator and picking belt with overband magnet,
- pulverisation by drum, hammermill or rasp,
- screen, and
- ballistic separator.

The general characteristics of such a plant would be:

- each flowline would have a capacity of about 10 tonnes/hour, which, if operated for 10 hours/day, would give a capacity of 100 tonnes/day,
- large plants would have multiple flowlines,
- capital cost per flowline would be about Rs. 4,000,000 for mechanical and electrical plant and associated civil works (foundations etc.) equivalent to Rs. 40,000/tonne of capacity/day.
- installed n.p. would be about 200 per flowline.

Depreciation would be at an annual rate of 10%, and maintenance cost 3%.

Where windrowing is performed manually, performance is estimated to be 5 tonnes (up to 15 cubic metres according to density) per man/day.

**windrowing plant  
performance and cost  
19.1.3.**

When windrowing is carried out by mechanical shovels (front-end loaders), it is necessary to use different performances in the case of crude refuse than for pre-treated refuse, the volume of which is reduced by the pulverisation process.

(1) Shovel performance with crude refuse :

Bucket capacity 1.0 cu metres\* = 0.4 tonnes x 320 cycles/day  
= 128 tonnes/shovel/day.

Jobs for 200 tonnes/day intake :

stacking	200 tonnes	
turning, 3 x	550 "	(allowing for losses)
removal to plant	150 "	(after decomposition)
selling from stock	100 "	compost
Total task	1,000 tonnes/day to be handled	

For this task 8 machines would be required and a spare would have to be available, a total of 9 front-end loaders.

(2) Shovel performance with pre-treated wastes :

Bucket capacity 0.7 cu metres = 0.4 tonnes x 320 cycles/day  
= 128 tonnes/shovel/day.

Jobs for 200 tonnes/day intake :

stacking	150 tonnes
turning, 3 x	400 "
removal to stockpile	100 "
selling from stock	100 "
Total task	750 tonnes/day to be handled.

For this task 6 machines are needed, plus 1 spare, total 7.

(3) Mechanical shovel operating costs :

Depreciation 1/7th of Rs. 170,000	24,300
Interest 6½% (see note later)	11,050
Maintenance, 20% of cost	34,000
Fuel, 20 litres/day = 6,000/year x Rs. 1.16	7,000
Driver	5,000
Annual cost	Rs. 81,350

The type of plant assumed here would be an alternative to the pre-treatment process and would be required where the wastes were windrowed in their crude state. The characteristics of a post-treatment plant are likely to vary with its capacity.

**post-treatment  
plant  
19.1.4.**

\* Based upon a standard "Escort" 0.7 cu m bucket fitted with extended tines (say 300 mm) which facilitate penetration of crude wastes and increase bucket capacity without exceeding permitted maximum weight. Long tines are not suitable, however, for pre-treated wastes or finished compost.

(1) Plants of 200 tonnes/day (based on Bangalore design, 18.3.):

- storage hopper with slat conveyor,
- elevator and picking belt,
- rasp,
- screen.

Required capacity would be about 60% of that for pre-treatment plants because of weight reduction and density increase arising from decomposition. Thus a single flowline at an estimated cost of Rs. 4,000,000 would handle 120 tonnes/day; this is equivalent to Rs. 20,000/tonne of capacity/day. Installed h.p. would be about 100.

(2) Plants of 50 tonnes/day :

- portable conveyors feeding elevator with picking section,
- screen and ballistic separator.

Cost is estimated to be about Rs. 7,000/tonne of capacity/day.

(3) Manual plants of 3 tonnes/day :

- manually operated rotary screen; cost about Rs. 1,000/tonne of capacity/day.

For all this equipment depreciation is taken at 10% and maintenance 3% a year.

**internal  
transport  
19.1.5.**

Internal transport is required for the movement of wastes between windrows, treatment plant and storage. For example at a 200 tonnes/day post-treatment plant trailers would be required on the following scale :

- 4 stationary trailers to be placed under the following outlet points of the plant: hand-picked contraries, screened contraries, two grades of compost,
- + 4 trailers to be exchanged with these when full, total 10 including spares.
- 4 tractors for towing trailers, total 5 including spares.

Internal transport requirements for pre-treatment would be similar, although the functions would be in a different order.

Tractor trailer costs are as follows :

	Tractor	Trailer
Depreciation, 10%, Rs. 50,000 & 15,000	5,000	1,500
Interest 6½%, see note below	3,250	1,000
Maintenance, 10% of cost	5,000	1,500
Fuel, 15 litres/day x 300 days x Rs. 1.16 litre	5,250	
Driver	5,000	
Annual cost	Rs. 23,500	4,000

**manual workers  
19.1.6.**

Drivers are included in vehicle costs. The annual cost of other manual labour is assumed to be :

skilled worker	Rs. 7,000/year
unskilled worker	3,000

This is an approximate average of a very wide range of labour cost as between rural areas and large cities.

From an examination of several project reports it would appear that the probable cost of managerial, technical, marketing and ancilliary services is equivalent to Rs. 7/tonne of compost produced. This figure would be equally applicable to a chain of small rural compost sites organised and supervised on a regional basis.

**administration**  
**19.1.7.**

Water : Rs. 5/1,000 gallons. If 200 gallons were used/tonne of compost the unit cost is Rs. 1/tonne of compost.  
Electricity : Rs. 0.20 kwh.

**other unit costs**  
**19.1.8.**

The hours of operation are assumed to be 300 days/year, 7 hours a day for manual operation and up to 10 hours/day at mechanised plants.

**hours of operation**  
**19.1.9.**

Depreciation rates vary and have been indicated earlier. They are treated as the equivalent of annual loan repayments. Interest is assured to be 12% but is calculated on a basis of equal annual loan repayments so that the average interest payment over the total loan period is about 6½%. Amortisation is, therefore, as follows:

**amortisation**  
**19.1.10.**

— for a depreciation rate of 5%:  $5\% + 6\frac{1}{2}\% = 11\frac{1}{2}\%$   
— “ “ “ 10%:  $10\% + 6\frac{1}{2}\% = 16\frac{1}{2}\%$

In the following pages comparative figures are given for the evaluation of post and pre-treatment plants of 200 tons/day and post-treatment plants of 3 and 50 tonnes/day.

**Post and Pre-treatment  
Plants of 200 Tonnes/Day  
19.2.**

This section provides an example of how the performances and costs which have been given above may be applied to the problem of comparing two plants of different types.

**estimated capital costs  
19.2.1.**

	<i>Rupees</i>	
	<i>Post-treatment</i>	<i>Pre-treatment</i>
Land	400,000	400,000
Site fencing, paving, drainage	750,000	750,000
Administrative buildings:		
Offices etc.	250,000	250,000
Amenities	500,000	500,000
Weighbridge	250,000	250,000
Electricity supply	50,000	50,000
lighting	50,000	50,000
Water supply	70,000	70,000
	<b>2,520,000</b>	<b>2,520,000</b>
Pre-treatment plant, 2 lines x 4 millions		8,000,000
Post-treatment plant, 1 line x 4 millions	4,000,000	
Windrowing plant, shovels 8 or 5	1,360,000	850,000
Internal transport: tractors 5	250,000	250,000
trailers 10	150,000	150,000
<b>Total capital cost</b>	<b>8,280,000</b>	<b>11,770,000</b>

**estimated operating costs  
19.2.2.**

	<i>Annual cost</i>	<i>Rs./tonne compost</i>
(1) Land, paving buildings amortisation		
Land, 11½%	46,000	1.530
Paving,	86,300	2.875
Buildings,	115,000	3.830
Electricity supply, 11½%	5,700	0.190
Lighting, 16½%	8,300	0.275
Water supply, 11½%	8,000	0.270
Miscellaneous, 16½%	33,000	1.100
	<b>302,300</b>	<b>10.070</b>
Repairs, 1½% *	37,860	1.260
<b>Total</b>	<b>340,100</b>	<b>11.330</b>
(2) Pre-treatment plant:		
Amortisation, 16½%	1,320,000	44.000
Repairs, 3%	240,000	8.000
Electricity, 300 kw x LF 80%		
= 240 kwh x 10 hours x 300 days	144,000	4.800
<b>Total</b>	<b>1,704,000</b>	<b>56.800</b>

\* NEERI prefer to allow at least 2% for civil and buildings maintenance.

	Rupees	
	Annual cost	Rs./tonne compost
<b>(3) Windrowing after pre-treatment :</b>		
Shovels, 7 x Rs. 81,350	569,500	18.950
Water	30,000	1.000
	<b>599,500</b>	<b>19.950</b>
<b>(4) Post-treatment plant :</b>		
Amortisation, 16½%	660,000	22.000
Repairs, 3%	120,000	4.000
Electricity, 100 kwh x LF 80% = 80 kwh x 10 hours x 300 days	58,000	1.930
	<b>838,000</b>	<b>27.930</b>
<b>(5) Windrowing before post-treatment :</b>		
Shovels, 9	732,200	24.405
Water	30,000	1.000
	<b>762,200</b>	<b>25.405</b>
<b>(6) Internal transport :</b>		
Tractors, 5 x 23,500 a year	117,500	3.917
Trailers, 10 x 4,000 a year	40,000	1.333
	<b>157,500</b>	<b>5.250</b>
<b>(7) Manual workers :</b>		
Skilled, 4	28,000	0.933
Unskilled, 50	150,000	5.000
	<b>178,000</b>	<b>5.933</b>
<b>(8) Administration</b>	<b>210,000</b>	<b>7.000</b>

**summary of comparative costs  
19.2.3.**

	Post-treatment		Pre-treatment	
	Rs./year	Rs./tonne	Rs./tonne	Rs./tonne
Land etc.	340,100	11.337	340,100	11.337
Pre-treatment	—	—	1,704,000	56.800
Windrowing	762,200	25.405	599,500	19.950
Post-treatment	838,000	27.930	—	—
Internal transport	157,500	5.250	157,500	5.250
Manual workers	178,000	5.933	178,000	5.933
Administration	210,000	7.000	210,000	7.000
	<b>2,485,800</b>	<b>82.855</b>	<b>3,189,100</b>	<b>106.270</b>



**Post-treatment Plants  
of 3 and 50 Tonnes/Day  
19.3.**

This section provides a comparison between a mainly manual plant of 50 tonnes/day and an entirely manual plant of 2-3 tonnes/day, similar to those described in Chapter 7. The use of standard costs produces different results from those given in Chapter 7 which were based on actual local costs and which excluded land cost.

**estimated capital costs  
19.3.1.**

	<i>Rupees</i>	
	50 t./day	3 t./day
Land 1 Ha. or 350 sq metres	100,000	3,500
Site fencing, paving, etc., or paving only	187,500	800
Buildings: office	20,000	—
amenities	50,000	—
Electricity supply	10,000	—
lighting	20,000	—
Water supply	20,000	—
Miscellaneous	60,000	600
	*467,500	4,900
Post-treatment plant:		
Conveyor belts	200,000	—
Screen	100,000	3,000
Ancilliary structures	40,000	—
	340,000	3,000
Windrowing plant:		
Mechanical shovel	170,000	—
Internal transport:		
Tractor, 1	50,000	—
Trailers, 3	45,000	—
	95,000	—
<b>Total</b>	<b>1,072,500</b>	<b>7,900</b>

**estimated operating costs  
19.3.2.**

	50 tonnes/day		3 tonnes/day	
	Rs./year	Rs./tonne	Rs./year	Rs./tonne
<b>(1) Land etc: amortisation</b>				
Land 11½%	11,500	1.533	403	1.343
Paving 11½%	21,562	2.875	92	0.307
Office 11½%	2,300	0.307		
Amenities 11½%	5,750	0.767		
Electricity supply 11½%	1,150	0.153		
Lighting 16½%	3,300	0.440		
Water supply 11½%	2,300	0.307		
Miscellaneous 16½%	6,900	0.920	99	0.330
	54,762	7.302	594	1.980
Repairs 1½%	7,003	0.933	74	0.247
	61,765	8.235	668	2.227
<b>(2) Windrowing, shovel                                   water</b>				
	81,350	10.847		
	7,500	1.000	300	1.000
	88,850	11.847	300	1.000
<b>(3) Post-treatment plant:</b>				
Amortisation 16½%	56,100	7.480	495	1.650
Repairs, 3%	10,200	1.360	90	0.300
Electricity, 20 kw, LF 80%	6,720	0.896		
	73,020	9.736	585	1.950
<b>(4) Internal transport:</b>				
Tractor, 1	23,500	3.133		
Trailers, 3	12,000	1.600		
	35,500	4.733		
<b>(5) Manual workers</b>				
Skilled	7,000	0.933		
Unskilled, 65 or 3	195,000	26.000	9,000	30.000
	202,000	26.933	9,000	30.000
<b>(6) Administration</b>				
	52,500	7.000	2,100	7.000
<b>Total costs</b>	<b>513,635</b>	<b>68.484</b>	<b>12,653</b>	<b>42.177</b>

**Summary  
of Comparative Costs  
19.4.**

The following table summarises the result of using this method of evaluation for the four plants :

—————Cost in Rupees/Tonne of Compost Produced—————

	3 t./day manual	Post-treatment		Pre-treatment 200 t./day mech
		50 t./day manual	200 t./day mech	
(1) Land, paving etc.,	2.227	8.235	11.330	11.330
(2) Pre-treatment	—	—	—	56.800
(3) Windrowing, loading, etc.	—	11.847	25.405	19.950
(4) Post-treatment plant	1.950	9.736	27.930	—
(5) Manual workers	30.000	26.933	5.933	5.933
(6) Internal transport	—	4.733	5.250	5.250
(7) Administration	7.000	7.000	7.000	7.000
<b>Total expenditure/tonne</b>	<b>41.177</b>	<b>68.484</b>	<b>82.855</b>	<b>106.270</b>
<b>Income/tonne, say</b>	<b>50.000</b>	<b>60.000</b>	<b>60.000</b>	<b>60.000</b>
<b>LOSS/tonne compost</b>	<b>nil</b>	<b>8.484</b>	<b>22.855</b>	<b>46.270</b>
<b>LOSS expressed as disposal cost/tonne wastes received</b>	<b>nil</b>	<b>4.242</b>	<b>11.428</b>	<b>23.135</b>
<b>CAPITAL INVESTMENT/tonne of capacity/day,</b>	<b>2,600</b>	<b>21,450</b>	<b>41,400</b>	<b>58,850</b>

The first conclusion is that in present Indian conditions diseconomy of scale applies to composting and that unit costs of compost production increase as plant capacity rises and mechanisation is increased. Thus, to achieve the lowest production cost, a policy of encouraging multiple small manually operated plants should be followed.

That would not solve the problems of the large urban areas, however, and some mechanisation is almost unavoidable for plants receiving 100 tonnes/day or more of wastes. The most important cost element of the larger plants is for pre-treatment of wastes as received, or for treatment of crude compost after windrowing without prior treatment. If the figures above are reasonably correct (and they must be revised where local conditions are different from the assumptions made by the writer) pre-treatment costs about Rs. 57/tonne while post-treatment costs much less: about Rs. 28/tonne. The explanation is very simple: although the plant processes are similar in most respects, a post-treatment plant requires little more than half the volumetric capacity of a pre-treatment plant.

Next in importance is the cost of mechanical handling, stacking, turning and removing windrows and loading compost. Here the cost at pre-treatment plants is less, Rs. 20 instead of Rs. 26 at post-treatment plants, because pre-treatment reduces the volume to be handled in windrows. More than half of this sum is expended on turning if front-end-loaders are employed, but there may be a possibility of reducing this expenditure if *in situ* turning machines are successfully developed.

Perhaps the most important conclusion for India is that the mechanised 200 tonnes/day post-treatment system disposes of wastes at a cost of about Rs. 11/tonne. This is roughly the cost that would be incurred in the operation of sanitary landfilling to a good standard. It represents an annual expenditure on wastes disposal (excluding collection) of about Rs. 1.5/inhabitant of a city, compared with an annual expenditure of Rs. 15/person or more in Europe. It is a viable method of disposal even when the financial constraints of most Indian cities are taken into account.

## CHAPTER 20. PLANNING A COMPOST PLANT

### **Agriculture** **20.1.**

In sections 2.3 to 2.5 the total dependence of a composting plant on support from the agricultural authorities and the surrounding farming community was stressed. Thus the first stage in planning a compost plant is the enlistment of this support in the following tasks:

- the evaluation of the potential compost in relation to local soil conditions and agricultural methods,
- to put a financial value on the compost on the basis of its estimated nutrient content and in terms of equivalent cost of artificial fertilizers,
- to estimate the potential market for compost within its economic transport range.

With co-operation of this kind, the concept can be based on a realistic estimate of the size of the market and the price that could be obtained for the product.

### **Analyses and Projections** **20.2.**

The next requirement is to carry out physical analysis of the wastes, using an accurate sampling method, to obtain the following information:

- density of wastes,
- proportions of salvageable constituents,
- proportions of contrary constituents,
- proportion of constituents that could be incorporated in the compost,
- graded particle size of the compostable wastes.

A compost plant would normally have a life of 15 to 25 years and over such a long period it is likely that changes would occur in the character of the wastes; this could arise from three main causes:

- a rising standard of living increases the production of solid wastes, particularly constituents other than vegetable/putrescible,
- changes in retail distribution and packaging technology may increase the proportion of packaging wastes,
- changes in domestic fuels, for example a reduction in the use of solid fuel, could change physical and chemical characteristics of domestic wastes.

In cities where annual analyses have been carried out for many years, changes of this kind appear on a graph as

a fairly smooth curve from which it is usually possible to extrapolate for up to 10 years ahead. Where this information is not available, it is prudent to attempt projections based upon national and local estimates of economic growth and industrialisation.

For composting the two vital constituents are vegetable-putrescible matter and paper products; most of the others would be removed as salvage or as contraries. In respect of the relative proportions of these two materials, countries fall into three main categories:

Ratio, paper : vegetable-putrescible matter		
<i>Low GNP/head</i>	<i>Medium GNP/head</i>	<i>High GNP/head</i>
1:20	1:4	2:1
C:N below optimum	C:N about optimum	C:N to high

As GNP/head increases, so does the proportion of paper to vegetable-putrescible matter, thus it is possible to make the following broad generalisations on future wastes characteristics:

- in countries with low GNP/head the character of the wastes will tend to improve for composting purposes,
- in countries with a medium GNP/head the wastes may remain in the optimum range for many years, but the tendency will be towards an ultimate decline in quality,
- where GNP/head is already high, a continuing decline in the composting properties of urban wastes seems to be inevitable.

The total period required for the planning, site acquisition, design and tender stage, and erection of a compost plant is at least two, and often four years. For a comparatively small investment this period can be used to carry out composting on a small scale, with minimum treatment for the following purposes:

**Pilot Tests  
20.3.**

- familiarisation of senior personnel with problems of windrow management,
- the training of at least one junior engineer or chemist in the biochemistry of aerobic composting,
- the training of two or three manual workers in the practical handling of wastes, particularly moisture control, during composting,
- to determine optimum windrowing period by daily temperature records for each windrow,
- testing of the compost for pathogens, insects and weed seeds to re-assure local people as to its hygienic standards.
- to obtain the average N, P and K content of the compost as a partial basis for pricing,
- to produce compost for testing by local agricultural interests and for use in demonstration plots to aid future marketing.

**operation of  
pilot programme**

**20.3.1.**

The most convenient scale of operation is one load/day of wastes, of not less than 8 cubic metres. These loads should be drawn in rotation from different areas of the city so as to represent the average wastes produced.

Each load can be formed into one small windrow and space should be provided for about 20 of them. It may be found possible to reduce the retention period below 20 days after experience has been gained. If the loads are too small to form separate windrows, two may be combined, and the total number will then be only 10.

Each windrow would be built manually and during this process salvage and large contraries would be extracted by hand. Windrows would be turned on the 6th, 11th and 16th days, but there is scope for useful experiment on these intervals. When decomposition was complete the contents of the windrow would be screened; for this purpose a small rotary screen should be provided, operated manually, or by an electric or petrol motor of about one h.p.

The screened compost should then be stored for a few weeks; the minimum period between arrival of the wastes and sale of the compost should be about 40 days. For a daily input of 3 tonnes, three men would be able to perform all the necessary manual operations.

The physical characteristics of this compost may be inferior to that produced in a more sophisticated plant in one respect: it will contain glass fragments. In other ways, however, it would be fairly representative of the ultimate product.

**use of data**

**20.3.2.**

In addition to satisfying the objectives listed earlier, such as training, laboratory sampling and field tests, a pilot project could provide valuable data for the final design of the main project.

A useful guide would be obtained on the qualities and quantities of salvage which could be recovered and the prices obtainable.

The proportions of compost and contraries produced would assist in the accurate detail design of mechanical handling elements.

The proportion of oversize compostable matter in the final screen rejects, such as pieces of paper and cardboard, vegetable stalks etc., which had resisted composition, would provide a measure of the importance of initial size reduction. If such losses were small, the cost of size reduction may not be justifiable in terms of a slightly increased production of compost.

Differences in the composting qualities of wastes, from various parts of the city would quickly become apparent.

If the compost plant was to handle only a proportion of the city's wastes, it would then be possible to select the most suitable wastes for delivery to the plant, leaving the wastes of lower composting value to be disposed of by landfill.

However well it may be designed and operated, a compost plant will never be a good neighbour for the following reasons:

**Site Selection  
20.4.**

- it generates traffic in the form of vehicles delivering wastes and collecting the products of the plant,
- it generates noise from traffic and mechanical plant,
- odour can never be avoided completely; when odours do occur, usually during periods of no wind and high humidity, they are unlikely to be putrid, but they may have a musty character that some people dislike,
- a well operated plant will not produce flies; on the contrary it will destroy them by the million, but, it may attract flies from the immediate neighbourhood of the plant to those areas where fresh wastes are handled,
- the handling of finished compost may give rise to airborne dust.

The location of a site should be on the outskirts of a city in either an industrial or a rural zone; if the former, care should be taken not to put the plant adjacent to factories which may be sensitive to any of the above potential nuisances.

Location of the site in relation to the road network of the area has three requirements:

**road access  
20.4.1.**

- a satisfactory route between the catchment area of the wastes and the plant site,
- good routes from the plant to the main agricultural areas where the compost will be distributed,
- if the site lies off a main road, local access road must be provided.

In most cases it will be necessary to accept a compromise between the first two needs. Where a choice exists, the lowest total transport cost will be attained by locating the plant as close to the city as possible.

The main requirement is that the major part of the site should be level, dry and possess load-bearing qualities appropriate to the civil and mechanical installations contemplated. If part of the site has two levels, or a steep gradient which could be formed into two levels, it is sometimes possible to use this to advantage by putting the reception area at the upper level, thus avoiding or reducing the amount of excavation required for the storage facility.

**site  
characteristics  
20.4.2.**

The total area of the site is determined by the various treatment and handling phases which may include some or



all of the following:

- reception, storage and pre-treatment plant,
- windrowing area,
- post-treatment plant,
- compost storage area,
- roads system and weighbridge,
- mechanical maintenance facilities,
- administration, laboratory and welfare facilities.

The minimum areas required for the simpler systems are about :

40 tonnes/day	0.75 Ha.
80 " "	1.50 "
200 " "	3.00 "

The following are desirable features of a compost plant site :

- as far as possible from dwellings,
- space for future expansion,
- a nearby landfill site for disposal of rejects,
- the availability of a water supply from a well, a water-course, or a main supply.

**Design and Tender  
Stage  
20.5.**

Throughout the world there are numerous manufacturers of compost plants, each of whom claims special merits for his system. A city which is contemplating the erection of a plant often comes under heavy commercial pressure to adopt a proprietary system on the basis of a "turnkey" project. If open tenders are invited on no more than a capacity basis the tenders are likely to include such a wide range of systems, of very different capital costs, that evaluation on a truly comparable basis becomes almost impossible. In such a case it is common for the lowest tender to be accepted regardless of operating costs or other factors.

There is no single composting process which is universally viable because of the very wide differences which exist between countries at different stages of industrial development and in different climates. The vital factors are:

- composition of the wastes,
- initial particle size of the compostable wastes,
- labour costs,
- energy costs,
- indigenous manufacturing capacity,
- the required compost quality.

If the wastes are low in packaging materials and of small average particle size, it may be possible to halve the cost of composting by eliminating pre-treatment. In some countries the turning of windrows mechanically may be much cheaper than manually, but there are many places where the reverse is true. In some situations it may be preferable to employ manual labour, even when it is

slightly more expensive than mechanisation, in order to avoid the expenditure of scarce foreign exchange on machines and fuel. There are also areas where the overriding need is to supply the farmer with compost at minimum cost regardless of the contrary content.

For these and other reasons every compost plant should be designed to match local requirements in terms of wastes characteristics, compost quality, and the right balance between capital and labour.

The purpose of the design stage is to produce an outline design which can serve as the basis for comprehensive tenders all employing the same series of processes. The tenders then are limited to the kind of system required, and evaluation is mainly a matter of careful checking, and comparing costs. The main features of the outline design would be:

**design stage  
20.5.1.**

- definition of the required processes,
- capacities of the mechanical elements,
- design constraints (e.g. the maximum speed for a certain conveyor belt),
- specification for roads, building construction and mechanical equipment,
- general layout of the plant.

The work of the design team would be based upon all the preceding phases of the project which have been discussed: consultation with agricultural experts, refuse analyses and projections, the results of a pilot project, all in relation to existing economic constraints.

The design team could be drawn from permanent staff in large cities; for smaller towns the state environmental agency may be able to provide a team. If adequately trained permanent staff were not available from such sources, it would be necessary to employ consultants.

The tender documents will be framed in accordance with local usage. Here it is necessary to stress only the importance of incorporating guarantees of performance of the following kind:

**tenders  
20.5.2.**

- the plant must perform continuously throughout one working day at (say) 10% in excess of rated performance,
- the plant must operate at rated throughput for five successive days,
- the performance of specific elements should be separately guaranteed, for example in the case of hammermills: the life of a set of hammers in terms of weight of wastes treated, and the average particle sizes of the hammermill product.

The tender price should include the supply of sufficient spare parts for one year's operation after final commissioning, a complete parts list and recommended stock-holding, maintenance manuals for all mechanical elements, and the provision of in-house training for plant operators.

## ANNEX I

### PLANNING AND ORGANIZATION OF SOLID WASTES MANAGEMENT SERVICES

The solid wastes management of a city would normally include:

- refuse collection,
- street cleansing and probably gully emptying,
- refuse disposal,
- workshops for vehicles and plant,
- administration: budgetary control, wages, stores, statistics.

In developing countries it has been found that the operation of all these services absorbs from 2 to 5 manual workers/1,000 population and one heavy motor vehicle for about 20,000 population. In certain countries the high ratio of manual workers to population arises through the employment of a large proportion of the workforce on street cleansing; this is sometimes because of inefficient sweeping methods but often because of inadequate refuse collection services, a consequence of which is that a significant proportion of domestic and shop wastes are collected in the form of street refuse.

It is probable that in most cities, given good methods and sound management, efficient services could be provided with a ratio of 2½ to 3 manual workers/1,000 population. Even on this scale, however, the labour force to be controlled is very large, about 1,000 men for a city of 400,000 population. The effective deployment of so many workers demands that day-to-day control should be decentralised into partially autonomous groups, each headed by a leader of suitable quality and training.

Thus the basic organisation for refuse collection and street cleansing should be a group of about 50 workers controlled by an Inspector. The size of this group can be greater—100 or more in densely populated areas, but for these larger groups the inspector requires an assistant. The area controlled by an inspector can be called a district in a city of medium size, a sub-district in a big city.

It is a sound management principle that middle and senior management should control no more than five junior management units. In large cities, therefore, five sub-districts would form one district, headed by a District Supervisor; five districts would form a division headed by a Divisional Superintendent. At the head of this hierarchy will be the officer responsible for the operation of refuse collection and street cleansing within the solid wastes management department.

Such an organisation cannot operate efficiently without a physical infrastructure of the following kind:

- sub-district depots (described earlier in connection with transfer stations),
- district offices,
- divisional offices (in large cities),
- central offices for senior management of the various branches of solid wastes services.

### **Qualifications for Management**

In a large city the director of the department and the assistant directors should be engineers of a discipline appropriate to their main responsibilities, for example:

Operation	Public health engineer
Mechanical services	Mechanical/electrical engineer
Sanitary landfill	Civil Engineer
Administration	Commerce graduate or economist

For the operational control of refuse collection and street cleansing, solid wastes management technicians are necessary, having a basic education to high school standard and a diploma in solid wastes management. The subjects which should be embraced by such a diploma are suggested in Annex II on training.

### **Labour Relations**

A major problem of man-management is that of maintaining the interest of the average worker in his dull and repetitive job. High productivity can be achieved only when motivation is good and some measure of creative satisfaction is provided.

The best approach is that of regular consultation with the workers in order to elicit complaints and suggestions, and also to inform them on management problems and policies, particularly proposals for changes in methods.

The extent to which these consultations are formalised will depend to a large extent on industrial organisation. Where most of the men are members of a trades union, consultation will be structured and some of the initiative will come from the workers' representatives.

Even in the absence of unions, consultation and interchange of views should be strongly encouraged at all levels. They are particularly productive at district or sub-district level, because here every man is known personally by the inspector. Senior managers should also consult directly with workers, informally during day-to-day contacts and more formally, perhaps through divisional meetings, when major policy issues need to be discussed.

## **Health and Safety**

Management at all levels should be vigilant in providing the maximum protection of workers against risks of accidents and ill-health. The following are important issues :

- the regular use of protective clothing,
- avoiding dangerous methods of riding on vehicles,
- hydraulically tipped vehicle bodies sometimes descend suddenly without warning; men should not stand underneath them.
- all cuts and animal bites should be reported without delay in order that first-aid or medical treatment can be provided,
- personal hygiene should be encouraged by the provision of showers for use before leaving work.

## **Planning a Refuse Collection Service**

The planning and introduction of a re-organised refuse collection service is a complex procedure that may extend over several years and contains four stages :

- a preliminary study to provide guidelines for the testing of what appear to be suitable methods;
- one or more pilot projects to test proposed systems and establish work performances and costs,
- production of a Master Plan based on systems that are successful at pilot scale,
- a phased programme of implementation of the Master Plan.

## **Preliminary Study**

The study should have clearly defined objectives which may include :

**Health and aesthetic aspects:** For example wastes must not be exposed to vectors, animals or scavengers during storage; collectors must not sustain skin contact with wastes during collection.

**Systems:** A system must satisfy the specific needs of that area of the city where it is to be applied; thus multiple systems will probably be necessary.

**Mechanisation:** Labour-intensive methods should be used unless mechanisation produces a positive reduction in total expenditure, or is necessary for health protection.

**Indigenous equipment:** Indigenous vehicles and plant are to be used for at least 90% of all investment.

**Productivity:** High productivity will be sought by method and time studies and priority given to ensuring high vehicle productivity.

**Traffic:** Methods should avoid interfering with traffic as far as possible; this implies that animal carts should not be used in the city centre and that motor vehicles should not be parked on the highway for protracted loading periods.

The first step in the preliminary study will be to obtain estimates of wastes generation from the main sources: domestic premises, shops and markets, offices and institutions. Street refuse should also be estimated because it may be handled through refuse collection transfer points. It is also necessary to know the density of the wastes at source, and useful to know the physical constituents. Sampling methods for generation and analysis are described in Chapter 2.

A broad physical survey of the city is then undertaken, to divide it into areas of similar characteristics on which tentative storage and collection proposals could be based in the light of existing knowledge and available equipment. For each type of area the following issues are considered:

#### *Storage*

Communal storage systems of small capacity and short spacing, enclosed, with detachable liners capable of being handled by not more than two men,

Storage in the home, bin capacities for dwellings of various types, and for various collection frequency.

Bin capacities required at shops.

Storage at markets, schools, hotels and other large wastes producers.

Potential use of chutes, and the types of containers to be used in chute chambers.

Responsibility for the provision of containers: owner, occupier or municipality?

#### *Collection :*

Frequency of collection for various areas.

Primary collection vehicles: design of handcarts, animal carts, vehicle capacities in relation to density of wastes from various sources.

Short-range transfer systems: trailers, skips, spacing of transfer stations in areas of various population density, design of transfer stations, list of potential sites.

Potential use of crew collection in shopping areas and single dwelling areas: selection of potentially suitable vehicle types.

Potential for mechanised small containers of 1-2 cubic metres at schools hotels and large stores.

Relationship between collection systems and location of disposal site: vehicle capacity in relation to length of haul; relay systems.

At the conclusion of the preliminary study it should be possible to define the main types of area for which different solutions will be

necessary, probably ranging from city centre prestige shopping to shack communities, and for each situation one or more tentative proposals together with possible scales of cost.

### **Pilot Projects**

The next stage is to test on a limited scale the most promising of the possible solutions that have emerged from the preliminary study. The purpose of the pilot tests would be to obtain the following information :

- accurate work performances for manual labour and vehicles, as a basis for route planning at the implementation stage,
- accurate costs, for comparing rival systems, and for accurate estimating of investment programme and annual budget,
- to try to judge the impact on health and environmental standards of the systems under test,
- to measure public acceptability of the new systems, without which it would be useless to adopt them.
- to judge the acceptability of the new methods to the workers, because their support is also a vital ingredient.
- to find what modifications are needed to equipment and vehicles.

A pilot project normally requires at least 1½ years, because it should run for a complete year in order to cover seasonal changes which occur in wastes generation, and it must be preceded by a period of detailed planning. There may also be delays in acquiring the equipment needed to operate it.

The size of a pilot project is usually determined by the minimum size of an operating unit. For example the minimum for primary collection by handcart would be one transfer unit, say a trailer, thus about six collectors should be employed, and they would serve about 1,200 dwellings. For communal containers, however, a mere dozen would be sufficient to judge their efficacy, and to obtain standard times for emptying them. Thus the population range for pilot projects may be between 2,000 and 10,000.

It is of the utmost importance that a pilot project should be continuously supervised and detailed results recorded throughout the whole of the test period. Each project may require staffing on the following scale in addition to the workers operating it :

- 1 project manager,
- 2 supervisors,
- 3 recorders, 6 for double shift operation,
- 2 social workers.

The social workers have the important task of maintaining a continuous dialogue with residents, to guide them in making best use of the service being provided, to gain a high level of co-operation and to measure the acceptability of the method being employed.

## Master Plan

The results of the pilot projects, judged in the light of cost, public acceptability, and the extent to which primary objectives can be met, can form the basis for a Master Plan which would be implemented by a phased programme over several years.

The Master Plan would define the system to be adopted in every given situation, and would estimate the proportion of wastes from all sources to be handled through each system. On the basis of these estimates, equipment requirements for the whole city can be defined and estimates prepared for capital and operating costs.

The Plan would also establish the geography of operation and control; the locations of transfer points, depots, and offices, and would include standard designs for depots and transfer stations.

## Implementation

Implementation of the Master Plan may involve a complete re-organisation of the refuse collection services. It would impose a very heavy managerial load and it would probably be necessary to place the re-organisation process in the hands of a special project team whose leader ranked as a Deputy Director, in order to allow normal standards of control of current operation to continue.

Training in the new methods would be necessary for manual workers and technicians; a convenient way of achieving this is to maintain the pilot projects in operation as training grounds during the early period of implementation.

It is probable that a large building programme may be necessary to provide the physical infrastructure for the new methods and it is certain that a large amount of equipment would have to be acquired. The capital expenditure involved is a further reason for phasing implementation over several years.

It is likely that implementation would also involve some changes in the management structure, at the very least some of the boundaries between sub-districts and districts may have to be rationalised. The sub-district or district, having a population in the range 20,000 to 50,000 is the recommended basis for re-organisation. In the first year it may be prudent to undertake only one or two districts. In a city with 40 districts phasing could be on the following scale :

1st year	3 districts
2nd "	5 "
3rd "	9 "
4th "	10 "
5th "	14 "

The speeding up of implementation in the later years is possible because detailed route planning can be undertaken continuously by the Project



Team and also because after the first two years a large number of trained personnel will be available for temporary transfer to districts under re-organisation.

It should be stressed that implementation requires the same care in planning and supervision as the pilot projects, but for a shorter period. Every collection route must be precisely defined in writing with every single source listed, and during the first few days of operation a supervisor must continuously accompany the collector or the crew, to advise and train them, and to monitor their working rate.

The success of the implementation programme will depend to a large extent on public relations. Every medium should be used to inform the public of the objectives and to advise them on the duties they must perform as part of the service. The best method is always personal contact. Elected representatives should pay visits from house to house in a district under re-organisation. Social workers should be involved in areas where there are particular difficulties of communication with the people. The press and radio are obvious methods of instruction and publicity. School teachers should be fully informed about the Master Plan so that it can be discussed in classes.

## ANNEX II

### TRAINING FOR SOLID WASTES MANAGEMENT

(A memorandum which was approved by the Solid Wastes Management Workshop held at Ahmedabad in October, 1975, by GOI and WHO.)

The following list endeavours to define the required areas of knowledge for officials employed by cities on the management of solid wastes. From such a list it is possible to compile a syllabus for training and examination at different levels of responsibility, e.g :

Technician	(engineering diploma) only subjects marked T and to limited depth.
Professional	(graduate engineer) all subjects.
Post-graduate	(having already covered all subjects) selected specialisations to greater depth.

#### Introductory

- T Man in the environment
  - The closed cycle
  - Inter-relationship of pollution from all sources
- T Solid wastes in relation to public health

#### Federal and State Law

- T Public health legislation as affecting solid wastes
  - Road transport legislation
  - Relevant labour laws

#### Administration

- Administrative structure of a department and physical infrastructure (depots, workshops)
- T Man-management
- T Work study (method and time study)
  - Cybernetics of relevant manual activities
  - Office organisation and machines

- T Statistics and graphs
  - Cost accounting
  - Preparation of estimates
- T Reports
- T Specifications for materials and equipment
  - Storekeeping systems and records

### Solid Wastes Characteristics

- T Sources and types of solid wastes: domestic, trade, industrial
- T Physical analysis of mixed domestic and trade wastes
- T Determination of density and per-capita production
  - Determination of moisture content and calorific value
  - Projections of wastes production
  - Hazardous wastes

### Storage and Collection of Solid Wastes

- T Determination of collection frequency; the effects of frequency on storage and collection
- T Manually handled storage containers for dwellings and shops
- T Mechanically handled containers for large premises
  - Refuse chutes
- T Communal containers
  - Expendable containers
- T Influence of length of carry, and duties imposed on householders
- T Vehicles: man-drawn, animal-drawn, and motor:
  - design,
  - optimum radii of operation
- T Collection by team:
  - optimum team size,
  - vehicle capacity,
  - work norms,
  - relay systems,
  - planning rounds
- T Collection by single operators:
  - work norms,
  - vehicle capacity,
  - transfer points,
  - planning rounds
- T Collection of contents of mechanically handled containers
- T Exchange systems for hoist or roll-on containers

### Street Cleansing

- T Origin and character of street refuse
- T Road structure in relation to cleansing

**T** Classification of streets for cleansing purposes

**T** Manual sweeping:

    brooms, shovels and other tools  
    hand-trucks,  
    organisation

**T** Gang sweeping, organisation

Mechanical sweepers:

    pedestrian controlled  
    highway sweepers  
    special applications of suction sweepers

**T** Litter containers, design and siting

## Gully and Cesspool Emptying and Street Washing

    Designs and application of tanker vehicles with reversible vacuum pumps

    Organisation of routes

## Transfer Stations

    Inter-relation of collection and disposal systems

    Alternative long-distance transport methods

    Transfer stations, design and operation

## Refuse Disposal

    Re-cycling; pre-separation and recovery

    Land-use planning in relation to solid wastes

    Principles of refuse treatment:

        pulverisation,  
        incineration,  
        composting, and others

    Mechanical elements of treatment plants

    Control of pollution transfer

**T** Disposal on land:

    site selection, relations with other public agencies

    water pollution control at disposal sites

    codes of practice

    preparation and planning of site

    operation of site: manual methods,

        mechanical methods

    vector control

    biochemistry of deposited wastes

    deposit of hazardous wastes

    Comparative costs of alternative treatment and disposal methods

    Comparative environmental impact of alternative methods

## Mechanical and Electrical

An adequate basis of theory is assumed by the entry standard. It is necessary to consider, perhaps at a later stage, provision for training in industrial applications such as treatment plants, and the maintenance of motor vehicles and earth-moving plant. (In Britain training includes several months' experience in workshops.)

### To Be Determined

Should an academic body or a professional body determine syllabus and standards ?

Duration of courses ?

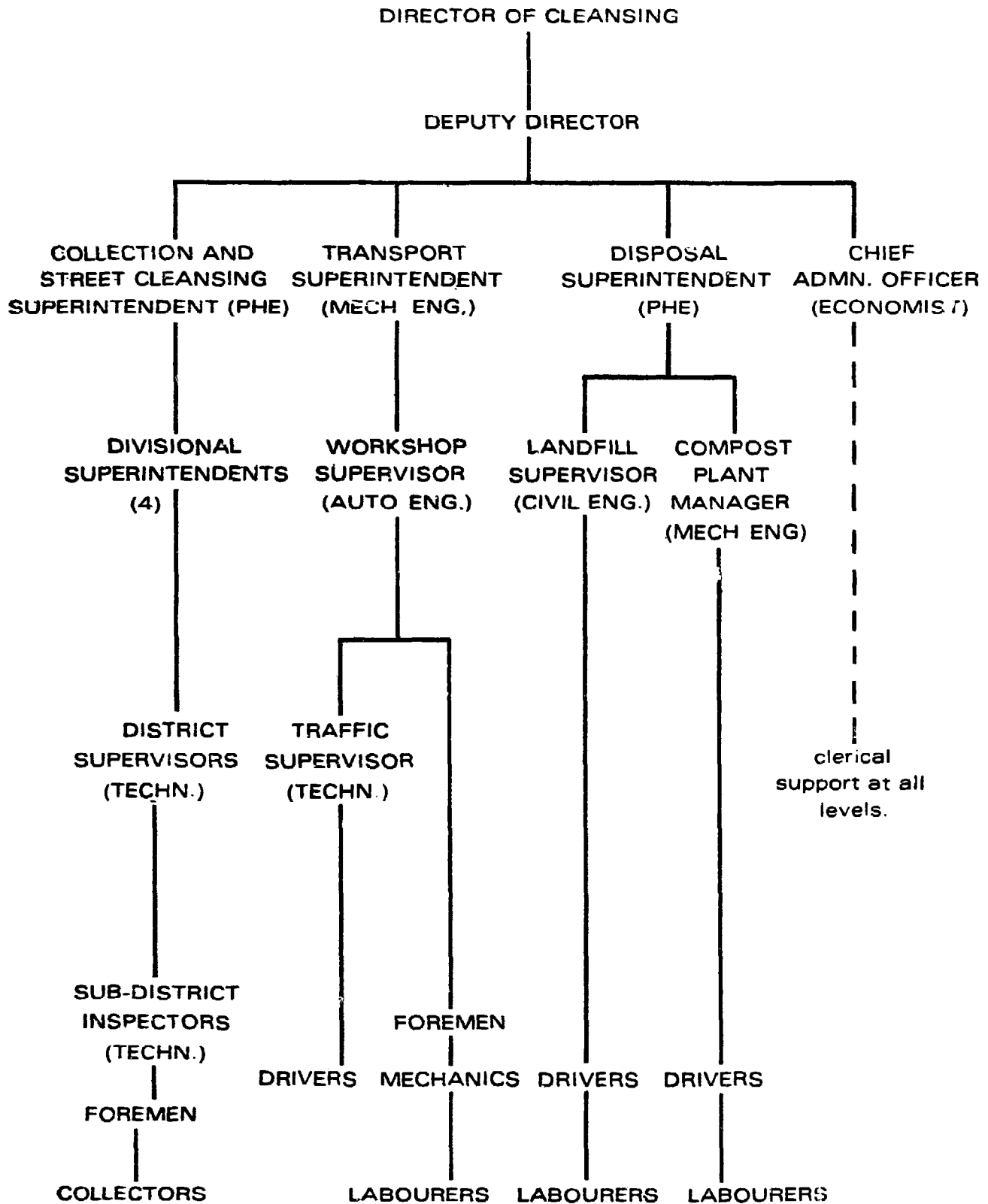
Location of training centres ?

Sources of lecturers ?

Selection of trainees ?

Provision of posts on completion of training ?

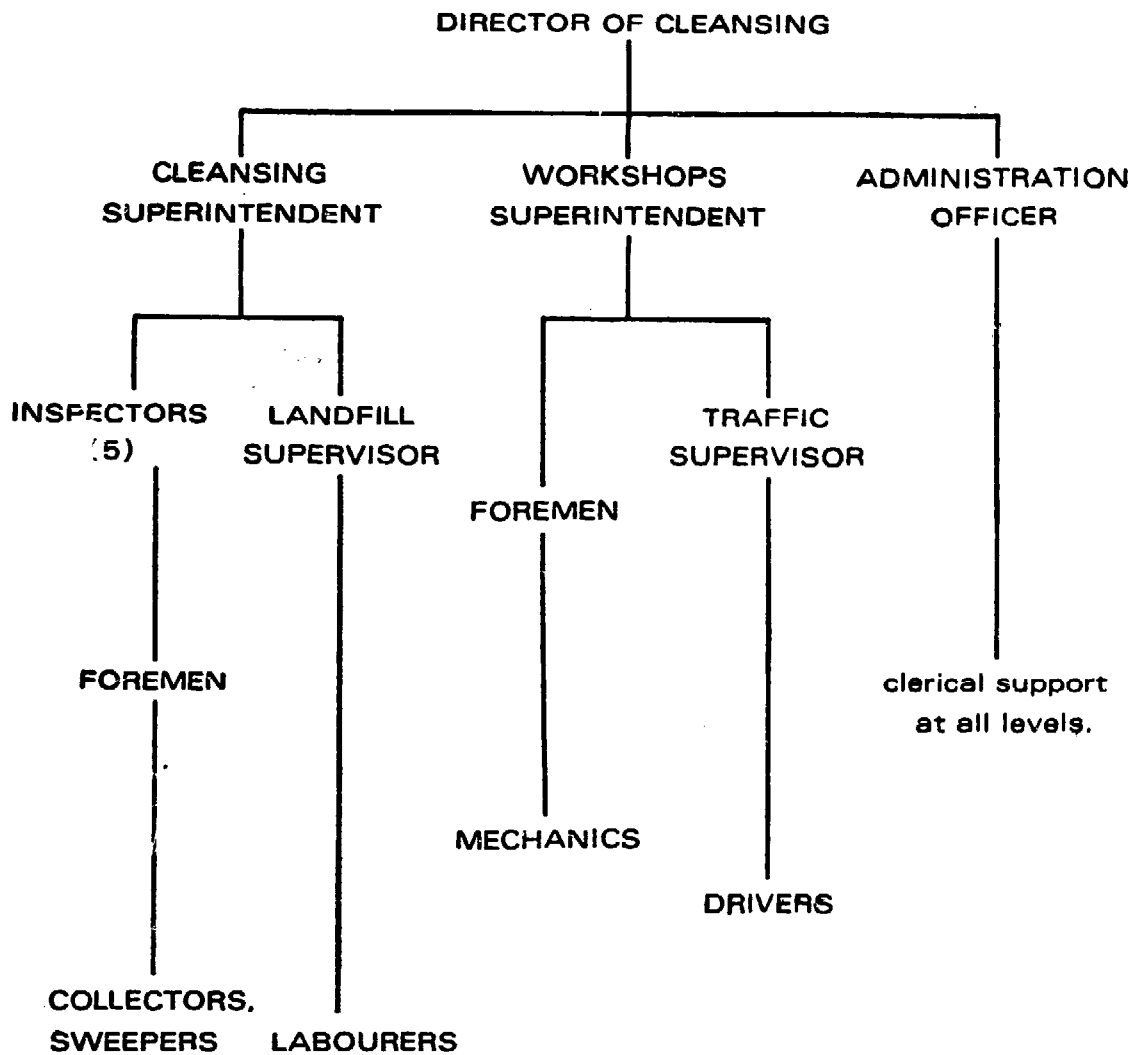
# TYPICAL ORGANISATION FOR 2,000,000 POPULATION



## STAFFING RATIOS FOR SOLID WASTES MANAGEMENT

Ratio	Staff numbers for population of	
	100,000	2,000,000
Manual workers 2.5/1,000 population	250	5,000
Foremen 1/10 manual workers	25	500
Inspectors, 1/50 manual workers	5	100
District supervisors, 1/5 Inspectors	—	20
Divisional superintendents, 1/5 District supyrs.	—	4

### TYPICAL ORGANISATION FOR 100,000 POPULATION



## ERRATA

- Page 55 Section 8.2, para 2, first line, read "from" as "front"
- Page 64 Line 5, for "South East" read "South-East Asia"
- Page 75 Photo 14 is discussed in detail in Section 12.2
- Page 88 Section 12.2.1, para 3, read "base" as "bass"
- Page 106 Section 14.2.2, line 8, delete "that", line 9, for "it" read "which"
- Page 135 Photo 15 caption, read "bumper bay" as "bumper bar"
- Page 137 Section 14.8.4, line 5, for "until" read "unit"
- Page 142 Line 2 should read: "the deposit in water of organic wastes."
- Page 153 Line 1, read "much" as "mulch"
- Page 173 Full para 3, line 3, add "high winds" before "but"
- Page 190 Para 2, line 9, for "with" read "have"
- Page 191 Section 17.5.1, para 3, lines 11-12, for "as they are" read "through being"
- Page 200 Section 18.2, para 1, last line, for "Figures 5 and 6" read "Figures 31 and 32"
- Page 222 Section 19.3.1, line 2, for "or paving only" read "or fencing only"
- Page xvi Credits in footnote, for "photos 4 and 9" read "photos 4 and 10, reproduced on pages 30 and 52"