

AT MICROFICHE
REFERENCE
LIBRARY

A project of Volunteers in Asia

Solar Distillation as a Means of Meeting
Small-Scale Water Demands

Published by:
United Nations
New York, NY 10017 USA

Paper copies are \$ 7.00. Ask for publication
number 70.II.B.1 when ordering.

Available from:
United Nations
Publications Sales
Room A-3315
New York, NY 10017 USA

Reproduced by permission of the Department
of Public Information, the United Nations.

Reproduction of this microfiche document in any
form is subject to the same restrictions as those
of the original document.



SOLAR DISTILLATION

*as a means of meeting
small-scale water demands*

UNITED NATIONS



Department of Economic and Social Affairs

SOLAR DISTILLATION

**as a means of meeting
small-scale water demands**



UNITED NATIONS

New York, 1970

NOTE

Symbols of United Nations documents are composed of capital letters combined with figures. Mention of such a symbol indicates a reference to a United Nations document.

ST/ECA/121

UNITED NATIONS PUBLICATION

Sales No.: E.70.II.B.1

Price: \$U.S. 2.00
(or equivalent in other currencies)

CONTENTS

<u>Chapter</u>	<u>Page</u>
Preface	vi
Explanatory notes	viii
I. Summary and findings	1
A. Current technology and costs	1
B. Potential scope of solar distillation	3
C. Steps for evaluation of solar distillation	3
II. Basin-type solar stills	5
A. Still design	5
B. Theory of solar-still operation	10
C. Still size, rain-water catchment and product storage	15
D. Installation and operation of solar stills	20
E. Economics of solar distillation	23
III. Trends in solar distillation	37
A. Evolution of basin-type stills	37
B. Collection of solar energy: solar ponds	38
C. Combined energy-source systems	39
D. Multiple-purpose systems	39
E. Integrated-function plants	40
References and selected bibliography	59
ANNEXES	
I. Alternative solar-distillation processes	64
II. The theory of solar-still operation	75
III. Water storage requirements and costs	85

LIST OF TABLES

	<u>Page</u>
1. Existing large solar stills, 1969	8
2. Typical solar-still production	16
3. Example of preliminary estimate of solar-still yield	17
4. Capital costs of solar stills	26
5. Estimate of hourly output, q_e , of solar stills, using characteristic chart	83
6. Estimate of solar-still output and storage requirements	85

LIST OF FIGURES

1. Solar still, Las Marinas, Spain	42
2. Schematic cross-section of basin-type solar still	43
3. Schematic diagram of solar distillation plant, showing major items of equipment	44
4. Plan and sections of basin-type solar still, Daytona Beach, United States of America	45
5. Beam and glass seal details of basin-type solar still, Daytona Beach, United States of America	46
6. Plan and sections of solar still, Las Marinas, Spain	47
7. Details of lower beam for solar still, Las Marinas, Spain	48
8. Section of basin-type solar still, Commonwealth Scientific and Industrial Research Organization, Australia	49
9. Section and frame details of basin-type solar still, Technical University of Athens, Greece	50
10. Schematic design for demonstration unit, small-scale basin-type solar still, for use on Pacific Islands	51
11. Schematic sections of plastic-covered basin-type solar stills	52
12. Diagrammatic section of solar still, showing significant energy transport streams to, from and within the still	53
13. Effect of ambient temperature and loss efficiency on predicted still output at $H_s = 2,555$ BTU square foot ⁻¹ day ⁻¹	54
14. Effect of solar radiation and loss coefficient on predicted still output at $T_a = 80^\circ\text{F}$, $C_{wg} = 16$ and wind velocity of 5 miles per hour	55

LIST OF FIGURES (continued)

	<u>Page</u>
15. Comparison of predicted and experimental still performances, Giffith, Australia	56
16. Comparison of results of extended tests of capacity of basin-type solar stills with results obtained from calculations	57
17. Typical solar-still daily production as a function of radiation and average air temperature	58
18. Compression-distillation unit using electric energy from solar-power plant	66
19. Multiple-effect evaporator heated by steam from focusing solar collector	67
20. Multiple-effect evaporator heated by steam from flat-plate collector	68
21. Multiple-effect solar still employing glass covers and copper condenser-evaporator plates	69
22. Glass-covered evaporating pan with reflecting surfaces	70
23. Extruded plastic still with blackwick for evaporation and cooling	71
24. Tilted-tray solar still	72
25. Tilted wick-type solar still	73
26. Experimental multiple-stage flash solar distiller, Puerto Penasco, Sonora, Mexico	74
27. Heat fluxes for a solar still	76
28. Evaporative heat transfer, q_e , <u>versus</u> cover temperature, T_g , for different values of brine temperature, T_w	78
29. Cover heat loss, q_{ga} , <u>versus</u> cover temperature, T_g , for various values of ambient temperature, T_a , and wind velocity	79
30. Characteristic chart for thermal performance of a solar still	80

PREFACE

This study is part of a programme of studies undertaken by the Resources and Transport Division of the United Nations Secretariat which is concerned with questions of applying new technologies and development methods to the water resources problems in developing countries. Particular attention has been focused in recent years on the application of water desalination as a means of meeting real water needs and stimulating development in areas suffering from a shortage of fresh water.

This report is intended to define the conditions under which solar distillation may provide an economic solution to the problems of fresh water shortage in small communities. In particular, the purposes of the study are: (a) to review the current status of solar distillation; (b) to outline the general classes of situations in which it may represent the best solution to water supply problems; (c) to provide a method for potential users to estimate performance and costs of current still designs in their areas; (d) to note practical problems of solar-still design and operation; and (e) to recognize some possible changes in solar-distillation technology and economics which may affect the applicability of the process in future.

The study does not consider the conversion of solar energy into other forms, such as the generation of electrical energy, which may subsequently be used in desalination processes.

The proposals for the present study which were contained in the report of the Secretary-General, "Water desalination with special reference to developments in 1965" (E/4142), were approved by the Economic and Social Council in resolution 1114 (XL) of 7 March 1966.

Accordingly, a panel of experts was convened at United Nations Headquarters from 12 to 19 October 1968, composed of the following persons:

V.A. Baum, Physico Technological Institute, Turkmenian Academy of Sciences, Ashkhabad Turkmen SSR

A.A. Delyannis, Technical University of Athens, Greece

J.A. Duffie, University of Wisconsin, Madison, Wisconsin, United States of America

E.D. Howe, Sea Water Conversion Laboratory, University of California, Berkeley, California, United States of America

G.O.G. Löf, Consulting Chemical Engineer, Denver, Colorado, United States of America

R.N. Morse, Commonwealth Scientific and Industrial Research Organization, Melbourne, Australia

H. Tabor, National Physical Laboratory of Israel, Jerusalem, Israel

Assistance through the provision of material and substantive comments was also rendered by C. Gomella, Société d'études pour le traitement et l'utilisation des eaux (SETUE), Paris, France. Staff members of the Resources and Transport Division of the United Nations participated in the meetings and in the preparation of this report. The United Nations Secretariat is particularly indebted to J.A. Duffie, who assisted in the preparation of this report.

Additional United Nations publications in the field of desalination are listed in the bibliography.

EXPLANATORY NOTES

Reference to "gallons" indicates United States gallons, and to "dollars", United States dollars, unless otherwise stated.

The abbreviation "gpd" indicates gallons per day.

The following table will allow conversion into other units:

<u>To convert</u>	<u>To</u>	<u>Multiply by</u>
gallons (U.S.)	imperial gallons	0.833
gallons (U.S.)	cubic metres	0.00379
1,000 gallons (U.S.)	cubic metres	3.79
square feet	square metres	0.0929
gallons/square foot	cubic metres/square metre	0.0408
dollars/square foot	dollars/square metre	10.77
pounds/square foot	kilogrammes/square metre	4.88
BTU square foot ⁻¹ day ⁻¹	calorie square centimetre ⁻¹ day ⁻¹	0.271
BTU hour ⁻¹ square foot ⁻¹ °F ⁻¹	calorie hour ⁻¹ square centimetre ⁻¹ °C ⁻¹	0.487
BTU square foot ⁻¹ °F ⁻¹	calorie square centimetre ⁻¹ °C ⁻¹	0.487

The nomenclature used in annex II to this report is given below:

C_{wg}	thermal capacity of water, still and ground, BTU °F ⁻¹ sq. ft. ⁻¹
h_{ga}	convective heat transfer coefficient glass cover to air BTU hour ⁻¹ sq. ft. ⁻¹ °F ⁻¹ , having a value of 2.6 for a wind velocity of 5 mph and 7.2 for 20 mph
H_s	solar radiation on horizontal surface BTU hour ⁻¹ sq. ft. ⁻¹
h_w	latent heat of vaporization of water BTU/lb.
k_b	thermal loss coefficient base of still to surroundings BTU hour ⁻¹ sq. ft. ⁻¹ °F ⁻¹
P_w, P_{wg}	partial pressure of water vapour at T_w T_{wg} psi
q_b	heat loss from base of still BTU hour ⁻¹ sq. ft. ⁻¹
q_e	heat transfer brine to glass by evaporation BTU hour ⁻¹ sq. ft. ⁻¹
q_{ga}	heat transfer glass cover to surroundings BTU hour ⁻¹ sq. ft. ⁻¹
q_r, q_c	heat transfer brine to glass by radiation and convection BTU hour ⁻¹ sq. ft. ⁻¹
t	time
T_a	ambient temperature °F
T_g, T_w	temperature of glass cover and saline water °F
α_g, τ	solar absorptance and transmittance of glass cover
α_w	solar absorptance of brine and trough system
η_o	drainage efficiency of still
σ	Stefan-Boltzmann constant 17.2×10^{-10} BTU hour ⁻¹ sq. ft. ⁻¹

I. SUMMARY OF FINDINGS

Solar energy represents a vast energy resource which is most available in many areas where population density may be low and where conventional energy resources may be expensive. Its use for operation of desalination processes for production of fresh water is technologically feasible.

A. Current technology and costs

The most advanced solar still currently in use is the basin-type still, a century-old concept which has been modified and adapted to modern materials and applications. An 11,500-sq. ft. basin-type solar still installed at Las Marinas, Spain, is shown in the frontispiece; and a sectional diagram of a basin-type still is shown in figure 2.*

At the current time, all solar stills can be viewed as being in various stages of development, rather than as an established technology. Some still designs, however, are in advanced stages of development, and considerable operating experience is available upon which to judge their utility and costs. Still productivity can be predicted with some confidence for those designs in which problems of mechanical failure or corrosion are minimized. The most advanced designs are those which use standard materials of construction, such as glass, concrete, asphalt and corrosion-resistant metals. Consideration is also being given to designs that rely in part on new plastic materials. With most designs there are possibilities of construction using, to some degree, locally available materials and labour in the area of application. Construction maintenance and operation do not require high levels of skill in working with complex machinery.

Solar distillation should be considered a possible method for water-supply under the following circumstances:

- (a) Natural fresh water is not available and saline water is available;
- (b) The climate is good (i.e., the solar radiation levels are high);
- (c) The potable water needs for the community or user are below about 50,000 gpd;
- (d) Reasonably level land is available for solar-still sites
- (e) Such land is in isolated locations where inexpensive power and highly trained manpower are not always available.

* Figures 2-17 may be found at the end of the report.

The unique characteristics and problems of solar distillation must be taken into account when evaluating it as a possible method of water-supply in comparison with other methods.

Being based on a time-variable energy source, solar distillation provides a variable output. Summer product-water yields are typically three to four times winter yields. If water needs do not follow the same patterns with time, product-water storage or auxiliary supply, or a combination, must be provided.

Solar distillation is a capital-intensive process, requiring relatively large capital investment per unit of capacity and, in properly designed and constructed systems, a minimum of operating and maintenance costs. Product-water costs thus depend primarily upon still productivity, capital cost of the installation, its service life, and amortization and interest rates.

Solar-still productivity is conveniently referred to, in round numbers, as being, typically, $0.1 \text{ gal sq. ft.}^{-1} \text{ day}^{-1}$ for a good day. It is, however, highly dependent upon solar radiation and less dependent upon air temperature and other factors. On clear winter days a well-designed still will yield perhaps 0.03 and on clear, hot summer days, perhaps $0.12 \text{ gal sq. ft.}^{-1} \text{ day}^{-1}$.

Summing up these yields over a year, experience shows that annual still yields of about 25 gal/sq. ft. are obtained, with some variations due to climate and still design.

The unit capital of solar stills built in recent years has been $\$2.00$ - $\$0.60/\text{sq. ft.}$ Most of the estimates based on current designs of durable stills show costs of materials and labour for still construction to be in the neighbourhood of $\$1/\text{sq. ft.}$

The projected lifetime for stills constructed of concrete, glass and other long-lived materials is twenty years or more. Other still designs have been developed using some materials with shorter service lives which must be periodically renewed.

Assuming favourable interest rates, such as those granted to a public-utility type of venture, and service lives as noted, one obtains water costs of $\$3$ - $\$6$ per $1,000$ gallons. Variations within and from this range are experienced because of rainfall collection, storage costs and unpredicted factors affecting still productivity.

While this cost is high, when measured by the usual standards of large-scale water-supplies, it is based on solar plants with outputs of $25,000$ - $50,000 \text{ gpd}$, or less. Experience thus far with other desalination processes in this small size range has shown product-water costs to be as high or higher, particularly when energy sources have to be especially provided. In plants larger than this, it is clear that other desalination processes can produce water more economically than can solar distillation. It may also be observed that the costs of solar stills do diminish as significant developments occur; however, the costs of competitive processes may also decrease accordingly.

Flexibility in choice of size over a significant range, without significantly affecting unit costs, is an important feature of the solar still.

B. Potential scope of solar distillation

There are other solar processes which may broaden the scope of solar distillation in future, depending upon the success of development studies on the processes and upon further developments in other areas of research not directly related to solar distillation. Some of the areas of current or possible research and development on solar distillation are described below.

Further refinements in basin still design, to improve performance and reduce costs, are being studied. Use of new materials with unique properties and of locally available materials and evolutions of design are potentially important. Some research is directed to development of very small units, in the range of 500 gpd or less.

The basin-type solar still combines the solar-energy collection function and the distillation function in a single unit. Separation of these functions would allow regenerative, or multi-stage processes, to be solar-operated. This development is, of necessity, dependent upon very significant progress in solar-collector technology (i.e., a "breakthrough").

Combined energy source systems, in which solar energy to the still is augmented by waste heat from, for example, intermittently operated diesel or gasoline engines, may reduce the cost of product water from the still.

Multiple-purpose systems, producing some combination of water, salt and possibly power, can be conceived. Within the limits set by relative markets for these commodities, such systems could be significant, but only after very considerable further research and development.

Multiple-function plants, in which water production is integrated with water use, are also being considered, for example, in an integrated system for energy, water and food production.

C. Steps for evaluation of solar distillation

The following steps and considerations are suggested for assessing solar distillation as a method of meeting a particular water need, to provide information with which to compare it with alternatives:

(a) Climate. If the solar radiation climate is good, i.e., skies are generally clear, a solar distillation plant may be feasible. Productivity of stills is a direct function of solar radiation received on a horizontal surface;

(b) Scale of need. Solar distillation now appears suited to water requirements on a relatively small scale, i.e., less than about 50,000 gpd. For larger demands, or demands that are anticipated to increase in the near future, other desalination methods are now more economical;

(c) Site. Land that can serve as a site, with unobscured solar radiation, for the still installation, should be near the water users. Saline water must be available for feed water to the process. Competing uses for sites should also be considered;

(d) Estimate of preliminary still size. A well-designed, well-constructed still in a good climate should produce about twenty-five gallons per square foot of still per annum. This yield, compared with annual water needs, will give a first approximation of the required solar-still area;

(e) Design. One or more designs can be selected or developed in the light of local conditions, available materials and skills of local work force, and evaluated for the particular location;

(f) Estimate of monthly yield. Based on a particular design, monthly yields of distilled water can be estimated from experimental data on similar stills in other locations, or through the use of estimation methods such as those outlined in chapter III of this report. These monthly yields should be based on monthly mean radiation levels and temperatures (the most widely available form of the pertinent meteorological data);

(g) Rainfall contribution. If local conditions and regulations permit, rainfall run-off from the still can be recovered. This can be estimated from average monthly rainfall data (if rainfall is not highly variable) or minimum monthly rainfall (if it is variable), applying a reasonable recovery factor. Useful monthly rainfall collected can then be added to still yield to provide an estimate of month-to-month production of useful water from the still;

(h) Monthly needs versus production. A comparison of month-to-month distributions of water production and water needs will indicate water storage requirements, modifications in still size or possible uses of supplementary sources.

(i) Estimate of cost. With the foregoing information, the appropriate data on still designs, first costs, service life, maintenance and operating requirements, and local information on interest rates and other economic factors, the cost of delivering water from the solar stills can be estimated and compared with alternatives;

(j) Other considerations. Considerations not directly quantifiable in terms of cost may also be important. These could include, for example, sociological and personal factors, resistance to change, distance of users from the potable water-supply, protection of the still from vandalism, methods of water cost distribution or sales methods, subsidies and/or fuel savings.

II. BASIN-TYPE SOLAR STILLS

The most common type of solar still, and that in the most advanced stages of development and application, is the basin-type still (also referred to as the greenhouse-type, roof-type, simple-type or conventional-type still).

This section contains: descriptions of the designs, a brief discussion of the theory of operation, a method of estimating still performance, rain-water collection and storage requirements; practical considerations of solar-still operation; and a discussion of costs of solar stills and water produced from them; and the potential areas of applicability of the process. (Information on other still designs and additional details on still theory are given in annexes I-III to this report.)

It must be observed here, however, that other types of solar stills have been proposed and studied. These include: (a) multiple-effect stills; (b) multiple-stage flash units; (c) solar heat collectors supplying heat to conventional distillers; and (d) tilted, wick-type stills. Other designs are clearly in earlier stages of research and development, while another group has been studied and discarded for reasons of engineering difficulties or lack of promise of economic feasibility.

The status of various solar-still designs and processes needs to be recognized. Some basin-type designs are in late stages of development and have progressed far enough for water-supplies for small communities, at least for limited time periods, to have been based on them. These designs are described below.

A. Still design

The process

In nature, fresh water is produced by a very large-scale process of solar distillation. Solar radiation impinging on the surface of rivers, lakes, marshes and oceans is absorbed as heat and causes evaporation of water from these surfaces. The resulting vapour rises as humidity of the air above the surface and is moved along by winds. If and when the air-vapour mixture is cooled to the dew-point temperature, condensation may occur; and the pure water may be precipitated as rain or snow. The essential features of this process are the production of vapour above the surface of the liquid, the transport of this vapour by air, the cooling of the air-vapour mixture, and condensation and precipitation.

The natural process is copied on a small scale in basin-type solar stills. A water surface of limited size is covered with a cover transparent to solar radiation. This cover serves two major purposes: it prevents escape of the humid air above the water surface; and it furnishes a cool surface upon which part of the humidity can condense. The cover also serves as a radiation shield and reduces the energy loss by emitted long-wave radiation from the water surface.

While neither glass nor the sheet plastic materials used for the cover are completely transparent to solar radiation, they absorb and reflect only a small portion of it and interfere little with the evaporation process.

A schematic cross-section of this type of solar still is shown in figure 1. There are several existing solar-still designs, which differ from one another in materials used and in geometry, but all include elements serving the same functions. The saline-water container or basin must be watertight; it is blackened to absorb solar radiation effectively. The transparent cover must be vapour-tight and sloped at an angle sufficiently great to permit water condensing on its inside surface to flow by gravity into the condensate troughs. Condensate troughs must be arranged to collect all of the water dripping from the lower edges of the cover and to drain this product water to the outside of the enclosure. The basin liner may be laid directly on the ground or insulated therefrom to reduce heat loss through the bottom. Metal, concrete or other long-lived materials may be used for the structural elements and condensate troughs. Further differences are introduced by the use of various configurations and sizes.

Brief history of the growth of solar distillation

The principles basic to solar distillation had been known for many years before the first significant installation was made in Chile in 1872. Located at Las Salinas in a desert area, this solar still was described by Harding (1) as a glass-covered installation which covered a ground area of 50,000 sq. ft. and produced a maximum of some 5,000 gpd of distillate for watering mules. The length of time that this still was in service is somewhat uncertain; it has been reported to have been as long as forty years. When the mule trains used to haul out the nitrate ores were replaced by a steam railway, the water was no longer required; operation of the still was discontinued, and today there are only vestiges of the still foundations at the site.

During the Second World War, collapsible units were designed for use on life-rafts (2). These were circular plastic units with weighted conical bottoms and hemispherical tops which would float in the sea when inflated. A horizontal felt sheet underneath the plastic dome was saturated with sea water and the plastic assembly inflated. The vapour formed within the dome was condensed partly on the inside of the plastic cover and partly on the lower cone, which was in contact with the cold sea. Distillate was collected in the bottom of the cone. This device was produced in considerable quantities.

Following the Second World War, several small experimental glass-covered stills were designed and constructed in the United States of America - in Massachusetts (3) and at the University of California (4). At about the same time, experiments on a small unit were conducted in the Virgin Islands (5).

In 1954, the Office of Saline Water (OSW) of the United States Department of the Interior summarized the possible ways in which solar energy might be used in desalting water (6). This report is still an important basic document in the field.

In 1955, a conference on the use of solar energy, held in Tucson, Arizona, included presentations on solar distillation experiments in Algeria, Australia,

and the United States of America. Small glass-covered stills designed in Algeria (7) were built and sold in small numbers in Australia, Cyprus as well as in Algeria. During the next few years, there was accelerated experimentation in the United States, under OSW auspices, which culminated in the construction of large glass-covered and plastic-covered units at Daytona Beach, Florida. These units were operated for several years for OSW, and the results were published by that agency (8). Meanwhile, additional experimental work had been carried on in Australia, Italy (9), the Union of Soviet Socialist Republics and the United States of America.

In addition, the United Nations Conference on New Sources of Energy, convened at Rome from 21 to 31 August 1961, produced further information on the research development and operation of solar stills in many areas of the world (10).

There are currently large installations in Australia, Greece, Spain and Tunisia, and on Petit St. Vincent Island in the Caribbean (see table 1). Small units are located in a number of other countries and on several islands in the southern Pacific Ocean. All of the existing installations are of the basin type. Other installations, including one in the Turkmen, Soviet Socialist Republic, and one at Gwadar, West Pakistan, have been proposed.

Designs for basin-type stills

Before discussing existing solar stills, it is well to note certain aspects of solar-still operation which render this process quite different from other methods of desalination. Where most of the other processes are intended to operate at an essentially constant production rate at all hours of the day and during all seasons of the year, the solar still relies on the occurrence of sunshine for its operation. Its production rate varies from a minimum (perhaps zero) during the night to a maximum during the sunny period. Furthermore, the daily production rate varies considerably with the seasonal intensity of solar radiation. This short-term and long-term variability of production rate requires the storage of product water, as the demand for water generally does not match still production.

The solar-still installation must include supply and product storage tanks, the latter being relatively much larger than those required for non-solar desalination plants. Figure 3 shows a diagram of the normal arrangement for a solar-still installation. Saline water is pumped into the elevated saline-water supply tank, from which it flows by gravity into the still basins. Product water flows by gravity from the product collection troughs in the still into the product water storage tank. From that point, the water must be pumped into the distribution or delivery system.

A great number of variations of the basin-type design have been used; they differ from each other chiefly in the materials used, their geometry, the schemes for supporting and attaching the transparent cover and the arrangements for admitting and discharging water. Basically, all consist of a transparent canopy enclosing the space above a shallow pool of saline water. The canopy slopes towards the edges or the centre so that water condensing on its inner surface will drain by gravity into the trough which bounds most of the inner periphery of the canopy.

Table 1. Existing large solar stills, 1969

Location	Size (square feet)	Date installed	Cover material	Design	Status
Muresk, West Australia	4,500	1963	Glass	CSIRO ^{a/}	Operating
Cooper Pedy, South Australia	38,000	1966	Glass	CSIRO ^{a/}	Operating
Caiguna, West Australia	4,500	1966	Glass	CSIRO ^{a/}	Operating
Hamelin Pool, West Australia	6,750	1966	Glass	CSIRO ^{a/}	Operating
Regna, Greece	16,000	1965	Plastic	Inverted ^{b/} vee	Converted to stretched frame
Salamis, Greece	4,100	1966	Plastic	Inverted ^{b/} vee	Uncertain
Patmos, Greece	95,500	1967	Glass	TUA ^{c/}	Under repair
Kimolos, Greece	27,500	1968	Glass	TUA ^{c/}	Operating
Nisyros, Greece	22,600	1968	Glass	TUA ^{c/}	Operating
Las Marinas, Spain	11,500	1966	Glass	Basin type ^{d/}	Operating
Petit St. Vincent	19,000	1967-1968	Plastic	Inflated plastic ^{e/}	Operating
Chekmou, Tunisia	4,650	1967	Glass	<u>f/</u>	Operating
Mahdia, Tunisia	13,700	1968	Glass	<u>f/</u>	Operating

Note: At an average production rate of 25 gal/sq. ft. per annum an average demand of 10,000 gpd requires some 150,000 sq. ft. of still area.

a/ Commonwealth Scientific and Industrial Research Organization, Australia; see figure 8.

b/ Built under sponsorship of Church World Series; see figure 11.

c/ Technical University of Athens; see figure 9.

d/ Organization for Economic Co-operation and Development; see figures 2, 6 and 7.

e/ Brace Research Institute, McGill University, Canada; see figure 11.

f/ Centre d'Etudes Nucleaires de Tunis-Carthage.

Materials used for the transparent cover have included sheet glass and sheet plastics. Glass is preferred by many designers because of its high and sustained transparency to solar energy, its mechanical rigidity and comparatively low cost. The glass used in some solar stills has been known to perform satisfactorily for periods of ten to fifteen years or more, with a very small amount of breakage. Figures 4-10 show designs using glass covers.

Transparent plastic materials have been extensively considered. Early attempts utilized cellulose acetate and clear polyethylene, but the former material lacked mechanical strength and the latter deteriorated rapidly under the influence of solar radiation. While clear polyethylene film has been modified to remain somewhat more stable under the influence of solar radiation, it has not yet found wide application in stills. Most of the plastic-covered stills currently under development use Tedlar film, a stabilized polyvinyl fluoride; some use polyvinyl chloride films. Two of the several designs are shown in figure 11.

The basin-type unit developed during experimentation by OSW at Daytona Beach, United States of America (see figures 4, 5) was modified by the French and Spanish designers for the Las Marinas installation (11, 12). The modifications are clearly shown in figures 6 and 7. The water surface in the basin is continuous throughout the area covered by this still. The basin liner is a heavy asphalt mat sealed at joints with melted asphalt. Precast concrete beams supported on concrete blocks hold up the glass panes and maintain alignment between the glass panes and the distillate troughs. Sealing of the glass joints to the support beams is accomplished by application of asphaltic cement. Levelling of the site must be sufficiently accurate to ensure that no dry spots shall be left at minimum water level, about 2 inches. These stills are usually operated on a batch basis, but continuous feed and overflow can also be employed. The slope of the glass panes is about 10° with the horizontal.

The design developed by the Commonwealth Scientific and Industrial Organization (CSIRO), Australia (13) consists of a number of parallel bays separated by sheet metal troughs (see figure 8). These troughs support both the glass and the distillate channels. Since the ground is completely covered by the still bays and sheet metal troughs, the troughs serve also as collectors for rain which may fall on the still area. The basin liner used in Australia is black polyethylene sheets, which run the full length of the bays, about 150 feet. The bays are uniformly sloped along their length at about 1 in 40, and are fitted with cross-dams or weirs every 4 feet. Saline water is introduced at the high end of each bay and flows steadily at a rate sufficient to provide for the daily evaporation and for holding down the salinity of the effluent brine. The glass panes are sealed around the edges with a silicone material, which is sufficiently strong to act as a hinge joint at the ridge, thus requiring no other support there. Alignment along the ridge is accomplished by metal clips between adjacent panes. The slope of the glass panes is about 18° with the horizontal.

The design developed by the Technical University of Athens (TUA), Greece (14) has aluminium frames which support the glass panes at an angle of about 12° with the horizontal on the south slope and about 78° on the north slope (see figure 9). The pre-assembled frames also incorporate the distillate collection gutters and thus serve to maintain alignment between the glass and the gutters. The metal frames are supported on a concrete foundation, which also serves as

the boundary of the saline-water basin. Butyl rubber is used for the basin liner, primarily because of its reduced vulnerability to high temperatures. The space between bays is paved in order to facilitate collection of rainfall.

In all three designs, the slope of the glass panes is between 10° and 18° with the horizontal; if dripping of condensate back into the saline water is to be avoided, the minimum angle is about 10° . A primary reason for using a minimum glass angle is that this ensures a maximum solar basin heat-collection area for a given glass area. Since the cost of glass is a major item of material cost, a low glass angle leads to minimum cost for a given area of solar still.

The dimensions of the glass panes are of interest because of the effect on cost. The Daytona Beach basin-type design uses $1/8$ inch glass panes which are 48 inches in the longest dimension. The CSIRO design, in contrast, uses glass panes which are only 18 x 22 inches in size. The use of this size makes it possible to use thinner "horticultural" glass, which is available in Australia at about \$0.10/sq. ft.

This glass may be obtained in sizes such that the sum of the two dimensions does not exceed 40 inches.

At the University of California, United States of America, a design was developed for use on islands in the South Pacific (15). This design which is intended for small-scale installations, utilizes metal glass-supports with a symmetrical saw-tooth arrangement and distillate collector troughs running across the width of the still (see fig. 10).

Large plastic-covered solar stills, constructed with the two configurations shown in figure 11, have been installed on several Greek islands (16). They used the inflated canopy (as does a similar still on Petit St. Vincent in the Caribbean), or an inverted V design. One of these stills is being replaced by a new design using a single slope, in which the plastic cover is placed under tension by the adjustment of bolts which move a high-side adjustment piece in a lateral direction; the inflated design is being dismantled. These stills are considered to be in a developmental stage.

B. Theory of solar-still operation

Energy balance statements and their significance

The basin-type solar still operates when solar radiation, passing through its transparent cover, heats the saline water in the basin to a temperature higher than that of the cover. The resulting temperature gradient and associated vapour-pressure gradient within the still causes water vapour to condense on the underside of the transparent cover. This thin film of condensate is drained to collecting channels and runs to a fresh-water storage facility.

Losses are of various types, including convection and radiation from the warm water to the cooler cover, reflection from both the cover and the saline-water surface, reflection from the imperfectly blackened base of the still, heat transfer from the base and edges to the surroundings and some condensate, which may leak back into the saline water instead of running into the condensate

troughs. It should be noted that the heat transfer from the cover to the surroundings is not a loss, but rather the rejection of heat to the thermodynamic heat sink without which the process could not continue. For a large still mounted directly on the ground, edge losses include the heat transfer from the edges of individual sheets of the glass cover, where they are supported by members or surfaces which are in contact with the outside air. These act as cooling fins and can cause a serious, if unavoidable, heat loss from the still.

Since the direction and magnitude of the solar radiation striking a still are continually changing, as are also the ambient temperature and, perhaps, the wind velocity, it is necessary to regard the operation of a solar still as a dynamic system. Steady-state conditions do not occur for any significant time in real installations and are of academic interest only.

Although in theory the cover may consist of any transparent material, in practice it must be durable, cheap and readily wettable. Glass has overwhelming advantages from these points of view and is the most widely used material. For this reason, the analysis given below applies to glass-covered stills (see figure 1), although the expressions are quite general and can incorporate the properties of different cover materials.

The operation of the still is determined at any time by a set of: (a) heat and mass transfer rate relationships; and (b) energy balances. As is shown in annex II, a set of seven equations suffices to describe the system. The major items in the energy balance on a still are indicated in the diagram shown in figure 12.

The energy balance for the still requires that the total solar energy absorbed must equal the energy transferred from the cover, q_{ga} , plus losses from the bottom and edges of the still, q_b , plus energy stored within the system. The useful energy term, q_e , to which water production is directly proportional, is a part of the energy transferred from the cover. Thus, a basin-type still can produce, as an upper limit, an amount of water whose energy for evaporation is the same as the solar energy incident upon the still. In practice, the ratio of actual production to the theoretical upper limit is in the range of one third to two thirds.

For a unit area of solar still, at a solar radiation intensity of H_s , with a transparent cover having a transmittance, τ , and absorptance, α_g , with a water basin absorptance, α_w , and a system heat capacity, c_{wg} , the energy balance on the still can be written as follows:

$$\alpha_g H_s + \alpha_w \tau H_s = q_{ga} + q_b + (c_{wg}) \frac{dT}{dt} \quad (\text{Equation I})$$

The significance of these terms is as follows:

- $\alpha_g H_s$ = Solar energy absorbed by the glass;
- $\alpha_w \tau H_s$ = Solar energy transmitted through the glass and absorbed in the basin;
- q_{ga} = Energy transferred from the cover to the air;

- q_b = Energy lost from the still base to the surroundings;
- $(c_{wg}) \frac{dT_w}{dt}$ = Energy stored in the system as the water temperature T_w changes with time t .

An energy balance on the cover can be written as follows:

$$q_{ga} = q_r + q_c + q_e + \alpha_g H_s \quad (\text{Equation II})$$

where the new terms have the following significance:

- q_r = Energy exchange by radiation, basin to cover;
- q_c = Energy exchange by convection, basin to cover;
- q_e = Energy exchange by evaporation-condensation, basin to cover (i.e., the useful energy transfer).

Still productivity $P = q_e/\lambda$, where λ is the latent heat of vaporation of water at still temperature. The objective of still design is to maximize the ratio of productivity, P , to still costs. Some of the factors leading to high P include: minimization of the shading of the basin by cover structure; blackening the basin and minimizing crystal formation in it to maintain a high α_w ; using a cover which will be wetted by condensing moisture and retain a high τ ; and insulation to reduce q_b .

Frequent reference is made to still efficiency, η , which is $\eta = \frac{q_e \times 100}{H_s}$, the ratio of latent heat of product water to the incident radiation. This may be taken over any period of time, but the most significant values are those for a period long enough (at least 24 hours) for there to be equal basin temperatures at the beginning and end of the interval.

Annex II shows methods for calculating the various terms in the energy balance equations given above (I, II). The resulting set of equations may be solved graphically by means of characteristic charts in which q_e is plotted against T_g for fixed values of T_w . These charts may be used to predict the performance of a solar still in much the way that a psychrometric chart is used for air-conditioning calculations.

In a comprehensive analysis of the type outlined above published in 1961, the output of a solar still is correlated with solar intensity, wind velocity, atmospheric temperature, cover transmittance and other design parameters (17).

An analysis published in the Union of Soviet Socialist Republics shows graphically the variation of magnitude of terms in the energy balance with air temperature, radiation and other parameters (18).

It is also possible to compute still performance from the equations by numerical methods, and available computer programmes permit the calculation of still performance under a wide range of operating conditions, as well as with varying design characteristics (19). In these ways, the instantaneous output under prescribed conditions of operation may be determined; and by stepwise progression, hour by hour for 24 hours, the daily output under changing conditions is obtained.

Interaction of still and atmospheric parameters

The most important factors that the designer can influence are the values of thermal capacity, c_{wg} , and the heat-transfer coefficients, k_b ($\text{BTU hour}^{-1} \text{sq. ft.}^{-1} \text{ } ^\circ\text{F}^{-1}$) for losses at the edges and base due to leakage. The important climatic variables are insolation, H_s , ambient temperature, T_a , and wind velocity, which affects the value of the cover heat-transfer coefficient, h_{ga} .

To illustrate the interaction of some of these factors, computations for typical stills of the CSIRO design are given in figures 13 and 14. Both the loss coefficient, k_b , and the ambient temperature, T_a , have a significant effect on the still performance. This design, for mechanical reasons, has a relatively high ratio of perimeter to area.

The CSIRO design shown in figure 8 has the value, $k_b = 0.5$, but it may be worth while to attempt to reduce this by means of insulation at the edges of each of the sections, r , as has been done in continuous single-basin designs, by minimizing effective edge length. Insulation adds to the cost, so it becomes a matter for the designer to balance the cost of increasing the output of a still by insulating it, against increasing the output by using a larger area of uninsulated still or changing the still plan. The comparison must be made over an extended period of operation to allow for ambient temperature changes. Because insulation has a significant effect on performance, better methods of insulating stills to reduce base and edge losses should be investigated, and ratio of perimeter to area minimized.

The effect of ambient temperature on the output of a still is important, as may be seen from figure 13. It is usually sufficiently accurate to consider only the average ambient temperature over a 24-hour period, since there is not much difference in the output of a still which runs at a constant temperature and one which varies over that period about the same mean temperature.

The solar radiation on the still is the most important single parameter, and figure 14 shows how the output varies for different values of daily insolation for stills having differing loss coefficients. It will depend to some extent upon how the radiation is distributed throughout the day; but this is a second-order effect, and it is usually sufficient to consider only the total radiation received each day. It is obvious, from the data given in figures 13 and 14, that the best situation for a solar still is one where both the daily insolation and the mean ambient temperature are consistently high.

The thermal capacity of a still has a small effect on its performance; for an uninsulated still, this consists of the thermal capacity of the water and the ground with which it is in thermal contact. A typical value for a still having a 1-inch depth of water is $16 \text{ BTU lb}^{-1} \text{ sq. ft.}^{-1} \text{ } ^\circ\text{F}^{-1}$; but this would not vary over a wider range than, say, about 10-50 for practical stills; and within this range it does not have a large effect on output. The output does increase as the thermal capacity is reduced; it follows that, while water depth is not critical, it should be as small as is practical.

The effect of wind is unimportant on the output of the still. Sudden changes in wind velocity will cause momentary changes in output, but these will balance out over a period.

Practical limitations of theoretical predictions

The theoretical predictions of performance are based on still configurations not too different from that shown in figure 8, where the ratio of the water area to the glass area is 3:89. Since the output is expressed per unit of area, it is necessary to decide whether to choose the glass area, the water area or some other area as a basis. In all the examples given, the area of glass is taken as the basis, which, in this particular case, happens to be very nearly the same as the horizontal projection of the glass surface. When access or walkways are considered, the total ground area for the still diagrammed in figure 8 is 1.28 times the glass area, so that when rain is collected from the surface of the still, it is the total area which is significant.

Predictions are meaningless if stills are not essentially watertight or vapour-tight, and serious leakages occur. It is very difficult to allow in calculations for vapour leaks; and since these can have a serious effect on the performance of a still, it should be taken as axiomatic that the construction should be as vapour-tight as is practical. Some allowance for vapour leakages appear in the term k_p , since they will be proportional to temperature difference over a small temperature range, but it is difficult to allow for the effect of wind. Some stills operate on a batch production basis, where the saline basins are filled at regular intervals and flushed to prevent salt crystallization, while others operate on a continuous flow. In both cases, some allowance should be made in the predictions; but provided the flow rate is low in the continuous-flow still, the correction is only a minor one.

Solar stills have now been developed to the stage where their performance can be predicted with some confidence. The influence of the various interacting parameters is understood quantitatively, so that designs may be soundly based. This knowledge is not yet widely disseminated since stills are not yet widely used, but it is to be hoped that those concerned with further development will establish effective communication to avoid wasteful duplication of effort. For example, the computer programmes necessary for this work can usually be made available to those able to make use of them (19). In this way, it should be possible to ensure optimal performance in very different situations.

Comparison of predicted with measured performance

In order to have confidence in the ability to predict performance in the way described, it is necessary to compare the measured performance over some months of operation with the predicted values. Recent unpublished work at CSIRO, Australia, shows this comparison for an experimental installation at Griffith (see figure 15). Neglecting the points on days when rain fell and probably entered the still, the agreement is quite good for values of $c_{wg} = 16 \text{ BTU sq. ft.}^{-1} \text{ } ^\circ\text{F}^{-1}$ and $k_p = 0.48 \text{ BTU hour}^{-1} \text{ sq. ft.}^{-1} \text{ } ^\circ\text{F}^{-1}$.

The analysis published in the Soviet Union (18) has been compared with experiments in Ashkhabad (20), and good agreement has been found between calculated and observed results, as may be seen from figure 16.

Thus, the analyses do predict reasonably well the monthly outputs of basin-type stills and serve as a basis for understanding the process occurring in the stills.

C. Still size, rain-water catchment and product storage

In establishing the size of a solar still for a particular site, many factors must be considered including monthly water requirements, monthly solar radiation, monthly rainfall and still characteristics. These factors will determine still size, monthly total production, storage capacity requirements and costs.

Still productivity

The efficiencies of most of the basin-type solar stills that have been built and reliably tested are rather similar. It appears that care in design and maintenance to avoid water loss through leakage is the largest variable. Care in design of still edges and bottom insulation, and the maintenance of thin water films in the distiller basin make some difference in the performance of the various units at the same radiation levels.

Moreover, most of the large solar stills recently built have been in climates where the solar radiation levels do not differ greatly from one another. As a result of these similarities, the water distillation rate per square foot of distiller per annum has been roughly the same for all designs. In nearly all of the installations, productivities reach approximately $0.1 \text{ gal sq. ft.}^{-1} \text{ day}^{-1}$ on clear summer days. Some stills have delivered water at a rate as high as 0.14 gallon. In winter, however, at solar radiation levels of a few hundred BTU per square foot per day, average daily yields drop to $0.02-0.03 \text{ gal/sq. ft.}$

If a solar distiller could produce water every day of the year at a rate equal to a summer productivity of 0.1 gal/sq. ft. , the annual production would be 36.5 gal/sq. ft. Such performance would not be possible because of the seasonal variation in solar intensity, and in the vicinity of the 30th to 40th parallels, annual yields of about 25 gal/sq. ft. have been achieved in good climates. These are the results of operating sizable solar stills, in which there were known design defects and which suffered from various degrees of leakage and other problems. The 25-gal figure may therefore be considered a practical design basis. It is possible that with further improvements in design, directed primarily at virtually eliminating all leakage and related losses, annual yields approaching 30 gal/sq. ft. might be obtained in favourable climates. At the current time, however, a conservative still size estimate should be based on an annual production of 25 gal/sq. ft. , assuming a good solar climate similar to that in southern Spain, Greece, Florida (United States of America), the Turkmen SSR and South Central Australia.

First-order prediction of monthly output

As still output is variable throughout the year, it is of interest to estimate monthly still yields for a projected site and design. Under average monthly conditions, still output is most readily calculated from known values of mean daily solar radiation, H_s , and mean daily ambient temperature, T_a , for each month, as was described above. Tables of mean daily radiation for many locations have been tabulated or mapped (21, 22). This calculation is possible for a particular design of still if the thermal properties, especially c_{wg} and K_p , are known.

It is difficult to generalize because there are important differences in still productivity, both among still designs and among various locations. As an example of productivity, typical performance of the Australian stills now in commercial use is given in table 2. For convenience in use, these figures are plotted in figure 17.

Table 2. Typical solar-still production
(U.S. gallons per 1,000-square foot day)

Daily insolation (BTU per square foot day)	Mean ambient temperature (°F)			
	60	80	100	120
500	9	13	17	22
1,000	22	30	37	44
1,500	39	50	60	70
2,000	59	72	85	97
2,500	81	97	112	125
3,000	106	124	141	155

Note: $c_{wq} = 16 \text{ BTU sq. ft.}^{-1} \text{ } ^\circ\text{F}^{-1}$
 $k_b = 0.5 \text{ BTU hour}^{-1} \text{ sq. ft.}^{-1} \text{ } ^\circ\text{F}^{-1}$

The data given in table 2 and figure 17 apply to a still if the loss factor, k_b , is 0.5. The effect on the output of different values of loss factor may be estimated from data given in figure 14, by multiplying production figures from table 2 by the ratio of output at the proper value of k_b to output at $k_b = 0.5$. Note that production figures thus obtained can be used only as a first-order estimate of month-to-month still output. Before final decisions are made as to detailed design, more detailed calculation of expected output should be made, considering variations in average temperature, heat capacity and wind velocity.

An example of a month-by-month estimate of still output for a desert climate is given in table 3, which shows the monthly mean radiation, monthly average temperature, average daily output of a 1,000-sq. ft. still of the stated characteristics and monthly output. Clearly shown in column 5 is the wide variability of solar still output through the year.

Table 3. Example of preliminary estimate of solar-still yield
(still area = 1,000 square feet, $c_{wg} = 16$; $k_b = 0.5$)

Month No.	Average daily radiation (H_s)	Average temperature ($^{\circ}F$)	Distillate production (gallons per day)	Estimated monthly production (gallons)
1	1,050	75	29	900
2	1,420	75	43	1,200
3	1,870	80	66	2,050
4	2,131	85	82	2,460
5	2,310	88	95	2,940
6	2,410	95	103	3,090
7	2,350	95	101	3,130
8	2,210	90	89	2,760
9	1,950	88	76	2,280
10	1,530	83	53	1,670
11	1,110	78	32	990
12	950	75	27	940

Rain catchment

A well-designed still must make adequate provision to dispose of the rain which falls on it, so that the surrounding ground is not eroded nor flooded. The extra cost of diverting this rainfall into a fresh-water storage tank is negligible. It may be necessary to chlorinate the water if it is for human consumption, and in some locations local health regulations will prevent its being used. It should, however, be considered since rain will frequently add significantly to the still's output. The total area of the site, i.e., glass area plus surroundings, is usually available for this purpose. In semi-arid regions, annual rainfall of 10 to 15 inches is common. For example, at an assumed rate of 12 inches, and a recovery of 70 per cent of the precipitation, a square foot of solar still would deliver an additional 5 gal/sq. ft. On the basis of a 25-gal annual distillation rate, and conservatively assuming that catchment area and still area are the same, this precipitation would represent an additional yield of 20 per cent. If the distribution of the precipitation throughout the year were such that it could all be collected, stored and used, this quantity would represent a 16 per cent reduction in the cost of water per 1,000 gallons delivered, assuming that no additional cost was incurred by providing for rain-water collection.

It is clear that if the precipitation is significant, its collection should represent an economic advantage to a solar distillation operation. The size of the benefit depends upon the amount of rainfall and on whether it is received at rates and at times when it can be used. If the precipitation is so heavy

and intermittent that storage tanks are not adequate for its retention, it will be of small advantage. In many situations, however, a large fraction of the annual rainfall occurs during months when solar radiation is low (due partially to the clouds which yield the precipitation), and this additional yield can offset lower distillation rates during those times. Nevertheless, as this is not always the case, prudent design would generally be based on the assumption that only a portion of the annual rainfall could be beneficially used. The portion would, in turn, depend upon the time of year in which precipitation usually occurred, the distribution during this time (whether reasonably uniform over extended periods or heavy during short periods), the demand for water during those periods and the availability of storage. It is suggested that a run-off figure of 70 per cent may be used to calculate by month the extra water which may be collected, knowing the mean monthly rainfall for the site. It should be noted that rainfall is usually less reliable than solar radiation, and minimum rather than mean values may be preferred for safety.

Storage

The monthly demand for fresh water may now be related to the monthly production of distillate (plus rain-water catchment if it is significant) to determine how much storage of fresh water is required. The time dependence of water needs is a function of the local situation and uses to which the water is put. Where a solar still is supplying water for stock, the demand may follow production closely. There may be seasonal changes in water requirements for community water-supplies or an increase in needs for washing and drinking, or an increase in population (tourists) which could result in summer demands being higher than those in the winter. It may also be possible that demands will be relatively constant throughout the year. The most probable situation is that of a relative production deficiency in winter and excess in summer.

The problem of matching the availability of water from desalination facilities with variation in demand have been discussed in some detail (23). When considering solar distillation, however, the variation of water production rate with time is a major factor.

The daily productivity of a solar still in the winter is typically only 20 to 30 per cent of the average daily summer production. If the demand for water were constant through the year, either the still could not produce enough water in the winter to satisfy the demand, or, if it were designed to meet this winter demand, there would be a surplus of water in summer which could not be used. Thus, it is necessary to choose among a spectrum of alternatives, all of which tend to increase the cost of solar distilled water:

(a) Providing sufficient storage for holding excess water produced in summer for use in winter (see annex III);

(b) Designing the solar still in a size sufficiently large to satisfy the demand in winter and wasting the additional water produced in summer;

(c) Designing the solar still in a size sufficiently large to meet the summer demand and providing some other source of water to make up the deficit in winter.

The choice of the above alternatives depends upon economic factors. The cost of water storage tanks may be too high to justify the expense of the tankage which would be required to smooth out the variable productivity over the year. In some situations, however, where storage facilities may already exist or where natural, water-tight, protected basins may be available, this method would be attractive. Partial smoothing of output by use of less tankage might prove the most economical solution.

The alternative involving the design of a solar still to provide all the winter requirements (assuming that rainfall is not sufficiently dependable to augment the supply during this period) and the wasting of excess of summer production would generally be far too expensive to tolerate. The total cost of water actually used would be two to three times the costs computed elsewhere in this report on the basis of all the water produced being used. The still would have to be as much as four times as large as a still designed to meet summer requirements, or as much as two to three times the size of a still based on a mean annual productivity of 25 gal/sq. ft.

The third alternative involves designing the distiller so that all of the water output would be needed and used at the time of production (or with nominal storage of a week or two). Application of the previously outlined cost analysis to the operation will indicate the cost of the solar-distilled water (which will be lower than in the first alternatives because of 100 per cent product use and minimum storage requirements). The total annual cost of water would be that of the solar-distilled water plus the cost of the water from the supplementary source (which may be very high).

Local conditions would have to be known before decisions could be reached among these alternatives. If there is an alternative supply, even at somewhat higher cost than the solar-distilled water, it may be more economical to use it as a supplement during the period of low solar-distiller productivity. Annual average water-supply costs should be minimized by such a combination. If, however, the auxiliary supply entailed costs substantially more than double the cost of solar-distilled water, the solar still should be of a size sufficiently large to meet the entire demand, probably in combination with summer to winter storage.

In appraising the three alternatives, it can be concluded that the one which would definitely not be chosen is the design based on winter demand and the wasting of summer production. Before this would ever be done, storage facilities for impounding excess summer production would be found to be cheaper than the much larger solar still. Unfortunately, no meaningful general figures can be assigned to this cost of variable distiller capability. The cost of providing one of the above-mentioned alternatives and even the extent of need (dependent in turn upon the water-demand pattern of the community) cannot be even roughly determined without data applicable to the location in question.

It should be noted that solar-distilled water is likely to be nearly completely devoid of dissolved salts, and hence may be purer than is needed or even desirable for potable supplies. If a supply of slightly saline water is available, e.g., well water, it may be blended with the solar-distilled water in proportions such that the mixture has an acceptable total dissolved solids content (e.g., of not more than 500 ppm). Assuming that the blended

water is acceptable as to its biological composition and its taste, and that the cost of the saline water is less than that of the solar-distilled water, the blended supply is likely to be cheaper than an equivalent supply of solar-distilled water alone. By this blending process, the effective output of the solar still could be increased in winter above its normal level, at a sacrifice of water quality.

Optimum size of still

Due to the unit construction of solar stills, their cost increases nearly linearly with size, so that two small stills (5,000 sq. ft. or larger) cost very nearly the same as one twice the size. For this reason, they may be located close to the point where the water is needed to simplify distribution, provided a suitable saline-water source is available.

For example, underground saline water is often available over large areas of arid country which can support sheep and cattle if they are supplied with drinking water. Since sheep will walk approximately 1 mile and cattle about 2 miles to a watering point, it is possible for a known stocking density to calculate the optimum size and spacing of watering points. Consideration of stock-watering needs in two areas indicate that desalination systems having capacities of 400-1,000 gpd and spaced 2-4 miles apart could meet stock-watering requirements; unit solar stills may be ideal for this application. This application is further discussed below.

Flexibility in choice of size over a significant range without significantly affecting unit costs is an important feature of the solar still.

D. Installation and operation of solar stills

The general layout and components of a solar-distiller installation are shown in figure 3. Indicated are a feed-water supply tank and pump, stills, product collection, and storage tanks (which may be one) and piping to get saline water into the still, condensate from the still to collection system and for waste brine removal. The operation of basin-type stills presents several practical problems and options, including feed-water and distillate treatment, deposits inside the stills, feed addition and brine removal methods and maintenance of stills.

Water treatment

The velocity of water movements in still basins is essentially zero; therefore, to prevent settling out of suspended solids in the still, suspended materials should be removed from the feed water before it enters the still. In plants of relatively small size, the feed-water tank can serve as a settling tank if the feed water is held long enough for settling (e.g., one day). For larger plants, a sand filter may present a better solution of the problem.

The product water from solar stills, as from other stills, is essentially tasteless. It is common practice in the stills now operating to supply water for human consumption to add a small amount of feed water or salt to the

distillate, or to pass it over marble chips (to achieve slight calcium ion addition) in order to make it more acceptable to the consumer.

Deposits inside the still

Deposits in the stills may originate from crystallization of salts if too much water is evaporated from the feed. The nature of the deposits varies with the particular feed-water composition, but may typically include calcium carbonate, calcium sulphate or, in extreme cases, sodium chloride. Precipitated salts may be difficult and costly to remove.

The best solution to this problem is to remove the brine from the still before the concentration of any salt reaches saturation. Operating practice for some stills has been to feed the still periodically and permit the brine to evaporate until its concentration is about double that of the feed. Thus, for each 2 gals. of feed to the still, 1 gal. of product is obtained and 1 gal. of brine discarded. Other stills (notably the Australian stills) have salt water fed to them continuously at a rate which maintains a satisfactory salt concentration in the basin (and which can thus operate without attention). Note that high calcium salt concentrations in the feed may require frequent filling and draining, or high continuous-feed rates.

Growth of algae and other organisms can occur in still basins. This can usually be controlled by the addition of algicides, such as copper sulphate, to the feed. The growth of algae in stills does not appear to affect still productivity in an adverse way, but excessive accumulations, if not flushed out, can result in the need for costly cleaning of the still.

Feed addition and brine removal

Two types of construction have been adopted in designing the basins of solar stills. One type provides for a single large water basin covering the whole still area (Daytona Beach, United States of America; Spain). In the other type, the distillation plant is divided into many still units of varying lengths, but restricted width (Australia, Greece, Caribbean islands).

Differences in the two designs may affect still operation. Pathways between the still units allow for good accessibility of the central parts of the plant for maintenance. Techniques for feeding the salt water in and eliminating the brine from the stills may be different, and the brine depth is usually greater in the larger basins and less in the smaller divided basins.

Deep basins (e.g., more than about 2 inches deep) provide an accumulation of heat during day-time and retardation of cooling in the evening. The time of operation is thereby extended, but the maximum temperature reached after noon is lower than that in a corresponding shallow basin. Salt water remains for many days inside the deep basin until an evacuation of the brine due to salt concentration becomes necessary. In shallow basins, the water temperature at noon is considerably higher than that in deep basins. Accordingly, distillate output during the early afternoon hours is higher than that in deep-basin stills, but less in the evening because of earlier cooling of the salt water. Salt-water renewal is carried out in the shallow-basin stills at shorter intervals.

Several techniques have been adopted for the renewal of the salt water inside the stills:

(a) In deep-basin stills, salt water is renewed after several days, when the concentration trends to the limit of solubility;

(b) In many shallow basin stills, salt water is fed by batches every day, early in the morning, at one end of the basin; and the brine is displaced at the other end flowing over a weir. Due to irregularities in the bottom formation, the salt water might run in paths of the least resistance in its flow to the weir and leave areas with stagnant water in which calcium sulphate deposits might form;

(c) In the Australian design, a continuous feed of salt water is used. The feed is continuously displacing the brine, which overflows at the discharge end through a fixed pipe. The bottom of the stills has a slight slope, with a series of low dams or weirs over which the salt water cascades. Mixing occurs at every cascade, thus minimizing potential scale formation. No scale problems have been reported. Continuous feed necessarily involves some discharge of hot water and heat losses, which are reported not to be considerable;

(d) To avoid algae and potential scale formation, a technique of complete evacuation of the brine from the stills was developed in Greece. The brine outlet is ending at an open pipe, which may be turned up or down by means of a union. When the pipe is turned upwards, the open end controls the sea-water level inside the still. Consequently, the water level can be adjusted independently for each still unit, in order to obtain the minimum depth for which dry areas do not appear at the end of the evaporation period. By turning the open pipe downwards, the still is completely emptied. (This was found to be necessary every second day in summer-time and at longer intervals during other times of the year, according to the radiation intensity.) The operator empties the still units by batteries. While one battery is being emptied, another previously emptied is fed with sea-water, and so on.

Maintenance and operational requirements

Costs and requirements for maintenance are discussed in more detail in section E. Note is made here, however, of the need to operate the still in such a way that maintenance is reduced to an absolute minimum. For example, a need for mechanical cleaning of a still basin, even after one or more years of operation, would make the cost of solar-distilled water prohibitively expensive. Thus, it is highly important that nothing should be allowed to accumulate in a solar still which will seriously impair its performance and which cannot be removed by simple flushing with excess feed water.

It should further be noted that solar stills are designed to operate with water in them. A still which is allowed to run partially or completely dry will quite quickly reach temperatures higher than its normal operating temperatures. Depending upon the construction materials used, a dry still may suffer serious damage. For example, plastic materials within the enclosure may overheat and lose their desirable mechanical properties, or volatile components may distil out of asphalt basins and deposit on covers or collection troughs. Care in supplying feed water to stills will eliminate these potential problems.

Fencing

It has been found advisable in all solar-still installations constructed to date to completely enclose the still site by a fence. This serves to reduce the probability of damage to the still or injury to persons who might inadvertently come in contact with it. It also serves to keep animals out of the still, as they can break glass or puncture plastic covers.

E. Economics of solar distillation

Over-all considerations

A critical question bearing on the utility of solar distillation is its cost in relation to alternatives. It has been shown that there are numerous solar-distillation processes and variations; several of these have been tested and a few have been commercially applied. Economic studies, usually of limited scope, have been associated with most of these developments.

In contrast with other desalination processes, in which the cost of energy is a very important, if not the major element in the total, solar distillation involves virtually no energy cost. Experience has shown that the cost of operating labour is minimal, in comparison with that for conventional desalination processes. Thus, the cost of plant investment and those items of expense directly related to capital requirements are the all-important controlling expenses in solar desalination. This means that the total capital investment per unit of distiller production capacity, coupled with the interest charges on this investment and the amortization rate (depending directly upon the useful life of the installation) are the primary and controlling elements in the cost of water produced in solar stills.

In the evaluation of solar distillation as a means of supplying fresh water for consumptive use, three economic criteria may usefully be examined. These are: (a) at the point in question and for the volume of water required, the relative cost of desalted saline water and natural fresh water obtained by any known means; (b) the relative cost of various solar distillation processes and several commercially proved conventional desalination processes employing fuel or electric power as energy supply, unless natural fresh water is cheaper than any known desalination method; and (c) the relative cost, over the entire life of the installation, of the several solar distillation processes and variations which have been proved technically feasible, unless one of the conventional processes is more economical.

Most of the development work in solar distillation and all of the successful applications have involved the simple, basin-type still. As a consequence, most of the economic data on solar distillation pertain to this type of installation. In the discussion which follows, the basin-type solar distiller is implied.

In solar distillation, as in virtually all industrial processes, the following items make up the total cost of production: raw material; energy; interest on and amortization of investment (the latter also termed annual depreciation); taxes and insurance; operating labour and supervision; maintenance and repairs (labour and materials).

Cost of raw water and energy

In solar distillation, the cost of raw materials and energy can be lumped together as the cost of delivery of salt water to the still basin. Other than the small amounts of chemicals needed to control the growth of micro-organisms in the basin, salt water is the only raw material involved in the process. Except in unusual situations where brackish water might be available at a level above that of the basin, a small amount of energy will have to be used to pump feed water to the feed tank. Since the energy for evaporation is derived from the sun, there are no additional energy costs. Energy may be needed to pump the distilled water to storage or distribution systems; its costs may be included in the storage and distribution cost, rather than as part of production.

Sea-water at the shore may be considered a free commodity. The cost of brackish water in a well would have some finite value, depending upon the cost of drilling the well and the various annual charges and productive capacity of the well.

Analysis of typical examples of still installations indicates that the total cost of raw feed water and energy for pumping in a solar distillation plant could be expected to range from about \$0.03-\$0.10 per 1,000 gallons of product water. Slightly lower costs could be applicable in favourable situations, while considerably higher costs could be involved in smaller installations very unfavourably located with respect to the salt-water source.

Capital costs of solar stills

There have been numerous estimates of investment requirements in basin-type solar stills. Some of these have been based on actual experience in construction of various sizes of practical installations. Others have been based on extrapolations to larger size units of the actual costs in smaller installations. Still others have been based on somewhat speculative considerations involving the prices of materials and estimates of construction labour requirements.

It is clear that investment will vary with the cost of materials used and the wages and time requirements for construction labour. As indicated below and in the published literature, the actual experienced costs of building basin-type solar stills in sizes ranging from 3,000 to nearly 100,000 square feet have been on the order of \$1-\$2/sq. ft. This range appears to bracket nearly all of the large experimental and practical solar stills constructed throughout the world, representing a considerable variety of materials, sizes and labour wage rates.

In several of the development programmes resulting in the construction of these distillers, reasonably firm estimates of cost, either in larger units (particularly when based on distillers with an area of 3,000-5,000 square feet) or in situations where experimental and other unusual facilities would not be included, show total investment requirements for materials and labour of construction ranging from slightly below to slightly above \$1/sq. ft. Some of these estimates have shown capital costs as low as \$0.60/sq. ft., and the actual costs in one installation (Muresk, West Australia) were about \$0.60.

Capital cost alone is not a sufficient criterion for comparison of one solar still with another, because it cannot be used directly in measuring the cost of a given quantity of distilled-water product. Capital cost can be decreased by sacrifices in design which may reduce the water production rate and the service life of a solar still, both of these factors tending to increase water costs. It is primarily the combination of three items - capital cost, solar distiller useful life and annual water output - which are the controlling factors in the economics of solar-distillation.

The distribution of the required investment into the materials and construction labour categories depends heavily upon the distiller design and upon the wage rates in the region where it is built. In some installations, the proportion has been about half and half. In others, particularly those in the less industrialized countries, a considerably larger proportion of investment has been used for materials. Table 4 shows some actual and projected investments in solar stills and their approximate distribution into various categories. Comparisons of similar items between different installations must be made judiciously, however, because of large differences in material prices, labour rates, distiller sizes, accessory facilities and other factors.

It should be recognized that there may be considerable variation in capital costs, depending upon location. Availability and variability of sunshine is a major factor in unit output, hence in distiller size and cost. The price of materials and their cost of transport to the site is affected by the extent of industrial development of the country and the accessibility and distances involved. The skill, availability and cost of construction labour comprise a third major variable. Hence, the cost of even a fixed design may vary widely, perhaps as much as 50 per cent, from place to place. Therefore, capital costs must finally be based on the conditions in a specific location.

This generalization may be emphasized by some comparisons of the data given in table 4. In the small still at Daytona Beach (United States of America), 37 per cent of the total investment (\$2.30/sq. ft.) was in construction labour; and in the projected still (1 million sq. ft.) in the United States, 35 per cent would be labour cost. Material costs are \$1.11 and \$0.72, respectively. In the Patmos (Greece) still, however, only 19 per cent of the \$1.65 total cost is for labour, while materials were \$1.34. The lower wage scales in Greece (roughly \$2 per man-day) compared with those in the United States (averaging about \$25 per man-day) are responsible for most of the difference. Thus, unless considerable importation of materials is required (seldom foreseen because of their nearly universal availability), the costs of construction and operation of solar stills will be significantly lower in regions where labour wage rates are low. Appraisal of capital cost can be very roughly made by considering materials at \$0.60-\$1.20/sq. ft., depending upon size and design, with construction labour estimated at 0.3-1.0 man-hour/sq. ft., depending mainly upon the degree to which labour-saving techniques and equipment are used. In projected large-scale designs in the United States, construction labour appears reducible to about 0.1 man-hour/sq. ft.

Working capital has not been included in the investment requirement because it is a small item in the total. Land cost is another small item which is effectively included in construction costs. Even at the high value

Table 4. Capital costs of solar stills

	Ias Marinas still (9,350 square feet)	Daytona Beach still (2,650 square feet)			Patmos still (86,000 square feet)	Projected still, United States of America (1 million square feet)				
	<u>Actual costs</u> (dollars per square foot)	<u>Actual costs</u> (dollars per square foot)			<u>Actual costs</u> (dollars per square foot)	<u>Estimated costs</u> (dollars per square foot)				
		Materials	Labour	Total	Materials	Labour	Total	Materials	Labour	Total
Land preparation	.026	.04	.32	.36				.01	.09	.10
Concrete beams	.211	.25	.15	.40				.19	.10	.29
Masonry	.063	.07	.04	.11	.09			.16	.04	.10
Basin lining	.502	.32	.19	.51	.26			.15	.10	.25
Glass covers		.37	.14	.51	.23			.25	.10	.35
Piping, channels	.188	.03	.01	.04	.06			.03	.01	.04
Miscellaneous equipment	.246				.05					
Electrical	.178				.05					
Special works	.146				.19					
Distillate troughs		.03	.02	.05				.03	.02	.05
Aluminium frames					.28					
Contractor's fee				.32						.12
Subtotal		1.11	.87		1.21			.72*	.46*	
Total	1.56			2.30		1.51				1.30*

* Considered reducible to .60, .30 and .99, respectively.

of \$1,000/acre, the land cost is only \$0.025/sq. ft. At typical values of land near small communities in arid regions, this item would be well below 1 per cent of the total investment in the plant. It should be observed, however, that flat land is required for most types of solar stills, and that if significant levelling is required, the cost of land preparation may be substantial.

Investment in distribution systems is not included in desalination plant costs because such facilities, to the extent used, may be considered part of any water-supply system, whether desalted or naturally fresh. Since the costs associated with distribution vary widely, from zero to probably a dollar or more per 1,000 gallons, their inclusion would obscure the economic comparison of processes and sources. Hence, the foregoing capital requirements and the subsequent operating costs may be considered those "inside the fence" surrounding the solar-distillation plant itself. Since water storage is an inherent feature of solar distillation, the cost of storage for this purpose is a proper charge against the process itself, as is discussed later.

Amortization of investment

Of all the items affecting the cost of solar distillation, depreciation of the equipment is least well established. No durable solar still has operated for a sufficient length of time to establish by experience the useful life of the installation. Stills were operated experimentally at the University of California (United States of America) from 1952 to 1959; a still built in 1962 at CSIRO (Australia) was still in operation in 1969, with the object of determining life of components. Parts of the Las Salinas still in Chile reportedly operated for many years. Estimates of useful life of current designs are thus based on the limited experience to date and on the known or expected service life of the materials of construction.

The large solar stills built thus far may be conveniently divided into two main types for the purpose of estimating their service life. One type has been constructed of materials commonly used in buildings and other structures encountering environmental conditions similar to those facing solar stills. These stills are composed primarily of glass, concrete, asphalt and bituminous or other weather-resistant caulking materials. Butyl rubber has also been used.

The other type of solar still has been constructed, at least in part, of materials of less well-proved durability in this service. The most important components are thin plastic films, which are used as transparent covers and as basin linings. Metals (such as galvanized steel sheet), concrete and wood have also been used. In a rather unique category, the Australian stills have used materials in both of these classes, being primarily of common durable materials except for the plastic film used as bottom lining.

Considering first the useful service life of stills built with ordinary building materials, there seems to be a basis for expecting the components to serve as long as they ordinarily do in conventional buildings. A minimum life of twenty years should be expected, possibly ranging to fifty years, depending upon the quality of maintenance and barring destruction by natural disasters.

Another important factor in the amortization of an investment, not related to actual durability, is the expected rate of obsolescence of a design or even the entire concept. The development of improved designs, perhaps involving cheaper or more durable or more efficient systems, might indicate that the investment in an existing, partially depreciated plant should have been amortized more rapidly. Increased water requirements by a community, through population growth or industrial development, might require such a large expansion in a solar distillation plant that other desalination processes or water sources could be used more economically. Solar distillation is particularly vulnerable to premature obsolescence because of its capital-intensive characteristics.

At the current stage of development in solar distillation and in other processes of desalination, it would probably be imprudent to anticipate more than a twenty-year useful economic life for a solar distillation plant. In some locations, twenty years might be too long for realistic amortization. It appears that the durability of the materials in this type of solar still is sufficiently great that the limiting factor will be obsolescence rather than physical deterioration of the facility. Thus, with durable stills it would seem that twenty years is likely to be the maximum economic service life which can reasonably be projected. Estimating the service life of unproved designs must be done with considerable care.

Very limited experience has been achieved with solar distillers covered with plastic films. Controlled weather-resistance tests of polyvinyl fluoride films have shown, in bright sunlight, durabilities of several years. In actual solar stills, however, wind, rain, mechanical problems and other factors have limited useful life to one or two years, or less. The "weatherable" films of polyester, polyvinyl chloride and polyethylene have even a shorter service life in still applications. Other components of these stills can be expected to have longer lives, depending upon their basic characteristics. Depreciation costs in such units might therefore be considered to be made up of two principal items, those involving slow depreciation of the more durable components and those involving rapid depreciation of the plastic films and the expendable or replaceable items directly associated with them. In expectation of some improvements in plastic films and their use in solar stills, the projected depreciation rate on the transparent plastic covers might be based on a useful life of no more than three years, involving therefore an annual depreciation rate of 33 per cent or more of the cost of these components and their installation.

Although considerably more detailed depreciation and amortization schedules might be used, there is little justification because of the speculative elements involved. In the durable type of stills, obsolescence, at a rate which currently is speculative, appears to be the controlling factor. As ultimate useful service lives of plastic covers have not yet been well established, only the roughest estimate can now be made. The figures suggested above are believed to be in the range that should be used for evaluation purposes at the current time.

Interest charges

Interest on the capital investment is a significant item contributing to the cost of solar-distilled water. It is also highly variable from one location to another.

Typically, governmental divisions and subdivisions are able to borrow money at lower interest rates than are private organizations. Since it is probable that most community water supplies would be provided by municipal or federal authorities, interest charges would probably be at the lower levels existing in the region. In the industrialized countries, current prime interest rates range from 5 to 7 per cent per annum, with high-quality commercial credit being 1 or 2 per cent higher. In the less industrialized countries, rates may be still higher, up to 15 per cent or more.

Taxes and insurance

Taxes and insurance on a solar distiller can also vary widely, depending upon the type of ownership and the accounting policies in the organization concerned. With municipal or community ownership, there would be no taxes on the facility; and the ample financial reserves of such a governmental authority could make self-insurance adequate. Thus, there would be no direct outlays for these items. A privately owned facility, on the other hand, might be taxed at a prevailing rate; and insurance against loss would be a prudent expenditure. Risks requiring coverage might include damage by wind, earthquake, civil disturbance, vandalism, stray animals or vehicles, and liability for personal injury to employees and others. In some situations, public subsidies for water-supply facilities may be applicable, thereby reducing or entirely eliminating the charge of tax and insurance costs.

Maintenance and repairs

For convenience, and also because the type of construction used in basin-type solar stills tends to justify it, the cost of annual maintenance and repair materials and labour may be taken as a certain percentage of the capital investment. This percentage can soon, it is hoped, be appraised with some reliability as greater experience in the operation of solar stills is obtained. At the current time, only rough estimates can be made.

In estimating both labour and maintenance costs, it must be assumed that the designs have led to installations which, in the ordinary sense of the word, are "maintenance-free". If this is not the case, and if routine "working-over" of the solar still is required, the cost of this item becomes prohibitive. For example, if only one man is employed, on a full-time basis, to maintain a distiller with an area of 100,000 square feet, and if each portion would have to be serviced only once a year, he would have to do the maintenance work on about 400 square feet each day. If such work as replacement of caulking, patching and cleaning had to be done, this would probably represent all that he could accomplish. In an industrialized country, this would cost on the order of \$5,000 per annum (mostly for labour); and if the distiller has a nominal production rate of 25 gal/sq. ft. per annum, the maintenance cost alone would be about \$2 per 1,000 gallons of water produced. In countries where labour rates are much lower, this cost would not be quite as serious - perhaps being no more than \$0.50 per 1,000 gallons. These figures show the great importance of virtually maintenance-free designs.

With a durable solar still constructed of standard building materials and designed so as to minimize repair work, an annual charge of 1-2 per cent of investment is considered realistic. In other words, repair requirements might be

considered to be virtually only those to deal with damage or deterioration resulting from unusual conditions occasionally encountered. In comparison with other small-scale desalination processes, this is a very low maintenance cost and one which can be readily borne even in small plants. Repair of the complex machinery characteristic of other processes is completely avoided.

For the less durable type of solar stills, i.e., those employing plastic film covers and bottoms, a greater allowance should be made for repairs and maintenance. Costs of replacement of covers at suitable intervals have been included in the depreciation-amortization item, but the patching of small holes in the covers, occasional deflation (if the inflated design is used) to avoid wind and rain damage, subsequent rain-water removal and reinflation would be added requirements. Again, there is insufficient experience with these designs to permit reliable assessment of this item, but for the current time, possibly 2-4 per cent of investment would be a reasonable estimate.

In regions where wage rates are much lower than those in the industrialized countries, it would be expected that annual maintenance labour would be lower than 1-2 per cent of investment. To some extent, the lower labour cost may be offset by higher costs of repair materials, particularly if there are transportation problems. It thus appears that 0.5 per cent of investment should amply cover repairs and maintenance in the developing countries. (These figures are reasonably consistent with the low end of a range, based on experience with developmental stills in Australia, of 10 to 40 man-hours per annum per 1,000 sq. ft. of distiller.)

Summary of fixed costs

In the foregoing sections, estimates have been given of the annual percentages of the total capital investment in solar distillation facilities which should be charged each year to depreciation, interest, taxes and insurance, and repair and maintenance. The sum of these percentages can be applied to the investment and total annual fixed charges estimated.

The total annual percentage of capital investment chargeable to water production during the year, based on the above-mentioned estimates and minimum government interest rates, appears to be approximately 9-12 per cent for a durable type of basin still and 17-20 per cent for a still requiring replacement of plastic films every three years. If the capital cost is approximately \$1/sq. ft. and if the annual yield is taken as 25 gal/sq. ft., the annual fixed cost would be approximately \$0.09-\$0.12/sq. ft. for a durable type of still, corresponding to \$3.60-\$4.80 per 1,000 gallons. If a distiller required an investment of only \$0.60/sq. ft., approximately the case in the latest Australian design, and if a fixed charge of 13 per cent were applied (the higher end of the range because of possible higher depreciation and maintenance costs with the cheaper materials), the fixed costs applied to water production would be about \$3.15 per 1,000 gallons of product. If it is assumed that the plastic-covered distillers could be constructed for about this same cost, application of a (weighted) 20 per cent annual fixed charge rate would result in fixed charges of \$4.80 per 1,000 gallons at an annual production rate of 25 gal/sq. ft.; reduction of construction costs or improvements in yield would reduce this cost.

Here, a nominal annual production rate of 25 gal/sq. ft. of distiller has been assumed. Obviously, this figure depends greatly upon the solar radiation régime at the still site, upon some variations in performance due to design and upon the extent to which performance might suffer because of deterioration over-time and insufficient maintenance. Although higher distillation rates can be obtained, it appears improbable that annual yields greater than 30 gal/sq. ft. can be realized without resort to expensive alterations in design, such as the incorporation of bottom insulation or heat reuse facilities.

Operating labour and supervision

The cost of labour for operating and supervising a solar still appears to be the only item that is relatively independent of the total investment in the facility. Operation does not include repair and maintenance, and refers only to the routine tasks of providing for the supply and the delivery of salt water, brine and distilled water to the various units concerned, the addition of treating agents to the raw water and the product, the maintenance of records, the collection of revenue from the users of the water and the ordering of maintenance services when required. Some of these tasks may, of course, not be involved in particular installations because of their being assumed by other agencies. Somewhat uncertain at this time is the need for occasional cleaning and flushing of the salt-water basin. The growth of algae and other organisms does not appear detrimental, but it is possible that periodic removal will be found desirable.

The nature of the solar distillation process is such that it is virtually self-regulating. The only manual tasks are the switching of pumps for feed- and product-water handling and possibly the addition of liquid or solid chemicals to these streams. Even if these tasks are performed manually (rather than automatically), and if the "paper work" mentioned above is included, only a few man-hours per week are required, regardless of the size of the still. Practical solar stills for community water supply would therefore normally be operated by a person who had other duties and who could conveniently combine these tasks. If so, only a portion of his wages should be chargeable to distiller operation. The cost of these services would depend upon their extent and the prevailing wage scales.

There are solar stills currently in operation which are virtually unattended, except for occasional checking for major damage; and plans for completely self-operated units have been made. Study of several examples indicates a lack of reason for operating labour and supervision to exceed a maximum of possibly \$1,000 per annum, and it certainly could be much less. This amount is a relatively small item in the cost of water from a large plant (e.g., above 20,000 gpd); but in a small installation (e.g., 1,000 gpd average production), it could be excessive. It may be concluded that except in regions where relatively unskilled labour is very cheap, operating labour should be minimized or eliminated by use of automatic supply-and-delivery facilities. Where labour is available at a cost of very few dollars per day, automatic operation might not represent significant savings.

Distiller productivity

In order to determine the total (fixed plus operating) cost of producing solar-distilled water, per unit of product, it is necessary to know the quantity of water that can be delivered per unit of capital cost (or per unit of plant area). Still productivity has been discussed above in some detail (see chapter II, section C). It was shown that still outputs could be as high as 25 gal/sq. ft. per annum, plus rain-water catchment, with some prospects for small improvement.

Storage cost

It is difficult to generalize on costs of product-water storage, as outlined in chapter II, section C. However, a sample calculation based on the example of estimated still performance given in table 3, assuming no rain-water catchment and uniform water demand throughout the year to be met entirely from the solar still, is detailed in annex III. In this example, it is shown that summer-to-winter storage can add about \$0.54 per 1,000 gallons to a water cost which is otherwise in the range of \$4.00 per 1,000 gallons. This example is one of very high storage requirements. (Note that, in this example, collection of winter rainfall, if available, would reduce both required still size and storage requirements.)

Cost of product water

In review, the total fixed costs as an annual percentage of capital investment, the total cost of supplying salt water to the distiller over a year's time and the total operating labour and supervision expense, when added together equal the total annual cost of providing solar-distilled water for use. This amount divided by the total gallons of distilled water produced (plus assured collection and storage of rain-water) per annum equals the cost of each gallon of potable water produced. If all of this water can be used, this figure is also the cost of each gallon of water used. The following equation, in which \overline{IA} , \overline{MR} and \overline{TI} represent the average value over the estimated life of the installation, summarizes this relationship:

$$C = \frac{10I(\overline{IA} + \overline{MR} + \overline{TI}) + 1000(Oc + S)}{A(Y_D + Y_R)}$$

where C = cost of water (dollars per 1,000 gallons);

I = total capital investment (dollars);

\overline{IA} = annual interest and amortization rate (percentage of investment);

\overline{MR} = annual maintenance and repair labour and materials (percentage of investment);

\overline{TI} = annual taxes and insurance charges (percentage of investment);

O = annual operating labour (man-hours);

c = operating labour wage (dollars per man-hour);

- Y_D = annual unit yield of distilled water (gallons per square foot);
 Y_R = annual unit yield of collected rain-water (gallons per square foot);
 A = area of distiller on which yields are based (square feet);
 S = total cost (fixed and operating) of salt-water supply.

Since some of the items in this equation depend upon gross distiller size and some do not, an actual cost figure must be based on a specific total size. The major part of the total cost, however, is in the fixed costs related to capital investment, and since capital investment is nearly directly proportional to distiller size (after the relatively constant costs of pumps, piping and accessories have been greatly exceeded by those costs proportional to area), most of the water cost in sizable plants (i.e., with average annual capacities of 10,000 gpd or more) can be determined without reference to a specific distiller size. Thus, if the total annual fixed charges are 10 per cent and the still costs \$0.60-\$2.00/sq. ft. to construct (including storage and auxiliaries), and if the annual productivity is 25 gal/sq. ft., the resulting fixed cost of \$3-\$6 per 1,000 gallons represents nearly the entire cost of the solar-distilled water produced. To this can be added a few cents for the cost of supplying the necessary salt water to the still, either from the sea or from a brackish well. Operating labour expense (which might be virtually zero) would have to be added to obtain a total cost. The operating labour would depend upon the size of the installation, when reduced to the basis of 1,000 gallons of product. It might, of course, be an appreciable item if the solar distiller were quite small (say, in the hundreds of gallons per day). Lastly, this cost of \$3 to \$6 would have to be adjusted if any part of the total output of the distiller could not be used unless additional facilities were provided. These cost estimates would be affected by rain-water collection, e.g., if an additional 12 inches of precipitation were to be collected, stored and used, the total fixed costs quoted above could be reduced per 1,000 gallons of usable water.

Applications of solar distillation and alternative supplies
in situations of high water cost

The approximate costs of solar-distilled water have been shown to be \$3-\$6 per 1,000 gallons, plus storage costs, less the value of recovered rainfall. These costs can be compared with the costs of alternative methods of supply, from naturally fresh sources and other desalination processes.

There are numerous examples of expensive water supplies and of situations where population or economic development are water-limited.

In a number of locations where solar stills have been constructed and where other desalination processes have been put into service, the cost of existing supply replaced by the desalination unit has ranged as high as \$7 or more per 1,000 gallons. At this upper level of cost, the water was transported at several locations by truck, railway tank car, mules, and small tanker, and by humans.

In some of these locations, there have been existing supplies of water of such low quality (containing several thousand ppm of dissolved salts) that it was virtually unusable for human consumption. Drinking water was provided by other means, such as those noted above. In effect, therefore, dual supplies were provided in these locations.

In the arid zones of the Turkmen SSR, if the consumer is more than 50-60 miles from sources of fresh water, it is more economical to use solar stills than to bring in the water by truck or to collect rainfall (24). For the central and eastern parts of the Kara-Kum Desert, the cost of water brought in from a fresh-water source at a distance of 70 km from the consumer would be \$20-\$28 per 1,000 gallons (25). On the Makram coast of Pakistan, the cost of trucked-in, slightly salty, but drinkable, water is \$43 per 1,000 gallons. Numerous other examples of high water cost, all at small levels of demand in sparsely populated areas, can be cited.

In many countries, there are large areas of unused land where there is sufficient vegetation for live-stock grazing but insufficient drinking water for survival of the animals. In several semi-deserts, there are known supplies of saline water near or on the ground surface; and there are other areas where shallow brackish aquifers may exist. Several studies, particularly those conducted in Australia and the USSR, have shown that the provision of desalted water for drinking by sheep and cattle at suitably spaced watering points, would permit utilization of such lands. Solar stills, supplied with saline well water by wind-operated pumps and completely automatic in operation (subject only to periodic inspection), have been designed for this service; and economic evaluation has shown that the cost of water installations can be more than offset by profits on stock-raising. An Australian estimate shows that a solar still of about 4,500 sq. ft. might be built for about \$2,500, and that it would supply water for 350 sheep (for a water cost of about \$4 per 1,000 gallons) grazing on waste land. The first cost of the sheep plus the distiller investment would be about \$4,500; and with an estimated net increase in sheep value of \$2 per animal per annum, the \$700 gain would represent an annual return on invested capital of better than 15 per cent. Estimates based on conditions in the Turkmen SSR have led to similar conclusions, i.e., that pastures now unused can be used for stock-grazing and should have water supplied by solar stills. It thus appears that when solar stills requiring only intermittent attention have been developed to a dependable level, they should have considerable use for live-stock watering in arid areas.

As there are limits to the distance animals can walk from grazing to watering, this application needs a large number of small widely distributed desalination plants. This appears to be an ideal application of solar distillation, and one for which solar distillation is uniquely suited. When considering the distribution of desalination facilities in this manner, however, care must be taken in the disposal of the brine concentrate discharged from the still.

Desalted water obtained by solar distillation versus conventional processes

The cost of solar-distilled water is about \$3-\$6 per 1,000 gallons, and it is not very sensitive to plant size at capacities above about 5,000 gpd. The total cost would rise at lower capacity, due to the influence of operating labour costs (for non-automatic plants) and the nearly constant capital cost items, such as pumps and auxiliaries. At sizes substantially above this figure, the

economies of scale would operate to some extent, but the capital cost of the installation per unit of capacity would not decrease as rapidly as does the cost of most process equipment.

There are large (millions of gallons per day) commercial plants desalting sea-water at costs of approximately \$1 per 1,000 gallons, and designs of very large conventional evaporation plants anticipate total water production costs dropping below \$0.50 per 1,000 gallons. It is amply clear that solar distillation, in its current form, cannot compete and can never be expected to compete with these large evaporation plants.

On the other hand, the operation of a conventional multiple-effect evaporation system at outputs as low as 10,000 gpd, or even 50,000 gpd, would be extremely expensive. Cost analyses have shown that at capacity levels below 25,000-50,000 gpd, an estimated product cost of \$3 per 1,000 gallons for solar distillation is lower than that achieved by any other existing process when operating on sea water in a locality where power supplies have to be especially provided. This is particularly true in areas where labour rates (for construction) are not high and where the availability of waste heat, power-supplies, and skilled maintenance labour are severely limited. The vapour-compression process is now the closest competitor when desalting sea-water in the 25,000-50,000 gpd capacity range; at 10,000 gpd or less, vapour compression cannot now compete with solar distillation in a good climate.

It may be concluded that if a need exists in a community in which there is abundant sunshine and in which there is a requirement for potable water in the range of up to, say, 25,000 gpd, a solar still can provide the most economical supply of desalted sea-water. For demands appreciably above this level, further analysis of factors must be made, including variation in seasonal demand, variation in seasonal output of solar distiller, specific cost factors, availability of storage and most recent information on the cost of conventional processes in the size ranges required. Above about 50,000 gpd, non-solar methods now appear to be most economical.

It should be noted that if brackish water is the source, salt concentration is an important factor in determining water costs from membrane processes (electrodialysis and reverse osmosis); the costs of these processes in sizes below 50,000 gpd would need to be compared with costs of solar distillation, and they may be lower.

As noted previously, the capital-intensive nature and long life of solar distillation may indicate the choice of other processes if a rapidly expanding water need beyond the normal range of solar distillation (up to 25,000-50,000 gpd) is foreseen.

On the other hand, within the range in which they are most economical, solar stills have the advantage that additional capacity can generally be added in any increment, reducing the need for over-design of the plant. Thus, unless water demands are expected to rise above levels approaching those at which competing processes become cheaper than solar distillation appreciably before the solar plant is amortized, solar distillation can offer maximum economy.

Summary and conclusions regarding economics of solar distillation

Although the costs of solar-distilled water cannot yet be appraised with certainty, technical and economic data based on nearly a dozen large solar stills in four countries have recently permitted some usable cost estimates. Basin-type solar stills of durable materials can be built in sizes of tens of thousands of square feet at costs of \$0.60-\$2.00/sq. ft. At these costs and with typical productivities, amortization rates and other operating costs, solar-distilled water can be produced in favourable climates for \$3-\$6 per 1,000 gallons. If rain-water collection is included, the cost can drop appreciably below \$3.

Of the various types of solar stills heretofore proposed and tested, those employing durable building materials, such as concrete, asphalt, glass and non-corroding metal, appear to have the best prospects for expanded use; and they currently represent the cheapest source of solar-distilled water.

Comparing glass-covered basin stills with plastic-covered stills, there is as yet no firm evidence of a substantial difference in the capital costs. This may be ascribed in part to the newness of the films themselves and the designs incorporating them. Since more conventional methods and materials have been involved in the durable type of stills, somewhat less experimentation has been involved in their construction. Thus far, therefore, the glass distiller, with its longer service life and lower depreciation costs, yields water at lower cost than does the plastic still. The cost ratio is roughly equal to the ratio of the two effective fixed charge rates, which were previously seen to be about 10 per cent versus at least 20 per cent per annum.

As to future prospects, there appear to be possibilities for substantial reduction in the capital cost of plastic-covered stills, conceivably to a level approaching half that of most of the glass-covered designs. If this can be achieved and if a reasonably trouble-free design can be developed with a plastic film having an assured three-year service life, and if the film and its installation could be provided at a cost of \$0.10-\$0.15/sq. ft., the water cost would be in the same range as that from typical glass-covered units.

In the entire field of desalination, solar distillation can have economic advantages in capacity ranges up to possibly 50,000 gpd and most certainly up to 25,000 gpd. For small communities in climates of good radiation, in areas where power supplies or sources of waste heat are not readily available and where skilled labour is at a premium (features common to essentially "remote" or "isolated" communities or water demand centres), solar stills have a distinct economic advantage over other processes for desalting sea water. The total water production cost, although much higher than usual large-scale fresh-water supplies, can be substantially cheaper than alternative sources in many locations where potable fresh water is unusually scarce and expensive. In addition, the rather low foreign exchange element of solar-still costs (where locally available materials of construction are used) may be of special economic importance.

III. TRENDS IN SOLAR DISTILLATION

A variety of processes and systems have been proposed for using solar energy to obtain potable water. The basin-type still previously described in detail is the system most advanced in its technology. Other processes - which have been less extensively studied, which may combine water production with other functions, which may depend upon developments in other areas of research and development or which may be of a more speculative nature - are here briefly discussed. Any of these processes could conceivably have significant impact in reducing the cost of potable water supplies and widening the current rather narrow scope of solar distillation.

Discussed below are five groups of potentially significant developments:

- (a) further evolution of basin-type stills; (b) other types of solar stills;
- (c) system using combined energy sources (solar plus other); (d) multiple-purpose systems; and (e) systems in which several functions are closely integrated.

A. Evolution of basin-type stills

There are continuing research and development projects concerning basin-type stills. The energy balances on these systems indicate that it will not be possible to realize large increments in productivity (at the maximum, yield improvement might be one third over current yields), and efforts are directed primarily at reduction in still costs. Engineering developments are lowering still costs and, in some cases, resulting in improved performance. Several approaches may be considered.

Reductions in cost through the use of inexpensive local construction materials or inexpensive local labour, or through factory production of inexpensive standard parts with subsequent assembly at the site are conceivable. Caution must be exercised, however, to ensure that substitution of materials shall not correspondingly reduce still productivity and especially still service life.

Use of transparent plastic covers has been noted. Further development of low-cost, long-lived plastic films with desirable optical and mechanical properties, combined with further engineering development of plastic still design, may result in reduced distilled-water costs. Other materials development, such as material for basin liners, adhesives for glass or plastics, and structural and collection trough materials, may also result in cost reduction. (For example, the recent availability of a flexible silicone adhesive for glass has resulted in the simplification of methods of cover assembly and lower costs for the CSIRO still.)

Manufacturing methods for solar stills may evolve in either of two directions. Manufacture on site with local materials and labour has been noted. In contrast, factory production of modular units, which can then be assembled in multiples on site, may offer greater flexibility in design, control of still quality and economy. The scale of the solar-distillation process may have an effect on the choice among a spectrum of these alternatives; sizes in the range of, for example, 10,000 gpd or more may lend themselves to more on-site

fabrication and to greater use of heavy materials such as concrete, while smaller stills may be better adapted to factory production of at least some of their components. It can be expected that engineering and cost studies of these alternatives will result in steady progress towards lower still costs, but probably not to large decrements in water costs.

A further development to be foreseen in basin-type stills is towards smaller scale applications, i.e., less than 500 gpd. Some development work is in progress on "family-size" solar stills for small isolated groups of people. These should be able to produce potable water at costs that would be competitive with any other currently available desalination process. A modular concept of a well-engineered still can provide flexibility in capacity to meet a range of water needs.

B. Collection of solar energy: solar ponds

The solar distillation process involves essentially two basic operations: the collection of solar energy; and the distillation process itself. The basin-type still combines these functions in a single unit. Other designs separate them, to admit the possibility of multi-stage distillers and energy reuse (which is not possible in basin-type stills).

If solar energy collection is separated, the solar-distillation problem is put in other terms. What is the cost of delivering energy from the solar collector to the still; how does that cost compare with the cost of energy from other sources; and what effect does the nature of the solar-collection process (it is temperature-limited and time-dependent) have on the cost of the distillation part of the process? It appears, on the basis of experience to date, that solar-collected energy for operation of conventional stills is not competitive. Very significant developments must occur in solar-collector technology before systems with separate collector and distiller will become economically viable.

One solar-collector development that is worthy of special note is the solar pond (26, 27). This is a concept for collecting solar energy in large amounts without the use of glass or plastic covers. The solar pond is a black-bottomed pond of 1-2 metres depth containing water having a salt concentration that increases from the top surface to the bottom. The salt concentration gradient results in a density gradient so that the pond can heat up at the bottom. The heat stays at the bottom in static, non-convecting layers, with the overlying water providing good insulation. Heat is removed by decanting the bottom layer of hot solution from the pond, and temperatures over 90°C have been achieved in experimental ponds.

The collection efficiency of such a pond depends upon the conditions of use, but a figure of about 20-25 per cent is expected in real operating ponds. It may immediately be seen that, provided the cost of lining such a pond and operating the system are reasonable, this can be a very cheap source of calories in a sunny climate. For example, a pond having an area of 1 km² in a sunny location would provide 0.4×10^{12} kcals of heat per annum or the equivalent of 50,000 tons of fuel oil (burnt at 80 per cent combustion efficiency). If the price of fuel delivered to a remote site is \$20 a ton, this is an annual value of \$1 million. Calculations show that the capital cost of such a pond is likely to be on the order of \$2-\$3 million, so that if operating costs are reasonable and a number of

years of amortization are allowed, the solar-pond energy can be competitive with energy from fuel.

(The situation may be even more encouraging if the pond is used to produce salt with distilled water as a by-product. This aspect is further discussed below.)

At the current time, it is believed that the solar-pond concept is not suited for very small installations as the complexities which are justified for a unit of 1 million m² may not be justified for plants of a few thousands of square metres. The minimum size at which a solar pond would be justified is not yet known, but it appears that it may be on the order of 10,000-50,000 m². As this is about the upper end of size for basin-type stills, the solar pond would not compete with the basin-type still, but could be complementary to it.

The solar pond has interesting potential, but a great deal of additional research and development is needed before economic evaluations can be completed and designs specified.

C. Combined energy-source systems

Waste heat, in the form of warm water obtained from a variety of sources or warm water originating from geothermal sources, can be used to augment the output of a basin-type solar still without requiring a waste-heat steam generator. This could provide a significant increment to solar-still production in cases, for example, where diesel-generated power is used at a highly variable rate, such as for evening illumination of a village or for operation of a refrigeration plant with on-off control. When warm (saline) water is available from the diesel, it could be canalized into the solar distiller and thereby augment its output (e.g., by operation at night). In contrast, other desalination processes would require expensive secondary equipment to utilize waste heat in warm water. Preliminary estimates are that the cost of incremental improvement in still output might be \$1-\$2 per 1,000 gallons. Further studies are needed to develop the best methods of using waste heat in stills, to assess more accurately costs and improvements in still productivity and to determine the potential extent of application.

D. Multiple-purpose systems

Multiple-purpose processes, producing combinations of products (water and salt, or water and power) offer some encouragements in those unique situations where a combination of appropriately related needs exist.

The solar pond described above could potentially produce both salt and distilled water. For a plant whose primary purpose is salt production and where the salt has a sale value of \$3-\$4 per ton, a water cost projection of \$0.20 per 1,000 gallons has been made (28). Solar ponds have been considered for production of power only, water only, salt only or combinations. It must be observed that they are projected large and relatively inexpensive solar collectors and are potentially adaptable to a range of products.

Observations may be made on the possibilities of salt production in conjunction with solar distillation. First, normal solar-distillation practice, when using sea-water feed, is to evaporate about one half of the feed water. The effluent brine is then at a concentration of about 7 per cent, rather than its original 3.5 per cent. It is still a dilute brine for salt production, but it has had about one half of the water removed. Secondly, in the relatively remote or isolated areas of most likely application of solar distillation, production of salt can quickly saturate local markets if an appreciable part of the brines from a solar still was evaporated to produce salts.

The value of salts other than common salt (NaCl), contained in brines other than sea water, can be assessed through analysis. A combined distillation and evaporation process can then be evaluated as a possible process for both water and salt recovery. This could result in economic application particularly where the mineral to be recovered has a high sale value.

E. Integrated-function plants

If the use of the distillate, i.e., the product water, is or can be structurally related to the collection of solar energy or to the solar-distillation process, an integrated or multiple-function plant may be feasible. For example, if a large greenhouse is used as a collector-distiller for growing plants, and the evaporated and transpired water vapour is recondensed on the cover of the greenhouse, the plant growth requires a much smaller supply of distillate than if there were a separate distilling plant supplying water for open plant growth. In this process, the "still" provides a second profitable function at some cost, with the possibility of increasing economic viability. (Under ordinary circumstances, the cost of distilled water is too high, by one or two orders of magnitude, for use in agriculture; reduced water consumption, coupled with intensive controlled cultivation of valuable crops, could conceivably be of economic interest.)

Put in another way, solar-operated plants under some circumstances should not be compared only with alternate, single-purpose desalination schemes. Rather, it may be advisable to look at all requirements of the users (e.g., for heat, power or other related commodities) which may be associated with water demand and production. The economic viability of such integrated processes will depend, in all likelihood, upon successful technological and economic development of unconventional approaches to meeting the associated needs.

As an illustration of this approach, although it is not in the usual sense a solar-distillation scheme, a programme may be cited of research and development on an integrated system for economical production of power, water and food for coastal desert areas (29).

Power is generated by a diesel generator, which is unconventional in that it is equipped with waste-heat recovery equipment to recover much of the two thirds of the fuel energy that is normally rejected through the cooling system and in the hot exhaust gases. The reclaimed thermal energy heats sea-water feed to a humidity cycle desalination plant to 160°F. Ten per cent of the feed to the desalination plant is converted to distilled water; the other 90 per cent, which would normally be thrown back to the sea as waste, is combined with additional sea water and

pumped to the interior of large inflated plastic greenhouses. The air within the greenhouses is continually circulated through a packed column heat exchanger countercurrent to the spray of sea water. The sea water, by sensible heat transfer, modulates the temperature inside the greenhouses and maintains the humidity of the air at essentially 100 per cent. The exhaust gases from the diesel are purified in a sea-water scrubber, and CO₂ is pumped to the greenhouses for the photosynthetic process. Solar radiation provides energy for photosynthesis.

A combining of these functions in a single system offers advantages. First, there can be a sharing of engineering effort, capital investment and operating personnel. The thermal energy available as waste from the diesel engine, which is operated steadily, is potentially less expensive than possible alternates, including solar energy. The product water of the desalination plant can be less costly than it would be from a single-purpose plant. The cost of distilled water, however, is still far too great for conventional agriculture; but using the sea water inside the greenhouses for humidity control, the requirement for the product from the desalination plant for the food production sector is reduced to a small fraction of what it would be in open-field agriculture. In fact, during a large part of the year, the greenhouses actually produce more fresh water than the plants consume.

During a large part of the winter and at night for much of the year, condensation of fresh water occurs on the inside of the plastic-film greenhouse cover and either rains down on the plants or runs off to be collected in quantities greater than the plants require. While these greenhouses are not proposed as a desalination tool, this indicates that they can be operated, at least during a part of the year, in a mode where the distilled-water cost does not enter into the economics of the agricultural production. Intensive agriculture and plant breeding for growth in the unique environment of the greenhouses are resulting in yields of agricultural products well above normal levels.

It is not possible to say now what the economics of these integrated processes might be. Success in research and development on the various aspects of the processes will determine their applicability.

Figure 1. Solar still, Las Marinas, Spain

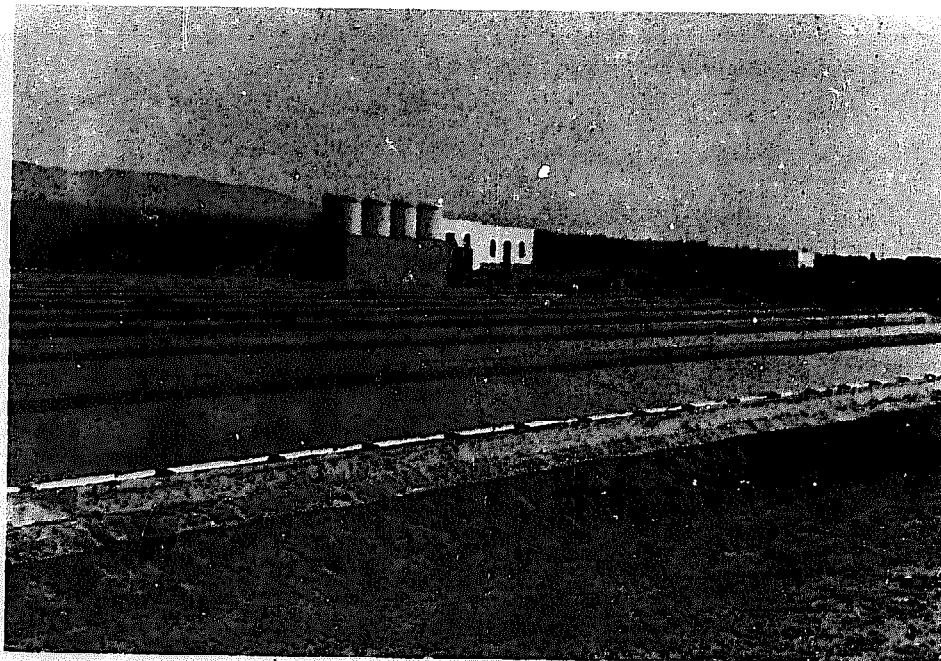
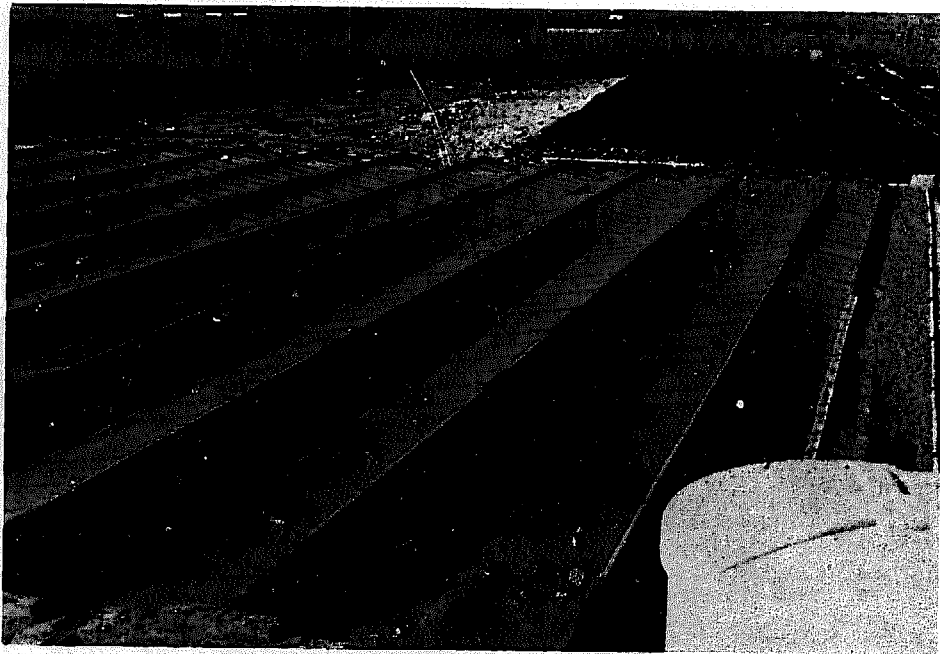

Figure 2. Schematic cross-section of basin-type solar still

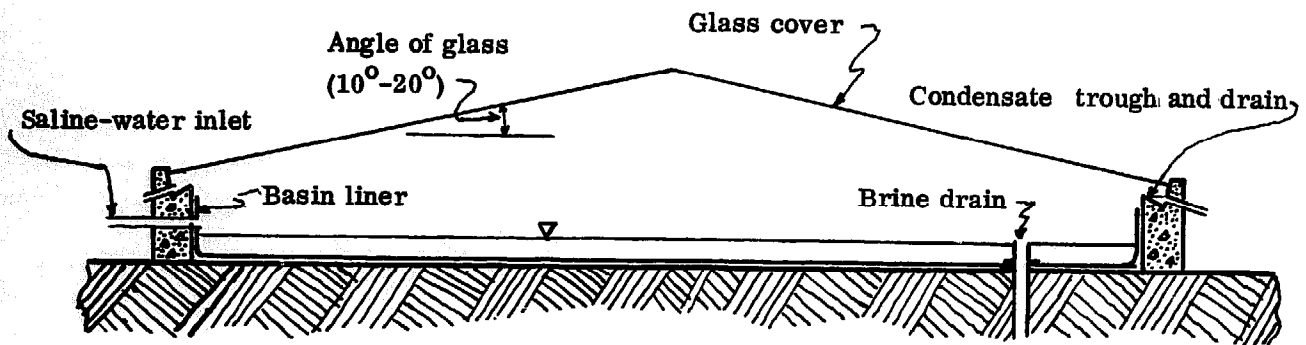

Figure 3. Schematic diagram of solar distillation plant, showing major items of equipment

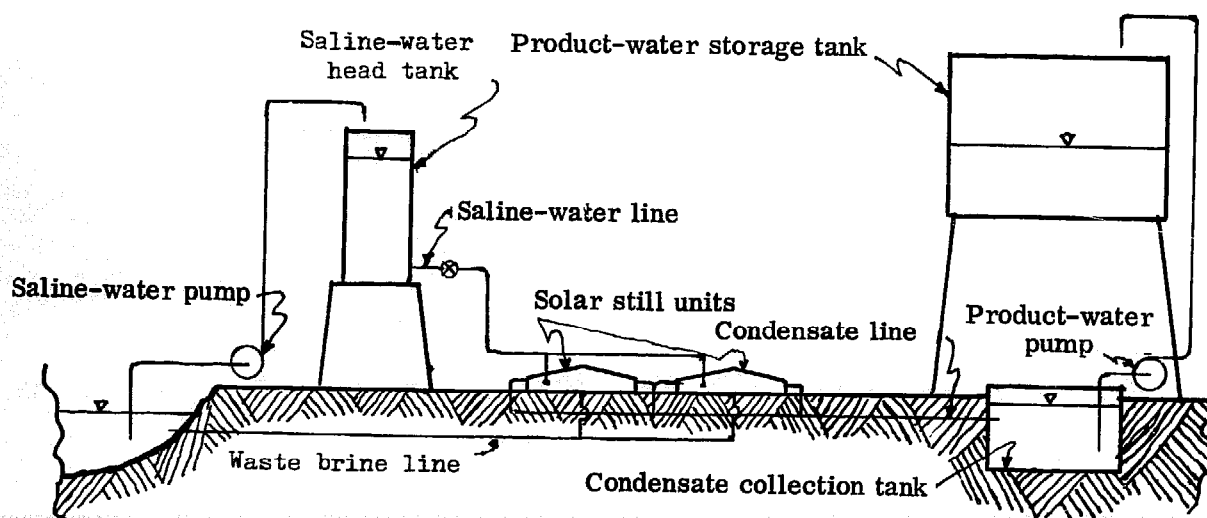
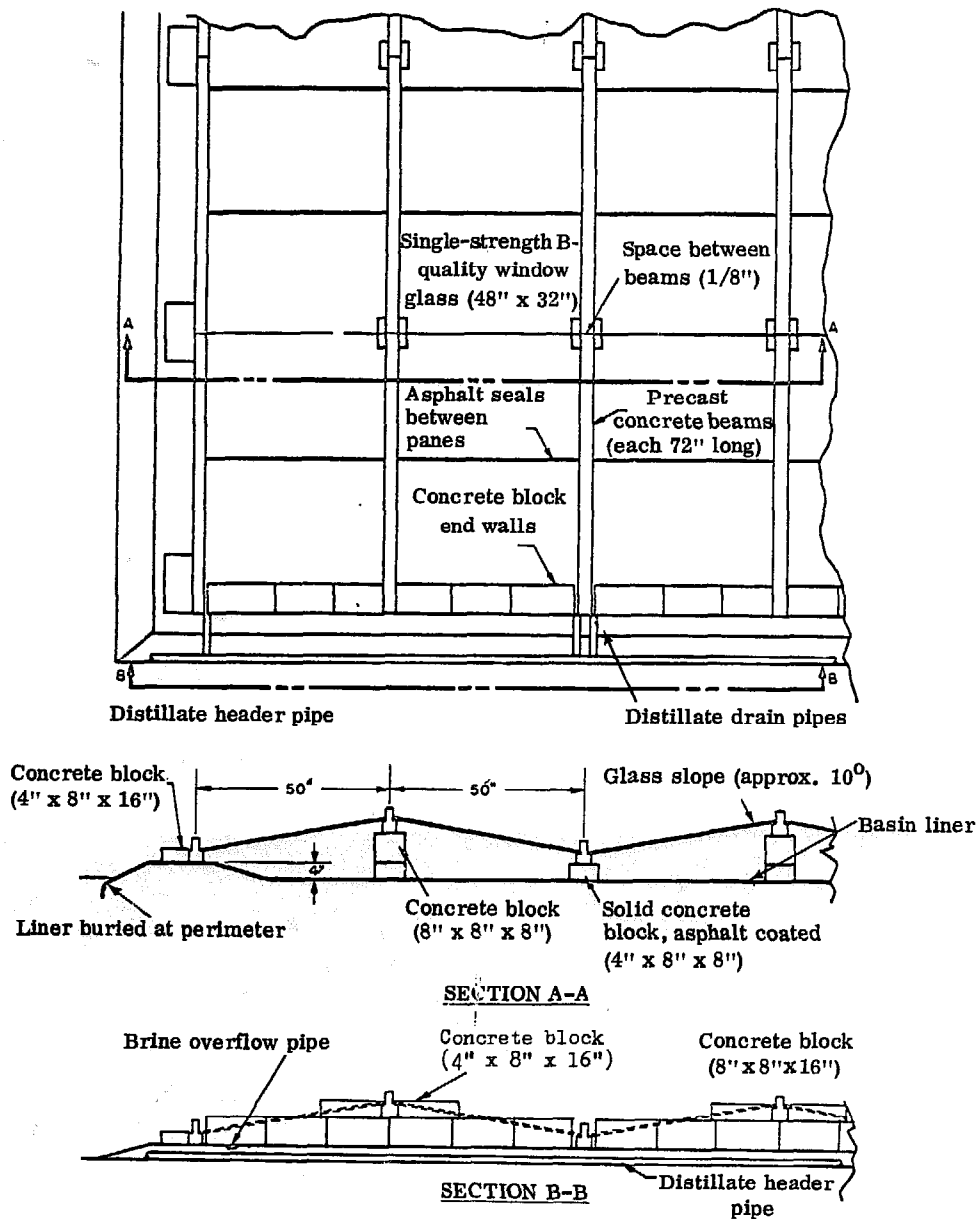
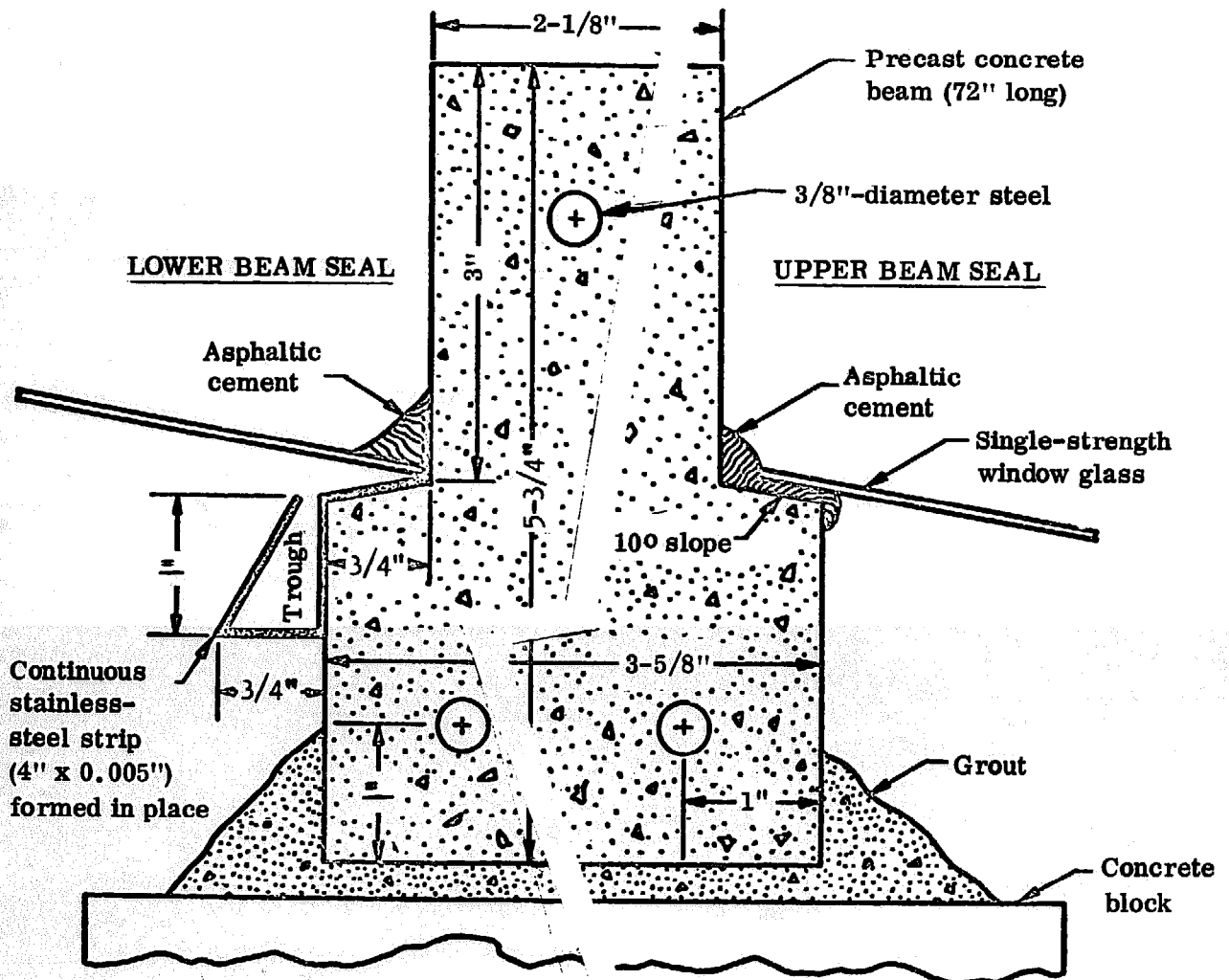

Figure 4. Plan and sections of basin-type solar still, Daytona Beach, United States of America



Source: Battelle Memorial Institute, Design of a Basin-Type Solar Still, Office of Saline Water Research and Development Report No. 112 (Washington, D.C., United States Department of the Interior, 1964).

Figure 5. Beam and glass seal details of basin-type solar still, Daytona Beach, Florida, United States of America



Note: The same beam was used for upper and lower beams. The arrangement of the glass and distillate collection trough at the bottom beam is shown on the left side of the diagram. The way in which the top edges of the glass were supported is shown on the left.

Figure 6. Plan and sections of solar still, Las Marinas, Spain

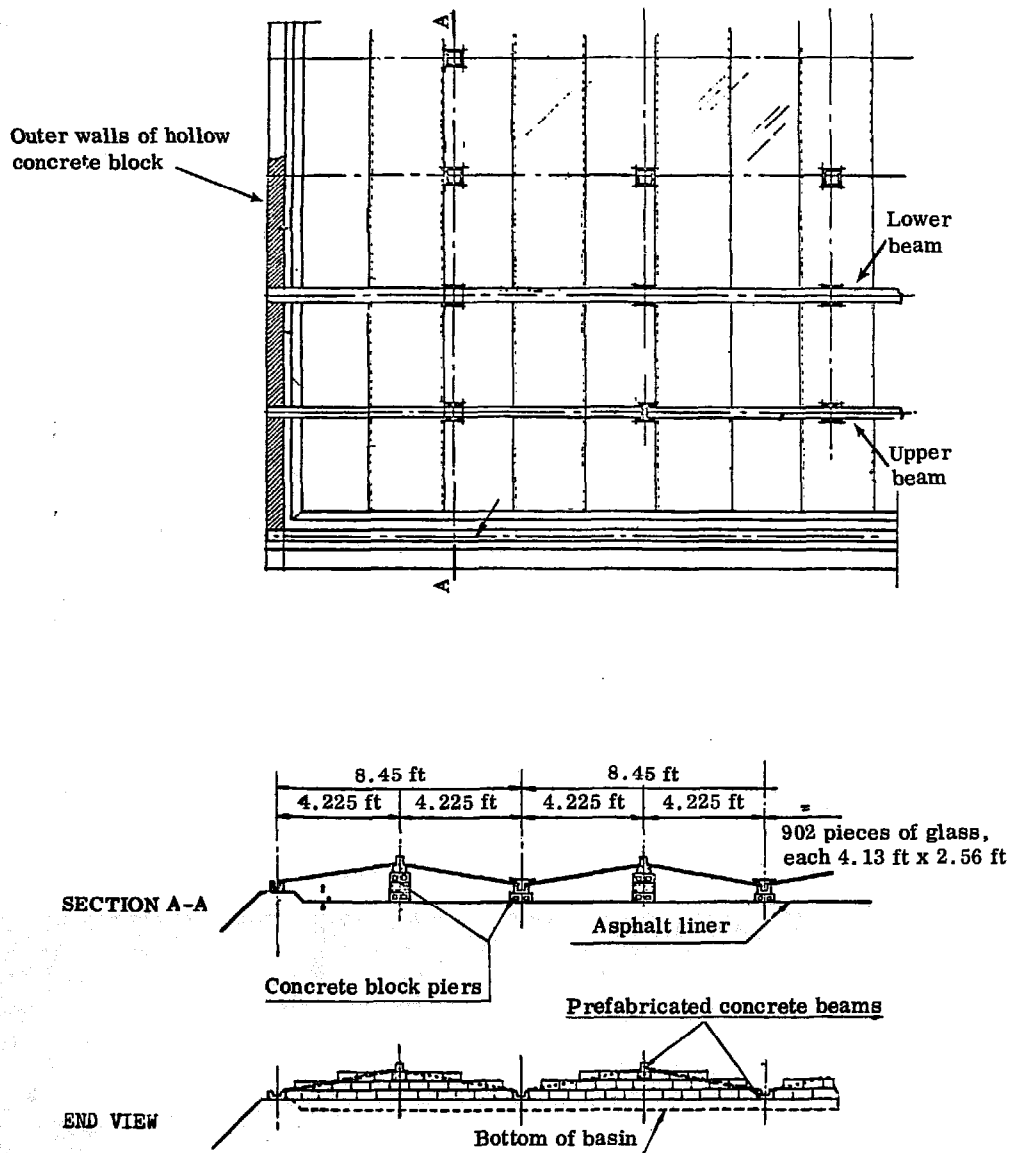

Sources: P. Blanco, C. Gomella and J.A. Barasoain, Installation Pilote de Potabilisation Solaire de "Las Marinas" (Espagne), Coopération Méditerranéenne pour L'Energie Solaire Bulletin No. 9 (Marseilles, France, 1965); P. Blanco, C. Gomella and J.A. Barasoain, Installation de Potabilisation d'eau de mer et d'eau saumâtre à Las Marinas (Almeria), Coopération Méditerranéenne pour L'Energie Solaire Bulletin No. 11 (Marseilles, France, 1966); P. Blanco, C. Gomella and J.A. Barasoain, Projet de Distillateur Solaire pour l'Ile de Neuva Tabarca (Alicante), Coopération Méditerranéenne pour L'Energie Solaire Bulletin No. 12 (Marseilles, France, 1967).

Note: There are eleven upper glass-support beams and ten lower glass-support beams, each mounted on fifteen concrete block piers.

Figure 7. Details of lower beam for solar still, Las Marinas, Spain

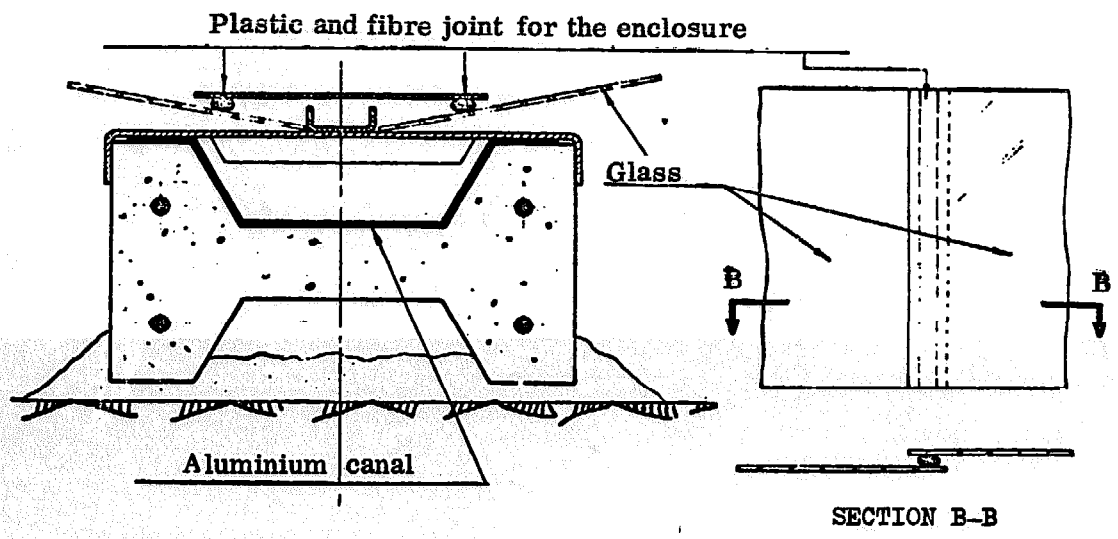
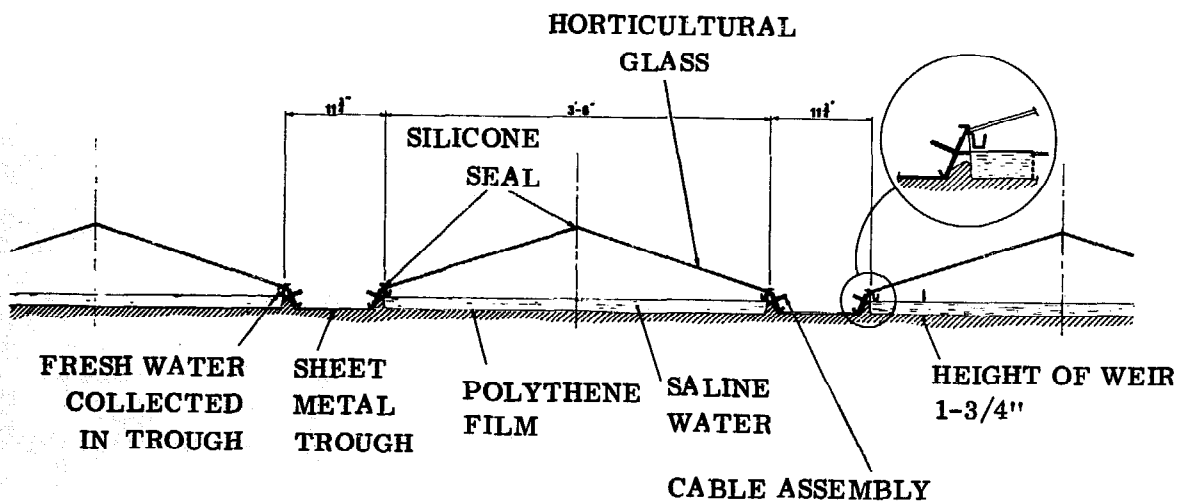
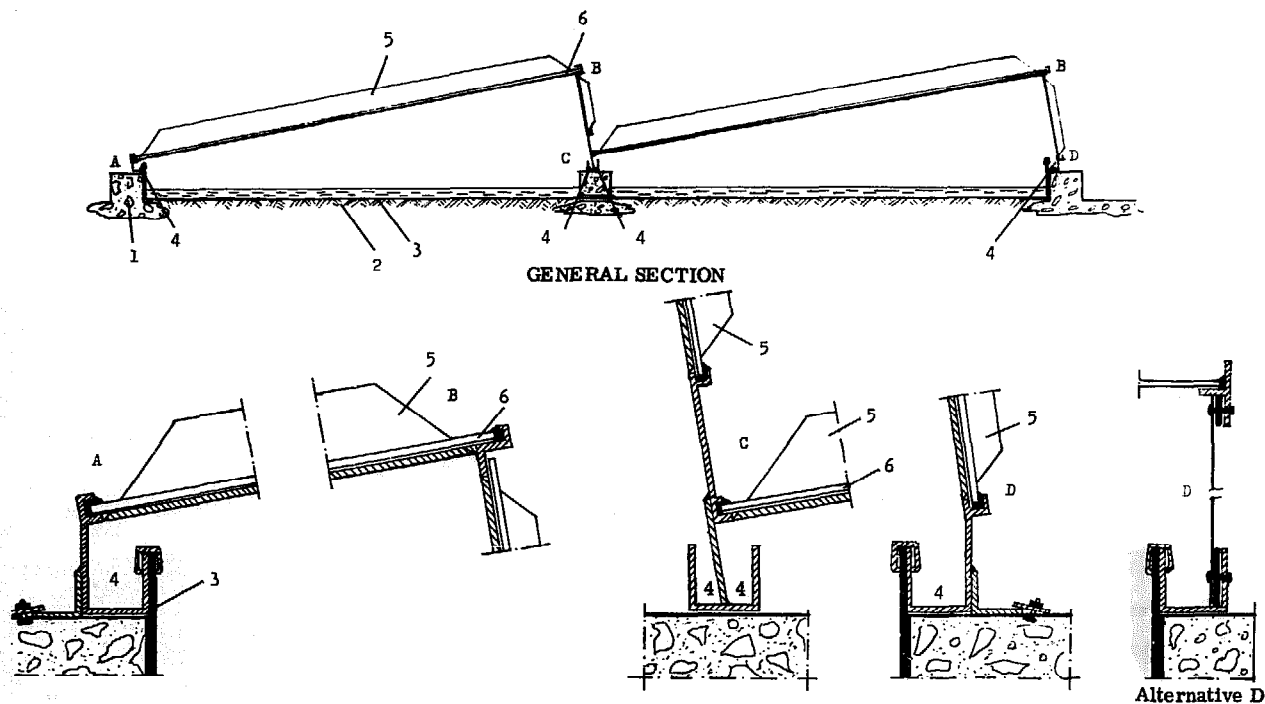

Figure 8. Section of basin-type solar still, Commonwealth Scientific and Industrial Research Organization, Australia



Source: R.N. Morse and W.R.W. Read, "The development of a solar still for Australian conditions", Proceedings of the Conference on Power Production and Energy Conversion, 1966 (Sydney, Australia, Institution of Engineers, 29-30 November 1966).

Figure 9. Section and frame details of basin-type solar still, Technical University of Athens, Greece



Sources: Battelle Memorial Institute, Second Two Years, Progress on Study and Field Evaluation of Solar Sea Water Stills, Office of Saline Water Research and Development Progress Report No. 147 (Washington, United States Department of the Interior, 1965); A.A. Delyannis and E. Piperoglou, "Solar distillation in Greece", Proceedings of the First International Symposium on Water Desalination (Washington, United States Department of the Interior, 3-9 October 1965), vol. 2, pp. 627-640.

Key:

- | | |
|--|----------------------------------|
| 1. Concrete frame | 4. Distillate collection gutters |
| 2. Sand layer for levelling and insulation | 5. Aluminium frame |
| 3. Butyl rubber sheeting | 6. Glass covers |

Figure 10. Schematic design for demonstration unit, small-scale basin-type solar still, for use on Pacific Islands

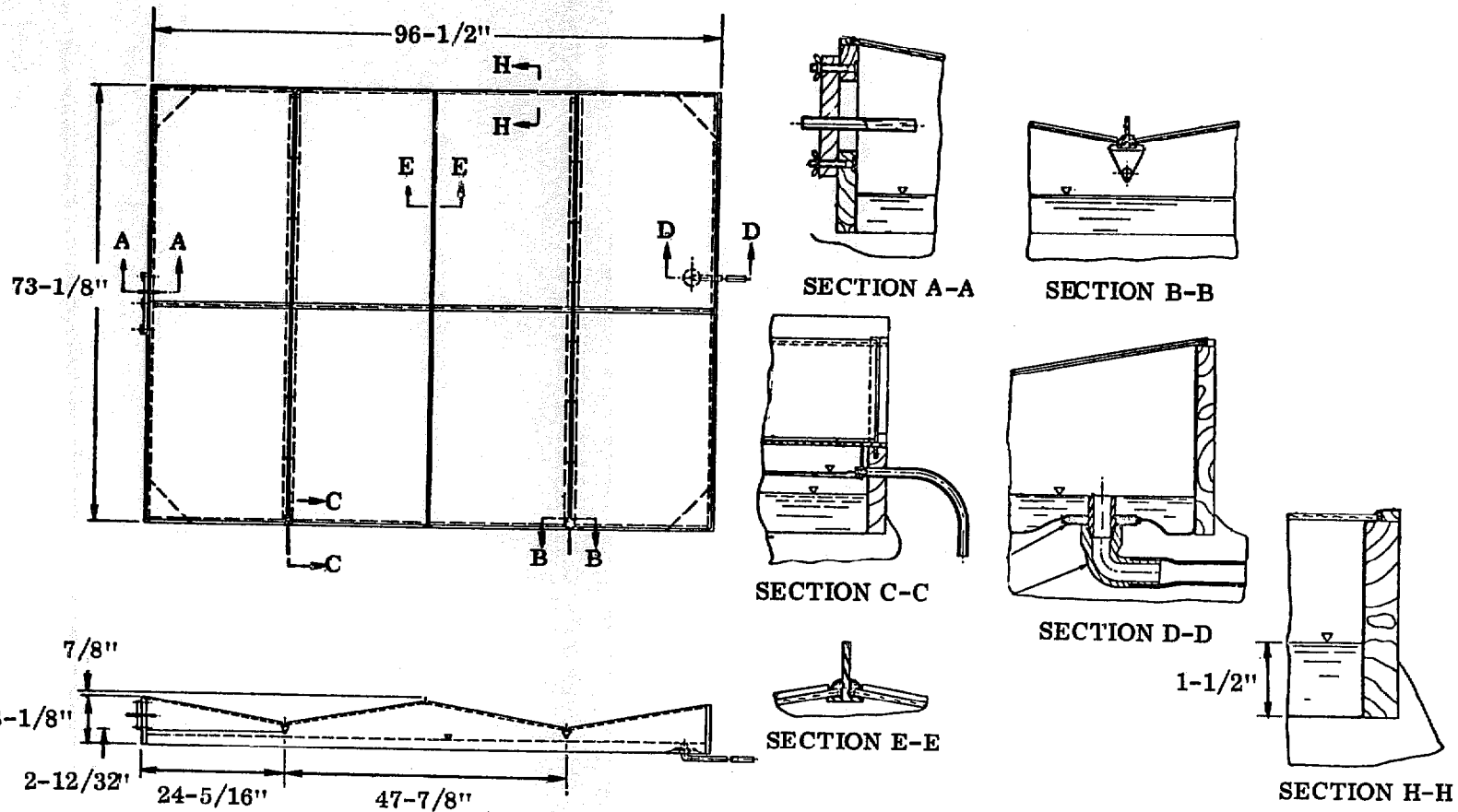

-51-

Sources: G. Nebbia, Researches in the University of Bari (Italy), Coopération Méditerranéenne pour L'Energie Solaire Bulletin No. 5 (Marseilles, France, 1963); E.D. Howe, B.W. Tleimat and A.D.K. Laird, Solar Distillation, Sea Water Conversion Laboratory Report 67-2 (Berkeley, University of California, 1967).

Figure 11. Schematic sections of plastic-covered basin-type solar stills

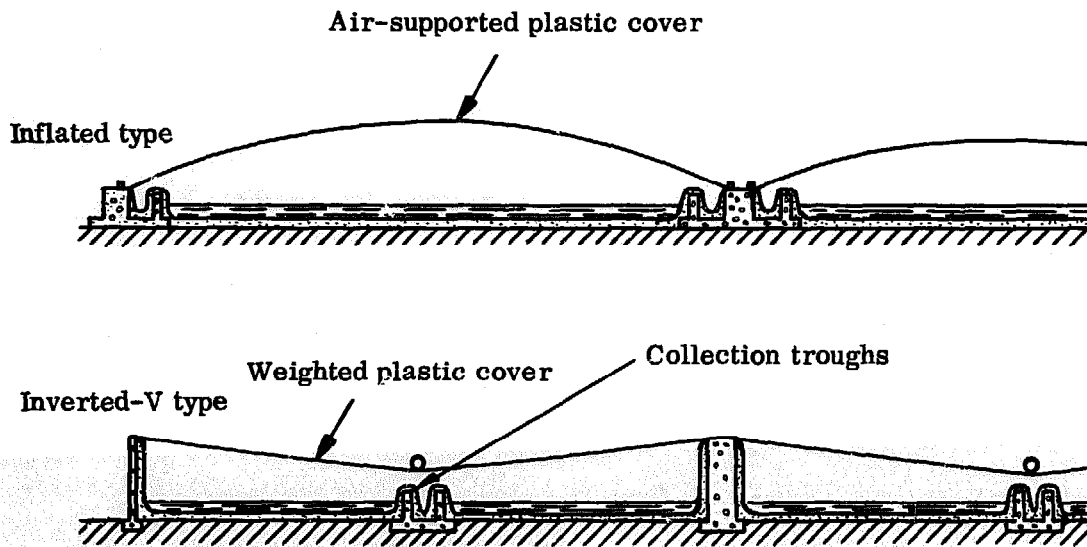

Figure 12. Diagrammatic section of solar still, showing significant energy transport streams to, from and within the still

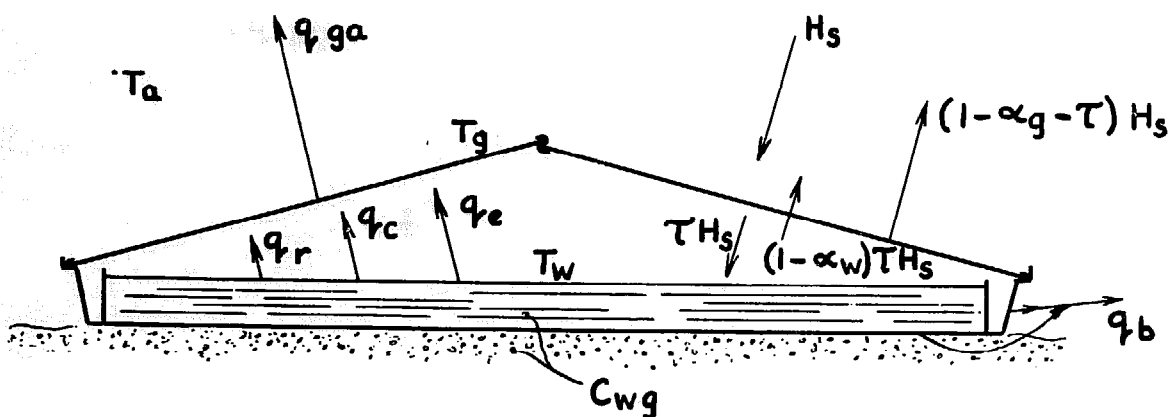

Figure 13. Effect of ambient temperature and loss efficiency on predicted still output at $H_s = 2,555$ BTU square foot⁻¹ day⁻¹

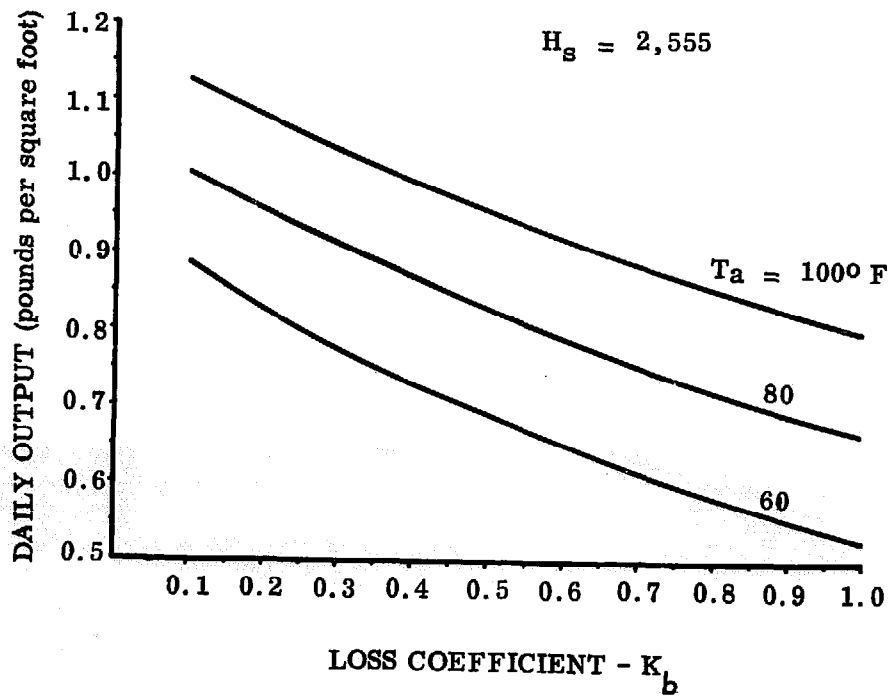

Figure 14 Effect of solar radiation and loss coefficient on predicted still output at $T_a = 80^\circ\text{F}$, $C_{wg} = 16$ and wind velocity of 5 miles per hour

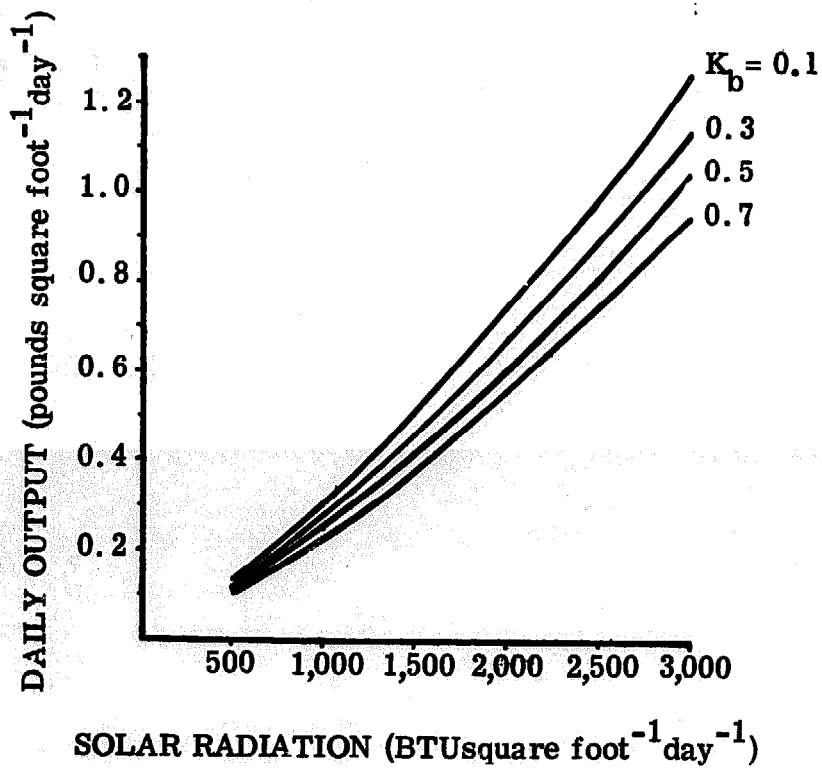
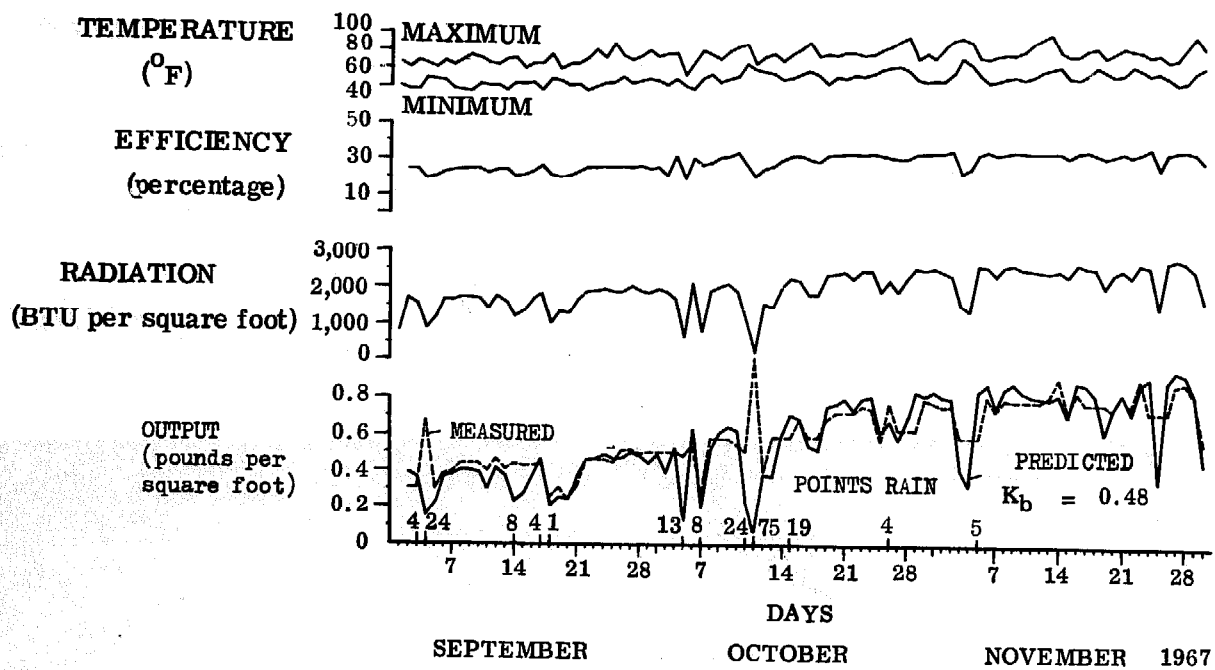
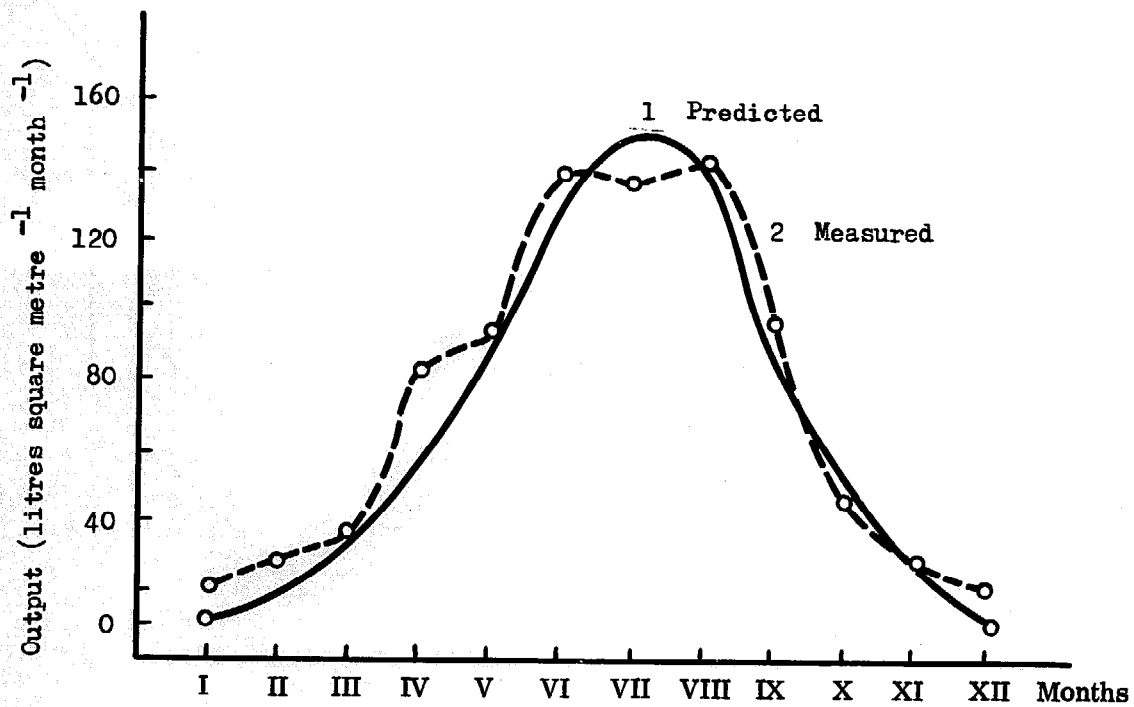

Figure 15. Comparison of predicted and experimental still performances, Griffith, Australia



Note: Still area = 500 square feet
 Glass angle = 18°
 Flow rate = $0.1 \text{ pound hour}^{-1} \text{ square foot}^{-1}$
 $K_b = 0.48$

Figure 16. Comparison of results of extended tests of capacity of basin-type solar stills with results obtained from calculations



Note: Curve 1 - results of tests
Curve 2 - results obtained from calculations

Figure 17. Typical solar-still daily production as a function of radiation and average air temperature

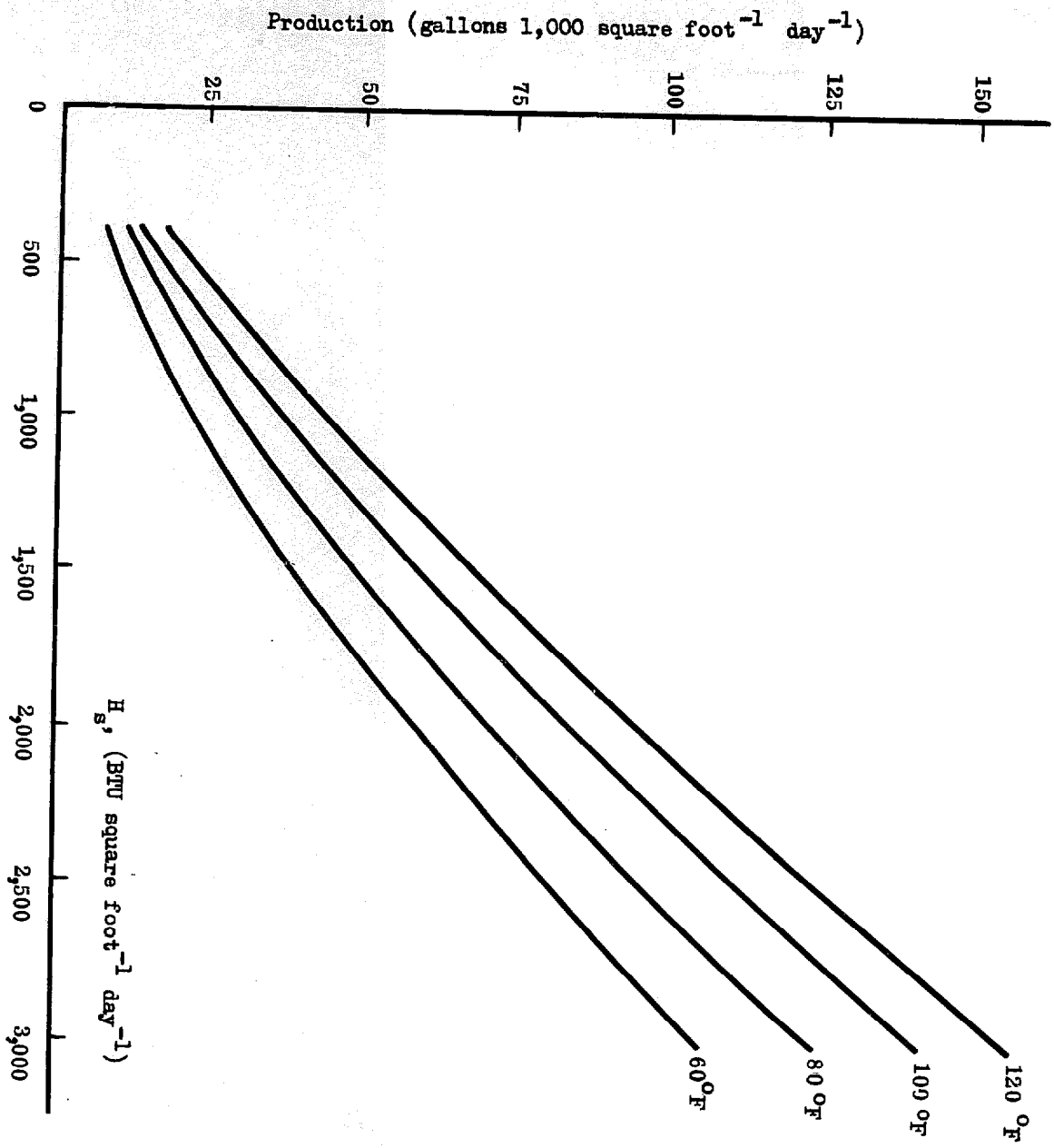

REFERENCES

1. J. Harding, "Apparatus for solar distillation", Proceedings of the Institution of Civil Engineers (London), vol. 73, 1883, pp. 284-288.
2. M. Telkes, Solar Distiller for Life Rafts, Office of Technical Services Research and Development Report No. 5225, P.B. 21120 (Washington, United States Department of Commerce, 1945).
3. M. Telkes, "Improved solar stills", Transactions of the Conference on the Use of Solar Energy, Tucson, Arizona, 1955 (Tucson, University of Arizona Press, 1958), vol. III, pp. 145-153.
4. L.H. Macleod and H.W. McCracken, Performance of Greenhouse Solar Stills, Sea Water Conversion Laboratory Report, series 75, issue 26 (Berkeley, University of California, 1961).
5. G.O.G. Löf, Solar Distillation of Sea Water in the Virgin Islands, Saline Water Conversion Program Research and Development Progress Report No. 5 (Washington, United States Department of the Interior, 1955).
6. G.O.G. Löf, Demineralization of Saline Water with Solar Energy, Saline Water Conversion Program Research and Development Progress Report No. 4 (Washington, United States Department of the Interior, 1954).
7. C. Gomella, "Practical possibilities for the use of solar distillation in under-developed arid countries", Transactions of the Conference on the Use of Solar Energy, Tucson, Arizona, 1955 (Tucson, University of Arizona Press, 1958), vol. III, pp. 119-133.
8. Battelle Memorial Institute, Second Two Years' Progress on Study and Field Evaluation of Solar Sea Water Stills, Office of Saline Water Research and Development Progress Report No. 147 (Washington, United States Department of the Interior, 1965).
9. G. Nebbia, Researches in the University of Bari (Italy), Coopération Méditerranéenne pour l'Energie Solaire Bulletin No. 5 (Marseille, France, 1963), p. 26.
10. Proceedings of the United Nations Conference on New Sources of Energy; vol. 6: Solar Energy III (United Nations publication, Sales No.: 63.I.40), pp. 139-303.
11. P. Blanco, C. Gomella and J.A. Barsoain, Installation de Potabilisation d'eau de mer et d'eau saumâtre à Las Marinas (Almería), Coopération Méditerranéenne pour l'Energie Solaire Bulletin No. 11 (Marseille, France, 1966), p. 32.
12. P. Blanco, C. Gomella and J.A. Barsoain, Projet de Distillateur Solaire pour l'île de Nueva Tabarca (Alicante), Coopération Méditerranéenne pour l'Energie Solaire Bulletin No. 12 (Marseille, France, 1967), p. 47.

13. R.N. Morse and W.R.W. Read, "The development of a solar still for Australian conditions", Proceedings of the Conference on Power Production and Energy Conversion, 1966 (Sydney, Australia, Institution of Engineers, 29-30 November 1966), pp. 39-46.
14. A.A. Delyannis and E. Piperoglou, "Solar distillation in Greece", Proceedings of the First International Symposium on Water Desalination (Washington, United States Department of the Interior, 3-9 October 1965), vol. 2, pp. 627-640.
15. E.D. Howe, B.W. Tleimat and A.D.K. Laird, Solar Distillation, Sea Water Conversion Laboratory Report 67-2 (Berkeley, University of California, 1967).
16. "Solar desalting gains acceptance in Greece", Chemical Engineering (New York), vol. 72, 20 Dec. 1965, pp. 42-43.
17. G.O.G. Löf, J.A. Eibling and J.W. Bloemer, "Energy balances in solar distillers", Journal of the American Institute of Chemical Engineers (New York), vol. 7, 1961, p. 641.
18. V.A. Baum, "Solar distillers", Proceedings of the United Nations Conference on New Sources of Energy; vol. 6: Solar Energy III (United Nations publication, Sales No.: 63.I.40), p. 178; V. Baum and R. Bairamov, "Heat and mass transfer processes in solar stills of hot box type", Solar Energy (United States of America), vol. 8, 1964, p. 78.
19. R.N. Morse, Commonwealth Scientific and Industrial Research Organization, Hightett, Victoria, Australia.
20. R. Bairamov, "Comparative tests of solar stills", Izvestia of Turkmenian Academy of Sciences (Ashkhabad), No. 1, 1964.
21. G.O.G. Löf, J.A. Duffie and C.O. Smith, World Distribution of Solar Radiation, Engineering Experiment Station Report No. 21 (Madison, University of Wisconsin, 1966).
22. M.I. Budyko, Atlas Teplovogo Balantsa (Leningrad, Glav. Geofi. Obs. in Voeikova, 1955; rev. ed. 1964).
23. United Nations, The Design of Water Supply Systems Based on Desalination (United Nations publication, Sales No.: 68.II.B.20).
24. V.A. Baum and R. Bairamov, "Prospects of solar stills in Turkmenia", Solar Energy (United States of America), No. 1, 1966; V.A. Baum et al., in Proceedings of the VII World Power Conference (Moscow, 1968).
25. V.A. Baum, R. Bairamov and Yu Malevski, Possibilities of Using Solar Energy in Reclaiming Deserts, Problems of Desert Reclamation Report No. 5 (Ashkhabad, 1967).
26. H. Tabor, "Solar ponds", Science Journal (London), June 1966, p. 66.
27. H. Tabor and R. Matz, "Solar pond status report", Solar Energy (United States of America), No. 9, Oct. 1965, p. 177.

28. H. Tabor, personal communication to the United Nations Secretariat, 1968.

29. C.N. Hodges, Controlled Environment Agriculture for Coastal Desert Areas, Environmental Research Laboratory Report (Tucson, University of Arizona, 1967).

SELECTED BIBLIOGRAPHY

The following also contain information relevant to the economics, design and operation of solar stills, and to the utilization of solar energy.

Bairamov, R. and Ya. Atayev. Economic effect of solar stills. Heliotechnika (Tashkent), No. 5, 1966.

Battelle Memorial Institute. Design of a basin-type solar still. Washington, Office of Saline Water, Department of the Interior, 1964. (Research and development progress report, 112).

Baum, V.A., R. Bairamov and K. Toilur. Report. Heliotechnika (Tashkent), No. 5, 1967.

Blanco, P., C. Gomella and J.A. Barsoain. Installation pilote de potabilisation solaire de "Las Marinas" (Espagne). Marseilles, France, Coopération Méditerranéenne pour L'Energie Solaire, 1965. (Bulletin, 9).

Bloemer, J.W. and others. A practical basin-type solar still. Solar energy (United States of America), 9:197, 1965.

Bloemer, J.W. Factors affecting solar-still performance. New York, American Society of Mechanical Engineers, 1965. (Paper 65-WA/SOL-1).

Brace Research Institute, McGill University. How to make a solar still (plastic covered). Montreal, 1965. (Do-it-Yourself leaflet, 1).

Brice, D.B. Saline water conversion by flash evaporation using solar energy. Paper submitted to the American Chemical Society Meeting, Washington, D.C., March 1962.

Dunkle, R.V. Solar water distillation: The roof-type still and a multiple effect diffusion still. In International developments in heat transfer. Papers submitted to the International heat transfer Conference, Denver, Colorado, 1961. Denver, University of Colorado, 1961. Part 5, p. 895-902.

Eibling, J.A., R.E. Thomas and B.A. Landry. An investigation of multiple-effect evaporation of saline waters by steam from solar radiation. Washington, D.C., Saline Water Conversion Program, Department of the Interior, 1953. (Research and Development Progress Report, 2).

Hodges, C.N., and others. Solar distillation using multiple-effect humidification. Washington, D.C., Office of Saline Water, Department of the Interior, 1966. (Research and Development Progress Report, 194).

- Howe, E.D. Solar distillation on the Pacific atolls. South Pacific Bulletin (Sydney, Australia, April 1964), p. 57-59.
- Howe, E.D. and B.W. Fleimat. Solar distillers for use on coral islands. Desalination (Amsterdam), 2:109-115, 1967.
- Lawand, T.A. The engineering and economic evaluation of solar distillation for small communities. Paper submitted to the Solar Energy Society meeting, October 1968.
- McCracken, H. Description of Sunwater Company solar stills. San Diego, California, 1968.
- Morse, R.N. and W.R.W. Read. A rational basis for the engineering development of a solar still. Solar energy (United States of America), 12:5-17, 1968.
- Telkes, M. Flat tilted solar stills. In Proceedings of the International Seminar on Solar and Aeolian Energy, Sunion, Greece, 1961. New York, Plenum Press, 1964, p. 14-18.
- United Nations. Department of Economic and Social Affairs. New sources of energy and economic development.
Sales No.: 57.II.B.7
- United Nations. New sources of energy and energy development. Report of the United Nations Conference on New Sources of Energy.
Sales No.: 62.I.21
- United Nations. Solar energy I. (Proceedings, United Nations Conference on New Sources of Energy, v. 4).
Sales No.: 63.I.38
- United Nations. Solar energy II. (Proceedings, United Nations Conference on New Sources of Energy, v. 5).
Sales No.: 63.I.39
- United Nations. Solar energy III. (Proceedings, United Nations Conference on New Sources of Energy, v. 6).
Sales No.: 63.I.40
- United Nations. Water desalination in developing countries.
Sales No.: 64.II.B.5
- United Nations. Water desalination: Proposals for a costing procedure and related technical and economic considerations.
Sales No.: 65.II.B.5
- United Nations. Proceedings of the Interregional Seminar on the Economic Application of Water Desalination.
Sales No.: 66.II.B.30
- United Nations. First United Nations Desalination Plant Operation Survey
Sales No.: 69.II.B.17
- United Nations. Fresh water from geothermal fluids. Proceedings of the International Conference on Water for Peace, Washington, D.C., 23-31 May 1967, v. 3, p. 106.

ANNEXES

ANNEX I

ALTERNATIVE SOLAR-DISTILLATION PROCESSES

During the past two decades, a number of solar-distillation processes have been proposed. Some have been the subject of analysis and some of experiment. It is of interest to review briefly the status of some of these processes and the reasons that they are not being used (in contrast to several basin-type stills).

Figures 18-20 are diagrams of a group of distillation processes in which energy, in the form of heated air, heated water or power, is supplied from solar collectors to more or less conventional distillation equipment. This arrangement permits better energy economy through multiple-effect or related evaporation processes and reduces solar-collector area requirements. Most of these processes can be described as technologically feasible, but economically infeasible. The problems are twofold. First, energy cannot be delivered from the collectors to the stills as economically as it can be from conventional sources. Secondly, the intermittent and variable characteristics of the energy supply dictate that use factor on the distillation system is low (about one third) or that energy storage be provided. It will take a breakthrough in solar-collector and energy storage technology to permit the possibility of economic interest of these processes.

Figure 21 shows a type of device that has been intensively studied, a multi-stage vapour-pressure still (or multiple-effect diffusion still), in which the total pressure remains at an atmosphere but there are established temperature and partial pressure gradients from the hot side of the still to the cold side. a/ Both analytical and experimental studies have been made of these devices. Thus far, it appears that devices of this kind cost more per unit of output than the basin-type still, even though the latter are less effective users of energy than the multiple-effect device.

Many variations of the basin-type still have been proposed, two of which are shown in figures 22 and 23. The use of reflecting surfaces, as shown in figure 22, has been limited to the application of mirrors to the rear vertical surfaces of small units. While this enhances the output appreciably, these mirrors are costly and not very durable, hence the lack of prototype application.

Any discussion of the greenhouse type of unit would be incomplete without mention of the tilted-tray and wick-type units. The tilted-tray unit has the virtues of very small water depths and more nearly optimum orientation with

a/ R.V. Dunkle, "Solar water distillation: The roof-type still and a multiple effect diffusion still", International Developments in Heat Transfer, papers submitted to the International Heat Transfer Conference, 1961 (Denver, University of Colorado, 1961), part 5, pp. 895-902.

respect to incoming solar radiation and, hence, should show high efficiencies. One version of this type, shown in figure 24, has been made in small sizes only. These small units have performed well, but are expensive to construct and maintain. The tilted wick-type unit carries the water depth variation to an extreme approaching zero. The version shown in figure 25 was tested for some time at Daytona Beach. b/ Other experiments have been made in Italy c/ and the United States of America. b/ While these units behaved satisfactorily for a short time, it was extremely difficult to keep the wicks uniformly wet and without dry spots. There are no large installations of this kind.

An experimental solar-distillation plant using a multiple-effect humidification-dehumidification process was built in Sonora, Mexico. d/ This installation, which was designed to produce 3,000-5,000 gpd, consists of a multiple-stage humidifier-dehumidifier designed to operate twenty-four hours per day using hot water from a storage tank. This water is heated partly by solar energy and partly by heat collected from the condensate. As is indicated in figure 26, sea water enters the condenser at 78°F, is heated therein to 142°F and finally is heated to 150°F by passing through a solar heat collector. Thus, only about one ninth of the heat energy is derived from solar energy.

The solar collectors were double-glazed, with one piece of transparent plastic in contact with the water surface to prevent evaporation and a second plastic sheet held above the first by air inflation. Evaporation in the packed tower takes place due to humidification of air which is circulated through the packing by a blower in the bottom cross-connection between the condenser and the packed tower. The condenser consists of several tube bundles connected in series. Finned tubing is used to increase heat-transfer rates on the air side. Several pumps and blowers are needed to circulate the air and water through the system.

Difficulties with the plastic materials used for the solar-heat collectors, plus the installation of a 60-kw diesel engine in the vicinity, which can supply economical waste heat, have resulted in the abandonment of the solar collectors. Future solar operation of this cycle will be dependent upon solar-collector technology. The distiller portion of the plant is now in operation, using waste heat from the diesel engine; and the daily production rates achieved are as large as the maximum realized during the most sunny weather with 10,000 sq. ft. of solar-collector area.

b/ M. Telkes, "Flat tilted solar stills", Proceedings of the International Seminar on Solar and Aeolian Energy, Sunion, Greece, 1961 (New York, Plenum Press, 1964), pp. 14-18.

c/ G. Nebbia, Researches in the University of Bari (Italy), Coopération Méditerranéenne pour L'Energie Solaire Bulletin No. 5 (Marseilles, France, 1963), p. 26.

d/ C.N. Hodges et al., Solar Distillation Using Multiple-Effect Humidification, Office of Saline Water Research and Development Progress Report 194 (Washington, United States Department of the Interior, 1966).

Figure 18. Compression-distillation unit using electric energy from solar power plant

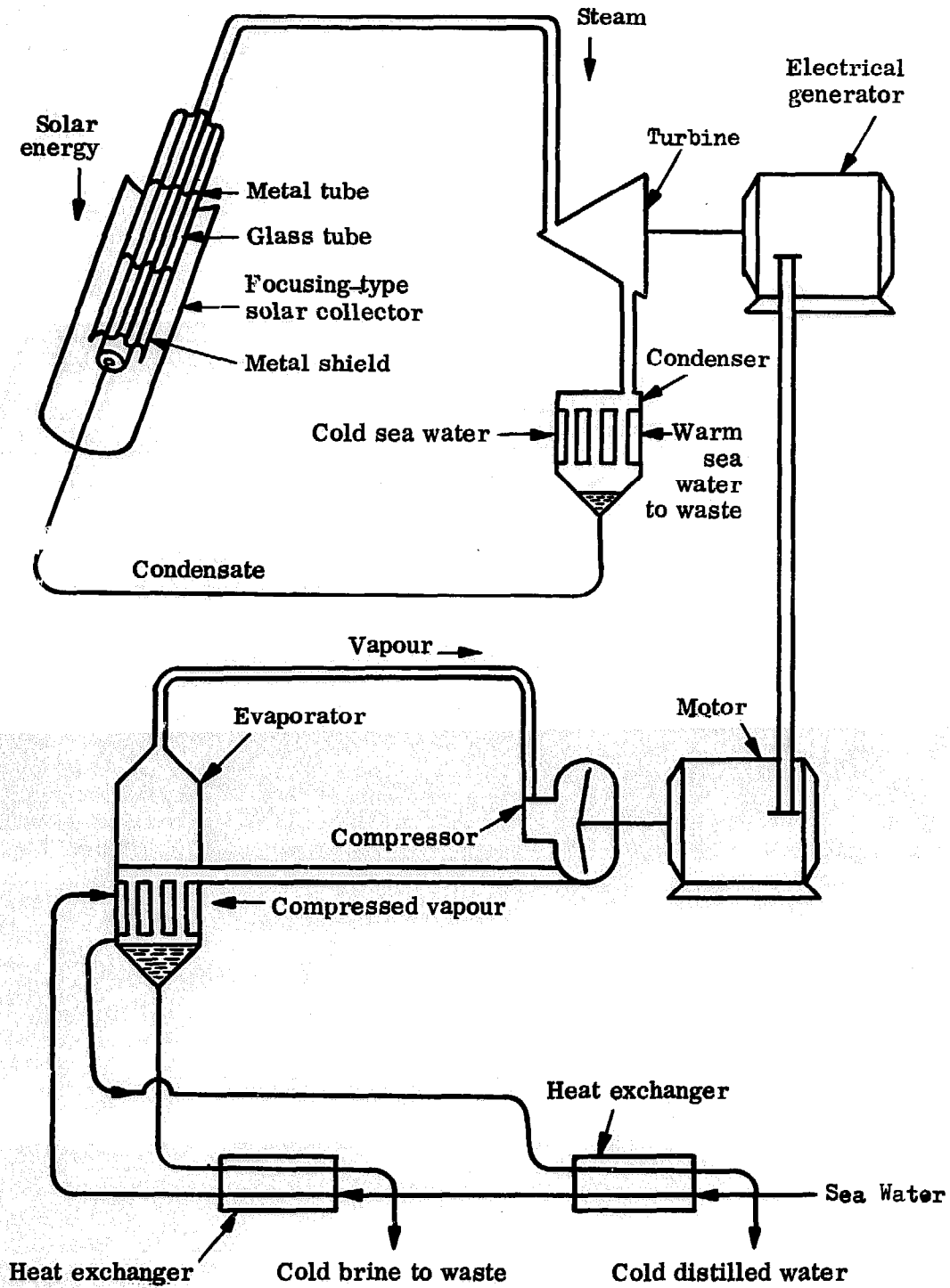

Source: J.W. Bloomer et al., "A practical basin-type solar still", Solar Energy (United States of America), No. 9, 1965, p. 197.

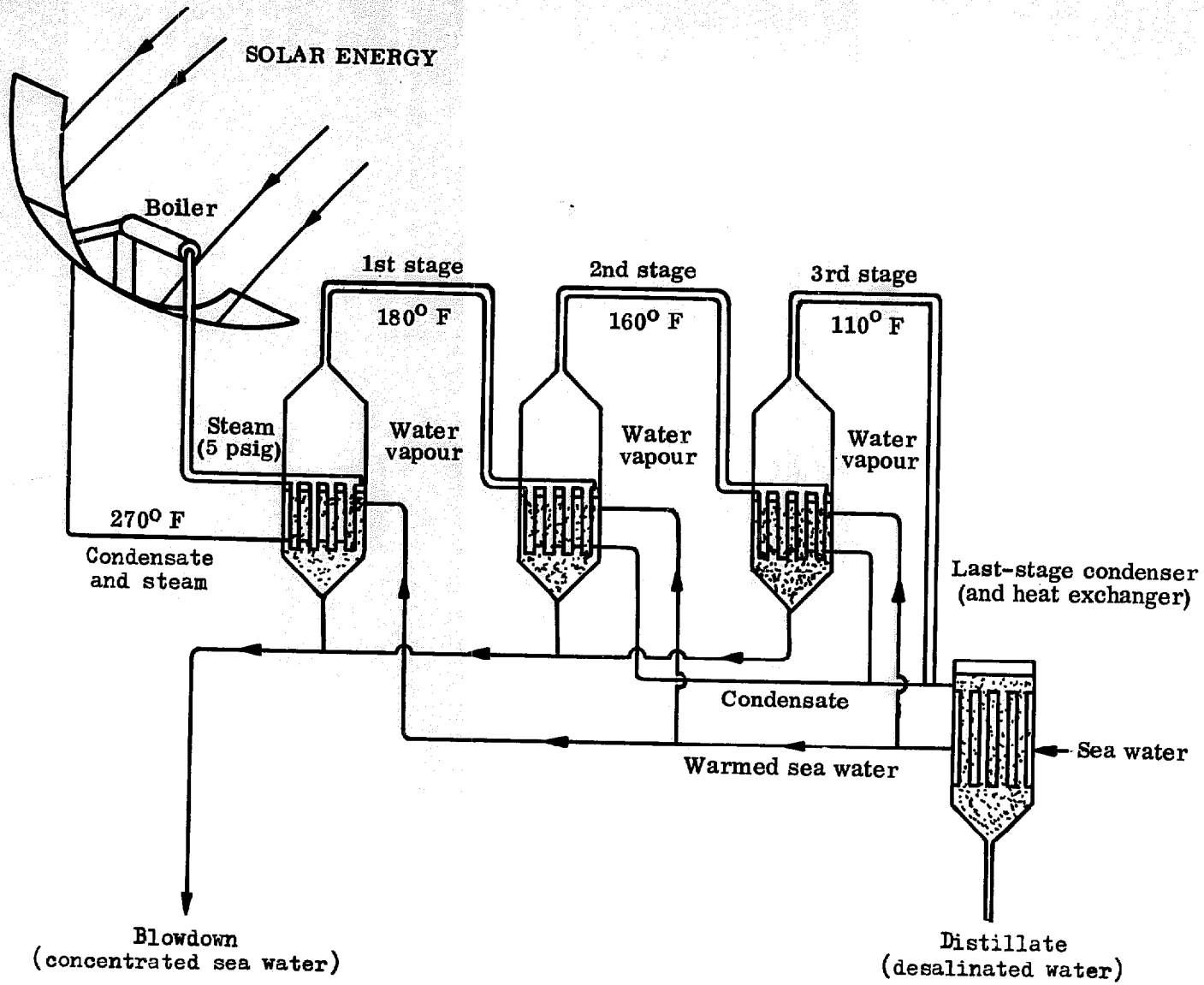

Figure 19. Multiple-effect evaporator heated by steam from focusing solar collector

Figure 20. Multiple-effect evaporator heated by steam from flat-plate collector

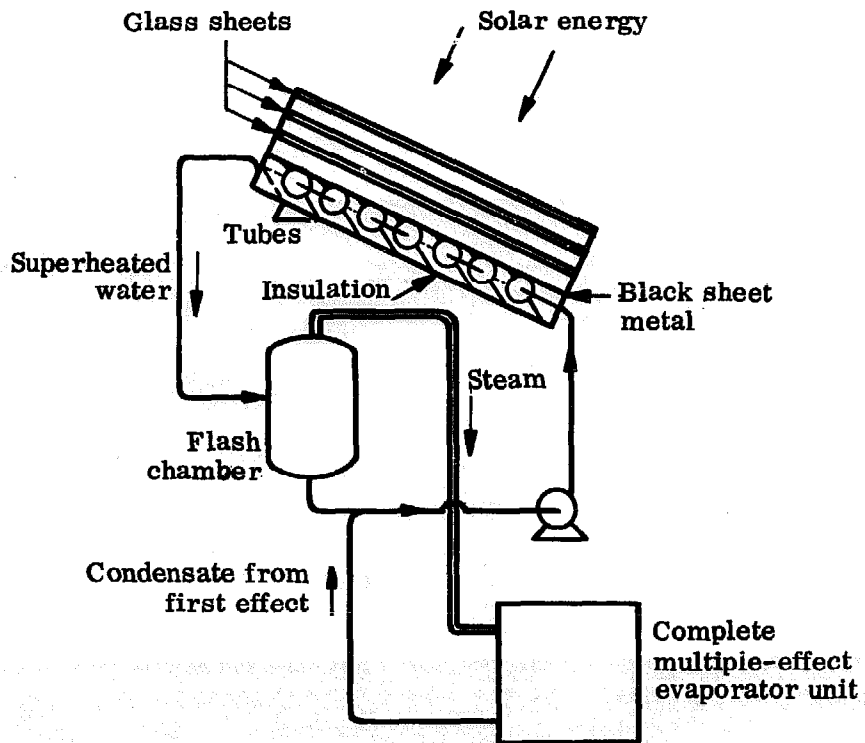

Figure 21. Multiple-effect solar still employing glass covers and copper condenser-evaporator plates

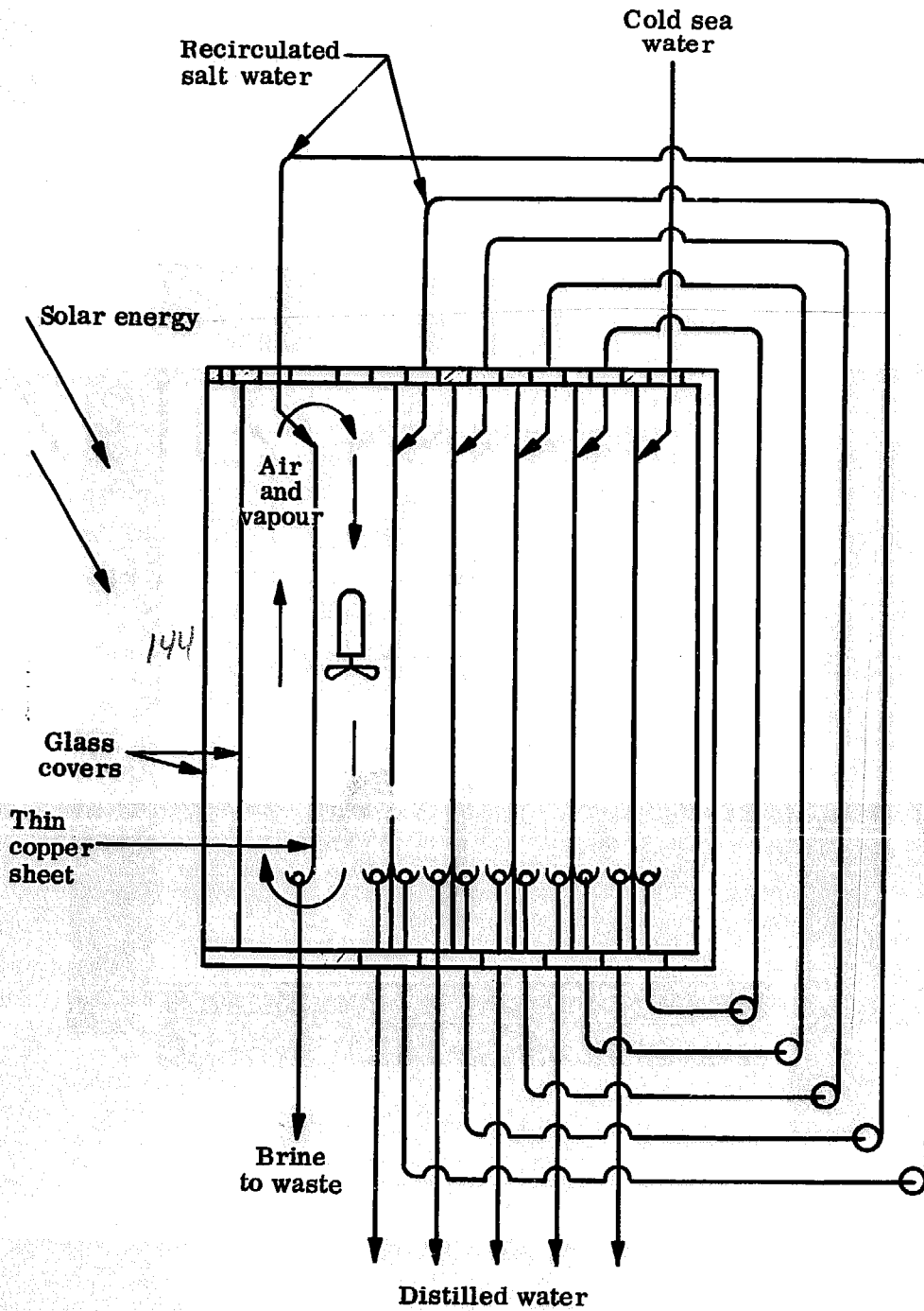

Figure 22. Glass-covered evaporating pan with reflecting surfaces

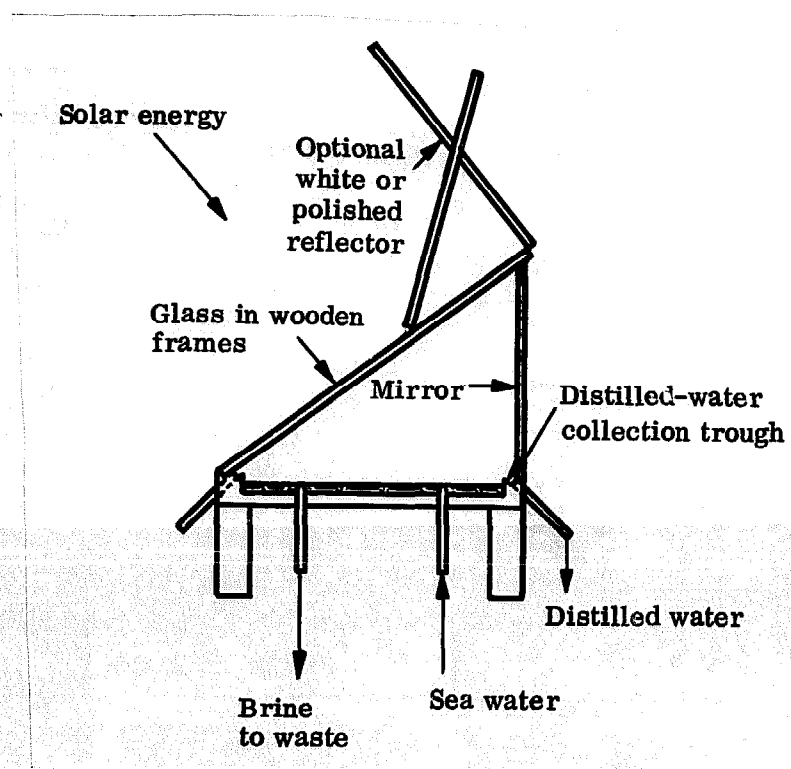

Figure 23. Extruded plastic still with blackwick for evaporation and cooling

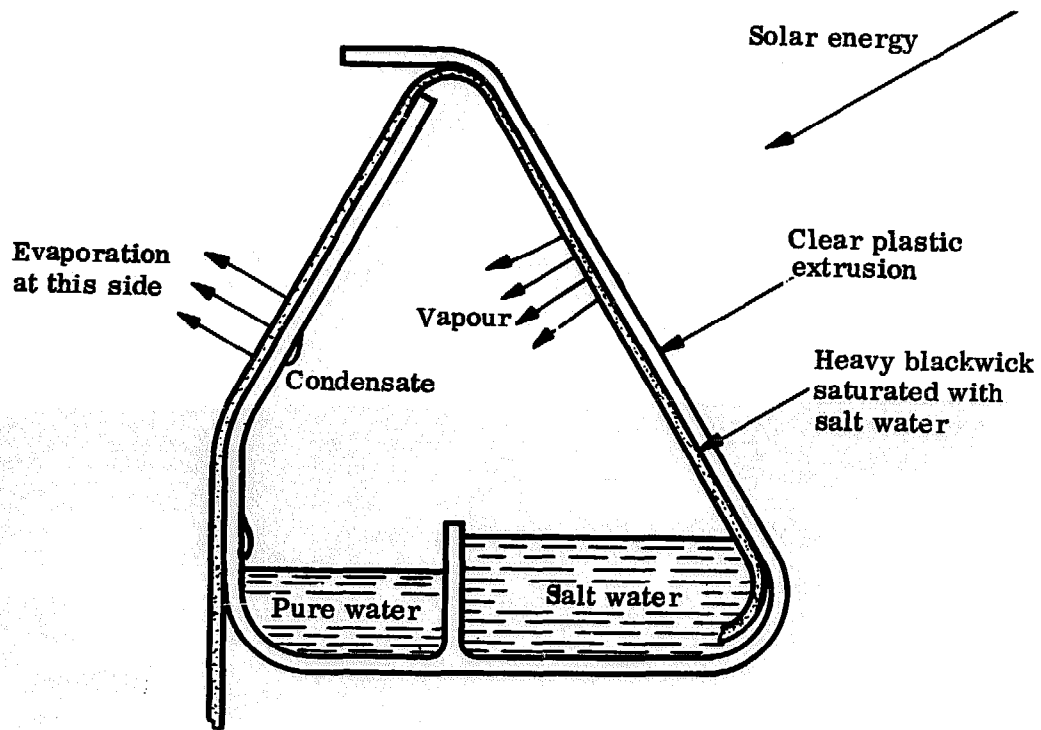
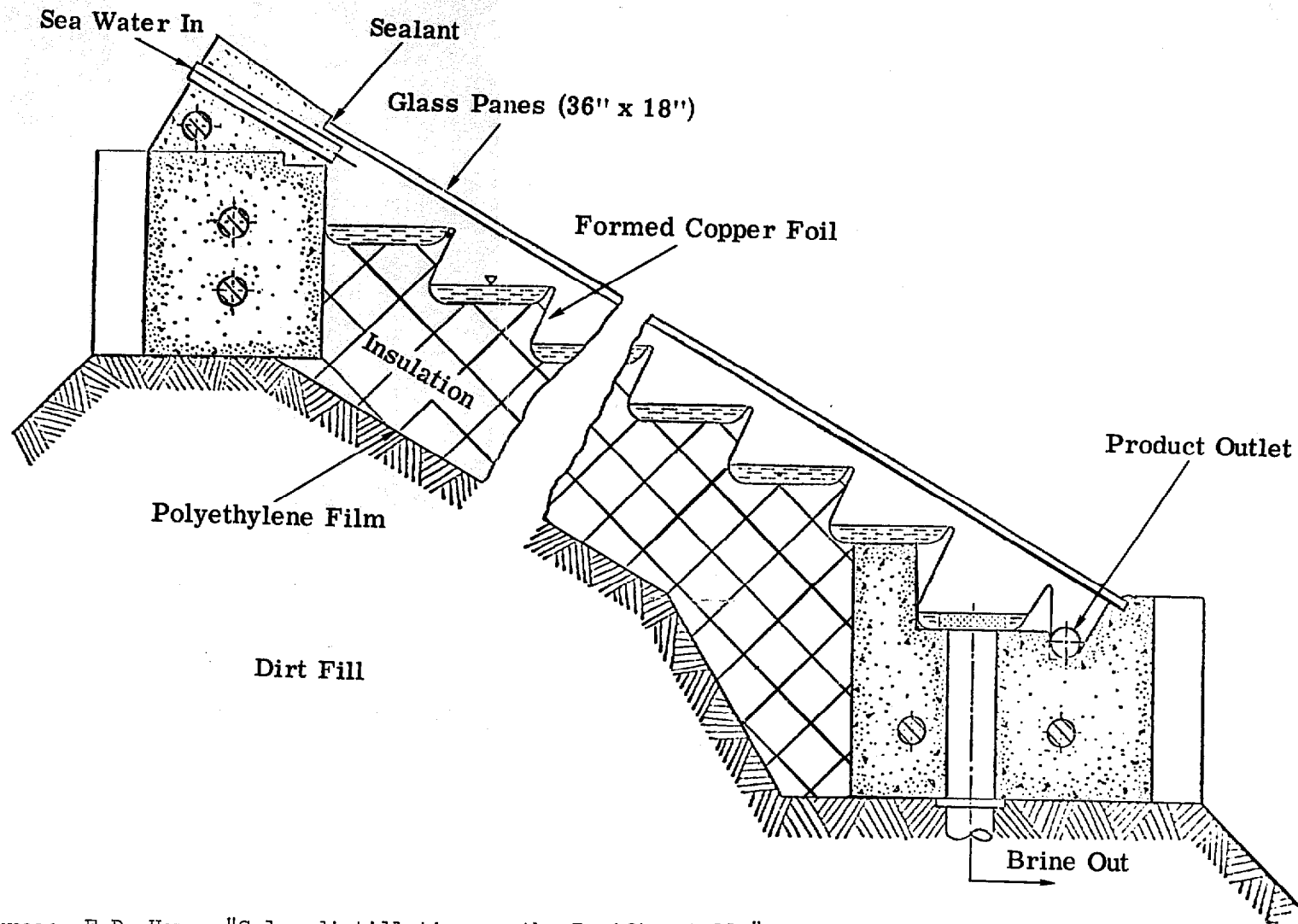
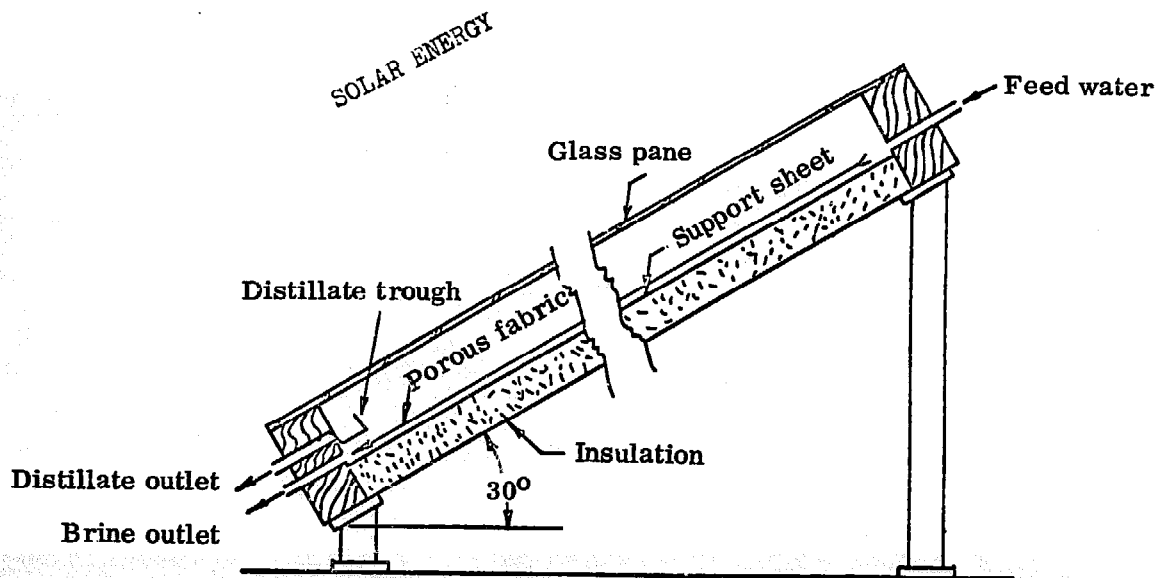

Figure 24. Tilted-tray solar still



Source: E.D. Howe, "Solar distillation on the Pacific atolls", South Pacific Bulletin (Sydney, Australia), April 1964.

Figure 25. Tilted wick-type solar still



Source: M. Telkes, "Flat tilted solar stills", Proceedings of the International Seminar on Solar and Aeolian Energy, Sunion, Greece, 1961 (New York, Plenum Press, 1964).

Figure 26. Experimental multiple-stage flash solar distiller,
Puerto Penasco, Sonora, Mexico

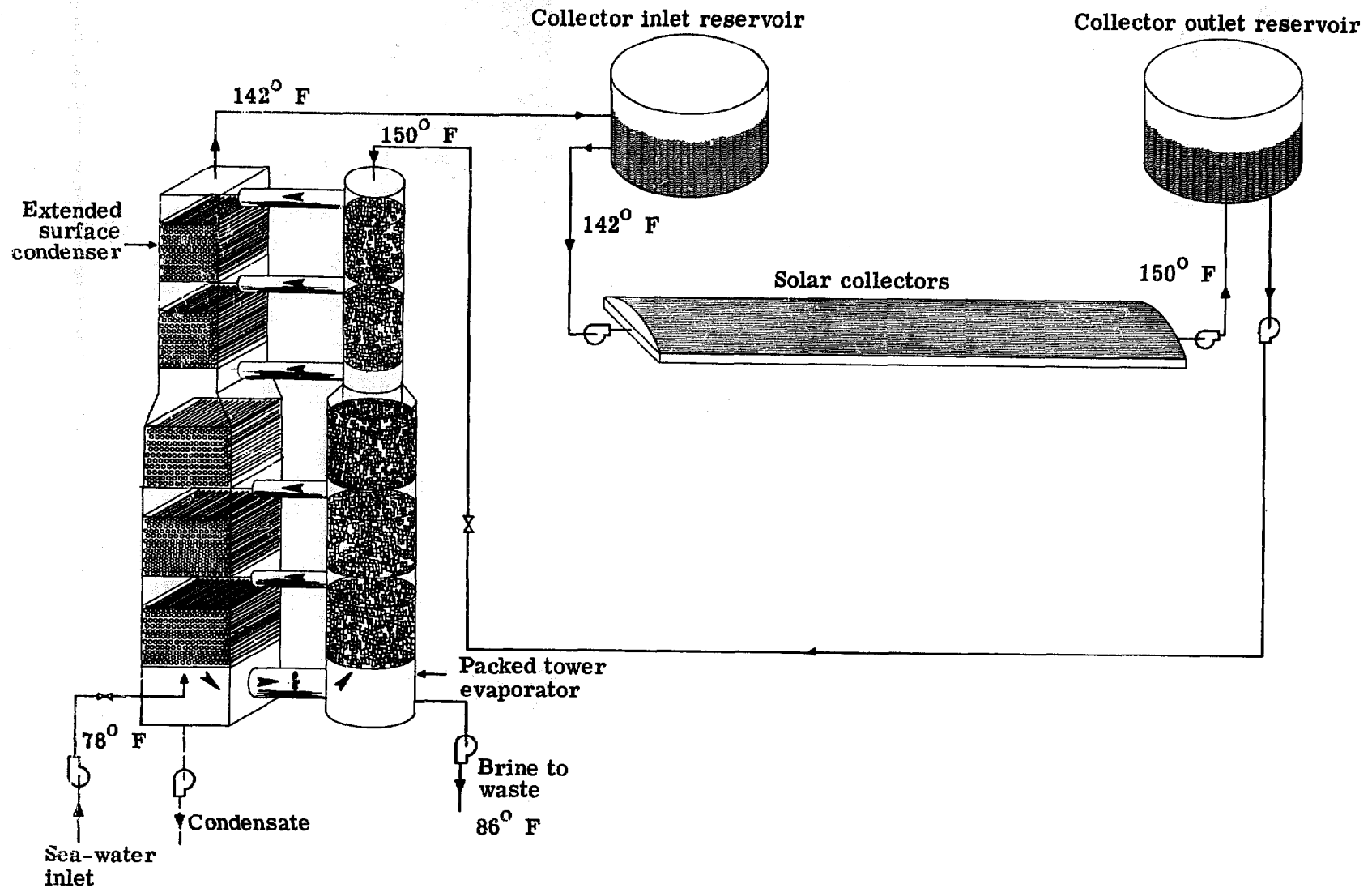

Source: C.N. Hodges et al., *Solar Distillation Using Multiple-Effect Humidification*, Office of Saline Water Research and Development Progress Report 194 (Washington, United States Department of the Interior, 1966).

ANNEX II

THE THEORY OF SOLAR-STILL OPERATION

The basic principles of operation of solar stills have been stated and developed a/ to the point where the numerical significance of the various parameters may be determined in relation to performance. The following has been adapted from the recent report by Morse and Read. b/

The heat and mass transfer relationships which govern the operation of a solar still in the steady state have been stated, c/ to which a term for thermal storage may be added to allow for changing conditions.

From figure 27 it will be seen that the energy input to the still comprises the radiation absorbed by the brine and trough system, $\alpha_w H_s$, plus that absorbed by the glass cover, $\alpha_g H_s$. d/ The heat transfer to the surroundings is via the cover, q_{ga} , and through the ground and edges, q_b . There is also a storage term, c_{wg} , which includes the effect of the ground under the still, the water and the structural members of the still itself.

This may be expressed as follows:

$$\alpha_g H_s + \alpha_w H_s = q_{ga} + q_b + c_{wg} \frac{dT}{dt} \quad (\text{Equation I})$$

- a/ G.O.G. Löf, J.A. Eibling and J.W. Bloemer, "Energy balances in solar distillers", Journal of the American Institute of Chemical Engineers, (New York), vol. 7, 1961, p. 641; V.A. Baum, "Solar distillers", Proceedings of the United Nations Conference on New Sources of Energy, vol. 6: Solar Energy III (United Nations publication, Sales No.: 63.I.40), p. 178; V. Baum and R. Bairamov, "Heat and mass transfer processes in solar stills of hot box type", Solar Energy (United States of America), vol. 8, 1964, p. 78; R.N. Morse and W.R.W. Read, "A rational basis for the engineering development of a solar still", Solar Energy (United States of America), vol. 12, 1968, pp. 5-17.
- b/ Morse and Read, op. cit.
- c/ R.V. Dunkle, "Solar water distillation: The roof-type still and a multiple effect diffusion still", International Developments in Heat Transfer, papers submitted to the International Heat Transfer Conference, 1961 (Denver, University of Colorado, 1961), part 5, pp. 895-902.
- d/ The nomenclature used in this annex may be found in the explanatory notes, p. viii.

Figure 27. Heat fluxes for a solar still

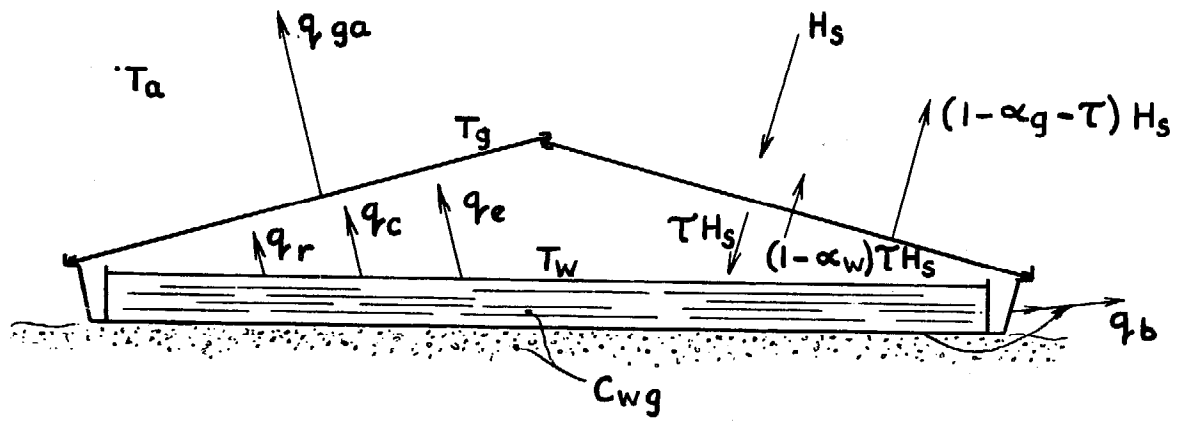

The heat transfer between the glass cover and the salt water is $q_r + q_c + q_e$, while the heat flow to the surroundings is the sum of these heat fluxes, plus the solar energy absorbed by the glass, or

$$q_{ga} = q_r + q_c + q_e + \tau_g H_s \quad (\text{Equation II})$$

and the heat loss from the still base to the surroundings is

$$q_b = k_b (T_w - T_a). \quad (\text{Equation III})$$

The expressions for q_r , q_c , and q_e are shown by Dunkle e/ to be

$$q_r = 0.9\sigma \left[(T_w + 460)^4 - (T_g + 460)^4 \right] \quad (\text{Equation IV})$$

$$q_c = 0.128 \left[T_w - T_g + \left(\frac{p_w - p_{wg}}{39 - p_w} \right) (T_w + 460) \right]^{1/3} (T_w - T_g). \quad (\text{Equation V})$$

$$q_e = 0.0254 \left[T_w - T_g + \left(\frac{p_w - p_{wg}}{39 - p_w} \right) (T_w + 460) \right]^{1/3} (p_w - p_{wg}) h_w. \quad (\text{Equation VI})$$

Finally, it is necessary to relate the heat dissipation from the cover to the ambient temperature, T_a . The long-wave radiation exchange may be taken as being between glass at temperature T_g , emittance 0.9 and a black body at $(T_u - 20)$. The convective heat-transfer coefficient, h_{ga} , is dependent on wind velocity, as follows:

Wind velocity (mph)	5	10	20
h_{ga} BTU hour ⁻¹ , sq. ft. ⁻¹ , °F ⁻¹	2.6	4.1	7.2.

Accordingly:

$$q_{ga} = 0.9\sigma (T_g + 460)^4 - (T_a + 440)^4 + h_{ga} (T_g - T_a). \quad (\text{Equation VII})$$

These seven equations cannot be solved explicitly, but a chart may be constructed from which graphical solutions can be obtained.

From equation VI, figure 28 may be drawn by plotting q_e against T_g for a number of values of T_w . For any point on a particular q_e curve, the value of $q_r + q_e$ may be calculated, so a second set of curves may be drawn through all values of q_e for which $(q_r + q_c) = 5, 10, 20$, etc.

From equation VII, figure 29 may be drawn by plotting q_{ga} against T_g for various values of T_a and for different wind velocities.

Now, by superimposing figures 28 and 29, figure 30 is obtained, by means of which equation II is solved for a known initial water temperature, insolation, ambient conditions and still characteristics.

e/ R.V. Dunkle, idem.

Figure 28. Evaporative heat transfer, q_e , versus cover temperature, T_g , for different values of brine temperature, T_w

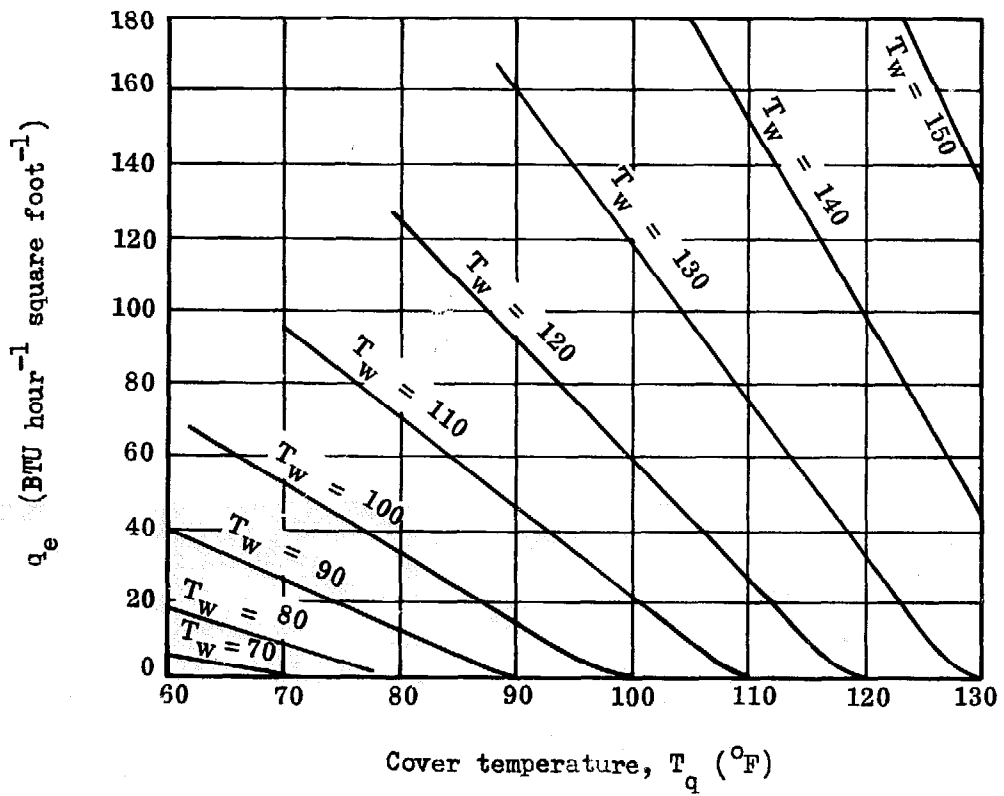

Figure 29. Cover heat loss, q_{ga} , versus cover temperature, T_g , for various values of ambient temperature, T_a , and wind velocity

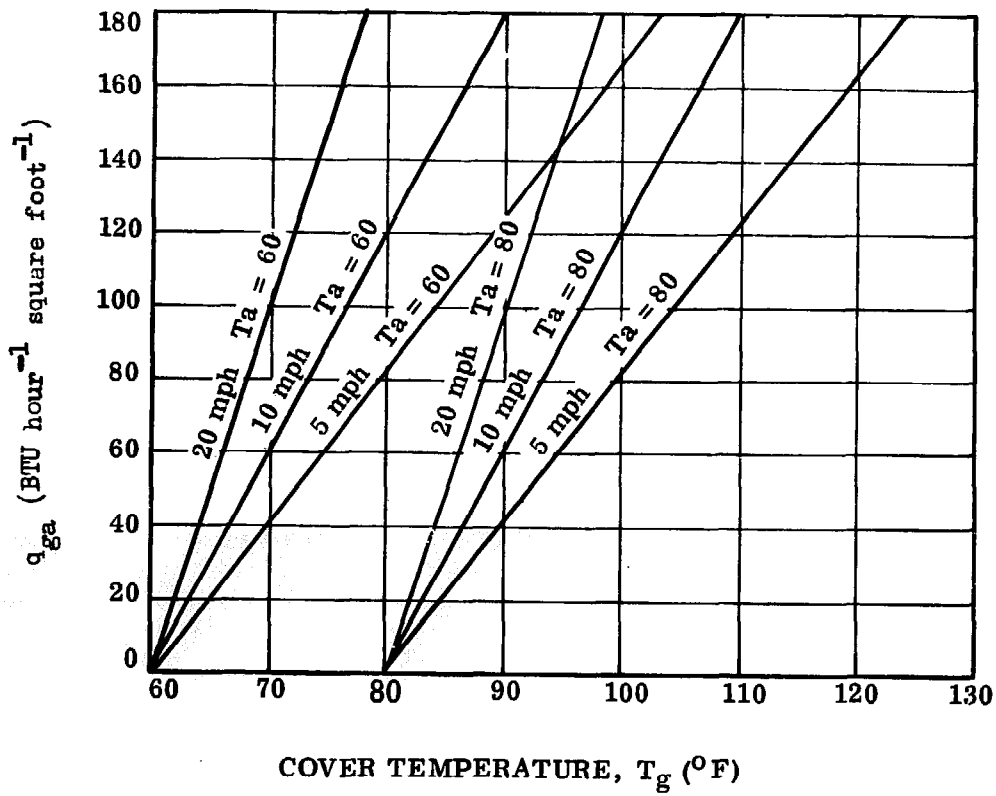
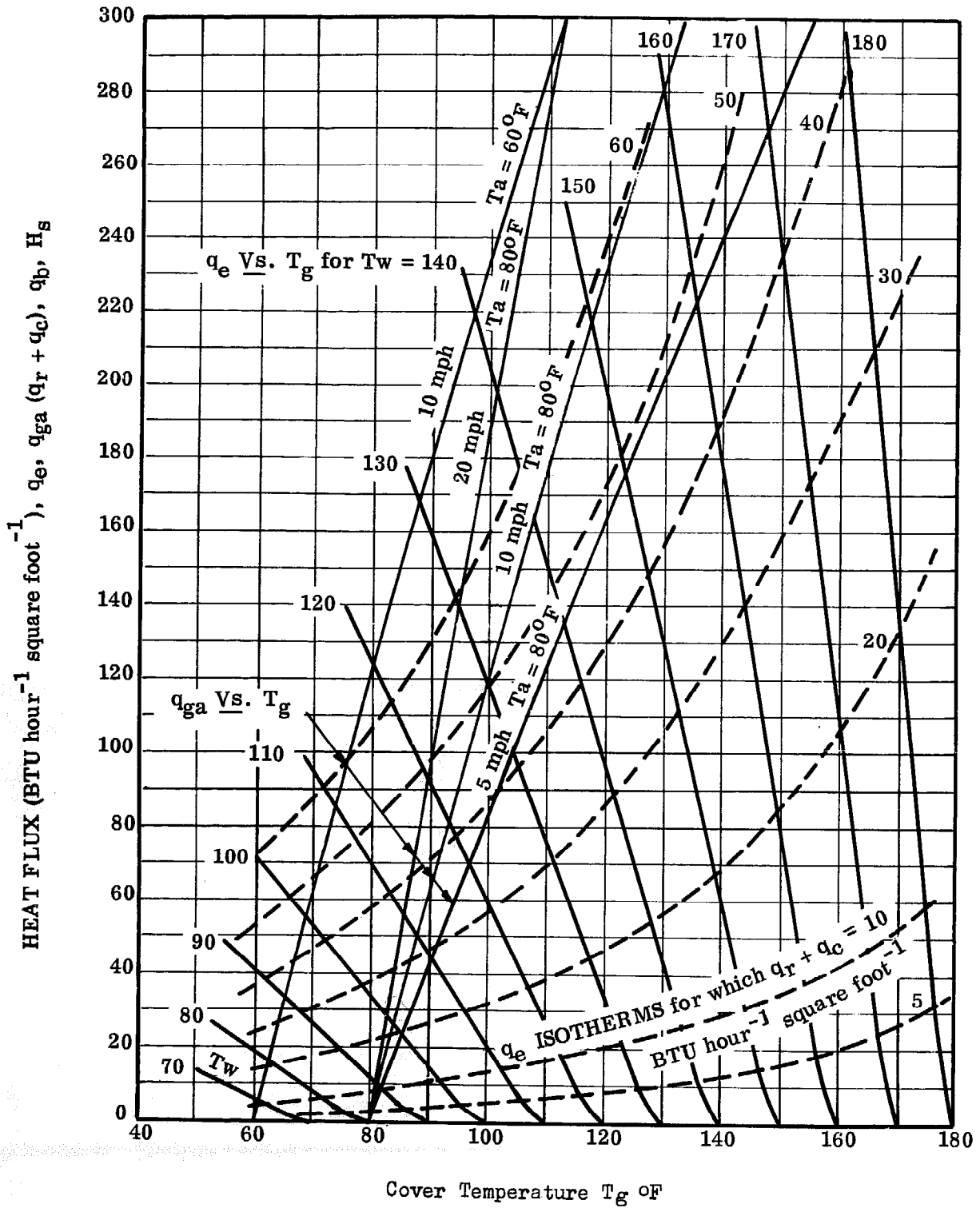

Figure 30. Characteristic chart for thermal performance of a solar still.



The method is best described by considering the following example:

$$C_{wg} = 16 \text{ BTU } ^\circ\text{F}^{-1}, \text{ sq. ft.}^{-1}$$

$$h_{ga} = 4.1 \text{ BTU hour}^{-1}, \text{ sq. ft.}^{-1}, ^\circ\text{F}^{-1}, \text{ corresponding to a wind velocity of } 10 \text{ mph}$$

$$h_w = 1020 \text{ BTU/lb}$$

$$k_b = 1.0 \text{ BTU hour}^{-1}, \text{ sq. ft.}^{-1}, ^\circ\text{F}^{-1}$$

$$T_a = 80^\circ\text{F}$$

$$c_g = 0.1$$

$$\tau = 0.8$$

$$\alpha_w = 0.9$$

$$\eta_o = 0.98$$

$$H_s = 31.1 \text{ BTU hour}^{-1}, \text{ sq. ft.}^{-1}$$

$$\text{Initial } T_w = 120^\circ\text{F}$$

The output of the still is q_c and is found by determining the operating point P_o - such that the length of the vertical intercept $P_o Q_o$ ($\text{BTU hour}^{-1}, \text{ sq. ft.}^{-1}$)

$$= 0.1 H_s + q_r + q_c$$

$$= 31 + (q_r + q_c).$$

The value of $(q_r + q_c)$ is read off the broken curves by interpolation if necessary, and the position of the line $P_o Q_o$ moved until the above relationship is satisfied. This is a graphical solution of Eq. (2) and determines the value of T_g .

One then has

$$q_c = 59 \text{ BTU hour}^{-1}, \text{ sq. ft.}^{-1}$$

$$(q_r + q_c) = 30$$

$$q_{ga} = 120 \text{ BTU hour}^{-1}, \text{ sq. ft.}^{-1}$$

Whence, from equation I

$$C_{wg} \frac{dT_w}{dt} = (c_g + c_w \tau) H_s - q_{ga} - q_b$$

$$16 \frac{dT_w}{dt} = 255 - 120 - 40$$

$$= 95$$

$$\frac{dT_w}{dt} = 5.9^\circ\text{F/hr}$$

After an interval of one hour the new water temperature T_w will be 125.9°F . and the process is repeated for a new value of H_g and using a line drawn by interpolation between $T_w = 120$ and $T_w = 130$.

In this way, the daily output of a solar still for a specified insolation pattern may be determined as shown in table 5. The initial water temperature is chosen so that at the end of the twenty-four-hour period it has returned to approximately the same value. When converting from q_e (BTU hour^{-1} , sq. ft.^{-1}) to output (lb/sq. ft.) it is necessary to correct for the nominal area of the still, which is usually different from the water area. For the stills now in operation at this laboratory, the ratio of water to glass area is 0.89. The daily output then becomes

$$0.89 \frac{\eta_o}{h_w} \int_0^{24} q_e dt \text{ lb/sq.ft.}$$

related to plan of glass. The term η_o is introduced to allow for the fact that all the water condensed on the cover may not be collected.

Table 5. Estimate of hourly output (q_e) of solar still, using characteristic chart
(Insolation = 2,555 BTU sq. ft.⁻¹, day⁻¹)

Time	6	7	8	9	10	11	Noon	13	14	15	16	17	18	19	20	21	22	23	M.N.	1	2	3	4	5	
H_s	28	111	184	236	280	318	324	311	262	233	133	86	43	5	0	0	0	0	0	0	0	0	0	0	0
T_w	85	85.5	90	96.8	104.8	113.2	121.5	127.8	131.4	131.8	130.3	124.6	118.3	111.9	105.2	100.4	96.6	93.4	91.1	89.2	87.6	86.2	85.2	84.5	
$0.1H_s$	3	11	18	24	28	32	31	32	26	23	13	8	4	0.5	0	0	0	0	0	0	0	0	0	0	0
$q_r + q_c$	5	5	7	12	18	24	31	36	38	40	40	37	33	30	23	19	16	12	11	9	8	6	5	3	
q_e	3	4	6	12	25	40	61	82	93	100	97	82	63	48	30	21	17	12	9	7	7	5	3	2	
q_{ga}	11	20	31	48	71	96	124	149	157	163	150	127	100	79	53	40	33	24	20	16	15	11	8	5	
q_b	5	6	10	17	25	33	41	48	51	52	50	45	38	32	25	20	17	13	11	9	8	6	5	5	
$0.05H_s$	2.2	9	15	19	22	26	26	25	21	19	11	7	4	0	0	0	0	0	0	0	0	0	0	0	0
Sub-total	18	35	56	84	118	155	191	222	229	234	211	179	142	111	78	60	50	37	31	25	23	17	13	10	
$0.9H_s$	25	100	166	212	252	286	292	280	236	210	120	78	39	4	0	0	0	0	0	0	0	0	0	0	0
Δq	7	65	110	128	134	131	101	58	7	-24	-91	-101	-103	-107	-78	-60	-50	-37	-31	-25	-23	-17	-13	-10	
ΔT	0.5	4.1	6.8	8	8.4	8.3	6.3	3.6	0.4	-1.5	-5.7	-6.3	-6.4	-6.7	-4.8	-3.8	-3.2	-2.3	-1.9	-1.6	-1.4	-1	-0.7	-0.6	

Note: Total q_e = 829 BTU day⁻¹, sq. ft.⁻¹; Daily output = 829 x 0.98/1020 x 0.89 = 0.71 lb/sq. ft.

ANNEX III

WATER STORAGE REQUIREMENTS AND COSTS FOR A
SOLAR-STILL INSTALLATION

The example given here is based on the predicted output of a still 100 times larger than that considered in table 3, but otherwise similar (i.e., a still with an area of 100,000 sq. ft.). The average output of the still over the year is 6,700 gpd.

Shown here is an estimate of the storage capacity required, assuming the water need is constant at 6,700 gpd. Thus, excess summertime capacity is to be stored for wintertime use. One hundred per cent recovery of stored water is assumed. No rainfall is included.

Column 2 of table 6 shows the average daily production, by month. Column 3 shows excess (+) or deficiency (-) of average daily production, in relation to daily needs. Column 4 shows the sums of the excesses or deficiencies in average daily production.

Table 6. Estimate of solar-still output and storage requirements

1 Month	2 Average daily output (gallons)	3 Monthly excesses (+) or deficiency (-)	4 Sum of excesses or deficiencies
April	8,300	+1,600	
May	9,500	+2,800	
June	10,300	+3,600	
July	10,100	+3,400	
August	8,900	+2,200	
September	7,600	+ 900	+14,500
October	5,300	-1,400	
November	3,200	-3,500	
December	2,700	-4,000	
January	2,900	-3,800	
February	4,300	-2,400	
March	6,600	- 700	-14,500

From April through September, the months of excess capacity, a total estimated excess (at thirty days per month) is $30 \times 14,500 = 435,000$ gallons of storage capacity.

If this excess is stored for use during the months of deficiency, October through March, the still production plus water from storage will just meet the constant average water need of 6,700 gpd.

Thus, a storage capacity of approximately 435,000 gallons, or approximately 65 days nominal capacity, is required.

The cost of the solar still, at \$1/sq. ft., is \$100,000.

The cost of the tank, assuming a horizontal steel tank of 435,000 gallons capacity at \$0.03 per gallon of capacity, is \$13,100.

Thus, the increase in investment due to tank requirements is 13.2 per cent.

Assuming the annual total cost of 10 per cent of still cost, for both still and storage system, for the annual output of 2,450,000 gallons ($365 \times 6,700$), the cost without storage is \$4.08 per 1,000 gallons; and the cost with storage is \$4.62 per 1,000 gallons.

This example, which shows a 13 per cent increase in costs due to storage requirements, is based on a "conservatively high" and long-term storage requirement. (It is of interest to note that a source of water available at less than \$4.62 per 1,000 gallons would admit the possibility of use of the supplementary supply, less storage of solar-distilled water, and possibly a smaller still.)

HOW TO OBTAIN UNITED NATIONS PUBLICATIONS

United Nations publications may be obtained from bookstores and distributors throughout the world. Consult your bookstore or write to: United Nations, Sales Section, New York or Geneva.

COMMENT SE PROCURER LES PUBLICATIONS DES NATIONS UNIES

Les publications des Nations Unies sont en vente dans les librairies et les agences dépositaires du monde entier. Informez-vous auprès de votre librairie ou adressez-vous à: Nations Unies, Section des ventes, New York ou Genève.

COMO CONSEGUIR PUBLICACIONES DE LAS NACIONES UNIDAS

Las publicaciones de las Naciones Unidas están en venta en librerías y casas distribuidoras en todas partes del mundo. Consulte a su librero o diríjase a: Naciones Unidas, Sección de Ventas, Nueva York o Ginebra.