

AT MICROFICHE REFERENCE LIBRARY

A project of Volunteers in Asia

Small Community Water Supplies
Technical Paper No. 13

Edited by: E.H. Hofkes

Published by:

WHO International Reference Centre for
Community Water Supply
P.O. Box 5500
2280 HM Rijswijk
The Hague
The Netherlands

Paper copies are free to serious groups.

Available from:

WHO International Reference Centre for
Community Water Supply
P.O. Box 5500
2280 HM Rijswijk
The Hague
The Netherlands

Reproduced by permission of the WHO International
Reference Centre for Community Water Supply.

Reproduction of this microfiche document in any
form is subject to the same restrictions as those
of the original document.

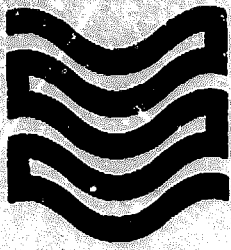

August 1981

Small Community Water Supplies

18

Technical Paper Series

The International Reference Centre for Community Water Supply and Sanitation (IRC) originates from an agreement between the World Health Organization and the Netherlands' Government. The general objective of the IRC is to underpin information and technology support in developing countries in the field of community water supply and sanitation, and to promote international cooperation therein. Acting as a catalyst, the IRC operates through a worldwide network of regional and national institutions, as well as with international agencies, bilateral donors, non-governmental organizations and individuals.

Requests for information or inquiries on specific subjects may be directed to the I.R.C., P.O. Box 5500, 2280 HM Rijswijk, The Netherlands.

**International Reference Centre
for Community Water Supply
and Sanitation**

Small Community Water Supplies

Technology of Small Water Supply Systems in Developing Countries

Prepared with contributions from and under the joint supervision of

L. Huisman

**Professor of Sanitary Engineering
Delft University of Technology
Netherlands**

J.M. De Azevedo Netto

**Professor of Sanitary Engineering
University of Sao Paulo
Brazil**

B.B. Sundaresan

**Director, National Environmental Engineering
Research Institute
India**

J.N. Lanoix

**Formerly: Division of Environmental Health
World Health Organization
Geneve**

Compiled and edited by:

E.H. Hofkes

**International Reference Centre for
Community Water Supply and Sanitation
The Hague**

**Technical paper 18
august 1981**

abstract

Small Community Water Supplies, August 1981

A handbook/source document on technology of small community water supply systems. Subjects: planning and management of small water systems, drinking water quantity and quality, water sources, rain-water harvesting, springwater tapping, groundwater withdrawal, surface water intake, artificial recharge, pumping, water treatment (general), aeration of water, coagulation and flocculation, sedimentation, slow sand filtration, rapid filtration, disinfection of water, water transmission, and water distribution.

Selected references added to each chapter.

Annexes provide information on: sanitary survey, well drilling methods, experimental studies for water treatment plant design, chemicals used in water treatment, and conversion of measurement units.

378 pages; 244 figures; 24 tables

(c) Copyright 1981

International Reference Centre for
Community Water Supply and Sanitation
P.O. Box 5500, 2280 HM Rijswijk (The Hague)
The Netherlands

Permission to reproduce material from this handbook may be granted on request.

This handbook is issued on the responsibility of the International Reference Centre for Community Water Supply and Sanitation. It does not necessarily reflect the views or policies of the World Health Organization.

contents

	<u>Page</u>
PREFACE	
1. INTRODUCTION	
1.1. Water and Human Health	9
1.2. Water Supply and Development	13
1.3. Small Community Water Supplies in Developing Countries	14
2. PLANNING AND MANAGEMENT	
2.1. Planning	19
2.2. Management and Supervision	24
2.3. Manpower and Training	26
2.4. Community Involvement	28
2.5. Maintenance	32
2.6. Emergency Operation	35
3. WATER QUANTITY AND QUALITY	
3.1. Water Use and Consumption	36
3.2. Water Quality	42
4. WATER SOURCES	
4.1. Water Occurrence and Hydrology	51
4.2. Quality of Water Sources	53
4.3. Water Source Selection	55
5. RAINWATER HARVESTING	
5.1. Rainwater as a Source of Water Supply	59
5.2. Roof Catchments	60
5.3. Ground Catchments	63
5.4. Storage	65
5.5. Water Quality Preservation	70
6. SPRINGWATER TAPPING	
6.1. Introduction	75
6.2. Basic Considerations	79
6.3. Tapping Gravity Springs	80
6.4. Tapping Artesian Springs	84
7. GROUNDWATER WITHDRAWAL	
7.1. Introduction	91
7.2. Groundwater Occurrence and Prospecting	92
7.3. Methods of Groundwater Withdrawal	100
7.4. Infiltration Galleries	106
7.5. Dug Wells	109
7.6. Tube Wells	121
8. SURFACE WATER INTAKE	
8.1. River Water Intake	137
8.2. Lake Water Intake	140
8.3. Typical Intake Constructions	142
8.4. Small Dams and Village Ponds	144
8.5. Screens	145

9.	ARTIFICIAL RECHARGE	
9.1.	Introduction	149
9.2	Bank Infiltration	150
9.3	Water Spreading	155
9.4	Sand Dams	159
10.	PUMPING	
10.1	Introduction	163
10.2	Power Sources for Pumping	163
10.3	Types of Pumps	167
10.4	Reciprocating Pumps	170
10.5	Rotary (positive displacement) Pumps	175
10.6	Axial-Flow Pumps	177
10.7	Centrifugal Pumps	178
10.8	Pump Drive Arrangements	179
10.9	Air-Lift Pumps	183
10.10	Hydraulic Ram	185
11.	WATER TREATMENT	
11.1	Introduction	191
11.2	Groundwater Quality and Treatment	194
11.3	Surface Water Quality and Treatment	195
12.	AERATION	
12.1	Introduction	201
12.2	Waterfall Aerators	202
12.3	Bubble Aerators	208
13.	COAGULATION AND FLOCCULATION	
13.1	Introduction	213
13.2	Coagulants	214
13.3	Rapid Mixing	217
13.4	Flocculation	220
13.5	Hydraulic Flocculators	222
14.	SEDIMENTATION	
14.1	Introduction	229
14.2	Settling Tank Design	230
14.3	Construction	233
14.4	Plate and Tube Settlers	237
15.	SLOW SAND FILTRATION	
15.1	Introduction	245
15.2	Theory of Slow Sand Filtration	247
15.3	Principles of Operation	250
15.4	Design Considerations	253
15.5	Construction	255
15.6	Cleaning	261

16.	RAPID FILTRATION	
16.1	Introduction	269
16.2	Theoretical Aspects	274
16.3	Rapid Filter Operation and Control	275
16.4	Design Considerations	281
16.5	Construction	290
16.6	Village-Scale Rapid Filtration	293
16.7	Roughing Filtration	295
17.	DISINFECTION	
17.1	Introduction	299
17.2	Physical Disinfection	299
17.3	Chemical Disinfectants	300
17.4	Chlorination	301
17.5	Chlorination Technology for Rural Water Supply	304
17.6	Disinfection using Chlorine Gas	309
17.7	Disinfection of New Tanks, Pipes and Wells	311
17.8	Disinfection of Water Supply in Emergency Situations	312
18.	WATER TRANSMISSION	
18.1	Introduction	317
18.2	Types of Water Conduits	317
18.3	Design Considerations	320
18.4	Hydraulic Design	322
18.5	Water Transmission by Pumping	324
18.6	Pipe Materials	332
19.	WATER DISTRIBUTION	
19.1	Introduction	339
19.2	Types of Distribution Systems	339
19.3	Design Considerations	347
19.4	Distribution System Design	356
19.5	Pipe Materials	359

ANNEXES

1. Sanitary Survey
2. Well Drilling
3. Experimental Studies for Water Treatment Plant Design
4. Chemicals Used In Water Treatment
5. Measurement Units Conversion

preface

The United Nations has designated the period 1981 - 1990 the International Drinking Water Supply and Sanitation Decade. Many hope and trust that there will be vastly increased efforts to provide adequate water supply and sanitation services to all those needing them.

The needs are enormous. Hundreds of millions of people living in developing countries lack reasonable access to an adequate supply of safe drinking water. The problems are particularly acute for countless small communities in the rural areas, as well as for urban fringe areas. Their water supply situation often is grossly inadequate.

In providing water supply systems to small communities, factors such as organization, administration, community involvement and finance are frequently the major constraints, rather than technical considerations. However, the selection of suitable technology remains important since other problems are compounded when techniques, methods and equipment are used that are not compatible with the conditions and situations of small communities.

It is a misconception to regard small community water supply systems as 'scaled down' versions of urban installations requiring less engineering skill or ingenuity. The exact opposite may be the case. Simplicity and smallness should not be regarded as backward or second-rate, but rather as appropriate for the purpose. Technologies must be selected that can be integrated with the approach of community involvement which is so essential in small-scale schemes. Misapplication of technologies is likely when the designer does not clearly understand the basic assumptions implicit in them. This usually will result in costly overdesigns and unrealistic manpower, operation and maintenance requirements.

This handbook has been designed to provide a broad introduction into the technology of small community water supplies. It provides information and guidance that should be most readily used by those having some technical background in civil engineering, public health or irrigation, but with no formal training or experience in water supply. It should serve engineers and public health inspectors who are called upon to assume responsibility for the design and/or maintenance of small water supply systems. This group also includes provincial and town engineers who have responsibility for water supply and sanitation, amongst many other tasks. The book, therefore, has not been written as a textbook for engineering students nor as a design manual addressed to technicians. Some theoretical explanations have been included but such material has been kept to a minimum. For in-depth information reference is made to monographs and textbooks.

acknowledgement

This handbook has been compiled and further developed from the contributions of many.

The main contributions have been made by a group of authors who each supplied selected chapters, and who collectively supervised the preparation of the handbook. These authors are Prof. L. Huisman (Netherlands), Prof. J.M. de Azevedo Netto (Brazil), Dr. B.B. Sundaresan (India) and Dr. J.N. Lanoix (WHO, Geneva).

Further, we are indebted to Messrs. L.G. Hutton and W. Moffat (WEDC Group, Loughborough University of Technology, England) for the material they supplied on groundwater occurrence and prospecting, and to Mr. P.K. Cruse (George Stow & Co. Ltd., Water Well Engineers, Henley-on-Thames, England) who prepared the section on well drilling methods. Mr. R. Trietsch (DHV Consulting Engineers, Amersfoort, Netherlands) assisted by preparing from earlier assembled materials a preliminary draft for the chapters on water transmission and distribution. Dr. B.C.J. Zoeteman (National Institute for Water Supply, Netherlands) advised on the presentation of water quality and health aspects, and the guidelines for drinking water quality.

Grateful mention is made of those who helped by reviewing the draft manuscript; their comments were invaluable as a basis for corrections and improvements. We feel the following persons should be specially mentioned: Dr. G. Bachmann (WHO, Geneva), Mr. Edwin Lee (WHO-WPRO, Manila), Mr. D.V. Subrahmanyam (WHO-SEARO, New Delhi), Mr. David Donaldson (PAHO, Washington), Mr. F.E. McJunkin (US AID, Washington), and Mr. T.K. Tjiok (IRC, The Hague).

In compiling and editing the various contributions, and in processing the numerous comments made to the subsequent drafts, Mr. E.H. Hofkes (IRC, The Hague) found himself charged with the task of integrating, re-organising, revising and, in several instances, completely rewriting sections and even complete chapters.

In the editing of the material, Mr. G. Bedard provided important assistance. Ms. Hannie Wolsink did an outstanding job of extensive text processing and administrative coordination without which the preparation of the handbook would not have been possible.

The present document is likely to require revision at a future stage. It is intended to undertake that work when appropriate.

Comments and suggestions from readers for changes, corrections or additions will be most welcome. These will be gratefully used in the future revision of the handbook, and will be duly acknowledged therein. Communications should be directed to: IRC, P.O. Box 5500, 2280 HM Rijswijk (The Hague), Netherlands.

1. introduction

1.1. Water supply and human health

Water is essential to man, animals and plants and without water life on earth would not exist. From the very beginning of human civilization, people have settled close to water sources, along rivers, besides lakes or near natural springs. Indeed where people live, some water is normally available for drinking, domestic use, and possibly for watering animals. This does not imply, however, that the available source of water is convenient and of sufficient capacity, nor that the water is safe and wholesome. On the contrary, in many countries people live in areas where water is scarce. Often it has to be carried over long distances, particularly during dry periods. Scarcity of water may also lead people to use sources that are contaminated by human or animal faeces, and are thus dangerous to human health.

A few litres of water each day are sufficient for a person's basic drinking and food preparation requirements, depending on climate and lifestyle. Much larger quantities are necessary when water is used for other purposes such as personal hygiene, cleansing of cooking utensils, laundry and house cleaning. Safe, adequate and accessible supplies of water, combined with proper sanitation, are surely basic needs and essential components of primary health care. They can help reduce many of the diseases affecting underprivileged populations, especially those who live in rural and urban fringe areas.

Safe drinking water is important in the control of many diseases. This is particularly well-established for diseases such as diarrhoea, cholera, typhoid and paratyphoid fever, infectious hepatitis, amoebic and bacillary dysentery. It has been estimated that as many as 80 percent of all diseases in the world are associated with unsafe water. This association can take a number of different forms, and diseases may be grouped accordingly (Table 1.1).

Table 1.1.
Diseases related to deficiencies in water supply and/or sanitation

GROUP	DISEASES
<ul style="list-style-type: none"> Diseases transmitted by water (water-borne diseases) Water acts only as a passive vehicle for the infecting agent. All of these diseases depend also on poor sanitation. 	<ul style="list-style-type: none"> Cholera Typhoid Bacillary dysentery Infectious hepatitis Leptospirosis Giardiasis Gastro enteritis
<ul style="list-style-type: none"> Diseases due to lack of water (water-washed diseases) Lack of adequate quantity of water and poor personal hygiene create conditions favourable for their spread. The intestinal infections in this group also depend on lack of proper human waste disposal. 	<ul style="list-style-type: none"> Scabies Skin sepsis and ulcers Yaws Leprosy Lice and typhus Trachoma Conjunctivitis Bacillary dysentery Amoebic dysentery Salmonellosis Enterovirus diarrhoeas Paratyphoid fever Ascariasis Trichuriasis Whipworm (Enterobius) Hookworm (Ankylostoma)
<ul style="list-style-type: none"> Diseases caused by infecting agents spreaded by contact with or ingestion of water. (Water-based diseases) An essential part of the life cycle of the infecting agent takes place in an aquatic animal. Some are also affected by waste disposal. 	<ul style="list-style-type: none"> Schistosomiasis (urinary & rectal) Dracunculosis (guinea worm) Bilharziosis Philariosis Oncholersosis Treadworm
<ul style="list-style-type: none"> Diseases transmitted by insects which live close to water (water-related vectors) Infections are spread by mosquitoes, flies, insects that breed in water or bite near it. These are especially active and aggressive near stagnant open water. Unaffected by disposal. 	<ul style="list-style-type: none"> Yellow fever mosquito Dengue + dengue mosquito hemorrhagic fever mosquito West-Nile and mosquito Rift Valley fever mosquito Arbovirus mosquito Encephalitides mosquito Bancroftian mosquito Filariasis mosquito Malaria (diarrhoea)* mosquito Onchocerciasis* Simulium fly Sleeping sickness* Tsetse fly
<ul style="list-style-type: none"> Diseases caused by infecting agents. Mostly contracted by eating uncooked fish and other food. (Faecal-disposal diseases) 	<ul style="list-style-type: none"> Clonorchiasis Fish Diphyllobothriasis Fish Fasciolopsiasis Edible plant Paragonimiasis Crayfish

* Unusual for domestic water to affect these much

Source:

Saunders, J.; Warford, J.

Village Water Supply: Economics and policy in the Developing World.

Published for the World Bank by the Johns Hopkins University Press, Baltimore, 1976

Water-borne diseases are those carried by water that is contaminated with infecting agents from human or animal origin. When the water is drunk the infecting agents will be ingested and may cause disease. Control of such diseases calls for improving the quality of the water.

Diseases due to lack of water tend to be a serious health hazard. When people use very little water, either because there is little available or because it is too far away to be carried home in quantity, it may be impossible to maintain a reasonable personal hygiene. There may be simply too little water for washing oneself properly, or for cleaning food utensils and clothes. Skin or eye infections are thus allowed to develop, and intestinal infections can much more easily spread from one person to another. Clearly, the prevention of these water-washed diseases depends on the availability of, and access to adequate supplies of water rather than its quality.



WHO Photo by A.S. Kochar

Figure 1.1.
Water carried home over a long distance will be used very sparingly

Water-based diseases do not spread directly from person to person. They are caused by infecting agents that for an essential part of their life cycle develop in specific water animals, chiefly snails and crustaceans. Over a period of days or weeks, the parasite larvae or eggs mature in these intermediate hosts, and then are shed into the water. The matured larvae or worms are infective to people drinking the water or having contact with it.

In tropical countries biting insects are common. Most of these, notably the mosquitoes, breed in pools or other open water, and sometimes even in household water containers. Tsetse flies are also active near the water. Such water-related vectors carrying pathogens can transmit disease.

Health hazards also emanate from infection sources other than water. Diseases may spread through direct contact (e.g. soiled hands) or through food, particularly fish, vegetables and fruit eaten raw. Besides safe water supply, the necessary measures to control disease therefore should include personal hygiene and inspection of food storage and market places.

Very important is the provision of adequate sanitation, including sanitary facilities for human waste disposal. All the water-borne and many of the water-based diseases depend for their dispersion on infecting agents from human faeces getting into drinking water or into food. The diseases' chain of transmission may be broken as effectively by sanitary disposal of faeces as by the provision of safe and adequate water supplies. There are certain agents, such as hookworm, where sanitation is much more important than water supply in the prevention of disease because transmission is from the faeces to the soil, and then by direct contact and penetration through the human skin.

Improvements in the quality of community water supplies will basically only affect the water-borne diseases such as bacillary dysentery, cholera, typhoid, and possibly schistosomiasis. Many of the diarrhoeal disease probably are more due to a lack of adequate quantities of water. Certainly, skin and eye infections are in this group of water-related diseases.

The provision of a wash tap, shower or some similar washing facility frequently has proven to improve the user's health situation. There is, however, no con-

vincing evidence yet that once each family has a tap or shower, further improvement of the water supply will appreciably affect health. When water supplies are developed without complementary improvements in personal hygiene, food handling and preparation, and in general health care, they are unlikely to produce the expected health benefits.

1.2. Water supply and socio-economic development

In the industrialized countries, community water supply systems were first provided for the larger cities. Smaller cities and towns followed. The water supply systems were built by the state, district or town authorities, or by private companies. In rural areas, community water supplies were installed much later since public health considerations were less pressing than in urban areas. In the first half of the 20th century many national governments started giving financial and technical assistance to small communities and the extension of water supplies to the rural population was then greatly accelerated.

For significant socio-economic development of a community, an adequate supply of safe water is a prerequisite. Factors such as time and energy saving in the collection of drinking water, and a substantial reduction in the incidence of disease can contribute to development, provided the time and energy gained are utilized economically.

The new water supply could help activities such as fruit and vegetable processing or fish conservation. Whether potential productivity benefits are realized or not depends on the specific circumstances. One important factor is how the time and energy saved in carrying water might otherwise be used. In some villages the ill health of the labour force seriously affects agricultural development, whereas in others there is underemployment and benefits may not be realized unless the water supply project forms part of an integrated rural development providing increased employment. A new water supply may open opportunities for handicraft manufacture, livestock keeping or vegetable growing. Thus, when productive work is stimulated and personal hygiene, health care and food preparation are improved, side by side, a community water supply can be expected to have a positive socio-economic development impact.

This is particularly true in arid regions or areas with a long dry season if sufficient quantities of water are provided to allow watering of livestock and irrigation of vegetable gardens.

It is possible that water supply systems, in combination with complementary health and economic development programmes, could slow migration from the rural areas to the cities. There is little evidence, however, that the provision of water supplies alone will have any substantial effect on migration. It is more likely that water supply systems can be used to encourage, over a period of time, the grouping of dispersed populations into village units of some size. The more concentrated the population to be served the more likely it is that a financially viable and properly maintained water supply system can be provided. If the water supply enables and encourages the formation of settlements of some size, this can help improve the potential for economic development.

In most cases it is impossible to present a rigorous economic justification for small community water supply projects. Instead, the justification must rest on a qualitative assessment of the benefits anticipated from the water supply. The most important direct benefits of improving the quality of water supply generally are better hygiene and health, greater convenience, and benefits from stock watering and vegetable garden irrigation. Indirect benefits commonly cited are a redistribution of purchasing power in favour of the rural poor, a better standard of living, and the development of community institutions.

1.3 Small community water supplies in developing countries

In the urban centres of developing countries, community water supply systems of the type developed in industrialized countries can be suitable, with appropriate adaptations. Because of economies of scale and the large numbers of people to be served, the per capita investment and operating costs of urban water supply systems need not be high. When a substantial number of houses are connected to the water distribution system, and water charges collected on a regular basis, the water supply undertaking can become self-financing.

In most small towns and rural communities in developing countries, the prevailing water supply conditions are very different from urban installations. Usually the number of people to be served by such a water supply scheme is small and the low population density makes piped distribution of the water costly. The rural population often is very poor and, particularly in subsistence farming communities, little money can be raised. Funds are hardly available to pay for the operation and maintenance of the water supply scheme, and small communities are unlikely to be able to obtain the investment capital without assistance from the national government or from external donor or lending agencies.

Trained personnel for the operation and maintenance of the water supply scheme are generally not available in small communities.

Qualified staff for design and construction may be obtained with external sources assisting the national institutes to become self-reliant. The recruitment and training of the necessary personnel for operation and maintenance of the water supply systems can, however, be difficult.

One important factor is the requirement to use a technology that is appropriate for the local conditions. This technology will differ from the conventional one which was mainly developed for the larger water supply systems of cities and towns of developed countries.



Figure 1.2.
Typical small community situation

For small communities, piped water supplies with house-connections are often not economically feasible. In such instances, the realistic option is to provide a number of individual or 'point' sources: a protected well fitted with a handpump, a spring tapping structure or perhaps a rainwater catchment and storage system. For larger towns and villages, a small water treatment plant and distribution of the water through public standpipes may be feasible. When the community to be served makes a contribution towards the construction costs of the water supply system, whether by payment of funds or through the provision of labour or construction materials, the capital investment can be kept low. The recurrent costs for operation and maintenance often present a problem especially when water charges are difficult or impossible to collect.

A small community water supply system need not be difficult to design and construct. The engineer should carefully select a technology which is simple, reliable, and adapted to the available technical and organisational skills. This is not easy but these problems present a fascinating challenge and rewarding field of work.

Small community water supply systems have been built for a long time, and recently such schemes have been constructed in considerable numbers. Some were successful but the overall record does not appear good. Sometimes small water supplies proved to be unsuited to the conditions under which they have to operate. Several schemes have been completely abandoned within a few years after their construction. Frequent breakdowns are by no means uncommon. It is necessary to learn from past mistakes and to recognize the causes of failure. From these, guidelines can be developed for the planning, construction, operation and maintenance of small water supply systems.

Introduction

Ballance, R.C.

WATER SUPPLY, SANITATION AND TECHNOLOGY

Interdisciplinary Science Reviews, Vol. 3, No. 3, 1978

Beyer, M.

DRINKING WATER FOR EVERY VILLAGE: Choosing appropriate technologies

In: Assignment Children 1976, No. 34 (April-June)

Cairncross, S.; Feachem, R.G.

SMALL WATER SUPPLIES

Ross Institute, London 1978, 78 p. (Bulletin No. 10)

COMMUNITY WATER SUPPLY

World Health Organisation, Geneva, 1969, 21 p.

(Technical Report Series No. 420)

Environmental Protection Agency

MANUAL OF INDIVIDUAL WATER SUPPLY SYSTEMS

U.S. Government Printing Office, Washington, D.C., 1973,

155 p.

Feachem, R.G.; McGarry, M.G.; Mara, L. (eds.)

WATER; WASTES AND HEALTH IN HOT CLIMATES

John Wiley, London, 1977

Feachem, R.G.; Burns, E.; Cairncross, S. et al

WATER, HEALTH AND DEVELOPMENT: AN INTERDISCIPLINARY EVALUATION

Tri-Med Books, London, 1978, 267 p.

Johnson, C.R.

VILLAGE WATER SYSTEMS

UNICEF, Nepal, 1977, 107 p.

Mann, H.T.; Williamson, D.

WATER TREATMENT AND SANITATION: A HANDBOOK OF SIMPLE METHODS FOR RURAL AREAS

Intermediate Technology Publication Ltd. London, 1976, 90 p.

Pacey, A. (ed.)

WATER FOR THE THOUSAND MILLION

Pergamon Press, Oxford, 1977

PEOPLE, WATER AND SANITATION

In: Assignment Children No. 45/46

UNICEF, Geneva, 1976

Pineo, C.S.; Subrahmanyam, D.V.

COMMUNITY WATER SUPPLY AND EXCRETA DISPOSAL SITUATION IN THE DEVELOPING COUNTRIES: A COMMENTARY

World Health Organisation, Geneva, 1980, 11 p.

Saunders, R.J.; Warford, J.J.
VILLAGE WATER SUPPLY: ECONOMICS AND POLICY IN THE DEVELOPING
WORLD

World Bank Research Publication
Johns Hopkins University Press, Baltimore, 1976, 279 p.

Secretariat des Missions d'Urbanisme et d'Habitat (S.M.U.H.)
ALIMENTATION EN EAU

Ministère de la Coopération
Fonds d'Aide et de Coopération (F.A.C.), Paris, 1977

Wagner, E.G.; Lanoix, J.N.
WATER SUPPLY FOR RURAL AREAS AND SMALL COMMUNITIES

World Health Organisation, Geneva, 1959, 337 p.
(Monograph Series No. 42)

White, A.U.; Seviour, C.
RURAL WATER SUPPLY AND SANITATION IN LESS-DEVELOPED COUNTRIES
International Development Research Centre, Ottawa, 1974, 81 p.

White, G.F.; Bradley, D.J.; White, A.U.
DRAWERS OF WATER: Domestic Water Use in East Africa
University of Chicago Press, Chicago, 1972

2. planning and management

2.1 Planning

In many countries the provision of community water supply systems is a major element in the environmental health programme and they are frequently planned in this context. However, the actual responsibility of the public health authorities is often limited to the quality surveillance of drinking water from community supplies, sometimes coupled with the control of sanitary facilities. In some countries the health authorities have assumed a direct responsibility for small community water supplies and sanitation in rural areas.

The control function in respect to water supplies and sanitary facilities would imply an active part in the planning, management and maintenance of all schemes. But the health authorities may not be sufficiently staffed and equipped to cope with the demands of such an involvement. Engineering units of other government departments usually carry out the bulk of water supply planning and construction. They are likely to concentrate their efforts on engineering and cost aspects, and may tend to overlook the health and social implications of drinking water supplies.

Programmes rather than projects

The planning and design of a large city water supply system usually is approached as a project. The term project is used here to describe all the preparations for the construction of a single scheme or water supply system. Every such major scheme is dealt with as a separate project. However, when planning water supply systems for a large number of small rural communities, the approach should be that of a programme rather than a series of individual projects. A programme is here understood to be an integrated group of continuing activities directed at the implementation of a considerable number of similar water supply schemes or systems. The key problems are likely to be less technical and more organisational and administrative. Community involvement aspects will assume a much greater significance.

Under a programme, technical decisions often have to be subordinated to other considerations. For example, the number of different types or models of pumps used in a programme should be kept to a minimum in order to reduce supply and maintenance problems. In the project approach, a pump would be selected to fit a technical specification, and the maintenance system would then be adapted to the pump's characteristics and service requirements.

Another basic difference is how the users perceive their relationship to the water supply and its cost and benefits. The urban dweller seldom has an alternative water source and is mostly aware of the general benefits of water supply services. Thus little time and effort are required to convince him of the need for more ample or safe water. In a small rural community there is usually no equivalent to this urban 'demand' for water. Rural households frequently have a choice between alternative water sources and people have developed their criteria to choose between them. Water is usually seen as a free commodity. Health considerations play a minor role. The quantities of water used are small, except perhaps for stock watering and plot irrigation. A strong demand for good quality water will then initially only exist in situations of severe shortages or of heavy pollution of the water sources.

It is, therefore, to be expected that an urban-type demand for water will not develop in small rural communities without some change in deeply ingrained water-use customs. An educational effort will have to be linked to the rural water supply programme and carried out with subtlety and knowledge of local habits.

Financial Considerations

In urban areas inhabitants have usually accepted the principle, or at least are familiar with the requirement that they must pay for the water, or rather for the convenience of having safe water delivered near the point of use. In small rural communities the principle of paying for water is usually not widely accepted. People feel that water, like air, is a natural gift. It is also a fact that those living in small communities often have little capacity to pay. Thus, developing financing schemes will be difficult and time-consuming, and requires a clear understand-

ing of local habits. For example, bills may have to be timed with local harvests.

For any rural water supply programme, it is necessary to establish a long-range financing arrangement. Small communities frequently find it difficult to obtain the capital for construction even when they unite into a national or provincial programme. The initiative for organizing and financing these programmes, therefore, must usually come from the central or provincial government.

Revolving funds offer one excellent method of financing because of their flexibility and adaptability to local needs and conditions. A revolving fund is a centrally established fund which finances new projects using repayments on earlier loans. To get started, the funds need to be established at the national or provincial level. The benefitting communities contribute labour and local materials for construction (for example, in Latin America usually up to 20 percent of construction costs). They then pay a water rate that, as a rule, covers local operation and minor repair expenses. To back up such local efforts, the national programme should organize a system for major repairs and maintenance at the district or provincial level. As the payments on earlier loans come in, the revolving fund is available to finance other schemes.

It is important to note that, in financing an urban scheme, basically all the required funds come from the community itself in the form of water revenues. In contrast, for the small rural communities, about 80 percent of construction costs would come from outside in the form of loans, grants, etc., and only the remaining 20 percent are direct community contributions such as construction materials and labour.

Recent studies in Latin America indicate that repayment schemes tend to promote effective organization at the local level. For this, the assistance of local administrators is essential. Communities do get used to community financing of water supply services and one of the major benefits seen is a greater community involvement.

Typical designs and standardisation

As one examines the thousands of small water supply systems required, one is struck by the number of repetitive elements: wells, intake structures, water

tanks, pump houses, etc. Substantial cost savings can be had if standard designs and construction techniques are used. In addition, costs can also be reduced by using technicians who are trained in the repetitive systems, limiting the number of professional engineers needed.

An advantageous approach has been developed in Latin America. Within this approach, the programme is broken down into its component parts - community promotion, technical design, programme financing, etc. - and each component is considered for its effects upon the others. A programme is developed which incorporates these elements into the least-cost solution that will best utilize the programme resources (manpower, finance, technology and management). It is obvious that, since a rural water supply programme must repeat many tasks in thousands of villages - in some countries, in tens of thousands of villages - the development of standard designs becomes a necessity.

These designs must allow for rapid and effective construction techniques, through repetitive work by relatively unskilled artisans with standard equipment and plant. Unit design constitutes an essential feature. The savings in planning and supervision costs will almost certainly outweigh the slight technical inefficiency of such a design. It is possible to devise a very simple form of investigation which will enable a technician or sanitarian to collect in one day sufficient information about a small water project to support its qualification for a certain type of design.

Standard design criteria should be selected, pre-designed elements (tanks, pump houses, etc.) and uniform equipment lists should be prepared. Once the design of a particular scheme has been reviewed by an engineer, the materials would be assembled in a central yard and sent to the community as a package, together with all the necessary tools and items not readily available locally. Professionals would also develop techniques and strategies for involving the community. These are formalized as work modules for each phase, and used in the training of personnel assigned to implement them at the local level. The design of both the technical and community involvement modules are determined in the context of the overall programme.

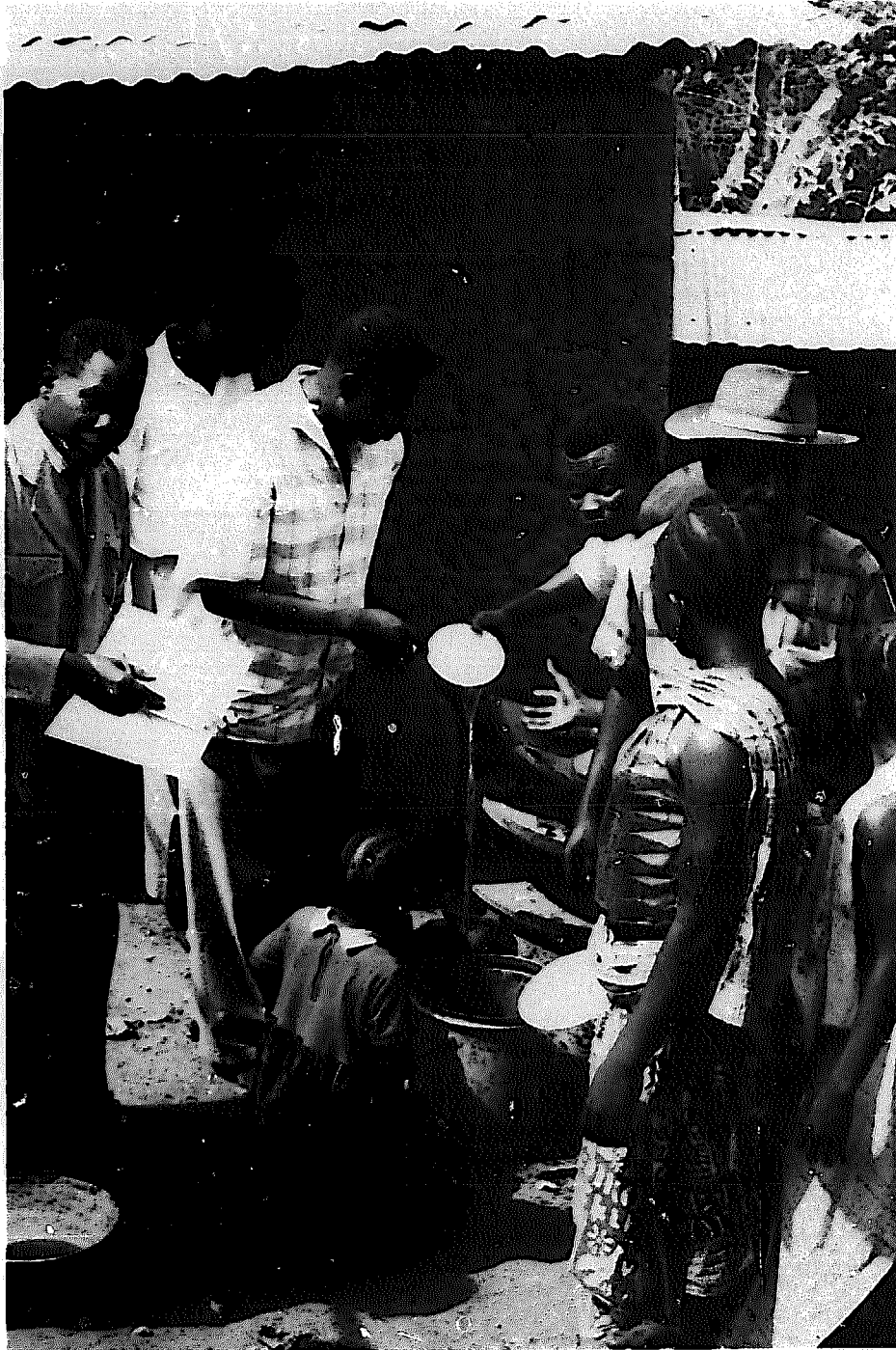

WHO Photo

*Figure 2.1.
Water, health and development*

2.2 Management and supervision

The following table outlines the principal functions carried out at the national, provincial and local levels. In some countries, provincial programmes are set up to operate autonomously but they are linked to the national programme by means of standard criteria, designs and financial assistance.

*Table 2.1.
Functional division over different levels of government*

<u>Level</u>	<u>Functions</u>
<u>National</u>	<ul style="list-style-type: none"> . Long-term planning. . Establishment of policies (technical and administrative) and standards. . Management of national funds, and matching these to local contributions. . Supervision of the execution of the national plan. . Supervision of provincial programmes. . General financial control. . Provision of technical assistance. . Training.
<u>Provincial (and District)</u>	<ul style="list-style-type: none"> . Programme implementation. . Design. . Construction, and administration of projects. . Promotion of community participation.
<u>Local</u>	<ul style="list-style-type: none"> . Administration of community water supply systems. . Operation and maintenance. . Collection of water charges.

It will not be possible to include all the existing small and rural communities into the national or provincial water supply programme at once. A selection will have to be made which will be amended and updated periodically. The criteria for selection and the order of priority for the construction of schemes will be determined at the national or provincial level taking into consideration all relevant factors.

The objective of any rural water supply programme should be as specific as possible. For instance: 'All

communities of 500 persons or more, and 50% of the smaller communities will have a safe water supply within a distance not exceeding 500 metres from each individual house, within 8 years'. Or, 'The goal is to provide drinking water to 90% of the rural communities in districts A and B within 22 months'. In contrast, it is vague to state the objective as 'Improvement of the water supply of small communities'.

A strong commitment to the programme at the national policy level is essential in order that the programme can operate on a long-term basis. It is often necessary to provide subsidies for some time until the communities served by the new schemes appreciate the benefits of an adequate supply of safe water. Once the people understand this, the process becomes one of a continuous upgrading of the basic service until it, hopefully, will reach a level where it is both firmly supported by the community and financially self-sufficient.

The management, operation and maintenance of a water supply system is a matter that should be kept in mind by policy-makers and design engineers from the earliest planning stage. The following statement summarizes this eloquently (Wagner & Lanoix, 1959):

' The engineer who makes the preliminary field investigations and designs can, by his decisions, facilitate or complicate future operation and maintenance problems. This will depend on whether he is searching simply for a solution, or for the best possible solution. Often, as a result of haste, these studies become less thorough than they should be. The engineer in charge of field investigations and design controls one of the most important phases which bears heavily on the future functioning of the project'.

'If by diligent work he can eliminate a pump, an engine, another piece of equipment, or a treatment process, he is thereby removing a possible obstacle to efficient operation. An understanding of the operational problems of small water systems, perseverance in the search for simple solutions, and vigilance in approval of projects are the best possible measures to facilitate the operation and maintenance of these systems, and, thus, to ensure the fulfillment of their function'.

' From the administrative standpoint, proper management of a water supply system, no matter how small, requires operating funds, personnel and organizational services. Since these are within the control of

local authorities, early negotiations should be undertaken, and a considerable degree of agreement should be reached, before the project gets into the construction stage. These negotiations are not always easy, as some officials, whether selected or appointed, will jealously guard their full authority, even though they may have had no previous experience in water supply management'.

2.3 Manpower and training

The number of personnel needed to manage and operate a small water supply greatly depends on the type of distribution system, if any, and whether there is a water treatment plant and/or pumping station. It should not be expected that qualified personnel will be found in small towns and villages. However, it will often be possible to recruit and train potentially good employees for both administrative and operational functions. One of the methods which has proven successful consists of using the construction period to select and train the key personnel who, later, will be responsible for operational duties. During this phase, they have an opportunity to learn how the system is put together and works. In this way they can best understand and perform the maintenance work which is expected of them.

The actual selection of these men may, in some instances, be a delicate matter inasmuch as their employment may be the normal function of the local government. With tact and understanding, however, it should be possible to find candidates who are acceptable to the local authorities and who possess the minimum qualifications required.

The challenge will be in the use of sub-professional personnel. While managers and engineers who are experienced in community systems should manage the programme, their task will be so great (and they are usually so few) that they will have to devote their time to directing, planning, reviewing and supervising the programme. A special group of sub-professional technicians and/or sanitarians should be trained for the day-to-day cooperation with the communities, the collection of field data, prospecting for and investigation of water sources, the preparation of the repetitive designs as well as the inspection visits to the completed systems.

In small undertakings, each person in a supervisory position has to perform a number of functions and without proper training he is bound to be inefficient in any individual function. Training is, therefore, particularly important for manpower engaged in small community water supply systems.

Training should stress the practical aspects of the subjects covered and should include a minimum of formal lectures. The programme of training may be accompanied, when circumstances permit, by a programme of examination and certification of water system technicians and operators, several grades being established for each category of personnel. Such a programme, which may be undertaken in collaboration with local educational authorities, will help to create an incentive on the part of the water supply personnel for technical development and progress towards more responsible positions.

One cannot overstress the need to develop in the mind of every waterworks official, whether office or field employee, the concept of 'service to the community'. Both the administration and the operation of a water system, large or small, should be geared towards the provision of a satisfactory service to the consumer. In many rural areas, this will be a novel idea. Often rural or small-town folk do not think of public utilities as agencies from which they can expect or demand service. To them the water supply may be thought of in terms of the mail service: poor and intermittent. Their attitude would be one of complacency. Much effort should be made by the responsible agency to ensure that neither the people served nor the watersupply employees develop this sort of attitude. The objective should be to make the employees understand the importance of giving a satisfactory service to consumers, and their role and responsibility in this. On the other hand, the local population needs to develop a sense of ownership and pride in the water supply system and to understand that it has a right to demand service. These processes are neither simple nor quick. However, once they are established, the service concept will grow and become more generally accepted. The critical time is in the early stage.

2.4 Community involvement

Acceptance of a small water supply system by a community is by no means assured. The users may not be satisfied by the supply provided, if it does not meet their expectations. Waiting in long lines to collect water, intermittent service and insufficient supplies during some or many hours daily, are common problems.

Engineers and technicians sometimes go to small communities, install water supply systems, and expect the villagers to use them with care for long periods of time. Too often, the people who are to benefit from the water supply system are not consulted on matters of design, construction, use and maintenance of the facilities. It is difficult, if not impossible, to achieve the continuous functioning of a small water supply without some degree of community involvement. If the installations are not accepted and supported by the community, they are likely to suffer from misuse, pilferage or even vandalism. Conversely, it has been seen time and again that, with proper consultation and guidance, people can be motivated to help in the planning, construction, operation and maintenance of water supply systems for their communities.

The positive role of community involvement in water supply development can be illustrated by events in Malawi. Here, participation of local people was the key to success in bringing piped water to over 150,000 villagers in water-scarce areas, at a cost of about US\$ 3 per person only. The villagers dug all the trenches, laid the pipes (supplied by the government and aid agencies), and constructed concrete aprons and soak pits. Small-scale pilot demonstrations were initially used, leading to large public meetings where there was a chance to discuss all aspects of the new system. As the project evolved, the concept of the 'project assistant' was introduced; three-week training courses were conducted for men who had been carefully selected by the communities and were charged with responsibility for the local systems.

Analysis of existing small community water supplies has shown that participation in the early design stages greatly contributes to the success of a project. The choice of water source, the level of service and the siting of the water supply facilities in particular are decisions in which the community can be usefully involved. A second consideration for more

community involvement in the design stage, the safeguarding of the interests of weaker sections of the community, will be more difficult to accept. Yet many of the decisions that are taken in this phase may lead to a worsening of the position of disadvantaged groups. Social problems impairing the access to the supply, loss of employment, loss of social contacts for women, and the domination of local elites in the water organization are all possible consequences of a new water supply system.



UNICEF/WHO photo by Matheson

*Figure 2.2.
Community involvement in construction*

Community involvement in the construction of small water supply systems can take many forms. Local contributions in cash, labour, materials, services and organization will reduce the required capital investment, stimulate feelings of local pride and

commitment, develop local capabilities, and present opportunities for the selection and training of suitable personnel for maintenance of the supply. It will also promote the proper use of the supply by the people. But such community involvement can make too great a claim on the available resources and time, resulting in a poor standard of construction, delays, difficulties in the recruitment of the required personnel and local conflicts. Generally, some involvement of the community in the construction of the water supply is regarded necessary but the usefulness of local labour depends to a considerable extent on the type of technology adopted, the local conditions and the availability of technical supervisors.

The delegation of operation and maintenance tasks to a community is more common today than it was some years ago. These delegated responsibilities vary widely, from some checking and reporting, or basic routine maintenance, up to the training of caretakers and operators. There is a considerable range of local organisation and administrative arrangements.

Three approaches may be distinguished: a standard approach, individual arrangements, and a compromise combination. In Latin America, a standard approach has been used with fixed selection procedures, formal delegation of responsibilities and authority, supplemented by training and supervision. Elsewhere, individual arrangements are common which are adapted to the existing community organization. However, these arrangements lack a legal base and their effectiveness is often limited. As a compromise, some flexibility can be brought into the standard approach to suit the local, social and cultural pattern. This relates to matters such as the selection procedures, scope of community organization and division of responsibilities and authority.

If the cooperation between the community and the water supply agency or health department is to be effective, both sides will have to be partners in a full exchange of information and views. The water supply agency needs to set forth the desired goals of the community water supply system. Health education may be part of the motivation for the water project and should start as early as possible. On the other hand, local conditions, expectations, and constraints will also play important roles. The water agency therefore needs to receive sufficient information about the socio-economic and cultural background of the community.

Project information and general health education during the planning phase may be followed by more specific educational efforts, such as training for delegated tasks. A users' education programme can be started before the installation is completed. Health education may be continued as a more specific programme on personal, household and public hygiene and other related health aspects. The integration of health education as a part of any water supply project has already been emphasized. The provision and use of safe water alone will not be enough to achieve a health impact. Usually, improvements in disposal of waste, nutrition, animal hygiene, housing, insect and rodent control, and food hygiene will be needed as well. In some countries water projects are part of the primary health care programme, or they are linked to nutrition projects. However, even when water supplies are planned and implemented independently, engineers should discuss with the community the role water can play in local development and they should encourage other agencies to link their programmes to the water project.



WHO Photo by D. Deriaz

Figure 2.3.
Educating the people about water (Iran)

2.5 Maintenance

Experience shows that small community water supplies are often more difficult to be kept running than to construct. The need for maintenance is generally recognized but the actual maintenance work is frequently neglected. A basic principle in the planning of any small community water supply should be that the technical design keeps in view the maintenance requirements of the installations and equipment. The maintenance scheme should be feasible, just as the technical design should be cost-effective and suited to the local conditions.

Two factors contribute to most failures in small community water systems:

- a) Equipment and materials are used under conditions for which they are not designed;
- b) Operators who, due to ignorance or disinterest, do not recognize the indications which precede breakdowns and failures.

The typical operator of a small water treatment plant also supervises or actually makes water service connections, reads meters, answers complaints and orders needed supplies and equipment. He must also argue his case before the town board, village chief or water committee. He is lucky if he receives half the pay he is worth. Operators of small water supply plants have limited resources available to them, and are frequently called upon to perform extensive tasks. They often get little support and appreciation. Yet they have to carry out their work in a creditable fashion.

By careful review of plant, design and specifications, the water supply agency can prevent or eliminate most difficulties of a mechanical nature. The reduction of troubles caused by the human element is harder to achieve. But much can be done, as previously indicated, through training of field personnel, technical assistance and supervision.

The following reasons make it particularly important to provide for proper operation and maintenance.

The effect of an inoperative community water supply on the health of the users. This may be difficult to quantify but many studies and surveys have shown that the incidence of intestinal diseases is related to the use of polluted water. Improvements in the health

situation that can result from the supply of safe water, are lost when the water supply breaks down.

In small rural and urban squatter communities where the provision of safe water is most important, the introduction of a new water supply is often a major event. Frequently this event also forms part of the health education towards the hygienic use of the water. If the water supply becomes inoperative, the chances of improving the hygienic practices in the community will be lost for months, if not years. Furthermore, if the water supply scheme was constructed with contributions from the community, whether in kind or money, the people will probably view the breakdown of the supply as evidence that their contribution is wasted. It is likely that they will be unwilling to further cooperate with the water supply agency or the government.

The above facts are difficult to analyse from a strictly economic point of view. However, a tentative assessment of the economic impact is as follows:

A country may have some 10,000 small community water supplies representing an average investment of about \$ 30,000 each. If only 75% of these schemes are functioning, then 2,500 schemes are out of operation at any one time. Should an improved maintenance system ensure the continuous operation of 1,500 out of these 2,500 schemes, this would be equivalent to a capital investment of \$ 45 million! Moreover, experience shows that installations remaining out of order for more than a few days are likely to suffer from pilferage and vandalism. It is not unusual that equipment is stolen from them. Therefore, not only the inconvenience and health hazards of inoperative small water supplies should be considered but also the loss of equipment, spare parts and construction materials.

The primary responsibility for the continuous functioning and maintenance of a small water supply system lies with the community, at the local level, backed by district support and the national water supply programme. A good example of this comes from the State of Tamil Nadu, in India, where a three-tier maintenance system was introduced. Since 1971, about 15,000 deep-well hand pumps have been installed and about an equal number of shallow-well hand pumps, serving villages in the rural areas of the State. The three-tier system is intended to provide maintenance of these wells and pumps.

The three-tier maintenance system comprises the following service personnel:

1) Caretaker at village level

An interested and capable volunteer, who usually lives close to the handpump, is chosen from among the villagers. He may be a farmer, shopkeeper, artisan or social worker. He is given a two-day orientation course on the importance of drinking water supply and on the mechanism, operation and servicing of hand pumps. He is trained to attend to minor repairs and is supplied with basic tools. He is also given pre-stamped and addressed postcards in the local language. When a breakdown occurs, the caretaker tries to fix it. If he can not do so, he specifies the type of repairs needed on two postcards, one of which he posts to the block-level 'fitter' and the other to the District mobile team. So far, some 2,000 caretakers have been trained in Tamil Nadu State.

2) 'Fitter' at the block level

One 'fitter' (service mechanic) for every 100 handpumps is appointed at the block level. He is under the supervision of the Block Development Officer. Upon receipt of a request from a caretaker, the fitter proceeds to the village and attends to repairs, if the problem is located in the 'top end' of the mechanism.

3) Mobile team at the district level

In case of the need for major repairs, it is the mobile team at the district level which proceeds to the village upon receipt of the postcard. There is one such team for every 1,000 handpumps and, therefore, this often involves a delay of a week or more. To reduce this waiting, the Tamil Nadu Government is now recommending one such team for every 500 handpumps. Any expenses incurred in the repairs are shared by the government and the local 'gram panchayats' (village councils).

Some breakdown of a water supply plant and equipment is inevitable in spite of the best maintenance measures taken. In order to deal with such breakdown efficiently and with minimum delay, the following facilities should be available:

- Workshop facility
- Sufficient stock of necessary spares, etc.
- Technical staff
- Communication facility
- Directory of addresses and names of firms and suppliers
- Training programme.

2.6 Emergency operation

Every community water supply system, large or small, should have some emergency procedures which may have to be operated in situations such as earthquake, flood, or war damage. It must be recognized that, in such circumstances, water is probably the most urgent need of people who will use any available source, polluted or not, unless provision is made quickly for a supply of safe water. It is recommended that, soon after the installation of a new water system, or even before, a realistic inventory be made covering all available sources of water, public or private. This inventory should include personnel resources and the available emergency-type water supply equipment, hand and motor pumps, water-tank trucks, pipe accessories, mobile or portable filter units, tools and spare parts, and chemicals (especially those for water disinfection purposes).

During emergencies, a minimum of 2 litres of water per person should be provided daily for drinking and 3 litres for other purposes, in such places as temporary shelters. In camps with tents, a minimum of 10 litres per person should be provided. This amount should be doubled for the supply of temporary hospitals and first-aid stations. While ground-water supplies from properly constructed wells, infiltration galleries, and spring structures may be regarded as safe, all surface water should be considered of doubtful quality. It has to be disinfected by boiling, chlorination or disinfection by iodine compounds. The free chlorine residual in reasonably clear water at times of emergencies should be not less than 0.5 mg/l after 30 minutes of contact for water that has not been filtered.

Planning and management

Bainbridge, M.; Sapirie, S.

HEALTH PROJECT MANAGEMENT

A Manual of Procedures for Formulating and Implementing Health Projects.

World Health Organisation, Geneva, 1974

(WHO Offset Publication No. 12)

Barker, H.W.

ASSESSMENT OF MANPOWER NEEDS AND TRAINING PROGRAMMES

In: International Training Seminar on Community Water Supply in Developing Countries

International Reference Centre for Community Water Supply, The Hague, 1977 (Bulletin No. 10)

Cairncross, S.; Carruthers, I.; Curtis, D.; et al

EVALUATION FOR VILLAGE WATER SUPPLY PLANNING

International Reference Centre for Community Water Supply, The Hague, 1980, 175 p. (Technical Paper Series No. 15)

Campbell, S.; Lehr, H.

RURAL WATER SYSTEMS PLANNING AND ENGINEERING GUIDE

National Water Well Association, New York, 1973

Donaldson, D.

PLANNING WATER AND SANITATION SYSTEMS FOR SMALL COMMUNITIES

In: International Training Seminar on Community Water Supply in Developing Countries. (Amsterdam, 1976)

International Reference Centre for Community Water Supply, The Hague, 1977 (Bulletin No. 10, pp. 71-105).

Also presented as:

LA PLANIFICACION DE SISTEMAS DE AGUA Y SANEAMIENTO PARA PEQUEÑAS COMUNIDADES

In: Curso Corto de Planificacion y Programacion de Saneamiento Bsico Rural, (Managua, Nicaragua, November 1977)

Panamerican Health Organisation, Washington, D.C., 1978

Imboden, N.

PLANNING AND DESIGN OF RURAL DRINKING WATER PROJECTS

OECD Development Centre, Paris, 1977, 51 p.

(Occasional Paper No. 2)

Kantor, Y.

RESEARCH, TRAINING AND TECHNOLOGY ASPECTS OF RURAL WATER SUPPLY AND SANITATION IN DEVELOPING COUNTRIES

World Bank, 85 p.

Pacey, A. (Ed.)

TECHNOLOGY IS NOT ENOUGH: THE PROVISION AND MAINTENANCE OF APPROPRIATE WATER SUPPLIES

In: Water Supply & Management, Vol. 1 (1977), No. 1, pp. 1-58

Wijk-Sijbesma, C. van
PARTICIPATION AND EDUCATION IN COMMUNITY WATER SUPPLY AND
SANITATION PROGRAMMES (2 volumes)
International Reference Centre for Community Water Supply, The
Hague, 1979, 1980.

- A selected and Annotated Bibliography, 238 p.
(Bulletin Series No. 13, 1980)
- A literature Review, 204 p. (Technical Paper No. 12, 1979)

Pisharoti, K.A.
GUIDE TO THE INTEGRATION OF HEALTH EDUCATION IN ENVIRONMENTAL
HEALTH PROGRAMMES
World Health Organisation, Geneva, 1975

Schaefer, M.
THE ADMINISTRATION OF ENVIRONMENTAL HEALTH PROGRAMMES:
A SYSTEMS VIEW
World Health Organisation, Geneva, 1974
(Public Health Paper No. 59)

Stanley, S.
BETTER PLANNING IS THE KEY
In: Reports, 6(1977)3
International Development Research Centre, Ottawa, 1977

Wagner, E.G.; Lanoix, J.N.
WATER SUPPLY FOR RURAL AREAS AND SMALL COMMUNITIES
World Health Organisation, Geneva, 1959, 337 p.
(Monograph Series No. 42)

WATER AND COMMUNITY DEVELOPMENT
In: Assignment Children 1976, No. 34, (April-June)
UNICEF, Geneva.

White, G.F.
DOMESTIC WATER SUPPLY IN THE THIRD WORLD
A paper presented at the IAWPR Symposium:
"Engineering, Science and Medicine in the Prevention of Tropical
Water Related Diseases"; London, December 1978.
In: Progress in Water Technology, Vol. 2 (1978)
Nos. 1 and 2, pp. 13-19

Whyte, A.
TOWARDS A USER-CHOICE PHILOSOPHY IN RURAL WATER SUPPLY PROGRAMMES
Assignment Children 1976, No. 34 (April-June)
UNICEF, Geneva.

3. water quantity and quality

3.1 Water use and consumption

Depending on climate and work load, the human body needs about 3 - 10 litres of water per day for normal functioning. Part of this water is derived from food. The use of water for food preparation and cooking is relatively constant. The amount of water used for other purposes varies widely, and is greatly influenced by the type and availability of the water supply. Factors influencing the use of water are cultural habits, pattern and standard of living, whether the water is charged for, and the cost and quality of the water.

The use of water for domestic purposes may be subdivided in various categories:

- drinking
- food preparation and cooking
- cleaning, washing and personal hygiene
- vegetable garden watering
- stock watering, and
- other uses including waste disposal

Individual house connections provide a higher level of service than a tap placed in the house yard ('yard connection') which in its turn is generally preferred over a communal water point such as a village well or a standpipe. In the selection of the type of water supply system, finance is usually an important factor, and the choice also depends on the location and size of the community, the geographical conditions, and the available water source.

Water use and consumption data are frequently expressed in litres per capita (head) per day (l.c.d.)*. Although such data neglects the fact that in a household a considerable part of the water use is shared by all members of a family (e.g. cooking, cleaning), per capita daily water usage data are useful for making rough estimates of a community's water demand.

* Previously, per capita water use data expressed in gallons per day was common.

In table 3.1 typical domestic water usage data are listed for different types of water supply systems.

Table 3.1.
Typical domestic water usage

Type of Water Supply	Typical Water Consumption (litres/capita/day)	Range (litres/capita/day)
Communal water point (e.g. village well, public standpost)		
- at considerable distance (> 1000 m)	7	5 - 10
- at medium distance (500 - 1000 m)	12	10 - 15
Village well		
walking distance < 250 m	20	15 - 25
Communal standpipe		
walking distance < 250 m	30	20 - 50
Yard connection (tap placed in house-yard)		
	40	20 - 80
House connection		
- single tap	50	30 - 60
- multiple tap	150	70 - 250

Sometimes, the number of households (families) in a community is easier to determine than the number of individuals, and the domestic water use can then be computed using an estimated average size of family.

Usually water from the community water supply is also used for other than domestic purposes, and in such cases additional amounts of water should be provided for these categories. Table 3.2 gives indicative data.

All the water requirements mentioned should be used for preliminary planning and design purposes only. It may serve as a rough guide. For the final design, criteria are needed that are specific for the country or area concerned. Studies of existing small community water supply systems in the same area can provide very useful water usage data. Field measurements should be taken whenever possible.

It is very difficult to estimate accurately the future water demand of a community and the design engineer must exercise considerable judgement in his analysis.

Table 3.2.
Various water requirements

Category	Typical Water Use
- Schools	
. Day Schools	15 - 30 l/day per pupil
. Boarding Schools	90 - 140 l/day per pupil
- Hospitals	
(with laundry facilities)	220 - 300 l/day per bed
- Hostels	80 - 120 l/day per resident
- Restaurants	65 - 90 l/day per seat
- Mosques	25 - 40 l/day per visitor
- Cinema Houses	10 - 15 l/day per seat
- Offices	25 - 40 l/day per person
- Railway and Bus Stations	15 - 20 l/day per user
- Livestock	
. Cattle	25 - 35 l/day per head
. Horses and Mules	20 - 25 l/day per head
. Sheep	15 - 25 l/day per head
. Pigs	10 - 15 l/day per head
- Poultry	
. Chicken	15 - 25 l/day per 100

The water usage figures given above include about 20% allowance for water losses and wastage. If there is considerable leakage or unauthorized withdrawal of water from the distribution system, the required supply of water will obviously be greater. In some cases these water losses may be as high as 30 - 50 % of the supply.

As a tentative estimate, a water supply system for a more or less centralized community settlement would need to have a capacity of:

- : about 0.3 l/sec. per 1,000 people when the water is mainly distributed by means of public standpipes;
- . about 1.5 l/sec (or more) per 1,000 people when yard and house connections predominate.

To allow for future population growth, and a higher use of water per person (or per household), a community water supply system should have a sufficient surplus capacity. The design is typically based on:

- the daily water demand estimated for the end of a specified period (the "design period), e.g. 10 years;
or
- the present water demand plus 50%;
or
- the demand computed on the basis of the population growth estimate.

The 'population growth factor' may be read from table 3.3.

*Table 3.3.
Population growth factor*

Design period (years)	Yearly growth rate			
	2 %	3 %	4 %	5 %
10	1.22	1.34	1.48	1.63
15	1.35	1.56	1.80	2.08
20	1.49	1.81	2.19	2.65

A community water supply system should also be able to cater for the maximum hourly or peak water demand during the day. (See: Chapters 18 'Water Transmission' and 19 'Water Distribution').

3.2 Water quality

The relationship between water quality and health effects has been studied for many water quality characteristics. An examination of water quality is basically a determination of the organisms, and the mineral and organic compounds contained in the water.

The basic requirements for drinking water are that it should be:

- Free from pathogenic (disease causing) organisms.
- Containing no compounds that have an adverse effect acute or in the long term, on human health.
- Fairly clear (i.e. low turbidity; little colour).
- Not saline (salty)
- Containing no compounds that cause an offensive taste or smell.

- Not causing corrosion or encrustation of the water supply system, nor staining clothes washed in it.

For their ready application in engineering practice, the results of the studies and research on drinking water quality must be laid down in practical guidelines. Usually these take the form of a table giving for a number of selected water quality parameters, the highest desirable level and the maximum permissible level. Such values should be regarded as indicative only, and should not be taken as absolute standards.

The most important parameter of drinking water quality is the bacteriological quality, i.e. the content of bacteria and viruses. It is not practicable to test the water for all organisms that it might possibly contain. Instead, the water is examined for a specific type of bacteria which originates in large numbers from human and animal excreta and whose presence in the water is indicative of faecal contamination. Such indicative bacteria must be specifically faecal and not free-living. Faecal bacteria are members of a much wider group of bacteria, the coliforms. Many types of coliform bacteria are present in soil. Suitable indicator bacteria of faecal contamination are those coliforms known as *Escherichia-coli* (E-coli), and faecal streptococci. They are capable of easy multiplication. When these bacteria are found in the water, fairly fresh faecal contamination is indicated, and on that basis there is the possibility of the presence of pathogenic bacteria and viruses. Either one or both of these coliform and streptococci bacteria may be used as indicator organisms.

In almost all small community water supply systems faecal bacteria are likely to be found. It would be pointless to condemn all supplies that contain some faecal contamination, especially when the alternative source of water is much more polluted. Rather, testing of the bacteriological quality of the water should examine the level of faecal pollution, and the amount of contamination of any alternative sources.

Water samples should be collected in sterile bottles according to standard procedure. They should be shaded and kept as cool as possible. It is necessary to carry out bacteriological examination of samples within a few hours after sampling, otherwise the results will be quite unreliable.

There are two methods for conducting tests on the

levels of faecal coli and faecal streptococci in water: the multiple tube method for establishing the most probable number (M.P.N.), and the membrane filtration method.

In the multiple tube method, small measured quantities of the water sample are incubated in 5 or 10 small flasks containing a selective nutrient broth. The most probable number of bacteria in the sample (M.P.N.) can be estimated on the basis of the number of bottles which show signs of bacterial growth.

In the membrane filtration method, water is filtered through a membrane of special paper which retains the bacteria. The membrane is then placed on a selective nutrient medium and incubated. The bacteria multiply forming visible colonies which can be counted. The result is expressed as number of bacteria per 100 ml of water. Direct counts of faecal coli and faecal streptococci can be made in 24 and 48 hours respectively. There is no need for confirmatory tests to check the species of bacteria as in the multiple tube method.

The equipment and materials necessary in the multiple tube method for faecal coli are cheaper and generally more readily available in developing countries, than is the case for the membrane filtration method. The problem with using the multiple tube method for faecal streptococci is that the required 5 days' incubation time is not so practical. The membrane filtration method is applicable both for faecal coli and faecal streptococci. It gives rapid results which are easy to interpret and quite accurate. The membrane tests can be carried out on site in the back of the vehicle. The multiple tube equipment is fragile and requires special provisions during transport. Taking all factors into consideration, the membrane filtration method is to be recommended.

In either of the methods, the facilities for the incubation are the main constraint. The difficulty is the accurate control of the temperature. For faecal coli, incubation should be at an accurately controlled temperature of $44.5^{\circ} \text{C} \pm 0.2^{\circ} \text{C}$. This degree of temperature control is not easy to achieve in an incubator under field conditions but special portable incubators are commercially available which can maintain the temperature within the required narrow range. They are relatively expensive (several hundred dollars) and require a power source such as a car battery for operation. If incubation with an accurate temperature control is not possible, the recommended practice is that only faecal streptococci should be

counted. For this count, incubation is required at 35-37° C which can be more readily provided.

Where possible, examination for both faecal coli and faecal streptococci should be made. This will provide an important check on the validity of the results. It also gives a basis for computing the ratio at which the two species of bacteria are present from which a tentative conclusion can be obtained whether the faecal pollution is of animal or human origin.

The following bacteriological quality criteria are generally applicable for small drinking water supplies:

- . Coliforms - less than 10 per 100 ml*
(average number present in the drinking water sampled)
- . E. coli - less than 2.5 per 100 ml*

There are cases where the water from a community water supply is bacteriologically acceptable, yet unfit as drinking water due to excessive organic or mineral contents. The main problems are caused by iron and manganese, fluoride, nitrate, turbidity and colour.

Table 3.4 gives guidelines for a number of these and other water quality parameters.

These water quality guidelines should always be applied with common sense, particularly for small community and rural water supplies where the choice of source and the opportunities for treatment are limited. The criteria should not in themselves be the basis for rejection of a groundwater source having somewhat higher values for iron, manganese, sulphates or nitrates than in the table. Care must be exercised in respect of toxic substances such as heavy metals. These should be allowed only after expert opinion of the health authorities has been obtained.

Many developing countries are aiming in their actual water supply practice to meet as far as possible the above guidelines that are derived from recommendations formulated by the World Health Organization.

* Statistically determined as most probable number (M.P.N.), or measured by membrane count.

Table 3.4.
Guidelines for drinking water quality

Water Quality Parameter	measured as	highest desirable level	maximum permissible level
Total dissolved solids*	mg/l	500	2000
Turbidity	FTU	5	25
Colour	mg Pt/l	5	50
Iron	mg Fe ⁺ /l	0.1	1.0
Manganese	mg Mn ⁺⁺ /l	0.05	0.5
Nitrate	mg NO ₃ ⁻ /l	50	100
Nitrite	mg N/l	1	2
Sulphate	mg SO ₄ ⁻ /l	200	400
Fluoride	mg F ⁻ /l	1.0	2.0
Sodium	mg Na ⁺ /l	120	400
Arsenic	mg As ⁺ /l	0.05	0.1
Chromium (hexavalent)	mg Cr ⁶⁺ /l	0.05	0.1
Cyanide (free)	mg CN ⁻ /l	0.1	0.2
Lead	mg Pb/l	0.05	0.10
Mercury	mg Hg/l	0.001	0.005
Cadmium	mg Cd/l	0.005	0.010

* This includes the major dissolved solids such as SO₄⁻, Cl⁻, HCO₃⁻, Ca⁺⁺, Mg⁺⁺ and Na⁺. The levels indicated depend on the climate, the type of food, and the work load of the water user. In some recorded cases, people have lived for months on water having a total dissolved solids content in excess of 5000 mg/l.

Although the water supply agency concerned may undertake to carry out the necessary tests on water quality on a regular basis, final approval and control of drinking water quality should remain with the health authorities.

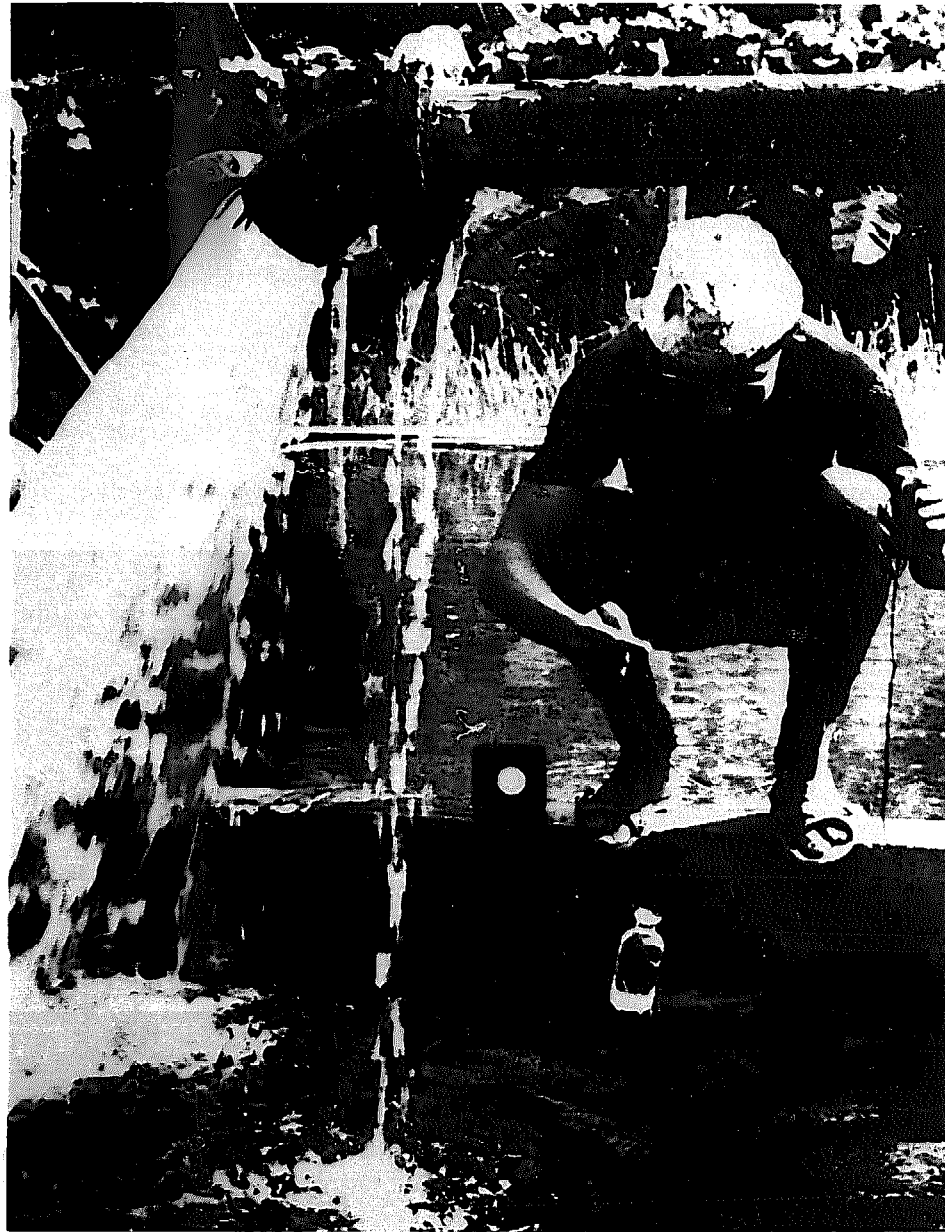

United Nations Photo

Figure 3.1.
Water Sampling (Gabon)

For small supplies which frequently are to be provided from individual wells, boreholes or springs, the water quality criteria given above, may have to be relaxed. Obviously, in all instances, everything possible should be done to limit the hazards of contamination of the water. Using relatively simple measures such as the lining and covering of a well,

it should be possible to reduce the bacterial content of water (measured as coliform count) to less than 10 per 100 ml, even for water from a shallow well. Persistent failure to achieve this and particularly if *E. coli* is repeatedly found, should as a general rule lead to condemnation of the supply. **

For the adequate interpretation of chemical and bacteriological analyses of drinking water supplies, a sanitary survey is essential. Many potential hazards can be detected by a careful study of the water source, the treatment works and the distribution system. No bacteriological and chemical tests can be substituted for a complete knowledge of the water supply system and the conditions under which it has to operate. Samples represent a single point in time and, even when samples are taken and analysed regularly, contamination may not be revealed especially when it is intermittent, seasonal and random.

Guidelines for sanitary surveys are given in Annex 1, where essential factors are listed that should be investigated or considered.

** International Standards for Drinking Water
(3rd Edition); World Health Organization, Geneva, 1971.

Water quantity and quality

Camp, T.R.

WATER AND ITS IMPURITIES

Reinhold Book Corp., New York, 1968

Chalapatioa, U.

PUBLIC HEALTH ASPECTS OF VIRUSES IN WATER

In: *Journal of the Indian Water Works Association*, 1975, No 1, pp. 1-7

Giroult, E.

ENSURING THE QUALITY OF DRINKING WATER

In: *WHO Chronicle*, 1977, No. 8, pp. 316-320

INTERNATIONAL STANDARDS FOR DRINKING WATER

World Health Organisation, Geneva, 3rd revised edition, 1971, 70 p.

LES VIRUS HUMAIN DANS L'EAU, LES EAUX USEES ET LE SOL

Organisation Mondiale de la Santé, Geneva, 1979

(Rapport Technique 639)

Pescod, M.D.; Hanif, M.

WATER QUALITY CRITERIA FOR TROPICAL DEVELOPING COUNTRIES

Asian Institute of Technology, Bangkok, 1972, 11 p.

Ponghis, G.

MINIMUM REQUIREMENTS FOR BASIC SANITARY SERVICES IN HUMAN SETTLEMENTS IN DEVELOPING COUNTRIES

World Health Organisation, Geneva, 1972

Rajagopalan, S.; Shiffman, M.A.

GUIDE ON SIMPLE SANITARY MEASURES FOR THE CONTROL OF ENTERIC DISEASES

World Health Organisation, Geneva, 1974

SIMPLIFIED PROCEDURES FOR WATER EXAMINATION - A LABORATORY MANUAL

American Water Works Association, New York, 1975, 158 p.
(supplement published in 1977)

SURVEILLANCE OF DRINKING WATER QUALITY

World Health Organisation, Geneva, 1976, 135 p.
WHO Monograph Series No. 63)

Tebbutt, T.H.Y.

PRINCIPLES OF WATER QUALITY CONTROL (2nd Edition)

Pergamon Press, 1977

White, J.F.; Bradley, D.J.; White, A.U.

DRAWERS OF WATER: Domestic water use in East Africa

The University of Chicago Press, Chicago, 1972

4. water sources

4.1 Water occurrence and hydrology

The first step in designing a water supply system is to select a suitable source or a combination of sources of water. The source must be capable of supplying enough water for the community. If not, another source or perhaps several sources will be required.

The water on earth, whether as water vapour in the atmosphere, as surface water in rivers, streams, lakes, seas and oceans, or as groundwater in the sub-surface ground strata is for the most part not at rest but in a state of continuous recycling movement. This is called the hydrological cycle (Fig. 4.1.).

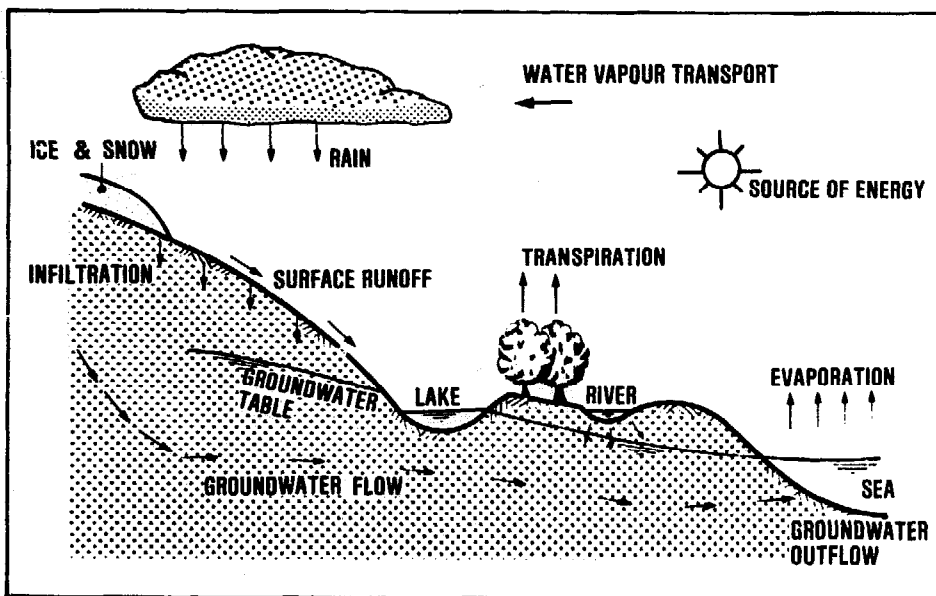

Figure 4.1.
Hydrological cycle

The driving forces are the sun's energy and the earth's gravity. Water from the atmosphere falls to the ground as rain, hail, sleet and snow or condenses on the ground or on the vegetation. Not all this water adds to surface or groundwater resources, as part of it evaporates and returns directly to the atmosphere. Another part is intercepted by the vege-

tation or is retained on the ground, wetting the topsoil.

Water accumulating on the ground in pools and marshes is exposed to evaporation*. Part of the accumulated water flows as surface runoff towards streams, rivers and lakes. Another portion infiltrates into the ground. This water may flow either at shallow depth underneath the ground to open water courses, or it percolates further downward to reach deeper groundwater strata. Neither the shallow nor the deep groundwater is stagnant; it flows underground in the direction of the downward slope of the groundwater table. Sooner or later the water emerges again at the surface, either in the form of a spring or as a groundwater outflow in a river or lake. From the streams, rivers, lakes, seas and oceans, the water is returned to the atmosphere through evaporation. The whole recycling process then begins again.

By far the greatest part of the water on earth is found in the oceans and seas. However, this water is saline. The amount of fresh water is less than 3%, about two thirds of which is locked in ice caps and glaciers. The fresh water contained in the underground and in all lakes, rivers, streams, brooks, pools and swamps amounts to less than 1% of the world's water stock.

Most of this liquid fresh water is in the underground, an estimated 6,000,000 km³ of groundwater up to 50 metres deep, and a further 2,000,000 km³ at greater depth. Contrary to popular belief, the amount of fresh water in lakes, rivers and streams is small, about 200,000 km³ of water. The atmosphere contains only 13,000 km³ of water. Table 4.1 provides an overview of the average precipitation and evaporation rates for the various continents.

Global and continental hydrological data, however, is of little use to the water supply engineer, apart from reminding him that all water resources are inter-

* Evaporation occurs from any water surface. Transpiration is loss of water from plants. All plants take water through their roots; it is expelled through transpiration from the leaves.

Table 4.1.
Precipitation and evaporation rates by continent

Continent	Precipitation mm/year	Evaporation mm/year	Run-off mm/year
Africa	670	510	160
Asia	610	390	220
Europe	600	360	240
North America	670	400	270
South America	1350	860	490
Australia and New Zealand	470	410	60
Mean values derived after weighting according to area	725	482	243

connected and are part of the global hydrological cycle. He needs information regarding the amount of rainfall, the flow of rivers and streams, the quantity and depth of groundwater, and evaporation rates. This information is rarely available so that it will be necessary to take field measurements or extrapolate data from such records as available.

4.2 Quality of water sources

Both surface water and groundwater largely originate from rainfall. All rainwater contains constituents that are taken up or washed out from the atmosphere. Atmospheric gases are dissolved in the rainfall droplets. Above oceans and seas, salts are taken up from the fine spray over the water surface. Over land areas, particularly in dry regions, dust particles are washed out.

Rainwater is usually slightly acidic due to its reaction with carbon dioxide (CO_2) in the atmosphere to form carbonic acid. When rainwater contacts gaseous pollutants in the atmosphere like sulphur dioxide (e.g. from volcanoes, industry), it may become quite acidic causing problems of corrosion and bitterness of taste. In rural areas, however, this is not a common problem.

After reaching the ground surface, rainwater forms surface runoff or groundwater flow. It will pick up considerable amounts of mineral compounds and of

organic matter, debris from vegetation and animal origin, soil particles and micro-organisms. Fertilizers and pesticides may be picked up in areas where they are used in agriculture. While flowing underground, the water will leach out constituents from the ground strata, in particular carbonates, sulphates, chlorides, calcium, magnesium and sodium salts. Thus, the total dissolved solids content of the water is increased. At the same time, filtration takes place removing suspended solids. Some organic substances are biologically degraded. Adsorption and other processes may result in the removal of bacteria, and of suspended and dissolved solids.

Where considerable amounts of organic matter are present, either in the subsoil (e.g. peat) or in the infiltrating water, the oxygen content of the underground water may be exhausted through microbial processes. As a result, certain chemical reactions may be taking place through which ammonia and hydrogen sulfide are formed from the nitrates and sulphates present in the ground. Similarly, iron and manganese would be dissolved in the water.

When groundwater is present at a shallow depth (e.g., less than 10 metres) it may be polluted from sources of faecal contamination such as pit latrines or septic tanks. Pathogenic bacteria and viruses from such sources can be carried by the groundwater, although they tend to attach themselves by adsorption to the solid ground particles. When assessing the possible health hazards of groundwater sources, one should pay more attention to the travel-time of the water through the ground strata than to the distance the water has to flow to the point of withdrawal. In limestone, karstic formations and fissured rock, human contamination may be carried over a distance of several kilometres. In sand formations, groundwater flow is much slower so that only contamination from nearby sources need to be considered when selecting the point of groundwater withdrawal.

Surface runoff as well as groundwater ultimately will reach streams, rivers and lakes where the water is open to pollution from human and animal life, vegetation, plants and algae. Many rivers in tropical areas have high amounts of suspended solids and turbidity, especially under flood conditions. The quality of this water varies considerably with rainfall. In the dry season, organic matter frequently gives a colouring to the river water.

In surface water the processes of self-purification are important. Aeration will bring oxygen from the atmosphere into the water with a simultaneous release

of carbon dioxide. In lakes and reservoirs suspended matter settles out, so that the water will become clear. Organic matter will be consumed through bio-chemical processes, and there will be a dying-off of intestinal bacteria, viruses, and similar micro-organisms. Generally, the water can recover its original quality, if no further pollution is introduced. However, lakes sometimes are subject to excessive growth of algae. 'Hafirs', small dams and ponds have similar features. Almost all surface water will require some treatment before it can be used for drinking and domestic purposes.

4.3. Water source selection

The process of choosing the most suitable source of water for development into a public water supply largely depends on the local conditions. Where a spring of sufficient capacity is available, this may be the most suitable source of supply.

Where springs are not available, or not suited to development, generally the best option is exploring groundwater resources. For small supplies simple prospecting methods will usually be adequate. For larger supplies, more extensive geo-hydrological investigations using special methods and techniques are likely to be needed. Infiltration drains may be considered for shallow ground-water sources. Dug wells can be appropriate for reaching groundwater at medium depth. Tubewells are generally most suitable for drawing water from deeper water-bearing ground strata. However, there are conditions where tubewells can be used with advantage for tapping shallow groundwater sources.

Dug wells often are within the local construction capabilities, whereas the drilling of tubewells will require more sophisticated equipment and considerable expertise. In some cases, drilling may be the only option available. If groundwater is not available, or where the costs of digging a well or drilling a tubewell would be too high, it will be necessary to consider surface water from sources such as rivers, streams or lakes. Surface water will almost always require some treatment to render it safe for human consumption and use. The costs and difficulties associated with the treatment of water, particularly the day-to-day problems of operation and maintenance of water treatment plants, need to be carefully considered.

Where the rainfall pattern permits rainwater harvesting, and storage during dry periods can be provided, rainwater harvesting may serve well for household and small-scale community supplies. With large ground catchment areas, considerable quantities of water may be obtained. Rainwater is sometimes used in conjunction with other sources to supplement another supply, particularly if the latter is poorly maintained and suffers from breakdowns.

Water sources

Balek, J.
HYDROLOGY AND WATER RESOURCES IN TROPICAL AFRICA
Elsevier Scientific Publishing Co., Amsterdam, 1978

Bear, J.; Issar, A.; Litwin, Y.
ASSESSMENT OF WATER RESOURCES UNDER CONDITIONS OF SCARCITY OF DATA In: **Water Supply, Proceedings of the Conference on Rural Water Supply, April, 1971,**
University of Dar-es-Salaam, pp. 151-186

GROUNDWATER IN AFRICA
United Nations, New York, 1973, 170 p.
(ST/ECA/147 Sales No. E71.11.16)

GROUNDWATER IN THE WESTERN HEMISPHERE
United Nations, New York, 1976, 337 p.
(ST/ECA/35 Sales No. E76.11.A.5)

Hammer, M.J.; MacKichan, K.A.
HYDROLOGY AND QUALITY OF WATER RESOURCES
John Wiley & Sons Ltd., Chichester, 1980, 408 p.

Institute of Water Engineers
MANUAL OF BRITISH WATER ENGINEERING PRACTICE, Vol. II
W. Heffer & Sons, London

Jain, J.K.
INDIA: UNDERGROUND WATER RESOURCES
In: *Phil., Trans. Royal Society, London, (1977), pp. 505-524*

James, L.D.
ECONOMICS OF WATER DEVELOPMENT IN LESS DEVELOPED COUNTRIES
In: *Water Supply and Management, Vol. 2(1978), No. 4, pp. 737-386*

Leeden, F. v.d. (Ed.)
WATER RESOURCES OF THE WORLD, SELECTED STATISTICS
Water Information Centre, Inc., Port Washington, 1975, 232 p.

MORE WATER FOR ARID LANDS
National Academy of Sciences, Washington, D.C. 1974, 153 p.

Rodda, J.C.; Downing, R.A.; Law, F.M.
SYSTEMATIC HYDROLOGY
Newnes-Butterworth, London, 1976

Stern, P.H.
RURAL WATER DEVELOPMENT IN ARID REGIONS
Paper presented at IAWPR Symposium: Engineering, Science and Medicine in the prevention of Tropical Water Related Disease; London, 1978.
In: *Progress in Water Technology, Vol. 2(1979) Nos. 1 and 2.*

United Nations
RESOURCES AND NEEDS, ASSESSMENT OF THE WORLD WATER SITUATION
In: Water Supply and Management, Vol.1, No. 3, 1977, pp. 273-311
(Principal Background Paper E/Conf. 70/CBP/1 of UN Water
Conference)

Wilson, E.M.
ENGINEERING HYDROLOGY
MacMillan Book Co., London, 1971 (3rd edition).

5. rainwater harvesting

5.1 Rainwater as a source of water supply

In several parts of the world, rainwater catchments and storage reservoirs have been constructed since ancient times and some have been preserved to this day. Rainwater is harvested as it runs off roofs, or over natural ground, roads, yards, or specially prepared catchment areas. Historical sources mention the use of rainwater for domestic water supply some 4000 years ago in the Mediterranean region. Roman villages and cities were planned to take advantage of rainwater for drinking water supply. In the hills near Bombay in India, the early Buddhist monastic cells had an intricate series of gutters and cisterns cut into the rock to provide domestic water on a year-round basis.

In many countries in Europe and Asia rainwater harvesting was used widely for the provision of drinking water, particularly in rural areas. In some countries it is still being practised. However, where piped water supplies have been provided, the importance of rainwater as a source of supply has diminished.

On some tropical islands rainwater continues to be the only source of domestic water supply. In arid and semi-arid areas where people mostly live in scattered or nomadic settlements, rainwater harvesting can be a necessary means of providing water for domestic purposes. This is especially the case where groundwater resources are unavailable or costly to develop. In developing countries rainwater is sometimes used to supplement the piped water supply.

Rainwater harvesting should be considered in countries where rainfall is heavy in storms of considerable intensity, with intervals during which there is practically no or very little rainfall. It requires adequate provision for the interception, collection and storage of the water. Depending on the circumstances the catchment of the water is on the ground, or the runoff from roofs is collected.

5.2 Roof catchments

Reasonably pure rainwater can be collected from house roofs made of tiles, slates, (corrugated) galvanised iron, aluminium or asbestos cement sheeting. Thatched or lead roofs are not suitable because of health hazards. With very corrosive rainwater, the use of asbestos cement sheeting for roof catchment requires some caution. Asbestos fibers may be leached from the roof material leading to relatively high asbestos concentrations in the collected rainwater. Plastic sheeting is economic but often not durable. Newly developed roofing materials are bituminous felt and sisal-reinforced paper. Painting the roof for water-proofing may impart taste or colour to the collected rainwater, and should be avoided. Fig. 5.1. shows a simple roof catchment.



Figure 5.1.
Simple roof catchment and storage (Thailand)

IRC Photo

The roof guttering should slope evenly towards the downpipe, because if it sags, pools will form that can provide breeding places for mosquitoes.

Dust, dead leaves and bird droppings will accumulate on the roof during dry periods. These will be washed off by the first new rains. It may be helpful to

arrange the downpipe so that the first water from each shower (the "foul flush") can be diverted from the clear water container and allowed to run to waste.

To safeguard the quality of the collected rainwater, the roof and guttering should be cleaned regularly*. A wire mesh should be placed over the top of the downpipe to prevent it from becoming clogged with washed-off material.

An arrangement for diverting the first rainwater running from the roof is shown in Fig. 5.2.

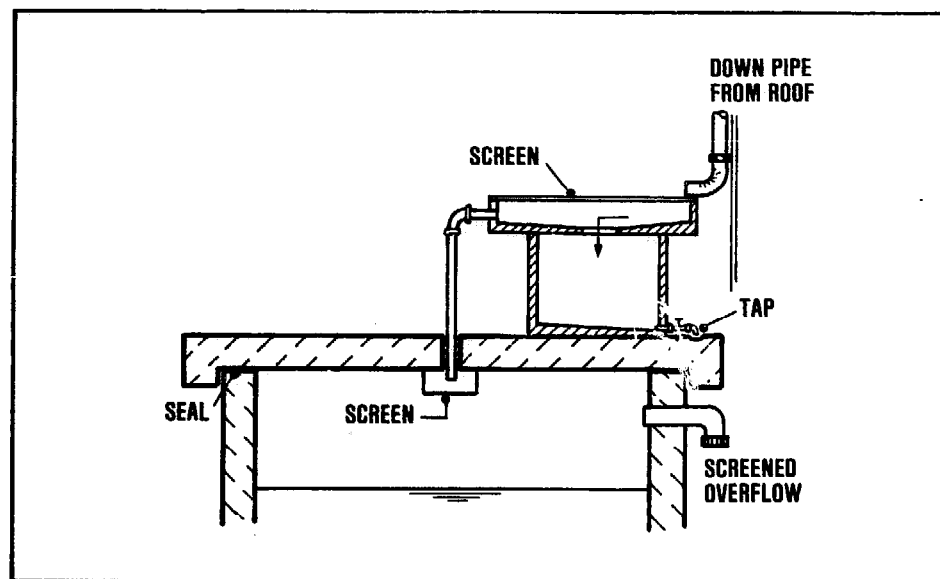

Figure 5.2.
Arrangement for diverting the 'first foul flush'

Another arrangement is an under-ground storage tank receiving rainwater that overflows from a vessel placed above the ground (Fig. 5.3). The surface vessel thus occasionally contributes water to the underground tank.

* Bird droppings have been reported to cause health hazards (salmonellosis) in Jamaica.

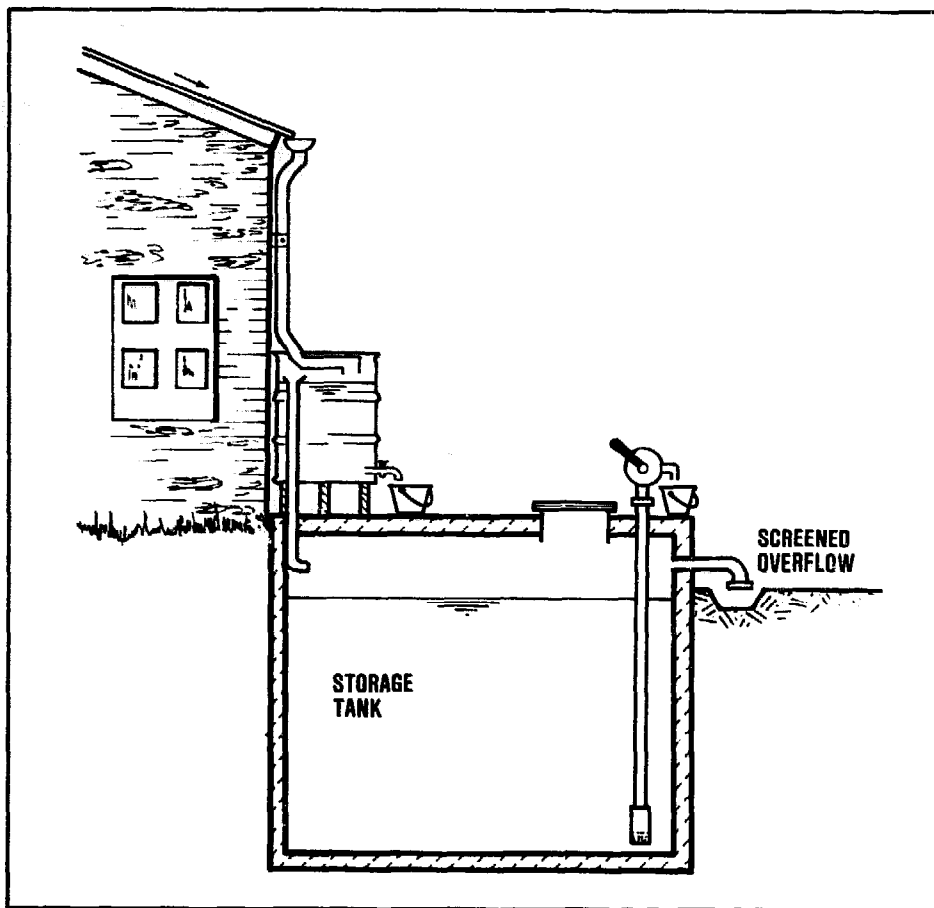

Figure 5.3.
Roof catchment and storage of rainwater
(withdrawal by handpump)

The size of the roof will depend on the size of the house. The quantity of rainwater that can be collected through roof catchment, will be largely determined by the effective area of the roof and the local annual rainfall. One millimetre of rainfall on one square metre of roof will yield about 0.8 litres of water, allowing for evaporation and other losses.

For a roof measuring 5m x 8m (in plan), and assuming an average annual rainfall of 750 mm, the amount of rainwater which can be collected in a year may be estimated as:

$$5 \times 8 \times 750 \times 0.8 = 24,000 \text{ litres/year}$$

$$\text{or: } \frac{24,000}{365} = 66 \text{ litres/day on average.}$$

To allow for conditions in years that are drier than average and also for dry seasons of exceptional duration, the roof and storage should have about 50% surplus yield over the basic water requirements of the people who will be dependent on the supply. With a sufficient storage, the roof catchment could in a dry year still provide some 40 litres/day which is the basic drinking and domestic water requirement of a family of 6 persons.

One can estimate the required storage volume by working out the amounts of water that will be used by the family household in the longest season which may pass without rainfall. For short dry periods the needed storage volume will be small and can probably be provided in the form of a simple wooden vessel, an oil drum or an other suitable container. Where rainfall varies widely during the year, dry seasons of considerable duration need to be anticipated.

For an average dry season of 3 months the storage volume required would be: $3 \times 30 \times 40 = 3600$ litres. To allow for longer periods without rainfall in extremely dry years, a 50% surplus should be provided and the storage volume would thus have to be 5400 litres.

5.3 Ground catchments

Ground catchments are used for collecting rainwater runoff. Part of the rainfall will serve to wet the ground, is stored in depressions, or is lost through evaporation or infiltration into the ground. A considerable reduction of such water losses can be obtained by laying tiles, concrete, asphalt or plastic sheeting to form a smooth impervious surface on the ground. Another method involves chemical treatment of the soil surface. Sometimes simply compacting the surface is adequate.

The amount of rainwater that can be collected in ground catchments will be dependent on whether the catchment is flat or sloping, and the watertightness of the top layer. Through preparation of the ground surface, a sufficiently rapid flow of the water to the point of collection and storage can be assured in order to reduce evaporation and infiltration losses.

The portion of rainfall that can be harvested ranges from about 30% for pervious, flat ground catchments,

to over 90% for sloping strip catchments covered with impervious materials.

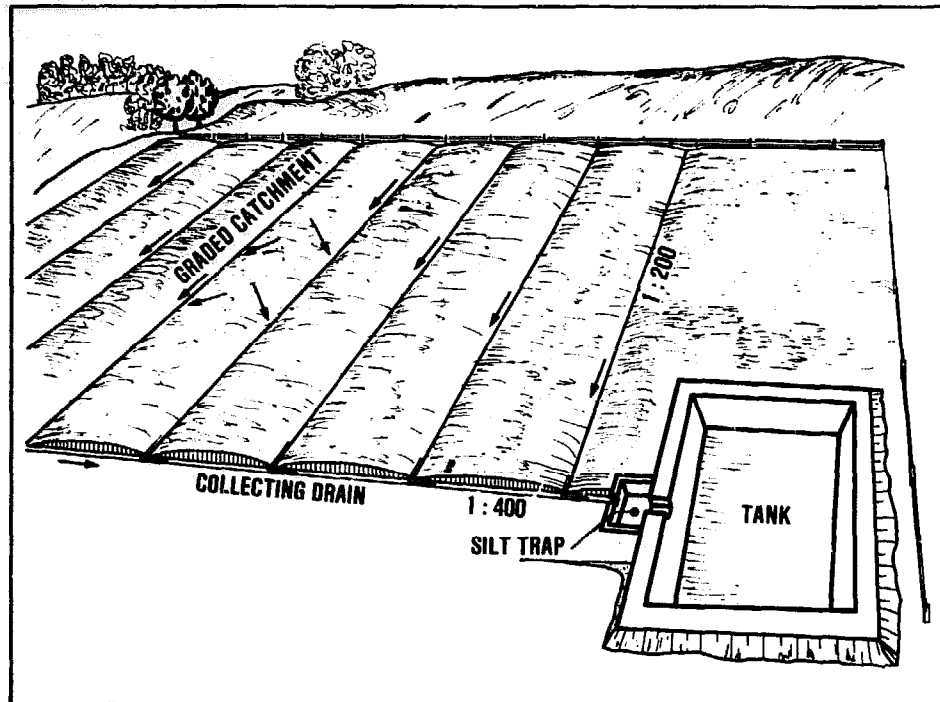

Figure 5.4.
Ground catchment

Land alteration involves the construction of ditches along contours, the clearing of rocks and vegetation, and simple soil compaction. Attempts are often made to achieve reduced infiltration losses of rainwater in the ground catchment area. In rolling hills careful soil compaction may be sufficient to attain good catchment efficiency. In flat terrain a subdivision in small, sloping strips will be needed with such special preparation of the ground surface as appropriate.

Where the surface of the ground catchment is to be covered, various materials may be used. Tiles, corrugated iron sheets, asphalt, cement, or even materials such as heavy butyl rubber or thick plastic sheets may be considered. When properly applied, these materials can give good water catchment efficiency with a yield as high as 90% of the rainfall runoff from the catchment area. Additional advantages are low maintenance and long useful life.

However, these materials are generally too expensive for use over large ground catchment areas. Catchment surface coating methods that may save costs, are being tested. These include:

- Asphalt in two coats (sealant and protection); reinforcement with plastic or fibreglass and covered with gravel; and,
- Paraffin wax spread as granules which melt in the sun.

Thin plastic membranes covered with 1-2 cm gravel or bonded to the ground surface by a bitumen tar are much cheaper but they are easily damaged by sharp stones, plant roots, or animals, and repairs are difficult to make. The water yield of such membrane-lined ground catchment sometimes proves disappointing (not higher than 30-50% of the rainfall). Good results can probably be obtained by treating the top soil layer of the ground catchment area with chemicals. Sodium salts may be applied converting clay particles to form an impervious layer, or a bitumen or tar coating may be sprayed over the ground to block the soil pores. Such a treatment need not be expensive and can be repeated at regular intervals (once every few years) in order to maintain the watertightness of the ground catchment.

Treated ground catchments of sufficient size can provide a domestic water supply for a number of families or even a whole village community but they need proper management and maintenance, and protection against damage and contamination. It may be necessary to provide fencing or hedging. An intercepting drainage ditch at the upper end of the catchment area, and a raised curb around the circumference would be needed to avoid the inflow of polluted surface runoff. A grass cover may be used to reduce erosion of the ground catchment although this will result in a lower yield. Trees and shrubs surrounding the catchment area can be planted to limit the entry of wind blown materials and dust into the ground catchment area.

5.4 Storage

Storage facilities can be above-ground or below-ground. Whichever type of storage is selected, adequate enclosure should be provided to prevent any contamination from humans or animals, leaves, dust or other pollutants entering the storage container. A tight cover should ensure dark storage conditions so

as to prevent algal growth and the breeding of mosquito larvae. Open containers or storage ponds are generally unsuitable as sources of drinking water.

There is a wide choice of materials for the construction of water storage containers. For small storage volumes, vessels made of wood, cement, clay or water-proofed frameworks may be used.

Below-ground storage facilities have the general advantage of being cool, and they will suffer practically no loss of water through evaporation. There can also be a saving in space and cost of construction where the container is moulded directly in the ground by simply compacting the earth. An example is shown in fig. 5.5.

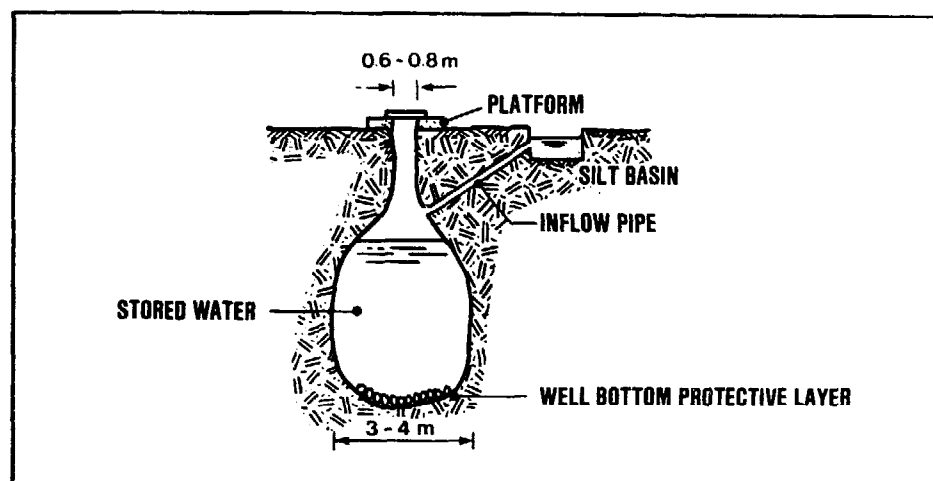

Figure 5.5.
Underground rainwater storage well
(as used in China)

Cement applied by hand may be used for plastering the walls of the excavation, or simple plastic sheeting. Storage tanks consisting of bee-hive structures (Fig. 5.6) have been built in various countries (e.g. Sudan, Botswana, Swaziland, Brazil, Jamaica) to volumes of 10,000 litres. Polythene tubes filled with a weak cement mixture and sealed at the ends, are laid in place before the mixture sets; this will allow them to readily take up the required shape. The sides of these tanks are polythene-lined.

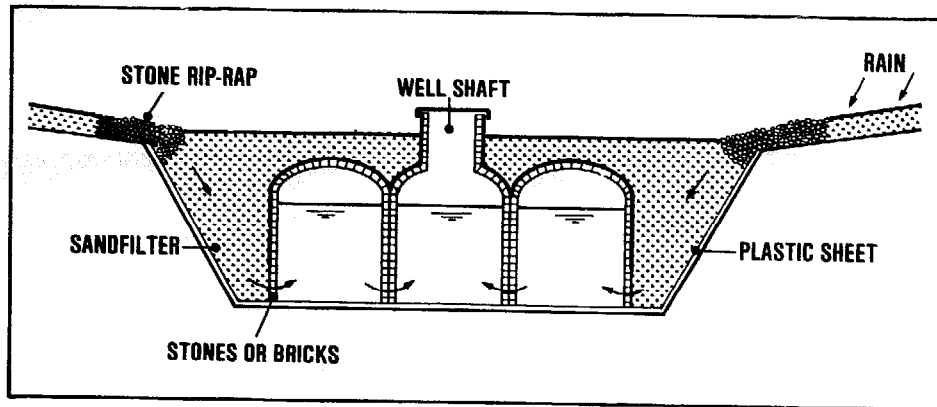

Figure 5.6.
Cistern built of polythene tubes

Two more examples of rainwater storage are shown in fig. 5.7. and fig. 5.8.

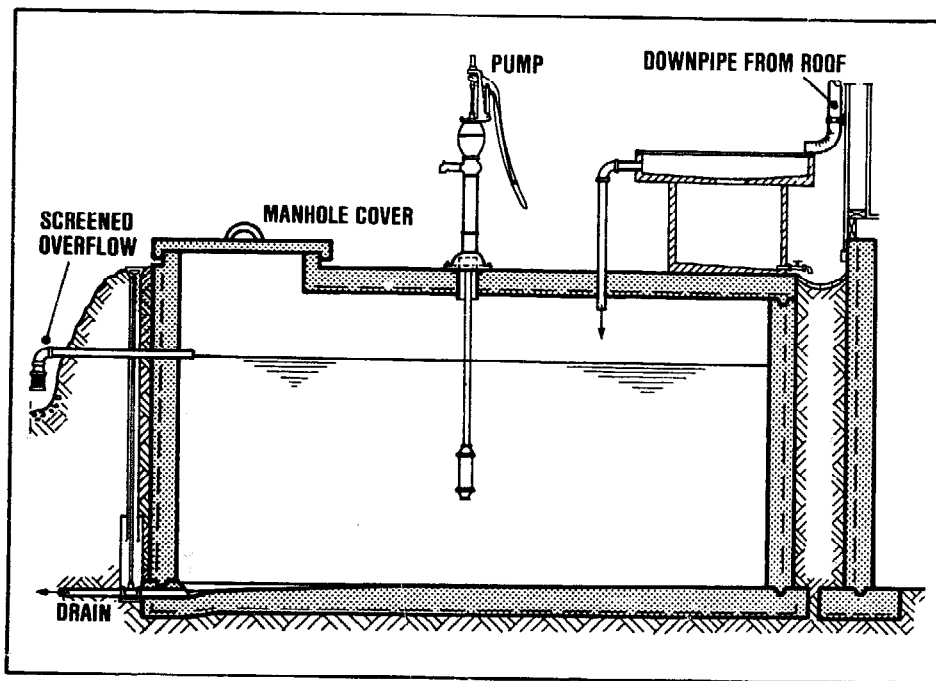

Figure 5.7.
Rainwater storage arrangement

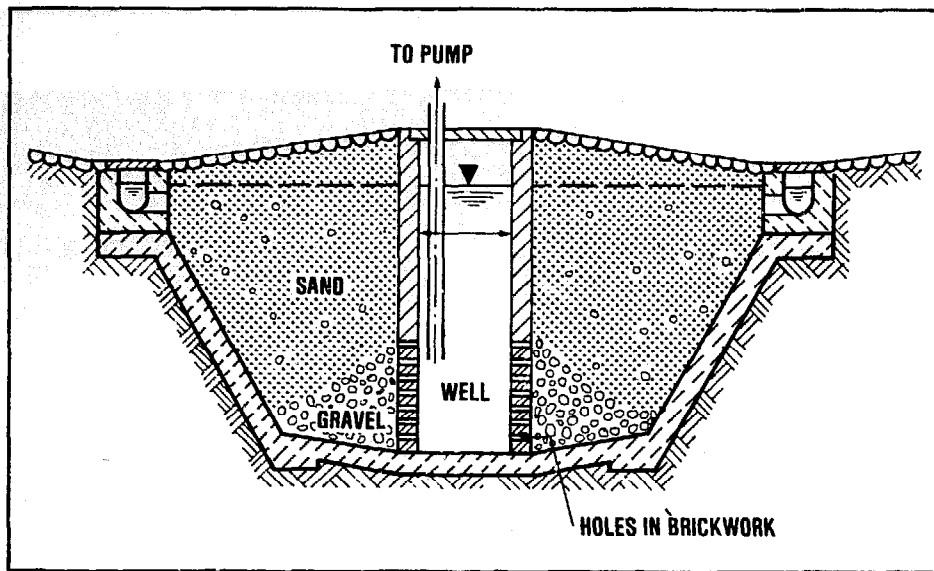

Figure 5.8.
Venetian Cistern

The cylindrical wooden rainwater barrel was a familiar sight in most western countries until the advent of piped water supplies. These containers may be specially constructed for rainwater storage, but suitable food stuff or beverage vessels may be utilized just as well after they have served their original purpose.

Relatively thin-walled cement containers can be built for moderate rainwater storage volumes. A tapered form has been developed by UNICEF, in Kenya, in which a simple cloth bag is used as the basis for a wall 3 cm thick or even less. Containers providing up to 2,500 litres storage volume can be built in this way.

In many parts of Africa, Asia and Latin America, clay is available. Clay can be used to build suitable rainwater storage containers of limited volume. Simple glazing techniques should be useful in improving the impermeability of the clay pot or barrel walls.

Water-proofed frameworks (e.g., from bamboo, or twigs) can be built by lining woven baskets with cement, mortar or plastic. Using a tapered form, full enclosure of the storage vessels should be accomplished easily.

In the construction of metal storage tanks, the most common material is galvanized iron sheets which are readily riveted and softsoldered. To avoid deformation of the tank when filled, a framework (wood, steel etc.) is required. These tanks can, in some instances, be incorporated as part of the wall structure or foundation of buildings.

Corrugated iron tanks have the advantage of being self-supporting. Tanks of this type for storage volumes up to 10,000 litres are found in Africa and Australia. Their construction is not difficult but a special 'roller' machine is required unless the corrugated iron sheets can be prepared manually. Local craftsmen can be trained to build these tanks in sizes suitable to the local requirements.

For larger storage volumes, tanks or cisterns constructed of brick or stone masonry are used most. Typically the walls are cylindrical and bonded by cheap lime mortar or more expensive cement mix. Where large storage volumes are built, and certainly for tank heights exceeding 2 m, reinforcement along the outside edges becomes necessary. This can be conveniently provided by means of one or more tightened steel bands around the outer circumference of the tank. The roofing of this type of tank is commonly provided by placing some suitable cover (e.g., galvanized iron sheets) over a supporting framework.

Reinforced concrete tanks are used in many areas. Double-walled formwork is used in their construction. Reinforcing material, usually steel mesh or bars, are positioned in the space and the concrete mix is poured in. The formwork can be removed when the concrete has hardened enough, usually after one full day or so. The formwork should then be deployed again for building another tank. This is necessary because the formwork represents a substantial initial investment; it must be economically utilized several times for which organisational measures are required. Reinforced concrete tanks have the advantage of great durability and they can, in principle, be built to any desired size. Because of their structural strength such tanks can be used as part of the walls or foundation of a building.

Bamboo reinforced concrete tanks have been successfully built in countries where bamboo is available in suitable length, size and strength (e.g. China, Indonesia, Thailand). Increasingly popular are ferro-cement tanks in which wire is used for the reinforcement of walls and bottom that are formed by plastering cement. Such tanks are quite economical.

5.5 Water quality preservation

Where storage tanks or cisterns are built below ground, special provision must be made to prevent dust, sand, leaves, insects or other pollutants from entering. For the same reason, the inlet and outlet opening and any air vents should be fitted with screens.

An intercepting ditch should be provided to drain off any excess surface runoff.

During storage, the quality of the rainwater collected from the roof or ground catchment may deteriorate through the putrefaction of organic material in the water, or through growth of bacteria and other micro-organisms. Measures to protect the quality of the stored water include the exclusion of light from the stored water, cool storage conditions, and regular cleaning. Simple disinfection devices such as the pot chlorinator (see Chapter 17) may be very useful in rainwater storage containers.

In theory, the prefiltration of collected water prior to its storage would be desirable, but in practice filters are not very effective for the required intermittent operation. Nevertheless, an example is shown in Fig. 5.9.

The boiling of water drawn from the storage before it is used for drinking or food preparation, would be desirable but it is often not practicable. In some places, a little bag containing a coagulant is suspended in the storage tank to flocculate the suspended solids in the water. The water drawn from the storage tank has a clear appearance, but its bacteriological safety is not assured.

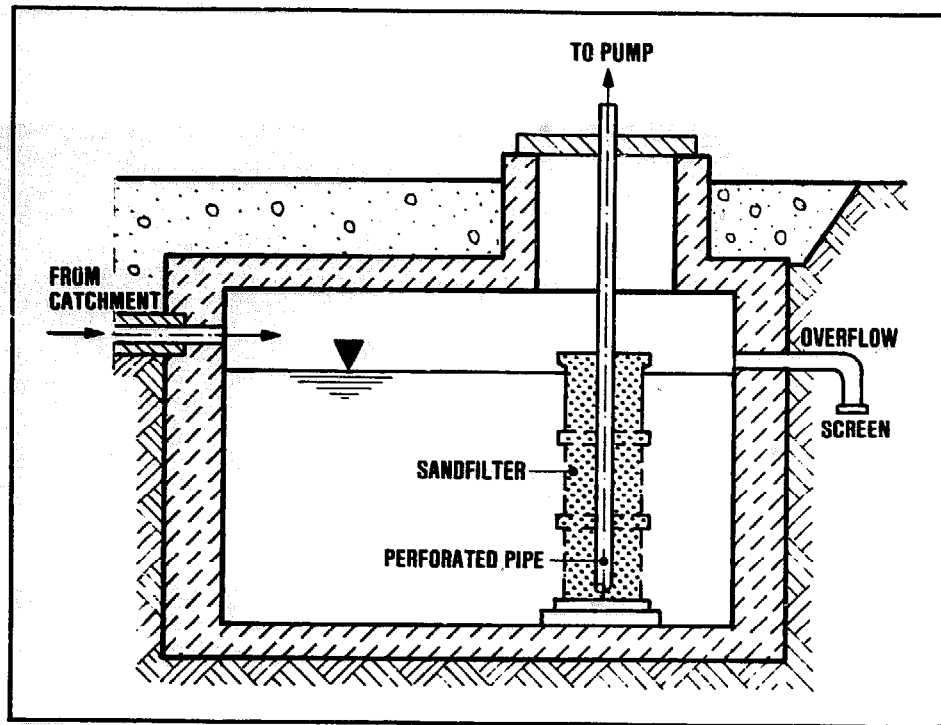

Figure 5.9.
Withdrawal of filtered rainwater from storage

Rainwater harvesting

Environmental Protection Agency
INDIVIDUAL WATER SUPPLY SYSTEMS
U.S. Government Printing Office, Washington, D.C., 1973

Grover, B.
HARVESTING PRECIPITATION FOR COMMUNITY WATER SUPPLY
World Bank, Washington, D.C., 110 p.

Ionides, M.
WATER IN DRY PLACES
Engineering, London, 1967, pp. 662-666

Johnson, K.; Renwick, H.
RAIN AND STORMWATER HARVESTING FOR ADDITIONAL WATER SUPPLY IN RURAL AREAS: Component review of North America
United Nations Environment Programme, Nairobi, 1979.

Maddocks, D.
AN INTRODUCTION TO METHODS OF RAINWATER COLLECTION AND STORAGE
In: *Appropriate Technology*, Vol. 2(1975) No. 3, pp. 24-25

Maddocks, D.
METHODS OF CREATING LOW-COST WATERPROOF MEMBRANES FOR USE IN THE CONSTRUCTION OF RAINWATER CATCHMENT AND STORAGE SYSTEMS
Intermediate Technology Publications Ltd., London, 1975

MORE WATER FOR ARID LANDS
National Academy of Science, Washington, D.C., 1974

RAINWATER CATCHMENT PROJECT JAMAICA
Inter-Technology Service Ltd.; Government of Jamaica
Ministry of Mining and Natural Resources, Water Resources
Division of Foreign and Commonwealth Office
(Overseas Development Administration), London, 1972, 220 p.

RAINWATER AND STORMWATER HARVESTING FOR ADDITIONAL WATER SUPPLY IN AFRICA
University of Nairobi, Department of Geography, Nairobi, 1979

RAINWATER HARVESTING IN INDIA AND MIDDLE EAST
Indian Institute of Science, Department of Civil Engineering
Bangalore (India), 1979

THE INTRODUCTION OF RAINWATER CATCHMENT AND MICRO-IRRIGATION TO BOTSWANA
Intermediate Technology Development Group Ltd., London, 1969, 110 p.

Watt, S.B.
RAINWATER STORAGE TANKS IN THAILAND
In: *Appropriate Technology* Vol. 5 (1978) No. 2, pp. 16-17

6. spring water tapping

6.1 Introduction

Springs are found mainly in mountainous or hilly terrain. A spring may be defined as a place where a natural outflow of groundwater occurs.

Spring water is usually fed from a sand or gravel water-bearing ground formation (aquifer), or a water flow through fissured rock. Where solid or clay layers block the underground flow of water, it is forced upward and can come to the surface. The water may emerge either in the open as a spring, or invisibly as an outflow into a river, stream, lake or the sea (Fig. 6.1). Where the water emerges in the form of a spring, the water can easily be tapped. The oldest community water supplies were, in fact, often based on springs.

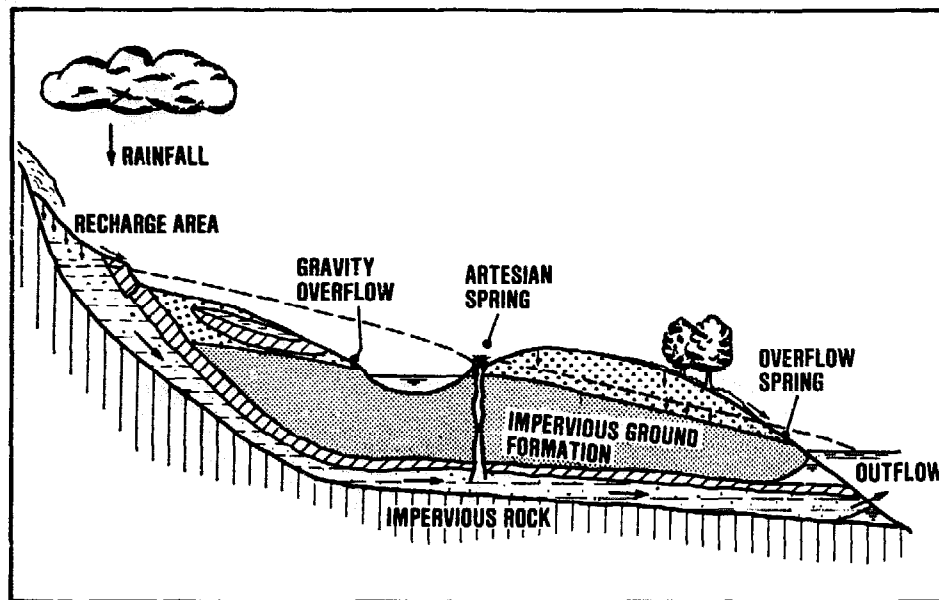

Figure 6.1.
Occurrence of springs

The best places to look for springs are the slopes of hill-sides and river valleys. Green vegetation at a certain point in a dry area may also indicate a

spring, or one may be found by following a stream up to its source. However, the local people are the best guides, as they usually know most springs in their area.

Real spring water is pure and usually can be used without treatment, provided the spring is properly protected with a construction (e.g. masonry, brick or concrete) that prevents contamination of the water from outside. One should be sure that the water is really fed from the groundwater and not a stream that has gone underground for a short distance.

The flow of water from a spring may be through openings of various shapes. There are several names: seepage or filtration springs where the water percolates from many small openings in porous ground; fracture springs where the water issues from joints or fractures in otherwise solid rock; and, tubular springs where the outflow opening is more or less round. However, to understand the possibilities of water tapping from springs, the distinction between gravity springs and artesian springs is most important. A further sub-division can be made into depression springs and overflow springs.

Gravity springs occur in unconfined aquifers. Where the ground surface dips below the water table, any such depression will be filled with water (Fig. 6.2).

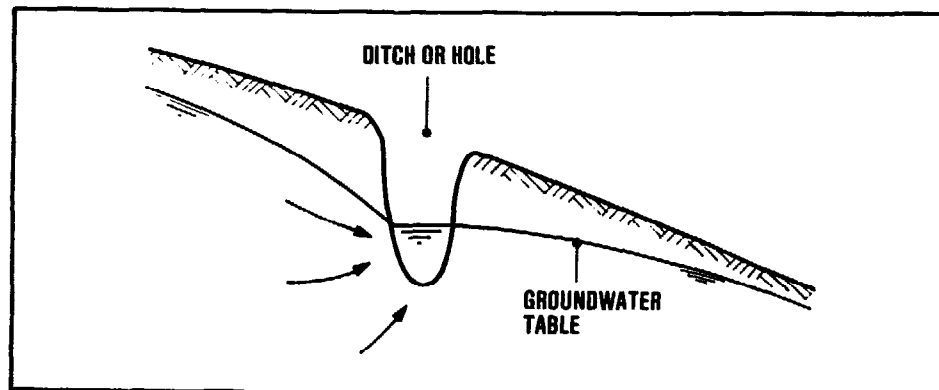

Figure 6.2.
Gravity depression spring

Gravity depression springs usually have a small yield and a further reduction is likely when dry season conditions or nearby groundwater withdrawals result in a lowering of the groundwater table.

A larger and less variable yield from gravity springs is obtained where an outcrop of impervious material, such as a solid or clay fault zone, prevents the downward flow of the groundwater and forces it up to the ground surface (Fig. 6.3). At such an overflow spring, all water from the tributary recharge area is discharged. The flow will be much more regular than the recharge by rainfall. Even so, an appreciable fluctuation of the discharge may occur and in periods of drought some springs may cease to flow completely.

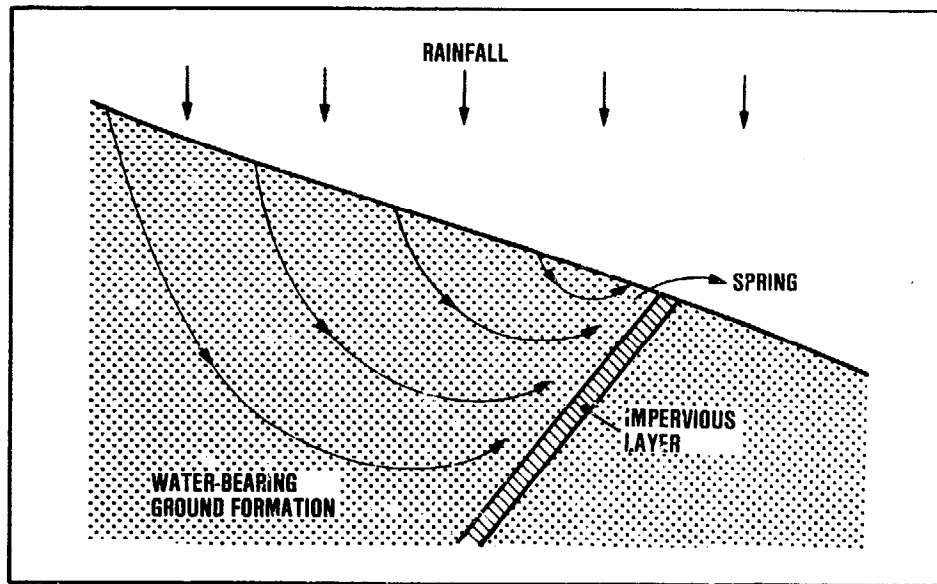

Figure 6.3.
Gravity overflow spring

Artesian* depression springs are similar in appearance to gravity depression springs. However, the water is forced out under pressure so that the discharge is higher and shows less fluctuation. A drop of the artesian water table during dry periods has little influence on the groundwater flow (Fig. 6.4). Artesian fissure springs (Fig. 6.5) form an important variant of this type of spring. They exist in many countries and are widely used for community water supplies.

* Artesian groundwater is groundwater that is by an overlying impervious layer prevented from rising to its free water table level, and therefore is under pressure.

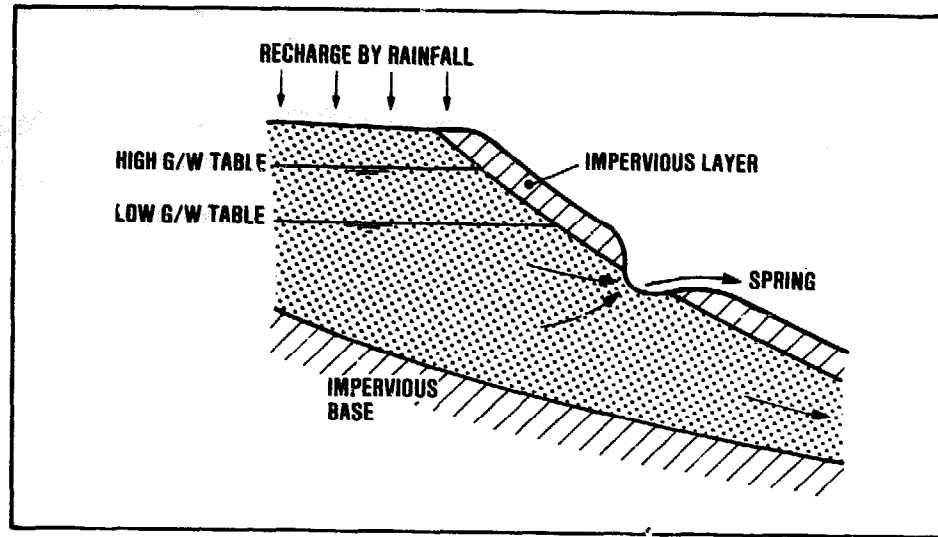

Figure 6.4.
Artesian depression spring

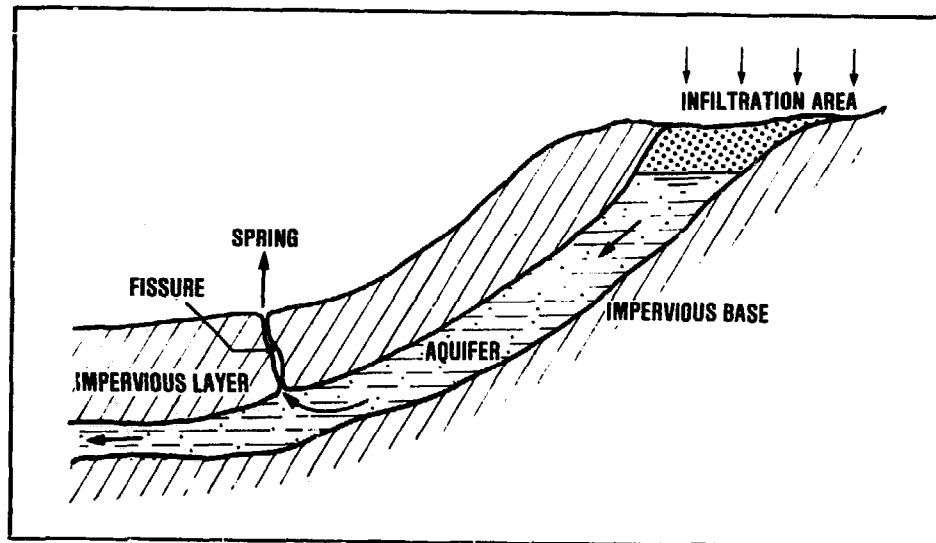

Figure 6.5.
Artesian fissure spring

Artesian overflow springs often have a large recharge area, sometimes a great distance away (Fig. 6.6). The water is forced out under pressure, the discharge is often considerable and shows little or no seasonal fluctuation. These springs are very well suited for community water supply purposes. Artesian springs

have the advantage that the impervious cover protects the water in the aquifer against contamination. The water from these springs will be bacteriologically safe.

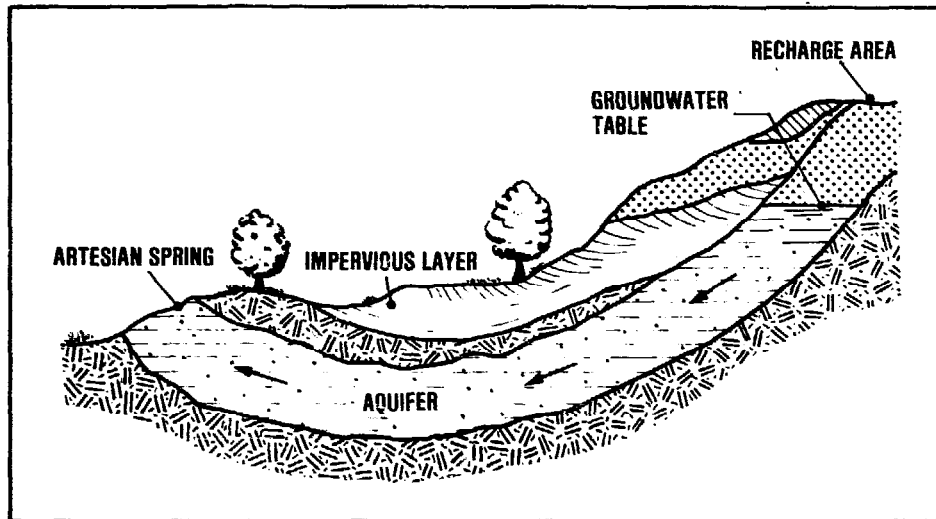

Figure 6.6.
Artesian overflow spring

6.2 Basic considerations

The spring chosen for a supply is to be enclosed in a structure from which a pipe leads down conveying the water to the point of delivery. Four factors are of great importance and should be given careful attention:

1. A sanitary protection to prevent contamination of the spring water in the tapping structure.
2. The quality of the spring water is of importance. In particular with artesian springs, the water will generally be free from pathogenic organisms. However, if the water differs in temperature during the day and the night, the water quality is suspect.

3. In granular aquifers, the outflow will vary little with distance along the contour (seepage springs). To tap this water, infiltration galleries of considerable length will be required but their location is not critical. With fractured rock aquifers, however, the outflow will be concentrated where water carrying fissures reach the ground surface. Small-scale catchment works will probably be adequate but they need to be sited with care.
4. An assessment of the yield of the spring and the seasonal variation of flow are needed. The yield and the reliability of a spring can only be slightly influenced by the construction of the springwater collection works.

Compared with the withdrawal of groundwater as described in Chapter 7, the tapping of spring water has an advantage in that the natural groundwater table will normally be lowered very little, if at all.

6.3 Tapping gravity springs

Because of the small yield and the difficulty of obtaining satisfactory sanitary protection, a gravity depression spring (Fig. 6.2) cannot be recommended for community water supplies. The presence of such a spring, however, indicates shallow groundwater that may be withdrawn using drains or dug wells. These can be covered and protected against contamination.

Gravity overflow springs in granular ground formations can be tapped with drains consisting of pipes, with open joints, placed in a gravel pack. To protect the spring, it is necessary to dig into the hillside so that a sufficient depth of the aquifer is tapped even when the groundwater table is low (Fig. 6.7).

The design of drains follows common engineering practice. They must be laid so deep that the saturated ground above them will act as a storage reservoir compensating for fluctuations of the groundwater table. The water collected by a drain discharges into a storage chamber, which is sometimes referred to as the "spring box" (Fig. 6.8).

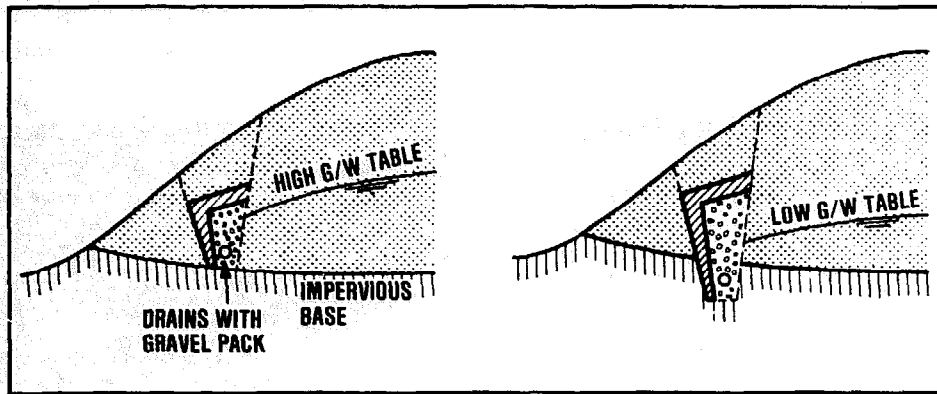

Figure 6.7.
Tapping of a gravity spring

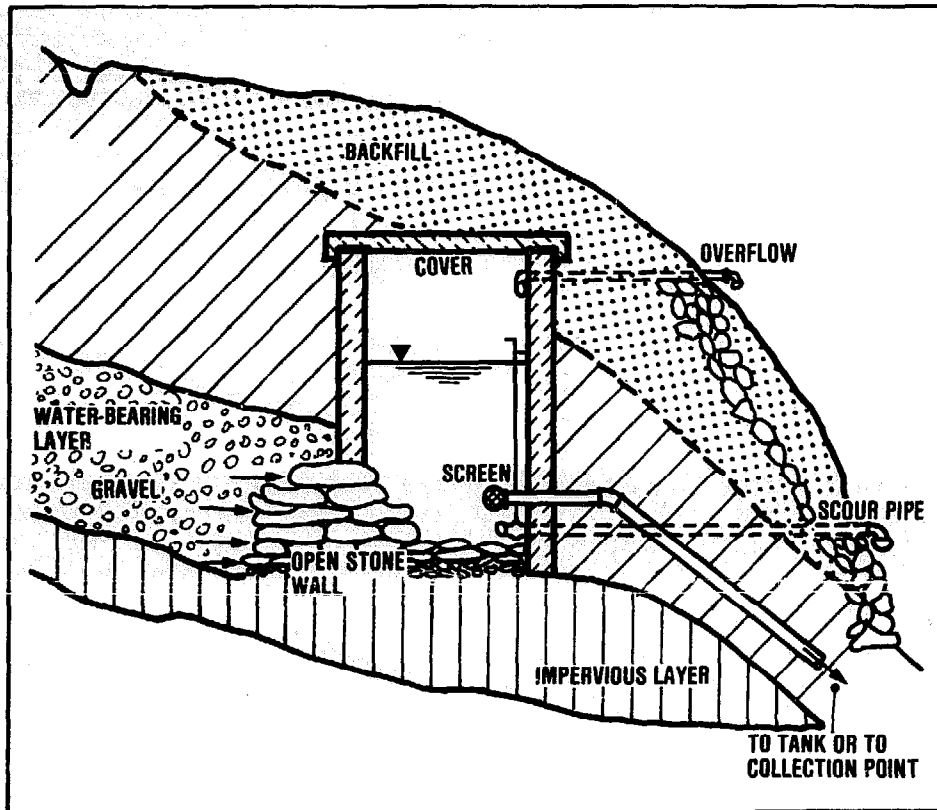

Figure 6.8.
Spring water storage chamber ('spring box')

The drain system and storage chamber should be so constructed that contamination of the collected water is prevented. Before the back of the chamber is built, loose stones should be piled up. These will serve to make a wall, and will prevent the washing away of soil. The chamber should be fitted with a locked, removable manhole cover for cleaning and access for maintenance work. Any air vents, overflow pipes and clean-out drains must have screened openings. A diversion ditch should prevent surface runoff running down the hillside from entering the chamber.

For sanitary protection the top of the gravel pack should be at least 3 metres below ground surface, which may be ensured by locating the spring catchment works in the hillside, or by raising the ground level with backfill from elsewhere. An area extending along the gallery over its full length plus 10 m at each side and, in the other direction, to a distance of at least 50 m upstream, should be protected against contamination from cesspools, manure or pits. This area should preferably be fenced in to prevent ^{the} ~~the~~ passing by people and animals. Above the spring ^{site} ~~site~~ a drainage ditch is required to divert any ^{surface} ~~surface~~ runoff from polluting the collected spring water.

In fractured ^{rock} ~~rock~~ aquifers, pipes packed in gravel may be used, ^{or} ~~or~~ the water may be collected by tunnels, lined (Fig. 6.9) or unlined, depending on the nature of the ^{ground} ~~ground~~ formation. Where fissures convey local high-rate outflows of water, a small spring tapping structure will be adequate (Fig. 6.10). However, in view of the high velocity of water flow through fissures, the area of sanitary protection against contamination should extend over a considerable distance, at least 100 metres and preferably up to 300 m upstream from the gallery.

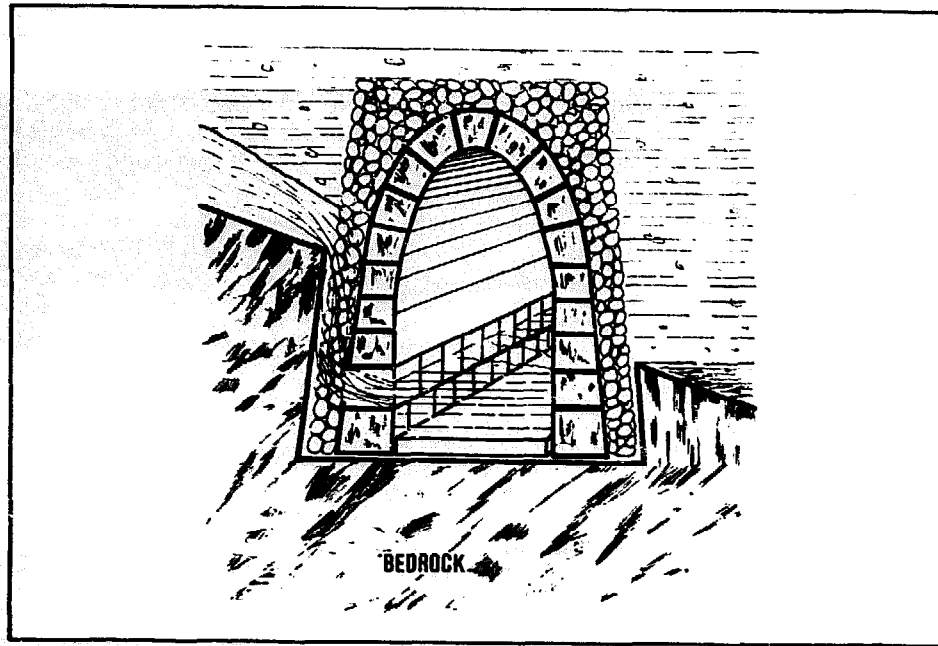

Figure 6.9.
Tunnel for tapping gravity overflow spring

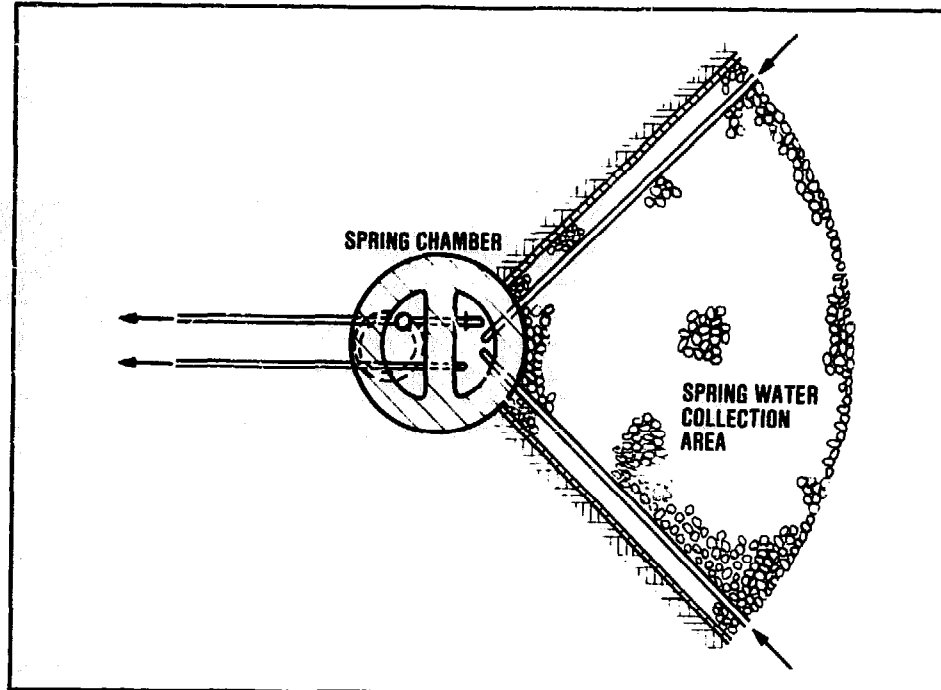

Figure 6.10.
Tapping spring water from a fractured rock aquifer

6.4 Tapping artesian springs

In outward appearance, artesian depression springs are quite similar to gravity depression springs but their yield is greater and less fluctuating, as the water is forced out under pressure.

To tap water from an artesian depression spring, the seepage area should be surrounded by a wall extending a little above the maximum level to which the water rises under static conditions. For sanitary protection the storage chamber should be covered (Fig. 6.11).

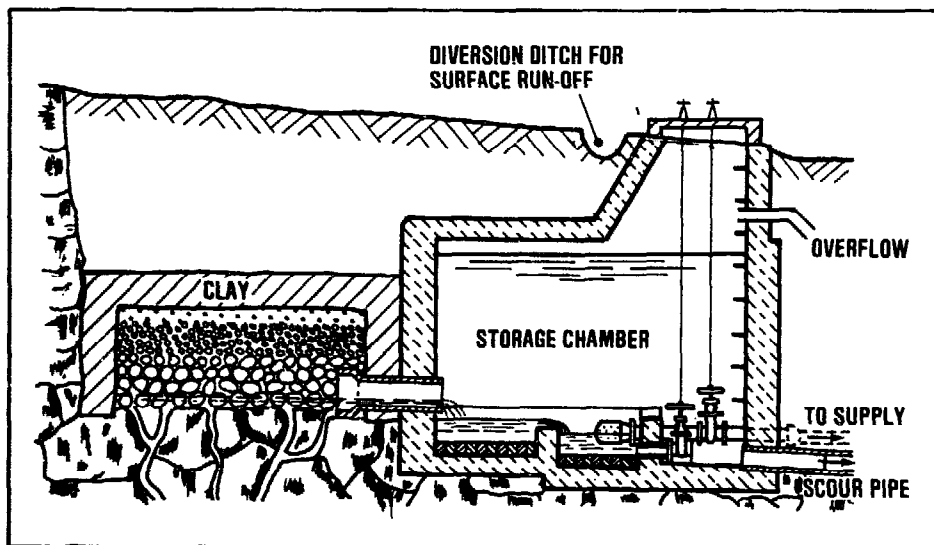

Figure 6.11.
Artesian depression spring

For artesian depression springs of large lateral extent, a system of drains will have to be used discharging the collected water into a storage chamber. From where it flows to the supply area. To increase the infiltration rate and for protection of the water quality, the recharge area should be cleaned of all debris. For granular top layers, it may be necessary to cover the recharge area with layers of graded gravel for the entrapment of fine suspended solids.

Fissure springs belong to the same category as artesian depression springs but the water rises from a single opening so that the catchment works can be small (Fig. 6.12). Some increase in capacity may be obtained by removing obstacles from the mouth of the

spring or by enlarging the outflow opening (Fig. 6.13). Due to the localised outflow of water from the spring, sanitary protection is easy to arrange.

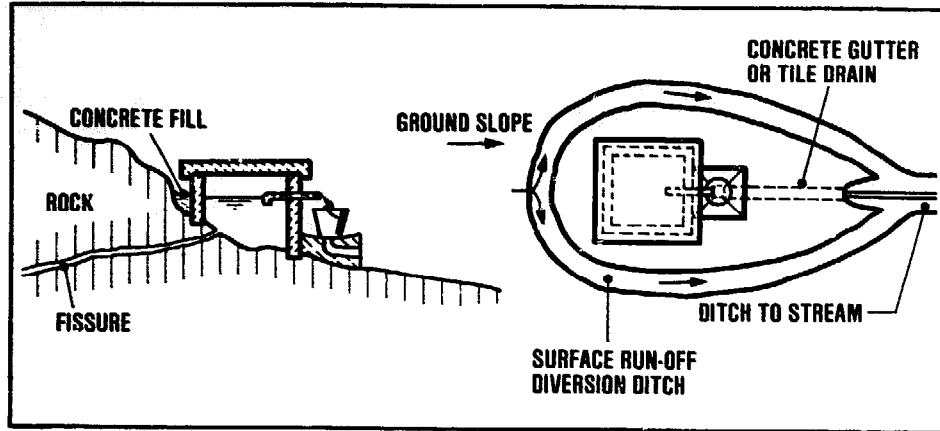

Figure 6.12.
Fissure spring of small capacity

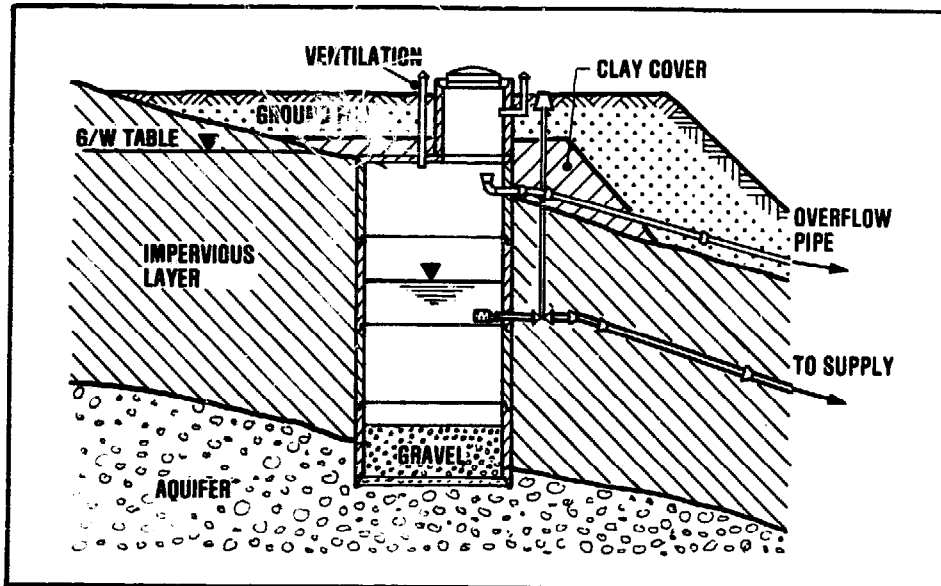

Figure 6.13.
Fissure spring of large capacity

Artesian contact springs often have a large recharge area at a great distance from the spring. The water flows out under pressure and is protected against

contamination by the overlaying impervious layer. The discharge can be large and stable, with little or no seasonal fluctuations. Such springs are excellent sources for community water supply.

Where the outflow of water occurs at only one point, the spring water can be tapped in a small catchment construction. For a large lateral spring, a retaining wall should be constructed over its full width with the abutments (borders) extending into the overlying impervious layers and the base of the wall constructed into the bedrock; in this way leakage of water and any risks of erosion and collapse are avoided. Upstream of the wall, a gallery should be constructed (Fig. 6.14), covered with a layer of clay for sanitary protection. From there the water discharges into the storage tank. Another typical spring tapping structure is shown in Fig. 6.15.

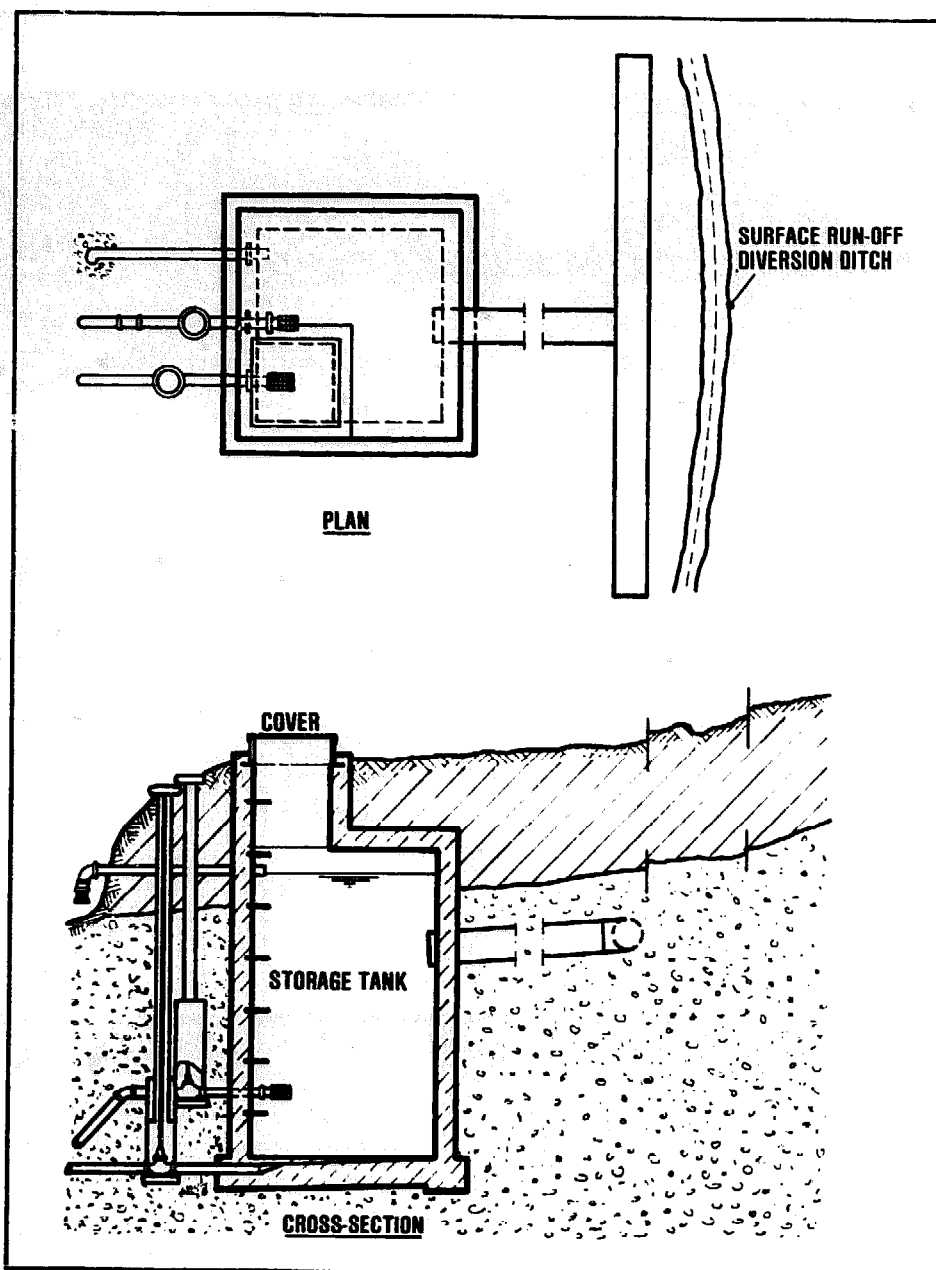

Figure 6.14.
Artesian contact spring of large lateral width

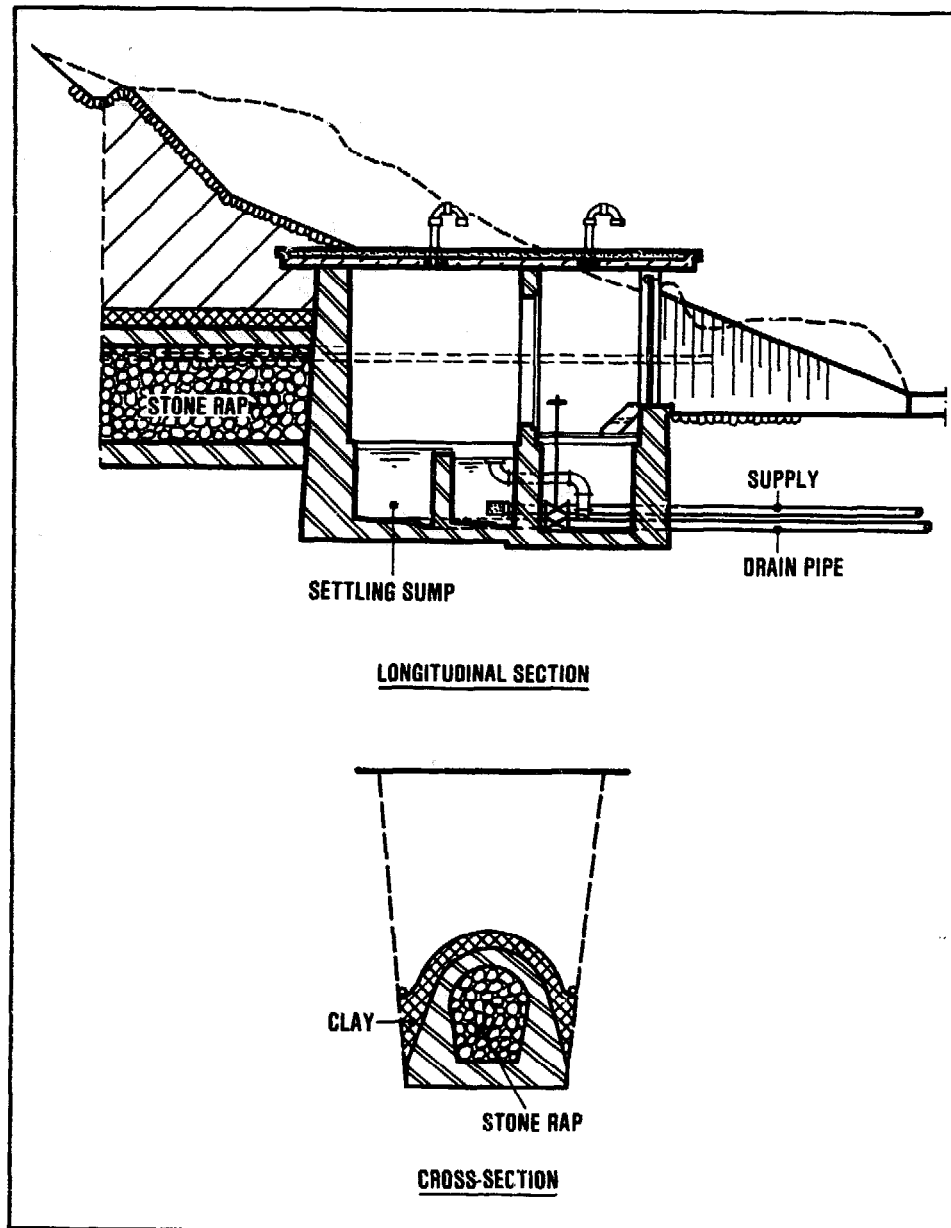

Fig. 6.15.
Typical spring tapping structure

Spring water tapping

Bryan, K.
CLASSIFICATION OF SPRINGS
Journal of Geology, 1919, pp. 522-561

Johnson, C.R.
VILLAGE WATER SYSTEMS
UNICEF, Kathmandu, Nepal, 1976.

MORE WATER FOR ARID LANDS
National Academy of Science, Washington, D.C., 1974

Savary, I.
INVESTIGATION OF SPRINGS: THE MOST EFFECTIVE METHOD FOR ESTIMATING
WATER RESOURCES IN CARBONATE AQUIFERS
In: Proceedings of the International Symposium on Development
of Groundwater Resources, Resources Journal, Vol. 1(1973), pp.
53-62

7. groundwater withdrawal

7.1 Introduction

For community water supply systems, groundwater always should be the preferred source. Surface water sources are very likely to be contaminated and much more subject to seasonal fluctuation. Groundwater withdrawals often can be continued long after drought conditions have depleted the rivers and streams. The utilisation of groundwater for community water supplies is most likely still very much below its potential in many countries.

Frequently, the available data on groundwater resources are grossly inadequate. Successful development of groundwater supplies may then be promoted by prospecting (exploration studies). These would also bring to light the physical and chemical characteristics of the groundwater.

The tapping of groundwater resources, both for drinking water supply and for irrigation purposes, dates back to ancient times. In China, wells were already drilled at least 3,000 years ago with hand-operated churn drills, to depths as great as 100 m and lined with bamboo casings. Hand-dug wells have been sunk since times immemorial, sometimes to a considerable depth, and such wells continue to be made in several parts of the world. The technology for tapping groundwater at great depth through tubewells is of more recent date.

The first type of water well drilling which came into general use was the cable-tool (percussion) method. Over a period of several centuries it developed from crude forms to a number of fairly sophisticated techniques. The need to prevent the collapse of unstable ground formations and the problems of controlling at depth the heavy tools required for percussion drilling, encouraged the development of other drilling methods. These use rotating cutters or "bits" that bore into the ground while a fluid is passed through them (direct-circulation rotary drilling). For water supply wells, the use of a clay-based mud fluid presents a hinderance as the aquifers to be tapped tend to clog up. This led to the development of the reverse-circulation rotary

drilling method in which a high-rate flow of clean water is used to carry the cuttings out of the drilled hole. A later, logical step was the pneumatic tool placed at the bottom of the drill pipe. In the 1950s the "down-the-hole hammer" drilling method was introduced. The efficiency of this tool proved to be remarkable and small-diameter holes, even in hard-rock formations, may now be drilled in a fraction of the time previously required.

No particular water well drilling technique is applicable under all conditions. Each well construction method can be the most suitable depending on the circumstances although the general trend is towards rotary drilling to reduce time and cost. Thus, the techniques for reaching the groundwater range from ancient methods such as the simple digging of wells with hand tools, and the excavation of the famous ganats (underground galleries extending many kilometres) in Iran and Afghanistan, to the sophisticated drilling machines ("drilling rigs") capable of making a tubewell some hundreds of metres deep even in hard-rock formations.

7.2 Groundwater occurrence and prospecting

Prospecting for water requires a basic knowledge of the various kinds of groundwater-bearing formations that can be found in the earth's crust. From this, the approach to their exploration for water supply purposes should be developed.

Occurrence

Groundwater occurs in pores, voids or fissures of ground formations. Pores are the spaces between the mineral grains in sedimentary ground layers and in decomposed rocks. The amount of pore space in a ground formation depends upon such factors as grain size, shape, packing and the presence of cementing material. Porosity is the ratio of pore space to total ground volume (Fig. 7.1). A high porosity does not always indicate good permeability (water-bearing potential).

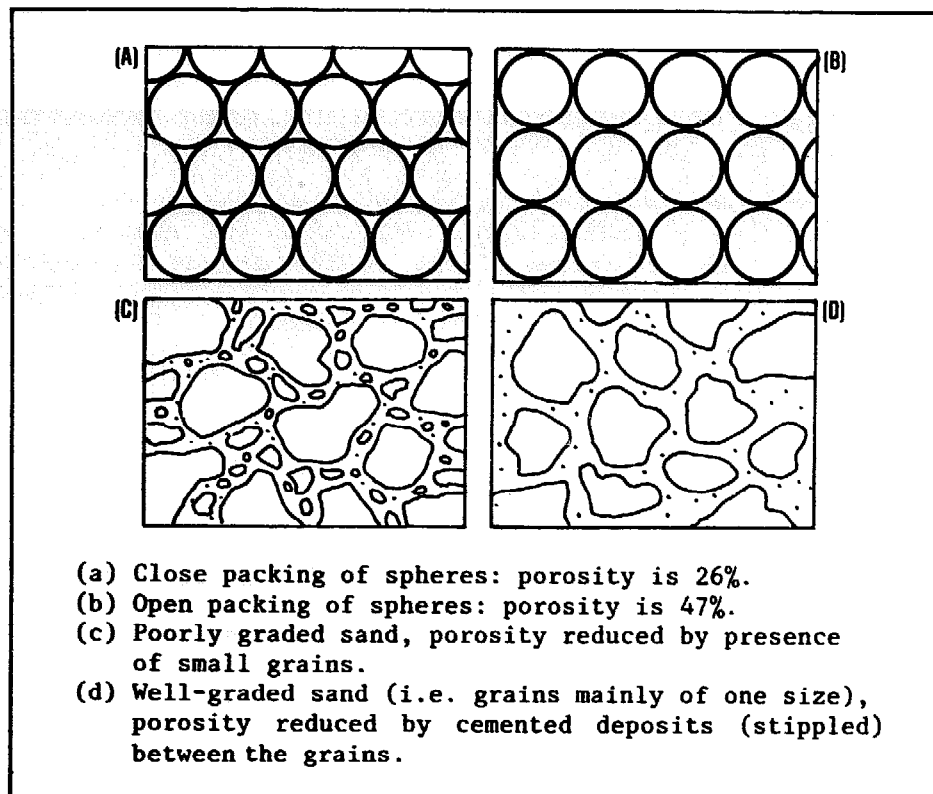

Figure 7.1.
Porosity and texture

Although clays and silts have a high porosity, the size of the pores is too small to allow water to flow easily. All openings in rocks such as joints, bedding, cleavage planes and random cracks are called fissures (in hydrogeological terminology). Igneous* rocks are not generally porous unless they are decomposed by weathering. Lavas which contain cavities formed by gas bubbles that escaped from it during the eruption, can be an exception. Even when a ground formation is highly porous the permeability may be very low because the voids are not always interconnected. Fissures may also occur in sedimentary** rocks.

* Igneous: originating from volcanic erupted material.

** Sedimentary: sediments compacted by (glacial) pressure to form solid material.

Geologically young and unweathered fissures in all types of ground formation tend to be closed and are likely to contain little or no water. As weathering proceeds, the fissures will open up near the ground surface but remain closed at depth.

Aquifers (water-bearing ground formations) which hold most of their water in large joints and fissures are called pervious whereas those with the water in pores are called porous. Table 7.1 shows common ground types and the way water usually occurs in them.

*Table 7.1.
Usual mode of water occurrence*

Ground Type	Water usually occurring in:
Sand and gravel	Pores
Sandstones	Pores and fissures
Limestone	Fissures often expanding into caves
Chalk	Pores and fissures
Clay	Very small pores
Massive Igneous	Fissures with pores in weathered zones
Lavas	Fissures with pores in igneous zones
Metamorphic	Fissures with pores in weathered zones

The ease with which water can flow through a ground formation under a hydraulic head is termed the hydraulic permeability. Hydraulic permeability is expressed as the velocity of flow of water through the ground per unit of hydraulic gradient, e.g. mm/sec, metre/day. It depends on the porosity, the average pore size and the distribution of the fissures (see Table 7.2).

Ground layers with a very low hydraulic permeability (less than about 10^{-6} mm/sec) are said to be impermeable and those with higher hydraulic permeability are regarded as permeable.

Table 7.2.
Porosity and hydraulic permeability for some common ground materials.

Material	Porosity (%)	Hydraulic Permeability Coefficient in mm/sec.
Clay	45-55	10^{-3} - 10^{-9}
Silt	40-50	10^{-2} - 10^{-6}
Sand	35-40	10^{-2} - 10^{-1}
Clean gravel	40-45	10^3 - 10^1
Sandy gravel	25-40	10^1 - 10^{-2}
Sandstone	10-20 (pores)	10^{-4} - 10^{-6}
	(fissures)	10^{-1} - 10^{-6}
Limestone	1-10 (pores)	10^{-6} - 10^{-8}
	(fissures)	10^2 - 10^{-10}
Granite (fresh)	1 (pores)	10^{-10}
	(fissures)	10^2

Fig. 7.3 shows the distribution of water in and above an unconfined aquifer.

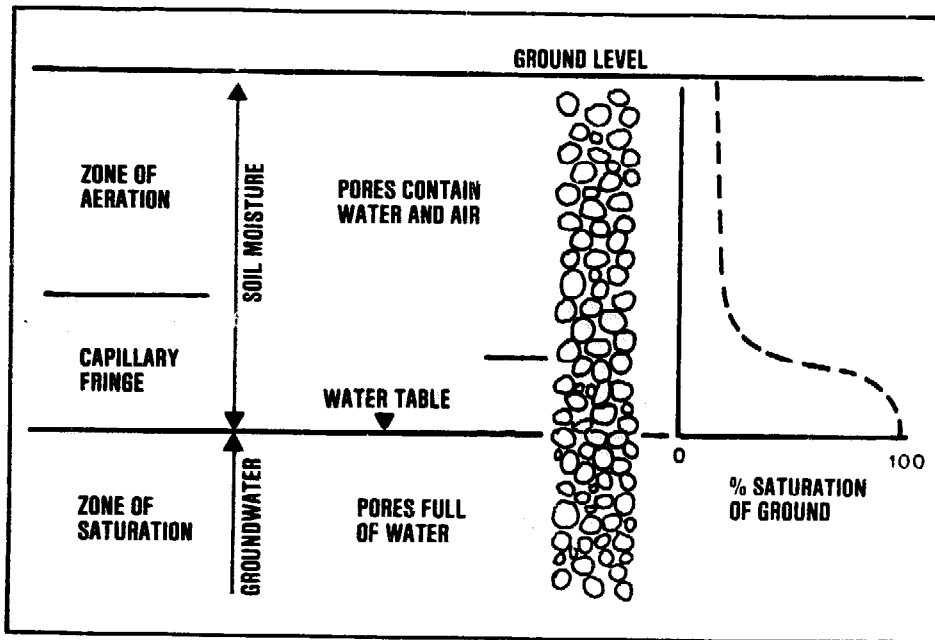

Figure 7.3.
Water distribution above and in a porous unconfined aquifer.

An unconfined aquifer is open to infiltration of water directly from the ground surface. This is illustrated in Figs. 7.4a and 7.4b.

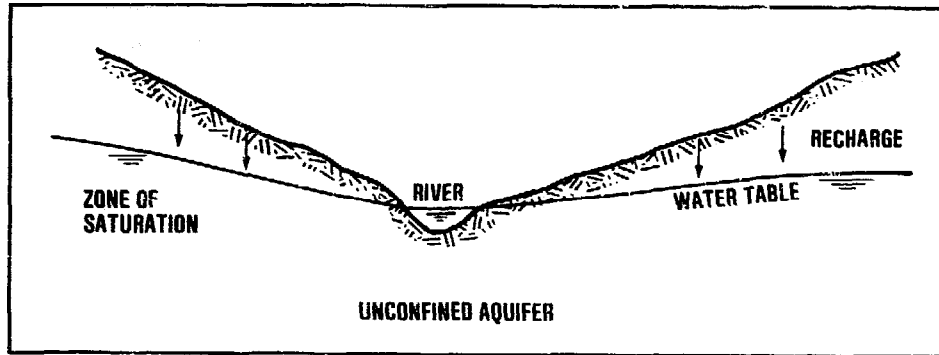

Figure 7.4a
Infiltration of water into an unconfined aquifer during the wet season

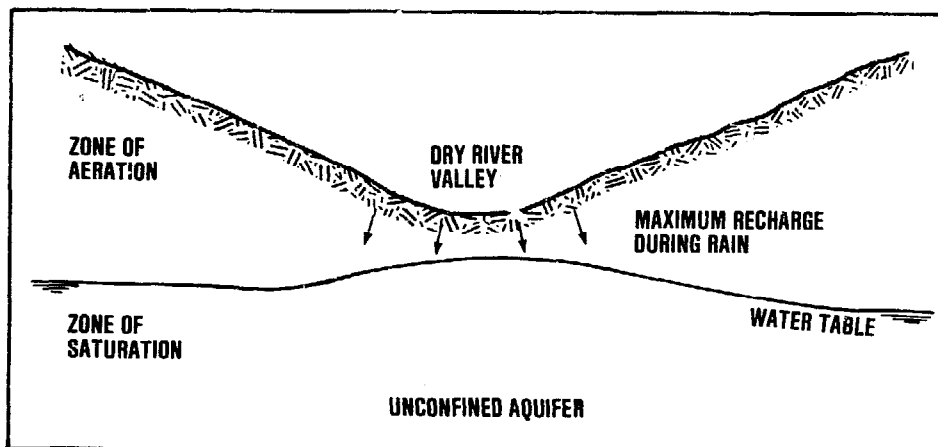

Figure 7.4b
Infiltration of water into an unconfined aquifer during the dry season

A confined aquifer (Fig. 7.5) is one where the water-bearing ground formation is capped by an impermeable ground layer. The water pressure in a confined aquifer is related to the level of its recharge area.

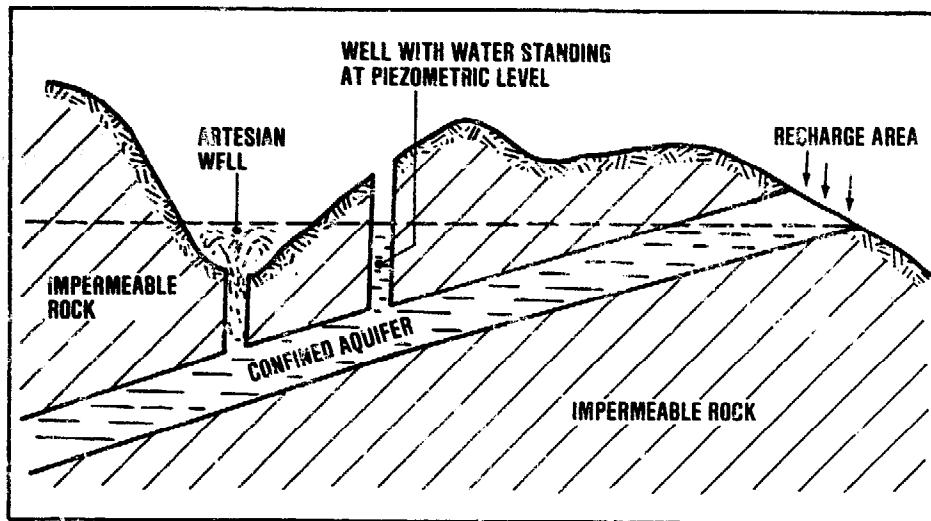

Figure 7.5.
 Confined aquifer fed from a recharge area

The water pressure in a confined aquifer can be measured by drilling into it and observing the level to which the water rises in the borehole. This water level is called the piezometric level. If the piezometric level is above the ground surface, water from the aquifer will be naturally overflowing from the borehole which is then called a (free-flowing) "artesian well".

The infiltration of water from the ground surface through permeable ground towards the groundwater table will be halted where a lens of impervious material such as clay is present (Fig.7.6). Water will then accumulate in the ground above this lens forming a perched water table some distance above the real ground water table. It is very important to identify a perched water table since the amount of water it contains is often small. Frequently perched water tables will disappear during dry periods when there is no recharge by infiltration from the ground surface.

Prospecting

Successful prospecting for groundwater requires a knowledge of the manner in which water exists in the water-bearing ground formations. Without this knowledge, effective and efficient water exploration is

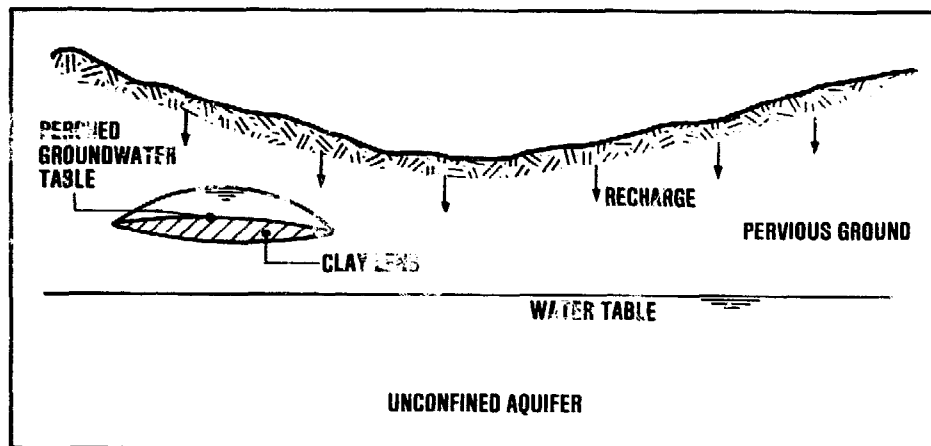

Figure 7.6.
Perched water table

impossible, and well drilling then becomes something like a game of roulette. The aim of the prospecting work must be clearly defined. Is it for providing a small local supply or is it to determine aquifer characteristics for the development of the groundwater resources of an entire area?

The following approach is suggested. The available hydrogeological information about the study area should be collected and collated. This may include: geological maps and reports; topographical maps; logs of tubewells; surface geological reconnaissance; meteorological records; and hydrological data.

To assist in the collection of information a survey of the study area should be made, preferably towards the end of the dry season. In some cases this may be all that is needed for an experienced hydrogeologist to define water sources for small community supplies and no further investigation would be required. If essential data are lacking, some field work would be necessary.

The survey should provide sufficient data to form a basis for the drawing up of a hydrogeological map showing: the distribution of aquifers; any springs or spring lines present; depth of water tables and piezometric levels; yield of existing groundwater sources, and the quality of the water from them. Sometimes, it is possible to prepare such a map on the basis of an examination of outcrops and existing water supplies, in other cases it may involve the use of specially drilled boreholes and geophysics. The

drilling of special test boreholes will usually only be required when an aquifer is to be fully exploited; for this, a knowledge of the hydraulic permeability and water storage capacity is needed.

Geophysical investigations, especially electrical resistivity measurements, are very useful in understanding the distribution and quality of groundwater. The value of the electrical resistance of a ground formation depends upon the amount, distribution and conductivity of the water it contains. Resistivity measurements are made by passing an electric current through the ground between two electrodes and measuring the voltage drop between two other electrodes (Fig. 7.7). The depth of penetration of the current is controlled by the spacing of the electrodes. By increasing the electrode spacing, the current can be made to penetrate deeper, and so a complete resistivity depth probe can be carried out. If a depth probe is done near to an existing well or borehole of which the water level, water quality and aquifer thickness are known, then the correlation between the resistivity values and the hydrogeological conditions can be established. This will provide a basis for the interpretation of resistivity depth probes done in other areas with much the same geology, and will so establish information on water table depth, water quality and aquifer thickness.

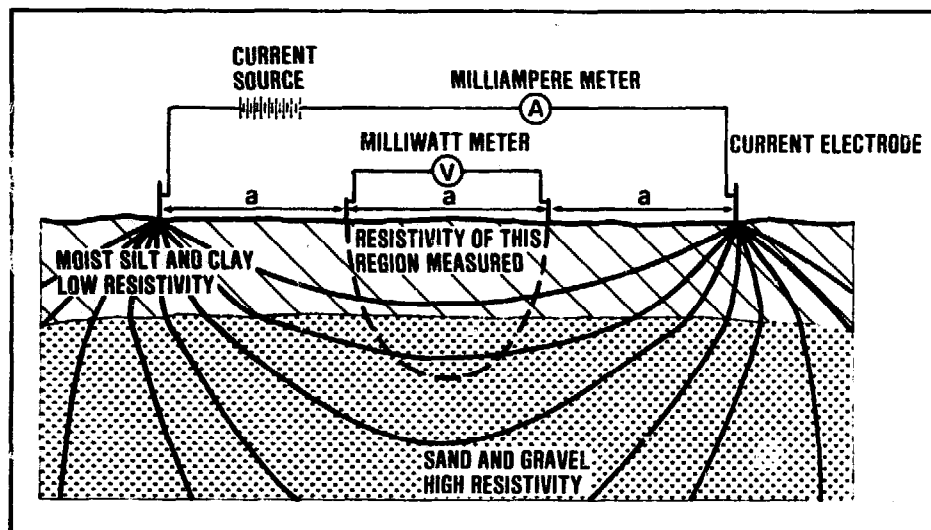

Figure 7.7.
Electrical resistivity measuring arrangement

If resistivity measurements are conducted in a grid pattern over an area, the readings can be plotted on a grid map to form patterns of high and low resistivity for each electrode spacing used. Lines of equal resistivity can then be drawn on the map for identification of areas of low resistivity, which are more likely to be permeable, and water-bearing ground formations than high-resistivity areas.

Sometimes, the drilling of small boreholes for prospecting purposes is required to supplement the data obtained with surface geophysical methods. This method is always expensive, and often difficult to employ. For obtaining the maximum amount of information from a borehole, geophysical logging may be necessary. This involves the lowering of measuring instruments down the borehole for carrying out measurements on ground and water properties. Borehole logging is a complex operation and advice should always be obtained from a geophysicist before it is decided upon. Other, more sophisticated, geophysical techniques for groundwater prospecting are seismic and gravity measurements.

Safe Yield

The safe yield of an aquifer is the maximum permanent withdrawal that can be permanently obtained from a groundwater source. The safe yield of an aquifer is estimated to see whether the planned withdrawal for water supply purposes will be safeguarded in the long run. Basically not more water can be withdrawn than the natural recharge amounts to. Another limitation is that the groundwater table should not be lowered so much that polluted water from elsewhere would be drawn into the aquifer. Sometimes, withdrawal of water from a new well may cause an appreciable reduction of the yield of existing wells nearby. In an area where little is known about the extent and capacity of the aquifer, the new well and any nearby wells should be monitored at least during the early period of operation.

7.3 Methods of groundwater withdrawal

The oldest method of groundwater withdrawal is to dig a hole in the ground, to a depth below the groundwater table. Usually the amount of water that can be collected in this way is quite limited and when more withdrawal capacity is needed, the aquifer must be tapped over a greater area of contact. This may be

done by enlarging the width of the excavation, by extending it to greater depth, or by increasing both the width and depth. Which of these methods can and should be applied in a particular case depends on the thickness of the water-bearing ground formation and on the depth of the groundwater table.

Horizontally extended means for groundwater withdrawal are called galleries and may be subdivided into seepage ditches (Fig. 7.8), infiltration drains (Fig. 7.9) and tunnels (Fig. 7.10).

Because of the difficulties and costs of excavation, galleries should only be used in cases where the groundwater table is at a shallow depth, not more than 5-8 m below the ground surface (tunnels in consolidated ground formation may still be economical at greater depths). Galleries offer the only practical solution when groundwater is to be withdrawn from shallow aquifers with a small saturated thickness. These aquifers have to be tapped over a large contact area. Galleries are also to be recommended in coastal areas where the fresh water to be withdrawn floats on top of underlying salt water. The drawdown* of the fresh water table must then be kept as small as possible, otherwise the salt water would rise and mix with the fresh water.



*Figure 7.8.
Seepage ditch*

* Drawdown: the lowering of the groundwater table around a groundwater collector, resulting from the withdrawal of the water.

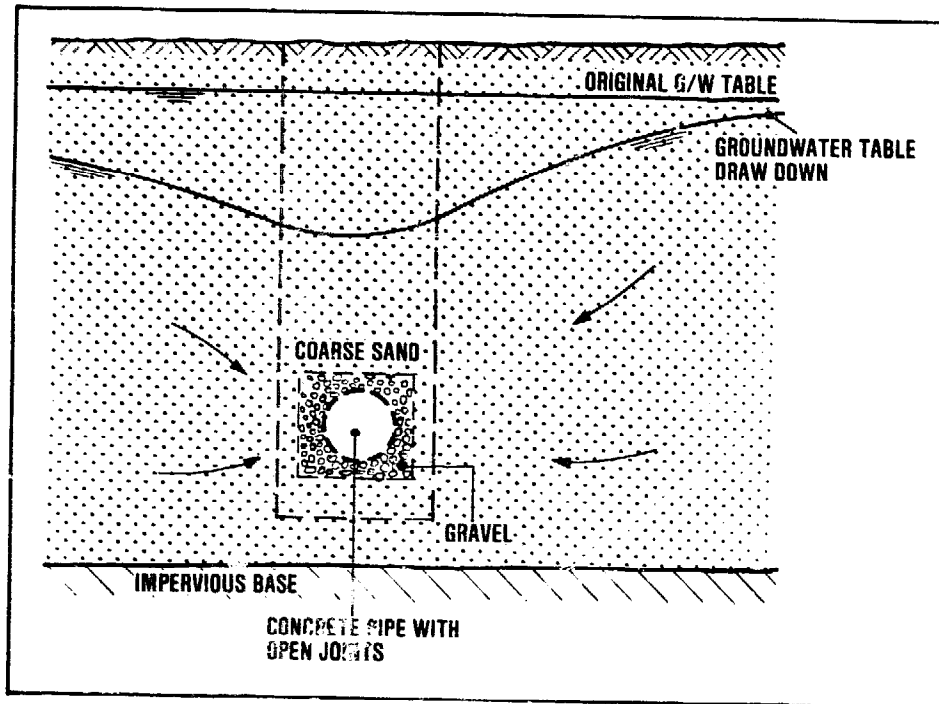

Figure 7.9.
Infiltration drain

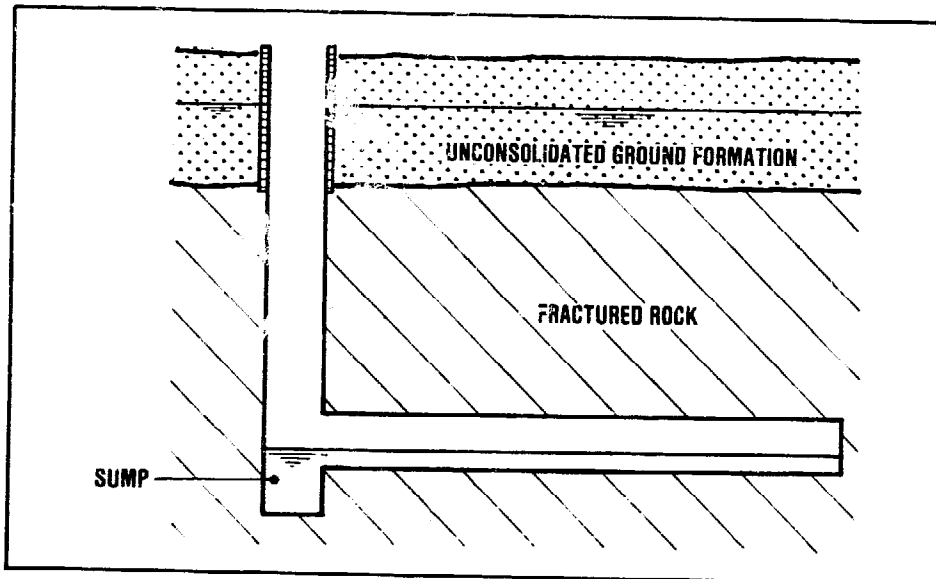

Figure 7.10.
Infiltration tunnel

Ditches are easy to construct, they can have a large capacity and a long useful life. However, ditches being open, the water collected in them is unprotected against contamination which makes them less suited for water supply purposes. Infiltration drains and tunnels are more costly to build, and their design is more complicated. Drains may be subject to clogging. The advantage of drains and tunnels is that these collectors are completely underground so that the collected water is protected against any contamination from the ground surface.

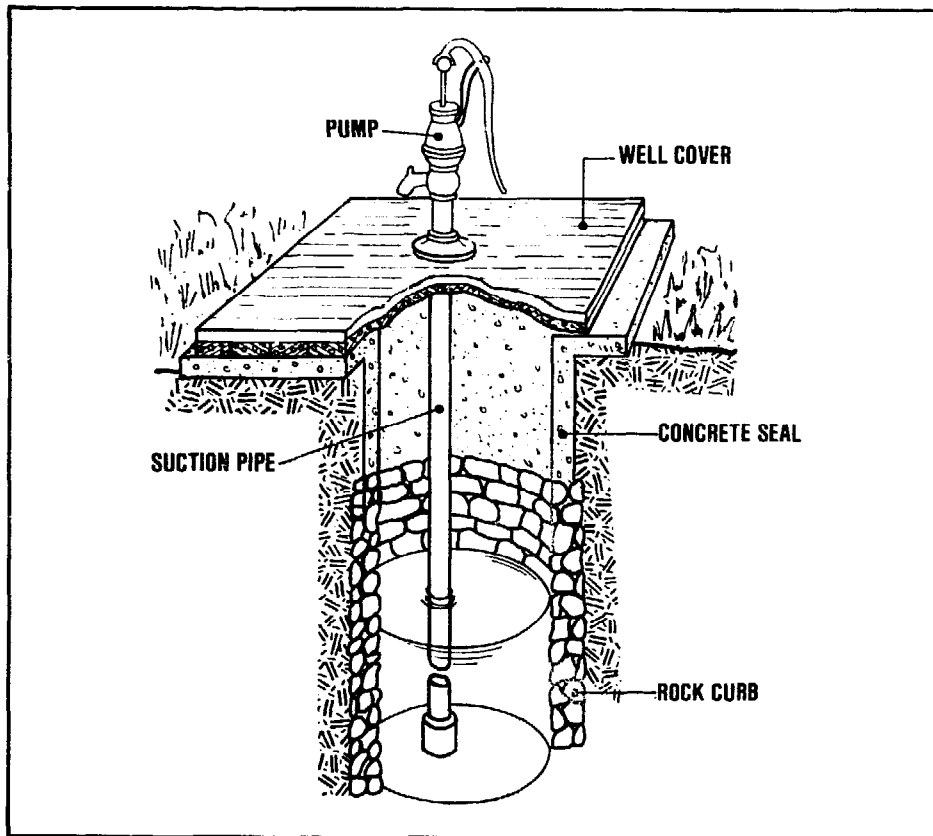

Figure 7.11.
Dug well

The vertical means for groundwater withdrawal may be subdivided into large diameter dug wells (Fig. 7.11) and small-diameter tubewells (or "boreholes") (Fig. 7.12). Tubewells should be used when the groundwater table is at a considerable depth below the ground surface but they are only effective in aquifers of sufficient thickness. Dug wells usually have a

limited capacity so that their use is restricted to individual household and other small-scale water supplies only. The large-diameter shaft acts as a storage reservoir and thus provides for any peak withdrawals. The capacity of tubewells varies over a wide range, from less than 1 litre/sec for shallow small-diameter wells in fine sand aquifers, to over 100 litres/sec for large-diameter deep wells in coarse sand or sedimentary rock deposits. Tubewells are very well suited for drinking water supplies because simple precautions will be adequate to safeguard the water so withdrawn against contamination. Sometimes, a battery of tubewells placed in a series and pumped as one unit, can be used (Fig. 7.13).

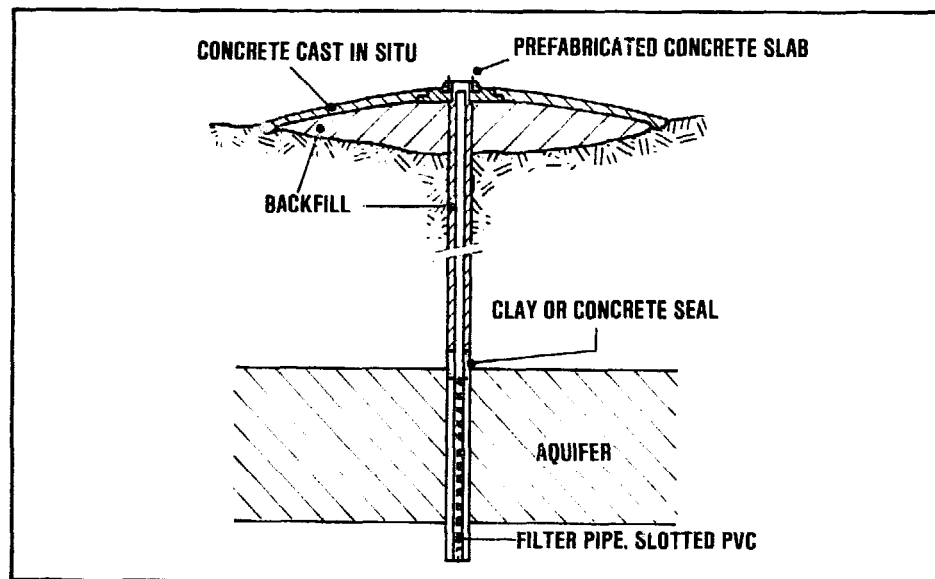

Figure 7.12.
Tube well

In situations where a thick water-bearing ground formation is present at shallow depth, both vertical and horizontal water collectors, or a combination of these, can be appropriate. The technical feasibility will largely depend on the local geological conditions. A much more difficult situation exists when groundwater has to be withdrawn from a thin aquifer situated at a considerable depth. In view of the small saturated area of such an aquifer, tubewells should not be used. Ditches and drains are not appropriate since they would require an excessive amount of excavation work. Sometimes, in consolidated ground, tunnels may be suitable. For unconsolidated

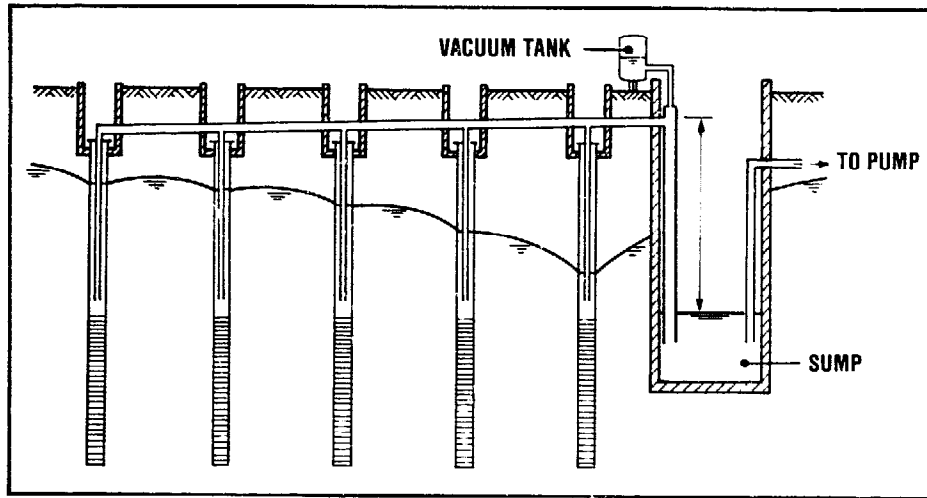

Figure 7.13.
Battery of tubewells

ground, radial collector wells may be considered (Fig. 7.14). However, such wells require specialist design and construction and they are, therefore, generally less suited to small-scale water supplies.

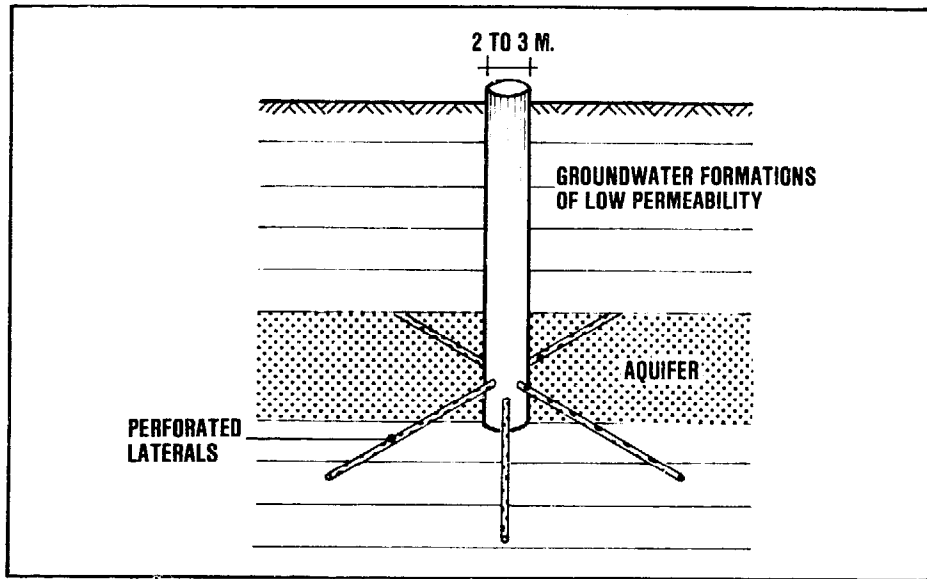

Figure 7.14.
Radial collector well*

* Also called "Ranney Well"

When groundwater is withdrawn there always is a lowering of the groundwater table. In principle, all other withdrawals from the same aquifer are influenced. The effect of groundwater withdrawals for community water supply is usually not great but for high-rate withdrawals that are frequently made for irrigation purposes, the possible effect of an appreciable lowering of the groundwater table should be carefully investigated. It may be necessary to carry out a test pumping to provide a basis for estimating the future drawdown of the water table (Fig. 7.15).

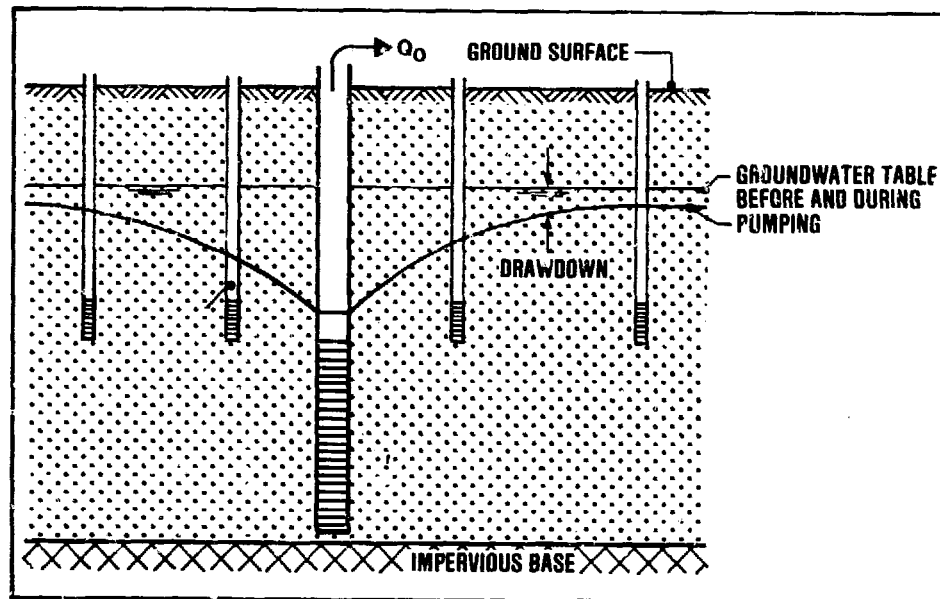

Figure 7.15.
Test pumping

7.4 Infiltration galleries

Ditches as a means of groundwater withdrawal are just a cut in the ground to make the aquifer accessible from the surface. They are easy to construct either manually or with mechanical equipment. The design will also present few problems. The most important requirements are the following (see figure 7.16):

- a. The width and depth should be sufficient to ensure that the collected water flows at a low velocity (usually less than 0.1 m/sec) so as to prevent erosion of the ditch sides and to limit the head losses.

- b. The depth should be greater than 1.0 m and preferably 1.5 m to reduce any penetration of sunlight into the water where it would stimulate plants and algae to grow and cause resistance to the flow of the water.
- c. The ditch sides should slope gently to provide for their stability. This is particularly important for the ditch side-water surface contact area.
- d. For deep ditches, a horizontal embankment about 0.5 m above the normal water level is desirable to facilitate access for cleaning and maintenance work.

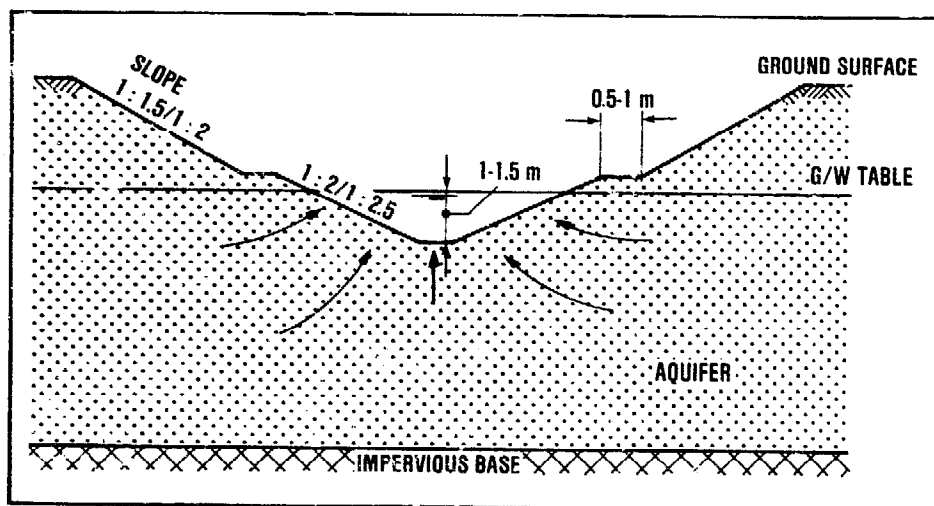

Figure 7.16.
Design of seepage ditch

Seepage ditches being open, the groundwater collected in them is subject to pollution, bacterial contamination and algal growth.

Drains (Fig. 7.17) have pores, perforations or open joints allowing the groundwater to enter. Porous drains may be made of materials such as clay or "no-fines" concrete (using a pea-size gravel and cement mixture, without sand). Perforated drains are mostly of vitrified clay baked in a kiln, plastic or wood. Drains with open joints are usually made of concrete or asbestos cement.

The choice which material to employ for a particular drain construction depends on the required strength, the corrosion resistance needed for the type of

groundwater to be collected, and above all on costs and availability. Perforations in the drain need only be made all round it when the drain is placed completely in the aquifer. For drains laid in the upper part of an aquifer, perforations in the underside will be adequate and for drains deep down in the aquifer only upward-facing perforations are necessary.

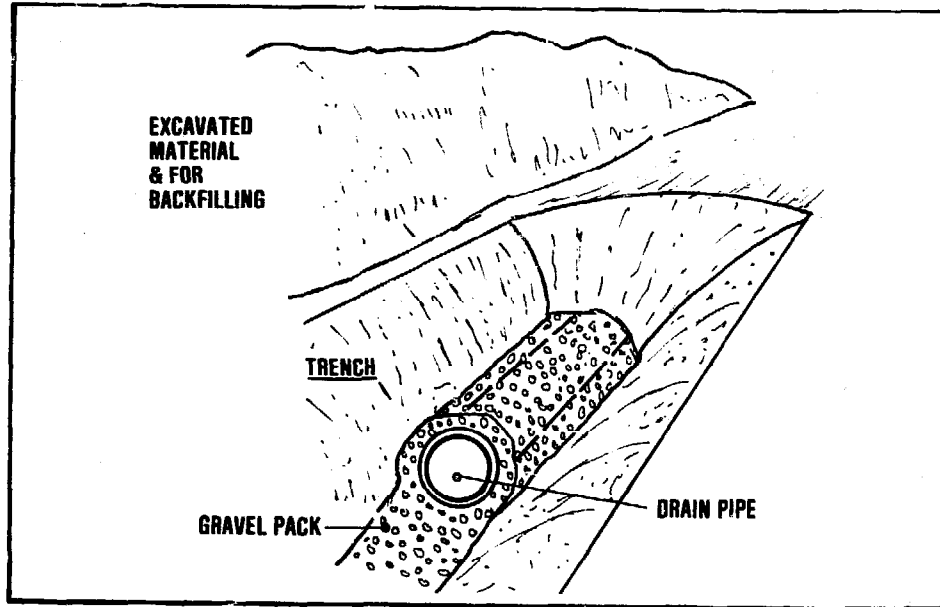

Figure 7.17.
Drain construction

In coarse ground formations such as gravel, the drain openings can easily be made small enough to keep back the ground material. In fine and medium sized sand, perforated drains and drains with open joints should be packed in one or more layers of gravel or coarse sand, to prevent the fine sand of the aquifer from entering the drains. The outside layer should be fine enough to keep back the aquifer material; the inside layer has to be of a size that is somewhat larger than the drain openings. For an aquifer of sand having an effective size of about 0.2 mm the gravel pack could consist of two layers, each about 10 cm thick, with grain sizes of 1-2 mm and 4-8 mm. Drain openings about 3 mm wide may then be used. When drains with open joints 10 mm wide are applied, a third gravel pack layer of 15-30 mm grain size would be necessary.

The most important factors in the design of a drain construction are the internal diameter of the drain pipes, and the depth at which the pipes and gravel pack are placed below the groundwater table.

In spite of the gravel pack, some suspended matter may get into the drain. When this material is allowed to accumulate it would block the drain. To prevent this, the drains should be so sized that the velocity of flow in them is sufficiently high to flush out any silt deposits. For drains to be self-cleaning, the velocity should be higher than 0.5 m/sec but not more than 1.0 m/sec, otherwise the friction losses will be too high. This would cause an uneven drawdown and withdrawal of groundwater along the length of the drain. To accommodate the accumulating quantity of water collected and flowing through the drain, it may be necessary to provide incremental sizes of the drain along its length.

Obviously, in view of the excavation costs the drains should be laid not deeper in the ground than necessary. However, the drains must remain fully submerged in the groundwater with the top of the gravel pack at least 0.5 m deep, even at the end of a long dry period when the groundwater table is likely to be at its lowest level. Using the existing groundwater table as a basis, the designer should allow for an operating drawdown of at least 1 m, plus a further drop of the groundwater table of 1 m under dry conditions. The top of the gravel pack thus should be at a depth of 2.5 m or more under the existing water table. When iron and manganese is present in the groundwater, there is a serious risk of iron and manganese deposits clogging the drain openings and gravel pack. It is then necessary to lay the drains deeper, some 4-5 m under the existing water table, to prevent oxygen from penetrating to the drains and forming the iron and manganese deposits.

7.5 Dug wells

Dug wells are made simply by digging a hole in the ground. They are widely used in many countries and can be quite satisfactory if conditions are right. Usually no special equipment or skills are required for their construction.

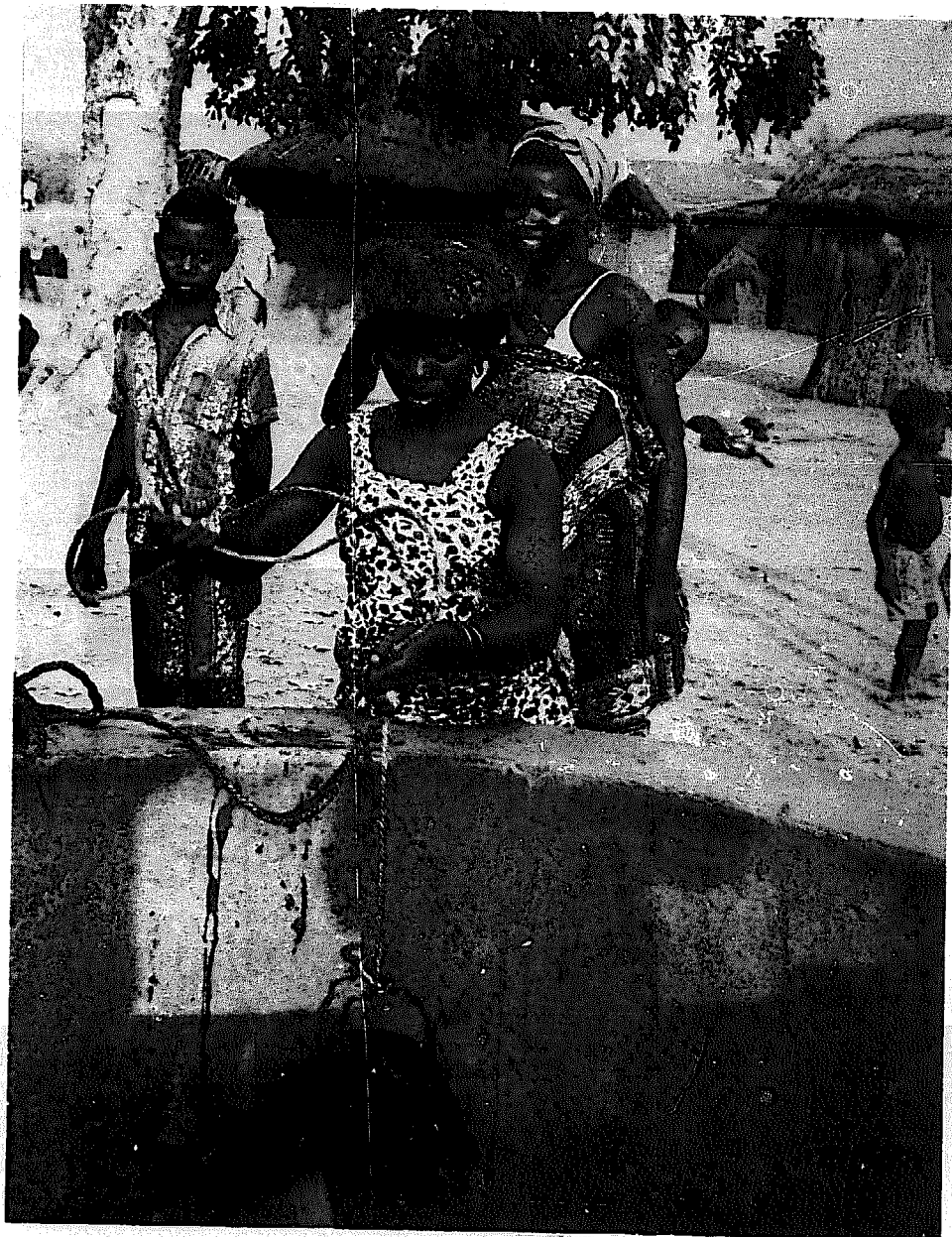

WFP Photo by G. de Sabatino

*Figure 7.18.
Drawing water from a concrete-lined dug well (Togo)*

Experience shows that the diameter of a dug well should be at least 1.2 m if two men are to work together at the bottom of the well during the digging. For a well serving a single household or farm community this minimum diameter is usually adequate but when more people are dependent on a dug well, a larger well, 2-3 m in diameter, must be provided. Further increasing the size of a well is seldom useful since the additional water yield so obtained is likely to be very small.

Due to their large diameter and volume, dug wells provide both groundwater withdrawal and storage. Because of the storage capacity, water can be temporarily withdrawn at a higher rate than the recharge inflow into the well. The storage effect is particularly important when the users take the water mostly at peak rates during a few hours in the morning and the evening.

The depth to which a well can and should be dug largely depends on the type of ground and the fluctuation of the groundwater table. An important factor is the stability of the ground and the costs of digging. Private wells generally are less than 10 m deep. Dug wells for communal use are frequently much deeper, 20-30 m is not unusual and greater depths of 50 m and more have been achieved.

Most dug wells need an inner lining. For this, materials are used such as brick, stone, masonry, concrete cast in a shuttering inside the hole, or precast concrete rings. The lining serves several purposes. During construction, it provides protection against caving and collapse and prevents crumbling ground from filling up the dug hole. After completion of the well it retains the walls. In consolidated ground (e.g. rock) the well may stand unlined but a lining of the upper part is always to be recommended (Fig. 7.19). In unconsolidated ground formations the well should be lined over its entire depth (Fig. 7.20). The section of the well penetrating the aquifer requires a lining with openings or perforations enabling the groundwater to flow into the well.

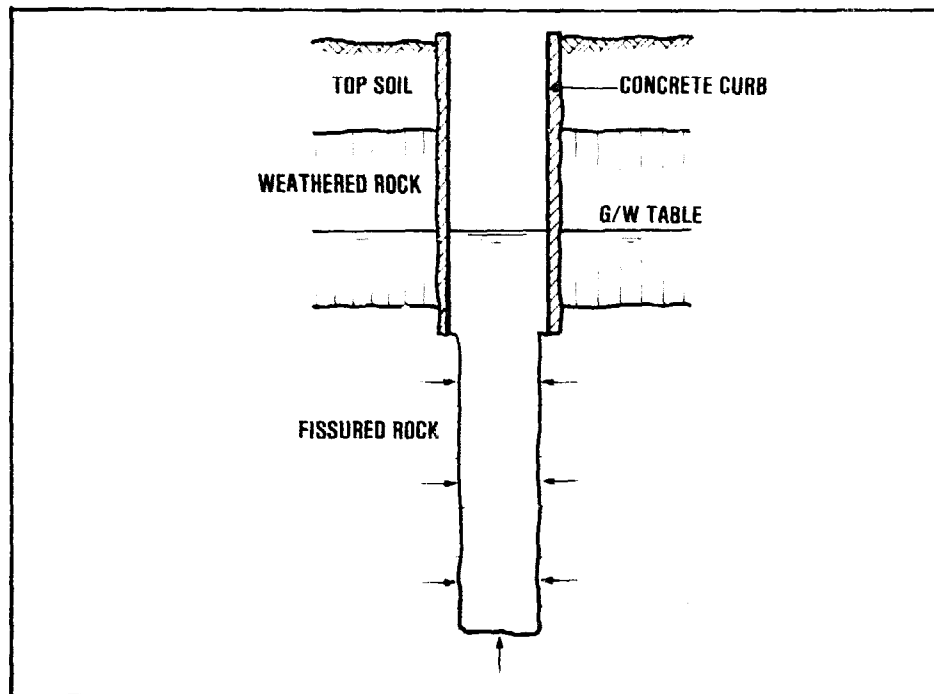

Figure 7.19.
Dug well in rock formation

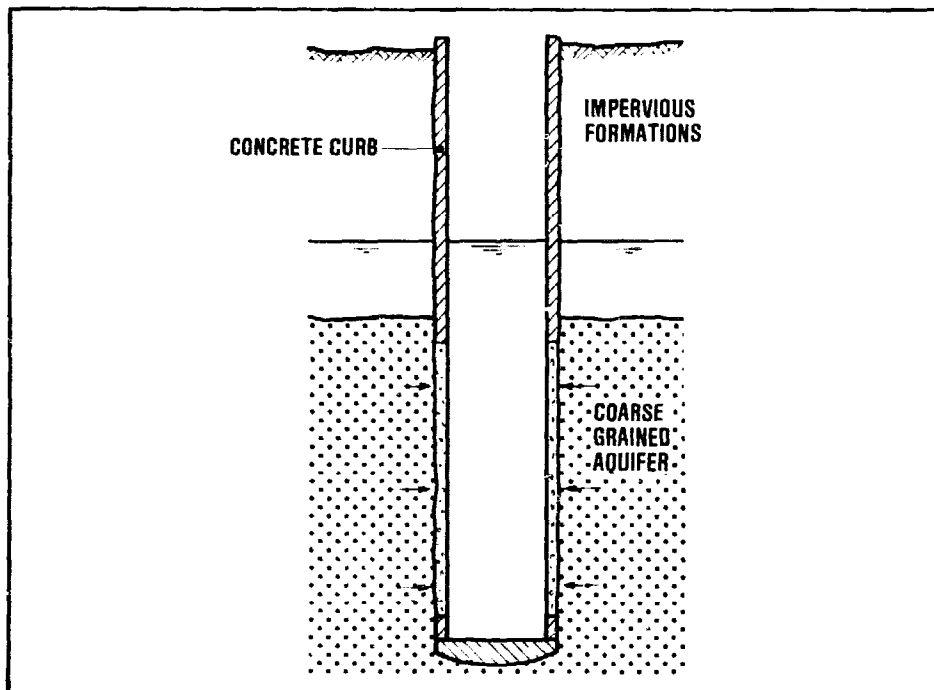

Figure 7.20.
Dug well in coarse granular material

In fine sand aquifers it is impossible to provide a lining with openings or perforations small enough to retain the fine sand and prevent it from passing into the well. In such cases the lining is frequently extended over the entire depth of the well without any openings or perforations. The groundwater enters the well only through the bottom which is covered with several layers of graded gravel keeping down the fine sand of the water-bearing formation (Fig. 7.20). For example, three layers of graded gravel, each 15 cm thick, may be used with grain sizes of 1-2 mm for the deepest layer, then 4-8 mm, and 20-30 mm effective size at the top.

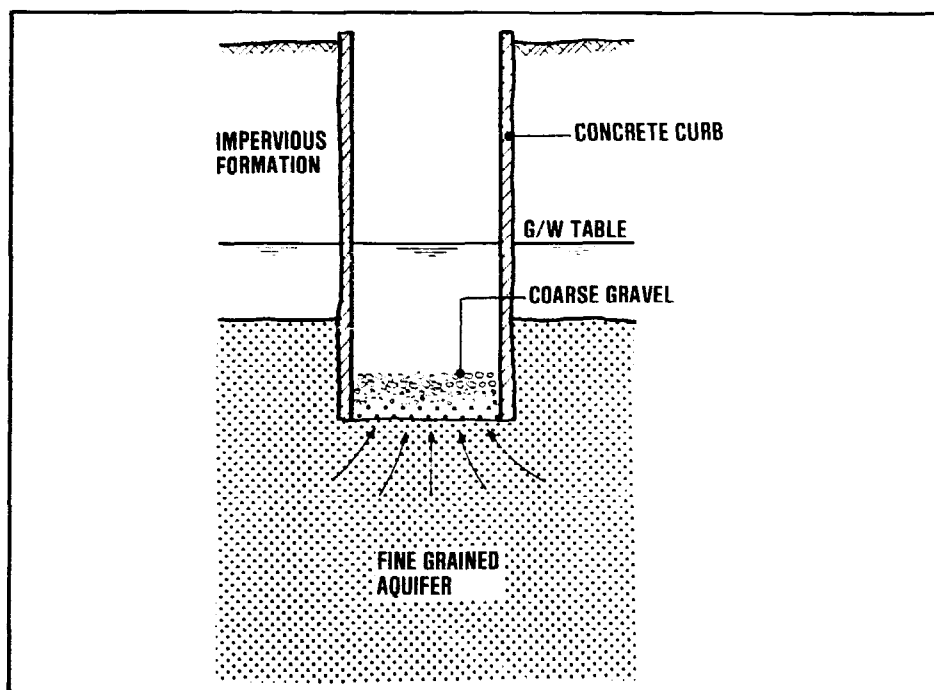
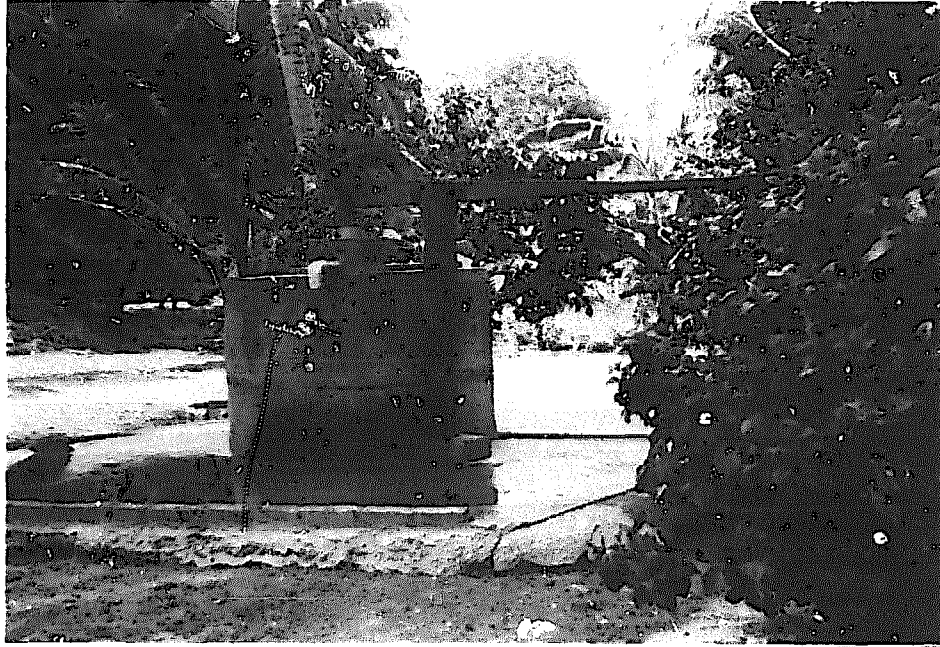

Figure 7.21.
Dug well in fine granular aquifer

Lining a dug well will also provide a seal against polluted water seeping from the surface into the well. This is not so effective if the well is open, because the water in it will then be polluted anyway, especially if the water is drawn using bucket-and-rope. As a minimal provision, the well lining should be extended at least 0.5 m above the ground to form a "head wall" around the outer rim of the well. A concrete apron should then be constructed on the ground surface extending about 2 m all around the well. The

concrete apron also seals any fissures between the well lining and the walls of the excavated hole and so prevents polluted surface water from seeping into the well.



IRC Photo

*Figure 7.22.
Covered dug well equipped with hand pump (Thailand)*

All these measures only have a limited effect, if the well remains open. A satisfactory safeguarding of the bacteriological safety of the water from a well can only be obtained if the well top is completely sealed with a watertight slab on which a pump is mounted to draw the water (Fig. 7.23). A manhole that can be tightly and securely locked should be provided to allow disinfection of the water in the well by chlorination. Although simple in itself, the sealing of dug wells is not always feasible, particularly where the standard of pump installation is poor and maintenance requirements cannot be adequately met.

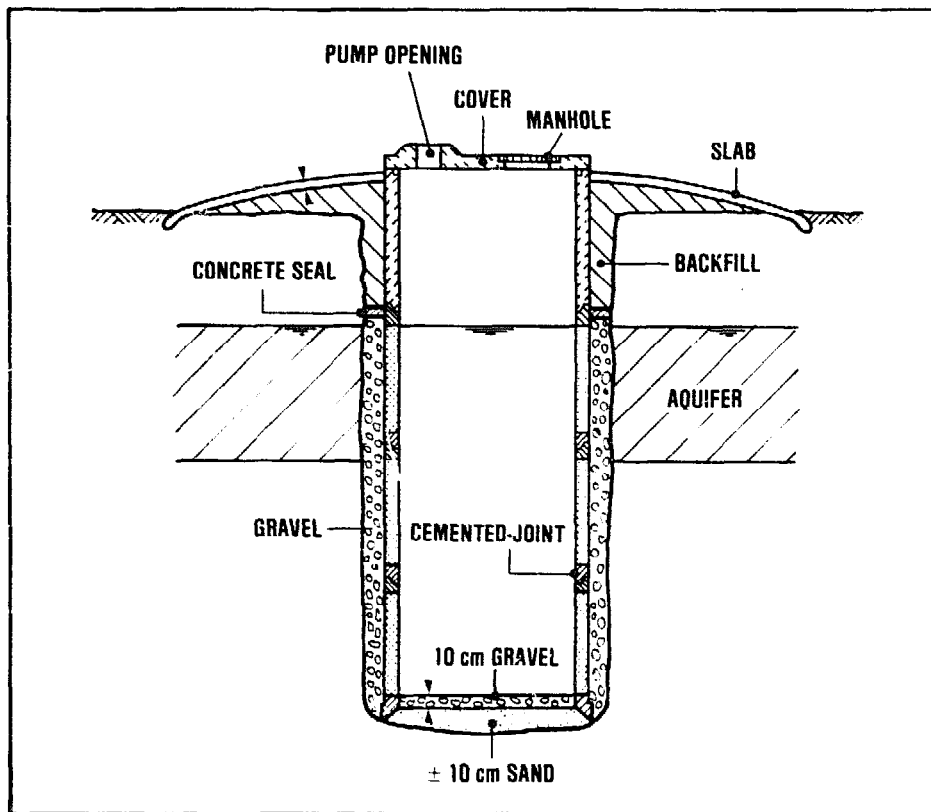

Source: 'Shallow Wells', 1978

*Figure 7.23.
Dug well sealed for sanitary protection*

Dug wells are sometimes constructed in a temporary excavation drained and braced against caving as necessary (Fig. 7.24). Any type of building material may be used. For economy, strength and stability circular walls are to be preferred. Masonry and brickwork are widely used; (reinforced) concrete is also popular, pre-fabricated or poured on the site. To enable the groundwater to flow into the well, the curbs of masonry and brickwork are made with open joints. In concrete linings short pieces of tin tube or garden hose can be cast to provide openings. To avoid the entrance of polluted water from the ground surface, back-filling should be done with care in thin layers that are firmly tamped.

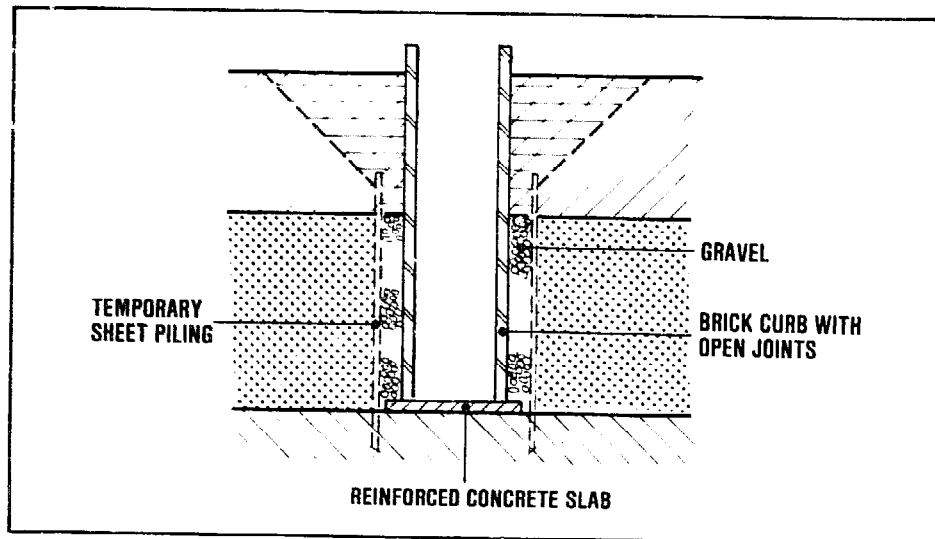

Figure 7.24.
Dug well built in temporary excavation

Stiff, consolidated formations requiring no immediate support for stability allow the temporary excavation to be executed as an open hole with unsupported walls. However, it is prudent to carry out the digging section by section as shown in Fig. 7.25.

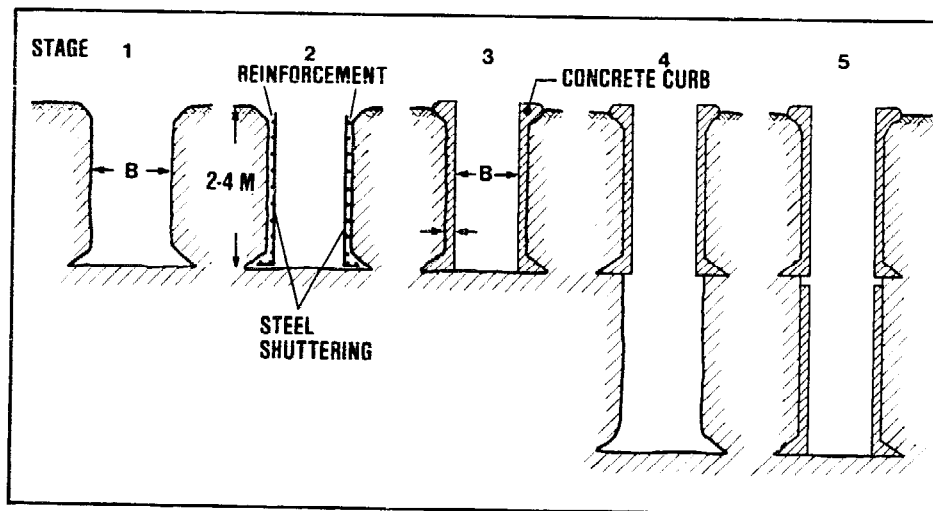

Figure 7.25.
Reinforced concrete curb built on site

Each section should be 2-4 m high and is kept in place by the surrounding ground pressing against it.

The most common method of constructing a dug well is by excavation from the inside, removing the ground at the bottom. The lining then sinks down due to its own weight (Fig. 7.26). For wells of a diameter up to 3-4 m the digging frequently is carried out with hand tools. Below the groundwater table draining of the well becomes necessary to enable further excavation to be carried out. In this construction method, circular well snapes are mostly used because they settle readily and are not liable to deformation when the well lining sections are subjected to uneven forces.

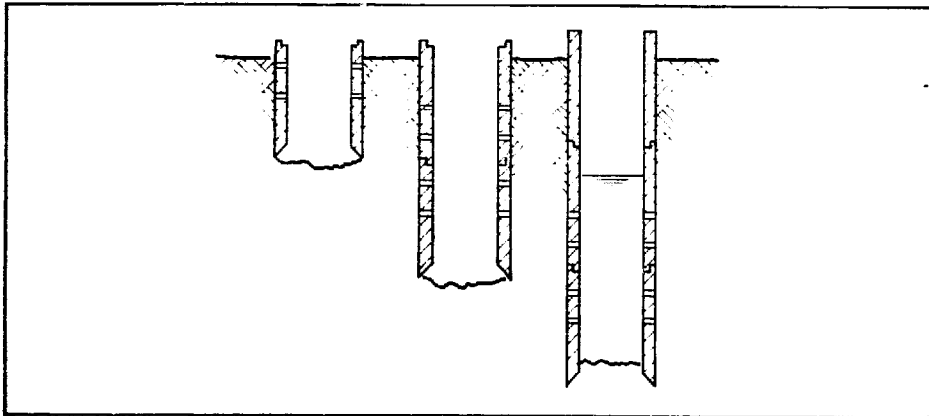

Figure 7.26.
Sinking a dug well by excavation from the inside.

Masonry work of stones, bricks or concrete blocks can be used to build the well lining using a strong steel shoe as the base (Fig. 7.27). The shoe prevents the lining from settling unevenly which could cause deformation and cracks. Reinforced concrete obviously is a more suitable construction material in this respect. It also allows the well lining to be constructed above ground as the well sinking progresses. Large-diameter pipes of concrete, asbestos cement or plastic may be used for well lining material. When these are not available or too expensive and difficult to handle, prefabricated concrete rings may be employed to form the lining (Fig. 7.28). There is no valid reason why prefabricated concrete rings should not be widely used. They require no skilled masons, only suitable stones, bricks or gravel, and it is not difficult to train unskilled workers for pouring concrete. The necessary sand and gravel may usually be obtained in the neighbourhood of the well site.

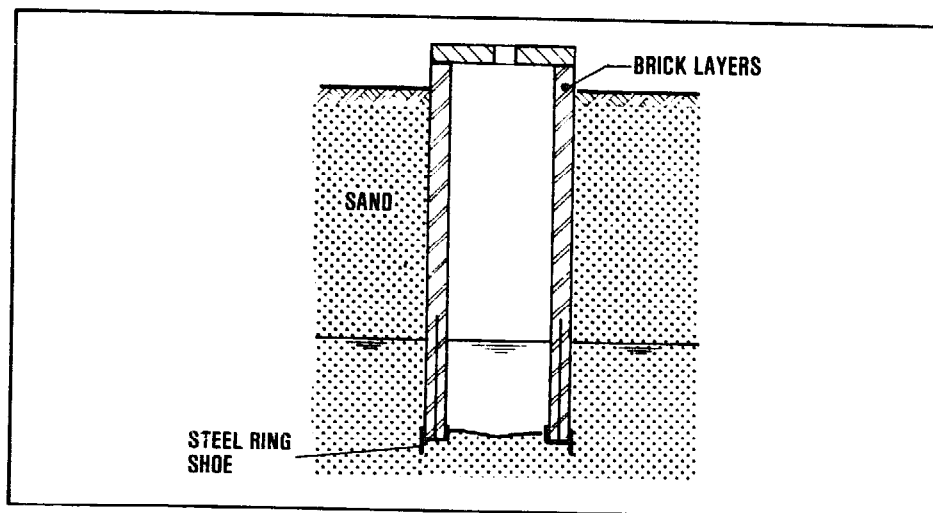

Figure 7.27.
Dug well with brickwork lining.

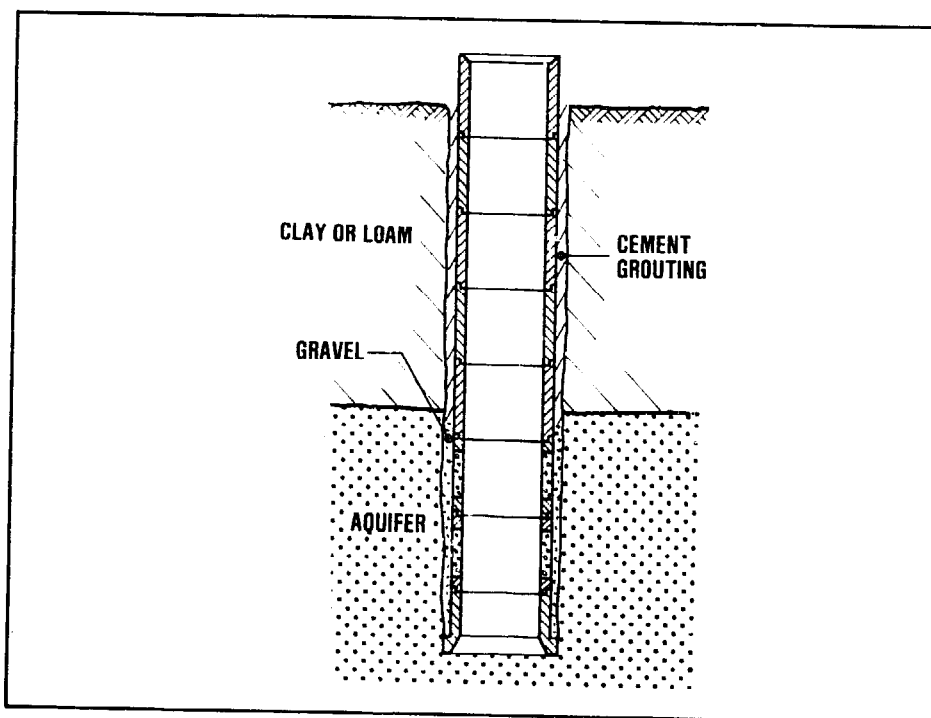

Figure 7.28.
Dug well construction with pre-fabricated rings.

The lower end of the starter ring is provided with a shoe having an inside cutting edge; the outside dia-

meter is somewhat larger to facilitate the sinking and to reduce ground friction along the outside (Fig. 7.29). The starter ring during sinking leaves a space around the curb. In loose formations this space will be self-sealing but in cohesive formations it must be filled with cement grout or puddled clay as a safeguard against seepage of polluted water from the ground surface. Over the depth of the aquifer, the rings are made of "no-fines" concrete (pea-size gravel and cement, without sand) through which the groundwater can enter the well.

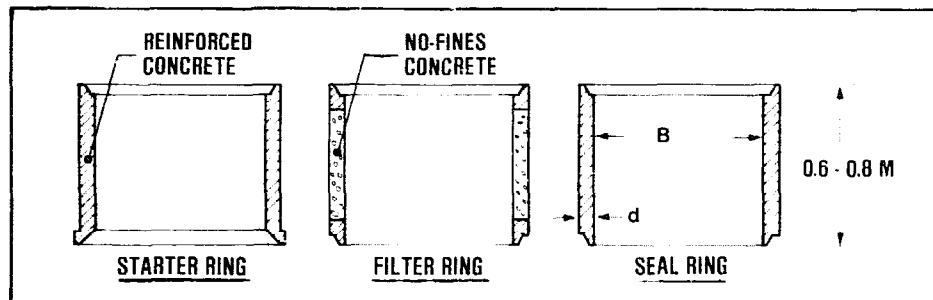

Figure 7.29.
Pre-fabricated concrete rings



VDO Photo

Figure 7.30.
Reinforced concrete ring for lining a dug well

Frequently, a more economic and technically better construction may be obtained by combining the two methods of construction described above. The construction of Fig. 7.31 gives an excellent protection against any ingress of polluted seepage water from the surface; it also allows the well to be made deeper when after some time the ground water would fall to a lower level. The design shown in Fig. 7.32 does not have this advantage but it costs much less to construct.

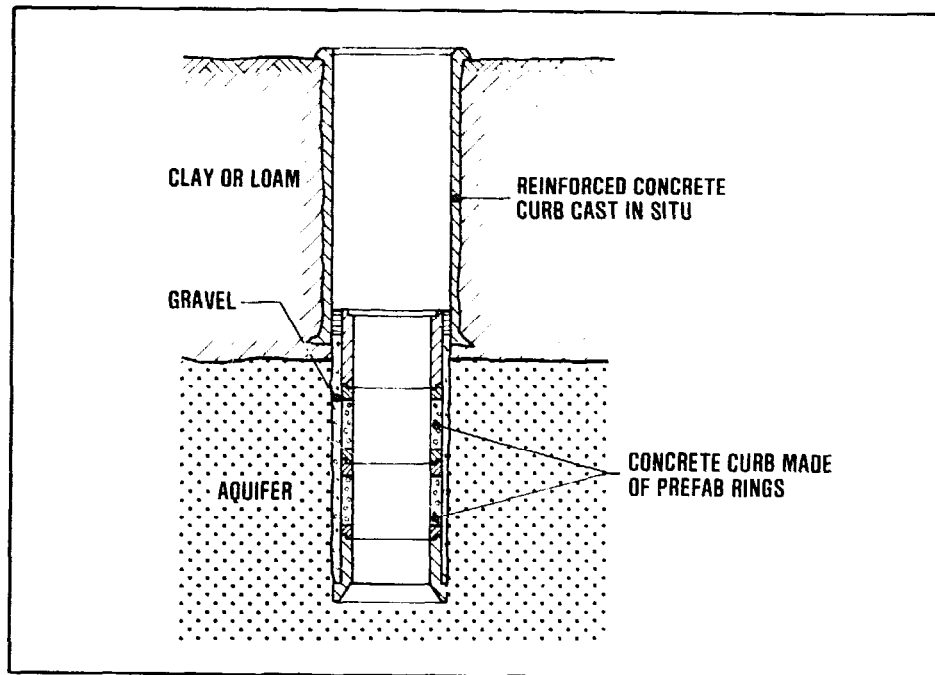

Figure 7.31.
Dug well construction using combination of methods

It will be clear that it is not so easy to protect the water of a dug well against bacterial contamination. To sum up, the following precautions are recommended:

1. The upper part of the lining should be watertight preferably to a depth several metres below the lowest drawdown water level in the well;
2. The space between the walls of the dug hole and the lining should be sealed with puddled clay, or better with cement grout;

3. The top of the lining should extend some 0.5 m above ground level and should be topped with a watertight cover on which a (hand) pump is to be mounted for drawing the water from the well;
4. An apron should be constructed around the raised top of the lining (the "head wall") about 2 m wide, sloping outwards and with a gutter draining any spill water away from the well site;
5. The water in the well should be chlorinated for disinfection, after the well has been completed; this should be repeated at regular intervals.

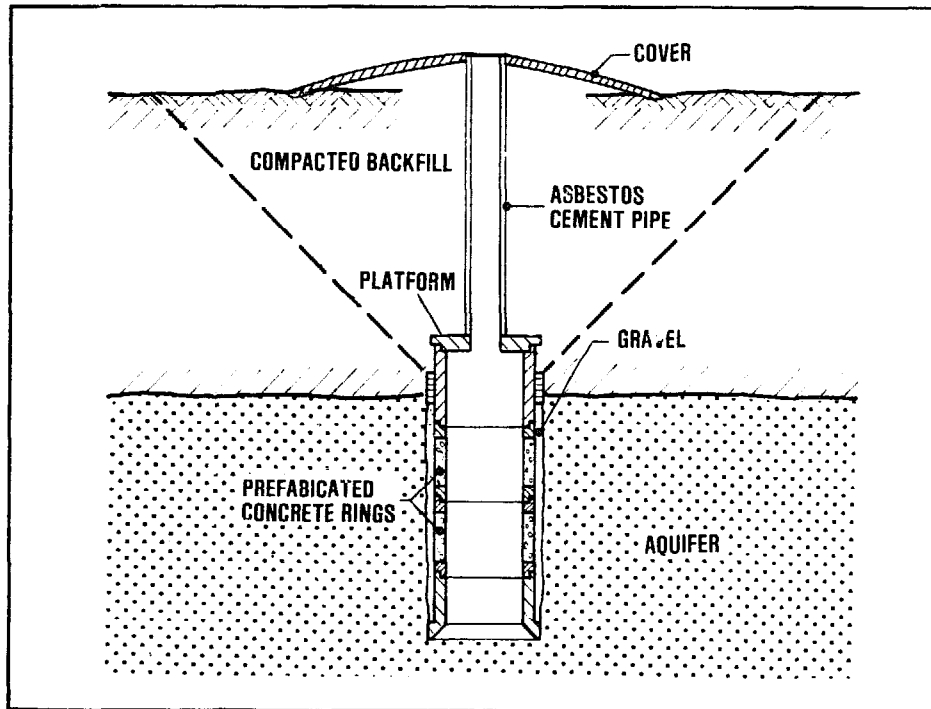

Figure 7.32.
Dug well construction using combination of methods

7.6 Tube wells

A tubewell has a casing consisting of pipes (tubes): plain pipes opposite non-water bearing ground formations, and perforated or slotted screen sections opposite the aquifer.

Tubewells are quite suitable for small-capacity water supplies. Tubewells of small diameter and shallow depth may be constructed by driving, jetting or

boring. Drilling is more appropriate for larger - diameter tubewells designed for the withdrawal of considerable amounts of water at greater depths, or for tapping aquifers that are overlaid by hard rock or similar ground formations. Drilling is a very versatile well construction technique which can be used for any reasonable depth and in most geological formations. However, it requires complicated equipment and considerable knowledge and experience. It is mostly done by specialist drillers. A detailed survey of well drilling methods is given in Annex 2.

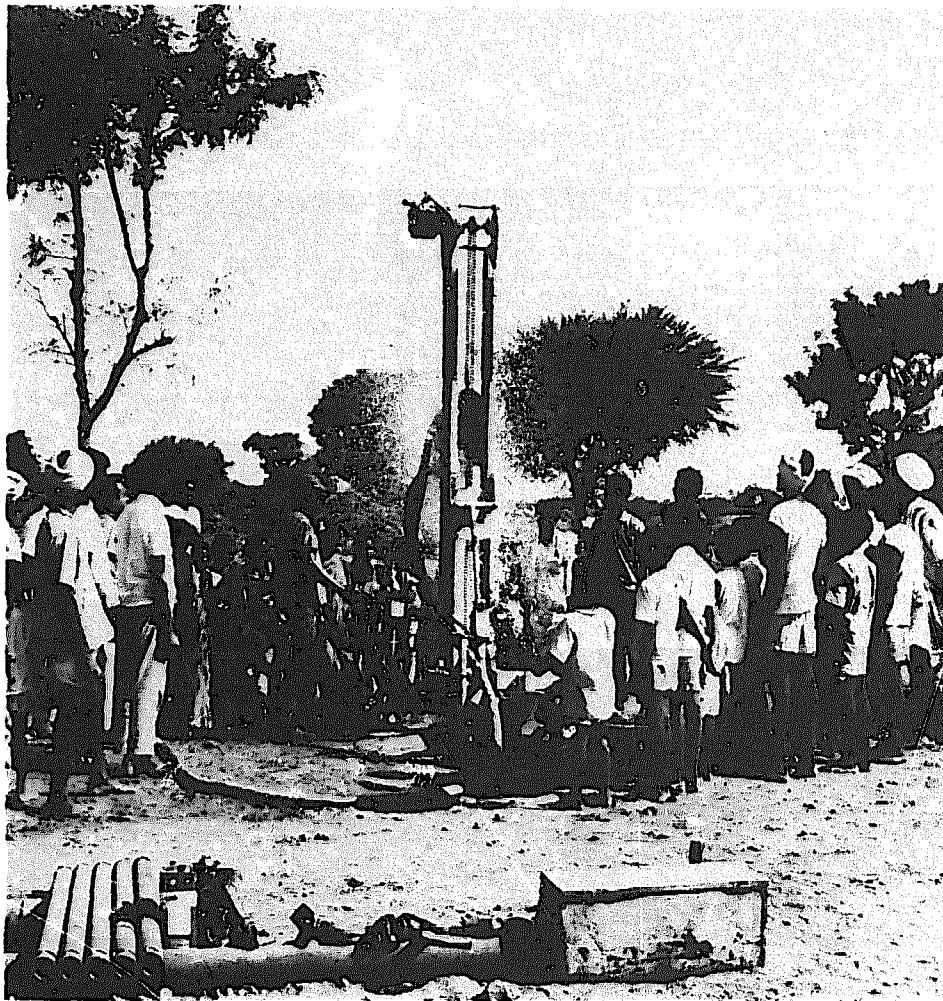

UNICEF Photo by Bash

Figure 7.33.
Well drilling

Tubewells can be drilled to over 200 m deep, even through hard rock. However, there never is a guarantee that water will be found. It is, therefore, important to make full use of any available prospecting and exploration data when choosing the site where a tubewell is to be drilled. The assistance of experienced and qualified people is essential, together with the information obtained through hydrogeological surveys.

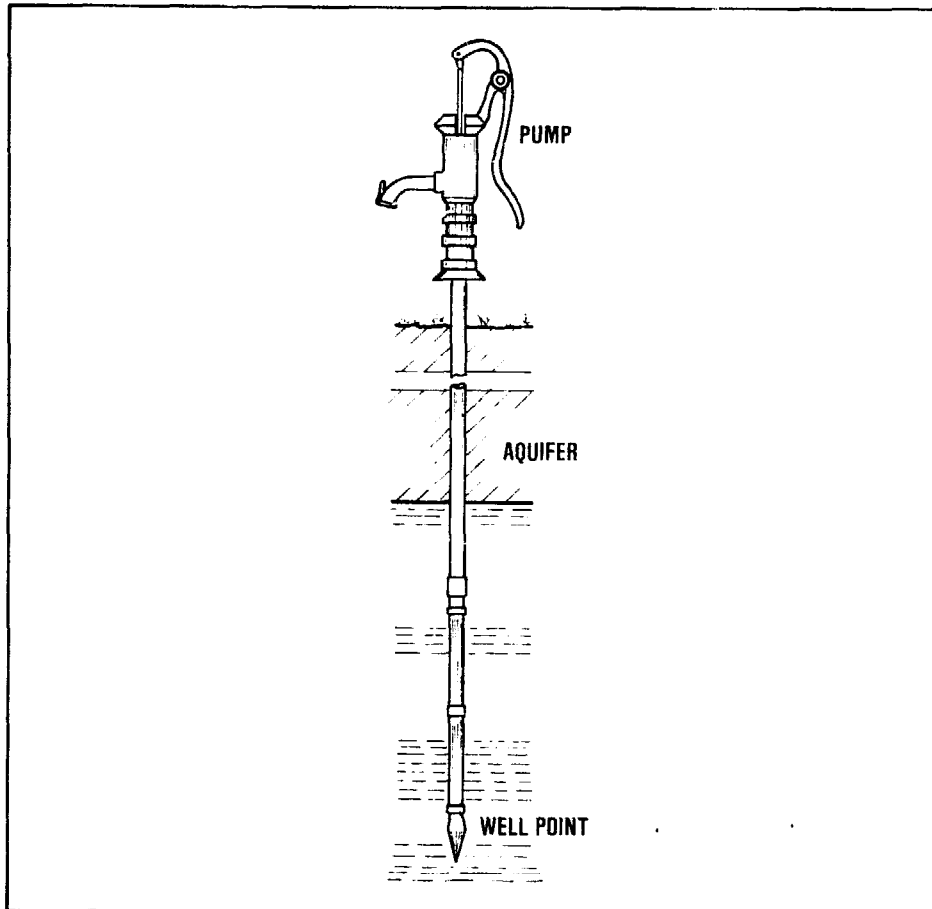

Figure 7.34.
Driven well

Driven wells (Fig. 7.34) are made by driving a pointed screen (called a "well point") into the water-bearing formation. To prevent damage to the well point when driving through pebbles or thin layers of hard material, the point at the lower end of the screen is made of solid steel, usually with a slightly larger diameter than the screen itself. Most

well points have a diameter in the 30-50 mm range. As driving proceeds and the well point sinks into the ground, successive sections of pipe are screwed on top so that the upper end of the casing always is above the ground surface. The well point is driven into the ground using a simple mechanism for hitting the top of the pipe. Many arrangements can be used. Fig. 7.35 is indicative.

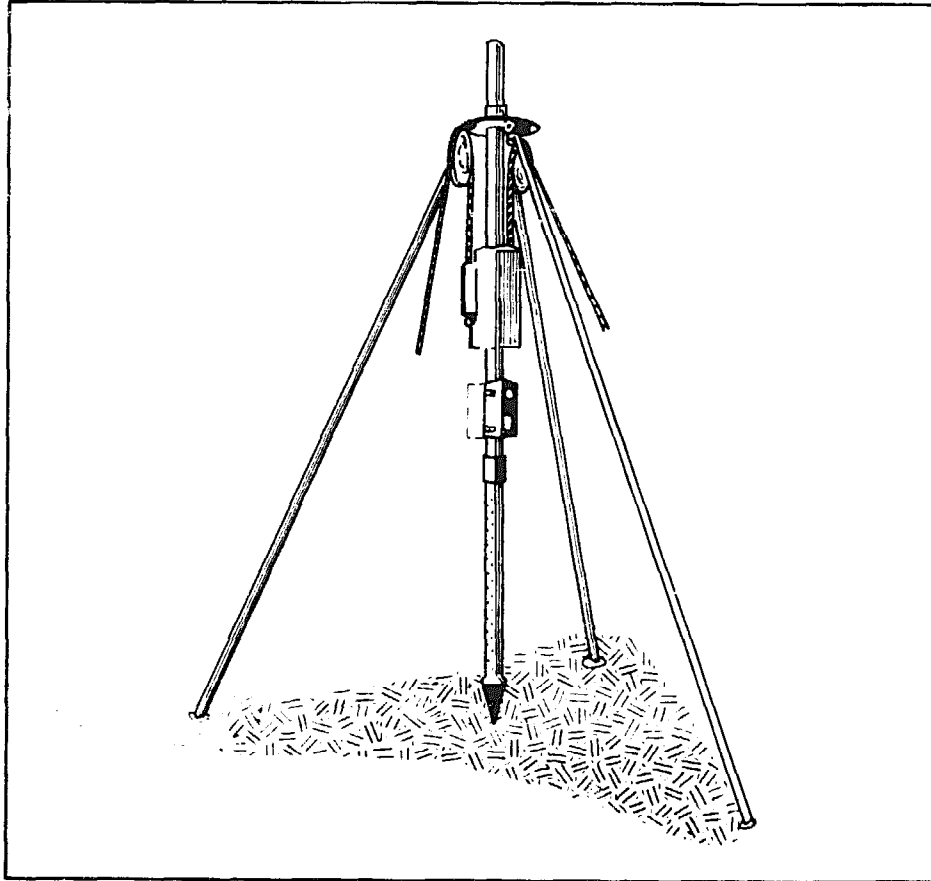

Figure 7.35.
Well driving arrangement

Whichever method is used, it is essential to ensure that the blows are square and vertical, otherwise the pipe will bend and perhaps break. As it is the pipe that transmits the blows to the well point, strong thick-walled piping must be used, particularly when difficult driving in hard formations is expected.

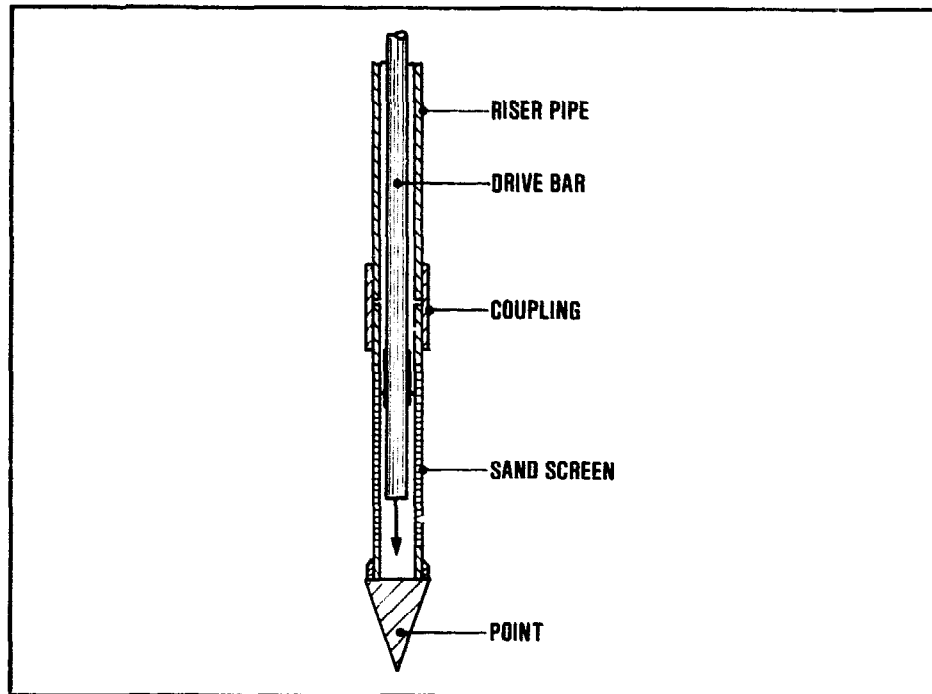

Figure 7.36.
Well driving with inside drive bar

In the well driving method shown in Fig. 7.36, the drive bar falls free inside the screen. The pipe is pulled into the ground rather than driven so that pipes of normal strength classes can be used. Driven wells are especially suitable for soft sandy formations which are readily penetrated by the well point. Driven wells cannot be made in areas where boulders or other obstacles are encountered in the ground. In all ground formations the resistance against driving increases with depth. The application of driven wells is therefore limited to shallow wells of less than 10-15 m depth. For the same reason the diameter is usually small varying from as narrow as 3 cm to a maximum of about 10 cm, a diameter of 5-8 cm being the most common. Well pumps cannot be installed inside such small diameters. Driven wells also have the disadvantage that the screen openings may during the driving become clogged with clay or similar material. This is almost impossible to remove after the completion of the driven well.

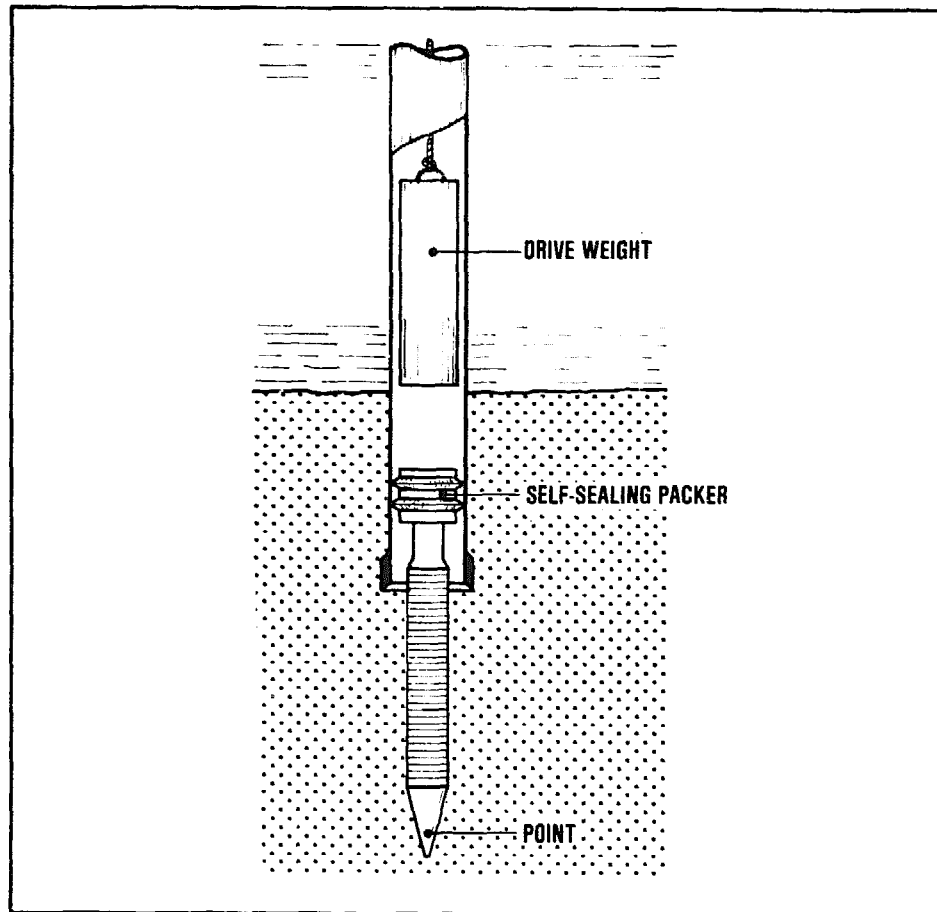
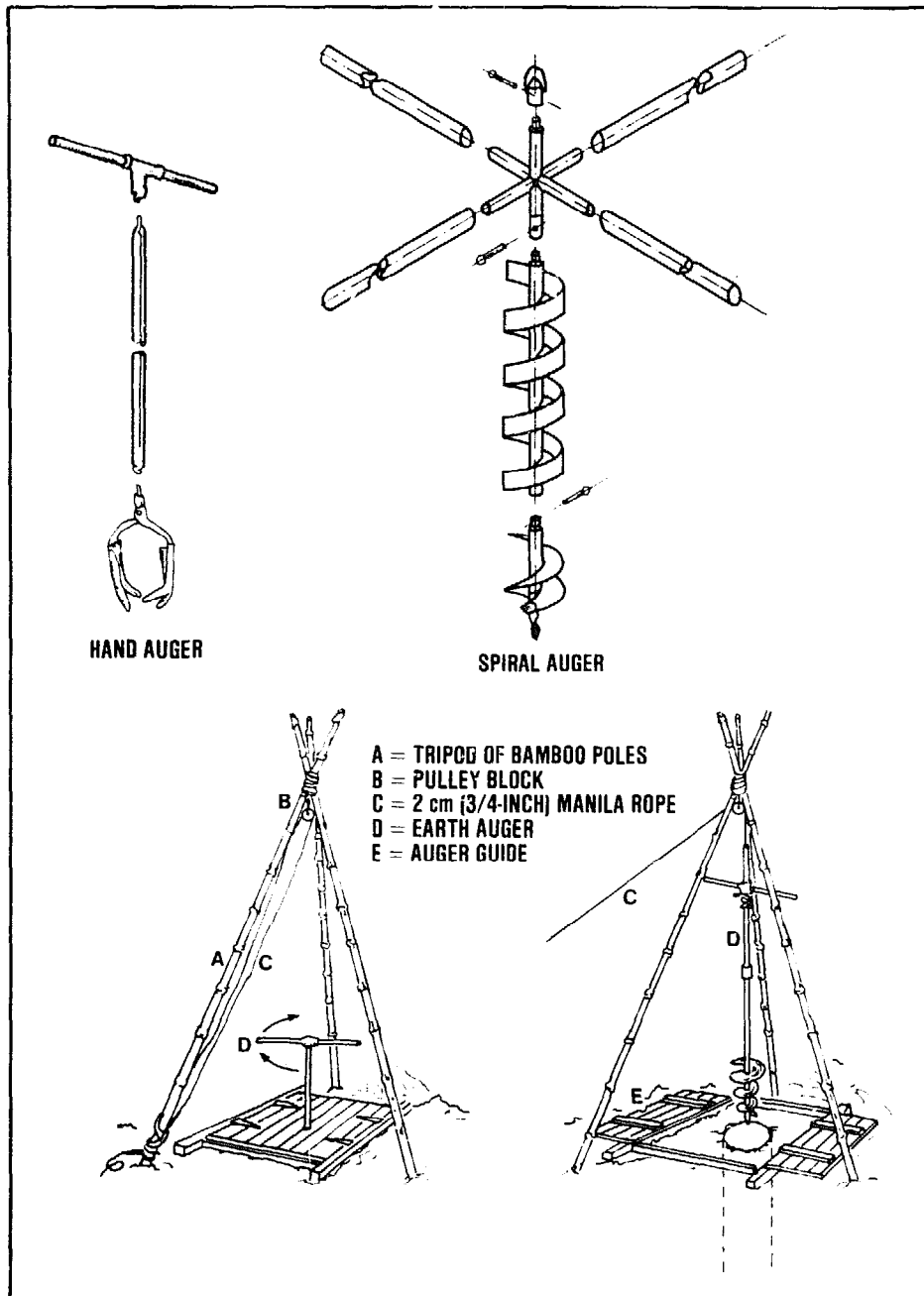

Figure 7.37.
Well drive point with sliding joint

The clogging of the well screen can be prevented by using a sliding joint (Fig. 7.37). During driving the screen is inside the casing and only after reaching the desired depth is it then forced out to intrude the water-bearing formation. When there are hard formations directly below the ground surface, a better solution is to start with an earth auger for boring a hole as deep as possible with a diameter slightly larger than the size of the well point to be driven down (Fig. 7.38). When the hole is straight, vertical and deep enough this also helps achieve a plumb well which otherwise may be difficult to obtain.



Source: WHO
(No. 7462)

Figure 7.38
Well boring equipment

If, after completion of the driven well the inside is thoroughly disinfected, the water from it will be bacteriologically safe and is likely to remain so.

However, the yield from a driven well is small, somewhere between 0.1 and 1 l/sec. This will be only sufficient for private household use or a small community. For a larger supply of water, a number of driven wells may be interconnected with a central suction line and pumped as one unit but this solution is rather expensive. In rural areas of developing countries driven wells have the advantage of easy and rapid installation with no need for specialized equipment or skills.

Jetted wells outwardly do not differ much from driven wells but the point at the lower end of the screen is hollow instead of solid, and the well is bored through the erosive action of a stream of water jetting from the point (Fig. 7.39).

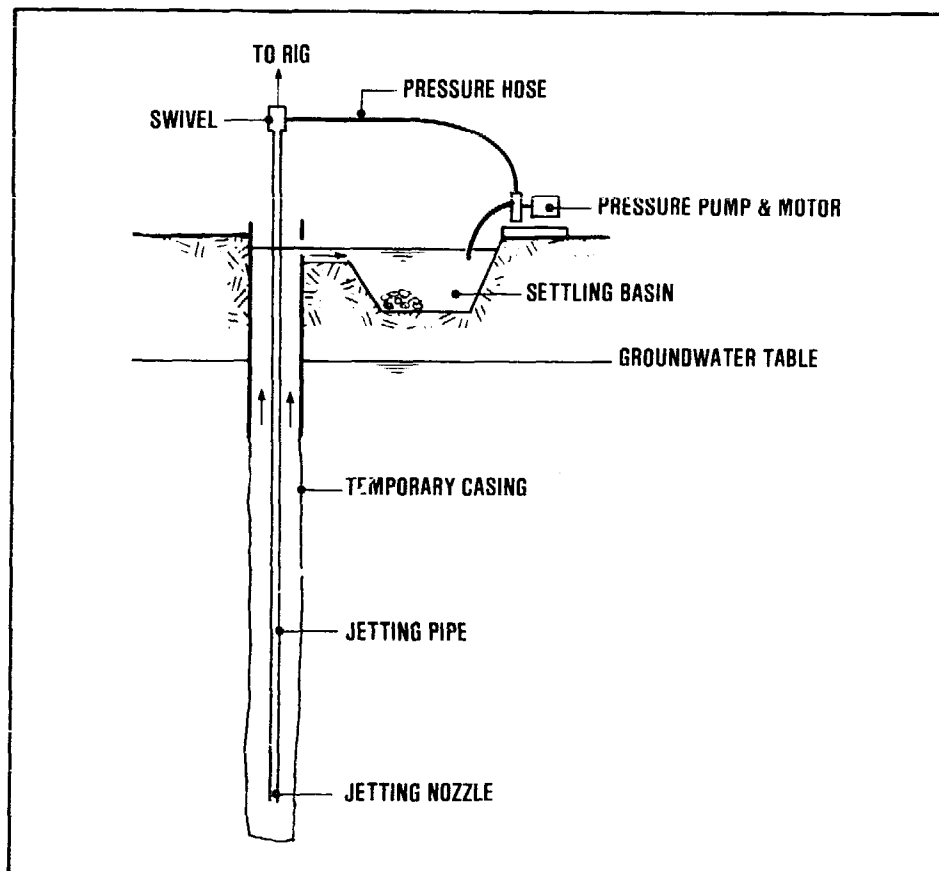

Figure 7.39.
Well jetting

Compared with driven wells, jetting of wells is much faster. Mechanical force is not needed so that plastic instead of steel can be used for casing and strainer. Obviously, jetted wells can only be sunk in unconsolidated formations. Sandy aquifers are best suited for this method; clay and hardpan often offer too much resistance to the jet stream of water. As with driven wells, boulders cannot be passed but it is a simple process to check the underground formation beforehand by washing the jetting pipe shown in Fig. 7.40 to the desired depth. Such a jetting pipe is also used in a well jetting technique using a separate jetting pipe to wash the plastic casing and screen into the ground. Compared with driven wells, the depth that can be obtained is somewhat greater, for the same diameters of about 5-8 cm. Clogging of the well screen openings is no problem.

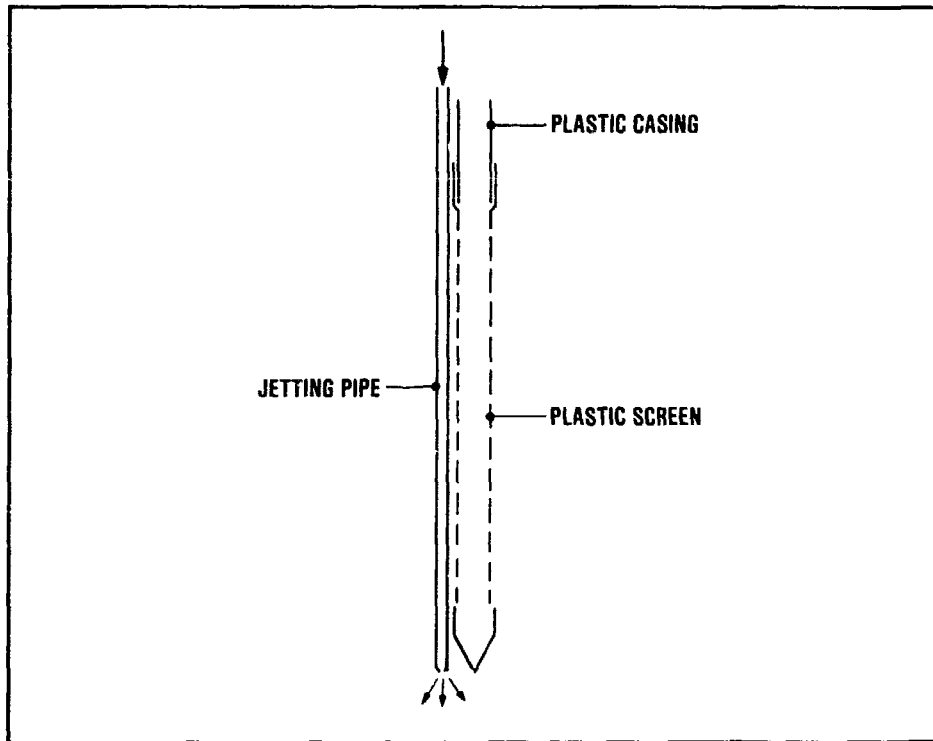

Figure 7.40.
Well jetting with an outside jet pipe

Wells can also be made as bored wells. The boring technique lends itself best for use in soft ground such as sand and soft limestone. Thus, boring is particularly used in deltaic areas where these types

of ground are most common. For shallow depth, spiral augers are employed as shown in Fig. 7.38. For greater depth bucket-type augers can be applied, again rotated from the surface by means of a drive shaft. This shaft is built up from steel rod sections, 3-6 m long and connected by quick-acting couplings. The upper part is called the kelly and has a square cross-section to receive the necessary torque from a rotating table. At the bottom, the auger is provided with a cutting face which peels the soil from the hole and discharges it into the cylindrical chamber above. When full, the auger is drawn up above ground and the hinged bottom is opened. Each time this is necessary, the drive shaft must be dismantled and coupled together again, a tedious and time consuming job.

It will be clear that bored wells are mainly suited to soft unconsolidated ground formations. In cohesive ground such as clay, a temporary casing to support the hole is usually not necessary above the groundwater table but in loose ground a temporary casing must be installed. Under the water table, the auger does break up the ground layers but it cannot bring the bored material to the surface as the cuttings escape from the container when the auger is pulled up from the bottom of the hole. A bailer lowered in the hole with a cable must be employed to collect the cuttings. The bailer is moved up and down near the bottom of the hole; during the downstroke the cuttings are entrapped by a closing valve. The whole operation greatly increases the time required for the boring of a well.

Sludger Method of Sinking Tubewells

The "sludger method" is an indigenous, low-cost, labour-intensive technique for sinking tubewells in unconsolidated alluvial ground formations such as those found in deltaic areas. Tubewells with a depth up to 50 m may be constructed using this method under suitable conditions. In Bangladesh, the sludger method has been and continues to be extensively used for sinking numerous tubewells to tap the abundant, shallow groundwater resources present in that deltaic country.

To start the drilling operation, a hole of about 0.6 m diameter and 0.5 m deep is made into which water is poured. Some bamboo staging is erected above the hole. A piece of steel pipe is placed vertically in the soil, and drilling is carried out by moving the pipe up and down with a jerking action. For this, a bamboo rafter fastened to the pipe and supported

from the staging is operated. At the foot of the drill pipe, soil loosened by the water enters into the pipe allowing it to penetrate in the ground. As a result of the jerking action of the drill pipe, the loosened soil and water is pushed upwards and comes out through the top of the pipe.

During the well sinking, one man sits on top of the staging and takes care that the pipe is drilled perfectly vertically. At each upward stroke, he closes the top of the drill pipe off with his hand which introduces a suction action. This assists the loosening of the soil at the pipe bottom and the forcing up of the drilled soil. More pieces of pipe are added as the string of drill pipe sections penetrates deeper and deeper in the ground.

As the well sinking proceeds, soil samples are collected from the mud flow coming out at the top of the drill pipe. These are taken at each 1.5 m the drill pipe is sunk further, and then examined. The drilling operation is stopped when good water-bearing formations are sufficiently penetrated. The whole length of pipe is withdrawn piece by piece taking care to keep the drilled hole intact. Immediately after withdrawal of the drill tubes, the well casing consisting of plastic pipes complete with strainer sections is fitted and lowered in the hole up to the determined depth.

An indication of the time and labour requirements for sinking a tubewell using the sludger method, may be obtained from an example concerning a well sunk in Konaburi District of Dacca (Bangladesh) to a depth of about 28.5 m. The following data are quoted:

- | | | |
|---|---|----------|
| - | Time required for drilling of the well | 11 hours |
| - | Time required for construction of platform | 4 hours |
| - | Labour engaged for drilling well skilled | 2 men |
| | unskilled | 3 men |
| - | Labour engaged for construction of platform | |
| | skilled | 1 man |
| | unskilled | 1 man. |

Groundwater withdrawal

Allsebrook, J.C.P.
WHERE SHALL WE DIG THE WELL
In: *Appropriate Technology*, Vol. 4(1978) No. 4.

A.W.W.A.
GROUNDWATER
AWWA Manual M21, 130 p.
American Water Works Assoc., New York, 1973

Beyer, M.G.
DRINKING WATER FOR EVERY VILLAGE
In: *Assignment Children*, UNICEF, 1976, No. 34

Bowen, R.
GROUND WATER
Applied Science Publishers Ltd., 1980, 227 p.

Brown, R.H. (Ed.)
GROUND WATER STUDIES
UNESCO, Paris, 1973-1977

Brush, R.E.
WELLS CONSTRUCTION
Peace Corps, Washington, D.C., 1980

BURGÉAP
LA CONSTRUCTION DES PUITES EN AFRIQUE TROPICALE
Ministere de la Cooperation, Paris, 1974
(Series Techniques Rurales en Afruque)

Castany, G.
TRAITE PRATIQUE DES EAUX SOUTERRAINES
Dunod, Paris, 1967, Second edition

Castany, G.
PROSPECTION ET EXPLOITATION DES EAUX SOUTERRAINES
Dunod, Paris, 1968, 717 p.

Campbell, M.D.; Lehr, J.H.
WATER WELL TECHNOLOGY
McGraw-Hill Book Co., New York, 681 p.

Cruse, K.
A REVIEW OF WATER WELL DRILLING METHODS
In: *Journal of Engineering Geology*, 1979, (Vol. 12), pp. 79-95

Davis, S.N.; De Wiest, R.J.N.
HYDROGEOLOGY
John Wiley & Sons, New York, 1966

Eberle, M.; Persons, J.L.; Lehr, J.H. et al.
APPROPRIATE WELL DRILLING TECHNOLOGIES
National Water Well Assoc., Worthington, Ohio, USA, 95 p.

Freeze, R.A.; Cherry, J.A.
GROUNDWATER
Prentice-Hall, Inc., Englewood Cliffs, N.Y., USA, 1979

Gibson, U.P.; Singer, R.D.
SMALL WELLS MANUAL
Agency for International Development, Washington, 1969, 156 p.

GROUNDWATER AND WELLS
Johnson Division, UOP, St. Paul, Minnesota,
(3rd printing), 1975, 440 p.

Holmes, A.
PRINCIPLES OF PHYSICAL GEOLOGY
Thomas Nelson & Sons Ltd., London, 1966

Huisman, L.
GROUNDWATER RECOVERY
McMillan, London, 1972, 336 p.

Hwindl, L.A. (Ed.)
HIDDEN WATER IN ARID LANDS
Report of a Workshop on Groundwater Research Needs.
Paris, 25 November 1975.
Association of Geoscientists for International
Development (AGID), 1976

Jain, J.K.
HANDBOOK ON BORING AND DEEPENING OF WELLS
Government of India, Ministry of Food and Agriculture, New
Delhi, 1962

MANUAL OF WATER WELL CONSTRUCTION PRACTICES
U.S. Environmental Protection Agency, Washington, D.C., 1975, 175 p.
(EPA-570/9-75-001)

McJunkin, F.E.
JETTING SMALL TUBEWELLS BY HAND
Washington, D.C., July 1960, p. 3
(Peace Corps Technical Notes No. 1)

Moehrl, K.E.
WELL GROUTING AND WELL PROTECTION
In: Journal of the American Water Works Association, No. 4,
1964(56), pp. 423-431

Romero, J.A.C.
MANUAL DE POZOS RASOS
Organizacion Panamericana de la Salud, Washington, D.C., 1977

SHALLOW WELLS

DHV Consulting Engineers, Amersfoort, Netherlands, 1978, p. 189

Slow, D.A.V.; Skidmore, J.; Beyer, A.R.

PRELIMINARY BIBLIOGRAPHY ON GROUNDWATER IN DEVELOPING COUNTRIES

Association of Geoscientists for International Development
(AGID), November, 1976

Todd, D.K.

GROUNDWATER HYDROLOGY

John Wiley & Sons, New York, 1959

Watt, S.B.; Wood, W.E.

HAND DUG WELLS AND THEIR CONSTRUCTION

Intermediate Technology Publications Ltd., London, 1976, 234 p.

8. surface water intake

8.1 River water intake

In tropical countries, rivers and streams often have a wide seasonal fluctuation in flow. This affects the quality of the water. In wet periods, the water may be low in dissolved solids content but often of a high turbidity. In dry periods, river flows are low and the load of dissolved solids is less diluted.

Mountain streams sometimes carry a high silt load but the mineral content is mostly low and human pollution frequently absent. In plains and estuaries, rivers usually flow slowly except when there is a flood. The water may be relatively clear but it is almost always polluted, and treatment will be necessary to render it fit for drinking and domestic purposes.

The quality of river water will usually not differ much across the width and depth of the river bed. The intake, therefore, may be sited at any suitable point where the river water can be withdrawn in sufficient quantity. The design of a river water intake should be such that both clogging and scouring will be avoided. The stability of the intake structure should be secured, even under flood conditions.

Where the river transports no boulders or rolling stones that would damage the intake, an unprotected intake may be adequate (Fig. 8.1).

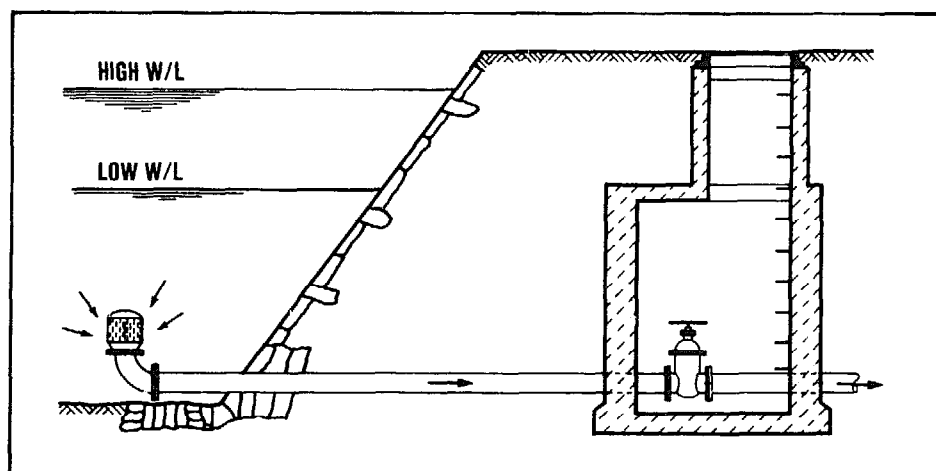

Figure 8.1.
Unprotected river intake

In cases where protection of the intake is necessary, intake structures of the type shown in Fig. 8.2 may be suitable.

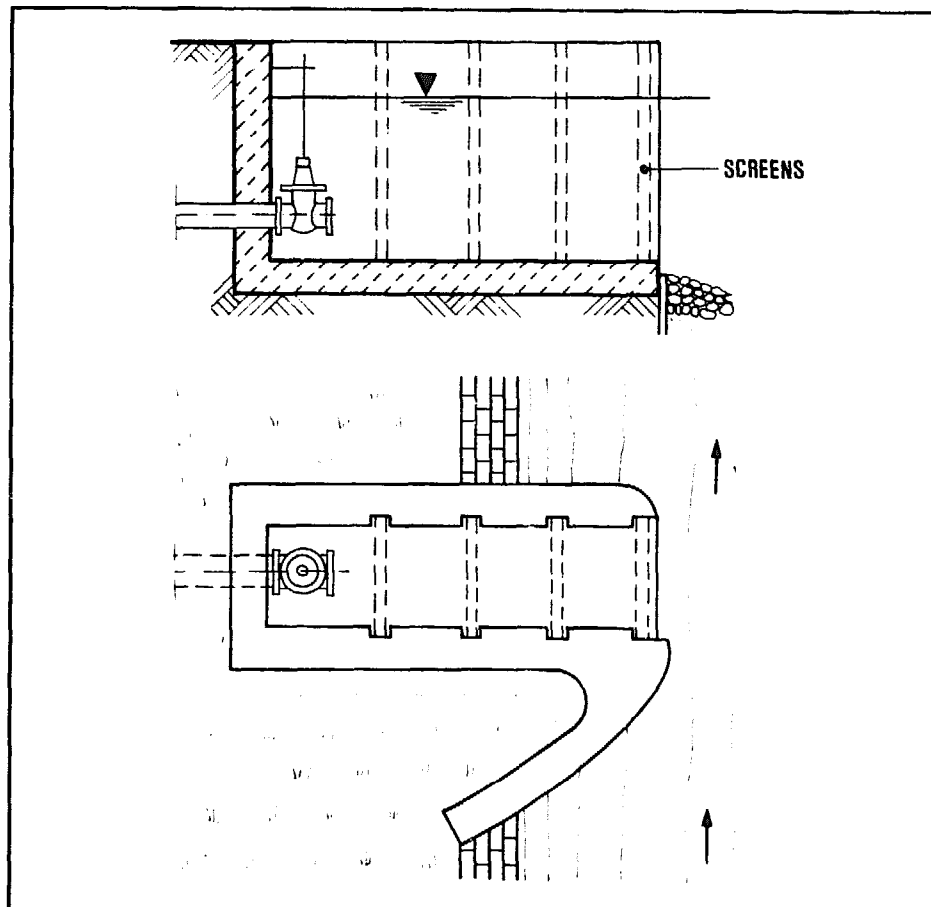

Figure 8.2.
River intake structure

The bottom of the intake structure should be at least 1 m above the river bed to prevent any boulders or rolling stones from entering. A baffle may be needed to keep out debris and floating matter such as tree trunks and branches. To reduce the drawing in of silt and suspended matter, the velocity of flow through the intake should be low, preferably less than 0.1 m/sec.

A river intake always requires a sufficient depth of water in the river bed. A submerged weir across the river may have to be constructed downstream of the intake to ensure that the necessary depth of water will be available, even in dry periods.

Frequently, pumping is needed for the intake of water from river sources. If the variation between the high and low water level in the river is not more than 3.5-4 m, a suction pump placed on the river bank may be used (Fig. 8.3).

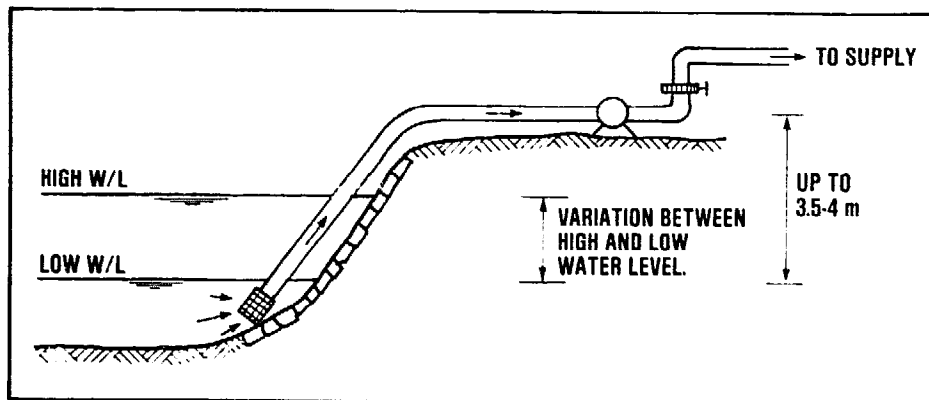

Figure 8.3.
Pumped river water intake

A different intake arrangement is needed if the required pumping head exceeds 3.5-4 m. One arrangement worth considering uses a sump constructed in the river bank. The river water is collected with infiltration drains laid under the river bed; under gravity it flows into the sump. As the lowest water level in the sump will probably be too deep for a suction pump placed above ground, the water is usually drawn with a submersible pump, or a spindle-driven pump, positioned down in the sump.

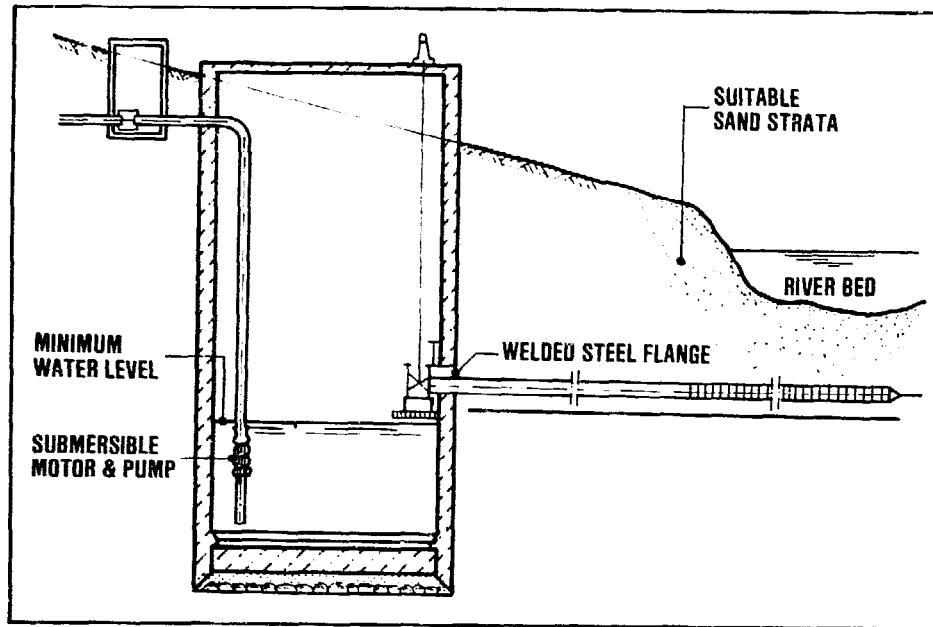

Figure 8.4.
Bank river intake using infiltration drains

8.2 Lake water intake

The quality of lake water is influenced by self-purification through aeration, bio-chemical processes, and settling of suspended solids. The water can be very clear, of low organic content and with high oxygen saturation. Usually, human and animal pollution only present a health hazard near the lake shores. At some distance from the shore, the lake water is generally free from pathogenic bacteria and viruses. However, algae may be present, particularly in the upper water layers of lakes.

In deep lakes, the wave action and turbulence caused by the wind striking the surface will not affect the deeper strata. There being no mixing, a thermal stratification will develop with the warmer upper water layers floating on top of the cooler deeper ones which have a higher mass density. As a result of the thermal stratification, the deeper water layers may differ in quality from the upper water. The thermal stratification can be fairly stable especially under tropical conditions. Fig. 8.5 gives an example.

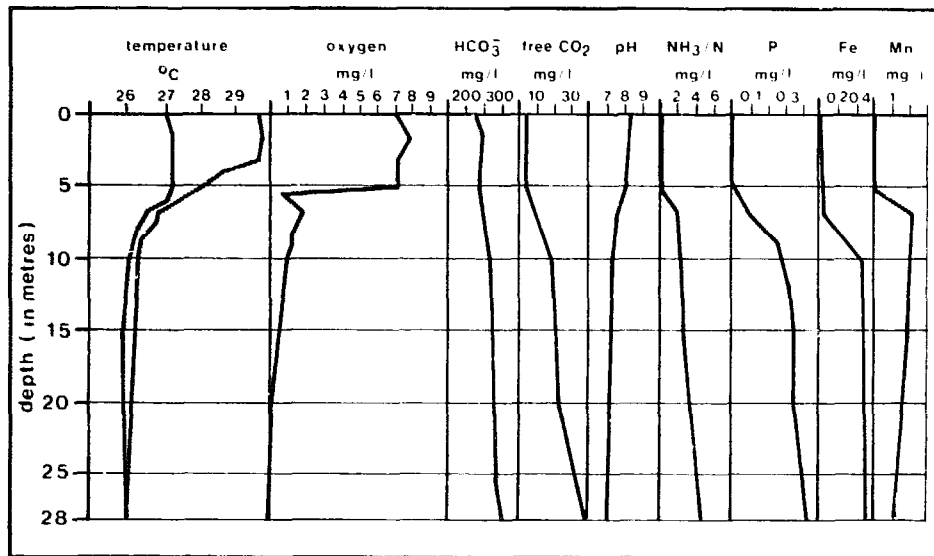

Figure 8.5.
Water quality variation with depth in a deep lake (Indonesia)

The thermal stratification should be taken into account when the location and depth of a lake water intake for water supply purposes is decided upon. The presence of algae in the upper water layers is another relevant factor.

In deep lakes with water of a low nutrient content (nitrates, phosphates, etc), the chemical quality of the water will be much the same throughout the full depth. For water supply purposes, water from deeper strata will have the advantage of a practically constant temperature. Provision should be made to withdraw the water at some depth below the surface (Fig. 8.6).

Deep lakes containing water with a high nutrient content show a marked difference of water quality at different depths. Water should be withdrawn from the upper layers of lake water containing the highest oxygen content. However, as the top layer of water may have become warmed up, the intake of water for water supply should preferably be 3-5 m below the surface.

In shallow lakes, the intake should be sufficiently high above the lake bottom to avoid the entrance of silt (Fig. 8.7).

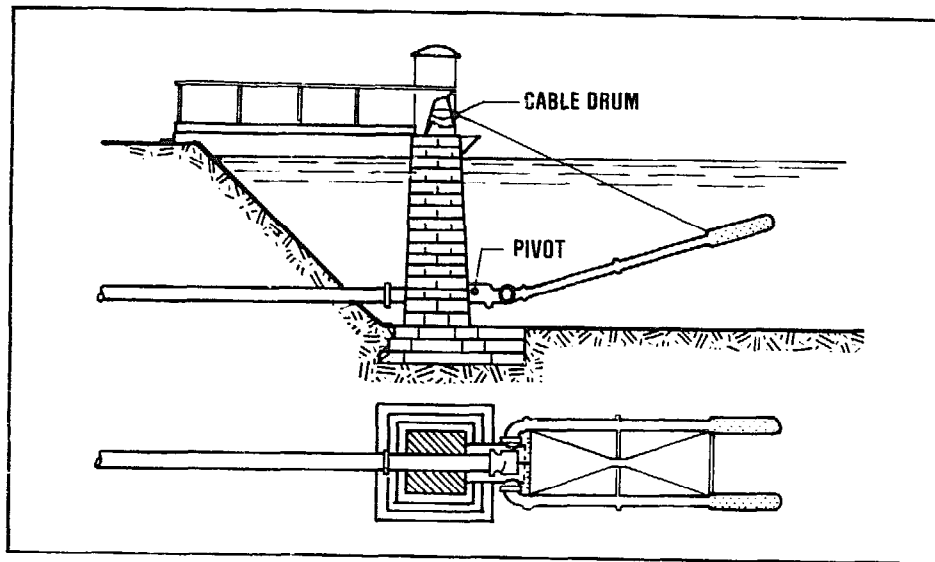

Figure 8.6.
Variable depth lake water intake.

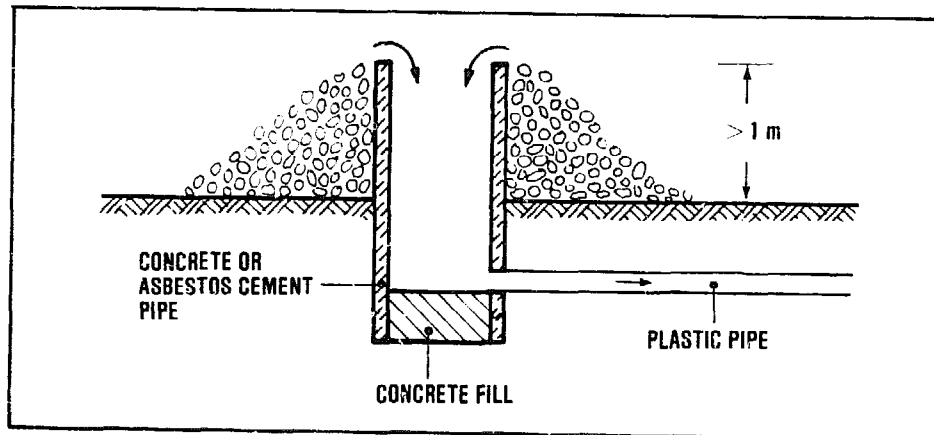

Figure 8.7.
Intake structure at bottom of shallow lake.

8.3 Typical intake constructions

For small community water supplies the quantity of water needed being small, often very simple intake structures can be used. With a per capita water use of 30 litres/ day and the peak intake 4 times the average water demand, 1,000 people would require an intake capacity of only 1.4 litres/sec. A 150 mm intake pipe would be sufficient to keep the entrance

velocity of flow below 0.1 m/sec. If an entrance velocity of flow of 0.5 m/sec is allowed, a pipe as small as 60 mm would be adequate.

For small capacity intakes, simple arrangements using flexible plastic pipe can be used (Fig. 8.8).

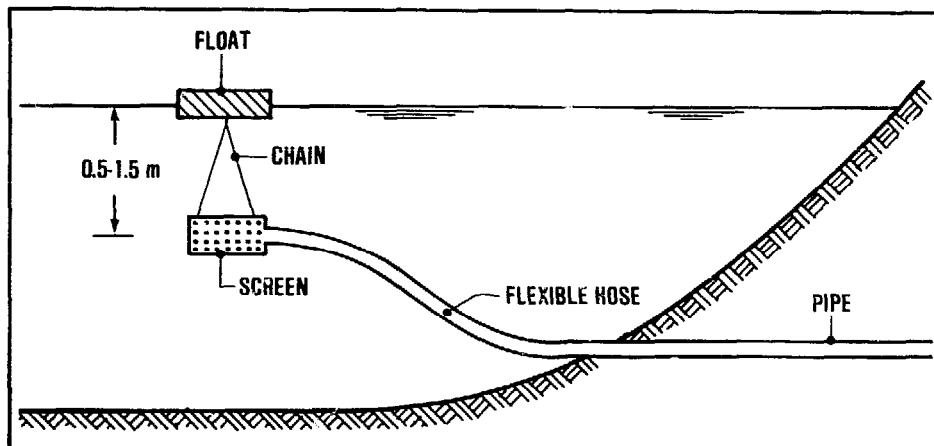

Figure 8.8.
Simple water intake structure

Another intake construction using a floating barrel to support the intake pipe, is shown in Fig. 8.9. The water is pumped from the well sump.

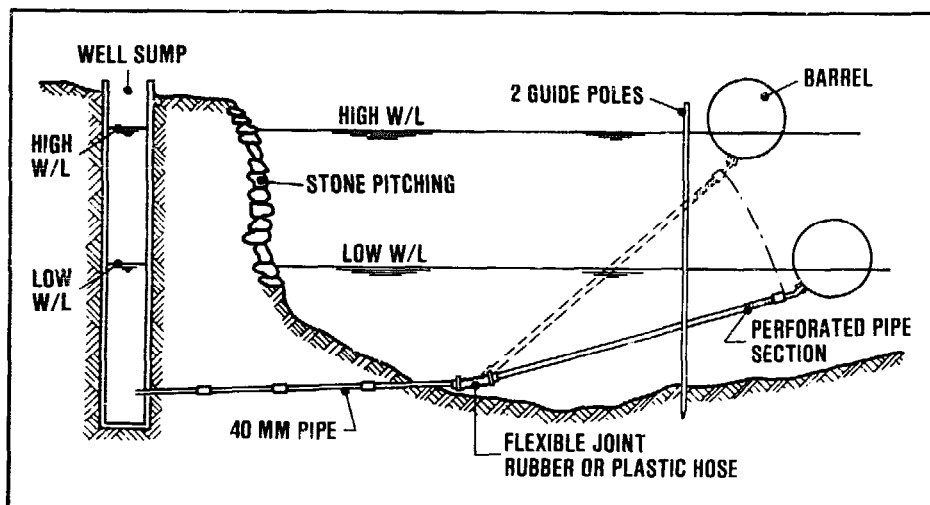

Figure 8.9.
Float intake

8.4 Small dams and village ponds

There are many small communities whose only source of water supply is a small dam or pond. These are called "hafir" (Sudan), "tapkis" (Nigeria), "represa" (South America), "tank" (India), "pond" (Eastern Africa), or other local names. In this handbook they are all referred to as small dams or village ponds.

Small dams and village ponds vary in area from small to large ones of several hectares. They may be entirely natural in origin - depressions in flat areas - or specially constructed for the purpose. If man-made, they may have been excavated for the express purpose of holding water or they may be pits from which clay for building has been taken. Many are a combination of natural and man-made pools which have been deepened or enlarged over the years to increase their holding capacity.

Some are to be found inside villages or small towns. More usually, they are located just outside the village area. In India they are often stocked with fish which provides a valuable source of food for the villagers.

Unfortunately, they are also used for washing and bathing. More often than not they are polluted, hazardous at best, and potential spreaders of epidemics. Too often they harbour pathogenic bacteria, viruses and parasites which account for incalculable numbers of illnesses and deaths, particularly amongst children.

The water may be full of silt or colloidal matter, especially immediately after the rains. Some village ponds have been in existence for centuries; they may be full of aquatic vegetation. Some are the recipients of refuse of all sorts. Others are relatively well-kept, beautiful in appearance and a distinctive feature of the landscape.

In practice, it is impossible to prevent the pollution of these small dams and village ponds. By their very nature they are at the lowest point of the surrounding area and all the village drainage finds its way into them.

In a newly excavated pond, the construction of an intake presents no difficulty if carried out before the tank fills. In an established pond, work must be done while the water is in use. Probably all the work will be done by hand and no special tools will be

available. In ponds where the water has high turbidity, the water is best drawn from just below the surface. A floating intake device may be suitable. Plastic pipe could be used instead of galvanized iron for the collecting pipe; bamboo might also be used for this purpose. The floating support may be made of bamboo or other locally available materials.

The presence of algae and other aquatic vegetation, as well as fish, in the pond will make it necessary to fix a strainer around the intake. The level of the intake opening must be below the lowest drawoff point, if syphoning is to be avoided. A well may be dug close to the bank and the intake pipe either thrust (using a heavy jack) or driven from the well into the pond. The pipe is then capped while the well is lined with masonry or concrete, and the floating intake fixed. The well should be deepened to form a sump which will allow some settlement of suspended matter.

8.5 Screens

Screening of water is done by passing the water through closely spaced bars, gratings or perforated plates. Screening does not change the chemical or bacteriological quality of the water. It serves to retain coarse material and suspended matter larger than the screen openings. Even when screened-out material forms a filtering mat of deposits, the screening still is purely of a mechanical nature.

In water supply engineering, screens are used for various purposes:

- (i) Removal of floating and suspended matter of large size which otherwise might clog pipelines, damage pumps and other mechanical equipment, or interfere with the satisfactory operation of the treatment processes. Fixed screens are used for this purpose and they are cleaned on site by hand or mechanically;
- (ii) Clarification of the water by removal of suspended matter even of small size, to lighten the load on the subsequent treatment processes. In particular they are used to prevent filters from becoming clogged too rapidly.

Bar screens usually consist of steel strips or bars spaced at 0.5 to 5 cm. If the amount of material expected to be screened out is small the bars are set quite steeply, at an angle of 60-75° to the horizontal, and cleaning is done by hand using rakes. If larger amounts will be retained, the cleaning by hand should still be feasible; to facilitate the cleaning work, the bars should be placed at an angle of 30-45° to the horizontal (Fig. 8.10).

The water should flow towards the bar screen at a quite low velocity, 0.1 - 0.2 m/sec. Once the water has passed the screen, the flow velocity should be at least 0.3 - 0.5 m/sec in order to prevent the settling out of suspended matter.

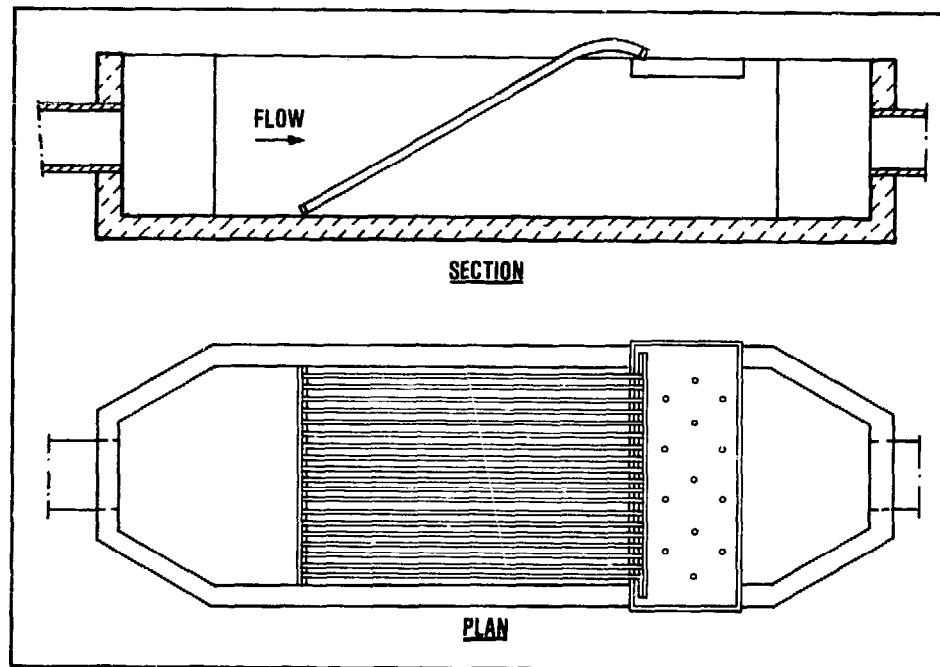

Figure 8.10.
Fixed bar screen

In the openings between the bars the velocity of flow should be limited to 0.7 m/sec; otherwise soft, deformable matter will be forced through the screen openings. A clean screen will allow the water to pass with a head loss of only a few centimetres. However, the head loss rises sharply when the clogging of the screen builds up. Regular cleaning should keep the head loss limited to 0.1 - 0.2 m head of water. Allowing for delayed cleaning and mechanical failures, it is good practice to design a bar screen for a head loss of 0.5 - 1.0 m.

Surface water intake

DESIGN OF SMALL DAMS

U.S. Bureau of Reclamation, Washinton, D.C. 1973

Instituto de Ingenieria Sanitaria

ABASTECIMIENTOS DE AQUA POTABLE A COMUNIDADES RURALES

Facultad de Ingenieria, Universitado de Buenos Aires, 1971

Institute of Water Engineers

MANUAL OF BRITISH WATER ENGINEERING PRACTICE (4th Edition)

W. Heffer & Sons Ltd., Cambridge, 1969

Wood, J.L.; Richardson, J.

DESIGN OF SMALL WATER STORAGE AND EROSION CONTROL DAMS

Colorado State University, Fort Collins, Colorado, 1975 74 p.

9. artificial recharge

9.1 Introduction

Groundwater usually has the great advantage over surface water from rivers and lakes in that it is free from pathogenic organisms and bacteria causing water-related diseases. However, groundwater is not always available and the amounts that can be withdrawn are usually limited. As indicated previously, in the long run the withdrawal of groundwater cannot exceed the amount of natural recharge. Therefore, when this recharge is small, the safe yield of the aquifer is also small. Under suitable conditions it is possible to supplement the natural recharge of an aquifer and so add to its safe yield capacity. This is called artificial recharge. It involves measures to feed water from rivers or lakes into the aquifer, either directly or by spreading the water over the infiltration area allowing it to percolate downward to the aquifer. Artificial recharge can have great potential for improving small community water supplies in many parts of the world.

Apart from adding to the yield of an aquifer, artificial recharge also provides purification of the infiltrated water. When water from a river or lake flows through a granular ground formation (Fig. 9.1), filtration will take place with a substantial removal of the suspended and colloidal impurities, bacteria and other organisms. The aquifer acts as a slow sand filter.

Provided that the water is recovered at a sufficient distance from the point of recharge, preferably more than 50 m, the water will flow underground for a considerable time, normally two months or more. As a result of the bio-chemical processes, adsorption and filtration, the water will become clear and safe for domestic use. In many instances it can be used without any further treatment.

The principal methods of artificial recharge of aquifers are bank infiltration and spreading of the water over permeable ground surfaces.

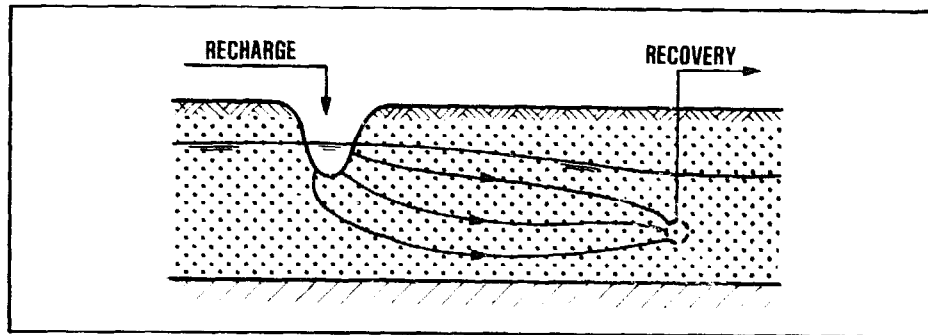

Figure 9.1.
Artificial recharge of aquifer

If artificial recharge is combined with underground storage of the water, water taken from a river in the wet season can be stored in the aquifer and recovered during the dry period when the river flow is small or absent (Fig. 9.2). It will often be much easier and more economical to provide such underground storage of water rather than surface reservoirs. This is particularly the case in flat land. Additional advantages are the great reduction of evaporation losses of water and the prevention of algal growth.

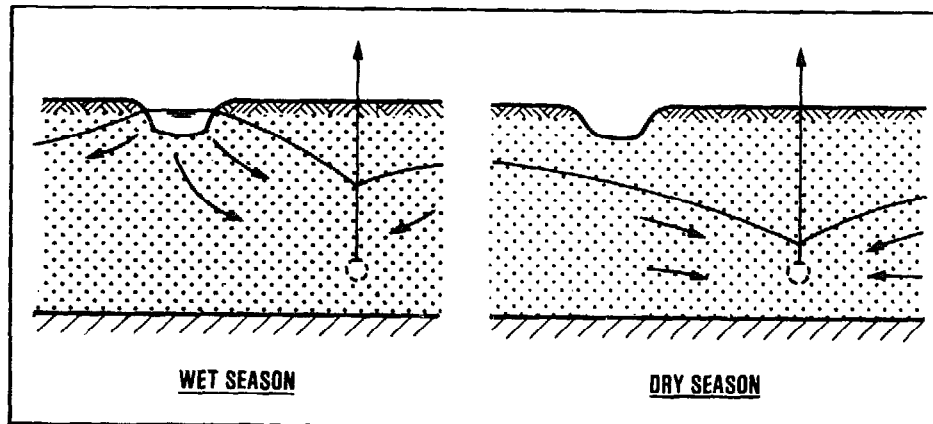

Figure 9.2.
Artificial recharge with underground storage of water

9.2 Bank infiltration

For bank infiltration (induced recharge), galleries or lines of wells are placed parallel to the shore-

line of a river or lake, at a sufficient distance. This is shown in Fig. 9.3.

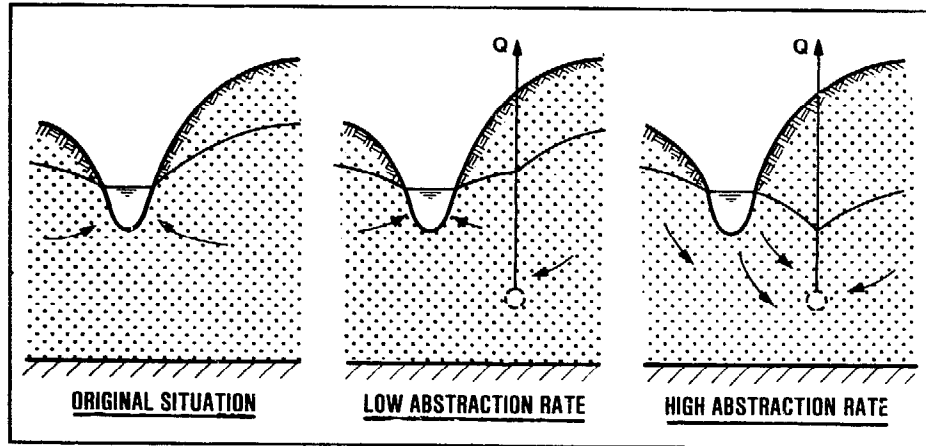

Figure 9.3.
Bank infiltration

In the original situation the outflow of groundwater feeds the flow of the river. When amounts of groundwater are withdrawn, the flow of groundwater into the river will fall. The withdrawal of groundwater results in a lowering of the groundwater table. For high abstraction rates, the groundwater table near the shoreline may be drawn down below the water level in the river. Water from the river will be induced to enter the aquifer. Provided that the permeability of the stream bed is adequate, considerable amounts of water may thus be recovered without much affecting the groundwater table further inland (Fig. 9.4). The abstracted water will, for the most part, be induced recharge, that is water originating from the river.

Apart from hydrogeological factors, the design of an induced recharge scheme is governed by two factors: the rate of groundwater withdrawal (q) from the gallery or line of wells, and the distance (L) (see Fig. 9.4). In order to provide for sufficient time for the purification processes in the water during its flow from the river to the gallery, the distance L should not be less than 20 m and preferably 50 m or more. The important parameter is the time the water travels underground. Three weeks is a minimum and whenever possible, it should be two months or more.

Of course, the travel time not only depends on the distance L but also on the rate of withdrawal (q), and the thickness and porosity of the aquifer.

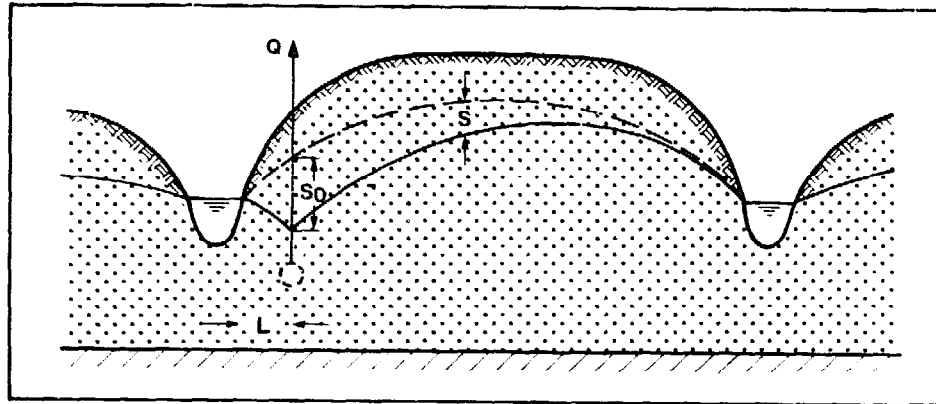

Figure 9.4.
Induced recharge

Induced recharge is particularly useful in cases where the natural recharge of an aquifer is small, for example, an aquifer of narrow width consisting of thin bands of pervious ground formations running alongside the river (Fig. 9.5). The safe yield of such an aquifer obtained from the natural recharge only, will be very limited but large amounts of water may be withdrawn when induced recharge is practiced.

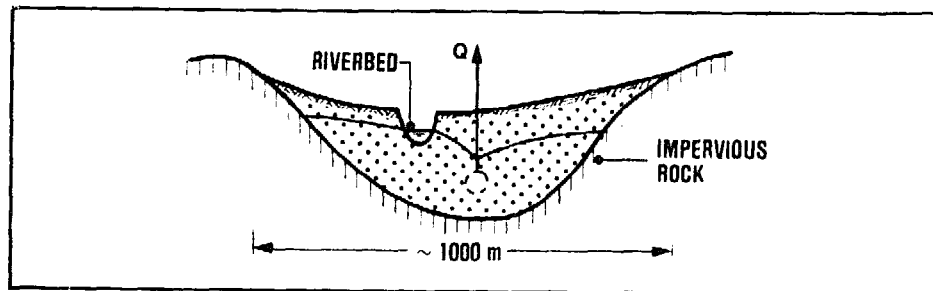

Figure 9.5.
Induced recharge and groundwater recovery from an aquifer of small width

The means for recovery of the recharged water may also be set in the river bed itself. Fig. 9.6 shows a line of jetted well points interconnected by a cen-

tral suction line. Another option is a horizontal collector drain placed under the river bed (Fig. 9.7).

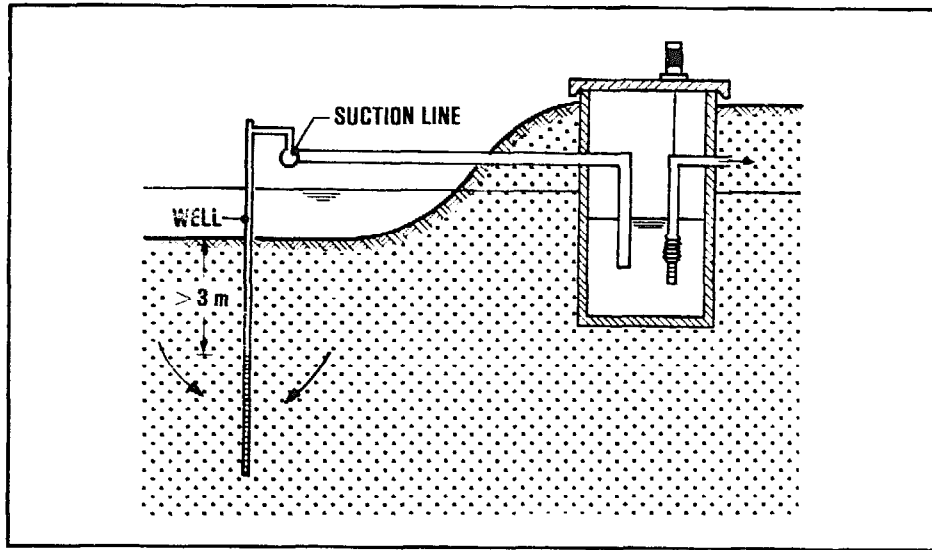

Figure 9.6.
Line of wellpoints placed in riverbed

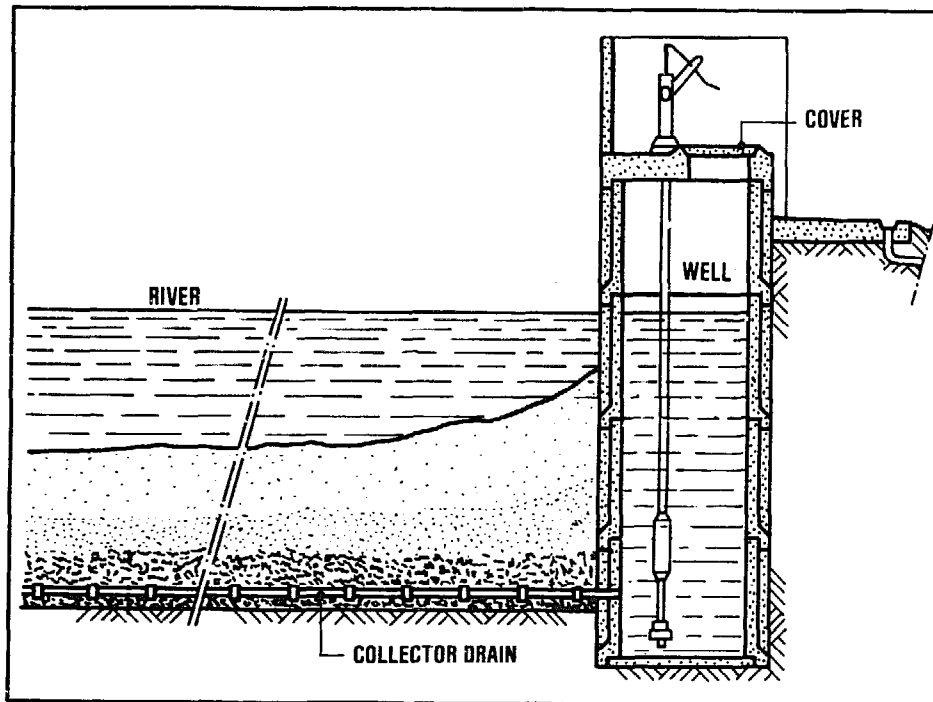

Figure 9.7.
Horizontal collector drain under river bed

With induced recharge, river water is made to enter the aquifer through the stream bed. At the river bed some clogging will take place, as a result of deposits of suspended particles and precipitation of dissolved solids. This clogging will gradually create an infiltration head loss (see Fig. 9.8).

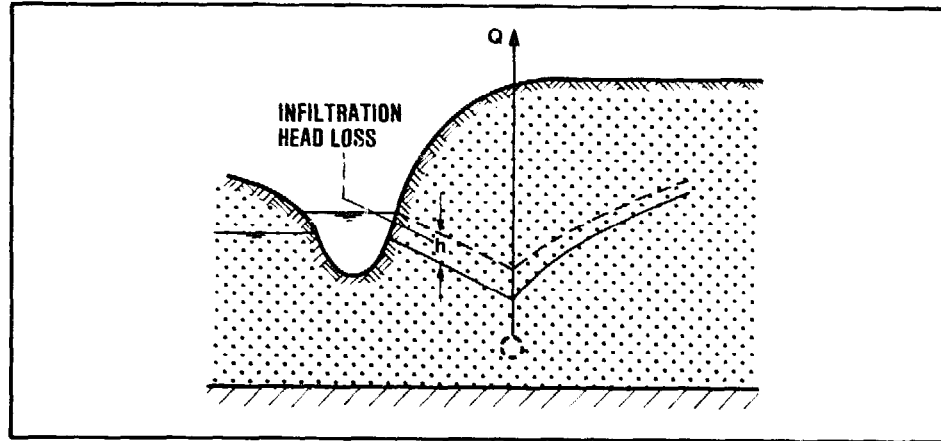

Figure 9.8.
Infiltration head loss on river bed due to clogging

Usually, the clogging of the river bed presents no serious problems, as flood flows in the river will periodically scour the river banks and wash away the deposits. In rivers with dams for flood control, however, scouring of the banks may be absent or infrequent. The clogging of the infiltration area can then increase to the point that the rate of induced recharge is greatly reduced. In theory, this could be remedied by a cleaning of the river bed but this is difficult and often impractical.

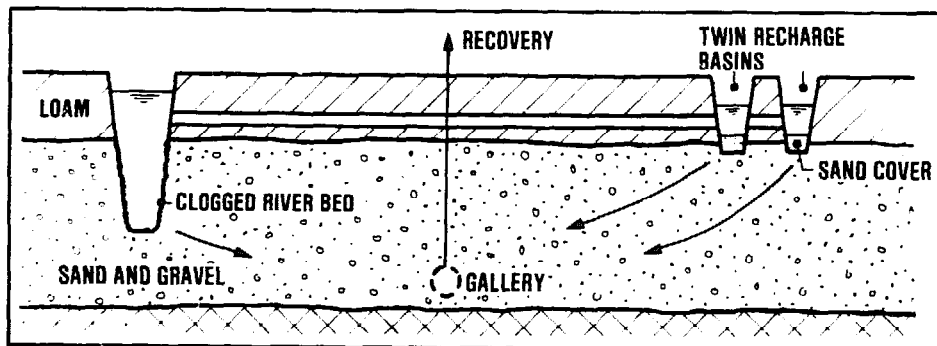

Figure 9.9.
Basins for recharge of aquifer using river water

In such cases, it may be advantageous to construct twin spreading basins that are filled with water from the river (Fig. 9.9). The bottom of these basins is covered with a layer of medium coarse sand, about 0.5 m thick. Clogging will now be restricted to the upper centimetres of this bed and can be readily removed by scraping.

9.3 Water spreading

The bank filtration described in the previous section can only be used where a suitable aquifer is adjacent to the source of surface water. Sometimes, both a suitable aquifer and a water source are present but some distance apart. Artificial recharge then can be practised but the water from the river, lake or other source has first to be transported to those sites where ground formations suitable for infiltration and underground flow are available. This certainly represents a complication of the recharge scheme but important additional advantages are attained:

- (i) The intake of water can be stopped when the river water is polluted or otherwise of poor quality;
- (ii) A saving in cost may be achieved when the recharge scheme is situated near the water distribution area.

A comprehensive scheme for artificial recharge by water spreading is shown in Fig. 9.10. It includes pre-treatment of the water before recharge in an infiltration basin, and further treatment after recovery.

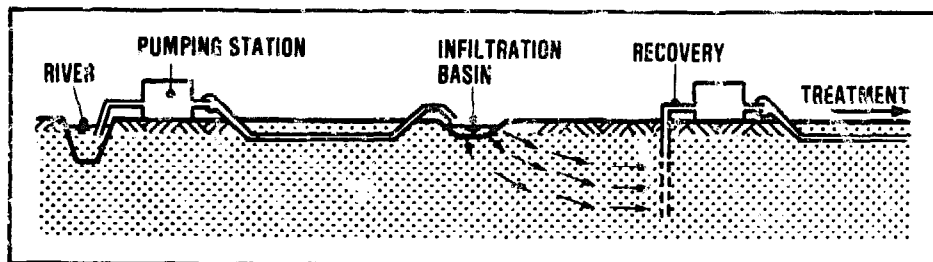

Figure 9.10.
Scheme for artificial recharge and recovery

Pre-treatment may be necessary to avoid that silt is deposited in the pipeline, or that microbiological slimes are formed which would greatly reduce the

pipeline's carrying capacity. It will also reduce the clogging of the recharge basin so that less frequent cleaning will be needed. Further it will protect the aquifer from becoming fouled by non-degradable organic substances. Treatment of the water recovered from the recharge scheme is necessary in the event that quality is still not satisfactory. This may for instance be the case when during its underground travel the water has become anaerobic and has picked up iron and manganese from the sub-soil.

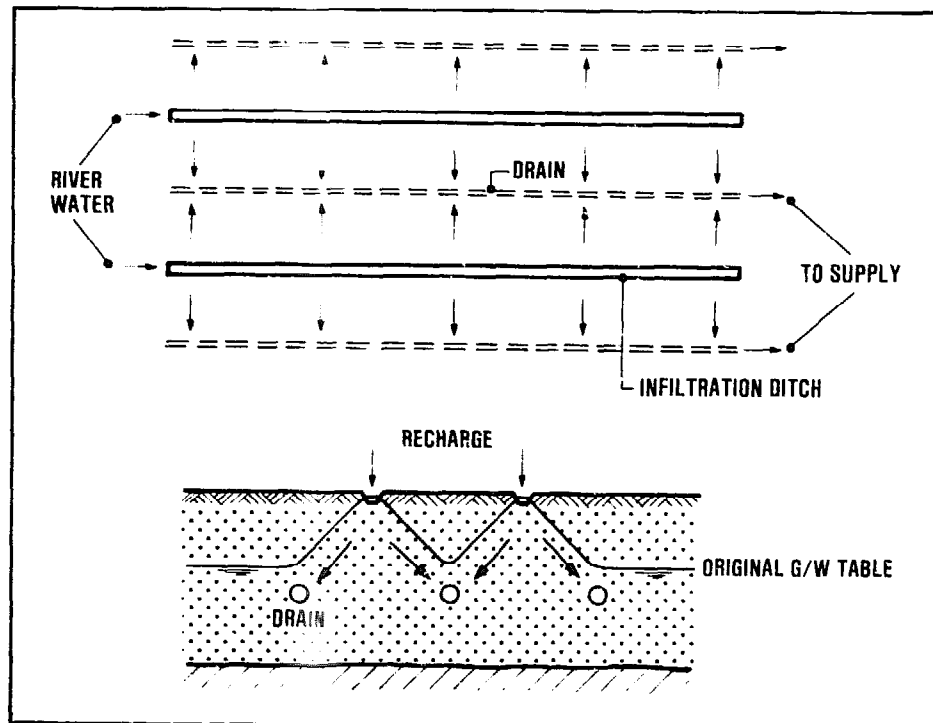

Figure 9.11.
Water recharge in shallow aquifer using infiltration ditches and drains

The design of an artificial recharge scheme depends on three factors:

- (1) The infiltration rate of the water in the water spreading basins. This rate should be so low that the basins will only require cleaning after a considerable period of time, at least several months and preferably one year or more;
- (ii) The travel time and length of the underground water flow;

- (iii) The maximum allowable difference of level between the water in the spreading basins and the groundwater table.

In combination, these factors indicate that for the artificial recharge of shallow aquifers, particularly aquifers with fine grain composition, the spreading basins should be constructed as ditches, with galleries for groundwater recovery constructed parallel to them (Fig. 9.11). For deep aquifers, particularly those having a coarse grain composition, the spreading basin preferably should be constructed as a pond surrounded by a battery of recovery wells (Fig. 9.12).

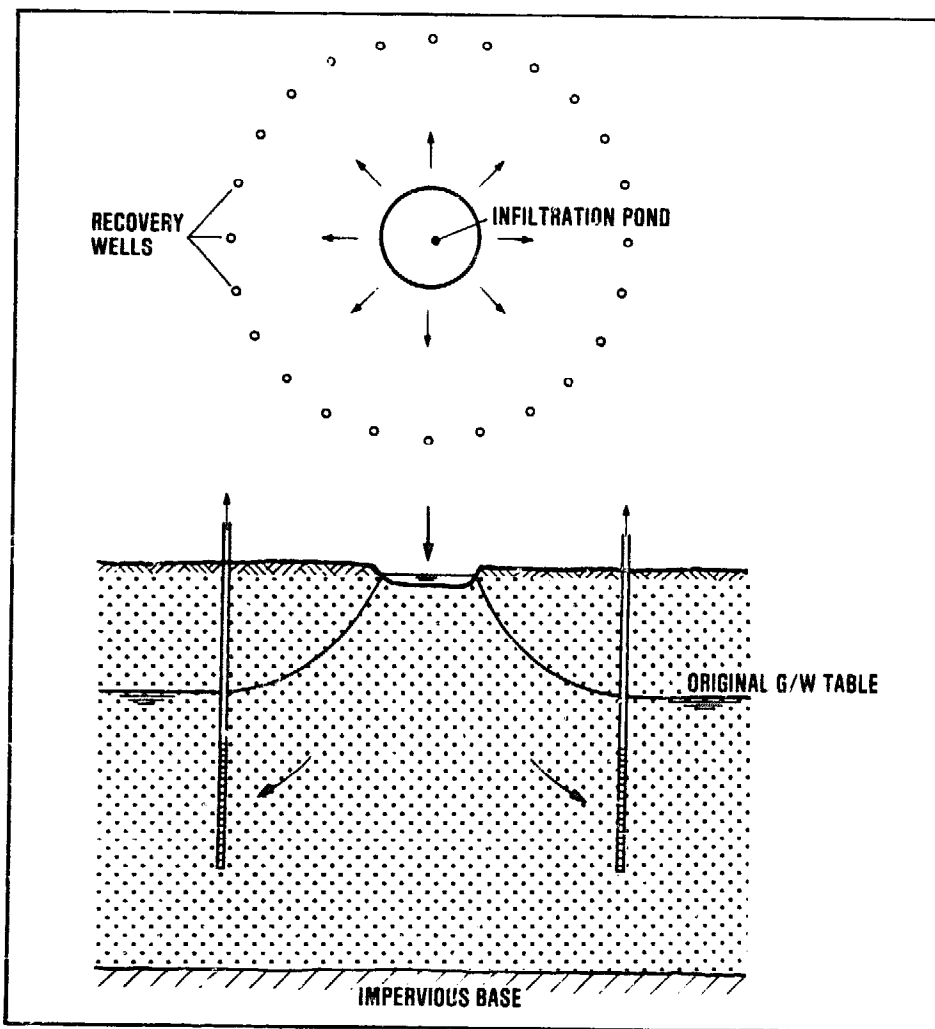

Figure 9.12.
 Recharge of a deep aquifer using an infiltration pond and recovery wells.

The artificial recharge schemes as described above are quite suitable for small community water supplies, particularly in rural areas. For the limited water requirements to be met from these supplies, treatment of the water is often not a feasible proposition. To serve 200 people having a per capita water use of 15 litres/capita/day, the required capacity would only be $3\text{m}^3/\text{day}$. Using artificial recharge, this can be readily provided. To provide a retention time of the water underground of 60 days (2 months), an aquifer having 40% pore space would need to be 450m^3 in volume to serve the purpose. Assuming an average saturated thickness of 2 m, the surface area would be 225m^2 ; for instance, 7.5 m wide and 30 m long. This can easily be constructed in the form of an excavation of 3 m deep, lined with a layer of puddled clay or plastic sheeting to avoid seepage losses (Fig. 9.13).

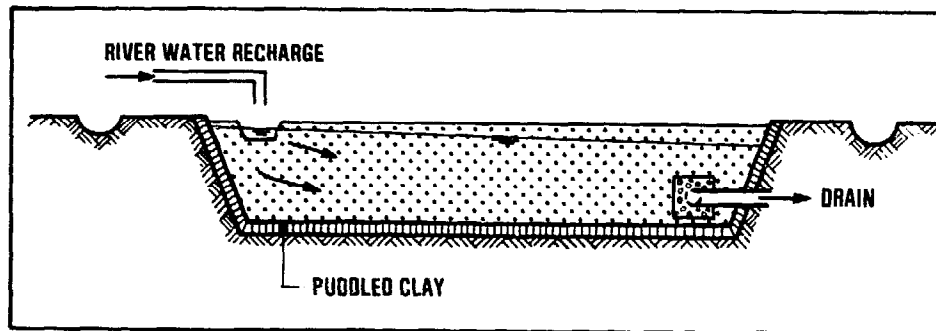
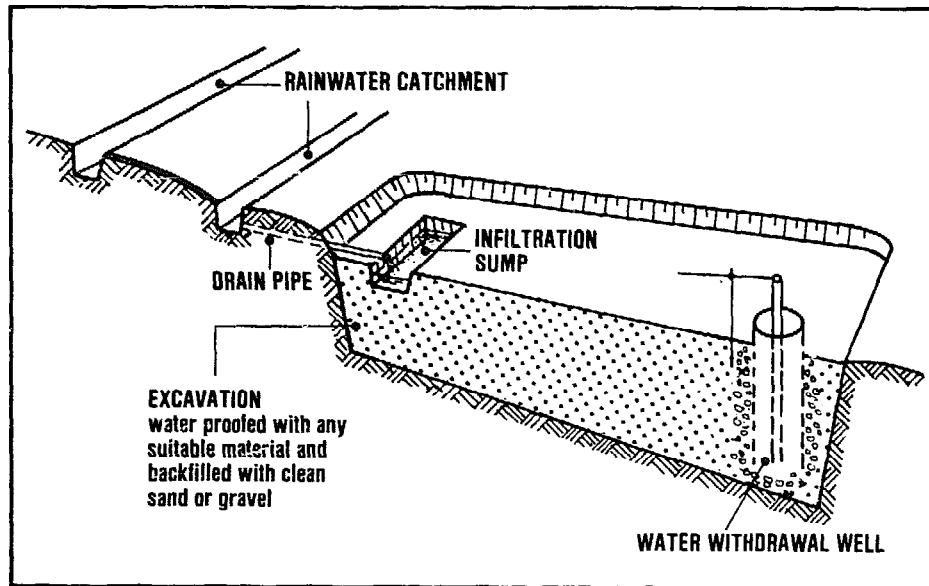

Figure 9.13.
Small-capacity recharge scheme

The possible utilization of rainwater for recharge purposes is shown in Fig. 9.14.



Source: ITDG

Figure 9.14.
Artificial recharge using rainwater

9.4 Sand dams

Sand dams are reservoirs filled with coarse sand, stones or loose rock. The water is stored in the pores of the accumulated bed of sand. This greatly reduces the evaporation losses of water. Sand dams are, therefore, particularly useful in areas where evaporation rates are high. They have been constructed in many of the semi-arid areas of Africa and the Americas. Water may be stored for long periods, and even under total drought conditions sand dams can provide water from the stored volume.

Water is withdrawn from the sand dam by a drain pipe or from a well dug into the sand bed near to the dam (Fig. 9.15). Usually the water can be used without any treatment, as it is filtered while flowing through the sand bed.

In the semi-arid areas where the use of sand dams is most appropriate, flood waters often carry a high sediment load because there is little vegetation to prevent erosion of the soil. Considerable amounts of sand and gravel are carried by the flood waters. Thus, when the dam wall for a storage reservoir is built in a river bed during the dry season, the flood waters in the wet season will deposit the sand and

gravel behind it. The flood waters will also carry substantial quantities of mud. To ensure that mainly sand and gravel are deposited behind the dam, the dam wall should first be built to a height of only about 2 m. Later the wall should be raised as the sand and gravel deposits build up. The staged raising of the dam will enable the mud to be carried over it by the overflowing flood waters. After four or five years, the dam may reach its full height (usually 6-12 m).

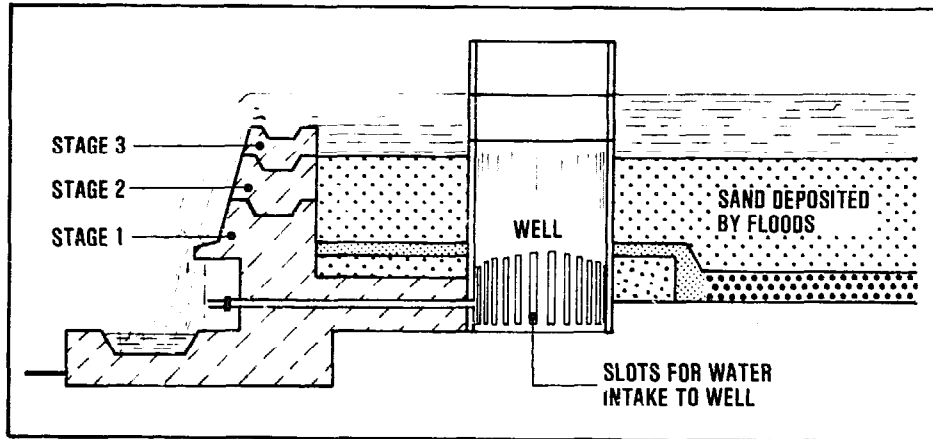

Figure 9.15.
Sand dam (schematic)

Sand-fill dams can be used with particular advantage for artificial recharge because they allow most of the finer sediments in flood water to be carried away with the overflow. Thus, the clogging of aquifers by silt-laden water which can give problems in recharge systems, is here avoided.

Artificial recharge

ARTIFICIAL RECHARGE AND MANAGEMENT OF AQUIFERS

Report of Symposium, Haifa, 1967

International Association of Scientific Hydrology, 1968
(Publication No. 72)

Bize, J.; Bourguet, L.; Lemoine, J.

L'ALIMENTATION ARTIFICIELLE DES NAPPES SOUTERRAINES

Masson et Cie, Paris, 1972

Buckan, S.

ARTIFICIAL REPLENISHMENT OF AQUIFERS

In: Journal of Institution of Water Engineers, 1955, pp. 111-163

GROUNDWATER STORAGE AND ARTIFICIAL RECHARGE

United Nations, New York, 1975, 270 p.

(Natural Resources/Water Series No. 2/ST/ESA/13)

Huisman, L.

ARTIFICIAL RECHARGE

In: Proceedings Sixth International Water Supply Congress,
Stockholm, 1964.

International Water Supply Association, pp. 11-18

Jansa, M.

ARTIFICIAL REPLENISHMENT OF UNDERGROUND WATER

In: Proceedings Second International Water Supply Congress,
Paris, 1952

International Water Supply Association, pp. 149-191

Meinzer, R.

GENERAL PRINCIPLES OF ARTIFICIAL GROUNDWATER RECHARGE

In: Economic Geology, 1946, pp. 191-201

Muckel, D.C.

REPLENISHMENT OF GROUNDWATER SUPPLIES BY ARTIFICIAL MEANS

United States Department of Agriculture, 1959

(Technical Bulletin No. 1195)

10. pumping

10.1 Introduction

Water pumping technology developed parallel to the sources of power available at the time. Indeed one can say that our first ancestor who cupped his hands and fetched water from a stream, chose the 'pumping' technique appropriate to him. Modern devices such as centrifugal pumps have reached a high state of development and are widely used, particularly in developed countries, only because suitable power sources such as diesel engines and electric motors became available.

For small communities in developing countries, human and animal power are often the most readily available power for pumping water, particularly in rural areas. Under suitable conditions, wind power is of relevance. Solar energy can have potential. Diesel engines and electric motors should only be used, if the necessary fuel or electricity supplies are available and secured, together with adequate maintenance and spare parts.

10.2 Power sources for pumping

Human Power

A manual pumping device* (including devices operated by foot) is any simple device powered by human power. They are capable of lifting relatively small amounts of water. Using human power for pumping water has certain features that are important under the conditions of small and rural communities in developing countries:

- The power requirements can be met from within the users' group;
- The capital cost of manually-operated pumps is generally low;
- The discharge capacity of one or more manual pumping devices is usually adequate to meet the domestic water requirements of a small community.

* Often referred to as: 'hand pump'



Photo: Matthijs de Vreede

*Figure 10.1.
Hand-pumped water supply (Bangladesh)*

The power available from the human muscle depends on the individual, the environment, and the duration of the task. The power available for work of long duration, for example 8 hours per day, by a healthy man is often estimated at 60 to 75 watts (0.08 to 0.10 horsepower). This value must be reduced for women, children and the aged. It also must be reduced for high temperature, and work environments with high humidity. Where the pump user and the pump are poorly matched, much of the power input is wasted; for example, when a person operates a pump from a stooped position.

Animal Power

Draught-animals are a common and vital source of power in many developing countries. Animal power is poorly suited to operate small-diameter pump devices fitted on covered wells. Animals are widely used for lifting irrigation water from large-diameter, open wells but these should not be used for community water supply purposes. The most efficient use of animals is at fixed sites where they pull rotating circular sweeps or push treadmills. Both methods

require gears and slow moving, large displacement pumps. Bullocks and donkeys are mostly used.

Windpower

The use of windpower for pumping water should be feasible if:

- Winds of at least 2.5 - 3 m/sec. are present 60% or more of the time;
- The water source can be pumped continuously without excessive drawdown;
- Storage is provided, typically for at least 3 days' demand, to provide for calm periods without wind;
- A clear sweep of wind to the windmill is secured, i.e. the windmill is placed above surrounding obstructions, such as trees or buildings within 125 metres; preferably the windmill should be set on a tower 4.5 to 6 metres high;
- Windmill equipment is available that can operate relatively unattended for long periods of time, for example six months or more. The driving mechanism should be covered and provided with an adequate lubrication system. Vanes, and sail assemblies should be protected against weathering.

By far the most common type of wind-powered pump is the slow-running wind wheel driving a piston pump. The pump is generally equipped with a pump rod that is connected to the drive axis of the windmill. Provision may be made for pumping by hand during calm periods.

The wind wheels range in diameter from about 2 to 6 metres. Even though the windmills themselves may have to be imported, strong towers can usually be constructed from local materials.

Modern windmills are designed to ensure that they automatically turn into the wind when pumping. They are also equipped with a 'pull-out' system to automatically turn the wheel out of excessive wind, stronger than 13-15 m/sec., which might damage the windmill. The 'sails' or fan blades can be so designed that they furl automatically to prevent the wheel from rotating too fast in high winds. The windmill will normally not begin pumping until the wind velocity is about 2.5 - 3 m/sec. Fig. 10.2 shows several typical arrangements for windmill-pumped water supply systems.

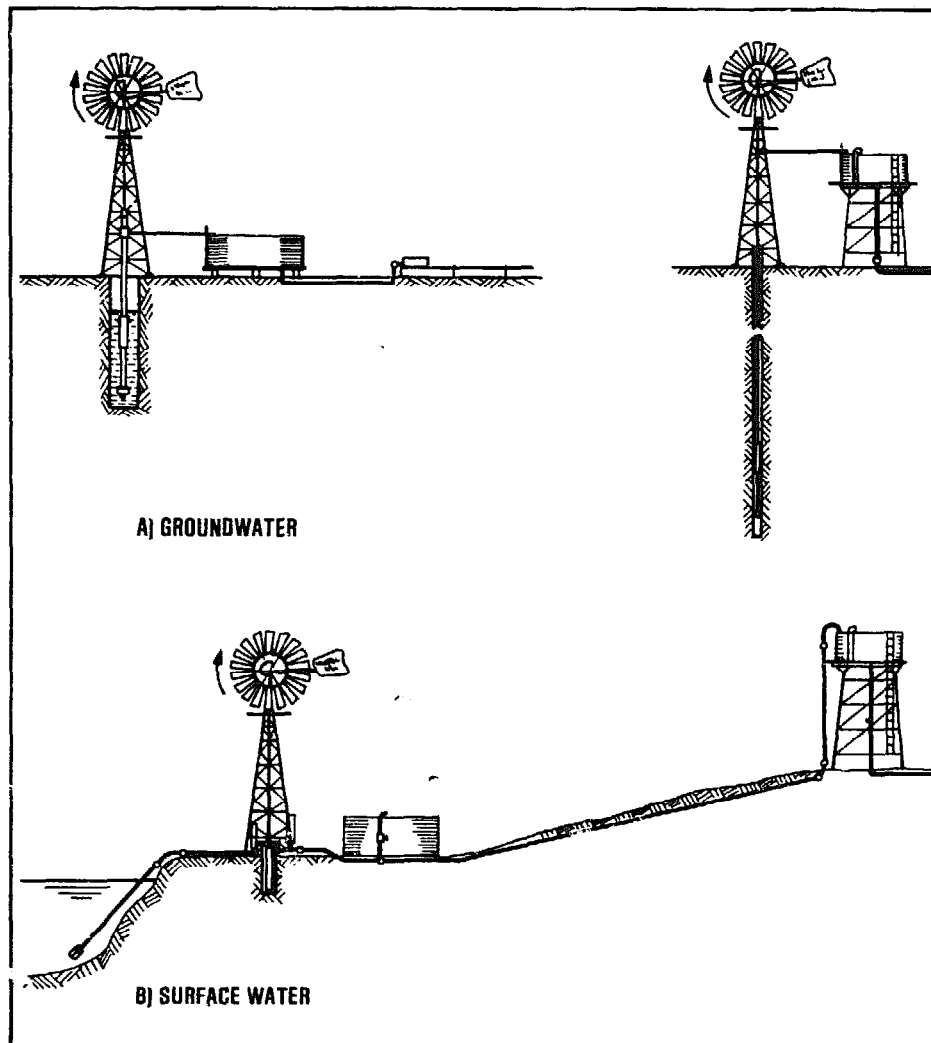

Figure 10.2.
Windmill-pumped water supply systems

Electric Motors

Electric motors generally need less maintenance and are more reliable than diesel engines. They are, therefore, to be preferred as a source of power for pumping if a reliable supply of electric power is available. In such cases, electric motors can be used to drive pumps. The electric motor should be capable of carrying the work load that will be imposed, taking into consideration the various adverse operating conditions under which the pump has to work. If the power requirement of a pump exceeds the safe operating load of the electric motor, the motor

may be damaged or burnt out. Attention must also be paid to the characteristic of the motor and the supply voltage.

There is a tendency to use general-purpose motors offered by the manufacturers without giving due consideration to the characteristics of the particular pump used, and this results in frequent failure or burning out of the motor. Squirrel-cage motors are mostly selected for driving centrifugal pumps as they are the simplest electric motors manufactured.

Diesel Engines

Diesel engines have the important advantage that they can operate independently at remote sites. The principal requirement is a supply of gasoil and lubricants and these, once obtained, can be easily transported to almost any place. Diesel engines, because of their capability to run independent of electrical power supplies, are especially suitable for driving isolated pumping units such as raw water intake pumps.

A diesel engine operates through compression of air to a high pressure, in its combustion chambers. As a result of the high compression, the temperature of the air rises to over 1,000° C. When gasoline is injected through nozzles into the chambers, the compressed air-gasoil mixture ignites spontaneously.

Diesel engines may be used to drive reciprocating plunger pumps as well as centrifugal pumps. Gearing or another suitable transmission connects the engine with the pump. For any diesel-driven pump installation, it is generally prudent to select an engine with 25-30% surplus power to allow for a possible heavier duty than under normal conditions.

10.3 Types of pumps

The main applications of pumps in small community water supply systems are:

- Pumping water from wells;
- Pumping water from surface water intakes;
- Pumping water into storage reservoirs and the distribution system, if any.

Based on the mechanical principles involved, these pumps may be classified as follows:

- Reciprocating*
- Rotary (positive-displacement);
- Axial-flow (propeller);
- Centrifugal;
- Air lift.

Another type of pump with limited application in water supply systems is the hydraulic ram.

An indication of the pump type to be selected for a particular application can be obtained from fig. 10.3. Table 10.1 gives characteristics of the various types of pumps.

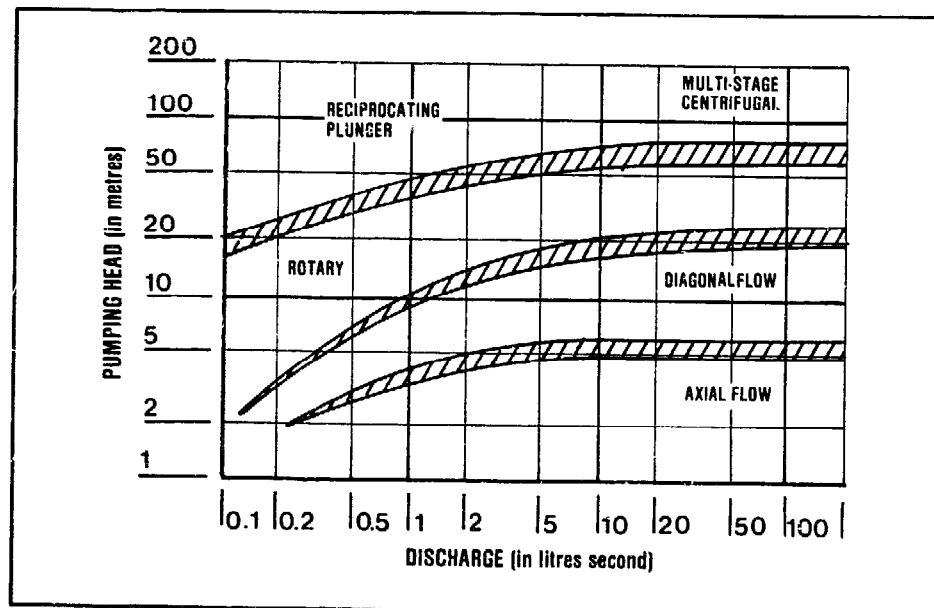

Figure 10.3.
Pump type selection chart

* Reciprocating pumps have a plunger (or piston) which moves up and down (reciprocates) in a closed cylinder for positive displacement of water. On the upward stroke the plunger forces water out through an outlet valve, and at the same time water is drawn into the cylinder through an inlet valve. The downward stroke brings the plunger back to its starting position, and a new operating cycle can begin.

Table 10.1.
Information on types of pumps

Type of Pump	Usual depth range	Characteristics and Applicability
1. RECIPROCATING (plunger)		low speed of operation; hand, wind or motor powered; efficiency low (range 25 - 60%)
a. Suction (shallow well)	up to 7 m.	capacity range: 10-50 l/min; suitable to pump against variable heads; valves and cup seals require maintenance attention.
b. Lift (deep well)		
2. ROTARY (positive displacement)		low speed of operation; hand, animal, wind powered;
a. Chain and bucket pump	up to 10 m.	capacity range: 5-30 l/min. discharge constant under variable heads.
b. Helical rotor	25 - 150 m. usually submerged	using gearing; hand, wind or motor powered good efficiency; best suited to low capacity - high lift pumping.
3. AXIAL - FLOW	5 - 10 m.	high capacity - low lift pumping; can pump water containing sand or silt.
4. CENTRIFUGAL		high speed of operation - smooth, even discharge; efficiency (range 50-85%) depends on operating speed and pumping head.
a. Single-stage	20 - 35 m.	requires skilled maintenance; not suitable for hand operation; powered by engine or electric motor.
b. Multi-stage shaft-driven	25 - 50 m.	as for single stage. Motor accessible, above ground; alignment and lubrication of shaft critical; capacity range 25 - 10,000 l/min.
c. Multi-stage submersible	30 - 120 m.	as for multi-stage shaft-driven; smoother operation; maintenance difficult; repair to motor or pump requires pulling unit from well; wide range of capacities and heads; subject to rapid wear when sandy water is pumped.
5. AIR LIFT	15 - 50 m.	high capacity at low lift; very low efficiency especially at greater lifts; no moving parts in the well; well casing straightness not critical.

10.4 Reciprocating pumps

The type of pump most frequently used for small water supplies, is the reciprocating (plunger) pump.* Several groups may be distinguished:

- Suction; lift
- Free delivery; force
- Single acting; double acting.

Suction Pumps (Shallow Well)

In the suction pump, the plunger and its cylinder are located above the water level usually within the pump stand itself (Fig. 10.4.).

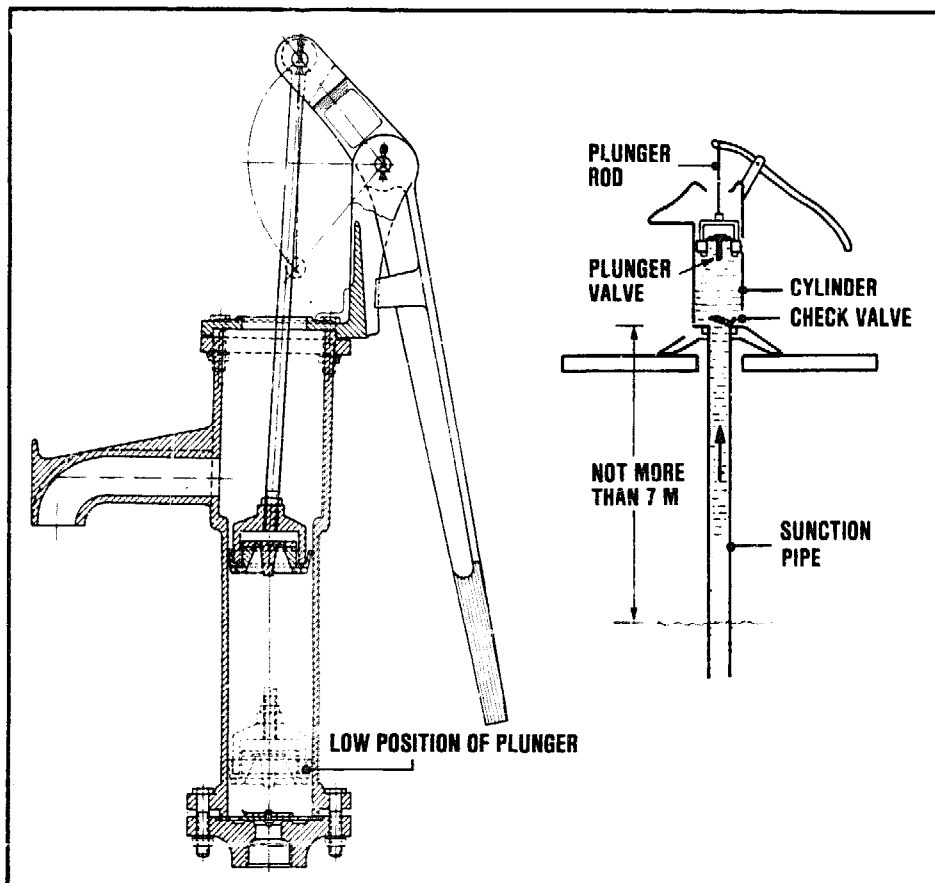

Figure 10.4.
Suction pump (shallow well)

* While this section focuses on the reciprocating plunger pump, the principles outlined also apply to other types of positive displacement pumps.

The suction pump relies on atmospheric pressure to push the water upwards to the cylinder. Contrary to popular belief, this type of pump does not 'lift' the water up from the source. Instead the pump reduces the atmospheric pressure on the water in the suction pipe and the atmospheric pressure on the water outside the suction pipe pushes the water up. Because of its reliance on atmospheric pressure, the use of a suction pump is limited to conditions where the water table is within 7 m of the suction valve during pumping. Theoretically, the atmospheric pressure would allow a suction pump to draw water from as deep as 10 metres, but in practice 7 m is the limit.*

Lift Pumps (Deep Well)

Deep or shallow well in terms of pump selection refers to the depth of the water level in the well, not the depth to the bottom of the tubewell or the length of the well casing.

In the deep-well pump, the cylinder and plunger are located below the water level in the well. This pump can lift water from wells as deep as 180 m or even more. The forces created by the pumping work increase with the depth to the water table, and the problems associated with reaching the cylinder, deep in the well, for maintenance and repair are much more difficult than in shallow well pumps. Thus the design of pumps for deep well use is more critical and complicated than for suction pumps.

An example of a (deep well) lift pump is shown in fig. 10.5.

The principal characteristic of all (deep well) lift pumps is the location of the cylinder. The cylinder should preferably be submerged in the water, in order to assure the priming of the pump.

* Depending on the altitude of the place where the pump is operated.

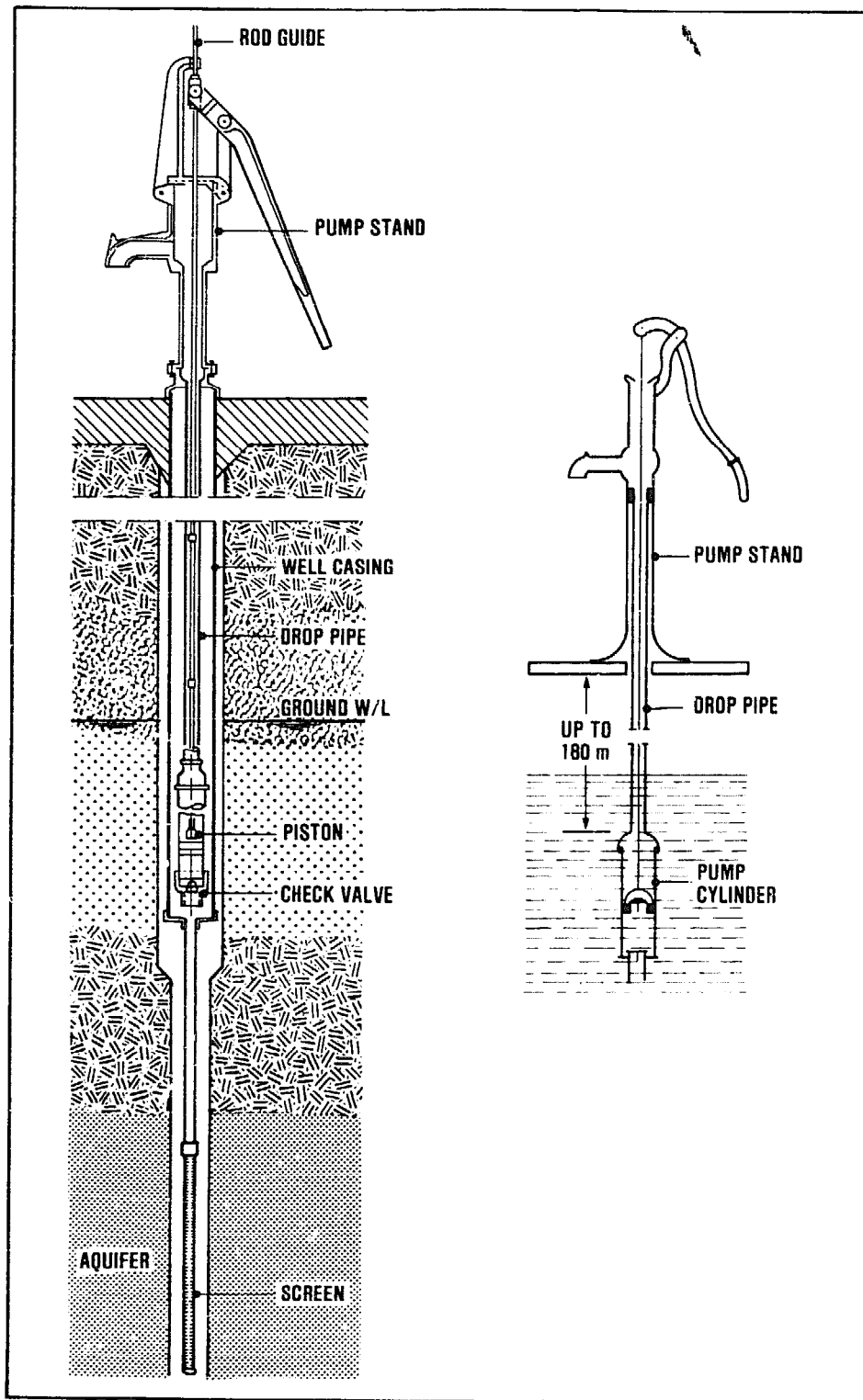

Figure 10.5.
Lift pump (deep well)

Force Pumps

Force pumps are designed to pump water from a source and to deliver it to a higher elevation or against pressure. All pressure-type water systems use force pumps. They are enclosed so that the water can be forced to flow against pressure. Force pumps are available for use on shallow or deep wells (Fig. 10.6).

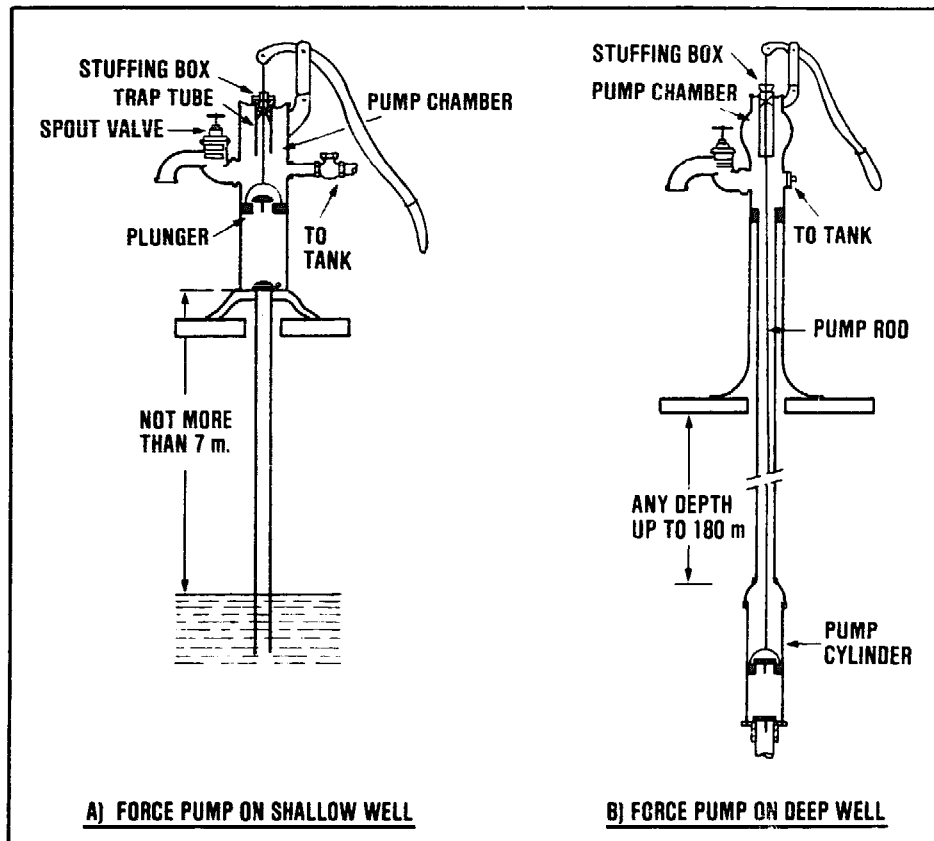

Figure 10.6.
Force pumps

A shallow-well force pump is shown in Fig. 10.6a. Its operating principle is the same as that of the reciprocating plunger pump earlier discussed, except that it is enclosed at the top and, therefore, can be used to force the water to elevations higher than the pump. For this, either a separate connection or a hose or pipe is fitted to the spout.

Force pumps usually have an air chamber to even out the discharge flow. On the upstroke of the plunger, the air in the air chamber is compressed and on the downstroke the air expands to maintain the flow of water while the plunger goes down. The trap tube serves to trap air in the air chamber, preventing it from leaking around the plunger rod.

The operation of a deep well force pump (Fig. 10.6b) is the same. The principal difference is in the location of the cylinder. With the cylinder down in the well the pump can lift water from depths greater than 7 m.

Diaphragm Pumps

Diaphragm pumps are positive displacement pumps. The main part of the pump is its diaphragm, a flexible disc made of rubber or metal. Non-return valves are fitted at the inlet and outlet (Fig. 10.7).

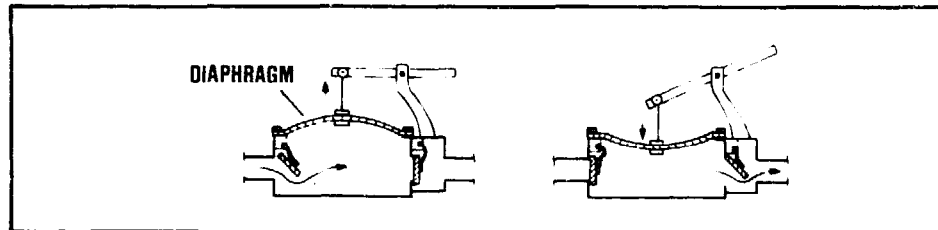

Figure 10.7.
Diaphragm pump

The edge of the diaphragm is bolted to the rim of the water chamber but the centre is flexible. A rod fastened to the centre moves it up and down. As the diaphragm is lifted, water is drawn in through the inlet valve, and when it is pushed down, water is forced out through the outlet valve. Pumping speed usually is about 50-70 strokes per minute. These pumps are self-priming.

The diaphragm pumping principle is used in a number of novel handpump designs. These pumps are being field tested and developed for use in rural water supplies (e.g. Hydropompe Vergnet; Petro Pump).

10.5 Rotary (positive displacement) pumps

Chain Pumps

In the chain pump, discs of a suitable material (e.g. rubber) attached to an endless chain running over a sprocket at the top, are pulled upward through a pipe to lift water mechanically up to the spout. This type of pump can only be used on cisterns and shallow dug wells. It can be readily adapted for manufacture by village artisans (Fig. 10.8). A small chain pump using a pipe of 20 mm diameter, with rubber discs spaced at 1 m intervals, will discharge water at a rate of 5 to 15 l/minute depending on the speed of rotation of the operating wheel (30 to 90 rpm).

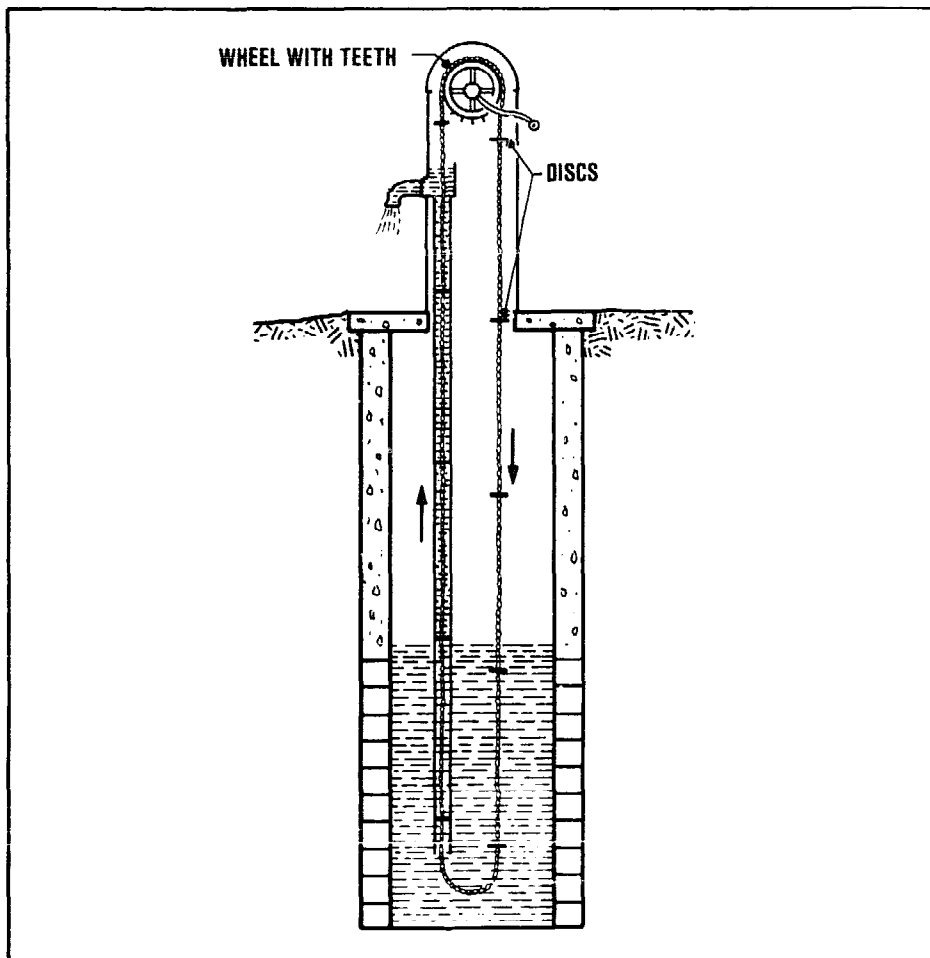

Figure 10.8.
Chain pump

Chain pumps using rags and balls instead of discs were commonly used for draining mines in Western Europe in the 16th Century. Animal-powered chain pumps are used in Asia for irrigation pumping.

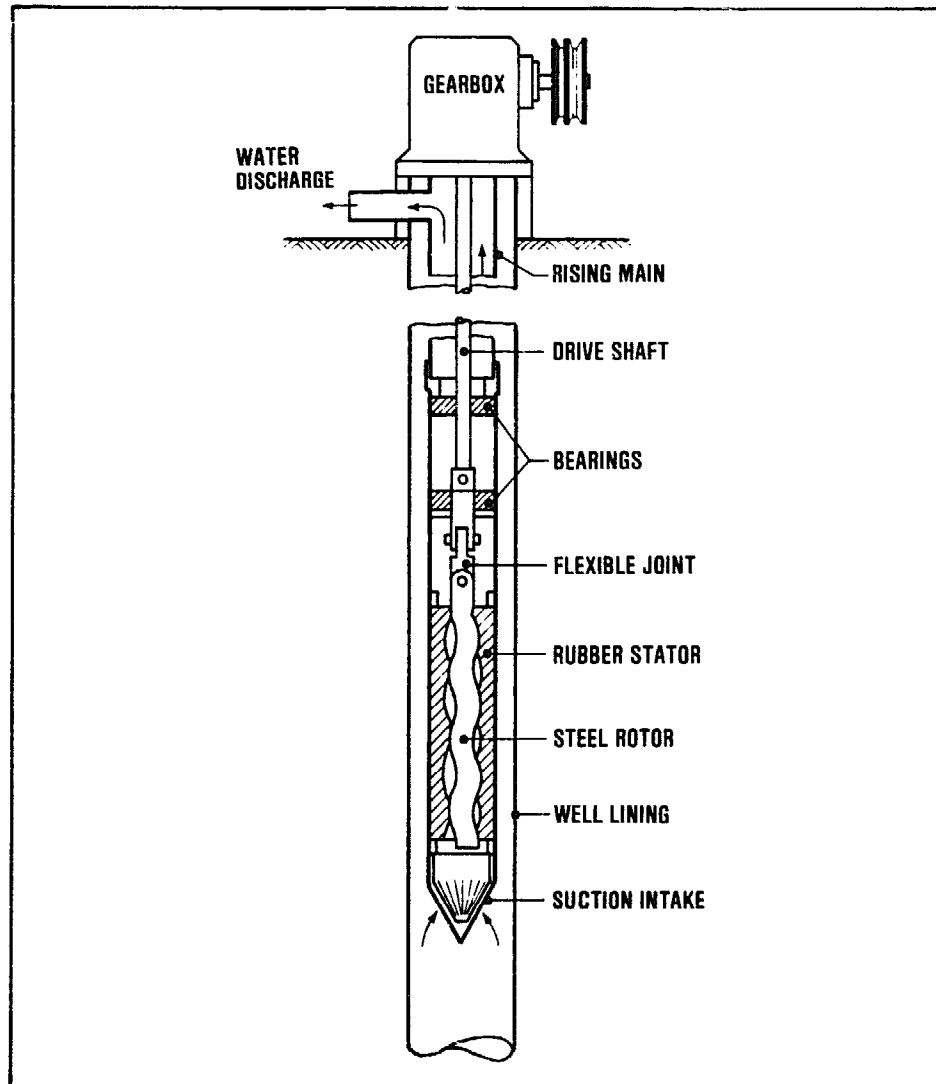

Figure 10.9.
Helical rotor pump

Helical Rotor Pump

The helical rotor pump consists of a single thread helical rotor which rotates inside a double thread helical sleeve, the stator (Fig. 10.9). The meshing helical surfaces force the water up, creating a

uniform flow. The water output is proportional to the rotating speed, and can be varied simply by changing a pulley. As the rotor and stator provide an effective, continuous seal, the helical rotor pump requires no valves. Helical rotor pumps are available for use in 4-inch (100 mm) or larger tube wells. Although relatively expensive, these pumps have given good service on deep wells in parts of Africa and Asia where they are known as the 'Mono' pump after its British manufacturer.

Drive arrangements suitable for helical rotor pumps, are: hand operation, electric motors, diesel and petrol engines. Different drive heads are available. If there is plenty of space, a standard head with a V-belt drive can be used. Where a compact unit is required, geared heads are installed for diesel engine or electric motor drives.

10.6 Axial-flow pumps

In the axial-flow type of pump, radial fins or blades are mounted on an impeller or wheel which rotates in a stationary enclosure (called a casing) (Fig. 10.10).

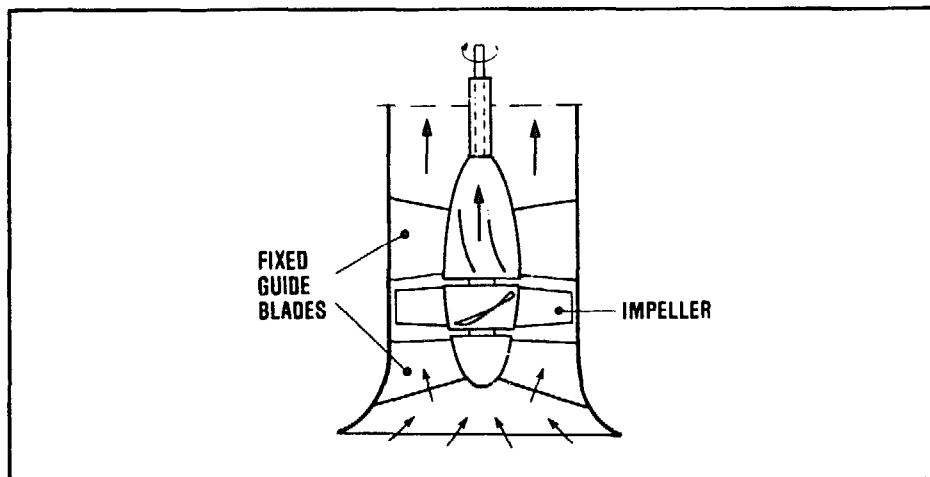

Figure 10.10.
Axial-flow pump

The action of the pump is to mechanically lift the water by the rotating impeller. The fixed guide blades ensure that the water flow has no 'whirl' velocity when it enters or leaves the impeller.

10.7 Centrifugal pumps

The essential components of a centrifugal pump are the impeller and the casing (Fig. 10.11).

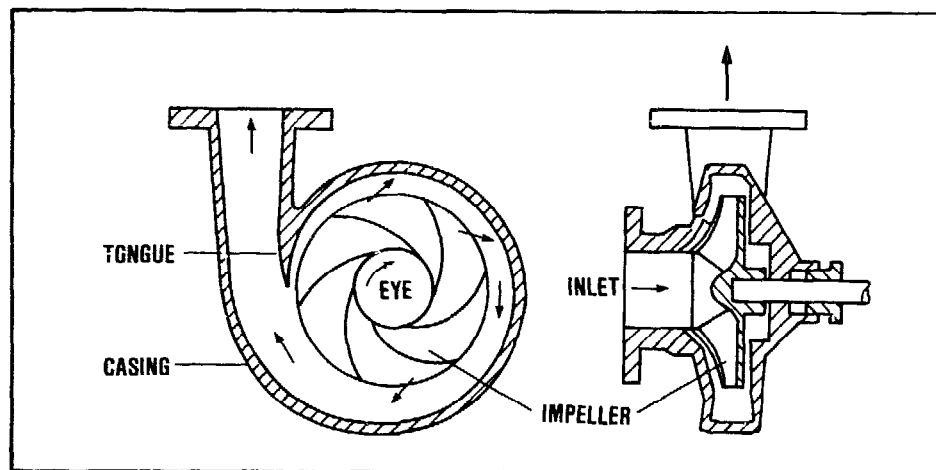

Figure 10.11.
Centrifugal pump (Volute-type Casing)

The impeller is a wheel having vanes radiating from the centre to the periphery. When rotated at a sufficiently high speed, the impeller imparts kinetic energy to the water and produces an outward flow due to the centrifugal forces. The casing is so shaped that the kinetic energy of the water leaving the impeller is partly converted to useful pressure. This pressure will force the water into the delivery pipe. The water leaving the eye of the impeller creates a suction; it will be replaced by water drawn from the source and forced into the casing under static head.

An impeller and the matching section of the casing is called a stage. If the water pressure required in a particular centrifugal pump application is higher than a single stage can practicably produce, a number of stages may be placed in series (multiple-stage pump). The impellers are attached to a common shaft and therefore rotate at the same speed. The water passes through the successive stages, with an increase in pressure at each stage. Multiple-stage centrifugal pumps are normally used for high pumping heads.

The rotating speed of a centrifugal pump has a considerable effect on its performance. The pumping

efficiency tends to improve as the rotating speed increases. Higher speed, however, may lead to more frequent maintenance. A suitable balance between the initial cost and maintenance costs has to be aimed at. A comprehensive study of the pump's characteristic is necessary before final selection.

In centrifugal pumps the angle between the direction of entry and exit of the water flow is 90° . In an axial-flow pump (section 10.6.), the water flow continues through the pump in the same direction with no deviation (0°). The term 'mixed-flow pump' is used for those centrifugal pumps where the change in angle lies between 0° and 90° ; they can be single or multiple-stage.

10.8 Pump drive arrangements

Two different drive arrangements exist for water pumping from deep wells: shaft driven and close-coupled submersible electric motor.

A. SHAFT-DRIVEN

The crankshaft or motor is placed at the ground surface and powers the pump using a vertical drive shaft or spindle (Fig. 10.12). A long drive shaft will need support at regular intervals along its length and flexible couplings to eliminate any stresses due to misalignment. The advantage of a drive shaft is that the drive mechanism may be set above ground or in a dry pit and thus will be readily accessible for maintenance and repair. An accurate alignment of the shaft is necessary; the shaft-drive arrangement is not possible in crooked tubewells.

B. CLOSE-COUPLED SUBMERSIBLE ELECTRIC MOTOR

In this pump drive arrangement, a centrifugal pump is connected directly to an electric motor in a common housing, with the pump and motor as a single unit. This unit is constructed for submerged operation in the water to be pumped (Fig. 10.13.).

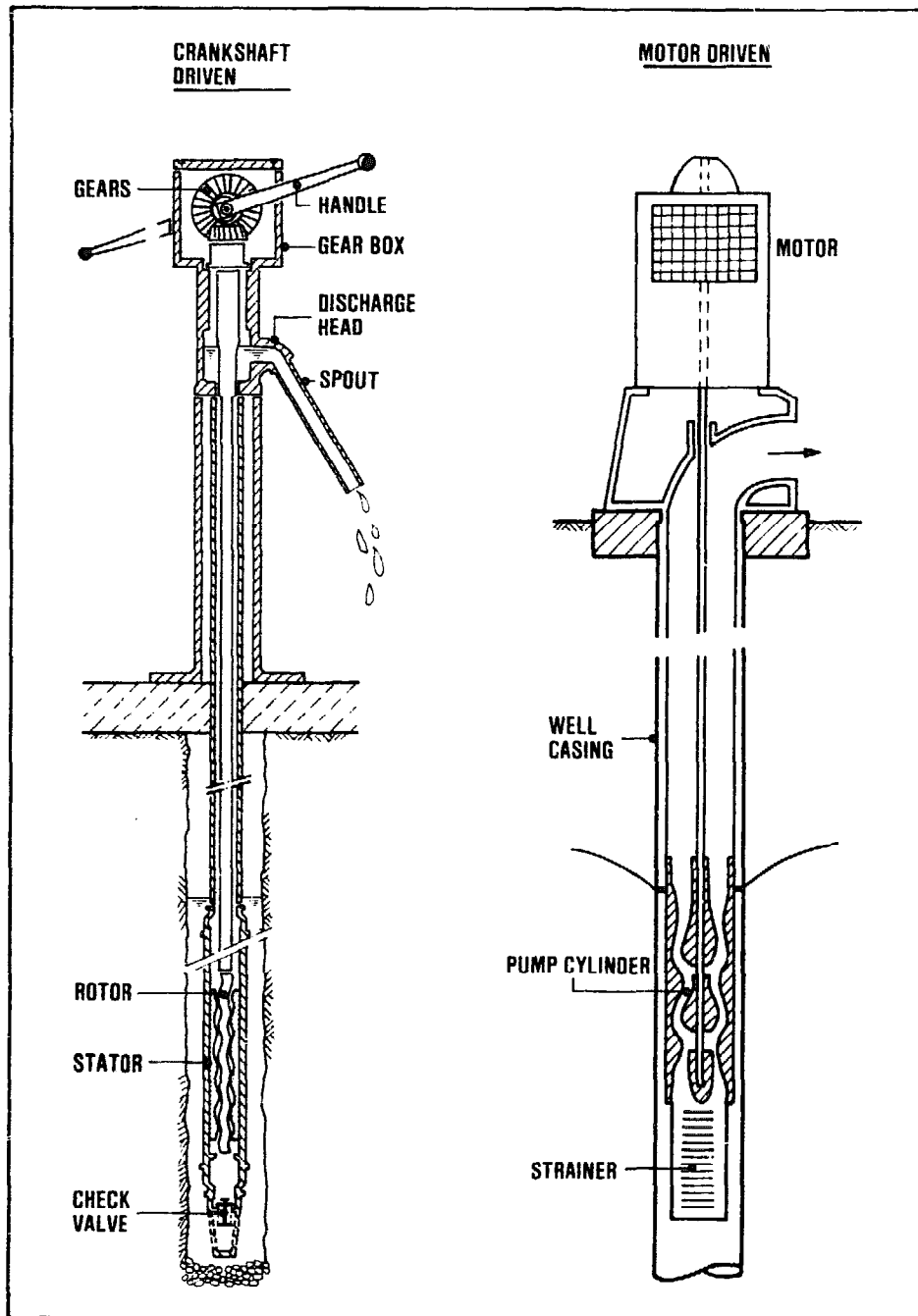
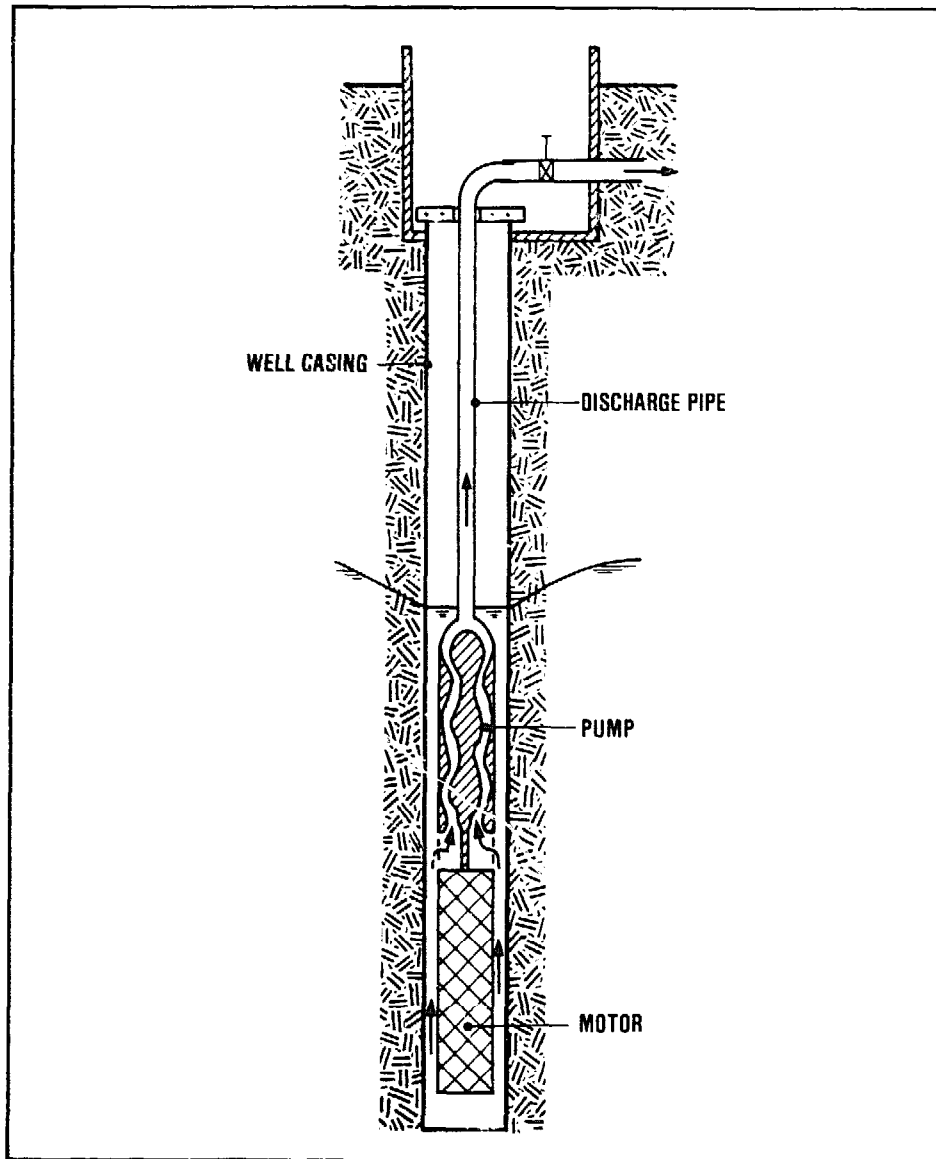

Figure 10.12.
Shaft-driven pumps



*Figure 10.13.
Pump driven by a close-coupled submersible electric motor*

The pump-motor unit (often referred to as 'submersible pump') is lowered inside the well casing, and set a suitable depth below the lowest draw-down water level in the well. Submersible pumps are often a 'tight' fit in a tubewell as their outside diameter is usually only 1 - 2 cm less than the internal bore of the well casing. Consequently, great care is needed during installation or removal of these pumps.

A waterproof electric cable connects the motor with the control box housing, the on-off switch and the power connection. The electrical control should be properly grounded to minimize the risk of shorting and damage to the motor. Fig. 10.14 shows a submersible pump in exploded view.

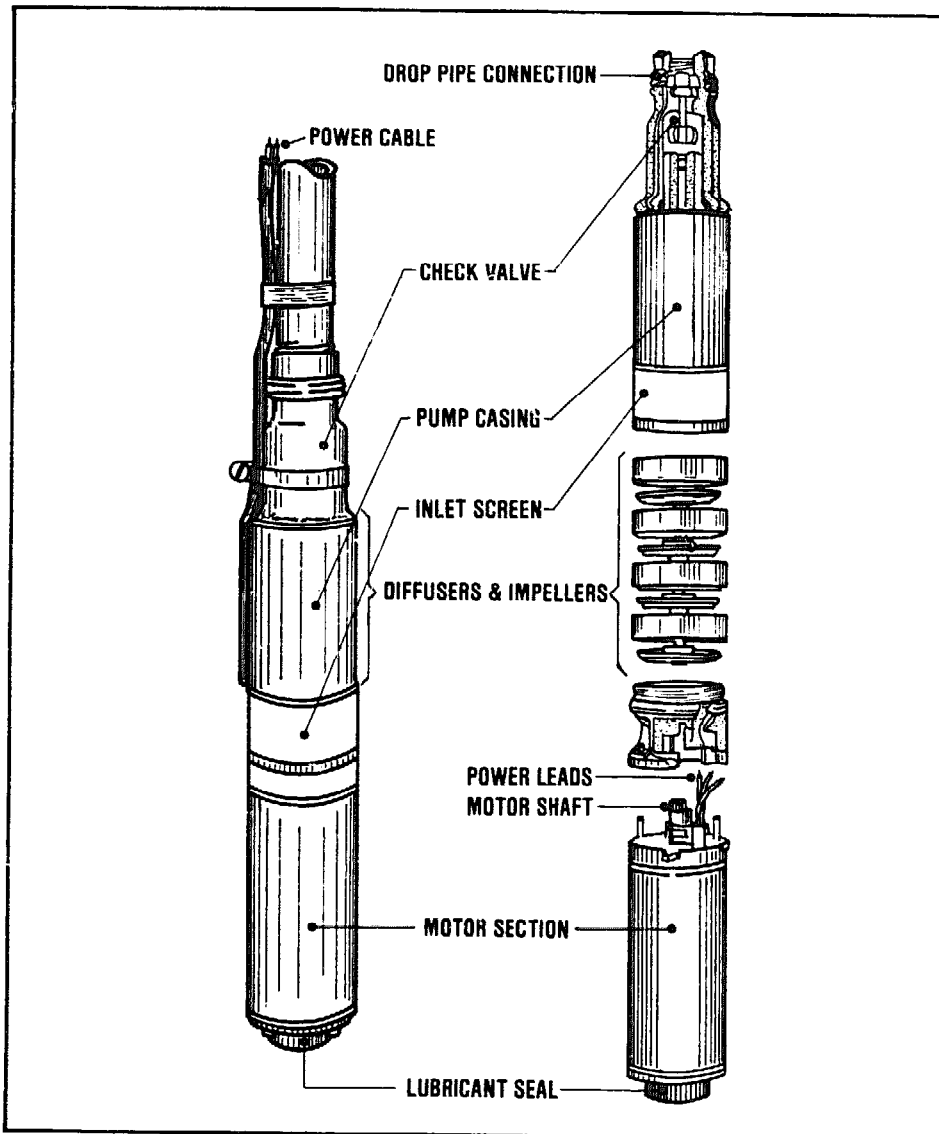

Figure 10.14.
Submersible pump (exploded view)

The submersible pump-motor unit is usually supported by the discharge pipe which conveys the pumped water to the connecting pipeline or tank.

When sand is found or anticipated in the water source, special precautions should be taken before a submersible pump is used. The abrasive action of sand during pumping would shorten the life of the pump considerably.

10.9 Air-lift pumps

An air-lift pump raises water by injecting small evenly distributed bubbles of compressed air at the foot of a discharge pipe fixed in the well. This requires an air compressor. The mixture of air and water being lighter than the water outside the discharge pipe, the water/air mixture is forced upward by the hydrostatic head (Fig. 10.15).

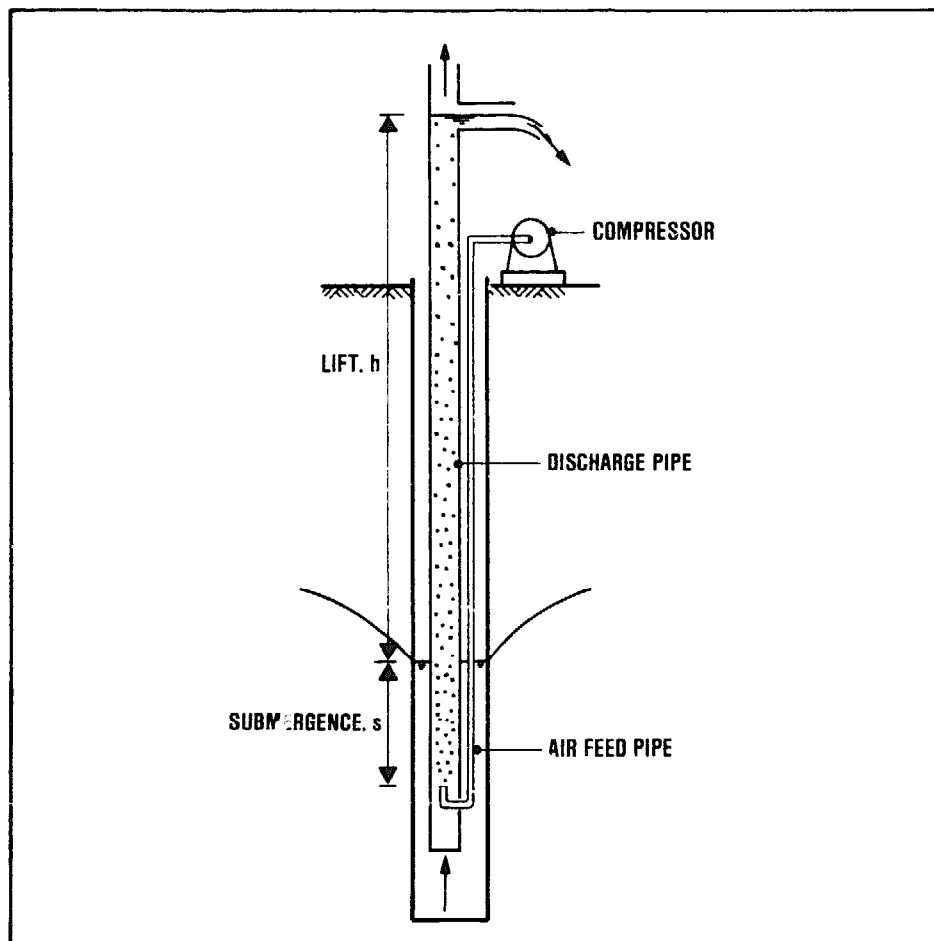

Figure 10.15.
Air lift pump (schematic)

The pumping head (h) against which an air lift pump can raise water, is related to the submergence (s) of the discharge pipe. A high lift requires a considerable submergence to a depth under the lowest drawdown level of the water in the well. The point of injection of compressed air is also at this depth, so that a sufficiently high air pressure is needed. The major drawback of air-lift pumps is their low mechanical efficiency in utilizing the energy supplied for lifting the water. The efficiency of an air-lift pump itself is about 25-40%. Additional are the energy losses in the compressor. Overall, not more than 15-30% of the total power consumption is effectively utilized.

However, air-lift pumps also have important advantages. They are simple to operate and not affected by sand or silt in the pumped water. All mechanical equipment (the compressor) is above ground. A number of air-lift pumps installed in adjacent wells can be operated using a single compressor. Water can be air-lift pumped from wells as deep as 120 m, at a considerable rate. Thus, air-lift pumps should be considered for those applications where their advantages will outweigh the drawback of high power consumption due to the low mechanical efficiency. They should be particularly considered in areas where the groundwater carries much sand or silt, and for pumping water that is acidic (low pH).

Table 10.2. is provided for preliminary guidance in air-lift pump selection.

Table 10.2.
Preliminary guidance in air-lift pump selection

Lift (m)	Submergence (m)	Air-to-water Flow Ratio (volume/volume)	Air pressure required (m H ₂ O)
10	12	3.0	20
20	20	4.7	30
30	25	6.2	40
40	28	7.9	45
60	40	9.6	65
80	49	11.6	85
100	58	13.3	105
120	71	14.8	125

Pumping Capacity (l/sec)	Discharge Pipe Diameter (mm)	Air pipe Diameter (mm)	Compressor Power (HP)
2.5	75 (3")	25 (1")	1.5
5.0	100 (4")	40 (1½")	2.5
7.5	100 (4")	40 (1½")	4
10.0	125 (5")	50 (2")	5
15.0	150 (6")	50 (2")	7.5
20.0	150 (6")	60 (2½")	10
40.0	200 (8")	75 (3")	20

10.10 Hydraulic ram

The hydraulic ram needs no external source of power. The ram utilizes the energy contained in a flow of water running through it, to lift a small volume of this water to a higher level. The phenomenon involved is that of a pressure surge which develops when a moving mass of water is suddenly stopped. A steady and reliable supply of water is required with a fall sufficient to operate the hydraulic ram. Favourable conditions are mostly found in hilly and mountainous areas. Hydraulic rams are not suited to pumping water from wells.

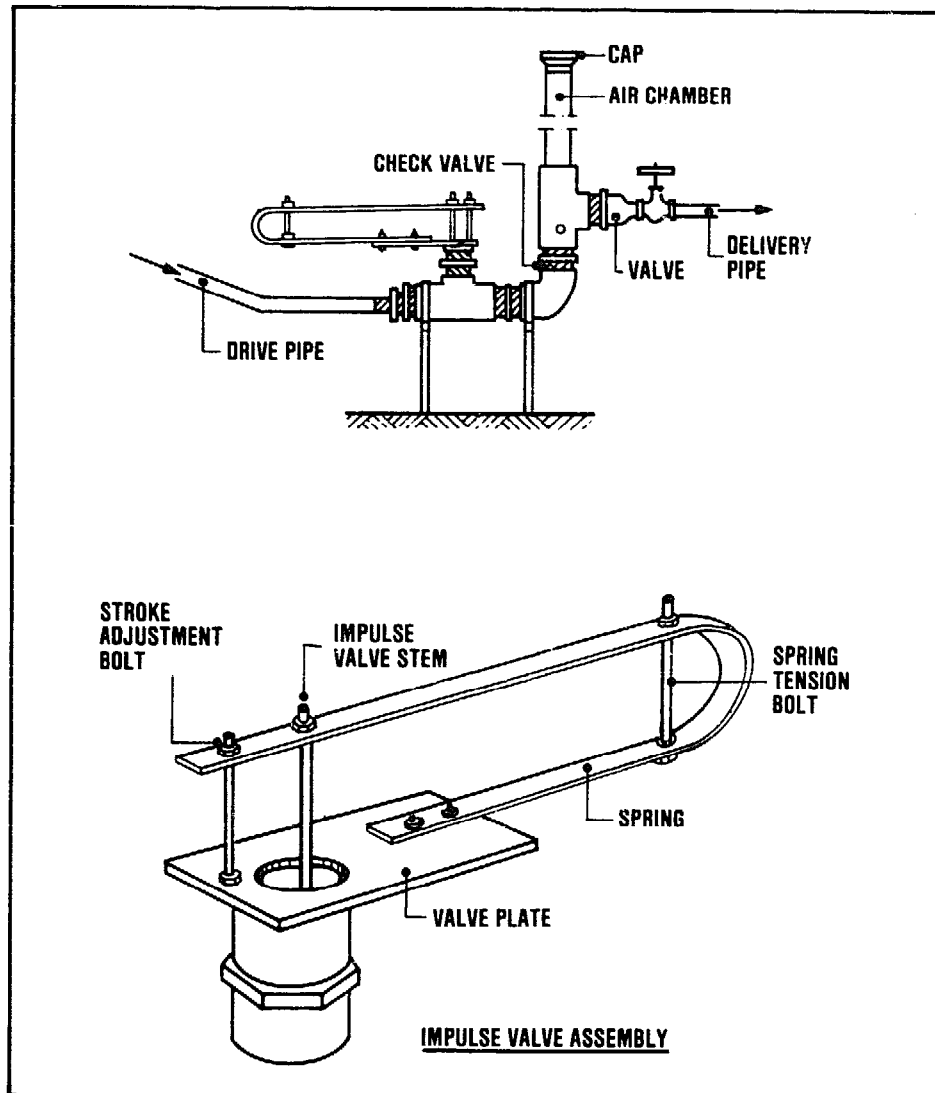

Figure 10.16.
Typical hydraulic ram

Source: S.B. Watt

A Manual on the Hydraulic
Ram for Pumping Water,
I.T. Publications Ltd., 1974

The ram operates on a flow of water running from the source down through the drive pipe into the pump chamber. The water escapes through the opened impulse valve (waste valve). When the flow of water through the impulse valve is fast enough, the upward force on the valve will exceed the spring tension of the valve adjustment and the impulse valve is suddenly shut. The moving mass of water is stopped with its momentum producing a pressure surge along the drive pipe. Due to the pressure surge, water is forced through the non-return (delivery) valve and into the delivery

pipe. Water continues to pass the non-return valve until the energy of the pressure surge in the drive pipe is exhausted. The air chamber serves to smooth out the delivery flow of water, as it absorbs part of the pressure surge which is released after the initial pressure wave.

When the pressure surge is fully exhausted, a slight suction created by the momentum of the water flow, together with the weight of the water in the delivery pipe, shuts the non-return valve and prevents the water from running back into the pump chamber. The adjustment spring now opens the impulse valve, water begins to escape through it, and a new operating cycle is started.

Once the adjustment of the impulse valve has been set, the hydraulic ram needs no attention providing the water flow from the supply source is continuous, and at an adequate rate, and no foreign matter gets into the pump blocking the valves.

An air valve is provided to allow a certain amount of air to bleed in and keep the air chamber charged. Water under pressure will absorb air and without a suitable air valve the air chamber would soon be full of water. The hydraulic ram would cease to function.

The advantages of the hydraulic ram are:

- No power sources are needed, and there are no running costs;
- Simple to make. Local materials and simple workshop equipment can be used;
- It has only two moving parts.

A small supply of water with plenty of fall will enable a hydraulic ram to lift as much water as a large flow of water with a small fall. Most hydraulic rams will work at their best efficiency if the supply head is about $1/3$ of the delivery head. The higher the pumping head required, the smaller the amount of water delivered.

In cases, where the required pumping capacity is greater than one hydraulic ram can provide, a battery of several rams may be used, provided the supply source is of sufficient capacity (Fig. 10.17).

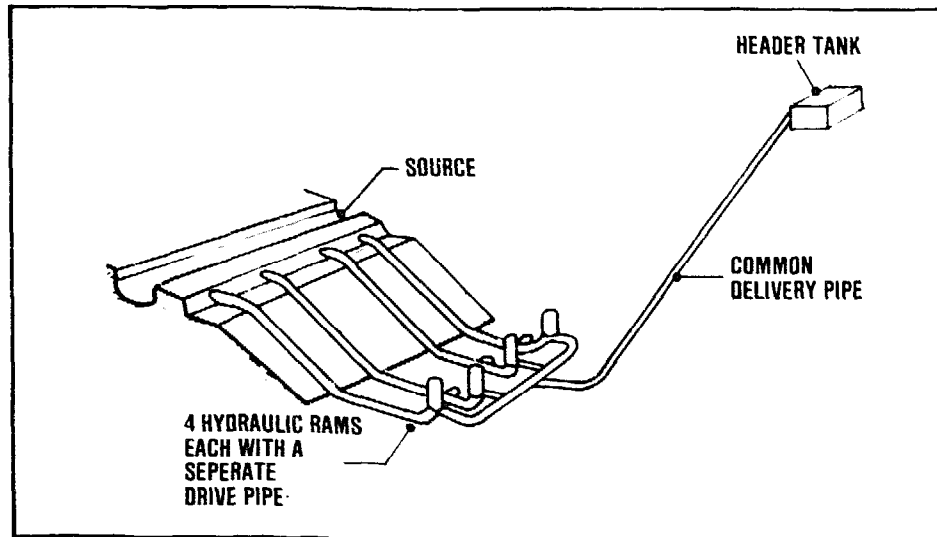

Figure 10.17.
Hydraulic rams placed parallel

The maintenance required for a hydraulic ram is very little and infrequent. It includes:

- Replacement of the valve rubbers when they wear out;
- Adjusting the tuning;
- Tightening bolts which work loose.

Occasionally, the hydraulic ram may need dismantling for cleaning. It is essential that as little debris as possible enters the drive pipe. For this reason, it is necessary to provide a grate or strainer to keep back floating leaves and debris.

Pumping

Addison, H.
THE PUMP USERS HANDBOOK
Pitman & Sons Ltd., London, 1958, 122 p.

Addison, H.
CENTRIFUGAL AND OTHER ROTODYNAMIC PUMPS
Chapman and Hall, London, 1956 (3rd Edition)

Benamour, A.
LES MOYENS D'EXHAURE EN MILIEU RURAL
Comité Interafricain d'Etudes Hydrauliques (C.I.E.H.),
Ouagadougou, Upper Volta, 1979

L'EQUIPEMENT DES VILLAGES EN PUITES ET FORAGES
Commission de Communautés Européenes, Brussels, 1978

Karassik, I.J.; Krutzch, W.C.; Fraser, W.H.; et al
PUMP HANDBOOK
McGraw-Hill, New York, 1958

McJunkin, F.E.
HANDPUMPS FOR USE IN DRINKING WATER SUPPLIES IN DEVELOPING
COUNTRIES International Reference Centre for Community Water Supply,
The Hague, 1977, 230 p. (Technical Paper Series No. 10)

Pacey, A.
HAND PUMP MAINTENANCE
Intermediate Technology Publications Ltd., London, 1976, 38 p.

Romero, J.A.C.
MANUAL DE POZOS RASOS
Organizacion Panamericana de Salud, Washington, D.C., 1977

Ross Institute
SMALL WATER SUPPLIES
London School of Hygiene and Tropical Medicine, London, 1964, 67 p.

Silver, M.
USE OF HYDRAULIC RAMS IN NEPAL
UNICEF, Kathmandu, Nepal, September 1977, 46 p.

Thanh, N.C.; Pescod, M.B.; Venkitachalam, T.H.
DESIGN OF SIMPLE AND INEXPENSIVE PUMPS FOR VILLAGE WATER SUPPLY
SYSTEMS
Asian Institute of Technology, 1979. (Final Report No. 67)

UNICEF Guide List OLGA
UNICEF, New York, 1975, 324 p. (under revision)

Watt, S.B.
A MANUAL ON THE HYDRAULIC RAM FOR PUMPING WATER
Intermediate Technology Publications Ltd., London, 1974, 37 p.

11. water treatment

11.1 Introduction

There will be situations where treatment of the water is necessary to render it fit for drinking and domestic use. The provision of any form of treatment in a water supply system will require a capital outlay that may be relatively substantial. More important, it will greatly expand the problems of maintaining the water supply system, and the risks of failure. Some water treatment processes are easier to operate and maintain than others, but all need regular supervision and attention. When designing a water treatment plant, the operational and maintenance requirements are key factors that must be considered carefully.

The purpose of water treatment is to convert the water taken from a ground or surface source, the 'raw water', into a drinking water suitable for domestic use. Most important is the removal of pathogenic organisms and toxic substances such as heavy metals causing health hazards. Other substances may also need to be removed or at least considerably reduced. These include: suspended matter causing turbidity, iron and manganese compounds imparting a bitter taste or staining laundry, and excessive carbon dioxide corroding concrete and metal parts. For small community water supplies, other water quality characteristics such as hardness, total dissolved solids and organic content would generally be less important. They should be reduced to acceptable levels but the extent to which the water is treated will be limited by economic and technical considerations. The quality guidelines for drinking water presented in Chapter 3 should be a guide when the extent of the necessary treatment is determined.

Various water treatment processes (also called 'unit operations') have been developed. Some serve a single purpose, others have multiple applicability. Often a treatment result can be obtained in different ways (Table 11.1). The treatment processes mentioned, are discussed in the chapters 12 - 17. Artificial recharge (discussed in Chapter 9) may also be regarded as a water treatment process.

Storage of water can be regarded as treatment. For example, schistosomiasis cercariae are normally unable to survive 48 hours of storage. The number of faecal coliforms and faecal streptococci will be considerably reduced when the raw water is subjected to storage. Storage also allows sedimentation to take place reducing the settleable solids content of the water. Storage, however, may promote algal growth in the water. Loss of water through evaporation often is another drawback. These effects will be minimized if storage tanks are covered which also would prevent dust, insects, air borne pollution and small animals from contaminating the stored water.

*Table 11.1.
Effectiveness of water treatment processes in removing various impurities*

+++ etc. = increasing positive effect
o = no effect
- = negative effect

TREATMENT PROCESS WATER QUALITY PARAMETER	Aeration	Chemical Coagula- tion and Floc.	Sediment- ation	Rapid Filtration	Slow sand Filtration	Chlorina- tion
Dissolved Oxygen Content	+	o	o	-	--	+
Carbon Dioxide Removal	-	o	o	+	++	+
Turbidity* Reduction	o	+++	+	+++	++++	o
Colour Reduction	o	++	+	+	++	++
Taste and Odour Removal	++	+	+	++	++	+
Bacteria Removal	o	+	++	++	++++	++++
Iron and Mangan- ese Removal	++	+	+	++++	++++	o
Organic Matter Removal	+	+	++	+++	++++	+++

* Turbidity of water is caused by the presence of suspended matter scattering and absorbing light rays, and thus giving the water a non-transparent, milky appearance.

Frequently, a number of water treatment processes have to be used in combination, in order to obtain the desired result. For groundwater and for clear surface water, one or a few processes will probably be sufficient. Slightly polluted surface water generally can be sufficiently treated using a few processes; heavily polluted water requires many treatment processes, one after the other, to render it safe for drinking and domestic use. For small community water supplies, complicated treatment schemes are not suited and in such cases a better solution may be to develop another, unpolluted source of water even when this can only be found at a greater distance. An alternative may be the use of underground formations for storage of water and quality improvement (artificial recharge).

Once the source of water has been selected, and the variation in its quality assessed, the engineer can decide which treatment should be applied. The following chapters give information and guidance. For small community water supplies, the most important design considerations are:

- Low cost;
- Use a minimum of mechanical equipment;
- Avoid the use of chemicals, when possible;
- Easy to operate and maintain.

Simple arrangements can be effective, provided they are well-designed. The water treatment process diagram shown in Fig. 11.1 is illustrative.

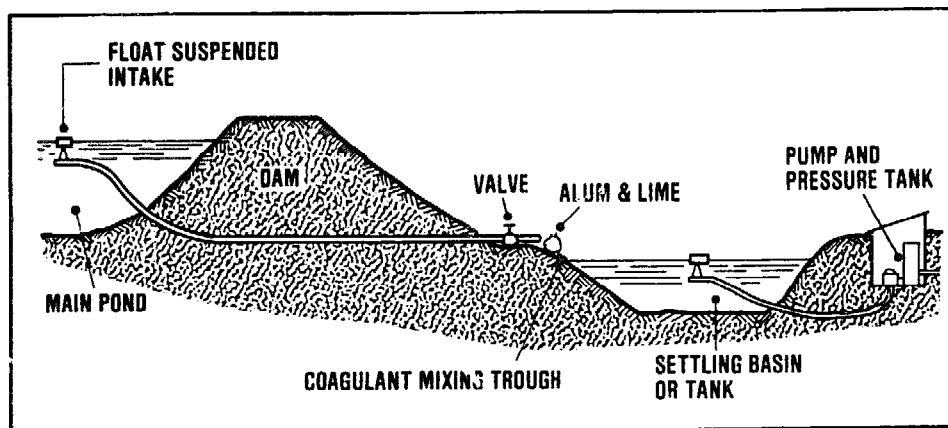

Figure 11.1.
Simple arrangements for water intake, coagulant mixing and settling

11.2 Groundwater quality and treatment

For the most part, groundwater originates from infiltrated rainwater which after reaching the aquifer flows through the underground. During infiltration, the water will pick up many impurities such as inorganic and organic soil particles, debris from plant and animal life, micro-organisms, natural or man-made fertilizers, pesticides, etc. During its flow underground, however, a great improvement in water quality will occur. Suspended particles are removed by filtration, organic substances are degraded by oxidation, and micro-organisms die away because of lack of nutrients. The dissolved mineral compounds are not removed; in fact, the mineral content of the water can increase considerably through the leaching of salts from the underground layers.

Groundwater, if properly withdrawn, will be free from turbidity and pathogenic organisms. When it originates from a clean sand aquifer, other hazardous or objectionable substances will also be absent. In these cases, a direct use of the water as drinking water may be permitted without any treatment. When the water comes from an aquifer containing organic matter, oxygen will have been consumed and the carbon dioxide content of the water is likely to be high. The water will then be corrosive unless calcium-carbonate in one form or another is present. In cases where the amount of the organic matter in the aquifer is high, the oxygen content may be completely depleted. The water containing no oxygen (anaerobic water) will dissolve iron, manganese and heavy metals from the underground. Through treatment these substances can be removed, i.e. by aeration. It depends on the type of aerator whether the carbon dioxide content of the water will be reduced or left unchanged. A reduction is desirable if the water is corrosive but in other cases it can result in troublesome deposits of calcium carbonate.

Sometimes, groundwater contains excessive amounts of iron, manganese and ammonia. In Europe, where groundwater is scarce, even such groundwater sources are abstracted and treated with chemical coagulation and flocculation or dry filtration to render them fit for drinking and domestic purposes. However, for small community water supplies in developing countries these processes are too complicated and should be avoided whenever possible. Table 11.2 sums up the treatment processes described above.

Table 11.2.
Treatment of groundwater

WATER QUALITY	Aeration for		Plain Sediment- ation	(Rapid) Filtration	Safety- or Post- Chlorination
	increasing O ₂	reducing CO ₂			
Aerobic, fairly hard, not corrosive					0
Aerobic, soft and corrosive		X			0
Anaerobic, fairly hard, not corrosive no iron and manganese	X				0
Anaerobic, fairly hard, not corrosive with iron and manganese	X		0	X	0
Anaerobic, soft, corrosive no iron and manganese	X	X			0
Anaerobic, soft corrosive with iron and manganese	X	X	0	X	0

(X = necessary, 0 = optional)

11.3 Surface water quality and treatment

Surface water can be taken from streams, rivers, lakes or irrigation canals. Water in such surface sources originates partly from groundwater outflows and partly from rainwater that has flowed over the ground to the receiving bodies of surface water. The groundwater outflows will bring dissolved solids into the surface water; the surface run-off is the main contributor of turbidity and organic matter, as well as pathogenic organisms. In the surface water bodies, the dissolved mineral particles will remain unchanged but the or-

ganic impurities are degraded through chemical and microbial processes. Sedimentation in impounded or slow-flowing surface water results in the removal of suspended solids. Pathogenic organisms will die off due to lack of suitable food. However, new contamination of the surface water is likely to take place as a result of waste influents and algal growth.

In sparsely populated areas, clear water from rivers and lakes might require no treatment to make it suitable for drinking. However, taking into account the risk of incidental contamination, chlorination as a safety measure should be provided whenever feasible. Unpolluted surface water of low turbidity may be purified by slow sand filtration as a single treatment process, or by rapid filtration followed by chlorination only. Slow sand filters, particularly in rural areas of developing countries, have the great advantage that local workmen can build them with locally-available materials and without much expert supervision.



WHO Photo by J. Magee

*Figure 11.2.
Surface water needs treatment before it is used for drinking and domestic purposes*

When the turbidity of the water to be treated is high, or when algae are present, slow sand filters would rapidly clog. A pretreatment will be needed, such as sedimentation, rapid filtration or both processes in combination. For colloidal suspended particles, the removal by settling can be greatly improved through chemical coagulation and flocculation. The removal of algae is promoted by pre-chlorination. All these processes are required in most instances where the organic matter content of the raw water is high. Water from rivers and lakes is of a very wide variety in composition and it is impossible to describe in detail all the treatment systems required in every case. Leaving complicated processes out, Table 11.3 shows the systems most applicable to small community water supplies.

*Table 11.3
Treatment of surface water*

treatment water quality	Pre-chlo- rination	Chem.coag. and floc.	Sediment- ation	Rapid Filtration	Slow Sand Filtration	Safety- or Post-chlo- rination
clear and unpolluted						0
slightly polluted, low turbid- ity				0	X	0
slightly polluted, medium turbidity			0	X	X	0
slightly polluted, high turbidity		X	X	X	X	0
slightly polluted, many algae	X	X	X	X		X
heavily polluted, little turbidity	X			X	X	0
heavily polluted, much turbidity	X	X	X	X		X

(X = necessary, 0 = optional)

Water treatment

American Water Works Association
WATER QUALITY AND TREATMENT
McGraw-Hill Book Co., New York, 1971 (3rd Edition)

Azevedo Netto, J.M.
TRATAMENTO DE AQUAS DE ABASTECIMENTO
Editora de Universidade de Sao Paulo, Sao Paulo, 1966

Cox, C.R.
OPERATION AND CONTROL OF WATER TREATMENT PROCESSES
World Health Organisation, 1964, 392 p.
(Monograph Series No. 49)

Fair, G.M.; Geyer, J.C.; Okun, D.A.
WATER AND WASTE WATER ENGINEERING (2 Volumes)
John Wiley, London, 504; 664 p.

Fair, G.M.; Geyer, J.C.; Okun, D.A.
ELEMENTS OF WATER SUPPLY AND WASTE DISPOSAL
John Wiley, London, 1972

Mann, H.T.; Williamson, D.
WATER TREATMENT AND SANITATION
Intermediate Technology Publications Ltd., London, 1968, 92 p.

MANUAL ON WATER SUPPLY AND TREATMENT
Government of India Ministry of Works & Housing (Central Public
Health Environmental Engineering Organisation),
New Delhi, 1976 (2nd Edition)

Sanks, R.C.
WATER TREATMENT PLANT DESIGN FOR THE PRACTICING ENGINEER
Ann Arbor Science, Ann Arbor, USA, 1978

Smethurst, G.
BASIC WATER TREATMENT
Thomas Telford Ltd., London, 1979

TEORIA DESIENO CONTROL DE LOS PROCESOS DE CLARIFICACION DEL AGUA
Centro Panamericano de Ingenieria Sanitaria y Ciencias del
Ambiente, Lima, 1974 (Serie Technica 13)

VILLAGE TECHNOLOGY HANDBOOK
Volunteers in Technical Assistance
Mount Rainer, Maryland, USA, 1977

12. aeration

12.1 Introduction

Aeration is the treatment process whereby water is brought into intimate contact with air for the purpose of (a) increasing the oxygen content, (b) reducing the carbon dioxide content, and (c) removing hydrogen sulfide, methane and various volatile organic compounds responsible for taste and odour. The treatment results mentioned under (a) and (c) are always useful in the production of good drinking water. Reducing the carbon dioxide content, however, may shift the carbonate-bicarbonate equilibrium in the water so that deposits of calcium carbonate are formed which may cause problems.

Aeration is widely used for the treatment of groundwater having too high an iron and manganese content. These substances impart a bitter taste to the water, discolour rice cooked in it and give brownish-black stains to clothes washed. The atmospheric oxygen brought into the water through aeration will react with the dissolved ferrous and manganous compounds changing them into insoluble ferric and manganic oxide hydrates. These can then be removed by sedimentation or filtration. It is important to note that the oxidation of the iron and manganese compounds in the water is not always readily achieved. Particularly when the water contains organic matter, is the formation of iron and manganese precipitates through aeration likely to be not very effective. Chemical oxidation, a change in alkalinity or special filters may then be required for iron and manganese removal. These treatment methods, however, are expensive and complex, and for rural areas in developing countries it would be better to search for another source of water. For the treatment of surface water, aeration would only be useful when the water has a high content of organic matter. The overall quality of this type of water will generally be poor and to search for another water source would probably be appropriate.

The intimate contact between water and air, as needed for aeration, can be obtained in a number of ways. For drinking water treatment, it is mostly achieved by dispersing the water through the air in thin sheets or fine droplets (waterfall aerators), or by mixing the water with dispersed air (bubble aerators). In both ways the oxygen content of the

water can be raised to 60-80% of the maximum oxygen content that the water could contain when fully saturated. In waterfall aerators an appreciable release of gases from the water is effected; in bubble aerators this effect is negligible. The reduction of the carbon dioxide by waterfall aerators can be considerable, but is not always sufficient when treating very corrosive water. A chemical treatment such as the dosing of lime, or filtration over marble or burned dolomite would be required for this type of water.

12.2 Waterfall aerators

The multiple tray aerator shown in Fig. 12.1 provides a very simple and inexpensive arrangement and it occupies little space.

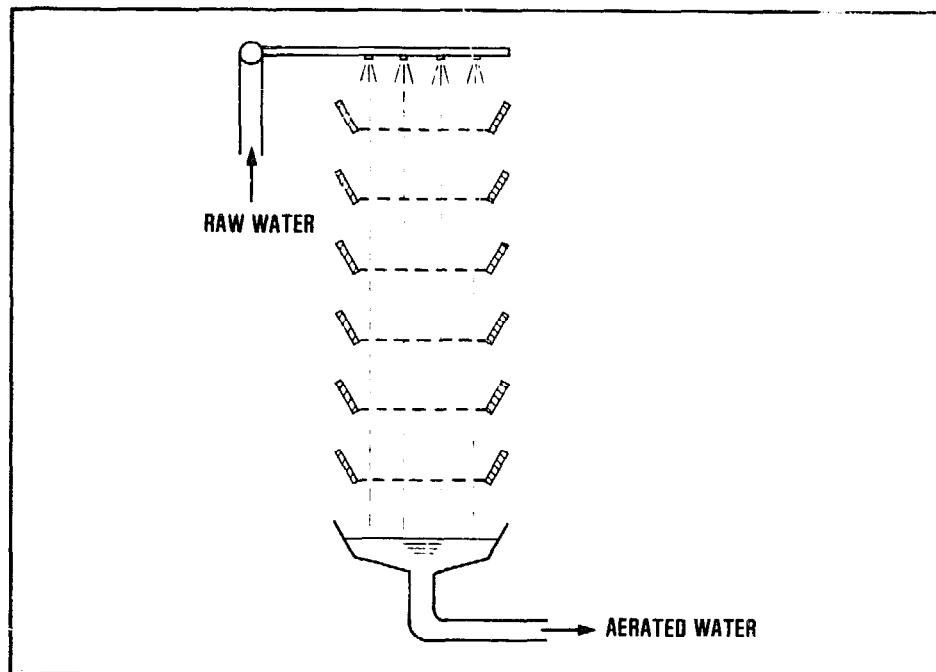

Figure 12.1.
Multiple-tray aerator

This type of aerator consists of 4-8 trays with perforated bottoms at intervals of 30-50 cm. Through perforated pipes the water is divided evenly over the upper tray, from where it trickles down at a rate of about $0.02 \text{ m}^3/\text{sec}$ per m^2 of tray surface. The drop-

lets are dispersed and re-collected at each following tray. The trays can be made of any suitable material, such as asbestos cement plates with holes, small diameter plastic pipes or parallel wooden slats (Fig. 12.2.). For finer dispersion of the water, the aerator trays can be filled with coarse gravel about 10 cm deep. Sometimes a layer of coke is used which acts as catalyst and promotes the precipitation of iron from the water. A hand-operated aeration/filtration unit for treatment of water having high iron and manganese content is shown in Fig. 12.3.

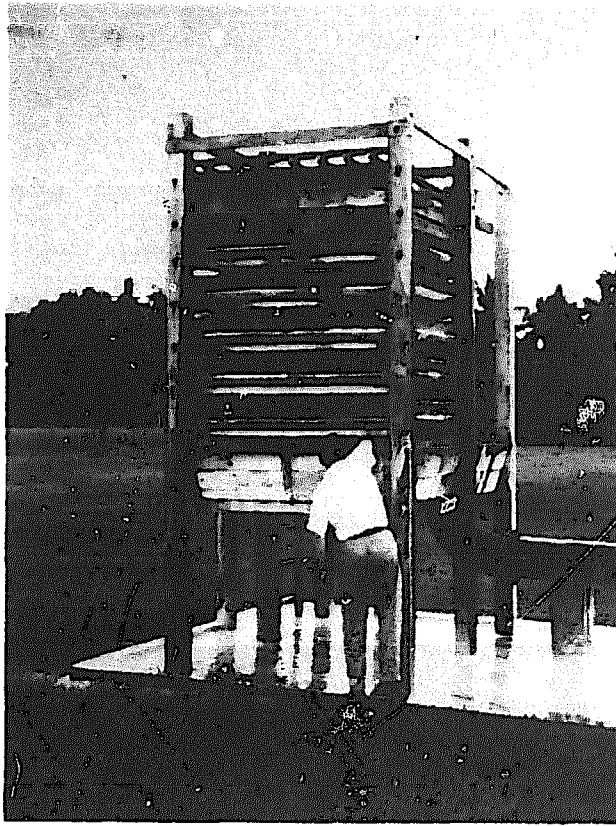
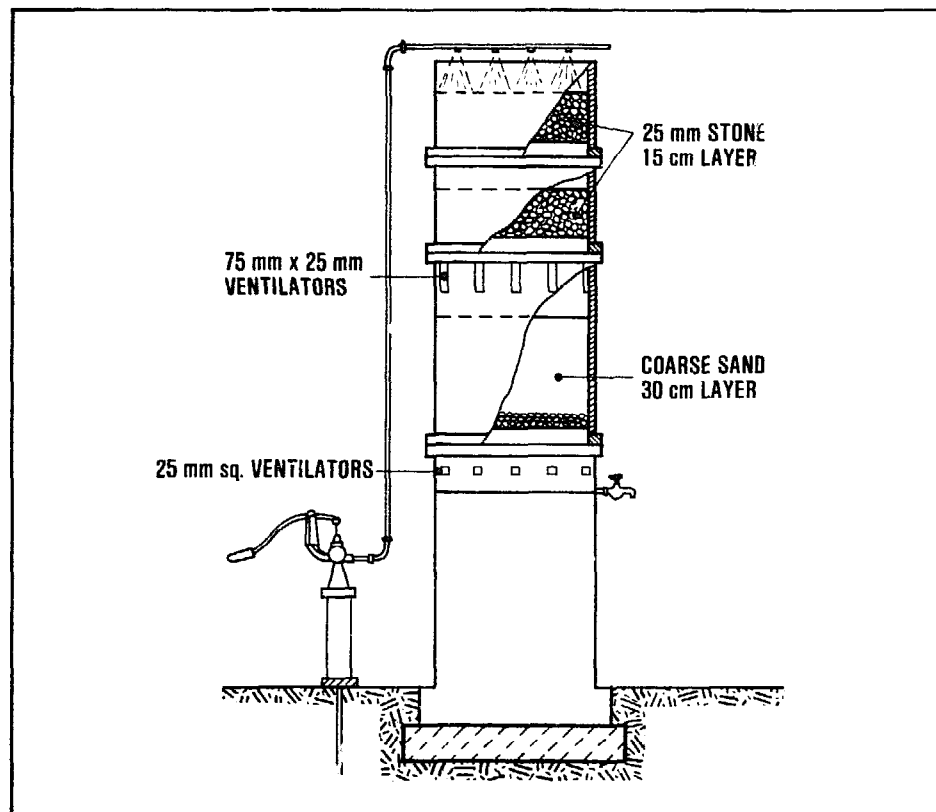

Figure 12.2.
Aerator installation



Ref.: NEERI, India

Figure 12.3.
Hand-operated aeration/filtration unit

A type of aerator with similar features, is the cascade aerator (Fig. 12.4). Essentially this aerator consists of a flight of 4-6 steps, each about 30 cm high with a capacity of about 0.01 m³/s per metre of width. To produce turbulence and thus promote the aeration efficiency, obstacles are often set at the edge of each step. Compared with tray aerators, the space requirements of cascade aerators are somewhat larger but the overall head loss is lower. Another advantage is that no maintenance is needed.

A multiple-platform aerator uses the same principles. Sheets of falling water are formed for full exposure of the water to the air (Fig. 12.5).

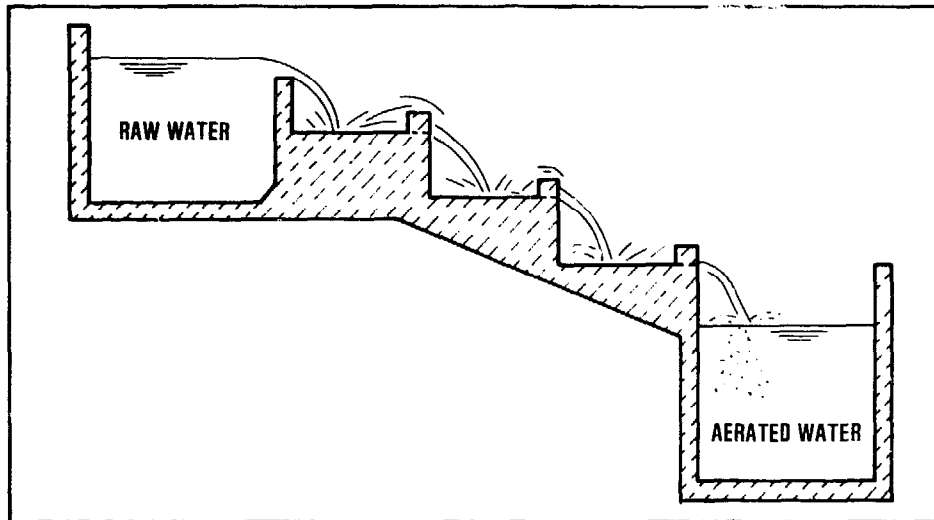

Figure 12.4.
Cascade aerator

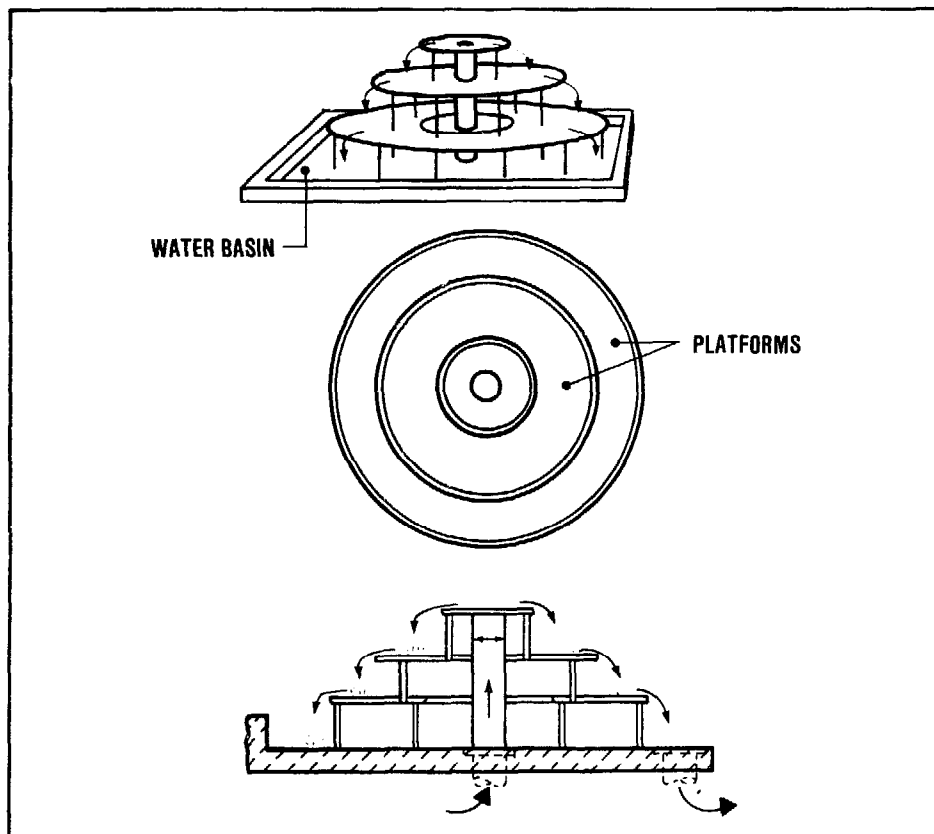

Figure 12.5.
Multiple-platform aerator

Spray aerators consist of stationary nozzles, connected to a distribution grid through which the water is sprayed into the surrounding air, at velocities of 5-7 m/sec.

A very simple spray aerator is shown in Fig. 12.6, with the water discharging downwards through short pieces of pipe, of some 25 cm length and with a diameter of 15-30 mm. A circular disk is placed a few centimetres below the end of each pipe, so that thin circular films of water are formed which further disperse into a fine spray of water droplets.



Figure 12.6.
Spray aerator

Another type of spray aerator uses nozzles fitted to feeding pipes, which spray the water upwards (Fig. 12.7). Spray aerators are usually located above the settling tank or filter units, so as to save space, and to avoid the need for a separate collector basin for the aerated water.

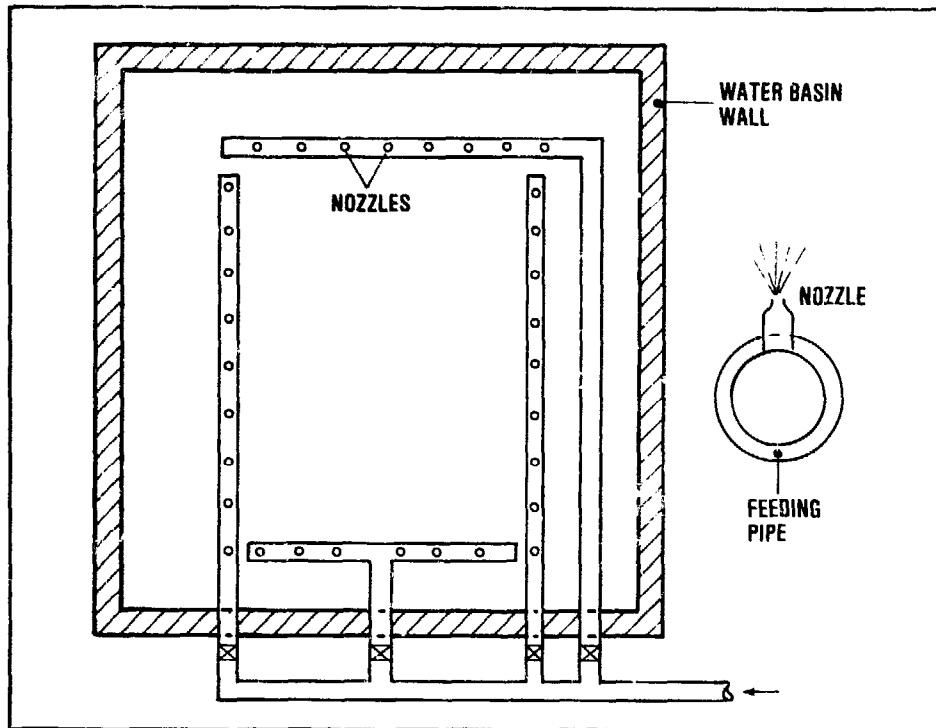

Figure 12.7.
Nozzled spray aerator

To avoid clogging, the nozzle openings should be fairly large, more than 5 mm, but at the same time the construction should be such that the water is dispersed into fine droplets. Many designs have been developed to meet these requirements. A simple spray aerator using a baffle plate is shown in Fig. 12.8.

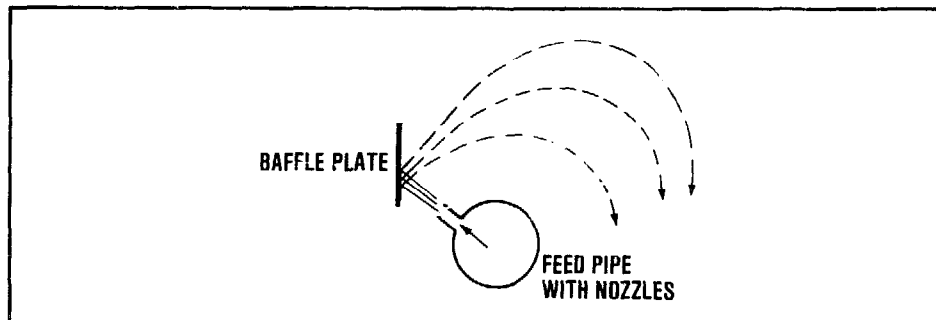
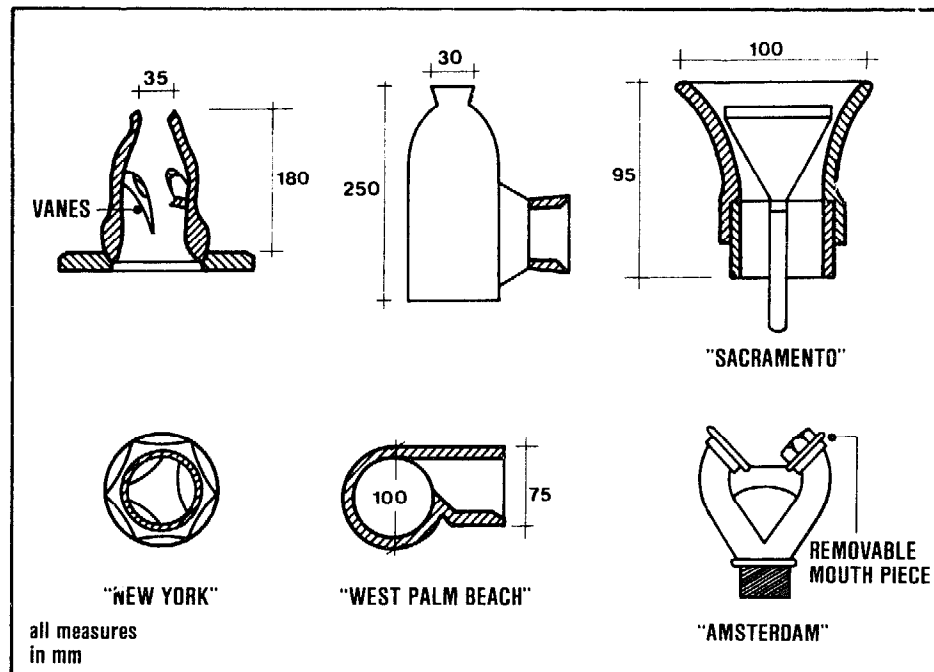

Figure 12.8.
Simple spray aerator using baffle plate

Fig. 12.9 presents several examples of specially designed nozzles.



After: Fair, Geyer & Okun, 1968

Figure 12.9.
Nozzles for spray aerators

12.3 Bubble aerators

The amount of air required for bubble aeration of water is small, no more than $0.3-0.5 \text{ m}^3$ of air per m^3 of water and these volumes can easily be obtained by a sucking in of air. This is best demonstrated with the venturi aerator shown in Fig. 12.10. The aerator is set higher than the pipe carrying the raw water. In the venturi throat the velocity of flow is so high that the corresponding water pressure falls below the atmospheric pressure. Hence, air is sucked into the water. After passing the venturi throat, the water flows through a widening pipe section and the velocity of flow decreases with a corresponding rise of the water pressure. The fine air bubbles are mixed intimately with the water. From the air bubbles, oxygen is absorbed into the water. The release of carbon dioxide in this type of aerator is negligible, because the air volume of the bubbles is quite small.

Compared with spray aerators, the space requirements of venturi aerators are low; the overall headloss is about the same.

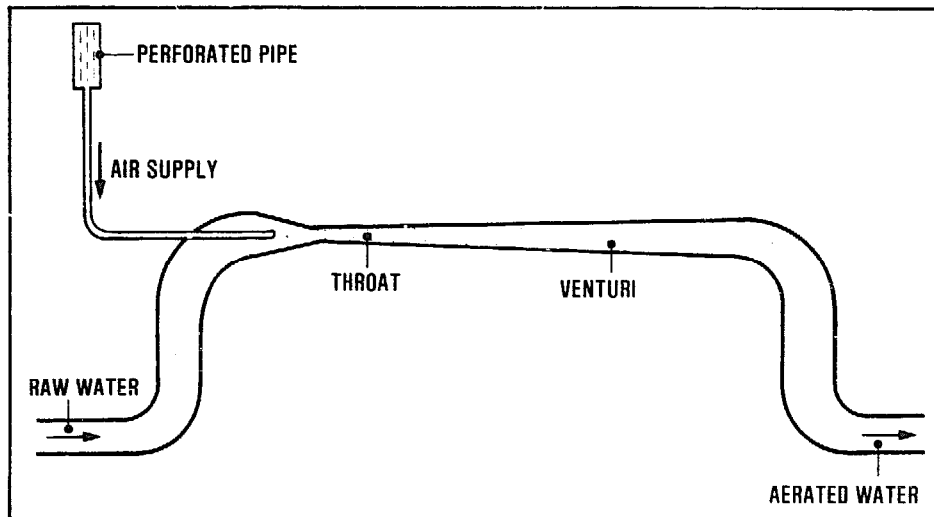

Figure 12.10.
Venturi aerator

The submerged cascade aerator of Fig. 12.11 operates by entrapping air in the falling sheets of water which carry it deep into the water collected in the troughs. Oxygen is then transferred from the air bubbles into the water. The total fall is about 1.5 m subdivided in 3-5 steps. The capacity varies between 0.005 and 0.05 m³/sec. per metre of width.

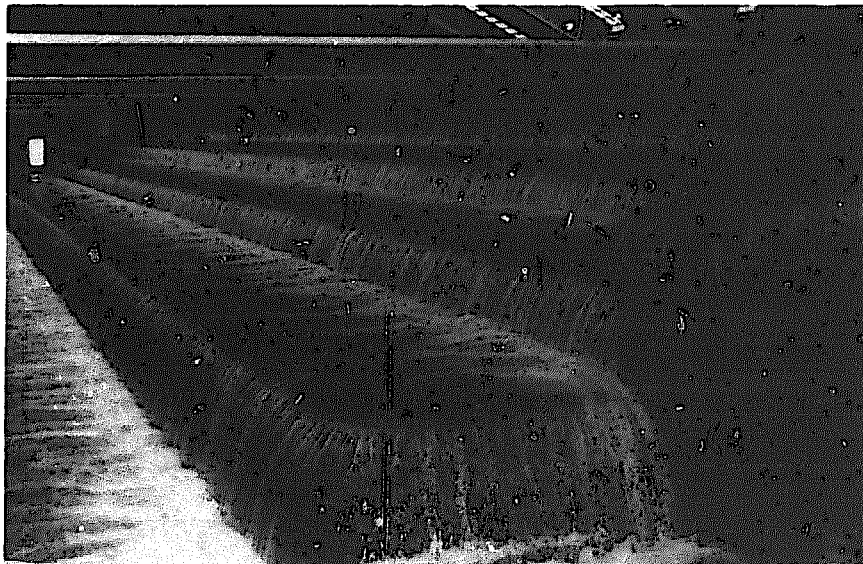

Figure 12.11.
Submerged cascade aerator

Aeration

American Water Works Association: Committee on Aeration
AERATION OF WATER

In: Journal Am. Water Works Assoc. Vol.47(1975) No. 5, pp. 873-893

Azevedo Netto, J.M.

TRATAMIENTO DE AGUAS DE ABASTECIMIENTO

Editora de Universidade de Sao Paulo, Sao Paulo, 1966

CURSO SOBRE TECNOLOGIA DE TRATAMIENTO DE AGUA PARA PAISES ON
DESARROLLO

CEPIS, Lima, 1977

Fair, G.M.; Geyer, J.C.; Okun, D.A.

WATER AND WASTEWATER ENGINEERING

Vol. 2, Water Purification and Wastewater Treatment and Disposal

John Wiley & Sons, New York, 1968

Haney, P.D.

THEORETICAL PRINCIPLES OF AERATION

In: Journal Am. Water Works Assoc., Vol. 24(1932) No. 62

Langelier, S.

THE THEORY AND PRACTICE OF AERATION

Journal Am. Waterworks Assoc. Vol. 24(1932) No. 62

13. coagulation and flocculation

13.1 Introduction

Coagulation and flocculation provide the water treatment process by which finely divided suspended and colloidal matter in the water, is made to agglomerate and form flocs. This enables their removal by sedimentation or filtration. Colloidal particles (colloids) are midway in size* between dissolved solids and suspended matter. Colloids are kept in suspension ('stabilized') by electrostatic repulsion and hydration. Electrostatic repulsion occurs because colloids usually have a surface charge due to the presence of a double layer of ions around each particle. Thus, the colloid has an electric charge, mostly a negative one. Hydration is the reaction of particles at their surface with the surrounding water. The resulting particle-water agglomerates have a specific gravity which differs little from that of water itself.

The substances that frequently are to be removed by coagulation and flocculation, are those that cause turbidity and colour. Surface waters in tropical countries often are turbid and contain colouring material. Turbidity may result from soil erosion, algal growth or animal debris carried by surface runoff. Colour may be imparted by substances leached from decomposed organic matter, leaves, or soil such as peat. Both turbidity and colour are mostly present as colloidal particles.

The electrostatic repulsion between colloidal particles effectively cancels out the mass attraction forces (van der Waal's forces) that would bring the particles together. Certain chemicals (called coagulating agents, coagulants) have the capacity to compress the double layer of ions around the colloidal particles. They check the electrostatic repulsion, and thus enable the particles to flocculate, i.e. to form flocs. These flocs can grow to a sufficient size and specific weight to allow their removal by settling or filtration.

Generally, water treatment processes involving the use of chemicals are not so suitable for small community water supplies. They should be avoided whenever possible. Chemical coagulation and flocculation

* Size range: $5 \cdot 10^{-6}$ - $2 \cdot 10^{-4}$ millimetre

should only be used when the needed treatment result cannot be achieved with another treatment process using no chemicals. If the turbidity and colour of the raw water are not much higher than is permissible for drinking water, it should be possible to avoid chemical coagulation in the treatment of the water. A process such as slow sand filtration would serve both to reduce the turbidity and colour to acceptable levels, and to improve the other water quality characteristics, in a single unit. A roughing filter can serve to reduce the turbidity load on the slow sand filter, if necessary.

13.2 Coagulants

Alum ($\text{Al}_2(\text{SO}_4)_3 \cdot n\text{H}_2\text{O}$; aluminium sulphate) is by far the most widely used coagulant but iron salts (e.g. ferric chloride; FeCl_3) can be used as well, and in some instances have advantages over alum. A significant advantage of iron salts over aluminium is the broader pH* range for good coagulation. Thus, in the treatment of soft coloured waters where colour removal is best obtained at low pH's, iron salts may be preferred as coagulants. Iron salts should also be considered for coagulation at high pH's, since ferric hydroxide is highly insoluble in contrast to aluminum salts which form soluble aluminate ions at high pH's. Sodium aluminate is mostly used for coagulation at medium pH's. Synthetic organic polyelectrolytes have become available as coagulants but are generally not economical for small water supply systems, nor are they readily available.

Coagulants such as soluble aluminium and iron salts react with the alkalinity of the water, and hydrolyze in it. For example, alum reacts to form aluminium-hydroxide floc, $\text{Al}(\text{OH})_3$, a gelatinous precipitate. The required alkalinity may be naturally present in the water or it has to be added through dosage of lime, $\text{Ca}(\text{OH})_2$ or sodium carbonate, Na_2CO_3 (also called: soda-ash).

For good coagulation, the optimal dose of coagulant should be fed into the water and properly mixed with it. The optimal dose will vary depending upon the nature of the raw water and its overall composition. It is not possible to compute the optimal coagulant dose for a particular raw water. A laboratory ex-

* Measure of the acidity/alkalinity of water. Acid water has a pH below 7, the pH of alkaline water is higher than 7.

periment called the 'jar test' is generally used for the periodic determination of the optimal dose. The 'jar test' may be briefly described as follows:

A series of samples of water are placed on a special multiple stirrer and the samples are dosed with a range of coagulant, e.g. 10, 20, 30, 40 and 50 mg/l; they are stirred vigorously for about one minute. Then follows a gentle stirring (10 minutes), after which the samples are allowed to stand and settle for 30 to 60 minutes. The samples are then examined for colour and turbidity and the lowest dose of coagulant which gives satisfactory clarification of the water is noted.

A second test involves the preparation of samples with the pH adjusted so that the samples cover a range (e.g. pH = 5; 6; 7 and 8). The coagulant dose determined previously is added to each beaker. Then follows stirring, flocculation and settlement as before. After this, the samples are examined and the optimum pH is determined. If necessary, a re-check of the minimum coagulant dose can be done.

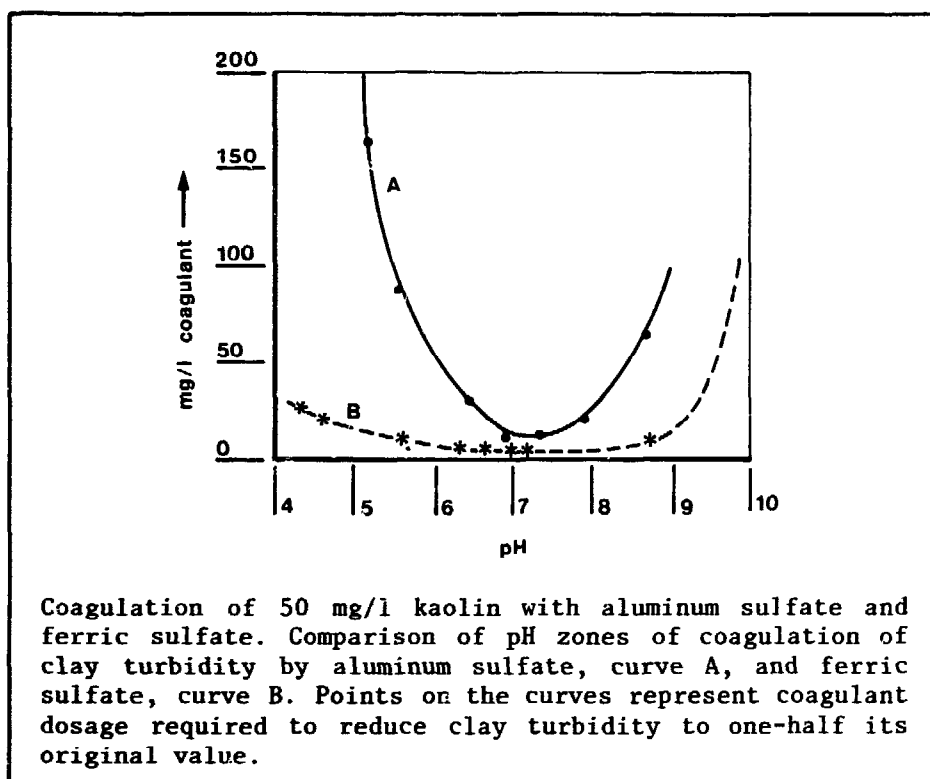

(Adapted from R.F. Packham).

Figure 13.1.
pH zone-coagulation relationship

As mentioned earlier, aluminium and iron salts have considerable differences in their pH zones of good coagulation. For alum the pH zone for optimum coagulation is quite narrow, ranging from about 6.5 to 7.5. The comparable range for ferric sulfate is considerably broader, a pH range of about 5.5 to 9.0 (Fig. 13.1). When the results of a 'jar test' are plotted, this type of curve is typical.

The most common method of dosing the alum or ferric sulphate is in the form of a solution. Such a solution (usually of 3 to 7% strength) is prepared in special tanks with a holding capacity of 10 or more hours coagulant feeding requirements. Two tanks are required, one in operation, while the solution is being prepared in the other.

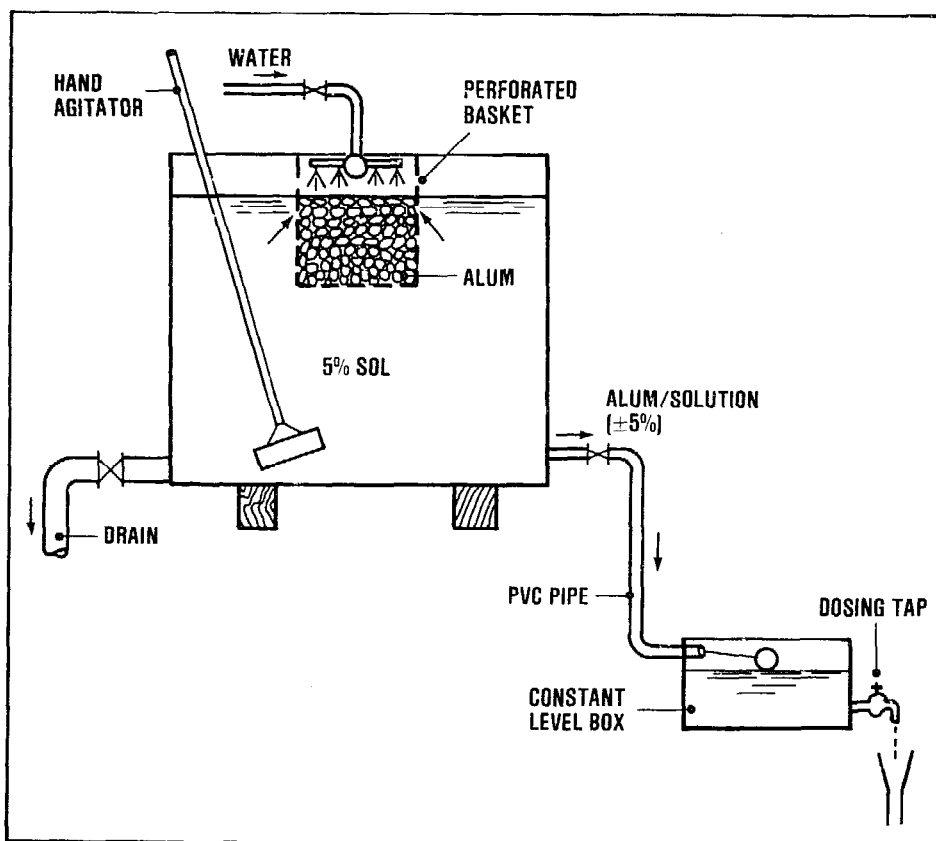

Figure 13.2.
Chemical feed arrangement for alum

When using alum, one should keep in mind that in solutions of less than 1 percent strength, the chemical is hydrolyzed (i.e. forms agglomerates with the

chemical feed water) before it is dosed into the raw water. To prevent this, the solution should always have a strength of more than 1.5 percent.

Various chemical feed arrangements can be used. Fig. 13.2. shows an example.

The simplest method of using lime is in the form of a suspension led into a special tank (called a 'Lime Saturator'), to produce a saturated solution of calcium hydroxide. The size of the tank depends on the required lime dosage.

For further information on chemicals used in water treatment, see Annex 4.

13.3. Rapid mixing

Rapid mixing aims at the immediate dispersal of the entire dose of chemicals throughout the mass of the raw water. To achieve this, it is necessary to agitate the water violently and to inject the chemical in the most turbulent zone, in order to ensure its uniform and rapid dispersal.

The mixing has to be rapid, because the hydrolysis of the coagulant is almost instantaneous (within a few seconds). The destabilisation of colloids also takes very little time.

The location of the rapid mixer should be near to the 'chemical house' where solutions of chemicals are prepared. The feeding pipes then will be of short length. It is also desirable to place the rapid mixing device close to the flocculators. To combine both these requirements in the layout of a treatment plant is often quite difficult.

Many devices are used to provide rapid mixing for the dispersal of chemicals in water. Basically, there are two groups:

- i) Hydraulic rapid mixing;
- ii) Mechanical rapid mixing.

Hydraulic Rapid Mixing

For hydraulic rapid mixing, arrangements are used such as: channels or chambers with baffles producing turbulent flow conditions, overflow weirs, and hy-

draulic jumps (Figs. 13.3; 13.4; 13.5). Rapid mixing may also be achieved by feeding the chemicals at the suction side of pumps. With a good design, a hydraulic mixer can be as effective as a mechanical mixing device.

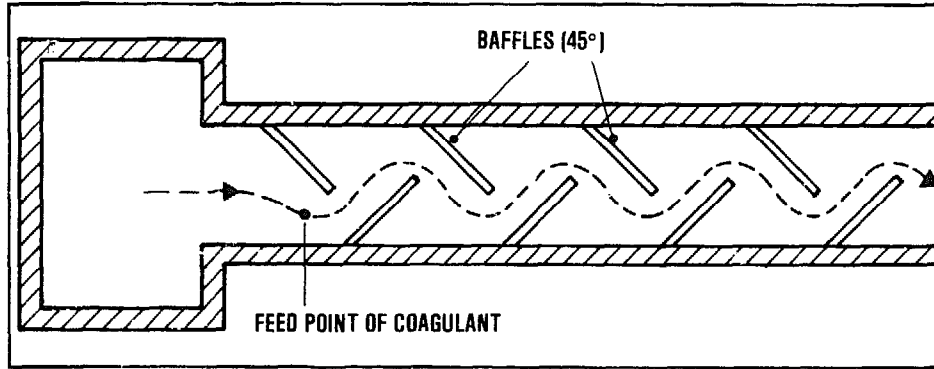
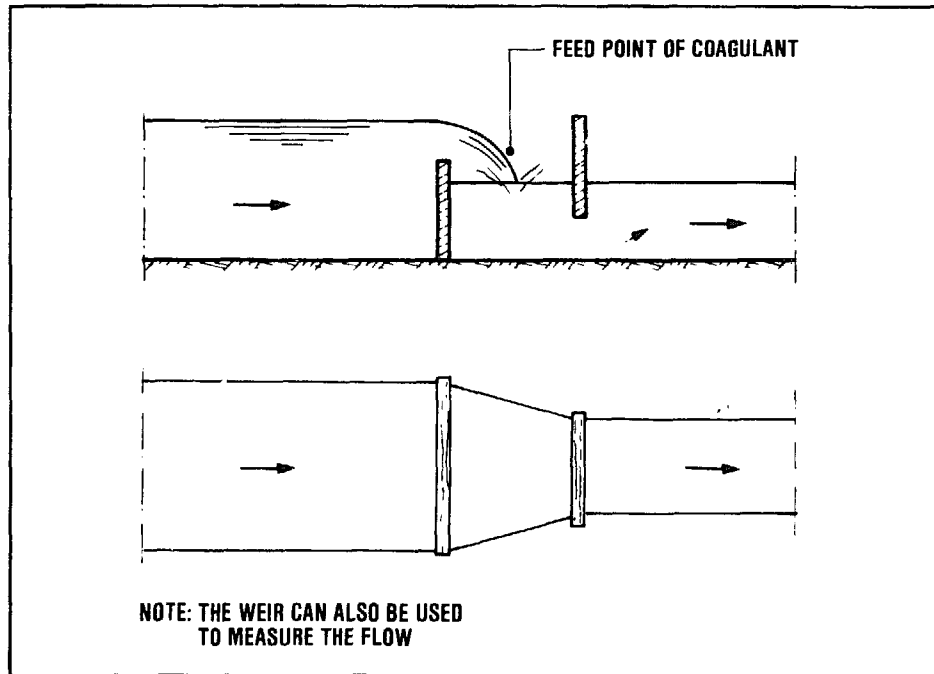

Figure 13.3.
Baffled channel for rapid mixing



NOTE: THE WEIR CAN ALSO BE USED
TO MEASURE THE FLOW

Figure 13.4.
Overflow weir

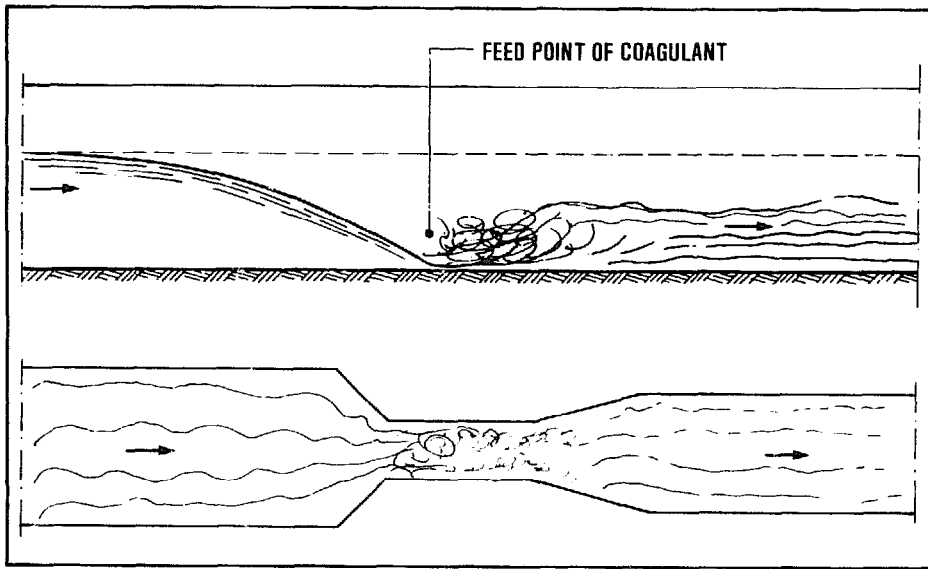

Figure 13.5.
Hydraulic jump



IRC Photo

Figure 13.6.
Hydraulic jump for rapid mixing (Philippines)

Mechanical Rapid Mixing

With mechanical mixing the power required for agitation of the water is imparted by impellers, propellers or turbines ('Rapid Mixers', 'Flash Mixers', 'Turbo Mixers'). See Fig. 13.7.

Generally, mechanical rapid mixers are less suitable for small treatment plants than hydraulic ones since they require a reliable and continuous supply of power.

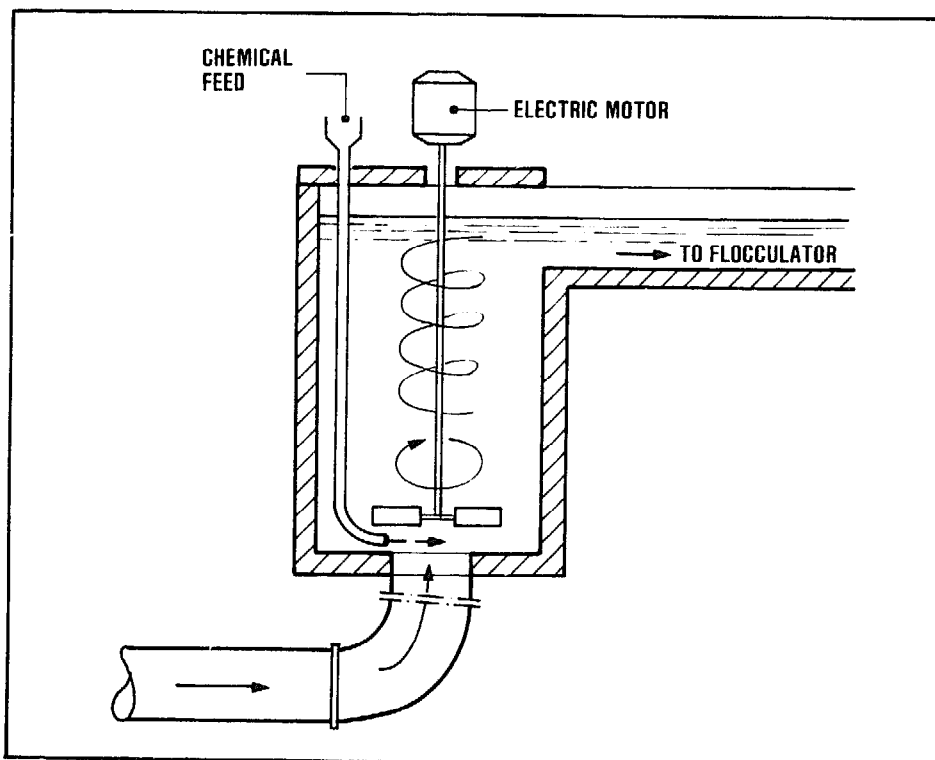

*Figure 13.7.
Mechanical mixer*

13.4 Flocculation

Flocculation is the process of gentle and continuous stirring of coagulated water for the purpose of forming flocs through the aggregation of the minute particles present in the water. It is thus the conditioning of water to form flocs that can be readily removed by settling or filtration. The efficiency of the flocculation process is largely determined by the

number of collisions between the minute coagulated particles per unit of time. There are mechanical and hydraulic flocculators.

In mechanical flocculators the stirring of the water is achieved with devices such as paddles, paddle reels or rakes.

These devices can be fitted to a vertical or horizontal shaft. Vertical shaft flocculators are usually placed in a square tank with several chambers (4 or more). With horizontal shaft flocculators having a traverse flow, one should provide at least 4 rows of shafts, with partitions of baffles (stop logs), so as to avoid short-circuiting.

In hydraulic flocculators, the flow of the water is so influenced by small hydraulic structures that a stirring action results. Typical examples are: channels with baffles, flocculator chambers placed in series (e.g. 'Alabama' flocculator) and gravel bed flocculators.

The main shortcomings of hydraulic flocculators are:

- No adjustment is possible to changes of raw water composition;
- No adjustment is possible to the water production rate of the treatment plant;
- The head loss is often appreciable;
- They may be difficult to clean.

Design of Flocculators

In the design of a flocculator installation not only the velocity gradient (G) should be taken into account, but also the detention time (t). The product G.t gives a measure for the number of particle collisions, and thus for the floc formation action.

The formula for computing the velocity gradient is:

$$G = \sqrt{\frac{P}{\mu V}}, \text{ in which}$$

G = velocity gradient (sec⁻¹)

P = power transmitted to the water (kilowatt)

V = volume of water to which the power is applied; where applicable, the volume of the mixing tank or basin (m³)

μ = kinematic viscosity of water (m²/sec)

(1.14 x 10⁻⁶ m²/sec at water temperature of 15°C;

1.01 x 10⁻⁶ m²/sec at 20°C; 0.90 x 10⁻⁶ m²/sec at 25°C).

*Table 13.1.
Flocculator design criteria*

Design Factor	G (sec ⁻¹)	t (sec)	G.t
Range	10 to 100	1.200 to 1.800	30.000 to 150.000
Typical Value	45 to 30	1.800	50.000 to 100.000

For each individual flocculator, the optimal G.t value should be carefully selected, and taken as high as is consistent with the optimal formation of flocs without causing disruption or disintegration of the flocs after they have formed. The internal cohesion of the flocs can be improved by chemicals such as activated silica or polyelectrolytes (coagulant aids).

13.5 Hydraulic flocculators

Baffled Channel Flocculators

For horizontal-flow baffled flocculation channels (Fig. 13.8), the design water velocity usually is in the 0.10 to 0.30 m/sec. range. Detention time normally is 15 to 20 minutes.

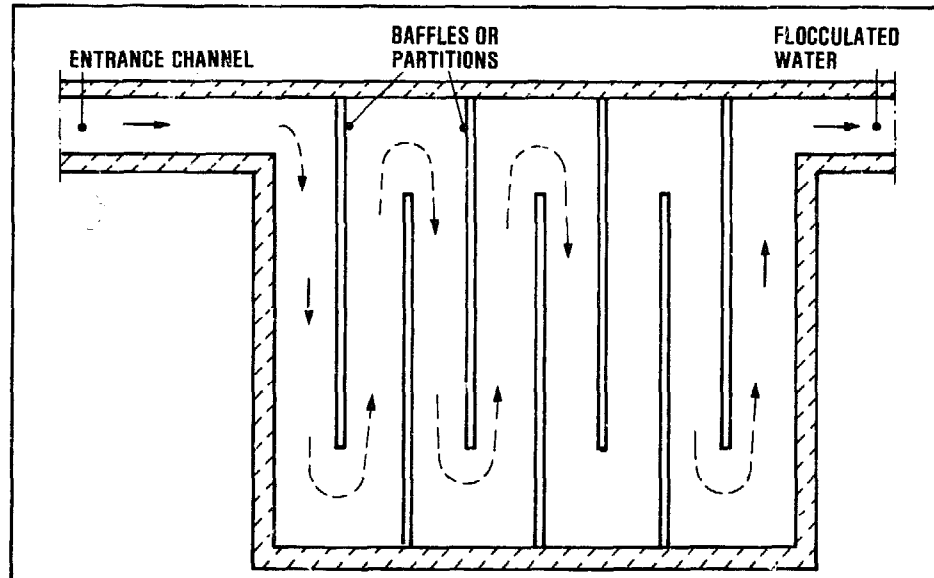

*Figure 13.8.
Horizontal-flow baffled channel flocculator (plan)*

This type of flocculator is well suited for very small treatment plants. The efficiency, however, is highly dependent on the depth of water in the baffled channel.

Flocculators with vertical flow through baffled chambers (Fig. 13.9) are mostly used for medium- and larger-size water treatment plants. The water flow velocity range is 0.1 - 0.2 m/sec. Detention time is 10 - 20 minutes. Cleaning arrangements are called for because of deposits in the flocculator.

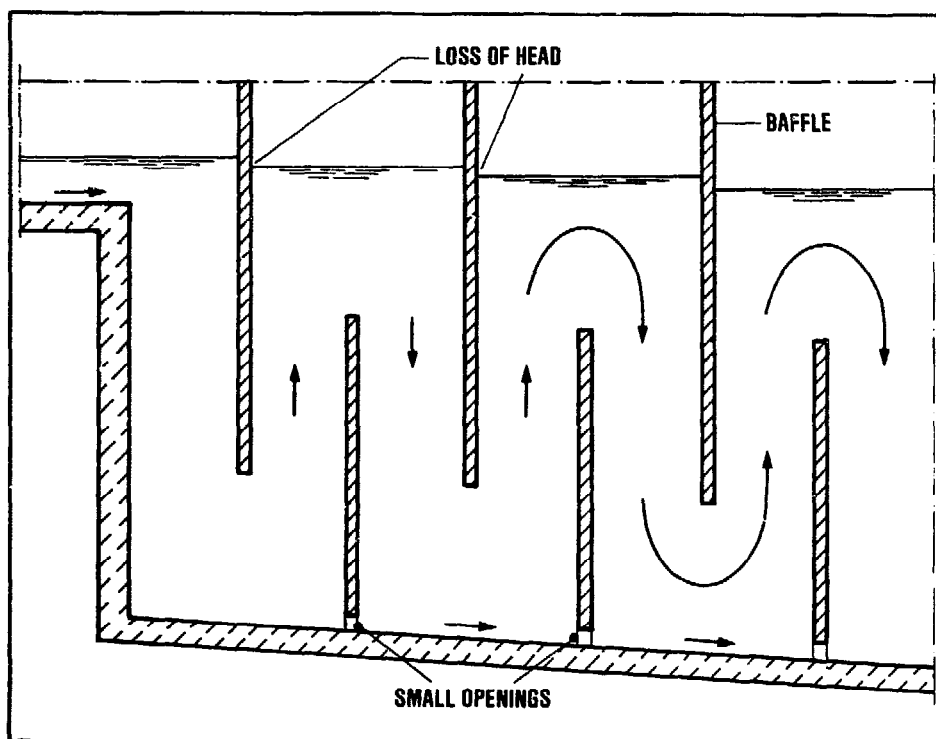

Figure 13.9.
Vertical-flow baffled chamber flocculator (cross section)

'Alabama'-type Flocculators

'Alabama'-type flocculators are hydraulic flocculators having separate chambers placed in series through which the water flows in two directions (Fig. 13.10). The water flows from one chamber to the next, entering each adjacent partition at the bottom end through outlets turned upwards. This type of flocculator was initially developed and used in the State of Alabama (U.S.A.) and later introduced in Latin America.

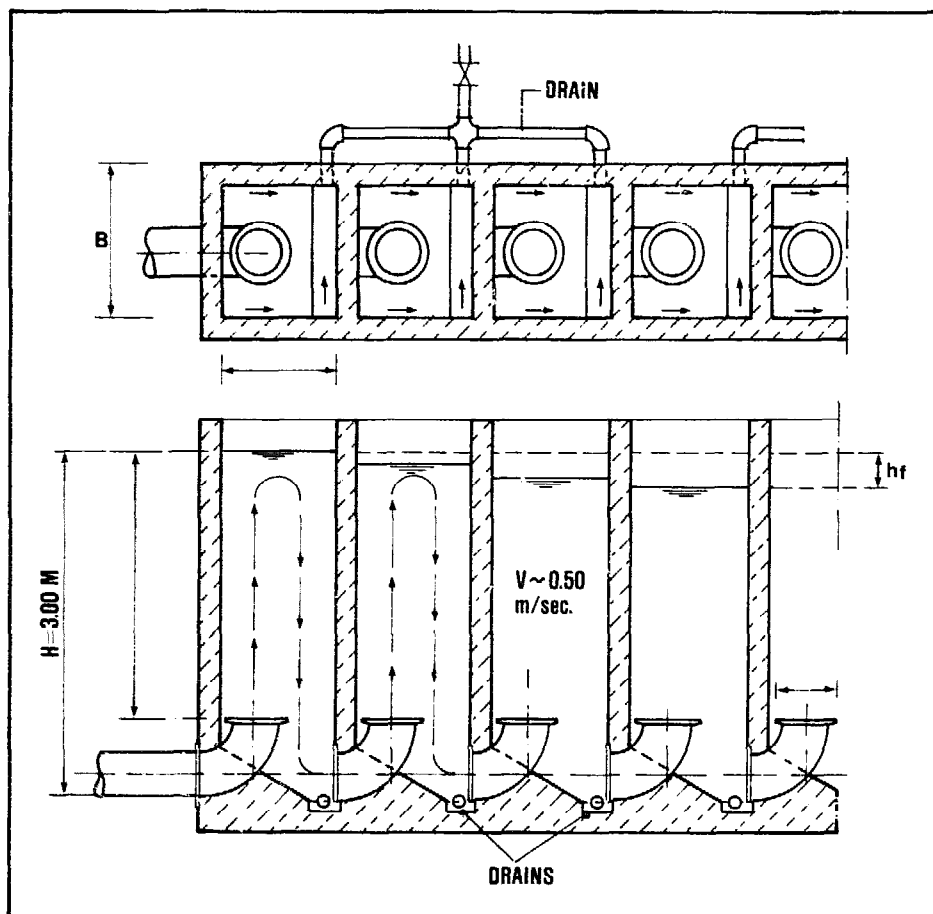

Fig. 13.10.
'Alabama'-type flocculator

For effective flocculation in each chamber, the outlets should be placed at a depth of about 2.50 m below the water level.

Common design criteria are:

Rated capacity per unit chamber:	25 to 50 litres/ sec per square metre
Velocity at turns	0.40 to 0.60 m/sec
Length of unit chamber (L)	0.75 - 1.50 m
Width (B)	0.50 - 1.25 m
Depth (h)	2.50 to 3.50 m
Detention time (t)	15 to 25 minutes

The loss of head in this type of flocculator normally is about 0.35 to 0.50 m for the entire unit. The velocity gradient is usually in the 40-50 sec^{-1} range.

Table 13.2 provides practical guidance for the design of an 'Alabama'-type flocculator.

*Table 13.2.
Guidance for 'Alabama'-type flocculator design*

Flow Rate Q	Width B	Length L	Diameter D	Unit chamber area	Unit chamber volume
l/sec.	(m)	(m)	(mm)	(m ²)	(m ³)
10	0.60	0.60	150	0.35	1.1
20	0.60	0.75	250	0.45	1.3
30	0.70	0.85	300	0.6	1.8
40	0.80	1.00	350	0.8	2.4
50	0.90	1.10	350	1.0	3.0
60	1.00	1.20	400	1.2	3.6
70	1.05	1.35	450	1.4	4.2
80	1.15	1.40	450	1.6	4.8
90	1.20	1.50	500	1.8	5.4
100	1.25	1.60	500	2.0	6.0

Example:

Flow $Q = 1.2 \text{ m}^3/\text{minute}$. Detention time = 15 min. Size of curved pipe: 250 mm (10"). Unit chamber measures $0.60 \times 0.75 \text{ m}^2$. Volume of unit chamber: 1.3 m^3 . Total volume required: $15 \times 1.2 = 18 \text{ m}^3$. Number of chambers $18/1.3 = 14$.

Hydraulic Jet Mixer and Flocculator

In a jet flocculator the coagulant (alum) is injected in the raw water using a special orifice device. The water is then jetted into a tapered cylinder placed above the nozzle. The resulting jet pump action gives a gentle stirring of the water for floc formation, and part of the formed flocs are recycled (Fig. 13.11). Through these two actions, in combination, excellent flocculation results can be achieved.

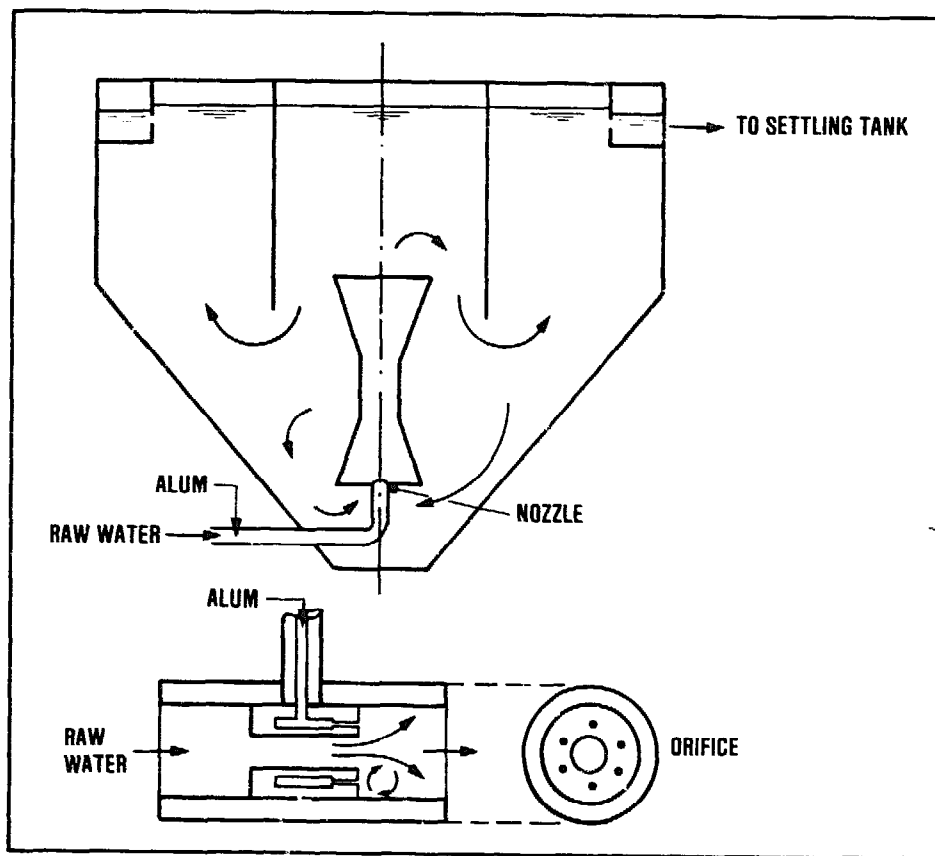

Figure 13.11.
Hydraulic jet flocculator

Coagulation and flocculation

Arboleda, J.
TEORIA, DISEÑO Y CONTROL DE LOS PROCESOS DE CLARIFICACION DEL
AGUA
Centro Panamericano de Ingenieria Sanitaria y Ciencias del Ambiente
Lima, 1977

A.W.W.A.
WATER TREATMENT PLANT DESIGN
Am. Water Works Assoc., New York, 1969

Azevedo Netto, J.M. et al
TECNICA DE ABASTECIMIENTO E TRATAMENTO DE AQUA
Vol. 2 (2nd Edition), CETESB, Sao Paulo, 1977

Camp, T.R.
FLOCCULATION AND FLOCCULATION BASINS
Trans Am. Soc. Civil Engineers, 1955, 120, pp. 1-16

Cox, C.R.
OPERATION AND CONTROL OF WATER TREATMENT PROCESSES
World Health Organisation, Geneva, 1964

Fair, G.M.; Geyer, J.C.; Okun, D.A.
WATER AND WASTEWATER ENGINEERING
Vol. 2; Water Purification and Wastewater Treatment and Disposal,
John Wiley & Sons, New York, 1968

Gomella, C.; Guerrée, H.
LA TRAITEMENT DES EAUX DE DISTRIBUTION
Editions Eyrolles, Paris, 1973

Hudson, H.E.; Wolfner, J.P.
DESIGN OF MIXING AND FLOCCULATING BASINS
In: Journal Am. Water Works Assoc. Vol 59(1967) No. 10, pp. 1257-1267

O'Melia, C.R.
A REVIEW OF THE COAGULANT PROCESS
In: Journal of Public Works, No. 3, 1969

Singley, J.E.
STATE-OF-THE-ART OF COAGULATION
PAHO Symposium on Modern Water Treatment Methods
Asuncion (Paraguay), August, 1972

Singley, J.E.; Maulding, J.S.; Harris, H.R.
FERRIC SULFATE AS A COAGULANT
Coagulation Symposium, Part III
In: Water Works and Wastes Engineering, Vol. 52(1965) No. 2

Stumm, W.; Morgan, J.J.

CHEMICAL ASPECTS OF COAGULATION

In: Journal Am. Water Works Assoc. Vol. 63(1971) No. 8, pp. 971-994

Vralé, L.; Jordan, R.M.

RAPID-MIXING IN WATER TREATMENT

In: Journal Am. Water Works Assoc. Vol. 63(1971) No. 8, pp. 52-63

14. sedimentation

14.1 introduction

Sedimentation is the settling and removal of suspended particles that takes place when water stands still in, or flows slowly through a basin. Due to the low velocity of flow, turbulence will generally be absent or negligible, and particles having a mass density (specific weight) higher than that of the water will be allowed to settle. These particles will ultimately be deposited on the bottom of the tank forming a sludge layer. The water reaching the tank outlet will be in a clarified condition.

Sedimentation takes place in any basin. Storage basins through which the water flows very slowly, are particularly effective but not always available. In water treatment plants, settling tanks specially designed for sedimentation are widely used. The most common design provides for the water flowing horizontally through the tank but there are also designs for vertical* or radial flow. For small water treatment plants, horizontal-flow, rectangular tanks generally are both simple to construct and adequate.

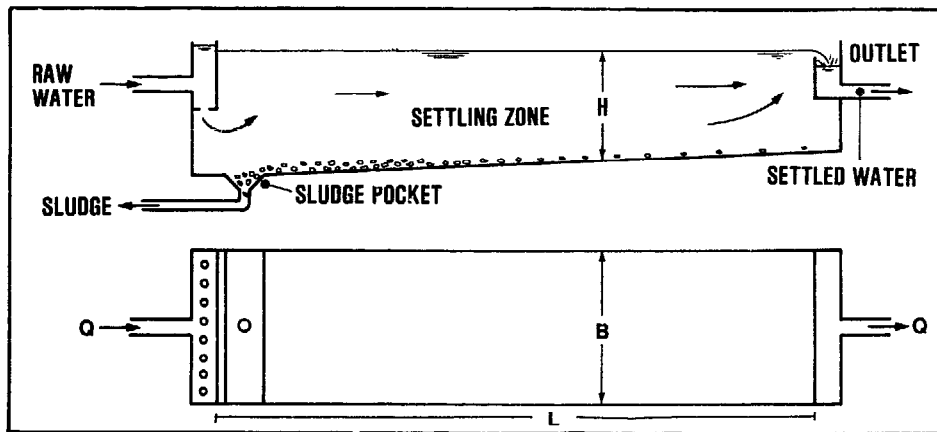

Figure 14.1.
Rectangular horizontal flow settling tank

* The operational requirements of vertical-flow sludge blanket-type settling tanks are so strict that they are generally not suitable for small water treatment plants.

The efficiency of the settling process will be much reduced, if there is turbulence or cross-circulation in the tank. To avoid this, the raw water should enter the settling tank through a separate inlet structure. Here the water must be divided evenly over the full width and depth of the tank. Similarly, at the end of the tank an outlet structure is required to collect the clarified water evenly. The settled - out material will form a sludge layer on the bottom of the tank. Settling tanks need to be cleaned out regularly. The sludge can be drained off or removed in another way. For manual cleaning (e.g. scraping), the tank must first be drained.

14.2 Settling tank design

The efficiency of a settling tank in the removal of suspended particles can be determined using as a basis the settling velocity (s_0) of a particle which in the detention time (T) will just traverse the full depth (H) of the tank. Using these notations (see Fig. 14.1), the following formulae are applicable:

$$s_0 = \frac{H}{T} ; T = \frac{BLH}{Q}, \text{ so that } s_0 = \frac{Q}{BL} \quad (\text{m}^3/\text{m}^2 \cdot \text{hr} = \text{m}/\text{hr})$$

s_0 = settling velocity (m/hr)
 T = detention time (hr)
 Q = flow rate (m^3/hr)
 H = depth of tank (m)
 B = width of tank (m)
 L = length (m)

Assuming an even distribution of all suspended particles in the water over the full depth of the tank (by way of an ideal inlet structure), particles having a settling velocity (s) higher than s_0 will be completely removed, and particles that settle slower than s_0 will be removed for a proportional part, $s : s_0$.

This analysis shows that the settling efficiency basically only depends on the ratio between the influent flow rate and the surface area of the tank. This is called the "surface loading". It is independent of the depth of the tank. In principle, there is no difference in settling efficiency between a shallow and a deep tank.

The settling efficiency of a tank as shown in Fig. 14.1, may therefore be greatly improved by the installation of an extra bottom as indicated in Fig. 14.2. The effective surface area would be greatly increased and the surface loading would be much lower.

The design of a settling tank should properly be based on an analysis of the settling velocities of the settleable particles in the raw water (see: Annex 3).

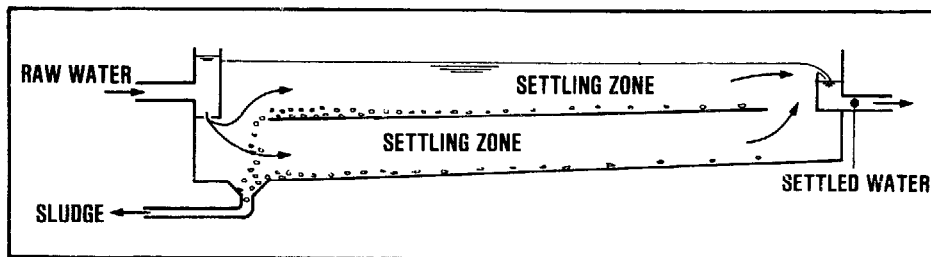

Figure 14.2.
Settling tank with extra bottom

Where sedimentation is used without pre-treatment, (this is called "plain sedimentation") for the clarification of river water, the surface loading generally should be in the range from 0.1-1 m/ hour. For settling tanks receiving water that has been treated by chemical coagulation and flocculation, a higher loading is possible, somewhere between 1 and 3 m/hour. In both cases, the lower the surface loading the better the clarification of the water: the settled water will have less turbidity.

The above considerations ignore the effects of turbulence, short-circuiting and bottom scour. To keep these effects to a minimum, the tank should not be too shallow, at least 2 m deep or more, and the ratio between length and width should be between 3 and 8. The horizontal velocity of flow, computed as $v_0 = Q/BH$, will then be in the 4 to 36 m/hour range. A tank 2 m deep or more could accommodate mechanical sludge removal equipment but small installations are better cleaned manually. This is done at intervals varying from one to several weeks. The depth of the tank should be adequate to accommodate the sludge accumulating at the bottom between the cleanings.

For a further elaboration of settling tank design, take the example of a town with a future population of 10,000 inhabitants, requiring an average of 40 litres/day per person. Assuming a maximum daily demand of 1.2 times the average demand, the design capacity should be:

$$Q = 10,000 \times \frac{40}{1,000} \times 1.2 = 480 \text{ m}^3/\text{day} = 20 \text{ m}^3/\text{hour}$$

If the raw water source is turbid river water, it may be subjected to plain sedimentation as a first treatment. Two settling tanks should be built. If the second tank serves only as a reserve for when the first tank is out of operation, then each of the two settling tanks has to be designed to take the full design flow ($Q = 20 \text{ m}^3/\text{hour}$). An alternative is to provide two tanks of $10 \text{ m}^3/\text{hour}$ capacity each; this would give a saving in construction costs. With one of these tanks out of operation for cleaning, the other tank has to be overloaded for the duration of the cleaning operation. In many situations this can be quite acceptable. Whether this approach may be followed, must be determined in each individual case.

If experience with other installations using the same water source indicates that a surface loading of $0.5 \text{ m}^3/\text{hour}$ gives satisfactory results, the sizing of the tank for a design capacity of $20 \text{ m}^3/\text{hour}$ would be as follows:

$$\frac{Q}{BL} = \frac{20}{BL} = 0.5, \text{ so that } BL = 40 \text{ m}^2$$

The tank dimensions could be, for instance:
 $B = 3 \text{ m}$, $L = 14 \text{ m}$.

With a depth of 2 m the tank would have about 0.5 m available for filling up with sludge deposits before cleaning is needed. The horizontal flow velocity would be:

$$v = \frac{Q}{BH} = \frac{20}{(3)(1.5)} = 4.44 \text{ m/hour.}$$

This is well within the design limits quoted above. Assuming that during periods of high turbidity the river water contains a suspended load of 120 mg/l which is to be reduced to 10 mg/l by sedimentation, then 110 grammes of silt will be retained from every

cubic meter of water clarified. With a surface loading of 0.5 m/hour this means an average sludge accumulation of 55 gram/m²/hour; that is for sludge having a dry matter content of 3%, an amount of $55 : 0.03 = 1830 \text{ cm}^3/\text{m}^2$ per hour = 1.83 mm/hour. At the inlet end of the tank the deposits will accumulate faster, probably about 4 mm/hour, so that for an allowable accumulation of 0.5 m an interval of 125 hours or 5 days between cleanings is to be expected. When the periods of high turbidity are infrequent and of short duration, this is certainly acceptable.

14.3 Construction

Settling tanks with vertical walls are normally built of masonry or concrete; dug settling basins mostly have sloping banks of compacted ground with a protective lining, if necessary.

Medium and large size settling tanks generally have a rectangular plan and cross-section. To facilitate sludge removal it is convenient to have the tank bottom slope lightly towards the inlet end of the tank where the sludge pocket is situated.

As described in section 14.1, a settling tank should have a separate inlet arrangement ensuring an even distribution of the water over the full width and depth of the tank. Many designs can be used; Fig. 14.3 shows a few examples. The arrangement shown to the left consists of a channel over the full width of the tank with a large number of small openings in the bottom through which the water enters the settling zone. For a uniform distribution of the influent these openings should be spaced close to each other, less than 0.5 m apart, and their diameter should not be too small (e.g. 3-5 cm) otherwise they may clog up. The channel should be generously sized, with a cross-sectional area of at least twice the combined area of the openings. A settling tank as elaborated in the example given earlier, with a capacity of 20 m³/hour and a width of 3 m, would have in the inlet channel about 6 holes of 4 cm diameter. The inlet channel itself would be about 0.4 m deep and 0.3 m wide.

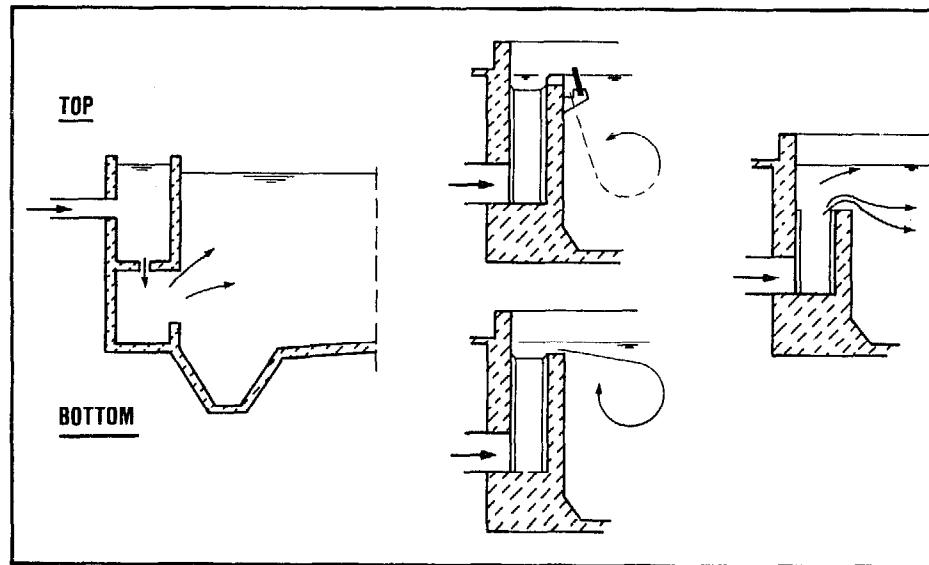

Figure 14.3.
Inlet arrangements

Frequently, the effluent water leaves the tank over weirs. Sometimes one weir is adequate but to prevent the settled material from being picked up again, the draw-off of the water should always be gentle and more weirs may have to be provided (combined length nB). The following formula can be used for computing the total weir length required:

$$nB = \frac{Q}{5Hs_0}$$

In the example of the preceding section:

$$(n)(3) = \frac{20}{(5)(1.5)(0.5)} \text{ or } n = 2$$

Outlet arrangements using one and more overflow weirs are shown in Fig. 14.4.

When low weir overflow rates are used, the precise horizontal positioning of the weir crest is of importance. In the above example the $5 \text{ m}^3/\text{hour}$ overflow rate would give an overflow height Δ of only 8 mm. A slight deviation of the weir crest from the horizontal would then already cause a very uneven withdrawal of the settled water. To avoid this as much as possible, the weir crest may be made of a special metal strip fastened with bolts to the concrete weir wall. The top of such a strip is not

straight; it has triangular notches at intervals (Fig. 14.5). Another solution is shown in Fig. 14.4 to the left. Openings in the settling tank wall are used which should be of a smaller diameter than for the similar inlet construction. For $Q = 20 \text{ m}^3/\text{hour}$, 6 openings of 2.5 cm diameter should be adequate. The suspended matter content of the effluent water normally being low, the danger of clogging the holes is small and cleaning should not be needed frequently.

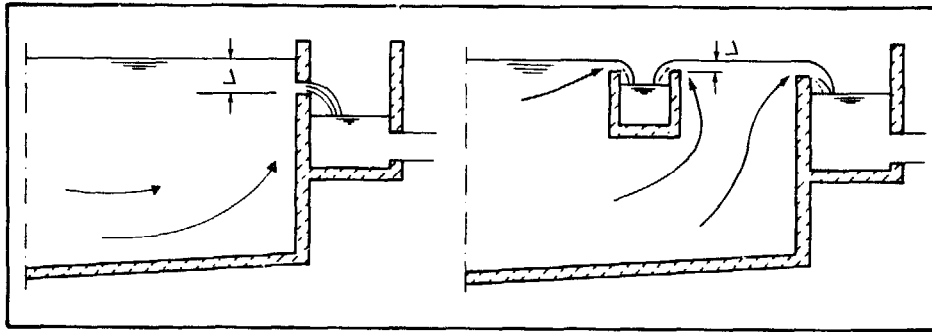

Figure 14.4.
Outlet arrangements

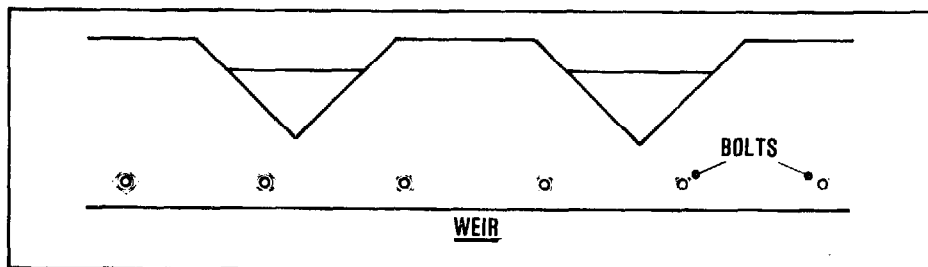

Figure 14.5.
Notched overflow weir

Earlier it was mentioned that small settling tanks may also be constructed simply as a basin with vertical walls of wooden sheet piling or similar material (Fig. 14.6), or with sloping walls (Fig. 14.7). In the latter case, only half the wetted slope length should be taken into account when computing the effective surface area and, thus, the surface loading of the settling basin. In both cases the basin should be constructed on raised ground to prevent flooding during wet periods.

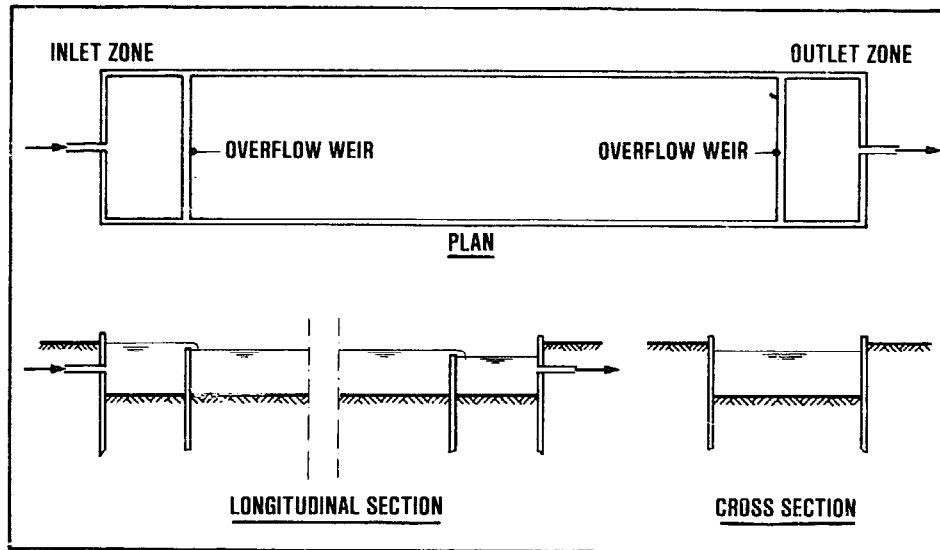

Figure 14.6.
Settling basin constructed with wooden sheet piles

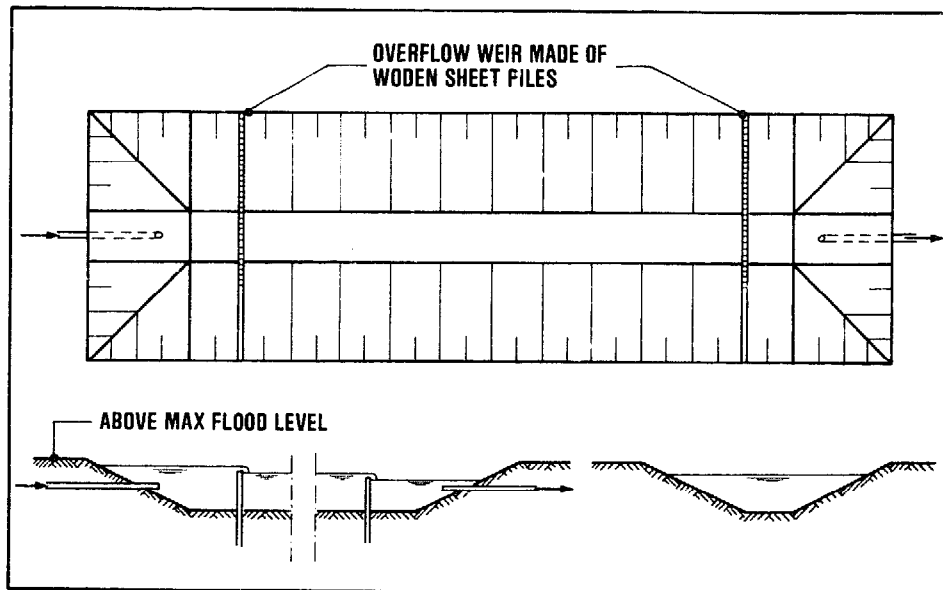

Figure 14.7.
Dug basin as settling tank

14.4. Tilted plate and tube settlers

The improvement in settling efficiency which can be obtained by the installation of one extra bottom (tray) in a settling tank can be greatly increased by using more trays as shown in Fig. 14.8. The space between such trays being small, it is not possible to remove the sludge deposits manually with scrapers. Hydraulic cleaning by jet washing would be feasible but a better solution is the use of self-cleaning plates. This is achieved by setting the plates steeply at an angle of 40 to 60° to the horizontal. The most suitable angle depends on the characteristics of the sludge which will vary for different types of raw water. Such installations are called tilted plate settling tanks. This type of tank is shown schematically in Fig. 14.9. Fig. 14.10 shows a cross-section.

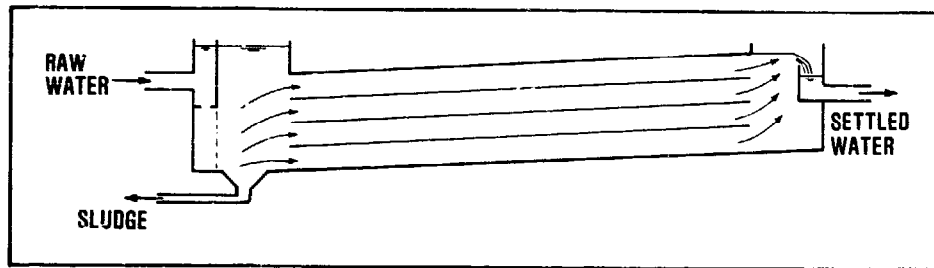

Figure 14.8.
Multiple-tray settling tank

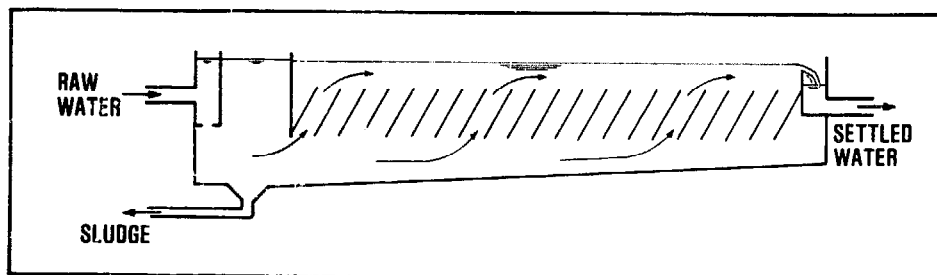

Figure 14.9.
Tilted plate settling tank

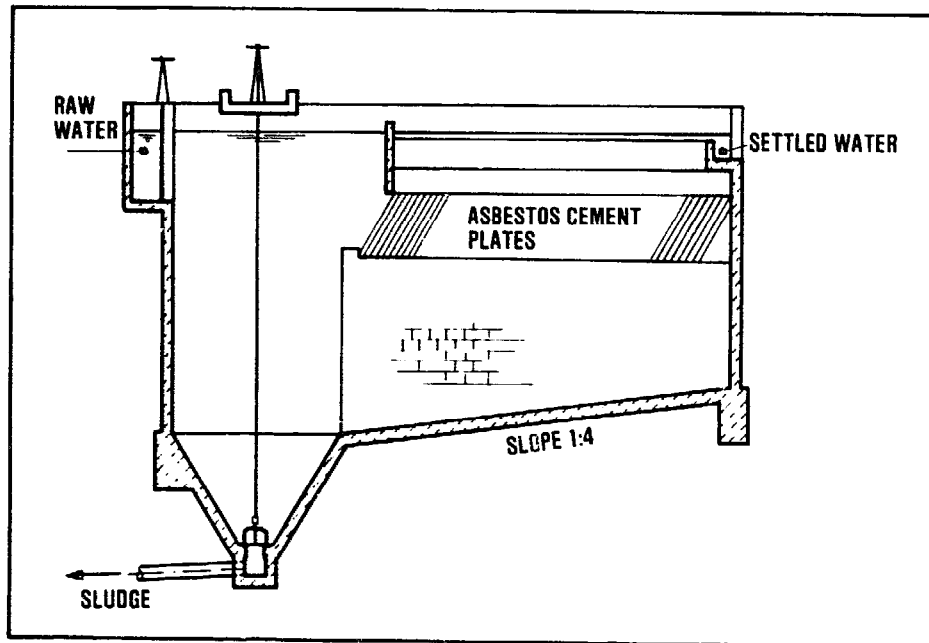

Figure 14.10.
Settling tank with tilted plates

For large tanks, quite sophisticated systems of trays or plates, have been devised but in small installations flat or corrugated plates and upward flow of the water are frequently the most suitable. For any clarification duty, tilted plate settling tanks have the advantage of packing a large capacity in a small volume. The effective surface being large, the surface loading will be low, and the settling efficiency, therefore, high. The surface loading may be computed as:

$$s = \frac{Q}{nA}$$

s = surface loading ($\text{m}^3/\text{m}^2/\text{hour}$)

Q = rate of flow (m^3/hour)

A = bottom area of the tank (m^2)

n = multiplication factor depending on the type and position of the tilted plates.

Water enters at the bottom of the settling tank, flows upward, passes the tilted plates, and is collected in troughs (Fig. 14.11). As the water flows upwards past the plates the settleable particles fall to the plates. When they strike it, they slide downwards, eventually falling to the area beneath the

plates. An individual particle might enter the plate channels several times before it agglomerates and gathers sufficient weight to eventually settle to the tank floor.

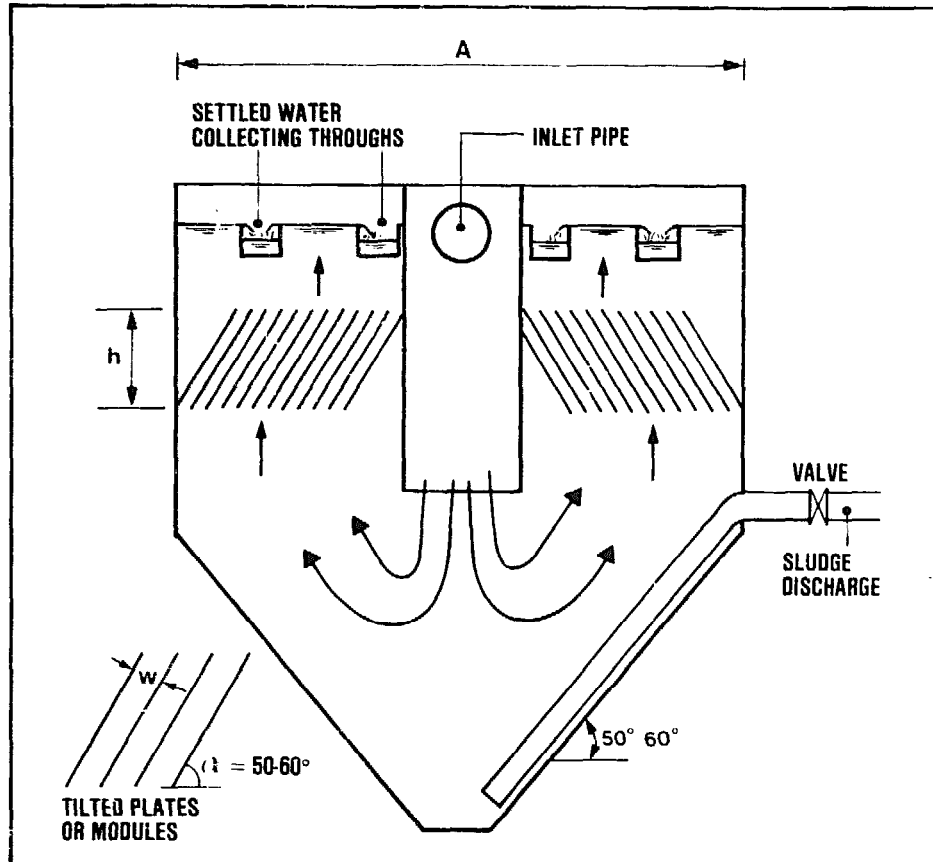

Figure 14.11.
Tilted plate settling tank design parameters

Assuming $h = 1.5$ m, $w = 0.05$ m, $\alpha = 55^\circ$ and plates made of asbestos cement with a thickness of 6 mm, we find $n = 16$! One should keep in mind that the sludge deposits per unit bottom area will also be 16 times greater, for the same influent flow rate. Manual sludge removal will probably be impractical. In a tank having a square plan, rotating sludge scrapers might be used. Another possibility is the use of hopper-bottomed tanks with the walls sloping at about 50° to the horizontal. The depth of such a tank will be considerable and the costs of construction are likely to be much greater than for flat-bottomed tanks. Sludge discharge is carried out through the

draining of water from the hopper-bottom section of the tank (this is called "bleeding").

Instead of tilted plates, closely packed tubes may be used. These can easily be made of PVC pipes, usually of 3-5 cm internal diameter and sloping about 60° to the horizontal. For large installations commercially available tube models can have merit. An example is shown in Fig. 14.12. There are many other designs that may give an equally good settling efficiency.

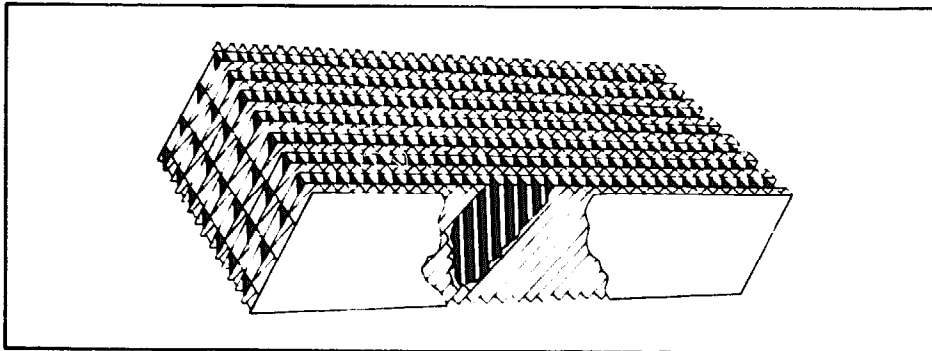

Figure 14.12.
Module for tube settler

In a 5 cm dia tube, the farthest distance any particle must settle is from the top of the tube to the bottom. If the particle's settling rate is 2.5 cm/minute it will take only two minutes for the particle to reach the bottom. In contrast, if the same particle were to settle in a 3 m deep tank, it would take 120 minutes (2 hours) for it to fall to the tank bottom. Tube modules commonly are approximately 76 cm wide, 3 m long and 54 cm deep. Because the tubes are at an angle of 60° the effective tube length is 61 cm.

Tube modules can be constructed from flat sheets of ABS plastic with the passage ways formed by slabs of PVC. The passage ways are slanted in a criss-cross pattern for structural strength so that the module need be supported only at its ends. Being of plastic these modules can be easily trimmed to fit the available space in a settling tank.

The effective settling surface is very great and, thus, the "surface loading" (overflow rate) very low. To illustrate this: a flow rate of $2 \text{ m}^3/\text{hour}$ through a settling basin of 0.1 m^2 surface represents a "surface loading" of $20 \text{ m}^3/\text{m}^2/\text{hour}$. If twenty rows of

tubes are used, the surface loading will be reduced to $1 \text{ m}^3/\text{m}^2/\text{hour}$. The detention time of the water in each tube will be just a few minutes.

The possibility of increasing the efficiency of a tank through the installation of tilted plates or tubes may be used with great advantage for raising the capacity of existing settling tanks. Where the available tank depth is small, less than 2 m, the installation of the tilted plates or tubes is likely to meet with problems. In deeper tanks, they can be very advantageous.

In considering the expansion of existing facilities by the addition of tilted plates or tubes, it is important to remember that more sludge will be generated and so additional removal facilities may be required. Inlet and outlet pipe sizes and weir capacity should also be checked to see if they can carry the increased loading.

Sedimentation

Babbitt, H.E.; Doland, J.J.; Cleasby, J.L.
WATER SUPPLY ENGINEERING
McGraw-Hill, New York, 1962 (6th Edition)

Camp, T.R.
SEDIMENTATION AND THE DESIGN OF SETTLING TANKS
In: Trans. ASCE, 1946, No. 3, pp. 895-903

Culp, A.M.; Kou-Ying Hsiung, Conley, W.R.
TUBE CLARIFICATION PROCESS: operating experiences
In: Proc. Am. Soc. Civil Eng. Vol. 95(1969) SA 5 October, pp. 829-836

Fair, G.M.; Geyer, J.C.; Okun, D.A.
WATER AND WASTEWATER ENGINEERING
Vol. 2, Water Purification and Wastewater Treatment and Disposal,
John Wiley & Sons, New York, 1968

Hazen, A.
ON SEDIMENTATION
In: Trans. Am. Soc. Civil Eng., 1904, No. 53, pp. 45-51

15. slow sand filtration

15.1 Introduction

Filtration is the process whereby water is purified by passing it through a porous material (or 'medium'). In slow sand filtration a bed of fine sand is used through which the water slowly percolates downward (Fig. 15.1). Due to the fine grain size the pores of the filter bed are small. The suspended matter present in the raw water is largely retained in the upper 0.5-2 cm of the filter bed. This allows the filter to be cleaned by scraping away the top layer of sand. As low rates of filtration are used ($0.1-0.3$ m/hour = $2-7$ m³/m²/day), the interval between two successive cleanings will be fairly long, usually several months. The filter cleaning operation need not take more than one day but after cleaning, one or two more days are required for the filter bed to again become fully effective.

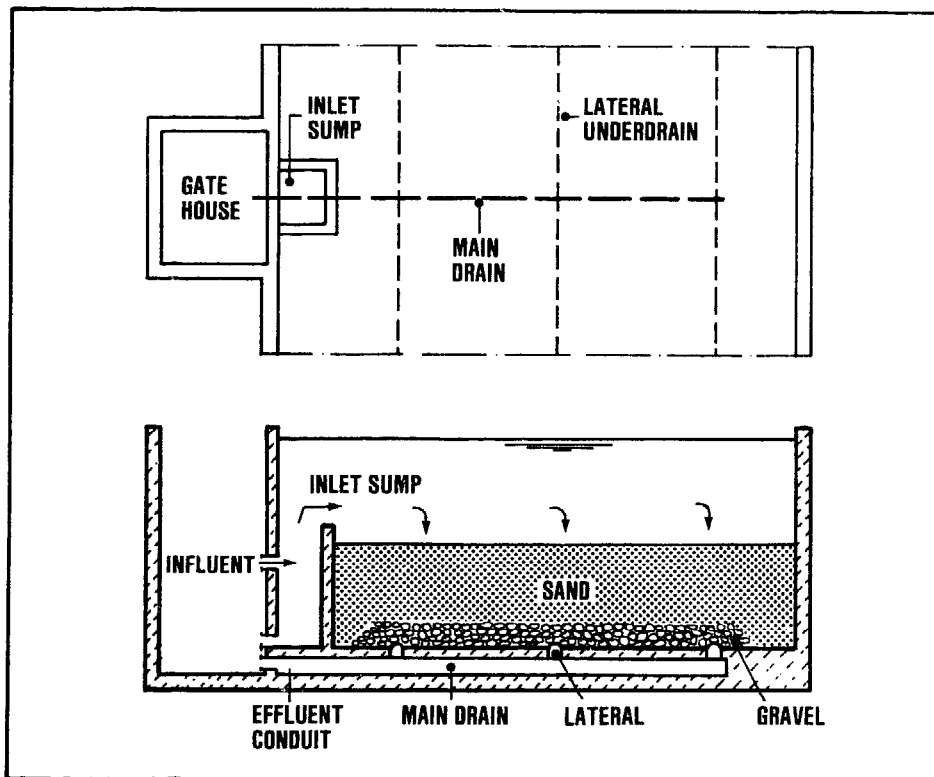
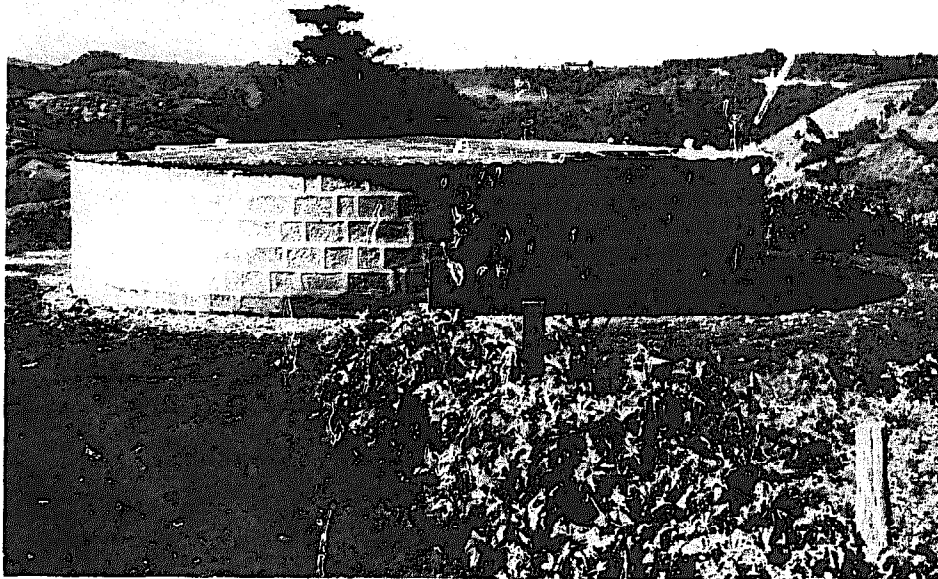

Figure 15.1.
Slow sand filter

The main purpose of slow sand filtration is the removal of pathogenic organisms from the raw water, in particular the bacteria and viruses responsible for the spreading of water-related diseases. Slow sand filtration is highly efficient in this respect as it is capable of reducing the total bacteria content by a factor of 1,000 to 10,000, and the E.coli content by a factor 100 - 1,000. A well-operated slow sand filter will remove protozoa such as Endamoeba histolytica and helminths such as schistosoma haematobium and Ascaris lumbricoides. When processing raw water that is only lightly contaminated, slow sand filters will produce a bacteriologically safe water. E.coli will normally be absent in a 100 ml sample of the filtered water, which satisfies normal drinking water standards.



IRC Photo

Figure 15.2.
Slow sand filter - circular type (Pakistan).

Slow sand filters are also very effective in removing suspended matter from the raw water. However, the clogging of the filter bed may be too rapid necessitating frequent cleanings. Trouble-free operation is only possible when the average turbidity of the raw water is less than 5 F.T.U., with peak values below 20 F.T.U. and occurring for periods of a few days only. When this is not the case, the suspended load

in the raw water must be reduced by a pre-treatment process such as sedimentation, coagulation and flocculation, or rapid filtration, before the water is admitted to the slow sand filter. In storage reservoirs, suspended particles will be removed by settling but a rapid blocking of the slow sand filter bed would still take place when considerable algal growth occurs. Pre-treatment will then be necessary.

Slow sand filters have many advantages for use in developing countries. They produce a clear water, free from suspended impurities and hygienically safe. They can be built with local materials using local skills and labour. Much of the complex mechanical and electrical equipment required for most other water treatment processes can be avoided. Slow sand filters do not for their operation require coagulating chemicals, lime or chlorine that frequently need to be imported. It is true that they occupy more land and that their cleaning calls for ample labour but particularly in the rural areas of developing countries these requirements generally should be no drawbacks.

15.2 Theory of slow sand filtration

In slow sand filters, the removal of impurities from the raw water is brought about by a combination of different processes such as sedimentation, adsorption, straining and, most importantly, biochemical and microbial actions. The purification processes start in the supernatant water but the major part of the removal of impurities from the water and the microbial and bio-chemical processes take place in the top layer of the filter bed, the 'Schmutzdecke'*

Straining removes those suspended particles that are too large to pass through the pores of the filter bed. It takes place almost exclusively at the surface of the filter where the impurities are retained in the top layer. This will improve the straining efficiency but it also increases the resistance against the downward water flow. Periodically the accumulated impurities have to be removed by scraping off the top layer. In this way the operating head of the filter bed is brought back to the original value.

* The 'filter skin' or layer of deposited material that forms on top of a slow sand filter.

Sedimentation removes fine suspended solids as they are deposited onto the surface of the filter bed sand grains. For fine sand as normally used in slow sand filters the combined surface area of the grains is very great, some 10,000 to 20,000 square metres per cubic metre of filter sand. In combination with the low rate of filtration, this gives a very low 'surface loading' (as described in section 14.2). The settling efficiency will, therefore, be so high that even very small particles can be completely removed. Again, this action takes mainly place in the upper part of the filter bed and only organic matter of low mass density is carried deeper into the bed. The remaining suspended solids, together with colloidal and dissolved impurities, are removed by adsorption either onto the sticky gelatinous coating formed around the filter bed grains or through physical mass attraction and electrostatic attraction.

The electrostatic attraction is the most effective, but it occurs only between particles having opposite electrical charges. Clean quartz sand has a negative charge and is, therefore, unable to adsorb negative-charged particles such as bacteria, colloidal matter of organic origin, anions of nitrate, phosphate, and similar chemical compounds. Thus, during the ripening period of a slow sand filter, only positive-charged particles are adsorbed, such as floc of carbonates, iron- and aluminium hydroxide, and cations of iron and manganese. However, the adsorption of positive charged particles will continue to a stage that over-saturation occurs. The overall charge of the filter bed grain coatings then reverses and becomes positive, after which negative-charged particles will be attracted and retained. After the initial ripening period the filter bed will exhibit a varied and continuously varying series of negative and positive charged grain coatings that are able to adsorb most impurities from the passing water.

The matter accumulated on the filter sand grains does not remain there unchanged; it is transformed by bio-chemical and bacterial activity. Soluble ferrous and manganous compounds are turned into insoluble ferric and manganic oxide hydrates that become part of the coating around the sand grains. Organic matter is partly oxidised thus providing the energy needed by the bacteria for their metabolism. Another part of the organic matter is transformed into cell material which is used for bacterial growth. Usually, the amount of organic matter in the raw water is small and provides food for only a limited bacterial popu-

lation. Thus, simultaneous with the bacterial growth mentioned above, there will be a die-off of bacteria. Organic matter is so released. It is carried away with the water flow and again consumed by other bacteria deeper in the filter bed. In this way the degradable organic matter originally present in the raw water is gradually broken down and transformed into inorganic compounds such as carbon dioxide, nitrates, sulfates, and phosphates. Finally these are discharged with the filter effluent.

It should be stressed that the microbial actions mentioned above need time to establish themselves. Hence, a ripening period of sufficient time is required. During this period bacteria from the raw water are adsorbed onto the filter bed grains. There, they multiply using the organic matter present in the water as food. The break-down of organic matter takes place in many steps in each of which a particular type of bacteria is active.

For the filtration process to be effective, it is necessary that the bacteria develop and migrate to the deeper layers of the filter bed. This takes time, and variations in the filtration rate should be introduced slowly over a period of hours. In practice it has been found that the full bacterial activity extends over a depth of about 0.6 m of filter bed so that the effective bed thickness should be not less than 0.7 m. The initial bed thickness should be 0.3-0.5 m more, to allow for a number of filter scrapings before resanding is necessary.

The most important purification effect of a slow sand filter is the removal of bacteria and viruses. Through adsorption and other processes, bacteria are removed from the water and retained at the surface of the filter bed grains. For intestinal bacteria, the filter bed provides unfavourable conditions because the water is generally colder than their natural habitat, and usually contains not sufficient organic matter (of animal origin) for their living requirements.

Moreover, in the upper part of the filter bed several types of predatory organisms abound feeding on bacteria. Deeper in the filter bed bio-chemical oxidation will have reduced the organic matter in the water already so much that the bacteria are starved. The various micro-organisms in a slow sand filter produce chemical compounds (antibiotics) and microbial agents that kill or at least inactivate in-

testinal bacteria. The overall effect is a considerable reduction of the number of E.coli and, since pathogens are less likely to survive than E.coli, an even greater reduction of their numbers is obtained. Treating a raw water of average bacteriological quality with slow sand filters, it is usual to find E.coli absent in 100 ml samples of filtered water.

Slow sand filters are usually built in the open. Photosynthetic algal growth may occur. This has some disadvantages as will be explained in section 15.5 but it also promotes the filter efficiency and helps achieve a greater removal of organic matter and bacteria. This is brought about by the thin slimy matting on top of the filter bed, consisting of threadlike algae and numerous other forms of aquatic life such as plankton, diatoms, protozoa, and rotifers. The filter matting is intensely active with the various organisms entrapping, digesting and breaking down organic matter from water passing through. Dead algae from the supernatant water and living bacteria from the raw water are similarly consumed in the filter matting; inert suspended matter is strained out.

15.3 Principles of operation

Basically a slow sand filter consists of a tank, open at the top and containing the bed of sand. The depth of the tank is about 3 m and the area can vary from a few tens to several hundreds of square metres. At the bottom of the tank an underdrain system (the 'filter bottom') is placed to support the filter bed. The bed is composed of fine sand, usually ungraded, free from clay and loam, and with as little as possible organic matter in it. The filter bed normally is 1.0-1.2 m thick, and the water to be treated (the 'supernatant water') stands to a depth of 1.0-1.5 m above the filter bed.

The slow sand filter is provided with a number of influent and effluent lines fitted with valves and control devices. These have the function of keeping both the raw water level and the filtration rate constant.

For clarity of illustration all influent and effluent lines are shown separately in Fig. 15.3 but in practice they are combined and placed together to save on construction costs.

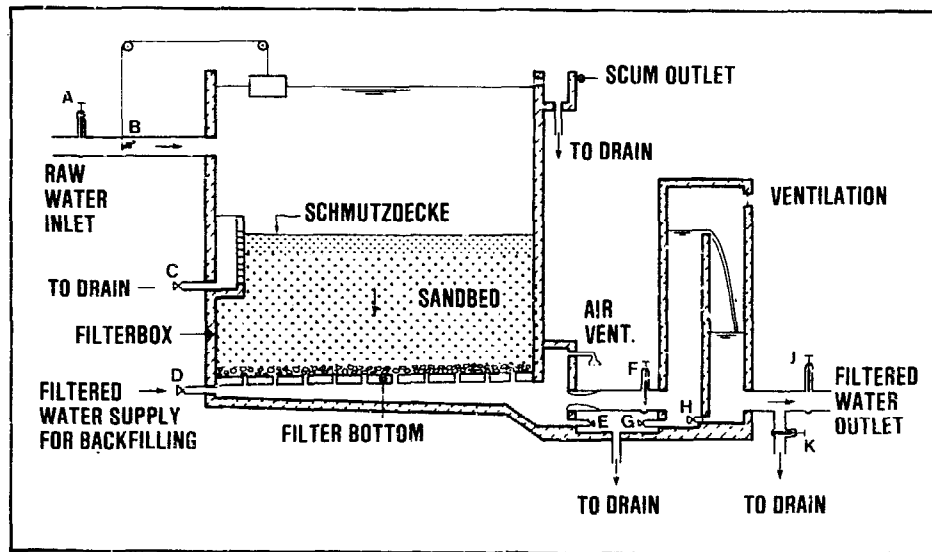

Figure 15.3.
Slow sand filter

During operation, the raw water enters the filter tank through valve A and passes the float-controlled regulating valve B; the supernatant water infiltrates into the filter bed and percolates down toward the underdrain system; the filtered water then passes a flow meter and the regulating valve F, and flows into the outlet weir chamber; from there the water passes through valve J and flows into the clear water well. Valve B keeps the raw water at a constant level. To obtain a constant rate of filtration, the regulating valve has to be opened a little bit each day in order to compensate for the increase in resistance of the filter bed due to clogging. When the demand for filtered water changes, valve F is adjusted slowly, over a period of several hours, with the water production rate checked by reading the flow meter. The outlet weir prevents under-pressures from occurring in the filter bed and makes the operation of the filter independent from water level variations in the clear water well. The weir also provides aeration of the water for which the weir chamber should be ventilated. Ventilation is further required for the filter itself to provide for the release of gases that are liberated or produced during filtration. To facilitate the release of these gases, the underside of the filter bottom should slope 1:500 upward in the direction of flow. For drainage purposes (e.g. when repairs are carried out) the filter-tank floor should slope 1:200 downward. If considerable amounts of scum (e.g. floating algae) accumulate at the water surface

during filtration, scum outlets at the four corners of the filter are handy for regular scum removal.

When after a period of operation the regulating valve F is fully open, a further increase in filter resistance would result in a reduction of the filtration rate. The production of filtered water would fall below the required rate, and the filter must be taken out of service for cleaning. Cleaning is carried out by scraping off the top 1.5 to 2 cm of dirty sand. For this the filter must first be drained to a water level about 0.2 m below the top of the sand bed. To start the cleaning operation, valve A is closed, usually at the end of a day, while the filter continues to discharge water in the normal way through valves F and J. The next morning, valves F and J are closed and the remaining supernatant water is drained off through valve C. This draining of the filter is controlled by a box of which one wall consists of stop logs forming a weir. The top of this weir is kept more or less level with the top of the filter bed. The pore water in the upper 0.2 m of the sand bed is drained off by opening valve E for a short period of time. When the cleaning operation (see section 15.6) has been completed, valve C is closed and the filter is slowly refilled with filtered water from underneath, through valve D, to a level of about 0.1 m above the top of the sand bed. During this operation one should take care that all the air that has accumulated in the pores of the bed is driven out.

After this, raw water is admitted from the inlet through valve A taking care not to damage the filter bed. An effective arrangement is to locate valve A above the discharge box connected to valve C. When the raw water level in the filter has reached its normal level as determined by the regulating valve B, valve K is fully opened and regulating valve F just enough for the clean filter to operate at about one quarter of its normal filtration rate.

During the next 12 hours the filtration rate is slowly raised to the normal level. After at least 12 more hours - but preferably 36 hours - valve K is closed and valve J opened; the filter is back in normal operation. When the filter has been out of operation for a considerable period of time, e.g. for re-sanding or repair, the ripening period of 1 to 2 days mentioned earlier must be extended with several more days. When the filter is new, the breaking-in period may even take several weeks. In the event of the filter remaining out of operation for a long

period, it should be drained completely using valves E, G and H.

The operating method for a slow sand filter as described above, is fail-safe and gives reliable results but the installation is rather complex. Many simplifications are possible. When the raw water level on top of the filter is kept constant by manipulating the raw water supply rate it is possible to do without the float-operated regulating valve B. Valves D and E may be combined, and the function of valve H can be fulfilled by valve K. Scum outlets are not necessary particularly for small filters, if scum removal can be carried out manually. Fig. 15.4 shows an example of such a simplified design which has a minimal number of control valves and only a few influent and effluent lines.

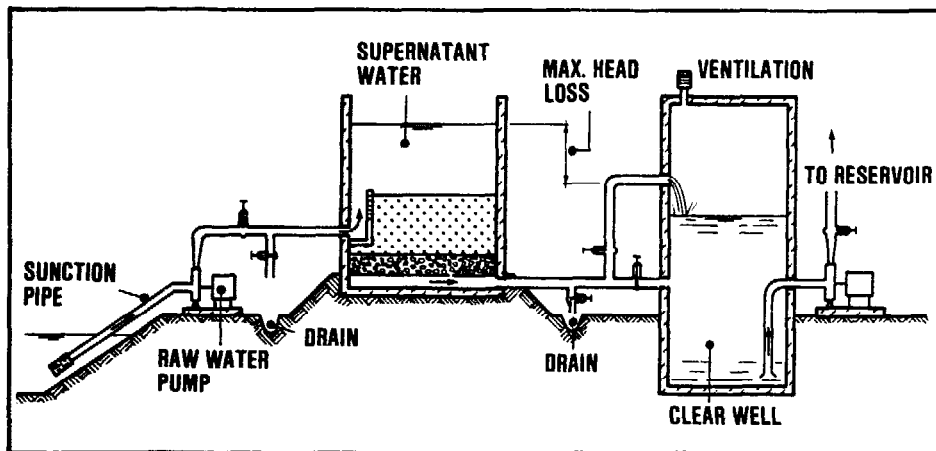

Figure 15.4.
Simplified slow sand filter

15.4 Design considerations

For the actual design of a slow sand filter four dimensions have to be chosen in advance: the depth of the filter bed, the grain size distribution of the filter material, the rate of filtration, and the depth of supernatant water. As far as possible, these design factors should be based on experience obtained with existing treatment plants which use the same water source or water of a comparable nature. When such experience is not available, the design should be based on results obtained with pilot tests carried out with experimental filters (see Annex 3).

When no actual or experimental data are available, the following procedure may be used:

- a. For the initial design, the bed thickness is chosen at 1.0-1.2 m. This is sufficient to allow for the necessary filter bed scrapings before the minimum thickness of 0.7 m is reached.
- b. Analyse the grain size distribution of locally available sand and determine the effective size and coefficient of uniformity (see Fig. 15.5). Select sand with an effective size of about 0.2 mm and a coefficient of uniformity less than 3. When such sand is not available a coefficient of uniformity up to 5 may be accepted, and an effective size of the sand ranging from 0.15 to 0.35 mm. Builder's grade sand often satisfies these requirements. Sometimes burnt rice husks of 0.3 to 1.0 mm size are used.
- c. For the initial design fix the depth of supernatant water at between 1 and 1.5 m.
- d. Provide at least 2 and preferably 3 filter units. The combined surface area should be so large that with one filter out of operation for cleaning, the filtration rate in the operating units will not exceed 0.2 m/hour.
- e. Provide space for additional filter units.
- f. As soon as operations start, carefully note the length of the filter runs. An average filter run of about 2 months is most appropriate. When filter runs prove to be much longer, filtration rates can be raised allowing a greater plant output. If filter runs are shorter than expected, additional units will have to be constructed at an earlier date than was anticipated.

In slow sand filters under-pressure (that is water pressure below atmospheric) must be avoided under all circumstances as this might give serious problems. Air bubbles would form and accumulate in the filter bed increasing the resistance against the filtration flow. Air bubbles of large size may even break up the filter bed and create fissures through which the water would pass without adequate purification. The maximum allowable head loss over the filter bed is thus limited to the depth of the supernatant water plus the resistance of the clean filter bed at the minimum filtration rate. In order to make the occurrence of under-pressure completely impossible, an overflow weir may be provided in the effluent line. The difference in level between the supernatant water and the overflow weir should not exceed the maximum allowable head loss plus the head losses in the effluent piping, again for the minimum rate of filtration.

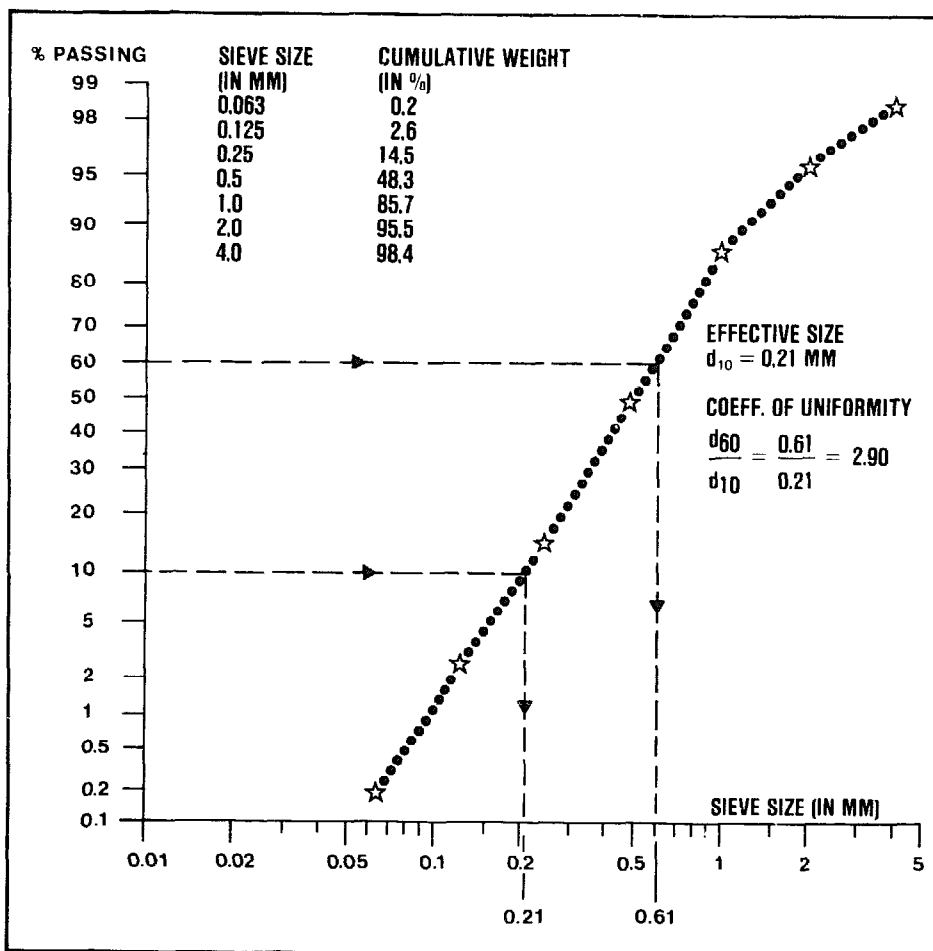

Figure 15.5.
 Grain size distribution of filter sand

For the low filtration rates used in slow sand filters, a small variation of the level of the supernatant water may have an appreciable influence on the filtration rate and so affect the effluent quality. To avoid this, filtration rate control fitted in the effluent line should be provided.

15.5 Construction

As regards the construction of a slow sand filter, various elements may be distinguished the most important being the filter tank, the filter bottom, the filter bed, the supernatant water and the influent and effluent lines. Attention should also be given to

the layout of the slow sand filtration plant as a whole.

In continental Europe slow sand filters are built of reinforced or pre-stressed concrete with a rectangular form and vertical walls 3 to 4 m high. Where possible they are situated above the highest ground-water table to make sure that there is no seepage of polluted water through cracks. In Great Britain mass concrete is still very popular. Gravity walls are used and a separate floor is constructed on site, with sections placed in a checker-board pattern (Fig. 15.6).

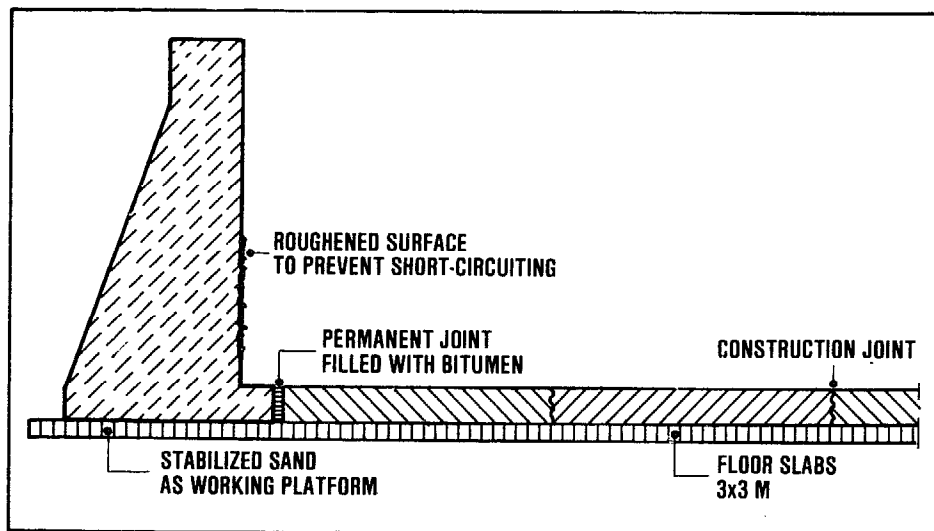

Figure 15.6.
Slow sand filter constructed in mass concrete

In the past slow sand filters have been built of masonry on a foundation of puddled clay (Fig. 15.7). Such a construction may be quite appropriate in rural areas of developing countries.

A very simple slow sand filter constructed in-ground is shown in fig 15.8.

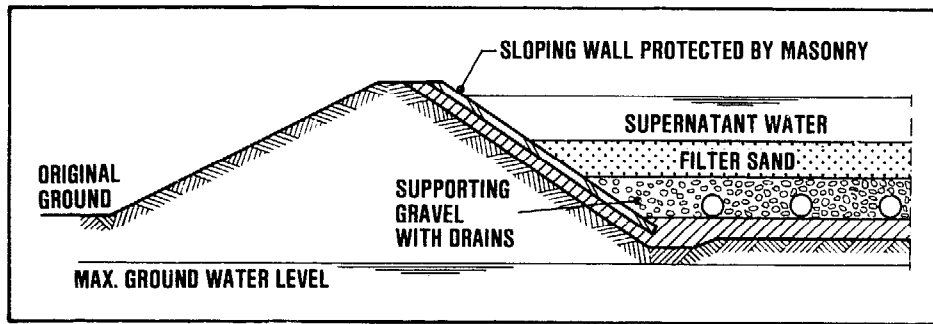

Figure 15.7.
Slow sand filter constructed of masonry on puddled clay

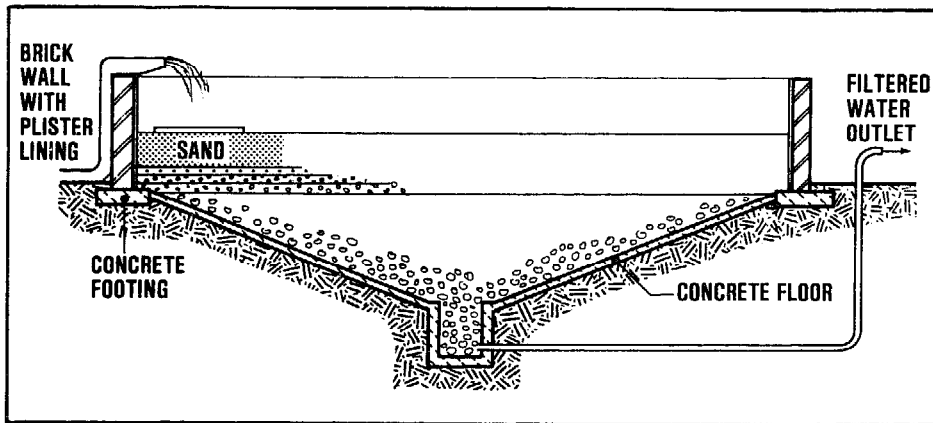

Figure 15.8.
Simple slow sand filter

Depending on the treatment plant capacity the required area varies from a few tens to several hundreds of square metres. There is a tendency to reduce the maximum sizes with a view of obtaining a greater flexibility of operation as well as quicker filter cleaning. With a maximum filtration rate of 0.2 m/hour a plant with a capacity of 2 million m³/year and a ratio between maximum and average daily production rate of 1.2 would require a filter bed area of 1,370 m². With one unit as a reserve (i.e. cleaning) this calls for 4 units each of 460 m² of surface area, or 6 units of 270 m² each. In order to ensure good effluent quality, short circuiting along the walls of the filter box must be prevented. When reinforced concrete is used, the inner wall should be made rough over half the filter bed depth. Con-

structuring this wall slightly tilted backwards also greatly helps in having the filter bed tightly fitted to the filter tank wall. Careful attention should be given to the occurrence of high groundwater levels which might lift the structure up and so damage the filter structures.

The filter bottom serves the two-fold purpose of supporting the filter bed and draining the filtered water off. The openings or pores of the filter bottom should be so fine that no filter material can pass through them. The resistance of the filter bottom to the passage of filtered water (head loss) should be small. As shown in Fig. 15.9 various types of filter bottom exist including stacked bricks and no-fines concrete poured on site on recoverable steel forms.

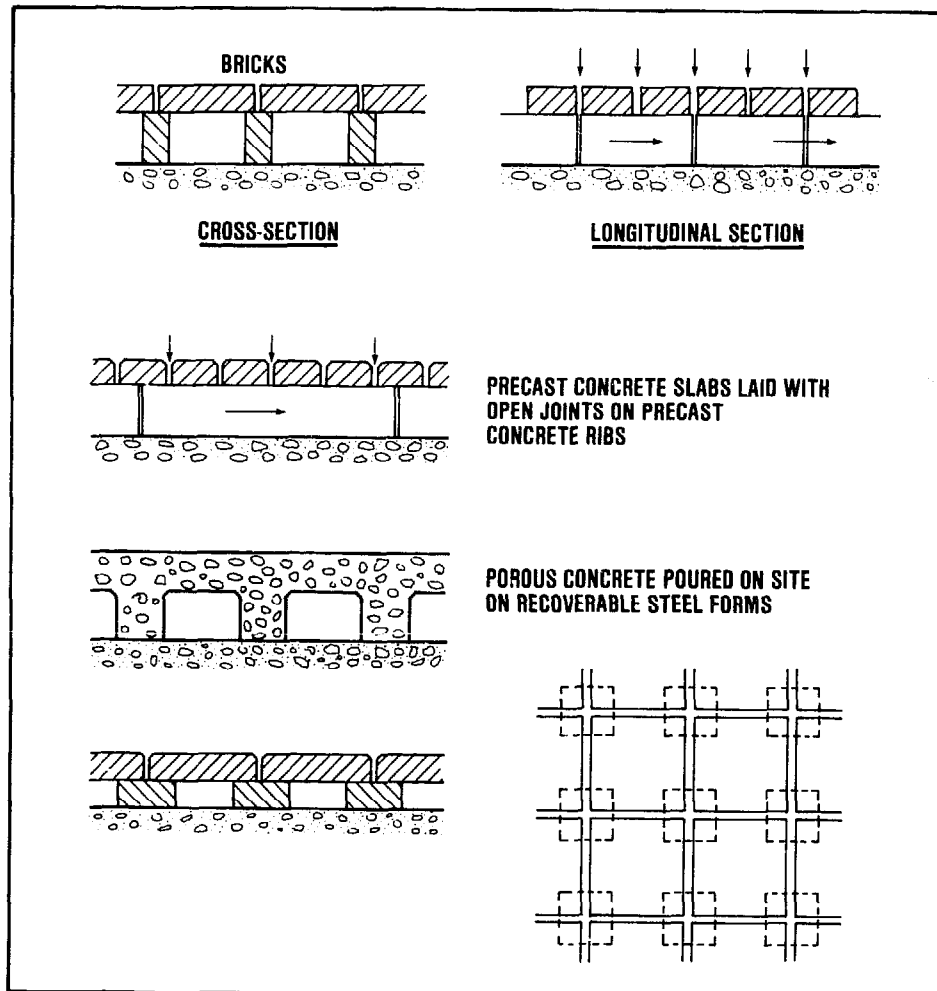

Figure 15.9.
Types of filter bottoms

To prevent the filter material from entering and blocking the underdrainage system a series of graded gravel layers can be used. The under layer of coarse size should be large enough to keep the openings in the filter bottom free, and the upper layer so fine that the overlying filter sand will not sink into its pores. For porous filter bottoms, one layer of 0.1-0.2 m thickness would be sufficient; for stacked bricks with open joints (10 mm wide) four layers will be required, for instance of 0.4-0.6 mm, 1.5-2 mm, 5-8 mm and 15-25 mm size each layer about 10 cm thick.

For small filters, perforated lateral pipes may be more attractive. They are connected to a central drain leading the water out of the filter. The perforated laterals can be made of many materials such as vitrified clay (full-round or half-round farm drain tiles) or cast iron, but in waterworks practice asbestos cement and polyvinylchloride are mostly applied. Locally-made porous pipes can also be used with advantage (Fig. 15.10). Lateral pipes with an inside diameter of about 80 mm are set at intervals of about 1 m and are provided with holes of 5 mm diameter on the underside; about 10 per metre of length. The central drain is usually not perforated and should have a cross-section of about twice the combined cross-sectional area of the laterals connected to it.

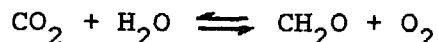

Figure 15.10.
Porous underdrain pipes

Sand for slow filters has already been discussed in section 15.4. When sand of the required effective size is not naturally available, it may sometimes be produced by thoroughly mixing two types of natural sand. However, this will result in a less uniformly graded sand bed. Sieving the sand to remove the coarsest grains may then be needed to obtain sand of the required uniformity.

The depth of supernatant water is related to the maximum allowable head loss which in its turn influences the length of filter run. A free board of 0.2 m above the maximum raw water level should be provided, and the top of the walls should be at least 0.8 m above ground level to minimize pollution by dust, leaves, small animals, etc.

Covering a slow sand filter is a necessity in cold climates to prevent the freezing of the water in winter time. In tropical climates it is sometimes practiced to prevent algal growth. In open filters the photosynthetic reaction



proceeds from left to right during daylight hours; oxygen (O_2) is produced. During the night, the reaction process is in the reverse direction and oxygen is consumed. As a result, there is a considerable variation in the oxygen content of the filtered water with very low values in the morning and perhaps even anaerobic water pockets in the filter bed. Dead algae may block the filter bed and cause a shortening of filter runs. A massive die-off of algae (e.g. in autumn) may impart a bad smell and taste to the filtered water. In tropical climates the period of daylight is generally relatively short, about 12 hours, and the water temperature is fairly constant. The growth and die-off of algae will then take place more or less at the same rate. The disadvantages mentioned above are thus less pronounced and the advantageous increase of self-purification processes can be fully utilized (see section 15.2).

Nowadays the various units of a slow sand filter plant are usually arranged in regular rows on both sides of a strip of land where all influent and effluent lines are laid. Between each row of units strips are kept open to facilitate access for filter cleaning. The filters frequently are provided with a small annex containing the valves, meters and other equipment necessary for the daily operation and control (Fig. 15.11).

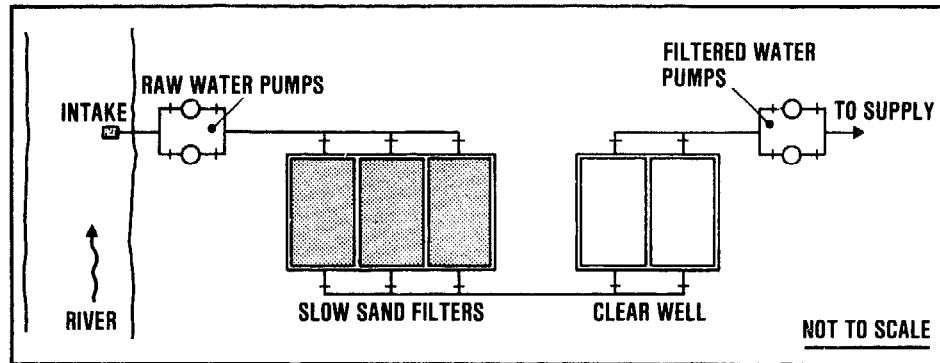

Figure 15.11.
General arrangement for slow sand filtration plant

15.6 Cleaning

The time-proven method of cleaning a slow sand filter is by scraping off the sand surface with hand shovels to remove the top layer of dirty sand over a depth of 1.5-2 cm. The scraped-off mixture of sand and impurities is piled in ridges or in heaps from where it is carried or carted to the edge of the filter using barrows or hand-carts wheeled over wooden planks (Fig 15.12). It may also be taken out of the filter with the help of baskets hoisted up with rope and tackle.

The dirty sand is sometimes discarded (can be used for landfills) but in other cases it is cleaned by washing (Figs. 15.13 and 15.14), if this is cheaper than buying new sand. To prevent putrefaction the sand should be washed immediately after it has been taken out of the filter. Care should be taken not to lose too much of the finer fractions of the sand during the washing.



*Figure 15.12.
Manual cleaning of a slow sand filter*

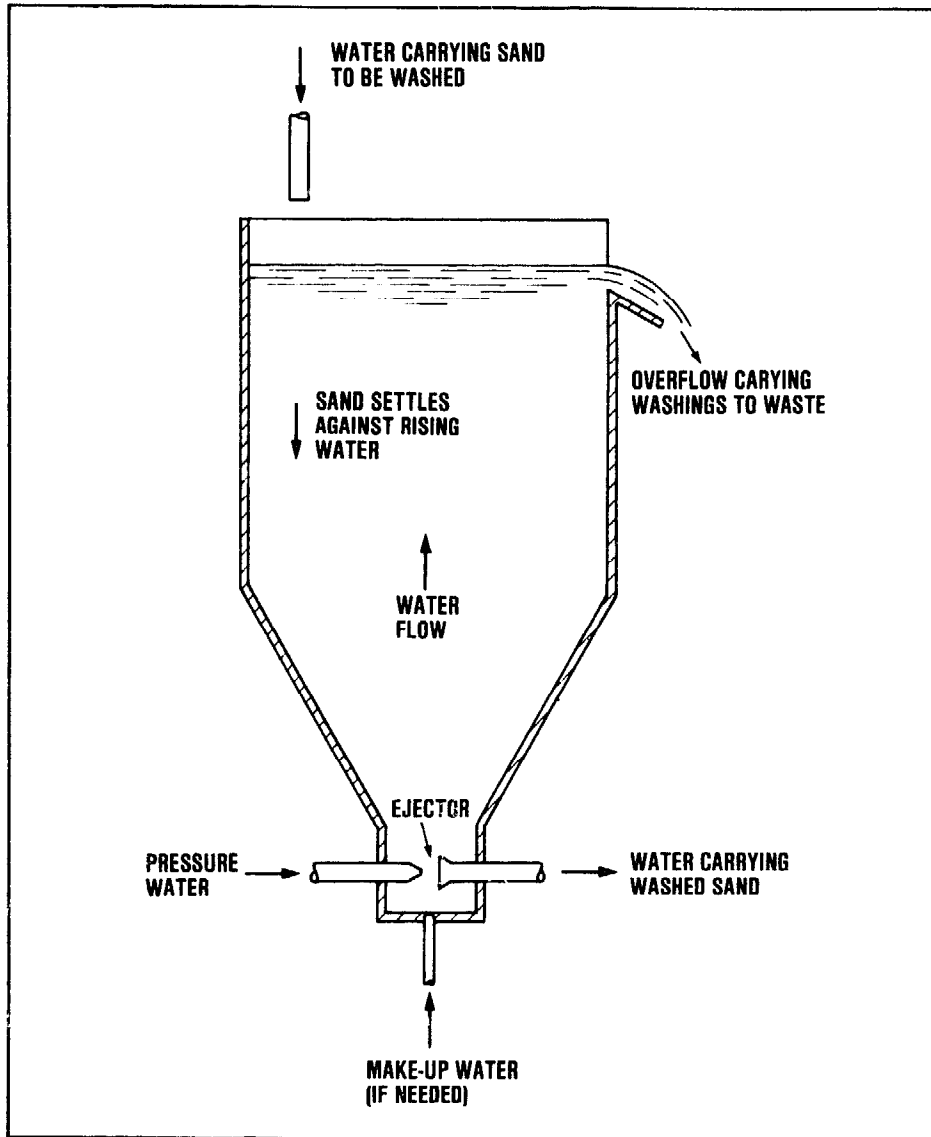

Figure 15.13.
Sand washer

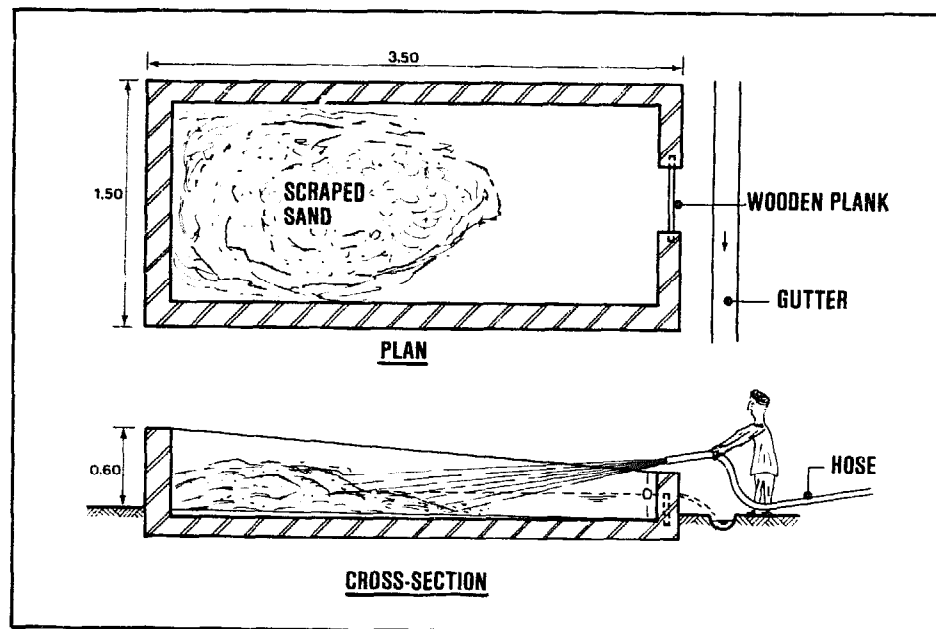

Figure 15.14.
Sand washing platform

The penetration of the impurities in the filter bed is largely confined to the upper layers. Scraping away the top layer removes the major part of the cloggings but some will remain in the deeper layers of the filter bed. These deposits accumulate little by little and also penetrate gradually deeper into the filter bed. This could cause problems if the sand remains in place for a very long time. When after many scrapings the minimum filter bed thickness is reached, it is therefore necessary to remove an additional 0.3 m of the filter sand before the new sand is brought in. The removed sand layer contains all the organisms necessary for the proper biochemical functioning of the slow sand filter and should be placed on top of the new sand in order to promote the ripening process (Fig. 15.15).

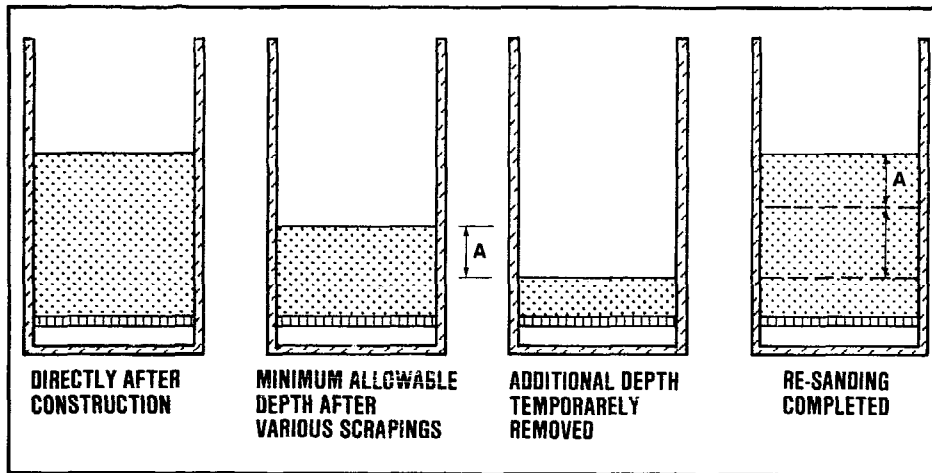

Figure 15.15.
Re-sanding of a slow sand filter

The manual cleaning work described above does not require special equipment or skills but for large filters a considerable number of workers are needed. Various mechanical systems of filter cleaning have been developed. Unfortunately, these are too complex and costly for use in small treatment plants in developing countries.

Slow sand filtration

Dijk, J.V. van; Oomen, J.H.C.M.
SLOW SAND FILTRATION FOR COMMUNITY WATER SUPPLY IN DEVELOPING
COUNTRIES - A DESIGN AND CONSTRUCTION MANUAL
International Reference Centre for Community Water Supply,
The Hague, 1978, (Technical Paper No. 11)

Frankel, R.J.
EVALUATION OF LOW-COST WATER FILTERS IN RURAL COMMUNITIES OF
THE LOWER MEKONG BASIN
Asian Institute of Technology, Bangkok, 1974

Huisman, L.; Woods, W.E.
SLOW SAND FILTRATION
World Health Organisation, Geneva 1974, 122 p.

Institution of Water Engineers
MANUAL OF BRITISH WATER SUPPLY PRACTICE
Heffer & Sons Ltd., Cambridge, 1950

Thanh, N.C.; Pescod, M.B.
APPLICATION OF SLOW SAND FILTRATION FOR SURFACE WATER TREAT-
MENT IN TROPICAL DEVELOPING COUNTRIES
Asian Institute of Technology, Bangkok, 1976
(Environmental Engineering Division Research Report No. 65)

Wright, F.B.
RURAL WATER SUPPLY AND SANITATION
John Wiley & Sons, Chapman & Hall, New York, 1956

16. rapid filtration

16.1 Introduction

As explained in the preceding chapter on slow sand filters, filtration is the process whereby water is purified by passing it through a porous material (or "medium"). For rapid filtration, sand is commonly used as the filter medium* but the process is quite different from slow sand filtration. This is so because much coarser sand is used with an effective grain size in the range 0.4-1.2 mm, and the filtration rate is much higher, generally between 5 and 15 m³/m²/hour (120-360 m³/m²/day). Due to the coarse sand used, the pores of the filter bed will be relatively large and the impurities contained in the raw water will penetrate deep into the filter bed. Thus the capacity of the filter bed to store deposited impurities is much more effectively utilized and even very turbid river water can be treated with rapid filtration. For cleaning a rapid filter bed, it is not sufficient to scrape off the top layer. Cleaning of rapid filters is effected by back washing. This is directing a high-rate flow of water back through the filter bed whereby it expands and is scoured. The back-wash water carries the deposited cloggings out of the filter. The cleaning of a rapid filter can be carried out quickly; it need not take more than about one half hour. It can be done as frequently as required, if necessary each day.

Applications of Rapid Filtration

There are several different applications of rapid filtration in the treatment of water for drinking water supplies.

In the treatment of groundwater, rapid filtration is used for the removal of iron and manganese. To assist the filtration process, aeration is frequently provided as a pretreatment to form insoluble compounds of iron and manganese (Fig. 16.2).

* Anthracite, crushed coconut shell, pumice, and other materials are also used especially in multiple-layer filter beds where one or more layers of such materials are placed on top of a (shallow) sand bed.

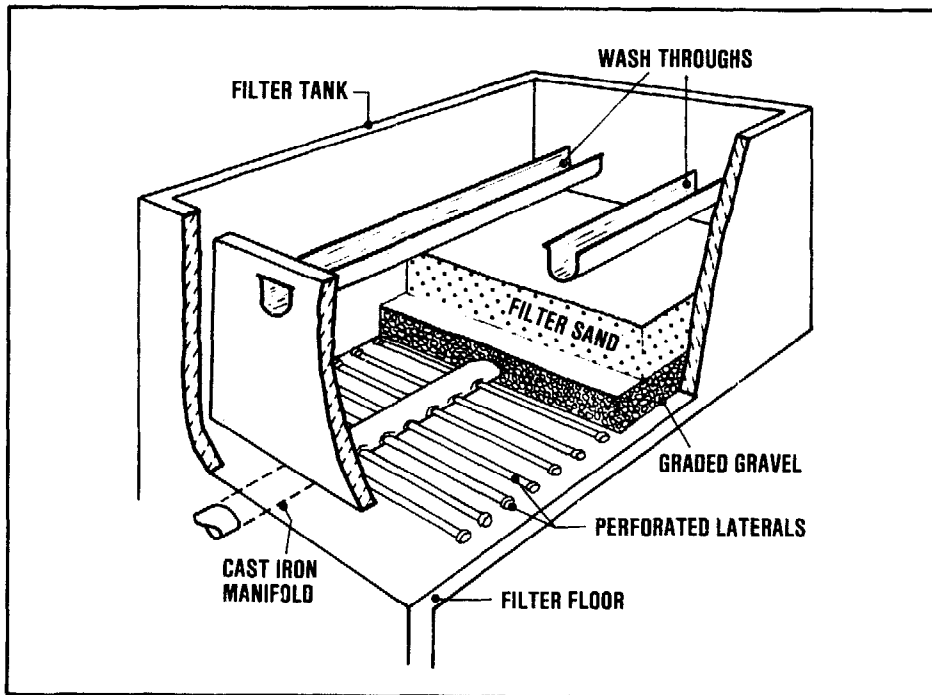

Figure 16.1.
Rapid filter (open, gravity-type)

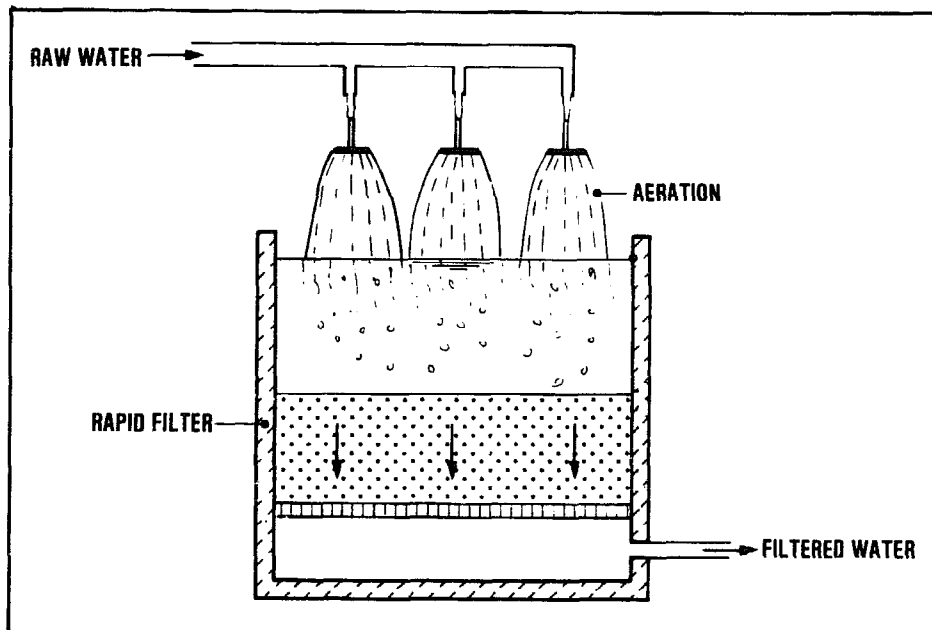

Figure 16.2.
Rapid filtration of pre-treated (aerated) water

For water with a low turbidity as frequently found in lakes and sometimes in rivers, rapid filtration should be able to produce a clear water which, however may still contain pathogenic bacteria and viruses. A final treatment such as chlorination is then necessary to obtain a bacteriologically safe water.

In the treatment of river water with high turbidity, rapid filtration may be used as a pre-treatment to reduce the load on the following slow sand filters (Fig. 16.3), or it may be applied for treating water that has been clarified by coagulation, flocculation and sedimentation (Fig. 16.4). In such cases again a final chlorination is required.

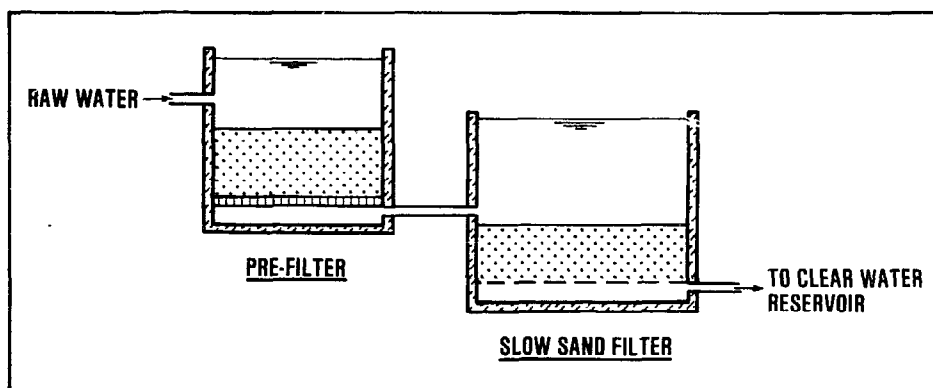

Figure 16.3.
Rapid filtration-followed by slow sand filtration

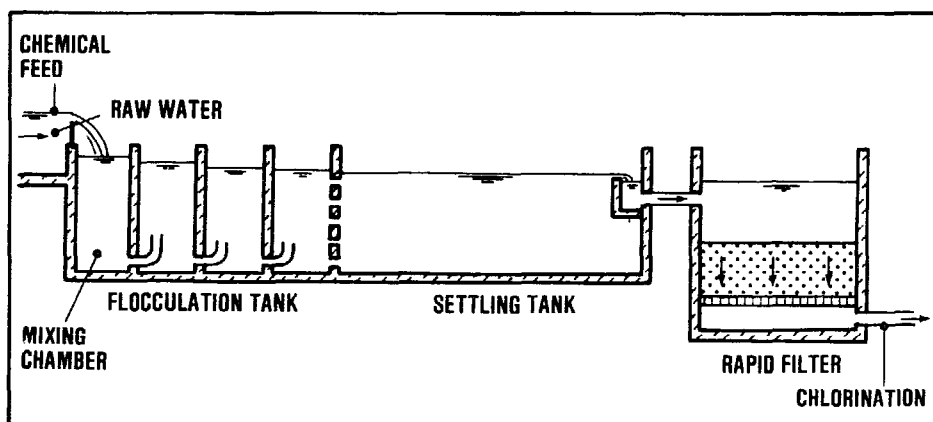

Figure 16.4.
Rapid filtration after coagulation and flocculation, and sedimentation

Types of Rapid Filters

Rapid filters are mostly built open with the water passing down the filter bed by gravity (Fig. 16.1).

For certain operating conditions, other rapid filters than the open gravity-type are better suited. The most important are: pressure filters, upflow filters and multiple-media filters.

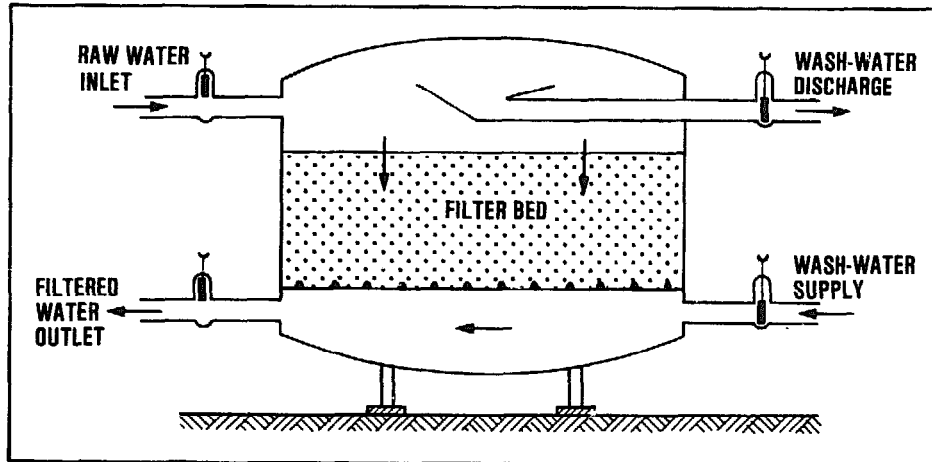

Figure 16.5.
Pressure filter

Pressure filters (Fig. 16.5) are of the same construction as gravity-type filters but the filter bed together with the filter bottom is enclosed in a water-tight steel pressure vessel. The driving force for the filtration process is here the water pressure applied on the filter bed which can be so high that almost any desired length of filter run is obtainable. Pressure filters are commercially available as complete units. They are not so easy to install, operate and maintain. For this reason they are not very well suited for application in small treatment plants in developing countries.

Upflow filters (Fig. 16.6) provide for a coarse-to-fine filtration process. The coarse bottom layer of the filter bed filters out the major part of the suspended impurities, even from a turbid raw water, with no great increase of the filter bed resistance, due to the large pores. The overlaying fine layers have smaller pores but here also the filter resistance will increase only slowly as not much impurities are left to be filtered out.

In upflow filters, sand is used as the single filter medium. They are frequently used for the pre-treatment of water that is further purified by gravity-type rapid filters or by slow sand filters. In such cases, upflow filters can give excellent results and may be well suited for use in small treatment plants.

One drawback is that the allowable resistance over an upflow filter is not more than the submerged weight of the filter bed. With sand as the filter material, the available resistance head is about equal to the thickness of the bed. For very turbid river water the length of the filter run and the allowable rate of filtration are thus very limited.

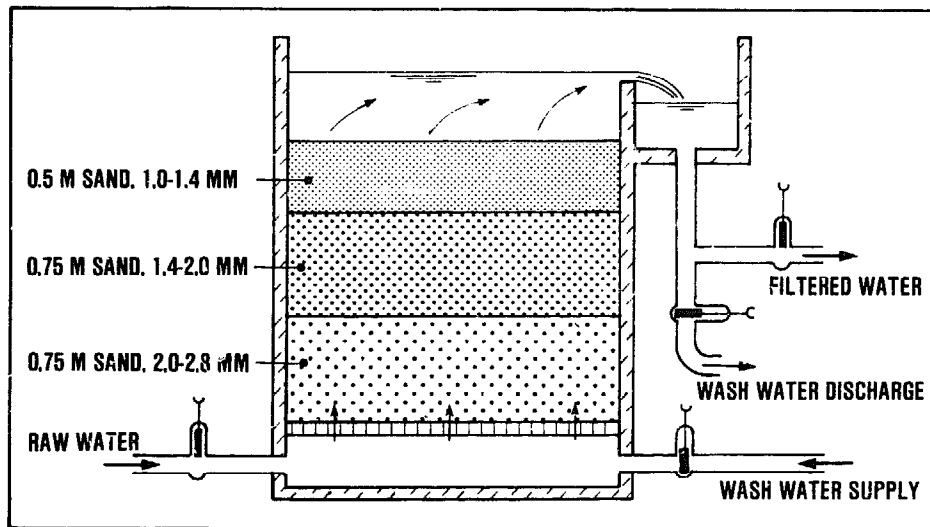

Figure 16.6.
Upflow filter

Multiple-media filters (Fig. 16.7) are gravity-type, downflow filters with the filter bed composed of several different materials which are placed coarse-to-fine in the direction of flow. For small-size rapid filters it is common to use only two materials in combination: 0.3-0.5 m of sand with an effective size of 0.4-0.7 mm as the under layer, topped by 0.5-0.7 m of anthracite, pumice or crushed coconut husks with an effective size of 1.0-1.6 mm. As a final treatment multiple-layer filters can give excellent results and, when suitable materials are available locally, application in small treatment plants is well worth considering.

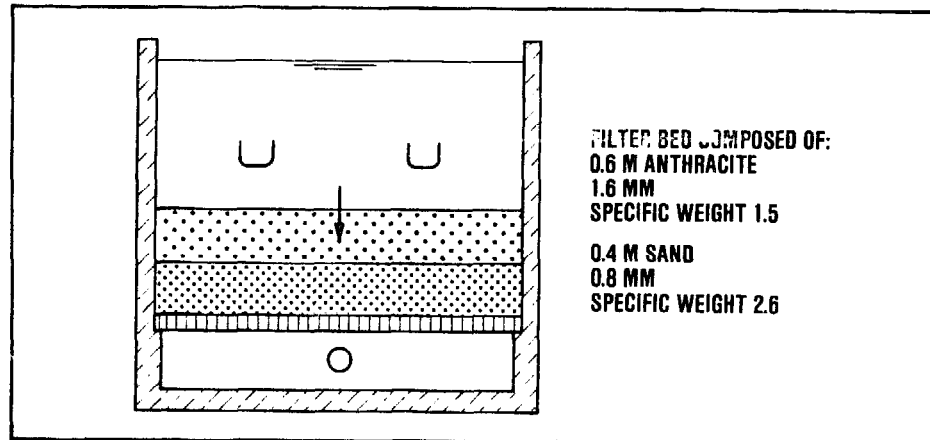

Figure 16.7.
Dual-media filter bed

16.2 Theoretical aspects

The overall removal of impurities from the water as effected in rapid filtration, is brought about by a combination of several different processes. The most important are: straining, sedimentation, adsorption, and bacterial and bio-chemical processes. These are the same processes already described for slow sand filtration (in section 15.2). In rapid filtration, however, the filter bed material is much coarser and the filtration rate much higher (up to 50 times higher than in slow sand filtration). These factors completely alter the relative importance of the various purification processes.

The straining of impurities in a rapid filter is not important due to the relatively large pores in the filter bed. Sedimentation will not be very effective due to the high filtration rates used. Thus, much less impurities will be retained by straining and sedimentation than in a slow sand filter. Especially the upper filter bed layers will be far less effective and there will be a deep penetration of impurities into the entire bed of a rapid filter.

By far the most important purification effect in rapid filtration is the adsorption of impurities having an electric charge, onto the filter bed grains with an opposite electric charge. In a rapid filter the natural static charges of the filter bed material are supplemented by the electro-kinetic charges pro-

duced by the high-rate flow of water. Charged particles ("ions") are dragged away from the filter bed grains with the result that the grains are left with an (opposite) charge. The electro-kinetic effect greatly reinforces the adsorption action.

In a slow sand filter the water stays several hours in the filter bed, but with rapid filtration the water passes in a few minutes only. From a rapid filter, the accumulated organic cloggings are frequently removed when the filter is cleaned by backwashing. There is very little time and opportunity for any bio-degradation of organic matter to develop, and for killing of pathogenic bacteria and viruses to take place. The limited degradation of organic matter need not be a serious drawback as the accumulated cloggings will be washed out of the filter during backwashing. The poor bacteriological and biochemical activity of a rapid filter will generally be insufficient to produce a bacteriologically safe water. Hence, further treatment such as slow sand filtration or chlorination will be necessary to produce water that is fit for drinking and domestic purposes.

16.3 Rapid filter operation and control

Filter Operation

The operation of a rapid filter (gravity type) is shown schematically in Fig. 16.8.

During filtration the water enters the filter through valve A, moves down towards the filter bed, flows through the filter bed, passes the underdrainage system (filter bottom) and flows out through valve B. Due to the gradual clogging of the pores the filter bed's resistance against the downward water flow will gradually increase. This would reduce the filtration rate unless it is compensated by a rising raw water level above the filter bed. Frequently, rapid filters are designed to operate with a constant raw water level which requires that the filter is equipped with a filter rate control device in the influent or effluent line. These filter rate controllers provide an adjustable resistance to the water flow. They open gradually and automatically to compensate for the filter bed's increasing resistance and so keep the operating conditions of the rapid filter constant.

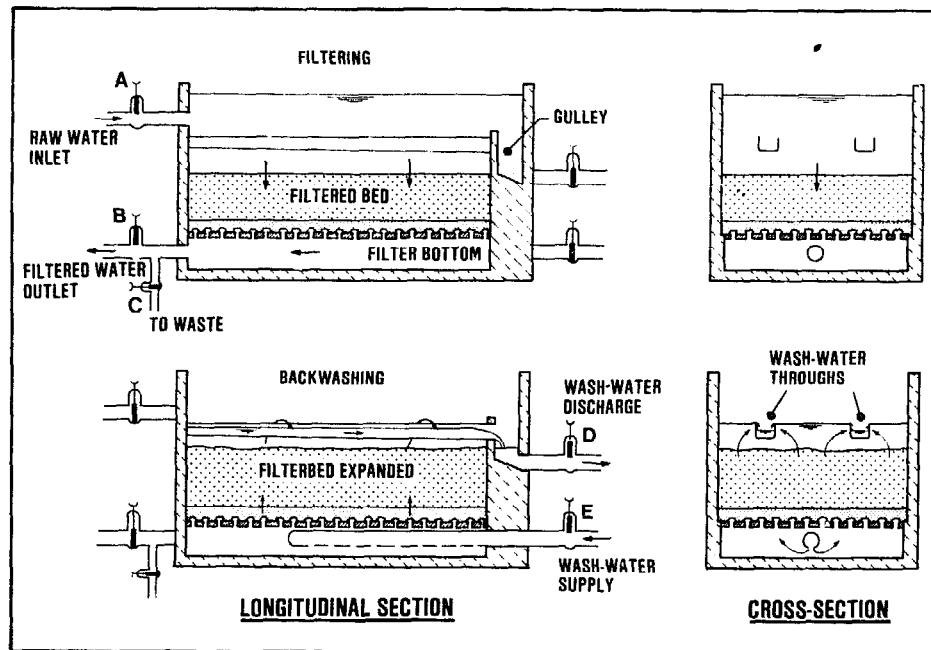

Figure 16.8.
Rapid filter (gravity-type)

When, after some time of operation, the filter rate controller is fully opened, a further clogging of the filter bed cannot be further compensated and the filtration rate would fall. The filter then is taken out of service for backwashing. For this, the valves A and B are closed, and valve D is opened to drain the remaining raw water out of the filter. A few minutes later valve E is opened for admitting the wash water. The back-wash rate should be high enough to expand the filter bed so that the filter grains can be scoured, and the accumulated cloggings carried away with the wash water. The wash water is collected in the washwater troughs from where it drains to waste. When the backwashing is completed, valves E and D are closed and valve A is re-opened admitting raw water to begin a new filter run.

For fine filter bed material the scouring action produced by the wash water during backwashing, may be in the long run not sufficient to keep the filter bed clean. It is then desirable to provide an additional scour using air and water in combination for backwashing. This, however, is much more complex than backwashing with water only, and air-and-water wash is generally not to be recommended for small water treatment plants.

Filter Control

There are several types of filtration-rate controllers: inlet rate control devices (equal distribution or "flow splitting"), and outlet rate control devices (level-operated valves, overflow weirs, and siphons). Basically, filter-rate control arrangements can be divided into three groups:

1. Each filter has an individual rate controller that keeps the filtered water production at the desired constant rate.
2. The total flow of water through the filter plant is controlled by the raw water intake rate, or alternatively by the rate at which the filtered water is withdrawn.
3. Same as under 2, but the filter units operate at individual, declining rates.

Individual rate controllers allow each filter unit to operate at its optimal filtration rate (Fig. 16.9). This advantage, however, is not very great and such rate controllers are generally very expensive and not easy to maintain.

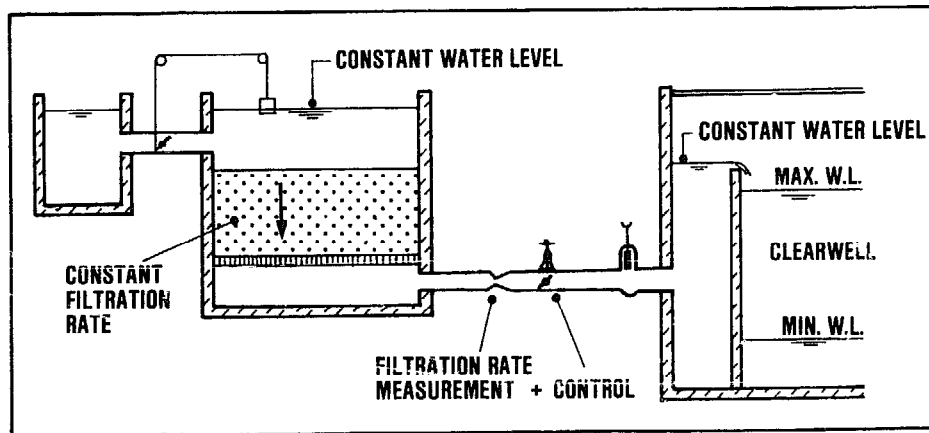

Figure 16.9.
Filter-rate control

Filter control arrangements using an even distribution of the raw water ("flow splitting") over the filter units or uniform withdrawal of the filtered water, are widely used in Europe and North America. Various methods can be employed. The one shown in Fig. 16.10b is probably the simplest as there are no moving parts at all. In this type the raw water enters the filter over a weir. For all

filters the weir crest is at the same level. The raw water conduit feeding the filter units is generously sized so that the water will flow without any appreciable head loss. The water level in it will be practically the same at each entrance weir. Thus, the overflow rate at each weir will be the same, and the raw water feed to the filter units will be equally split.

The filtration rate can be controlled jointly for all filter units by the raw water feeding rate. It can be readily adjusted to meet the demand for filtered water. In this arrangement there will be considerable variations of the raw water level in the filters which may be objectionable. If so, another arrangement as shown in Fig. 16.10c may be preferred. Here, a float-controlled valve is used to keep the raw water level in each filter constant.

Frequently, rapid filters are employed to treat water that has been pre-treated by coagulation, flocculation and sedimentation; they then serve to retain the flocs carried over from the settling tanks. Any break up of these flocs must be prevented and the entrance weirs mentioned above are not suitable in these cases. The arrangement shown in Fig. 16.10a would be much better. Each filter is equipped with a float box in which the water level is kept constant, at the same level in all filter units, with a float-controlled valve. The effluent channel should be generously sized to ensure that the water level will be practically the same at each filter effluent gate. The overall production rate of all filters jointly can now be controlled by the rate at which the filtered water is withdrawn.

Declining-Rate Filtration

When no filtration rate controllers are used, filtration will take place at a declining rate. The design of declining-rate filters is much simpler than for controlled-rate filters. Simple stop logs or gates can be used for filter control (Fig. 16.11).

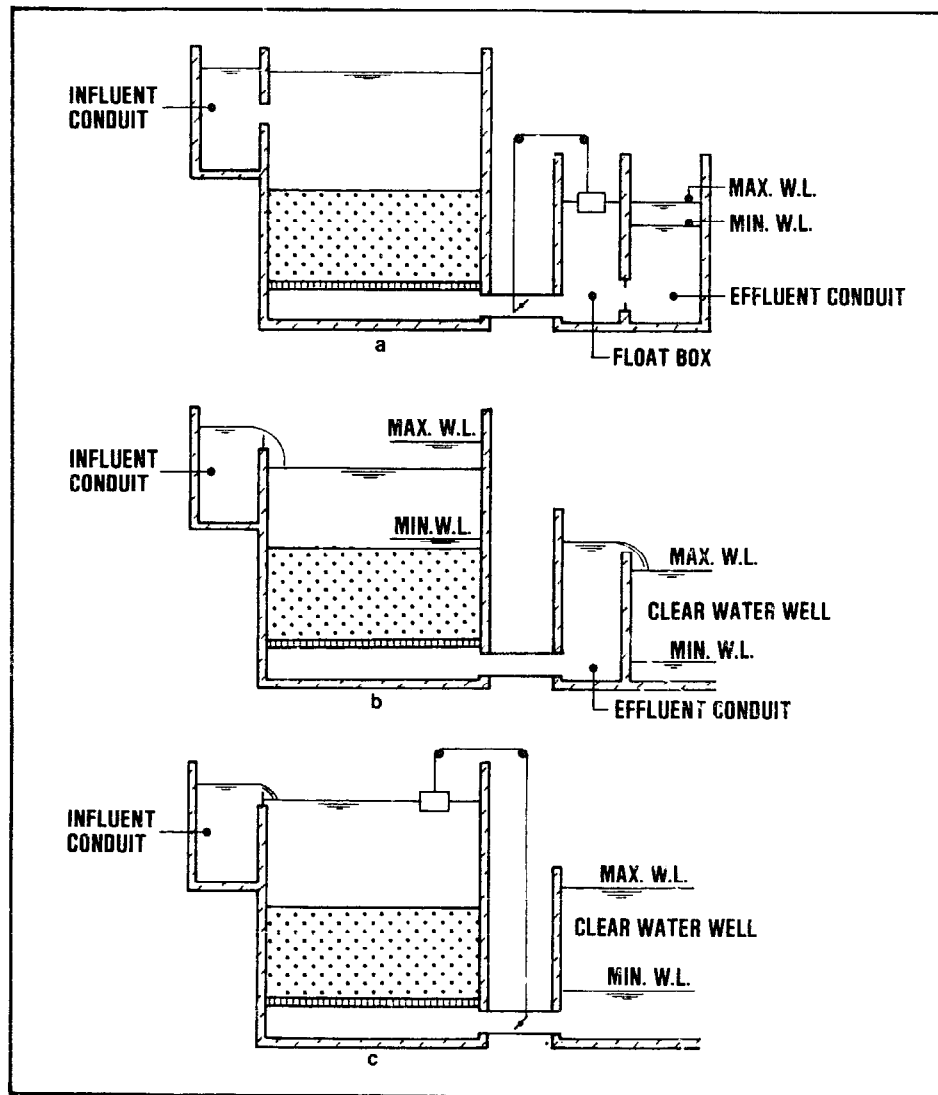

Figure 16.10.
Filter control systems

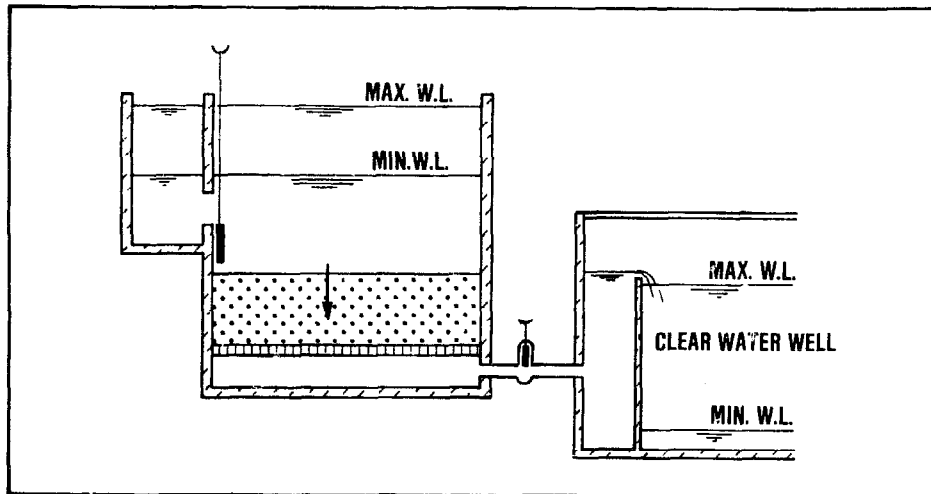

Figure 16.11.
Declining-rate filtration

All filters are in open connection with both the raw and filtered water conduits. Consequently, all have the same raw water level and filtered water level so that all filters will operate under the same head. The filtration rate for the various filter units, however, will be different: highest in the filter just cleaned by backwashing and lowest for the one longest underway in its current filter run. For all filters jointly, the production will be determined by the supply of raw water which should be high enough to meet the demand for filtered water. During filtration the filter beds are gradually clogged and the raw water level in all filters will rise due to the increased resistance against water flow in the filter beds. The filter unit that has been in operation for the longest period of time will probably reach the maximum allowable raw water level first, and needs cleaning by backwashing. After its cleaning this filter will have the lowest resistance against flow so that a considerable portion of the raw water supplied will pass this filter. The load on the other filters is temporarily reduced. These units will show a fall of the raw water level but later the further clogging of the filter beds will cause the raw water level again to rise. When in a second filter the maximum raw water level is reached this one will be backwashed and so forth.

If no special measures are taken, the filtration rate in a declining-rate filter just after cleaning can be very high, up to $25 \text{ m}^3/\text{m}^2/\text{hour}$, which is much higher than the average rate of $5\text{-}7 \text{ m}^3/\text{m}^2/\text{hour}$. When it is

necessary to limit the filtration rate in order to safeguard the filtered water quality, an extra flow resistance device (e.g. an orifice) should be fitted in the influent line.

For pressure filters, declining-rate filtration is common practice. For gravity-type rapid filters, its application is gradually increasing in Great Britain, in Latin America and also, to a limited extent, in North America. Due to its simplicity, declining-rate filtration is certainly worth considering for small water treatment plants in developing countries.

16.4 Design considerations

For the design of a rapid filter, four parameters need to be selected. The grain size of the filter material, the thickness of the filter bed, the depth of the supernatant water, and the rate of filtration. To the extent possible, these design factors should be based on experience obtained in existing plants that treat the same or a comparable raw water. When such experience does not exist, the design should be based on the results obtained with a pilot plant operating experimental filters (see Annex 3).

Backwash Arrangements

A rapid filter is cleaned by backwashing, that is directing a flow of clean water upward through the filter bed for a period of a few minutes. Filtered water accumulated by pumping in an elevated tank can be used, or the effluent from the other (operating) filter units of the filtration plant directly ('self-wash arrangements'). The velocity of the upward water flow should be high enough to produce an expansion of the filter bed so that the accumulated cloggings can be loosened and carried away with the washwater (Fig. 16.12).

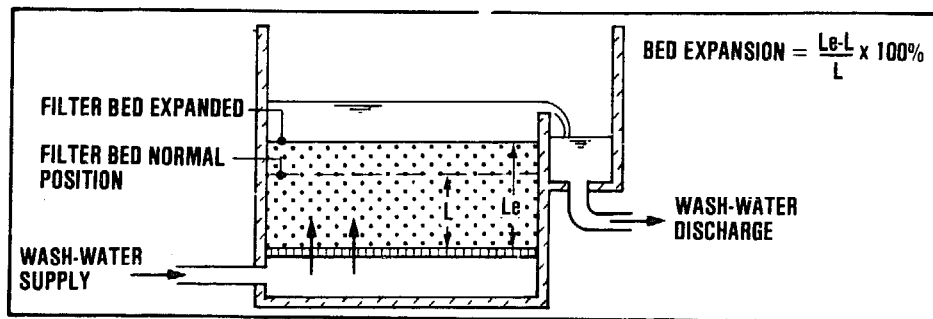

Figure 16.12.
Backwashing of rapid filter

For a filter bed of sand (specific weight: 2.65 g/cm³) typical backwash rates giving about 20 percent expansion are listed in Table 16.1.

Table 16.1.
Typical backwash rates

t	d mm	BACKWASH RATE (m ³ /m ² /hour)								
		0.4	0.5	0.6	0.7	0.8	0.9	1.0	1.1	1.2
10° c		12	17	22	28	34	40	47	54	62
20		14	20	26	33	40	48	56	64	73
30		16	23	30	38	47	56	65	75	86

d = average grain size of filter sand (mm)
t = back-wash water temperature (°C)
v = back-wash rate (m³/m²/hour)

If the wash water is supplied with pumps, three (in very small installations two) pumps in number are normally used of which one serves as the reserve unit. For high backwash rates and large filter bed areas these pumps would need to be of a large capacity so that their installation and operation would be rather expensive. A wash water reservoir such as the one shown in Fig. 16.13 is then preferable; small pumps will be adequate to fill the reservoir during the intervals between successive backwashings. The reservoir generally should have a capacity between 3 and 6 m³ per m² of filter bed area and it should be placed about 4-6 metres above the water level in the filter.

For pumping water into the wash-water tank, usually three pumps are provided one of which is the reserve unit. The total capacity of the two operating pumps should be about 10-20% of the wash-water supply rate. A special wash water tank or reservoir is not necessary when the required wash water is taken from the filtered water reservoir. However, this may cause undesirable pressure fluctuations in the distribution system due to the interrupted supply of water.

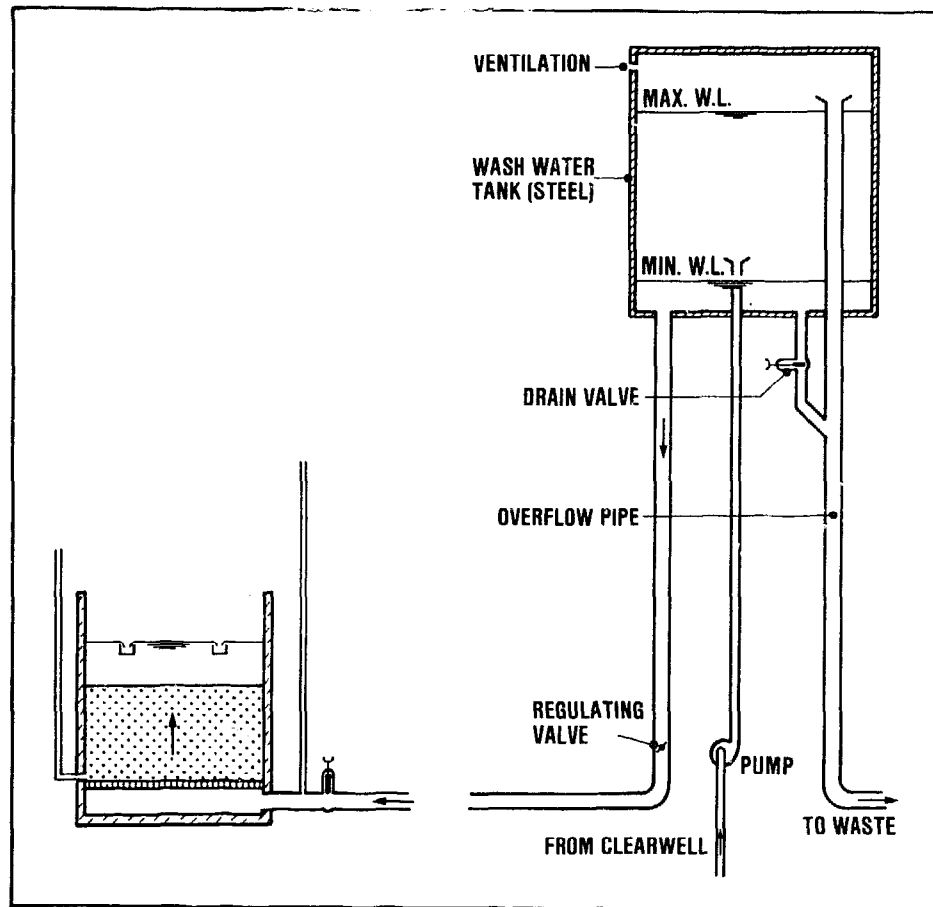

Figure 16.13.
Wash-water tank arrangement

A simpler solution is to increase the depth of the water standing over the filter bed and to limit the maximum filter resistance. The filtered water will then be available at a head of some 1.5 to 2 m above the filter bed which should be sufficient. The operating units of the filtration plant must supply enough water for the required back-wash rate. For this reason, a rapid filtration plant using this back-wash arrangement should have at least six filter units.

The wash water is admitted at the underside of the filter bed through the underdrain system ("filter bottom"). To divide the wash water evenly over the entire filter bed area, the underdrain system must provide a sufficient resistance against the passage of wash water (generally 0.6-1.0 m head of water).

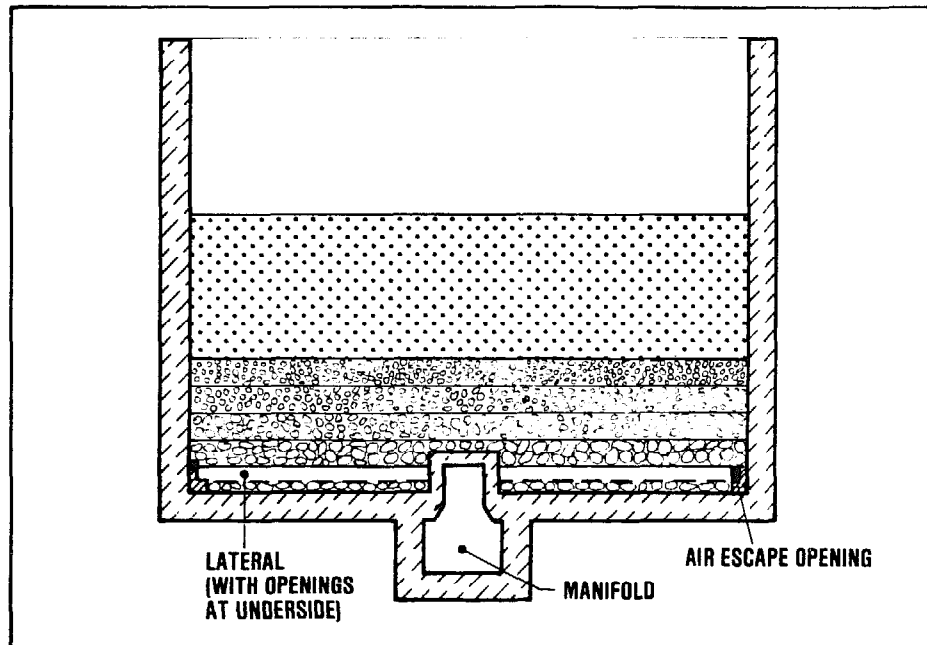

Figure 16.14.
Lateral underdrain systems

A frequently used underdrain system consists of laterals placed about 0.2 m apart, and connected to a manifold (Fig. 16.14). The laterals have holes at the under side, with a diameter of about 10 mm. Pipes of asbestos cement and rigid plastic are generally used in this underdrain system.

To prevent the filter material from entering the laterals through the holes, the filter bed should be supported by a layer of coarse material (e.g. gravel) that will not be dislodged by the backwash water jetting from the underdrain holes. For example, filter sand of 0.7-1.0 mm effective size would require 4 gravel layers; from top to bottom: 0.15 m x 2-2.8 mm, 0.1 m x 5.6-8 mm, 0.1 m x 16-23 mm and 0.2 m x 38-54 mm; the total gravel pack would be 0.55 m deep.

After passing the filter bed, the wash water carrying the washed-out impurities is collected and drained off with washwater troughs. The distance the wash water will have to travel horizontally to trough, should be limited to about 1.5-2.5 m. The troughs are set with their top at 0.5-0.6 m above the unexpanded sand bed, and their cross-sectional area follows from the consideration that at the discharge end of the

trough the water depth will be the free discharge ('critical') depth. (Fig. 16.15).

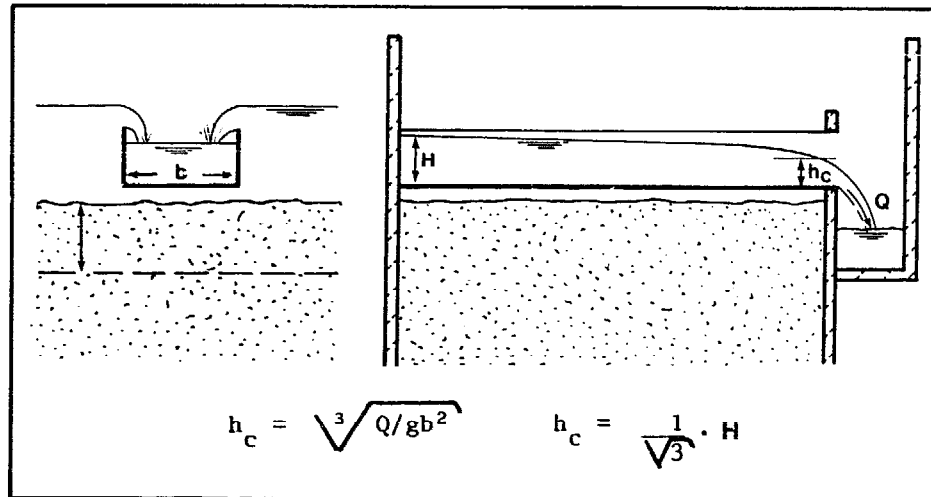

Figure 16.15.
Flow condition in wash-water trough

Table 16.2 gives wash water flow rates (Q) for combinations of depth of wash water flow (H) and width of wash water trough (b).

Table 16.2.
Wash water carrying capacity of troughs (litres/sec)

H Depth of washwater flow in trough	Width of trough		
	0.25 m	0.35 m	0.45 m
0.25 m	30	40	52
0.35 m	53	75	96
0.45 m	82	115	148

The wash water troughs can be placed in several ways. Fig. 16.16 shows typical arrangements.

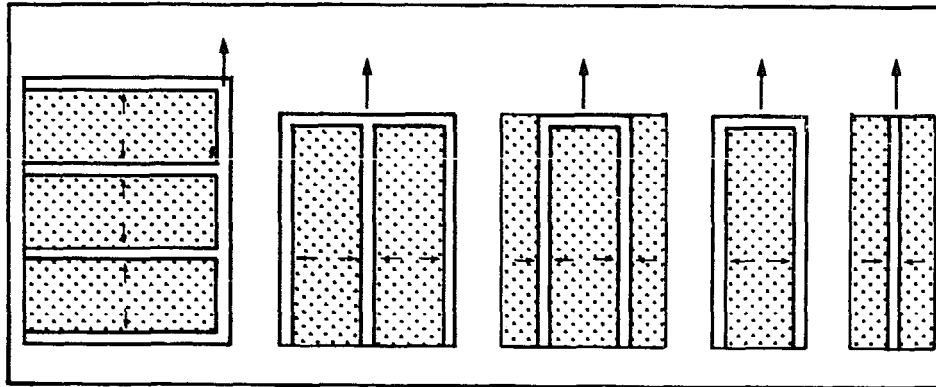

Figure 16.16.
Typical arrangements of wash-water troughs

Particularly when fine sand is used, with a grain size less than about 0.8 mm, the scouring force of the rising wash water may be inadequate to keep the filter grains clean in the long run. After some time they could become covered with a sticky layer of organic matter. This may cause problems such as mudballs and filter cracks (Fig. 16.17).

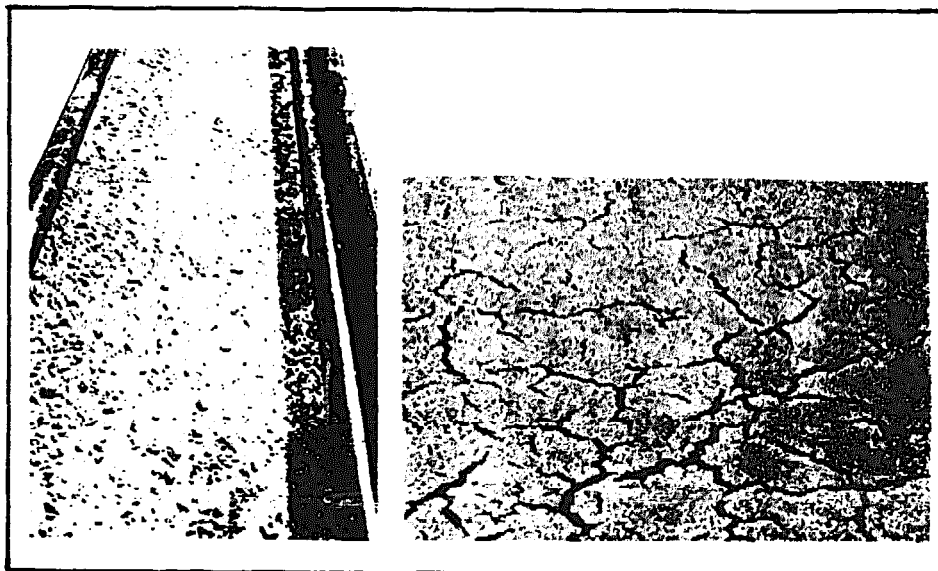

Figure 16.17.
Mudballs and filter cracks

These can be prevented by providing an additional scour through air wash. Filter cleaning now starts by back washing with air at a 30-50 m/hour rate, usually combined with a water wash at a 10-15 m/hour rate. This should remove the coatings from the filter grains and the loosened material is carried away by the following water wash. For backwashing with air a separate pipe system is necessary. An example is shown in Fig. 16.18. It should be noted that air-and-water backwashing generally is too complex an arrangement for small water treatment plants.

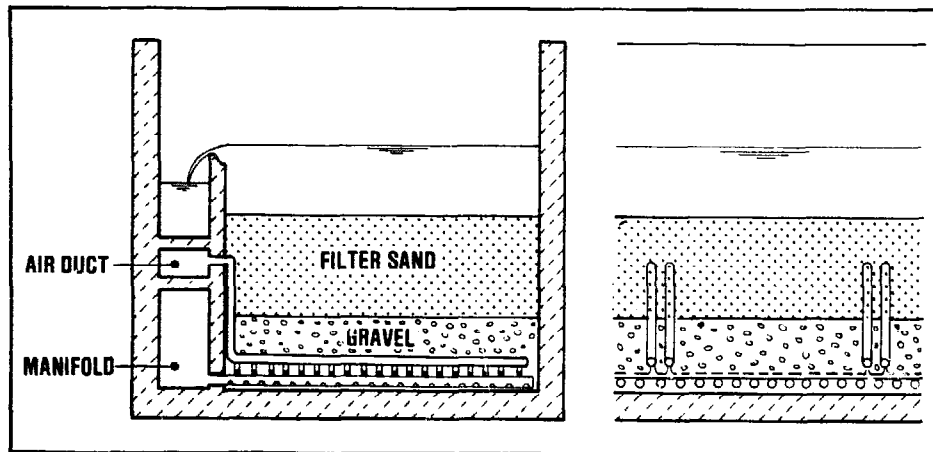

Figure 16.18.
Backwashing with air and water

An interesting arrangement for feeding air and water for back-washing is shown in Fig. 16.19. Back-washing starts by allowing water from chamber 1 to flow into chamber 2. The air in chamber 2 is pressurized and admitted for scouring the filter. Then the water collected in chamber 2 is used to back-wash the filter.

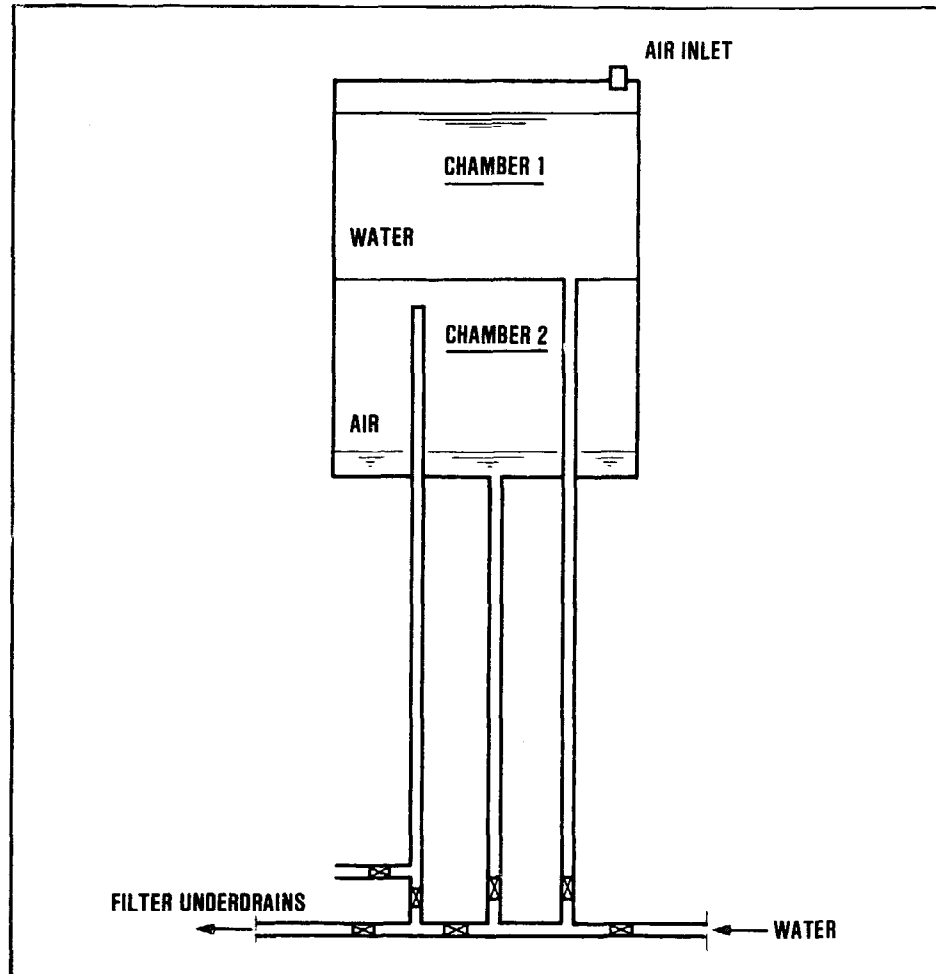

Figure 16.19
Air-and-water back-wash arrangement

Ref. Prof R.N. Sen
Indian Institute
of Technology
Kharagpur (India)

Rapid Filtration Plant Lay-out

A rapid filtration plant consists of a number of filter units (minimum 2), each with an area A. When one filter is out of operation for cleaning, the remaining units must be able to provide the required capacity Q at the selected rate of filtration r. This is expressed in the formula:

$$Q = (n - 1) A.r$$

For small plants there is little choice regarding suitable combinations of n and A, but for larger plants the choice should be such that the cost of construction is minimized. As a tentative design

step, the unit filter bed area (A) expressed in square metres may be taken about 3.5 times the number of filter units n.

For economy in construction and operation, the filter units should be set in a compact group with the influent and effluent lines, and any chemical feed lines as short as possible. The siting of the various units of a rapid filtration plant is a matter that warrants the closest attention of the design engineer. Allowance should be made for a future expansion of the plant. An example is shown in Fig. 16.20. Common facilities such as wash-water pumps and tanks, and chemical solution feeders, are to be placed in a service building which also should contain the office, laboratory and store rooms, chemical handling, and storage, and sanitary facilities.

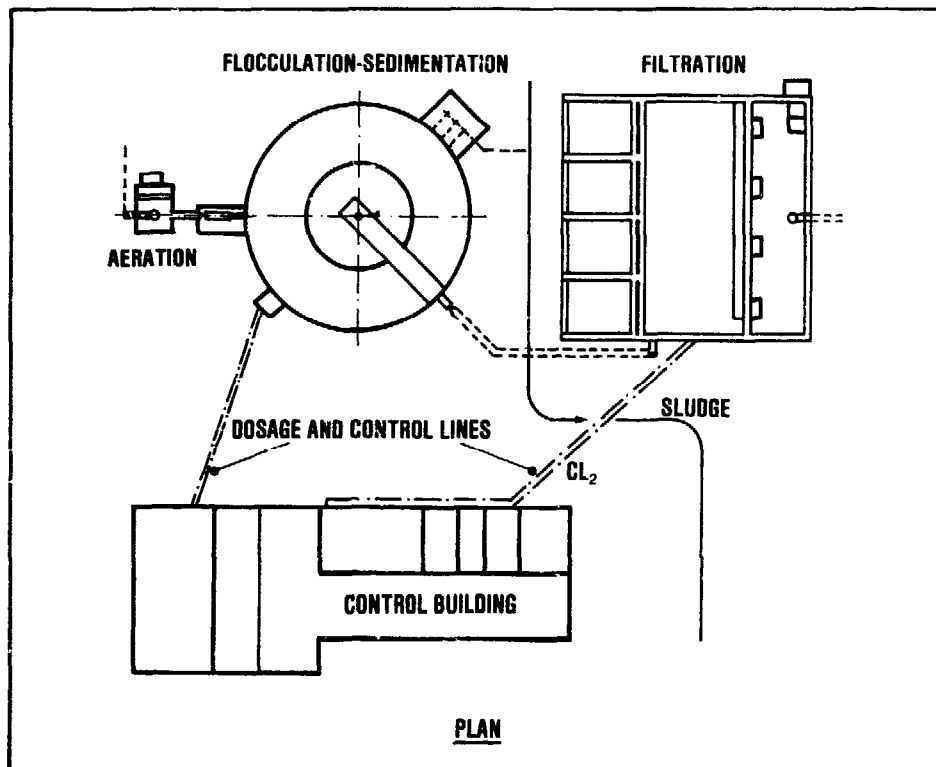

Figure 16.20.
Rapid filtration plant layout

Many designs place the service building in the centre while in the wings the various filter units are arranged on one or two sides of a two level corridor,

the upper level being the operating floor and the lower level the pipe gallery.

16.5 Construction

As explained in the preceding sections, a rapid filter consists of a tank containing the underdrain system, the filter bed and the supernatant water. The filter tank is mostly made of reinforced concrete, rectangular and with vertical walls. The design of the concrete structure follows common rules with the added difficulty that the water retaining structures must be water-tight. An ample concrete cover should be provided to protect the reinforcement bars against corrosion.

All bars should be placed far enough apart to allow the concrete to surround them completely. Loading stresses should be kept to a minimum. Any stresses developing in the concrete due to drying, shrinkage, temperature changes and differences in soil subsidence should be limited as far as possible by subdividing the building into a number of independent sections connected with water-tight expansion joints. The concrete mix's cement content and the placing of the mix should aim at full watertightness and as little drying shrinkage during hardening as possible. A plaster finish should never be used. A good finish can be obtained by using smooth shuttering, for instance made of laminated wood. To prevent short-circuiting of the water flow along the walls of the filter box, the inside shuttering opposite the filter bed should be made of unplanned planks placed horizontally. Whenever possible, the filters should be set above the highest groundwater table, if necessary on elevated land.

Numerous underdrain systems (popularly known as 'filter bottoms') have been developed in the past but unfortunately many are either too expensive or unable to ensure an even distribution of the washwater over the full underside of the filter bed. The simple system which was earlier described, using perforated laterals can be so constructed that a good washwater distribution is obtained. It has the added advantage that it may be made of locally available materials using local skills. Another good solution is the false bottom and strainer underdrain system. It consists of prefabricated concrete slabs, about $0.6 \times 0.6 \text{ m}^2$, placed on and anchored to short concrete columns as shown in Fig. 16.21.

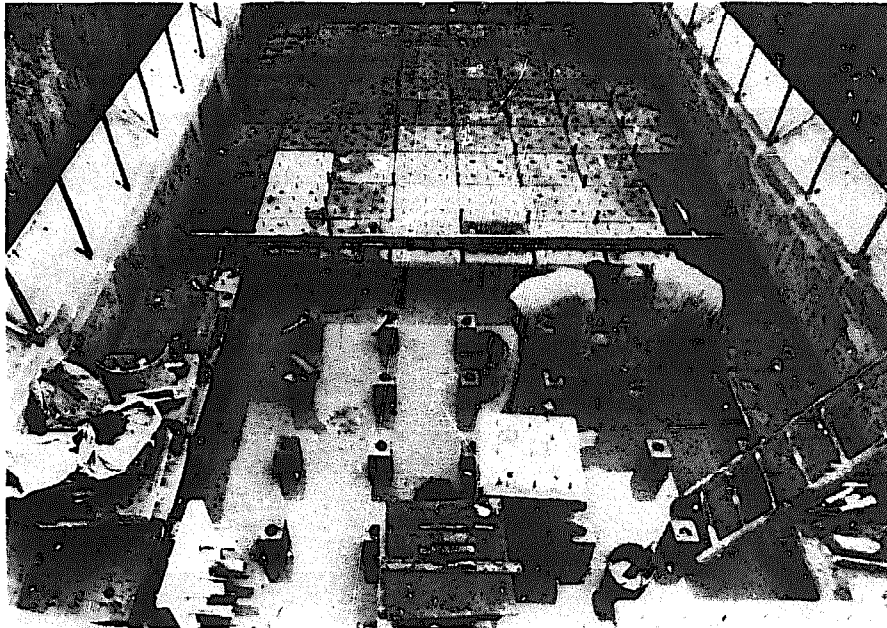

Figure 16.21.
Underdrain system with false bottom and strainers

The slabs are provided with holes, about 60 per square metre, in which the strainers are set (Fig. 16.22). The slits in these strainers are narrow, about 0.5 mm, giving a sufficient resistance against the passage of the wash water, for an even distribution of the water. This underdrain system allows the filter sand to be placed directly on the filter bottom with the strainers, and no supporting gravel layers are needed.

The work of a rapid filter is done by the filter bed and considerable attention should be given to its composition. Sand as filter material has proven to give excellent results, it is cheap and generally available, and for these reasons widely used. For single-medium filter beds there is no reason to use other filter materials except in very special cases. To prevent a hydraulic classification during back washing which would bring the fine grains to the top and the coarse grains to the bottom of the filter bed, filter sand that is as uniform as possible in size should be used. It should have a coefficient of uniformity less than 1.7 and preferably as low as 1.3. The requirements for grading filter sand are best given as maximum and minimum percentages of material that pass various sieves of standard mesh

sizes. For a graphical specification, a diagram can be plotted as in Fig. 16.23.

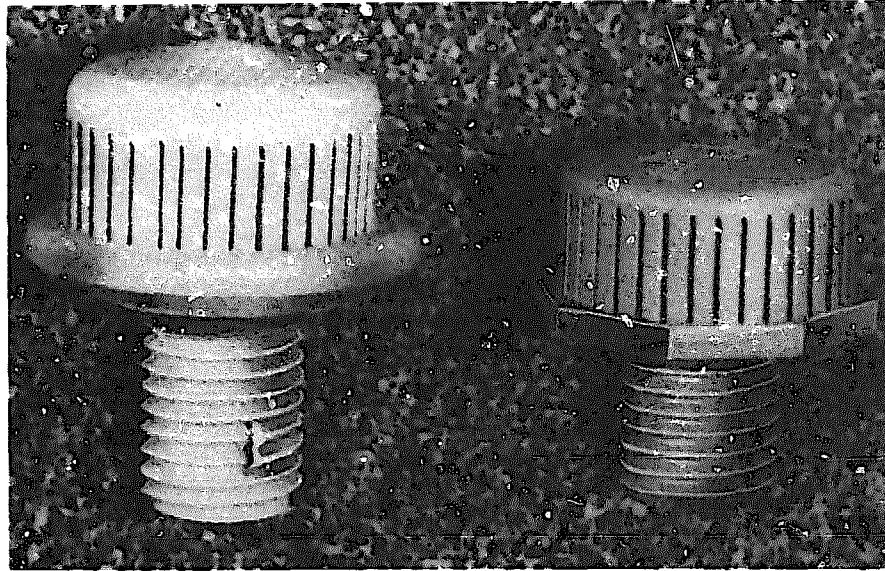

Figure 16.22.
Strainers made of plastic

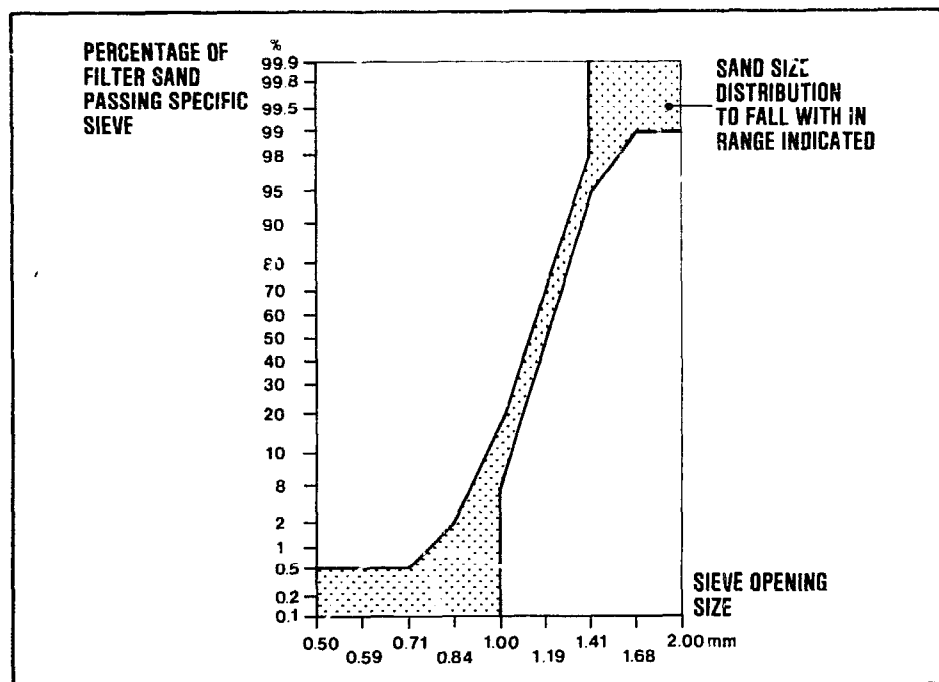

Figure 16.23.
Specification of filter sand for pre-treatment of river water

16.6 Village-scale rapid filtration

Because of their complex design and construction, and the need for expert operation, rapid filters are not very well suited for application in village-scale water treatment plants. This is especially true for their use as final filters in the treatment of turbid river water. The bacteriological safety of the filtered water then has to be secured by post-chlorination with all its associated difficulties. It would be better to use slow sand filters which give a bacteriologically safe filtrate, but these may suffer from rapid clogging caused by the turbidity present in the raw water.

Suspended matter can be removed from raw water through various processes such as: storage, coagulation and flocculation, and sedimentation. However, only rapid filters are able to constantly produce a clear water with a turbidity of less than 5 F.T.U. This will ensure the smooth operation of any following slow filters. There should be few objections against such an application of rapid filters. The use of rapid filtration for the removal of iron and manganese from groundwater also presents few problems as the health hazard of possible contamination of the treated water will be small.

Assuming a water use of 40 litres/person/day, the required water filtration capacity for 10,000 people would be 400 m³/day or 40 m³/hour for a 10-hour daily operating period. With a filtration rate of 5 m/hour this calls for 8 m² filterbed area which may be provided in three circular filters of 2 m diameter each (one filter as reserve). The underdrain system would probably best be made of perforated laterals (see section 16.4), covered with graded layers of gravel, broken stones or hard bricks chipped to the desired size. When coarse sand is available it should be graded using suitable sieves. Grading limits would be 0.8 mm - 1.2 mm for prefilters; 1.0 mm - 1.5 mm for iron and manganese removing filters. For pre-filters the sand bed thickness should be taken at 1.0 m and for iron and manganese removing filters at 1.5 m. In the event that sand cannot be obtained, similar materials may be used, such as crushed stones, bricks, crystalline calcium-carbonate, dolomite, etc. These should be graded to a size about 40 percent larger than the sizes mentioned above. In some instances burned rice husks and crushed coconut shells have given acceptable results. Before the filter is commissioned it should be back washed for about half an hour to clean the filter material.

The depth of supernatant water may be fixed between 1.5 and 2 m. The filter box will then have a total depth of 3.5-4 m.

The greatest difficulty encountered in village-scale rapid filtration is the backwashing process. It is uneconomical to use a wash-water pump. In the example presented earlier, a capacity of 100-200 m³/hour would be needed, in duplicate to allow for mechanical failures. Compared with the plant capacity of 40 m³/hour, this is an enormous pump involving a considerable investment and high operating costs. With an elevated washwater reservoir of 20 m³ volume, the pump capacity can be reduced to 10 m³/hour, but the costs of the tank should be taken into account. For villages with low buildings, the pressure in the distribution system generally does not need to be more than 6 m. In these cases, a good solution will be to use an elevated service reservoir for backwashing the filters. No separate pumps would be needed.

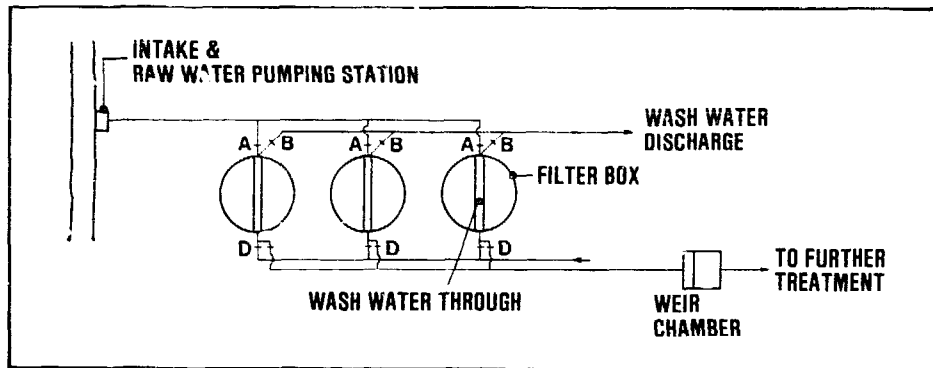

Figure 16.24.
General layout of a rapid filtration plant

The layout of the rapid filtration plant as described above is shown in Fig. 16.24. The raw water enters the filter through valve A and falls into the wash-water trough to disperse the flow energy. The branch pipes into which valves A are set, have a small diameter giving sufficient flow resistance (e.g. 0.5 m of head) to assure an even distribution of the raw water over the individual filter units. The filtered water is discharged through valve D and passes over a weir placed in the weir chamber. The top of the weir is set so high that the lowest raw water level in the filter tank will be at least 0.2 m above the filter bed. Due to clogging the level of the supernatant

water will rise until it reaches the water pressure level in the supply pipe; no more water will enter the filter. The filter should then be cleaned by feeding the wash water through valve C and discharging it through valve B. The dirty wash water should be clarified by sedimentation after which it may be discharged back into the river, some distance downstream of the raw water intake.

16.7 Roughing filtration

Sometimes a more limited treatment than rapid filtration using a sand bed, can be adequate for treating the raw water. This can be obtained by using gravel or plant fibres as filter material. In the upflow filter of Fig. 16.6 three layers would be used having grain sizes of 10-15 mm; 7-10 mm, and 4-7 mm, from the bottom upward, and with simple underdrain system. This coarse ("roughing") filter will have large pores that are not liable to clog rapidly. A high rate of filtration, up to 20 m/hour, may be used. The large pores also allow cleaning at relatively low back-wash rates since no expansion of the filter bed is needed. The backwashing of roughing filters takes a relatively long time, about 20-30 minutes.

Another possibility is the use of horizontal filters as shown in Fig. 16.25. These have a depth of 1-2 m subdivided into three zones, each about 5 m long and composed of gravel with sizes of 20-30 mm, 15-20 mm and 10-15 mm. The horizontal water flow rate computed over the full depth will be 0.5-1.0 m/hour.

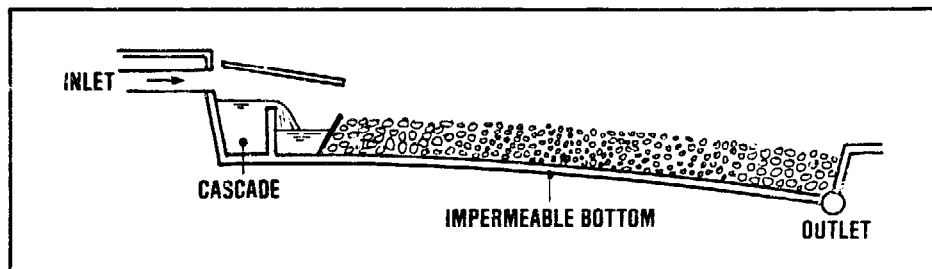

Figure 16.25.
Horizontal gravel filter

This represents a very low surface loading of the filter of only 0.03-0.10 m/hour. A large area will be required, but the advantage is that clogging of the

filter will take place very slowly, so that cleaning will be needed only after a period of years. This cleaning is carried out by excavating and washing the filter material after which it is put back in place.

Coconut fibres have been used for filter material in an experimental filter unit similar to a sand filter. The filter bed is only 0.3-0.5 m thick and the depth of supernatant water about 1 m. The filter is operated at rates of 0.5-1 m/hour which gives a length of filter run of several weeks. To clean the filter it is first drained after which the coconut fibres are taken out and discarded. The filter is repacked with new material that has previously been soaked in water for 24 hours to remove as much organic matter as possible. Coconut fibre filters appear to be able to cope with considerable fluctuations in their loading while producing an effluent of almost constant quality. The experiments showed a remarkably constant behaviour of the coconut fibre filters. The overall turbidity removal varied between 60 and 80 percent.

Rapid filtration

Arboleda, J.
METODOS SIMPLIFICADOS DE TRATAMIENTO DE AGUA
Nuevos Metodos de Tratamiento de Agua
CEPIS, Lima, August 1972 (Manual No. 14)

Arboleda, J.
HYDRAULIC CONTROL SYSTEMS OF CONSTANT AND DECLINING FLOW
FILTRATION
In: Journal Am. Water Works Assoc. Vol. 66(1974) No. 2, pp. 87-93

Baylis, J.R.
VARIABLE RATE FILTRATION
In: Pure Water, Vol. XI(1959) No. 5, pp. 86-114

Baylis, J.R.
EXPERIENCE WITH HIGH-RATE FILTRATION
In: Journal Am. Water Works Assoc. Vol. 42(1950) No. 7, pp. 687-694

Camp, T.R.
WATER TREATMENT
Handbook of Applied Hydraulics (2nd Edition)
McGraw-Hill Book Co., New York, 1962

Cleasby, J.L.
FILTER RATE CONTROL WITHOUT RATE CONTROLLERS
In: Journal Am. Water Works Assoc. Vol. 61(1969) No. 4, pp. 181-186

Cleasby, J.L.; Williamson, M.M.; Baumann, E.R.
EFFECT OF FILTRATION RATE CHANGES ON QUALITY
In: Journal Am. Water Works Assoc. Vol. 55(1963) No. 7, pp. 869-875

Conley, W.K.
EXPERIENCE WITH ANTHRACITE - SAND FILTERS
In: Journal Am. Water Works Assoc. Vol. 53(1961) No. 12,
pp. 1473-1483

Fair, G.M.; Geyer, J.C.; Okun, D.A.
WATER AND WASTEWATER ENGINEERING
Vol. 2, Water Purification and Wastewater Treatment and Disposal,
John Wiley & Sons, New York, 1968

Hudson, H.E.
DECLINING RATE FILTRATION
In: Journal Am. Water Works Assoc. Vol. 51(1959) pp. 1455-1461

Robeck, G.G.
MODERN CONCEPTS IN WATER FILTRATION
PAHO Symposium on Modern Water Treatment Methods,
Asuncion (Paraguay), 14 August, 1972
CEPIS, Lima, 1972 (Manual No. 14)

Shull, K.E.
EXPERIENCES WITH MULTIPLE-BED FILTERS
In: Journal Am. Water Works Assoc., March 1965, pp. 230-314

17. disinfection

17.1 Introduction

The single most important requirement of drinking water is that it should be free from any micro-organisms that could transmit disease or illness to the consumer. Processes such as storage, sedimentation, coagulation and flocculation, and rapid filtration reduce to varying degrees the bacterial content of water. However, these processes cannot assure that the water they produce is bacteriologically safe. Final disinfection will frequently be needed. In cases where no other methods of treatment are available, disinfection may be resorted to as a single treatment against bacterial contamination of drinking water.

Disinfection of water provides for destruction or at least complete inactivation of harmful micro-organisms present in the water. It is carried out using physical or chemical means. The following factors influence the disinfection of water:

- 1) The nature and number of the organisms to be destroyed.
- 2) The type and concentration of the disinfectant used.
- 3) The temperature of the water to be disinfected; the higher the temperature the more rapid is the disinfection.
- 4) The time of contact; the disinfection effect becomes more complete when the disinfectant remains longer in contact with the water.
- 5) The nature of water to be disinfected; if the water contains particulate matter, especially of a colloidal and organic nature, the disinfection process generally is hampered.
- 6) The pH (acidity/alkalinity) of the water.
- 7) Mixing; good mixing ensures proper dispersal of the disinfectant throughout the water, and so promotes the disinfection process.

17.2 Physical disinfection

The two principal physical disinfection methods are boiling of the water, and radiation with ultraviolet rays.

Boiling is a safe and time-honoured practice which destroys pathogenic micro-organisms such as viruses, bacteria, cercariae, cysts and ova. While it is effective as a household treatment, it is not a feasible method for community water supplies. However, in emergency situations boiling of water may be used as a temporary measure.

Ultraviolet light radiation is an effective disinfection method for clear water but its effectiveness is significantly reduced when the water is turbid or contains constituents such as nitrate, sulphate and ferrous iron. This disinfection method does not produce any residual that would protect the water against new contamination, and that could serve for control and monitoring purposes. Ultraviolet light for disinfection has been used in several developed countries but is rarely applied in developing countries.

17.3 Chemical disinfectants

A good chemical disinfectant should possess the following important characteristics:

- Quick and effective in killing pathogenic micro-organisms present in the water;
- Readily soluble in water in concentrations required for the disinfection, and capable of providing a residual;
- Not imparting taste, odour or colour to water;
- Not toxic to human and animal life;
- Easy to detect and measure in water;
- Easy to handle, transport, apply and control;
- Readily available at moderate cost.

The chemicals that have been successfully used for disinfection are: chlorine, chlorine compounds and iodine dosed in suitable form; ozone and other oxidants like potassium permanganate and hydrogen peroxide. Each one of these has its advantages and limitations.

Chlorine and chlorine compounds: Their ability to destroy pathogens fairly quickly, and their wide availability make them well suited for disinfection. Their cost is moderate and they are, for this reason, widely used as disinfectants throughout the world.

Iodine: In spite of its attractive properties as a disinfectant, iodine has serious limitations. High doses (10-15 mg/l) are required to achieve satis-

factory disinfection. It is not effective when the water to be disinfected is coloured or turbid. The high volatility of iodine in aqueous solution is also a factor against its use except in emergency situations.

Potassium Permanganate: This is a powerful oxidising agent, and has been found to be effective against cholera vibrio but not for other pathogens. It leaves stains in the container and hence it is not a very satisfactory disinfectant for community water supplies.

Ozone: Ozone is increasingly used for disinfection of drinking water supplies in industrialized countries, as it is effective in eliminating compounds that give objectionable taste or colour to water. Like ultra-violet rays, ozone normally leaves no measurable residual which could serve for monitoring the process. The absence of a residual also means that there is no protection against new contamination of the water after its disinfection. The high installation and operation costs and the need for continuous supply of power do not make the use of ozone a recommended practice in developing countries.

17.4 Chlorination

Water disinfection by chlorination, first introduced in the early 20th century, was perhaps the most important technological event in the history of water treatment. The chlorination of water supplies in developing countries is extremely important. Poor sanitation resulting in the faecal pollution of water sources frequently poses the greatest threat to public health. Effective chlorination of water supplies has in many cases achieved a substantial reduction in those enteric diseases that are primarily water-related. Recent studies, still in progress, have raised the possibility that organic compounds formed ("halogenated") when chlorine is added to water, might cause certain forms of cancer in man. Due to the number of variables involved no definite evidence is available so far. On the other hand, the disinfecting properties of chlorine are well established and, to date, should outweigh the suggested possible side effects when it is used to safeguard public health.

Chlorine is a greenish yellow toxic gas found in nature only in the combined state, chiefly with

sodium as the common salt. It has a characteristic penetrating and irritating odour, is heavier than air and can be compressed to form a clear amber-coloured liquid. Liquid chlorine is heavier than water. It vapourises under normal atmospheric temperature and pressure. Commercially, chlorine is manufactured by the electrolysis of brine with caustic soda and hydrogen as by-products. As a dry gas, chlorine is non-corrosive but in the presence of moisture it becomes highly corrosive to all metals except silver and lead. Chlorine is slightly soluble in water, approximately 1 percent by weight at 10°C.

Chlorinated Lime ("Bleaching Powder"): Before the advent of liquid chlorine, chlorination was mostly accomplished by the use of chlorinated lime. It is a loose combination of slaked lime and chlorine gas, with the approximate composition $\text{CaCl}_2 \cdot \text{Ca}(\text{OH})_2 \cdot \text{H}_2\text{O} + \text{Ca}(\text{OCl})_2 \cdot 2\text{Ca}(\text{OH})_2$. When added to water, it decomposes to give hypochlorous acid, HOCl . When fresh, chlorinated lime has a chlorine content of 33 to 37 per cent. Chlorinated lime is unstable; exposure to air, light and moisture makes the chlorine content fall rapidly. The compound should be stored in a dark, cool and dry place, in closed, corrosion-resistant containers.

High-Test Hypochlorites*: These are not only twice as strong as chlorinated lime (60 to 70 per cent available chlorine content) but retain their original strength for more than a year under normal storage conditions. They may be obtained in packages of 2-3 kg, and in cans of up to 45 kg; also available in granular or tablet form.

Sodium Hypochlorite: As a solution, sodium hypochlorite (NaOCl) usually contains 12 to 15 per cent available chlorine in the commercial product. Household bleach solutions of sodium hypochlorite usually contain only 3 to 5 per cent available chlorine.

It is the characteristics of chlorine and its compounds that have dictated the methods of handling and application in water disinfection practice.

Chlorination Practice: Chlorination practices may be grouped under two categories depending upon the desired level of residual chlorine and the point of application.

* Trade names include: 'HTH', 'Perchlorin', and 'Pittchlor'.

When it is required to provide a residual and the time of contact is limited, it is common practice to provide for free available residual chlorination. If combined available residual chlorination is used, the chlorine is applied to water to produce, with natural or added ammonia, a combined residual effect (Fig. 7.1).

Pre-chlorination is the application of chlorine prior to any other treatment. Frequently, this is for the purpose of controlling algae, taste and odour. Post-chlorination refers to the application of chlorine after other treatment processes, particularly after filtration.

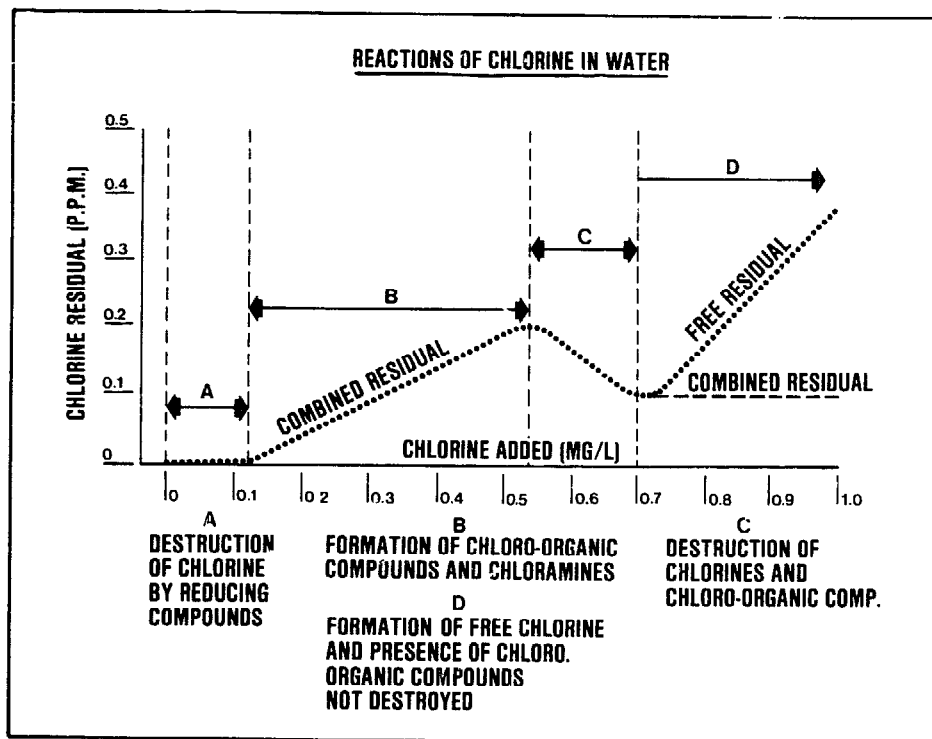

Figure 17.1.
Reactions of chlorine in water

Chlorine Demand: This is the difference between the amount of chlorine added to water and the amount of free or combined available chlorine remaining at the end of a specified contact period.

Residual Chlorine: Several methods are available to measure residual chlorine in water. Two of the more simple methods are presented here.

a) Diethyl-para-Phenylenediamine Method (DPD).*

Free available chlorine reacts instantly with N-diethyl-para-phenylene-diamine producing a red colouration providing iodine is absent. Standard solutions of DPD potassium permanganate are used to produce colours of various intensities. Colour produced by the addition of DPD is measured by a colorimetric method to indicate the concentration of residual chlorine. The colour produced by this method is more stable than that in Orthotolidine Method.

b) Orthotolidine Method

Orthotolidine, an aromatic compound, is oxidized in an acid solution by chlorine, chloramines and other oxidants to produce a yellow coloured complex the intensity of which is directly proportional to the amount of oxidants present. The method is suitable for the routine determination of chlorine residuals not exceeding 10 mg/l. The presence of natural colour, turbidity and nitrate interferes with the colour development. Orthotolidine has been demonstrated to cause cancer and is being withdrawn from production in several countries.

17.5 Chlorination technology for rural water supply

Groundwater obtained from shallow dug wells continues to be the major source of supply for millions of people in small communities. A number of surveys have revealed that dug wells become quite frequently contaminated. Surface water sources such as village ponds, canals and rivers are usually also polluted. While it is neither feasible nor always necessary to establish complete treatment of the water from these sources, proper disinfection should at least be provided in order to protect public health.

Technically, disinfection by chlorination can give a satisfactory solution for rural and small community water supplies. Disinfection by gaseous chlorine is generally not feasible for small water supplies, due to the problems of applying small quantities of gas accurately and on a continuous basis. The choice is likely to fall on chlorine compounds.

* Surveillance of Drinking Water Quality,
WHO Monograph Series 63 (1976)

Bleaching Powder: Chlorinated lime or bleaching powder (see Annex 4 for details) is a readily available and cheap chlorine compound. This chemical is easy to transport and not dangerous to handle if it is supplied in a suitable container. It is a free-flowing white or yellowish powder containing about 33 to 37 percent available chlorine. It is unstable and will lose chlorine during storage. In the presence of moisture, bleaching powder becomes corrosive; it is necessary to use corrosion-resistant containers made of wood, ceramic or plastics. These should be stored in a dark, cool and dry place. In order to minimize the loss of chlorine a maximum concentration of 5 percent is recommended for a bleaching powder solution.

Disinfection of Open Dug Wells: As open dug wells will continue to be used in considerable numbers as sources of drinking water in rural and small communities, it is desirable to employ simple methods for disinfecting the water of these wells.

Pot Chlorination: An earthen pot of 7 to 10 litres capacity with 6 to 8 mm diameter holes at the bottom is half filled with pebbles and pea gravel of 20-40 mm size. Bleaching powder and sand (in a 1 to 2 mixture) is placed on top of the pea gravel and the pot is further filled with pebbles up to the neck (Fig. 17.2). The pot is then lowered into the well with its mouth open.

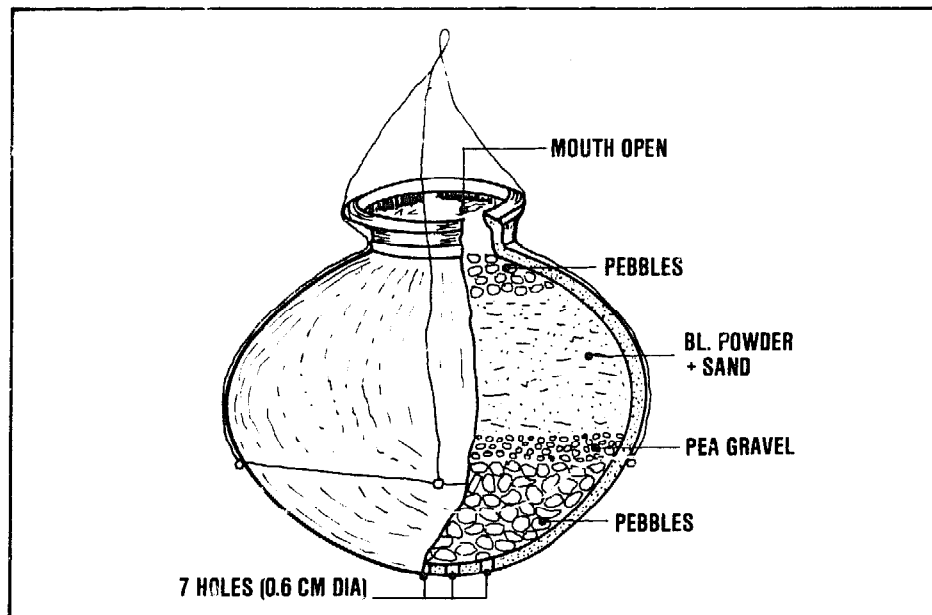
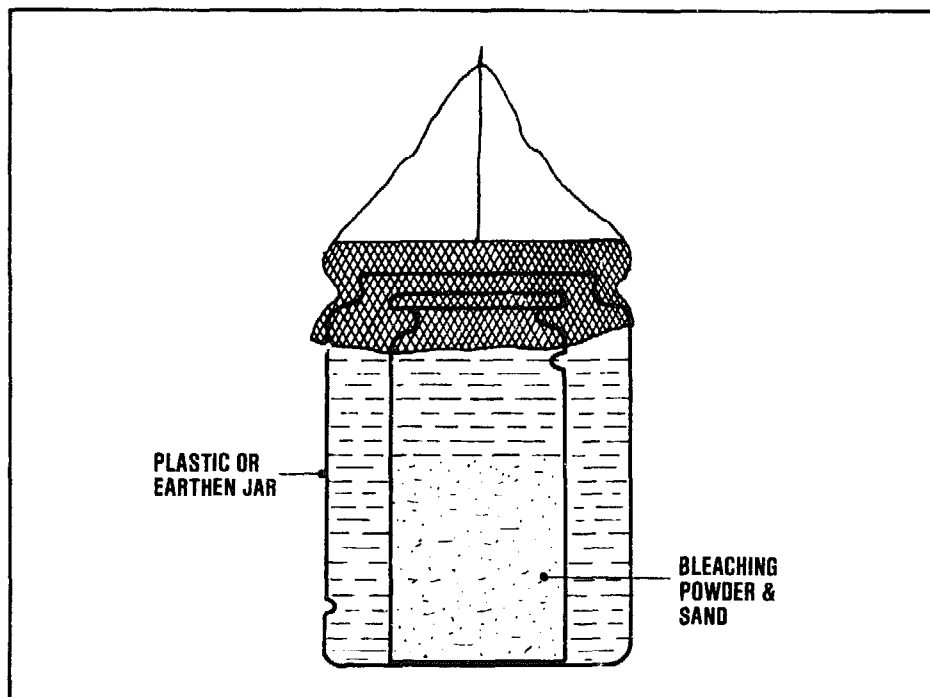

Figure 17.2.
Chlorination pot with holes at the bottom

For a well from which water is taken at a rate of 1,000-1,200 litres/day, a pot containing about 1.5 kg of bleaching powder should provide adequate chlorination for about one week.

Double pot System: When a single chlorination pot is used in a small household well, it may be found to give too high a chlorine content to the water ("over-chlorination"). In such situations, a unit consisting of two cylindrical pots one inside the other has been found to work well (Fig. 17.3). The inner pot is filled with a moistened mixture of 1 kg of bleaching powder with 2 kg of coarse sand to a little below the level of the hole and is then placed inside the outer pot. The mouth of the outer pot is tied with a polythene sheet and the unit lowered into the well with the help of a rope. Such a unit has been found to work effectively for 2 - 3 weeks in household wells of 4,500 litres capacity from which water is withdrawn at a rate of 400-450 litres/day.



After: Rajagopalan & Shiffman

*Figure 17.3.
Double pot chlorinator*

Drip-Type Chlorinator: An alternative device for disinfecting wells is a drip-feed chlorinator (Fig. 17.4). Clogging of the drip outlet may take place due

to calcium carbonate deposits that are formed when the bleaching powder solution comes into contact with atmospheric carbon dioxide. A special drip outlet similar to the one used in medical transfusions can be inserted in the outlet tube just before the stop-cock. The outlet tube is extended right into the well and dipped into the water. The container may be placed on the parapet of the well.

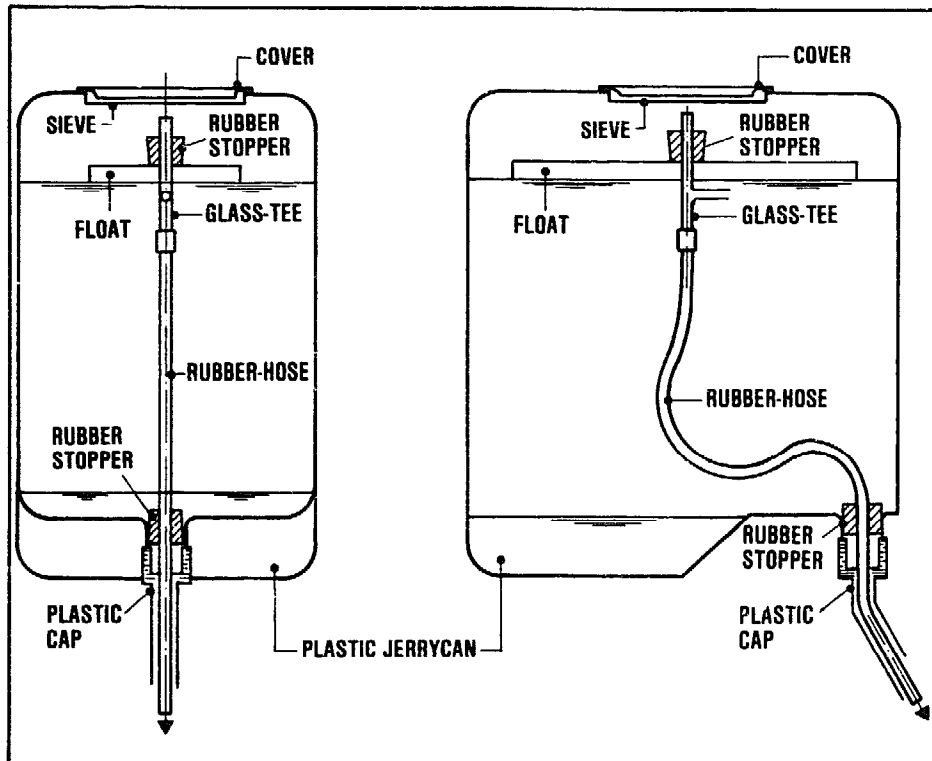

Figure 17.4.
Equipment for feeding chlorine solution

Solution feed devices using a constant head have been successfully operated in many places. Fig. 17.5 shows a "Floating Bowl" device.

Both the regulating tube and the delivery tube must have a tight sliding fit in the floating bowl. The tubes are adjusted to such a level that the solution enters into the bowl and flows down the delivery tube at the desired feeding rate. Another feeding rate can be set by varying the levels of the regulating and delivery tubes.

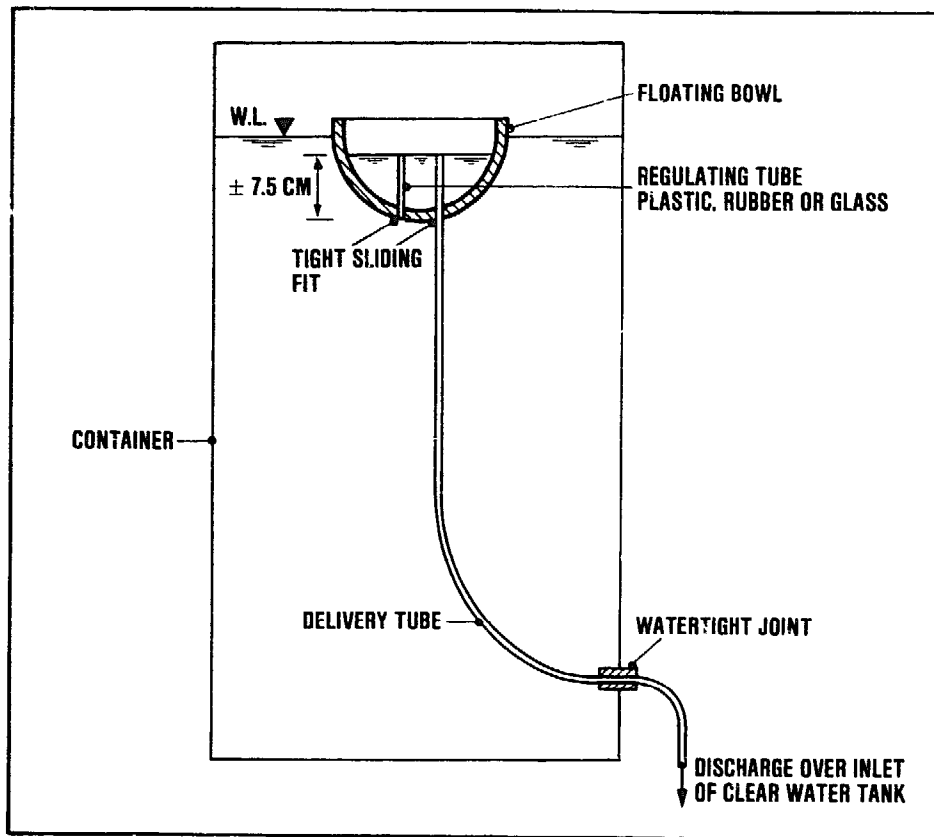

Figure 17.5.
Constant-head solution feeder for chlorine compounds

Proportioning Devices for Pumped Supplies: When water from the source is pumped to an elevated service reservoir and supplied by gravity to the distribution system, a bleaching powder solution may be dosed as in Fig. 17.6. From the bleaching powder solution reservoir a direct connection is made to the suction line of the pump. One percent bleaching powder solution prepared earlier and allowed to settle to remove impurities, is filled in the solution container. It should provide a supply sufficient for more than one day. Air entry at the suction side of the pump must be prevented. It is necessary to close the solution feed line when the pump is stopped.

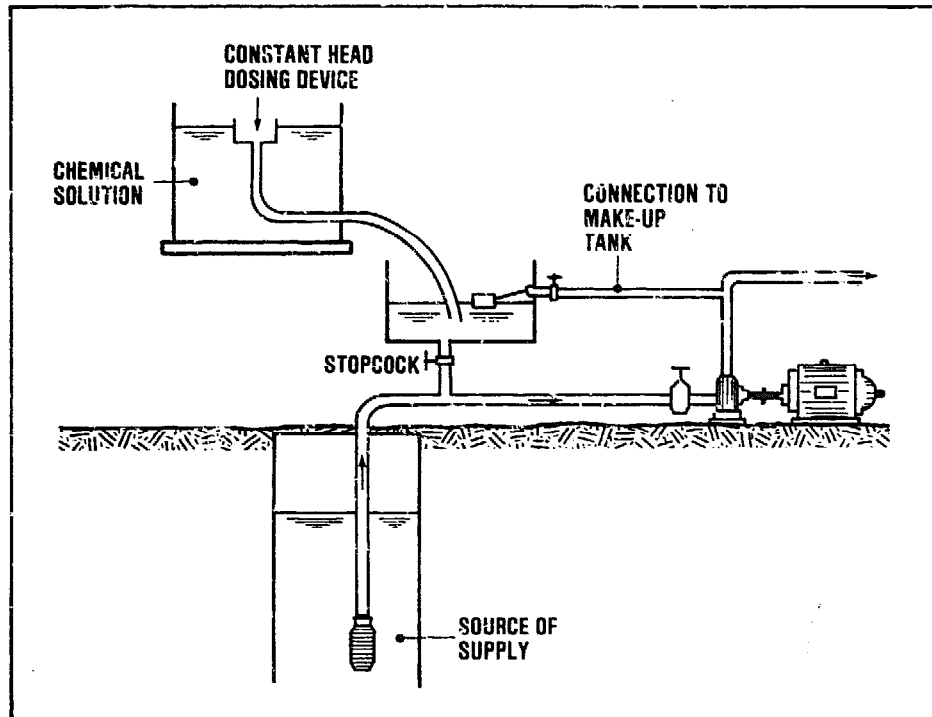

Figure 17.6.
Chlorination arrangement for pumped supplies

17.6 Disinfection using chlorine gas

The form in which the disinfectant should be used is governed by several factors such as the quantity of water to be treated, cost and availability of chemicals, the equipment needed for its application, and the skill required for operation and control. When the quantity of water to be treated is more than 500,000 litres per day, chlorine gas has been found to be the most economical. For smaller supplies, cylinder-mounted chlorine gas controllers are available but they are not capable of accurately feeding very small quantities of gas. Two distinct methods are available for controlled application of chlorine gas:

- 1) **Solution Feed:** The gas is first dissolved in a small volume of water and the resulting chlorine solution is fed to the main stream of the water to be disinfected. Dissolving the gas in a small volume of water promotes complete and rapid dispersal at the point of application.

- 2) Direct Feed: Here the gas is fed directly to the point of application. A special type of diffuser or perforated tubing (of silver or plastic) is needed for the proper diffusion of the gas. Therefore, this method is not recommended for small and rural water supplies.

The equipment used for the controlled feed of chlorine gas may be grouped under pressure-feed and vacuum-feed types. The pressure type consists of a gas filter, stop valve, pressure-reducing valve, and regulating valve or orifice tube with a manometer and moisture seal. Regardless of the pressure variation in the chlorine cylinder, a constant pressure is maintained across the orifice by means of the pressure-reducing valve. The differential pressure drop across the orifice is measured and is an indication of the rate of gas flow. The solution feed apparatus includes some means of introducing the metered gas into the small stream of water which then carries the chlorine to the point of application (Fig. 17.7).

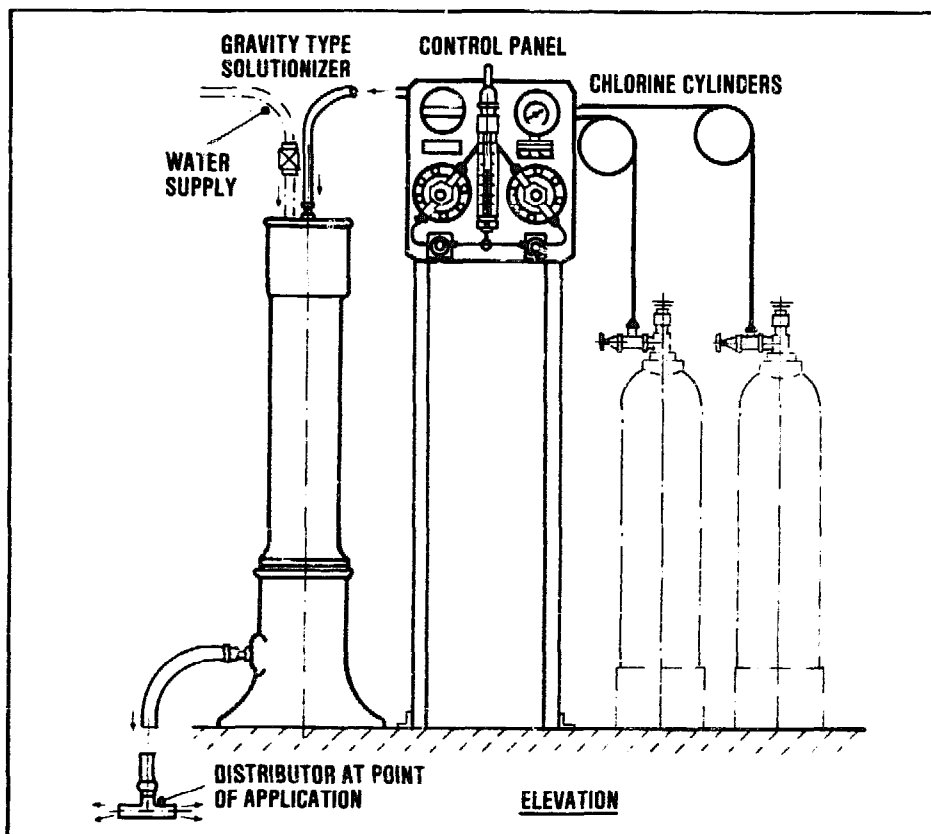

Figure 17.7.
Chlorine gas apparatus with gravity-type solutionizer

17.7 Disinfection of new tanks, pipes and wells

New Tanks: All new tanks and reservoirs should be disinfected before they are brought into service. Similarly, tanks that have been out of service for repair or cleaning should also be disinfected before they are put back in service. Prior to disinfection, wells and the bottoms of tanks should be cleaned by sweeping and scrubbing to remove all dirt and loose material.

One of the disinfection methods used for a new tank is to fill it to the overflow level with clean water to which enough chlorine added to produce a concentration of 50 mg/l. The chlorine solution is introduced into the water as early as possible during the filling operation in order to ensure thorough mixing and contact with all surfaces to be disinfected. After the tank is filled, it is allowed to stand, preferably for 24 hours but not for less than 6 hours. The water should then be drained out and the tank refilled for regular supply.

A second method which is quite satisfactory and practical under rural conditions, is the direct application of a strong solution (200 mg/l) to the inner surfaces of the tank. The surface should remain in contact with the strong solution for at least 30 minutes before the tank is filled with water.

A third method, which should be used only when other methods cannot be used, does not expose the upper surfaces of walls to a strong chlorine solution. Water containing 50 mg/l chlorine is fed in the tank to such a volume that when the tank is later completely filled up, the resultant chlorine concentration will be about 2 mg/l. The water containing 50 mg/l chlorine is held in the tank for 24 hours before the tank is filled up with water. The tank can then be put into service without draining the water used for the disinfection providing the final residual is not too high.

New Mains and Pipes: Distribution mains and pipelines are likely to be contaminated during laying irrespective of the precautions. Therefore, they must be disinfected before they are brought into use. Distribution systems need to be disinfected when contaminated in the event of main breaks or floods.

Every pipeline should be cleaned by swabbing and flushing in order to remove all foreign matter.

Immediately before use, the packing and jointing material should be cleaned and disinfected by immersion in a 50 mg/l chlorine solution for at least 30 minutes.

A practical means of applying chlorine solution for disinfection of rural water supply systems is to flush out each section to be disinfected. The intake valve is shut off and the section allowed to drain dry. Then the discharge hydrant or valve is shut off and the section isolated from the rest of the system. The disinfecting solution is fed through a funnel or a hose into a hydrant or opening made specially for this purpose at the highest part of the pipeline. Since air valves are usually placed at these high points removing an air valve often is a convenient way to provide a point of entry.

The solution is slowly poured in until the section is completely filled. Care should be taken to ensure that air trapped in the pipe is allowed to escape. If there is no air valve or other orifice, one or more service connections should be disconnected to provide for the release of air.

17.8 Disinfection of water supply in emergency situations

Long-term measures for the provision of safe water supply aided by personal hygiene and health education will greatly help protect and promote public health. However, natural disasters like cyclones, earthquakes and floods do occur and sometimes result in complete disruption of water supplies.

These situations call for measures to provide for supply of safe water on an emergency basis. While there is no single measure which is the panacea for all situations, the following may be useful to ensure a safe water supply depending upon local conditions and available resources.

When the regular water supply system is affected due to a disaster, top priority should be given by putting the system back into operation. Simultaneous action to tide over the situation should include a thorough search for all possible sources of water within a reasonable distance of the affected area. Water from private water supply systems and other sources may be transported by tankers to the points of consumption.

After floods, when the water supply distribution system remains intact, the pressure in the pipe lines should be raised so as to prevent polluted water from entering the pipes. As an additional measure the chlorination of the water at the treatment plants may be temporarily raised to a higher rate. High-dosage chlorination is recommended only in extreme circumstances or when cleaning out new pipes.

Chlorine Tablets and Bleach Solutions: Chlorine containing compounds that are dosed in solution or tablet form, are readily available in many countries*.

They are quite good for disinfecting small quantities of water, but are costly. After addition of the chemical in the prescribed quantity, the water is stirred and allowed to stand for 30 minutes before consumption. If the water is turbid, it may be necessary to increase the dose of the chemical.

* Trade names include: 'Halazone', 'Chlor-dechlor', 'Hydrochlorzone', 'Hadex'.

Disinfection

DISINFECTION FOR SMALL COMMUNITY WATER SUPPLIES
National Environmental Health Engineering Research
Institute, Nagpur (India)

Rajagopalan, S.; Shiffman, M.A.
GUIDE ON SIMPLE SANITARY MEASURES FOR THE CONTROL OF ENTERIC
DISEASES
World Health Organisation, Geneva, 1974

Rivas Mijares, G.
LA DISINFECCIÓN DEL AGUA EN AREAS TROPICALES
Italgrafica, S.R.L., Caracas, 1970

SURVEILLANCE OF DRINKING WATER QUALITY
World Health Organisation, Geneva, 1976, 135 p.

18. water transmission

18.1 introduction

Water transmission frequently forms part of a small community water supply system; in that they do not differ from large schemes. The water needs to be transported from the source to the treatment plant, if there is one, and onward to the area of distribution. Depending on the topography and local conditions, the water may be conveyed through free-flow conduits (Fig. 18.1), pressure conduits (Fig. 18.2) or a combination of both (Fig. 18.3). The transmission of water will be either under gravity or by pumping.

Free-flow conduits must be laid under a uniform slope in order to follow closely the hydraulic grade line*. Pressure pipelines can be laid up- and downhill as needed, as long as they remain a sufficient distance below the hydraulic grade line.

For community water supply purposes, pipelines are most common means of water transmission but canals, aqueducts and tunnels are also used. Whether for free flow or under pressure, water transmission conduits generally require a considerable capital investment. A careful consideration of all technical options and their costs is, therefore, necessary when selecting the best solution in a particular case.

18.2 Types of water conduits

Canals

Canals generally have a trapezoidal cross section but the rectangular form is more economical when the canal traverses solid rock. Flow conditions are more or less uniform when a channel has the same size, slope and surface lining throughout its length.

* The slope of the hydraulic grade line is the "hydraulic gradient". For open channels, it is the slope of the water surface. For closed conduits under pressure (e.g. pipelines), the hydraulic grade line slopes according to the head loss per unit length of pipe.

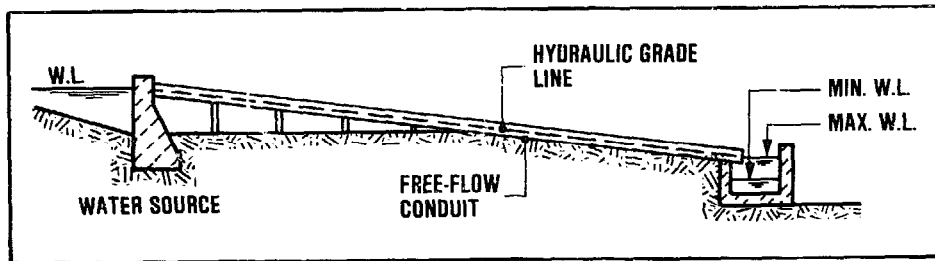

Figure 18.1.
Free-flow conduit

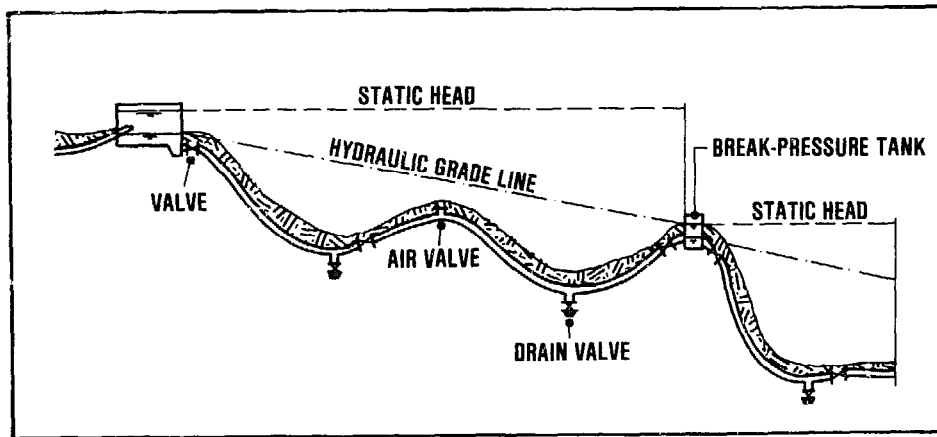

Figure 18.2.
Pressure pipeline

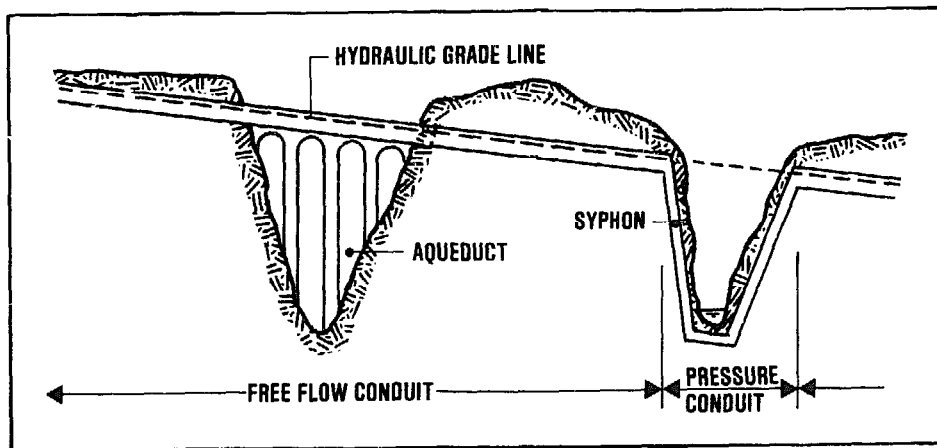

Figure 18.3.
Combined free-flow/pressure conduit

Open canals have limited application in water supply practice in view of the danger that the water will get contaminated. Open canals are never appropriate for the conveyance of treated water but they may be used for transmission of raw water.

Aqueducts and Tunnels

Aqueducts and tunnels should be of such a size that they flow about three quarters full at the design flow rate. Tunnels for free-flow water transmission frequently are horse-shoe shaped. Such tunnels are constructed to shorten the overall length of a water transmission route, and to circumvent the need for any aqueducts and conduits traversing uneven terrain. To reduce head losses and infiltration seepage, tunnels are usually lined. However, when constructed in stable rock they require no lining.

The velocity of flow in these aqueducts and tunnels ranges between 0.3-0.9 m/sec for unlined conduits, and up to 2 m/sec for lined conduits.

Free-flow Pipelines

In free-flow pipelines, there being no pressure, simple materials may be used. Glazed clay pipes, asbestos cement and concrete should be adequate. These pipelines must closely follow the hydraulic grade line.

Pressure Pipelines

Obviously, the routing of pressure pipelines is much less governed by the topography of the area to be traversed, than is the case with canals, aqueducts and free-flow pipelines. A pressure pipeline may run up- and downhill; there is considerable freedom in selecting the pipeline alignment. A routing alongside roads or public ways is often preferred to facilitate inspection (for detection of any leakage, unoperative valves, damage, etc.) and to provide ready access for maintenance and repair.



IRC Photo

*Figure 18.4.
Pressure pipeline under construction (Kenya)*

18.3 Design considerations

Design Flow

The water demand in a distribution area will fluctuate considerably during a day. Usually a service reservoir is provided to accumulate and even out the water demand fluctuation. The service reservoir is supplied from the transmission main, and is located at a suitable position to be able to supply the distribution system (Fig. 18.5). The transmission main is normally designed for the carrying capacity that is required to supply the water demand on the maximum day at a constant-rate basis. All hourly variations in the water demand during the day of maximum consumption, are then assumed to be leveled out by the service reservoir.

The number of hours the transmission main operates per day is another important factor. For a water supply with diesel engine or electric motor-driven

pumps, the daily pumping often is limited to 16 or less hours. In such a case, the design flow rate for the transmission main needs to be adjusted accordingly.

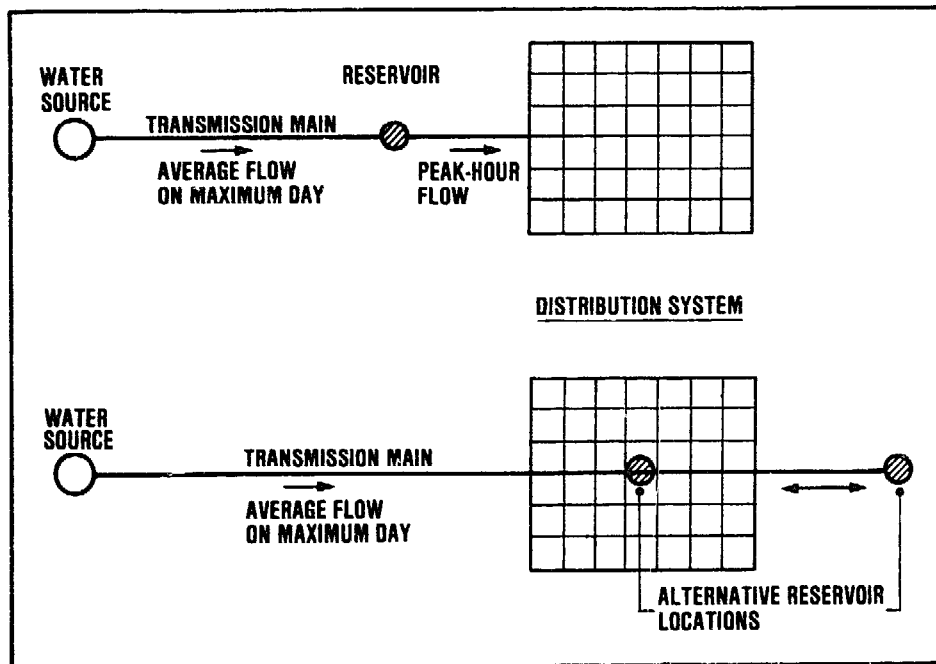

Figure 18.5.
Transmission main and service reservoir (schematic)

Design Pressure

The design pressure, of course, is only of relevance for pressure pipelines. Such pipelines generally follow the topography of the ground quite closely. The hydraulic grade line indicates the water pressure in the pipeline under operating conditions. The hydraulic grade line should lie above the pipeline, over its entire length, and for all rates of flow; in fact, nowhere should the operating head of water in the pipeline be less than 4 m (Fig. 18.6).

The pipe material must be selected to withstand the highest pressure that can occur in the pipeline. The maximum pressure frequently does not occur under operating conditions but it is the static pressure when the pipeline is shut. In order to limit the maximum pressure in a pipeline and, thus, the cost of the pipes, it can be divided into sections separated by a break-pressure tank. The function of such a

break-pressure tank is to limit the static pressure by providing an open water surface at certain places along the pipeline. The flow from the upstream section can be throttled when necessary.

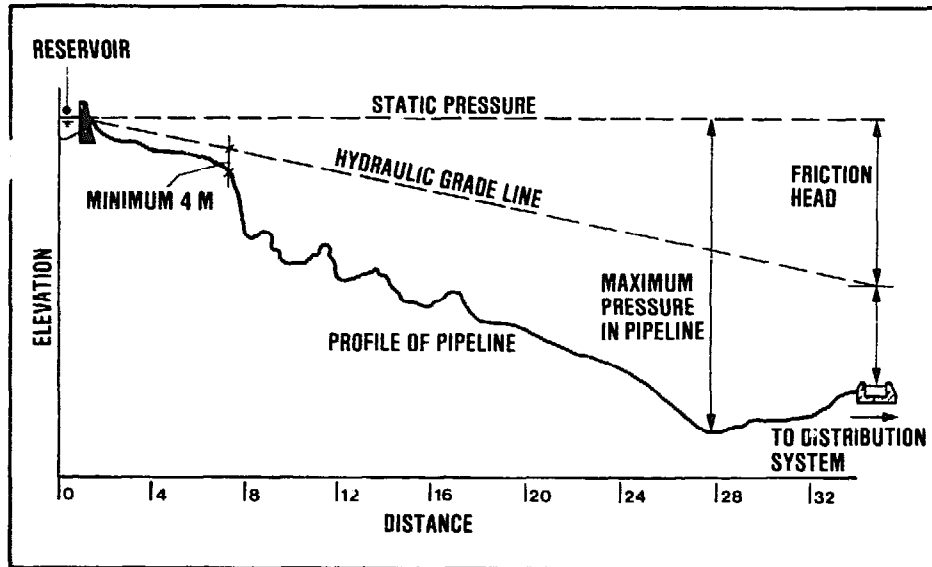

Figure 18.6.
Design pressure determination for pipeline

Critical pressures may also develop as a result of pressure surge or water hammer in the pipeline. These are caused by the instant or too rapid closure of valves, or by sudden pump starts or stops. The resulting pressure surges create over- and under-pressures that may damage the pipeline.

18.4 Hydraulic design

For a given design flow rate (Q), the velocity of flow (v) and consequently the required size of the water transmission conduit may be computed using the following formulae:

Open Conduits

The Manning (or Strickler) formula is widely used in the hydraulic design of open conduits with free flow conditions. The formula reads:

$$v = C.R^{2/3}.I^{1/2}$$

- v = (average) velocity of flow in water conduit (m/sec.)
 C = Coefficient of roughness of conduit walls and bottom (mm)
 R = Hydraulic radius (m)
 I = Hydraulic gradient (m/m¹);

For design purposes, Table 18.1 provides indicative values of the coefficient of roughness for various types of linings in clean, straight channels*.

*Table 18.1.
Indicative values for roughness of various types of linings*

Type of Lining	Coefficient of roughness (K)
Planed timber, joints flush	80
Sawn lumber, joints uneven	70
Concrete, trowel finished	80
Masonry	
. Neat cement plaster	70
. Brickwork; good finish	65
. Brickwork; rough	60
Excavated	
. Earth	45
. Gravel	40
. Rock cut, smooth	30
. Rock cut, jagged	25

Pipelines

The most accurate formula for computing the head loss of water flowing through a pipeline is the Colebrook-White ('universal') formula:

$$H = \frac{8\lambda}{\pi^2 g} \cdot \frac{Q^2}{D^5} \cdot L = i \cdot L$$

Where:

- H = head loss (m)
 L = length of pipeline (m)
 λ = friction coefficient
 D = internal pipe diameter (m)
 Q = flow rate (m³/s)
 g = gravitational factor (approx. 9.8 m/sec²)
 I = hydraulic gradient (m/m¹ or m/km)

* In practice, a channel does not have a single C-value. Frequently it varies for different sections of the channel, and often there are also seasonal variations.

The factor λ is the friction coefficient which is a function of the pipe wall roughness (k), the (kinematic) viscosity of water (ν), the flow velocity (v), and the internal pipe diameter (D). The Colebrook-White formula is too complicated for numerical calculations. Tables and monograms have been prepared for different values of pipe wall roughness.

Table 18.2 is an example. It gives the head loss for water flowing through smooth-walled pipes (wall roughness $k = 0.1$ mm). Figure 18.7 is an example of a head loss determination graph for pipes with wall roughness $k = 0.2$ mm.

Table 18.2.
Head loss in m/km

temperature 20° C

for smooth pipes (wall roughness $k = 0.1$ mm)

D in mm \ Q in l/s	15	20	25	30	50	70	100	120	150	200
0.1	44.1	10.5	3.51	1.45						
0.15	94.1	22.0	7.28	2.97						
0.2	162	37.6	12.3	4.99						
0.3		80.5	26.0	10.5	0.85					
0.5		214	68.1	27.0	2.13					
0.7			129	51.0	3.94	0.76				
1.0				101	7.60	1.44				
1.5					16.2	3.02				
2					28.0	5.15	0.88			
3					60.9	11.0	1.86	0.76		
5					164	29.1	4.81	1.94	0.65	
7						55.7	9.09	3.64	1.20	
10						111	17.9	7.13	2.33	0.56
15							39.2	15.5	5.01	1.19
20							68.6	26.9	8.66	2.04
30							152	59.3	18.9	4.39
50								161	51.0	11.7
70									98.7	22.5
100										199 45.1

Example 1

What is the head loss in a pipeline 1200 m long with a diameter of 50 mm, for a flow of 3 m³/hour?

A flow of 3 m³/hour is equal to 0.83 l/sec. Using the table:
 Q = 0.7 l/sec, i = 3.94 m/km, thus

$$I = \frac{(0.83)^2}{(0.7)} (3.94) = 5.54 \text{ m/km}$$

$$Q = 1.0 \text{ l/sec, } i = 7.60$$

$$I = \frac{(0.83)^2}{(1.0)} (7.60) = 5.24 \text{ m/km}$$

The average is (5.54 + 5.24) : 2 = 5.4 m/km, so that over a length of 1.2 km the head loss will be
 (1.2)x(5.4) = 6.5 m head of water.

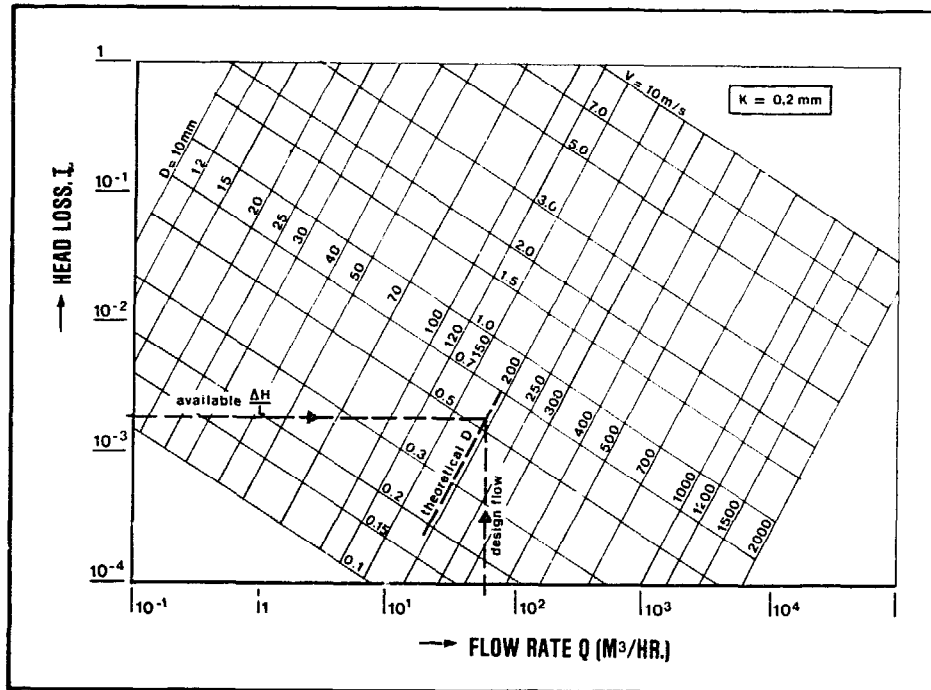

Figure 18.7.
 Head loss determination graph

Example 2

What will be the flow in a 50 mm diameter pipe to transport water from a small dam to a tank at 600 m distance. The difference in elevation between the two points is 5.40 m.

The hydraulic gradient thus is $5.40/0.6 = 9 \text{ m/km}$.
 According to the table, the hydraulic gradient for a flow of 1
 litre/sec is 7.60 m/km . Thus the actual flow will be:

$$Q = 1.0 \sqrt{\frac{9}{7.6}} = 1.1 \text{ litres/sec, or approximately}$$

$4 \text{ m}^3/\text{hour}$.

Example 3

What will be the flow in example 2 when a 55 mm diameter pipe
 is chosen?

$$Q = (1.1) \left(\frac{55}{50} \right)^{2.5} = 1.4 \text{ litres/sec.}$$

Indicative values of pipe wall roughness (k) are
 given below:

<u>Pipe Material</u>	<u>Pipe Wall Roughness*</u>
Asbestos Cement (A.C.)	k = 0.1 mm
Polyvinylchloride (P.V.C.)	k = 0.1 mm
Polyethylene (P.E.)	k = 0.05 mm
Ductile Iron (D.I.) (unlined)	k = 0.25 mm
Ductile Iron (D.I.) (cement-lined)	k = 0.125 mm
Steel (lined)	k = 0.125 mm
Galvanised Steel (G.S.)	k = 0.15 mm



Figure 18.8.
Water transmission main river crossing

* After several years of service, and allowing for the effect
 of the joints and some misalignment of the pipes.

18.5 Water transmission by pumping

For water transmission by pumping, the head loss corresponding with the design flow rate can be computed for any pipe diameter using tables or nomographs like the ones presented in section 18.4. The pumping head is the total head, that is the static head plus the friction head loss for the design flow rate. The pump to be selected must be able to provide this head (Fig. 18.9).

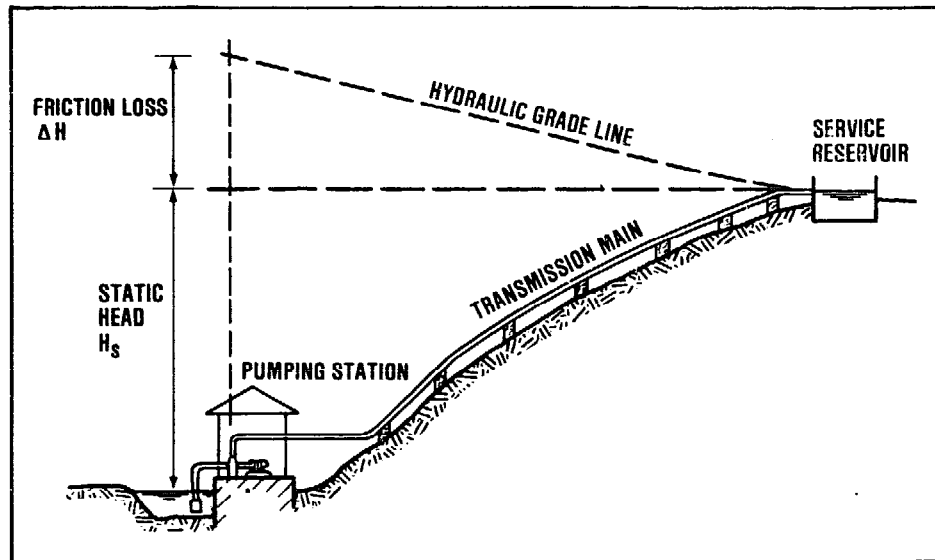

Figure 18.9.
Pumped supply

This calculation should be repeated for several pipe diameters. Each combination of pumping head and pipe diameter would be capable of supplying the required flow rate of water over the required distance, and up to the service reservoir. However, only one pipe diameter will represent the least-cost choice taking into account the initial costs (capital investment) and the energy costs for pumping. The total cost, capitalized, is the basis for selecting the most economical pipe diameter.

For this analysis, the calculated costs for different sizes of pipe are plotted in a graph of which Fig. 18.10 shows an example.

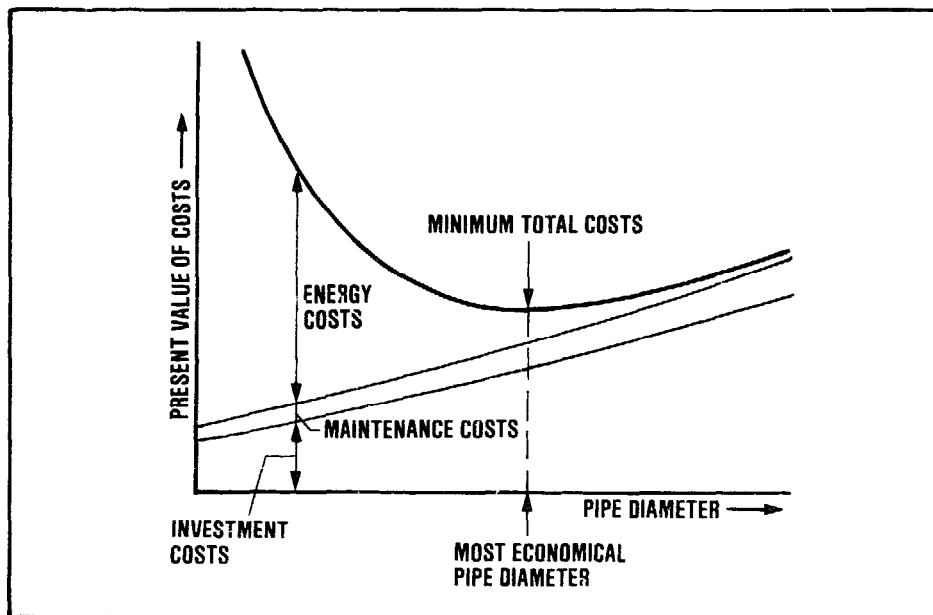

Figure 18.10.
Determination of most economical pipe diameter

The most economical pipe diameter will tend to be large:

- when energy costs are high,
- costs per linear metre of pipe low, and
- capital interest rates low.

For a tentative estimate of the most economical pipe diameter, this diameter may be computed using a velocity of flow of 0.75 m/sec.

Selection of Pumps

Various types of pumps have been mentioned in chapter 10: centrifugal, axial-flow, mixed-flow and reciprocating pumps. The choice of pump will generally depend on its duty in terms of pumping head and capacity.

Pumps with rotating parts have either a horizontal or a vertical axis. The choice between these is generally based on the pump-motor drive arrangement and the site conditions. At a site subject to flooding, the motor and any other electrical equipment must be placed above flood level.

In water transmission for community water supply purposes, it is not unusual that a substantial head is required. This implies that the pumps selected frequently are of the centrifugal (radial-flow) type.

Many waterworks pumps are designed to run (almost) continuously for long periods of time. A high efficiency of a few percent may represent a considerable saving in the running costs over a long period of time. However for rural water supplies, an even more important requirement is that any pumps installed should be reliable.

The pumping head/capacity characteristic of a pump, and its efficiency are indicated in graphs that are supplied by the manufacturers of the pump. Fig. 18.11 shows an example.

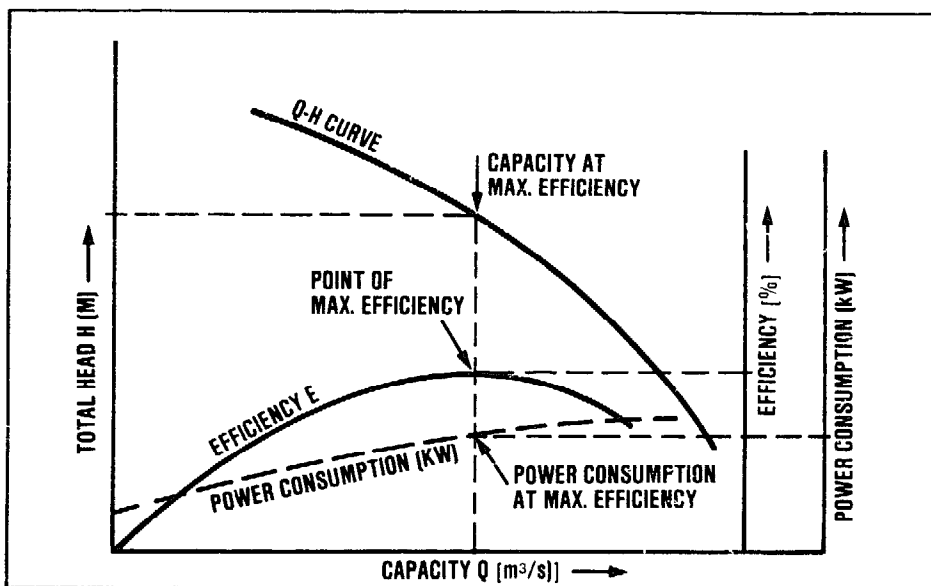

Figure 18.11.
Typical pump characteristic curve

In practice it is seldom possible to have the pump permanently run at its maximum efficiency because the operating point of the pump is determined by both the pumping head and the capacity, and these can vary considerably. The efficiency of small-capacity pumps operating under the conditions of rural areas in developing countries frequently is quite low. A tentative estimate would be in the range of as low as 30% for a 0.4 kilowatt pump, to 60% for a 4 kilowatt pump.

Power Requirements

The power required for driving a pumping unit can be computed with the following formula:

$$N = \frac{\rho \cdot g \cdot Q(H_s + i \cdot L)}{e}$$

Where:

- N = Power required for pumping (Watts)
 Q = Pumping rate (l/sec)
 ρ = Specific weight of water (kg/dm³)
 e = Pumping efficiency (percent)
 H_s = Static head (m)
 i = Head loss under operating conditions.
 (m of head/m of pipe)
 L = Length of pipe (m)

For $g = 9.81 \text{ m/sec}^2$; $\rho = 1 \text{ g/cm}^3$, and e for small-capacity pumps estimated at 50 percent, the above formula can be simplified to:

$$N = 20 Q(H_s + i \cdot L) \text{ Watts}$$

Example

For a water supply, pumping is required at the rate of 110,000 litres per 12 hours. The static head is 26 m, and the length of the pipeline is 450 m. Determine the diameter of the pipeline and the power requirement for pumping.

$$Q = 110,000/12 \times 3,600 = 2.55 \text{ l/sec.}$$

Table 18.2 indicates, that a 50 mm-diameter pipeline might be selected with a head loss of 43 m/km for the 2.55 l/sec design flow rate. The power requirement would be:

$$N = 20 \times 2.55(26 + 0.043 \times 450) = 2.310 \text{ Watts} = 2.3 \text{ Kilowatt}$$

Pump Installtions

Pumping stations may be of the wet-pit type (with submersible pumps or pumps driven by motors placed above the pump in the sump), or of the dry-pit type (pump installed in a pump room). The wet-pit type has the pumps immersed in the water, and the dry-pit type has the pump in a dry room separated from the water by a wall.

For ease of installation, horizontal pumps are sometimes situated above ground level. In that case the pump must be of the self-priming type which is gene-

rally a not so reliable arrangement for rural water supply installations.

Examples of various types of pump installations are shown in Figs. 18.12 and 18.13.

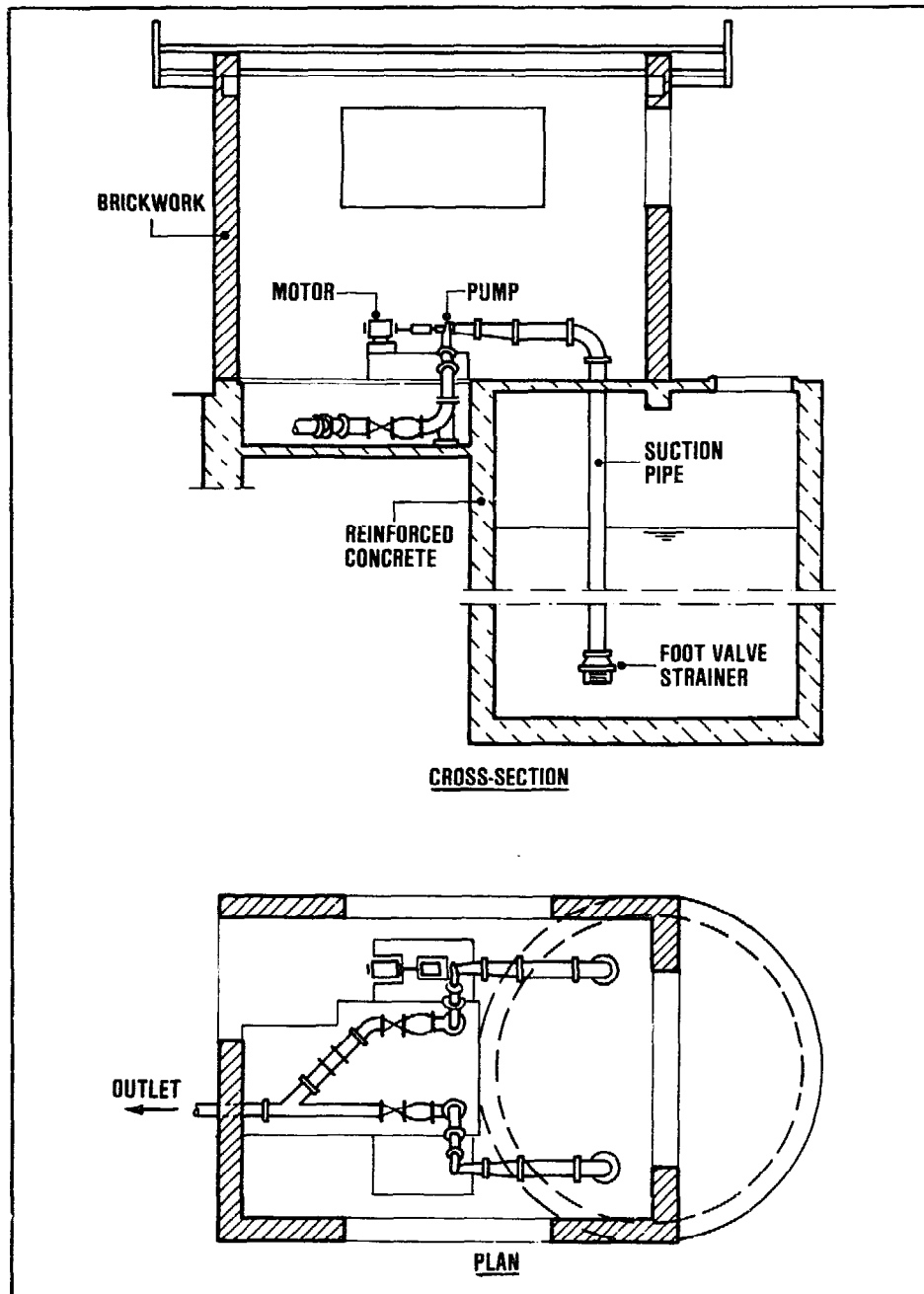

Figure 18.12.
Pumping station with horizontal pumps (self-priming)

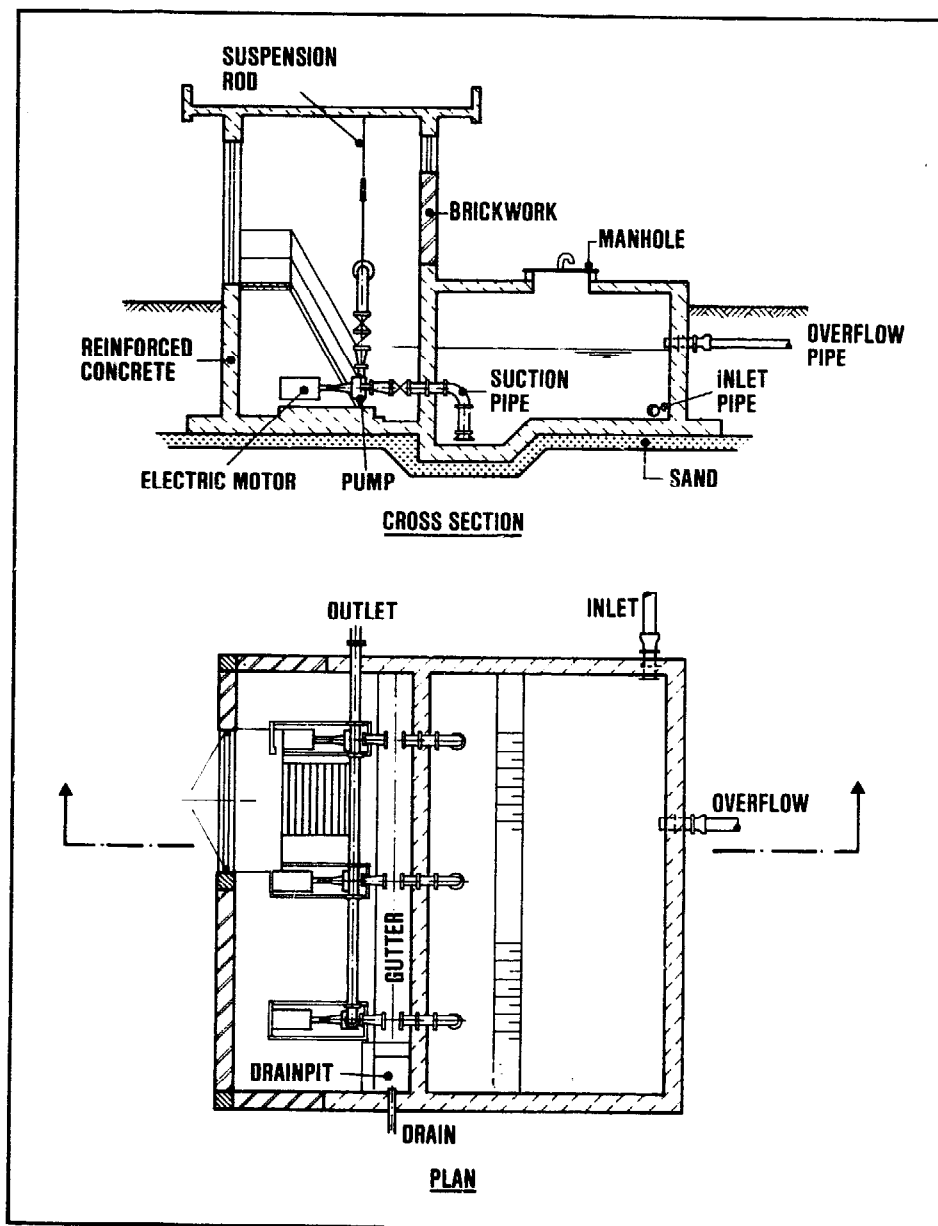

Figure 18.13.
Pumping installation (dry pit)

18.6 Pipe materials

Pipelines frequently represent a considerable investment, and selection of the right type of pipe is important. Pipes are available in various materials, sizes and pressure classes. The most common materials

are cast iron (C.I.), ductile iron, steel, asbestos cement (A.C.), polyvinylchloride (P.V.C.) and high-density polyethylene (P.E.).

Apart from these, indigenous materials such as bamboo sometimes have limited application.

The suitability of any type of pipe in a given situation is influenced by its availability on the market, cost, available diameters and pressure classes, and susceptibility to corrosion or mechanical damage. Although specific conditions will vary from one country to another the following general observations apply in most cases.

Ductile iron and steel are the strongest pipe materials making them the best choice when very high operating pressures are to be expected. However, the costs of fittings, valves, etc. increase rapidly for higher pipe pressure classes and it is, therefore, often advisable to reduce the maximum internal pipe pressure through the provision of a pressure-reducing valve or break-pressure tank. A break-pressure tank is generally more reliable than a pressure-reducing valve.

Asbestos cement may be less suitable for transmission mains because non-authorized tapping of such mains is possible. Moreover, this pipe material may be subject to scale-bursts when tapped without sufficient skill.

Non-authorized tapping of rigid plastic (P.V.C.) mains is also difficult to prevent. Steel and ductile iron pipes are almost impossible to tap without special tools and equipment.

Plastic (P.V.C.; P.E.) pipes are very corrosion resistant. P.V.C., however, suffers a certain loss in strength when exposed to sunlight for long periods of time, and care should be taken to cover P.V.C. pipes when these are stocked in the open.

High-density polyethylene (P.E.) is a very suitable pipe material for small-diameter mains because it can be supplied in rolls (for pipe diameters of 160 mm and less). Thus the number of the necessary joints is greatly reduced. Particularly in cases where rigid pipe materials would necessitate a considerable number of special parts such as elbows and bends the flexible P.E. makes for an ideal pipe material. Polyethylene does not deteriorate when exposed to direct sunlight.

To summarise, for pipelines of small-diameter (less than 150 mm) P.E. and P.V.C. may generally be best. For medium-size pipelines (diameters up to 300 to 400 mm) asbestos cement should be considered. Cast iron, ductile iron and steel are generally only used for large-diameter mains, and also in cases where very high pressures necessitate their use in small diameter pipes.

Table 18.3 lists the comparative characteristics of pipe materials for pipelines.

Table 18.3.
Comparison of pipe materials

Pipe Material	P.V.C. and P.E.	A.C.	C.I. and D.I.		steel	
			unlined	cement lined	unlined	cement lined
1. Cost of pipe	+	+	-	-	-	-
2. Availability of large diameters	-	+ -	+	+	+	+
3. Mechanical strength	+ -	+	++	++	++	++
4. Resistance against bursting when illegally tapped	+	-	++	++	++	++
5. Corrosion resistance	++	+ -	+ -	+	-	+

++: very well suited

+ : well suited

+ -: suitable

- : less suitable

Apart from the sluice ("gate") valves and non-return valves fitted to the pump outlets in the case of a pumped supply, various types of valves and appurtenances are used in the transmission main proper. As the pipeline will normally follow the terrain, provision must be made for the release of trapped air at high points and for flushing out deposits at low points. Air release valves (see Fig. 18.14) should be provided at all high points on the pipeline and may also be required at intermediate positions along long lengths of even gradient. To avoid underpressure, air admission valves may also have to be used. These serve to draw air into the pipeline when the internal pressure falls below a certain level. At the lowest

points of the pipeline, drain or discharge valves must be installed to facilitate emptying or scouring the pipeline.

In long pipelines, sluice valves should be installed to enable sections of the pipeline to be isolated for inspection or repair purposes. Especially when twin mains are used it is advantageous to connect them at intervals. In the event of leakage or pipe burst only one section of such an interconnected twin main needs to be taken out of operation whereas the other sections of that main and the entire other main can still be used. In this way the capacity of the twin main as such is hardly reduced. It should be mentioned that this advantage is obtained at a cost because each connection between the twin mains requires at least five valves.

Sluice valves perform their function either fully opened or completely closed. For pipe diameters of 350 mm and less, a single valve may be used. For larger diameters a small-diameter by-pass with a second valve will be needed because otherwise the closing of the large-diameter valve might prove very difficult. In those cases where the flow of water has to be throttled by means of a valve, butterfly valves should be used. This type of valve may also be used instead of the sluice valves mentioned above but their cost is usually somewhat higher. Fig. 18.15 shows various types of valves.

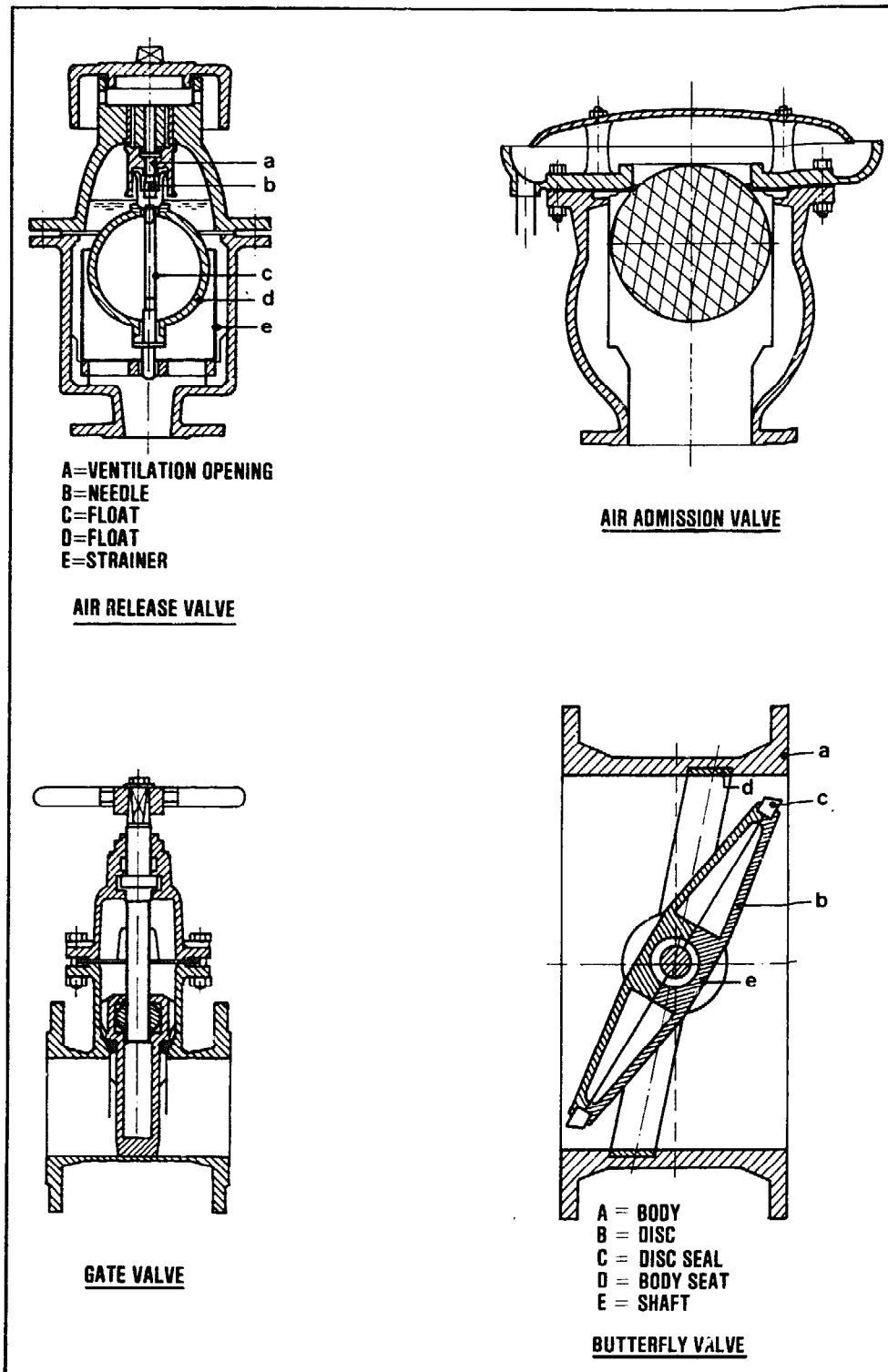

Figure 18.14.
 Various types of valves

Water transmission

Azevedo Netto, J.M.; Alvarez, G.A.
MANUAL DE HIDRAULICA
Edgard Blücher Editor, Sao Paulo, 1975

Bartlett, R.E.
PUMPING STATIONS FOR WATER AND SEWAGE
Applied Science Publishers Ltd., London, 1974

Dominguez, F.J.
CURSO DE HIDRAULICA
G. Gili Editor, Santiago del Chile, 1945

Fair, G.M.; Geyer, J.C.; Okun, D.A.
WATER AND WASTEWATER ENGINEERING (1st Volume)
John Wiley & Sons, New York, 1966

King, H.W.
HANDBOOK OF HYDRAULICS
McGraw-Hill Book Co., New York, 1930

MANUAL OF BRITISH WATER SUPPLY PRACTICE
Institution of Water Engineers, London, 1950

Schlag, A.
HYDRAULIQUE GENERALE ET MECANIQUE DES FLUIDS
Liège, 1930

Trueba Coronel, S.
HIDRAULICA
Mexico, 1955

19. water distribution

19.1 Introduction

The water distribution system (or 'reticulation' system) serves to convey the water drawn from the water source and treated when necessary, to the point where it is delivered to the users. For small community water supplies, the distribution system and any provision for water storage (e.g. service reservoir) should be kept simple. Even so, it may represent a substantial capital investment and the design must be done properly.

Generally, the distribution system of a small community water supply is designed to cater for the domestic and other residential water requirements. Stock watering and garden-plot irrigation water may also be provided.

A community's water demand varies considerably in the course of a day. Water consumption is highest during the hours that water is used for personal hygiene and cleaning, and when food preparation and washing of clothes are done. During the night the water use will be lowest.

Service reservoirs serve to accumulate and store water during the night so that it can be supplied during the daytime hours of high water demand.

It is necessary to maintain a sufficient pressure in the distribution system in order to protect it against contamination by the ingress of polluted seepage water. For small community supplies, a minimum pressure of 6 m head of water should be adequate in most instances.

19.2 Types of distribution systems

There are basically two main types of distribution system:

1. Branched system (Fig. 19.1a)
2. Looped network system (Fig. 19.1b)

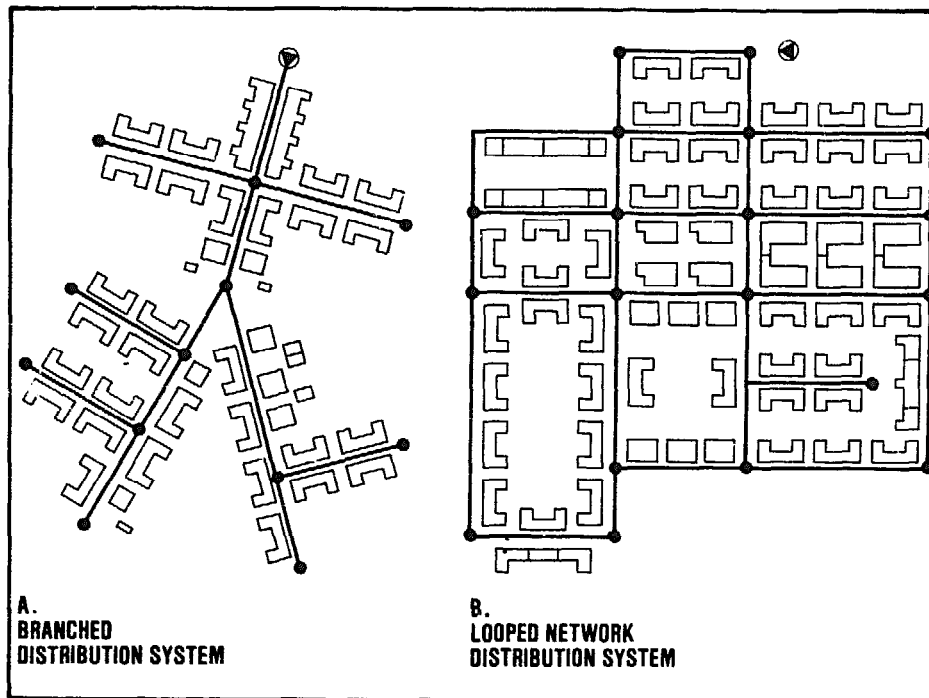

Figure 19.1.
Types of distribution systems

In general, branched systems are only used for small-capacity community supplies delivering the water mostly through public standpipes and having few house connections, if any. For larger distribution systems looped network grids are more common.

Branched systems have the advantage that their design is straight-forward. The direction of the water flow in all pipes and the flow rate can be readily determined. This is not so easy in the looped distribution network (or 'grid') where each secondary pipe can be fed from two sides. This greatly influences the hydraulic design of the distribution network. It is also of major importance in the event that one of the mains is out of operation (e.g. for cleaning, or for repair). A looped network usually has a ring of mains to which the secondary pipes are connected. In large (urban) distribution systems, the secondary pipes are usually all inter-connected which requires many valves and special parts (Fig. 19.2).

For small distribution systems, over-crossing secondary pipes that are not inter-connected may be advantageous with a considerable cost saving (Fig. 19.3).

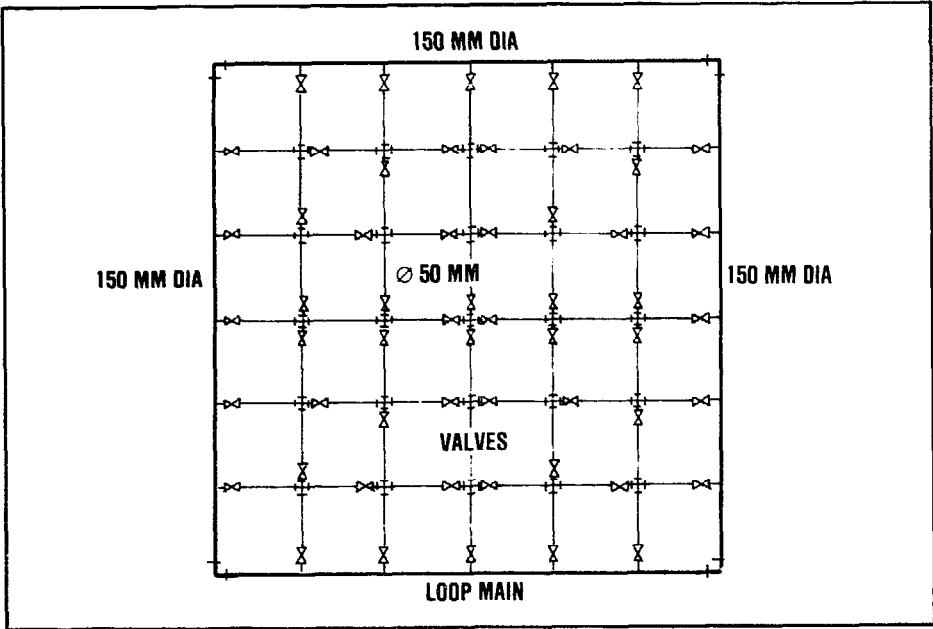

Figure 19.2.
Fully-interconnected pipes.

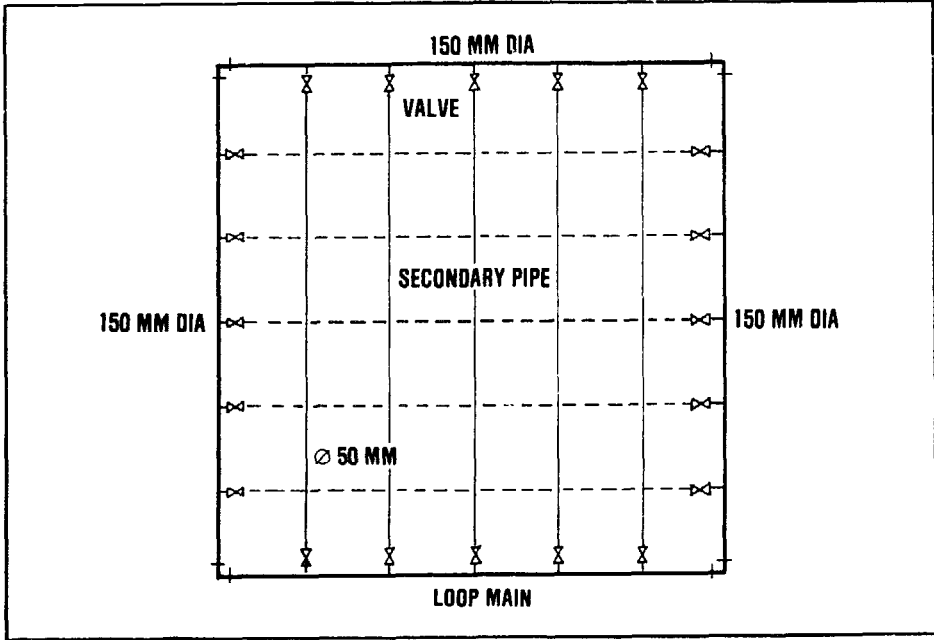

Figure 19.3.
Over-crossing single pipes

The number and type of the points (service connections) at which the water is delivered to the users, have considerable influence on the design of a water distribution system.

The following types of service connections may be distinguished:

- House connection,
- Yard connection*,
- Public standpipe.

A house connection is a water service pipe connected with in-house plumbing to one or more taps, e.g. in the kitchen and bathroom. Usually, 3/8 in (9 mm) and 1/2 in (12 mm) taps are used. A typical layout is shown in Fig. 19.4.

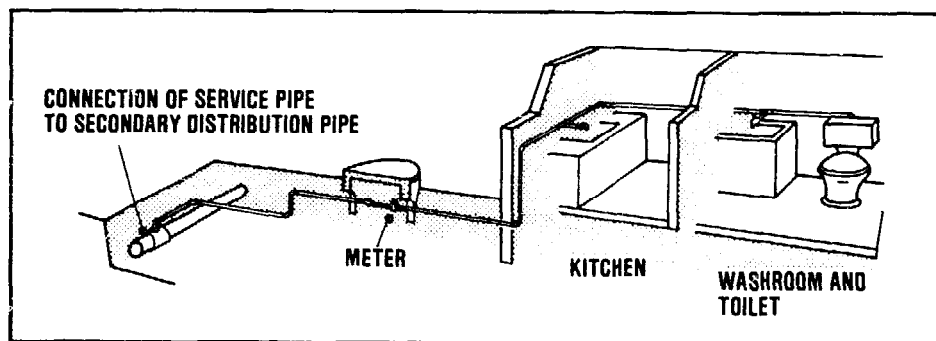

Figure 19.4.
House connection

The service pipe is connected to the distribution main in the street by means of a T-piece (on small-diameter pipes), a special insert piece ("ferrule") or a saddle (on larger-size secondary pipes). A special insert piece is mostly used for cast iron and ductile iron pipes.

A yard connection* is quite similar to a house connection, the only difference being that the tap(s) are placed in the yard outside the house(s). No in-house piping and fixtures are provided (Fig. 19.5).

Plastic pipes (polyvinylchloride or polyethylene), cast iron and galvanised steel pipes are used for both house connections and yard connections.

* Also called: patio connection

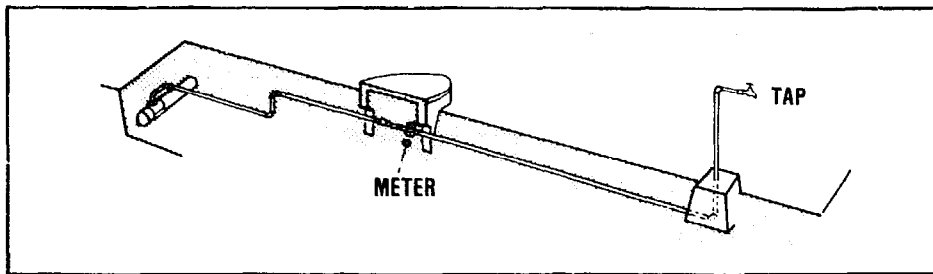

Figure 19.5.
Yard-connection

Public standpipes have long been in use for the distribution of water, and, for reasons of costs and technical feasibility, they will have to continue serving this purpose in many countries, for a long time to come. Each standpipe should be situated at a suitable point within the community area in order to limit the distance the water users have to go to collect their water. The walking distance, for the farthest user of a standpipe should, whenever possible, be limited to 200 m; in sparsely populated rural areas 500 m may be acceptable. The required discharge capacity of a standpipe normally is about 14-18 litres/minute at each outlet. A single-tap standpipe should preferably be used by not more than 40-70 people; a multiple-tap standpipe may provide a reasonable service for up to 250-300 persons; in no case should the number of users dependent on one standpipe exceed 500.

Public standpipes can operate at a low pressure. Distribution systems that serve only standpipes may, therefore, use low-pressure piping. Pipes for distribution systems with house connections generally have to be of a higher pressure class.

Wastage of water from standpipes, especially when users fail to turn off the taps, can be a serious problem. It is also not uncommon for the taps to be damaged by the users. Pilferage sometimes occurs. Poor drainage of spilled water may cause stagnant pools of dirty water with the associated health hazards.

Water fetched at a public standpipe will have to be carried home in a container (bucket, jerrycan, vessel, pot, etc.). This means that the water which was safe at the moment of drawing, may no longer be so at the moment it is used in the house. Water consumption from standpipes generally is not higher than 20 to 30 litres per person per day. The water

use for other purposes than drinking and cooking is likely to be curtailed when the water has to be fetched from a standpipe. Yard and house connections will usually better encourage a more generous water use for personal hygiene and cleaning purposes.

Public standpipes can have one or more taps. Single-tap and double-tap standpipes are the most common types in rural areas. They are made of brickwork, masonry, concrete, or use wooden poles and similar materials. Standpipes may have platforms at different levels, making it easy for adults and children to use them with containers of different sizes. Examples are shown in Fig. 19.6 and 19.7. Public taps drawing from a small reservoir ("cistern") represent an alternative method of water distribution (Fig. 19.8).

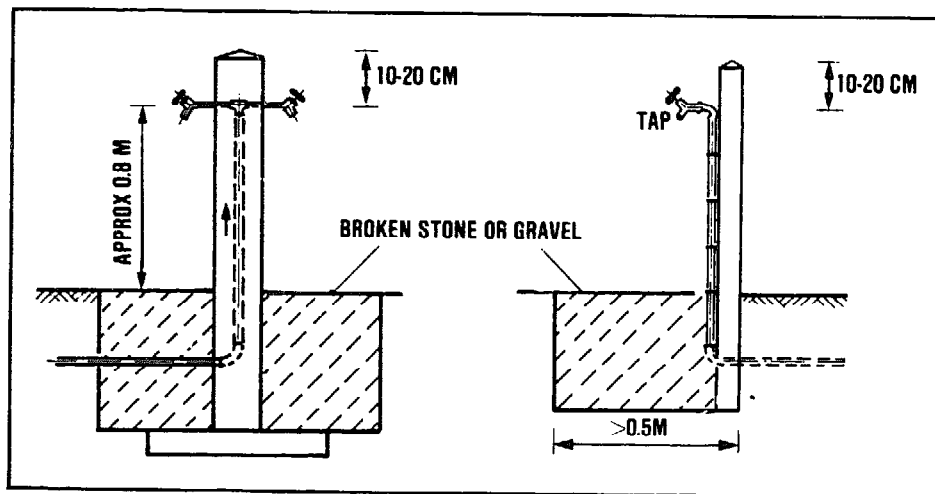

Figure 19.6.
Cross-section of simple standpipes

In spite of their shortcomings, public standpipes are really the only practical option for water distribution at minimum cost to a large number of people who cannot afford the much higher costs of house or yard connections. The housing, in fact, is frequently not suitably constructed to allow the installation of internal plumbing. Furthermore, it would often be impossible for a small community to obtain the substantial capital for a water distribution system with house connections. Also, the costs of adequate disposal of the considerable amounts of waste water generated by a house-connected water supply service would place an additional heavy financial burden on the community. Consequently, public standpipes will

have to be provided and the principal concern should be to lessen their inherent shortcomings as much as possible.

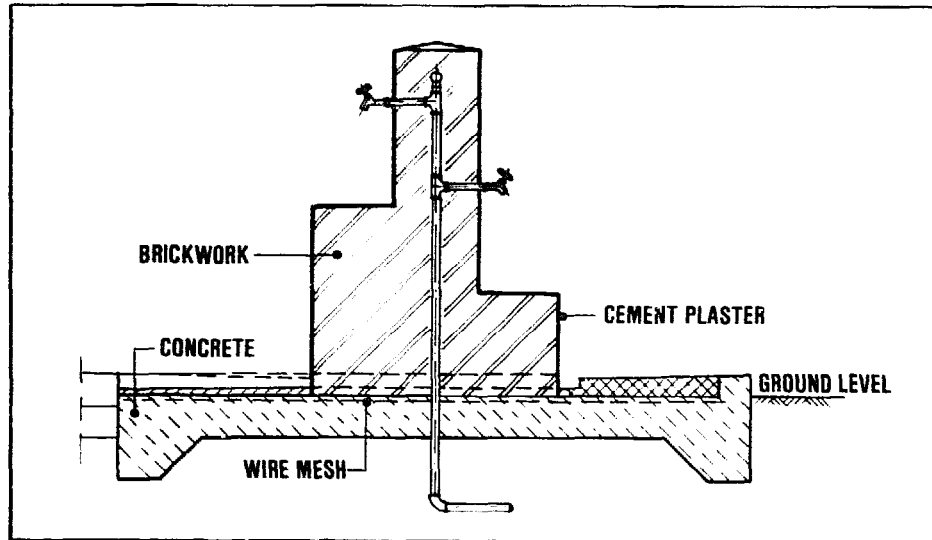

Figure 19.7.
Cross-section of multiple-tap standpipe

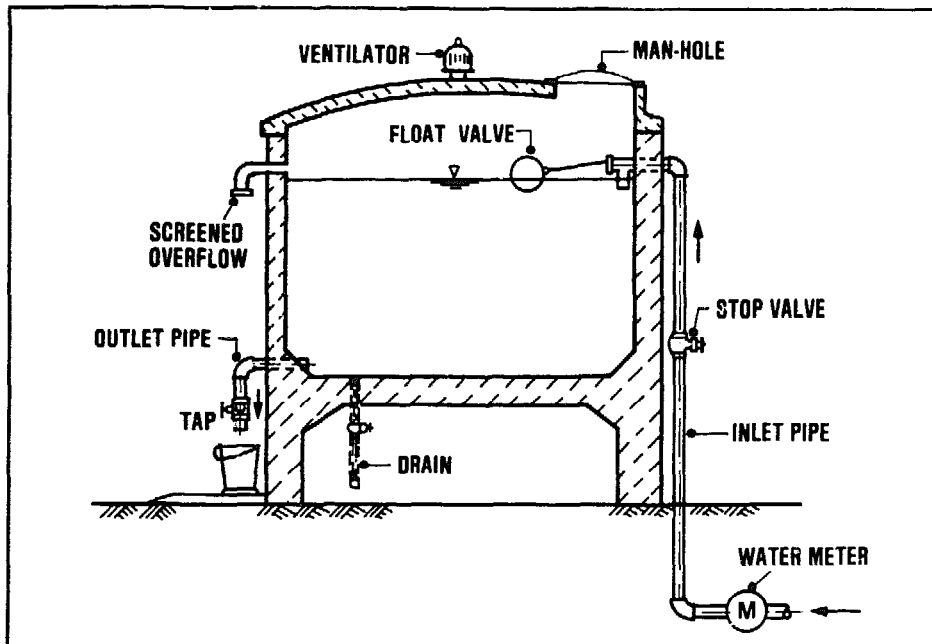
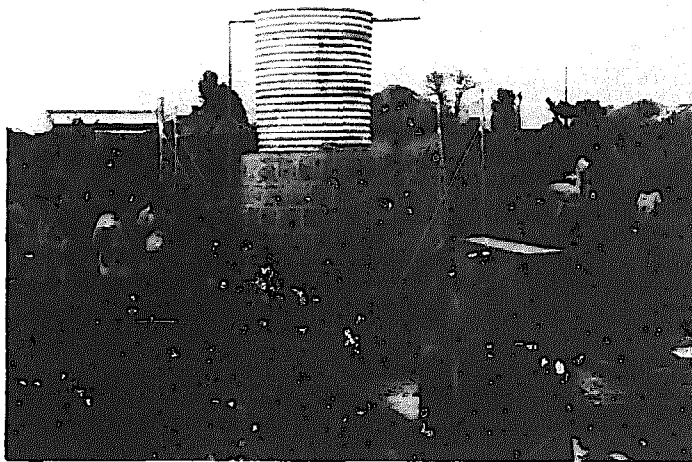

Figure 19.8.
Communal taps supplied from a small reservoir ('Cistern')

Staged Development of Distribution Systems

Experience shows that it is possible to develop a water distribution system in stages, upgrading it in steps when a community's standard of living improves and funds become available. Therefore, when designing a distribution system allowance should be made as much as possible, for its later upgrading. The design engineer has to take into account the higher per capita water demand which is associated with better water supply facilities.

The cost of a water distribution system depends mainly on the total length of pipes installed, and much less on the diameters of these pipes. It is, therefore, generally advantageous to design a distribution system, in any case its major components, directly for the ultimate capacity. This is even so when initially only part of the distribution system is installed for supplying water at a few standpipes. Thus, for a start, fairly wide-spaced standpipes are provided that probably can be supplied from one or a few mains. An elevated reservoir (or tank) will be very useful to obtain a reliable feeding of water to the distribution system, particularly if the water is taken from the water source by pumping.



IRC Photo

Figure 19.9.
Communal standpost supplied from elevated tank (Kenya)

In the next stage, additional standpipes are installed in order to reduce the spacing, and thus the distance the water has to be carried by the users.

This may require the laying of more distribution mains with secondary pipes serving the most densely populated clusters in the community. When this basic level of water service has spread throughout the community, the installation of yard taps and house connections may follow. This will probably be concurrent with the provision of yet more standpipes to improve the service to those users dependent on this type of supply.

The staged development of a distribution system would thus go parallel with the actual growth of water use in a community. It takes into account that in the initial years many of the existing dwellings may not allow the installation of the plumbing and fixtures required for a house connection.

19.3 Design considerations

Water Demand; Peak Factors

The daily water demand in a community area will vary during the year due to seasonal pattern of the climate, the work situation (e.g. harvest time) and other factors such as cultural or religious occasions. The typical figures for domestic water usage and other water requirements as given in Chapter 3, are averages. The maximum daily demand is usually estimated by adding 10 to 30 percent to the average daily demand. Thus, the peak factor for the daily water demand (k_1) is 1.1 to 1.3.

The hourly variation in the water demand during the day is frequently much greater. Generally, two peak periods can be observed, one in the morning and one late in the afternoon (Fig. 19.8). The peak hour demand can be expressed as the average hourly demand multiplied by the hourly peak factor (k_2). For a particular distribution area this factor depends on the size and character of the community served. The hourly peak factor tends to be high for small rural villages, it is usually less for larger communities and small towns. Where roof tanks or other water storage vessels are common, the hourly peak factor will be further reduced. Usually the factor k_2 is chosen in the 1.5 - 2 range.

A water distribution system typically is designed to cater for the maximum hourly demand. This peak hour demand may be computed as $k_1 \times k_2 \times$ average hourly demand.

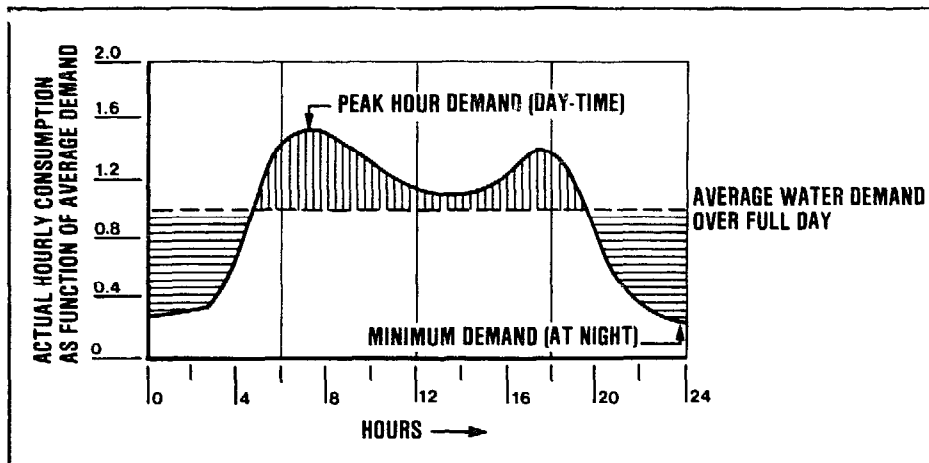

Figure 19.10.
Variation of water demand during the day

Example

For a particular distribution area, the average daily water demand is estimated (using the design figures given in Chapter 3) at 500,000 litres/day.

Q	average day	=	500,000 litres/day
Q	peak day	=	1.2 x 500,000 = 600,000 litres/day
q	Average hour on peak day	=	600,000 : 24 = 25,000 litres/hour
q	peak hour	=	1.8 x 25,000 = 45,000 litres/hour

Storage Reservoir

If there would be no storage of water in the distribution area, the source of supply and the water treatment plant would have to be able to follow all fluctuations of the water demand of the community served. This is generally not economical, and sometimes not even technically feasible.

The design capacities of the various components of a water supply system are usually chosen as indicated in Fig. 19.11.

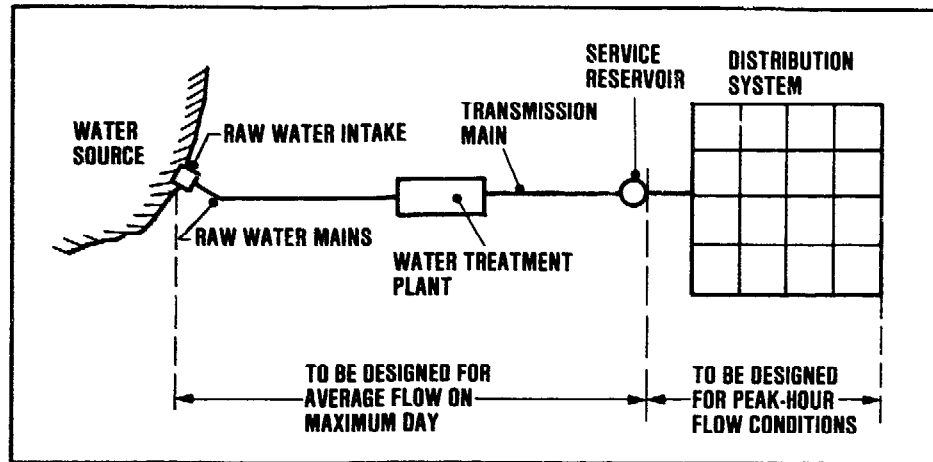

Figure 19.11.
Design capacities for water supply systems components

In summary:

<u>System Component</u>	<u>Design capacity</u>
Water source; raw water main; water treatment plant	peak day water demand
Distribution system	peak hour water demand

The service reservoir is provided to balance the (constant) supply rate from the water source/treatment plant with the fluctuating water demand in the distribution area. The storage volume should be large enough to accommodate the cumulative differences between water supply and demand.

The required storage volume can be determined as follows. The estimated hourly water demand (example given in Fig. 19.10) is expressed as a percentage of the total demand over the peak day and plotted in a cumulative water demand curve (Fig. 19.12). The constant supply rate is then drawn in the same diagram, as a straight line*.

The required volume of storage can now be read from the graph. For a constant-rate supply, 24 hours a day, the required storage is represented by A-A' plus B-B', about 28% of the total peak day demand. If the

* In the example, the supply operates at a constant rate. If the supply rate is not constant, the cumulative quantity of water supplied will be represented by a broken line.

supply capacity is so high that the daily demand can be met with 12 hours pumping a day, the required storage is found to be C-C' plus D-D', about 22% of the total peak day demand.

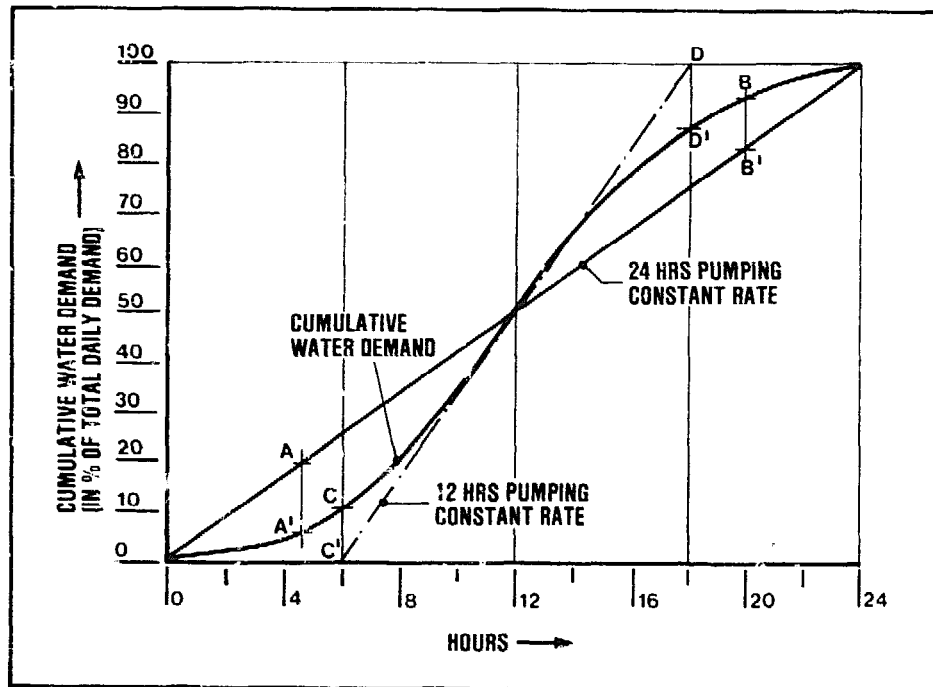

Figure 19.12.
Graphical determination of required storage volume (service reservoir)

A service reservoir with a storage volume of 20 to 40 percent of the peak day water demand should generally be adequate yet a larger reservoir may be called for in situations where any interruption of the water supply would be particularly critical.

The reservoir should be situated as close to the distribution area as possible. It should be situated at a higher elevation than the distribution area. If such a site is available only at some distance, the reservoir should be placed there. Fig. 19.13 shows two possible arrangements.

In flat areas where no suitable hill sites or other high points for ground reservoirs are available, water towers or elevated tanks have to be used. In principle, such towers or tanks should have the same storage volume as a ground reservoir. In practice,

however, water towers and elevated tanks have relatively small volumes because they are much more costly to construct than a ground reservoir.

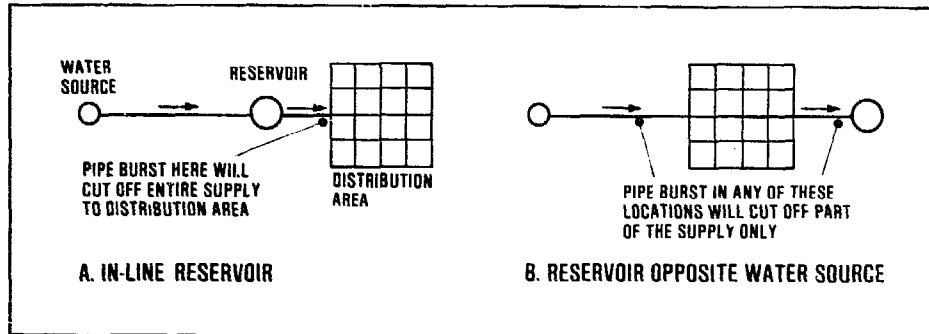

Figure 19.13.
Reservoir siting

Sometimes a combination of a ground reservoir and a pumping station is used (Fig. 19.14). This, however, generally is too complex an arrangement for a small community supply.

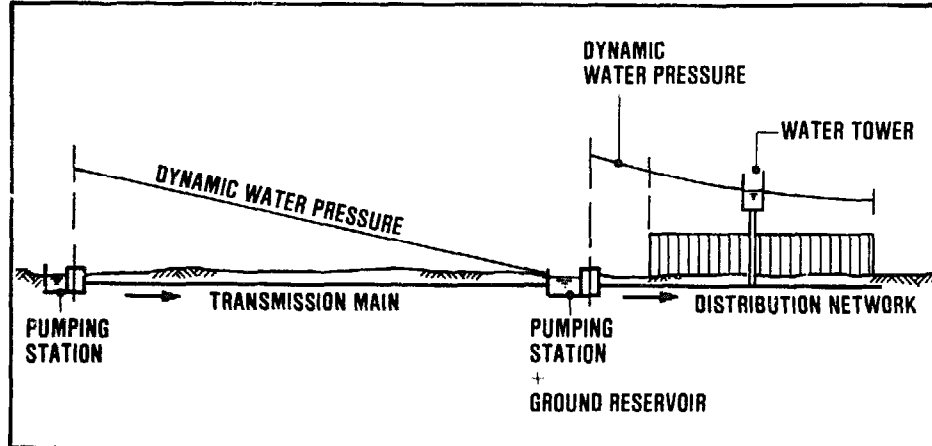

Figure 19.14.
Ground reservoir with pumping station

Ground reservoirs of some size are normally of reinforced concrete; small ones can be made of mass concrete or brick masonry. Elevated reservoirs are of steel, reinforced concrete or brickwork on concrete columns. Steel tanks are mostly placed on a steel or wooden support framework.

Examples of small service reservoirs are shown in Figs. 19.15 and 19.16.

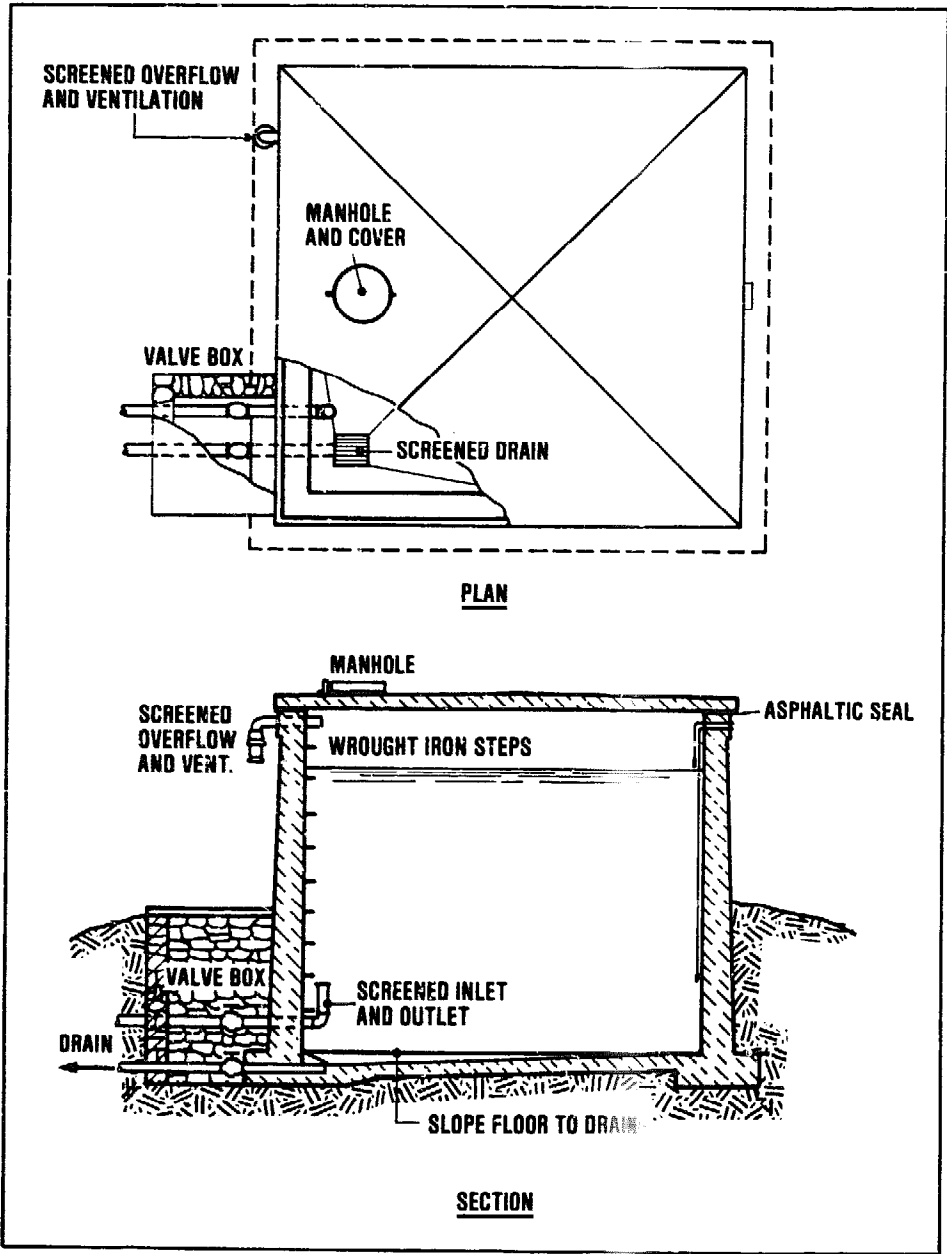

Figure 19.15.
Construction details of small reservoir

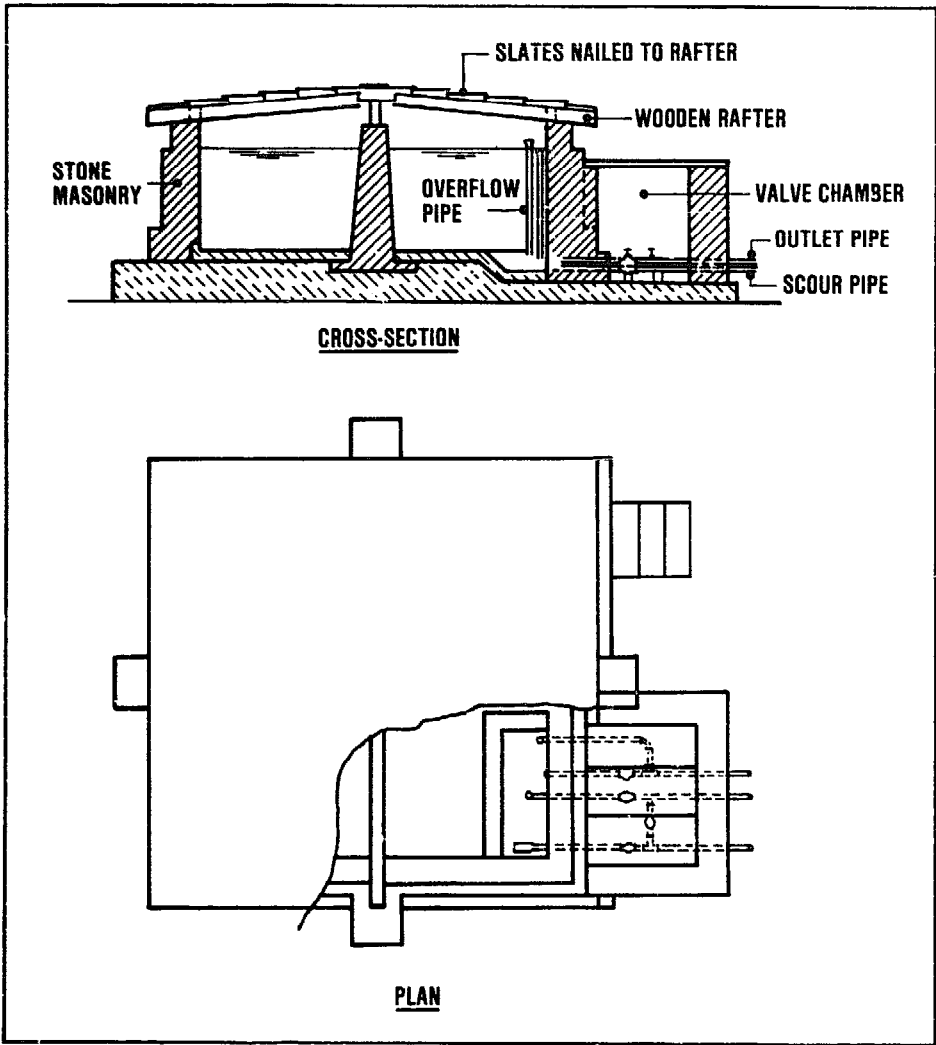

Figure 19.16.
Small service reservoir

An elevated service reservoir (steel tank on brick masonry support) is shown in Fig. 19.17, and Fig. 19.18 features a reinforced brickwork tank supported by masonry walls.

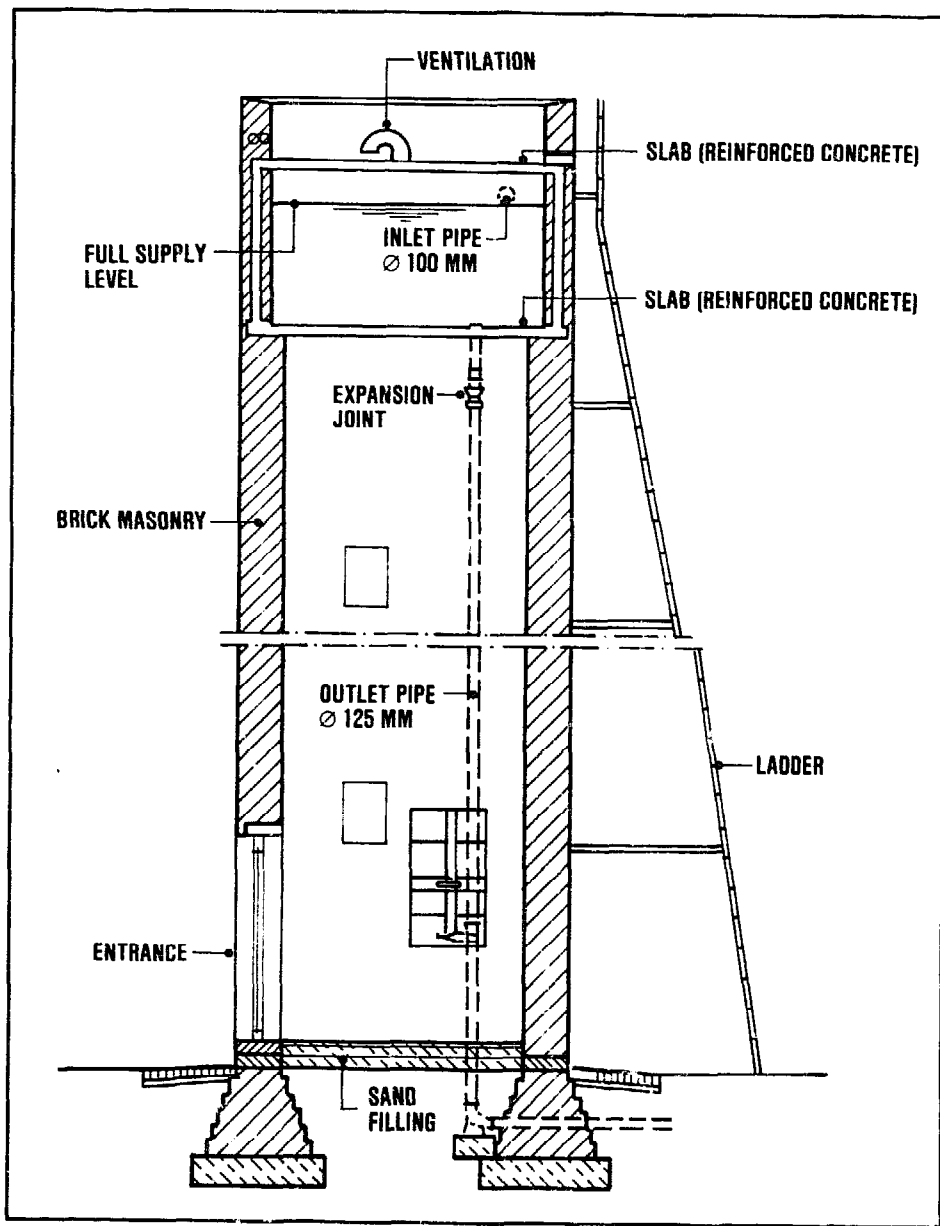

Figure 19.17.
Elevated service reservoir

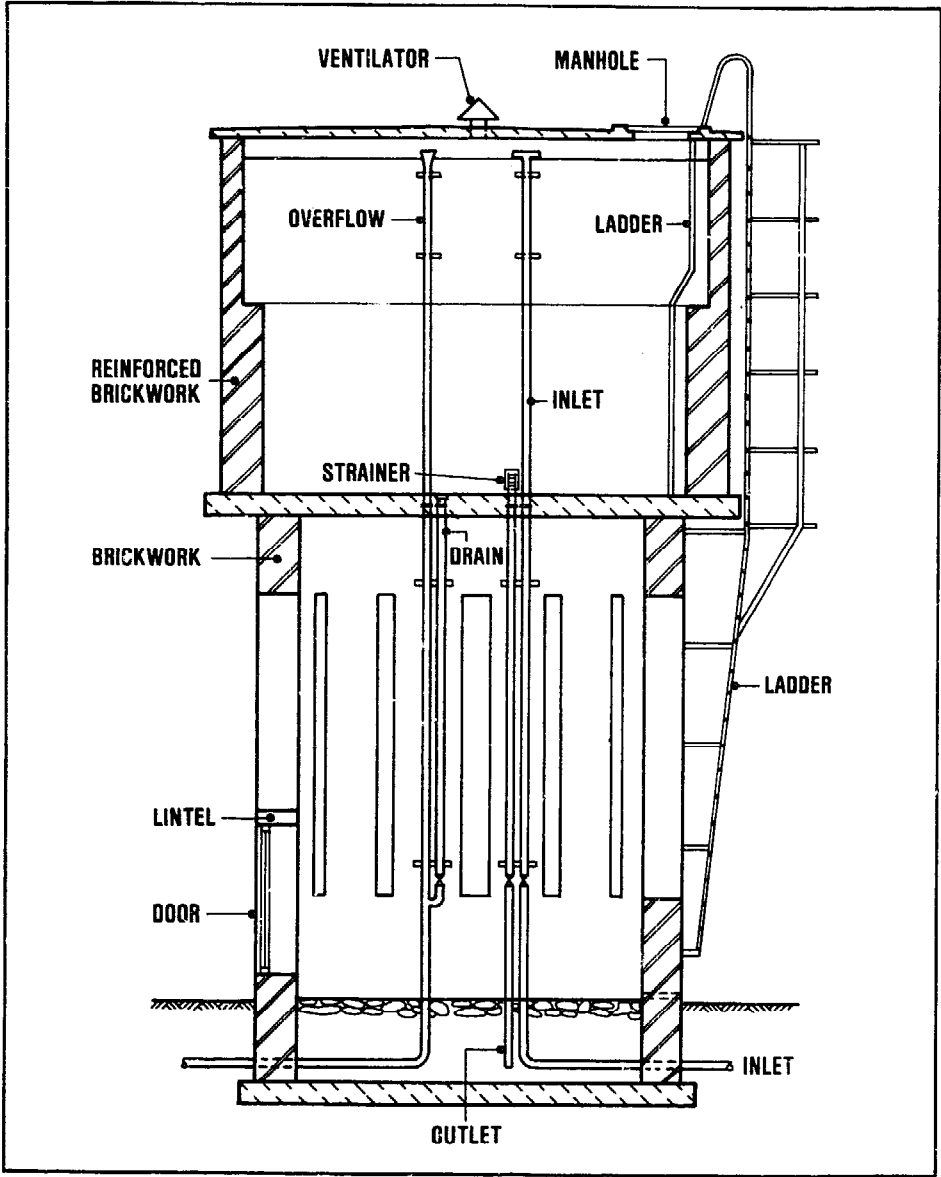

Figure 19.18.
Elevated service reservoir

19.4 Distribution system design

After establishing the general layout of a distribution system and its main components, the distribution area should be divided into a number of sectors according to topography, land use classification and density of population. Boundaries may be drawn along rivers, roads, high points or other features which distinguish each sector. The distribution mains and secondary pipes can then be plotted in the plan.

Once all the sectors are fixed, the population number for each sector can be estimated or computed from any data available. The water demand by sector is then computed using per capita water usage figures for domestic water consumption and selected values for the other, non-domestic water requirements.

Although in practice water will be drawn off at many points along the length of the pipes, it is common engineering practice to assume that all draw-offs are concentrated in the nodal points of the distribution network. The hydraulic calculation is much simplified by this assumption and the errors so introduced are negligible.

Having determined the draw-offs in the nodal points, a flow distribution over the various pipes can be assumed and the required pipe diameters estimated. One way to make the first assumption for the required pipe diameters is to make imaginary sections over the entire distribution network. The total water demand at the downstream end of the section being known, the selected design velocity of flow gives a first estimate of the total cross-sectional area of the pipes that are cut by the imaginary section (Fig. 19.19). The individual pipes can then be so sized that together they would provide the required cross-sectional area.

For the preliminary design of simple distribution systems, a quite simple method may be employed using the water consumption rate per linear metre of distribution pipe. This rate is, of course, greatly influenced by the type of water supply provided: public standpipes, yard taps, house connections, or combinations of these.

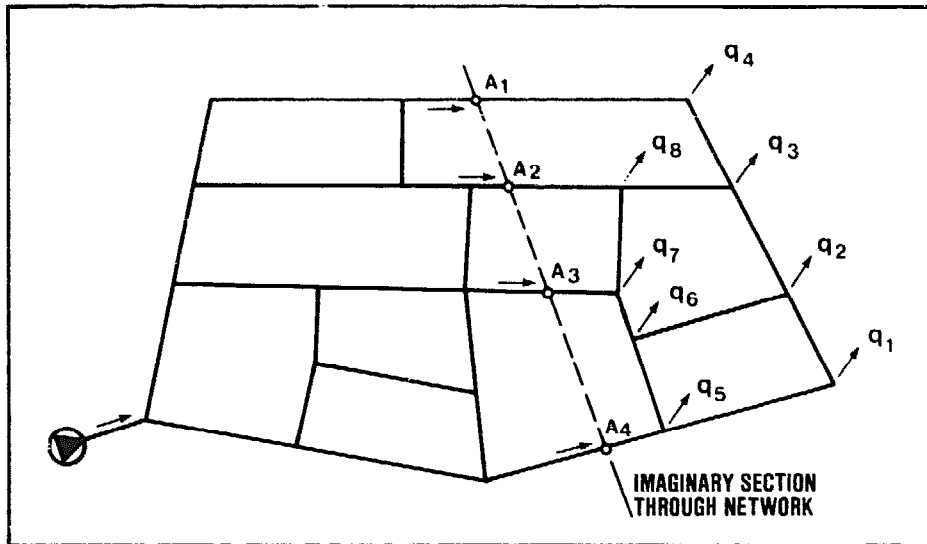

Figure 19.19.
Imaginary section design method

The following example illustrates this simplified design method (Fig. 19.20).

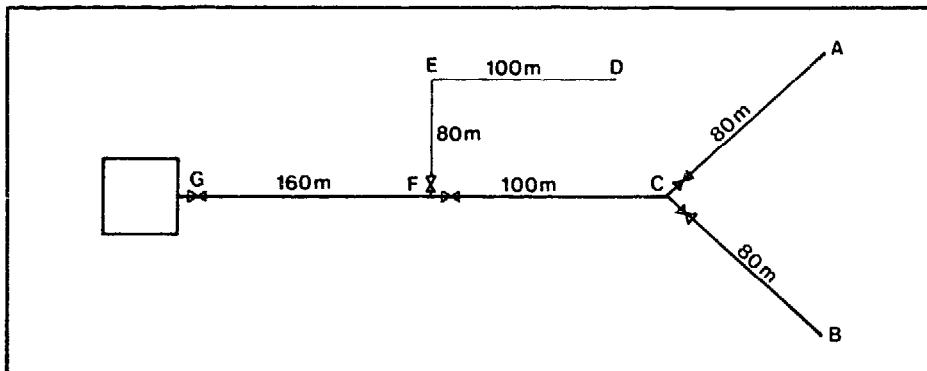

Figure 19.20.
Simple water distribution system (schematic)

Design Data:

Number of persons served	1750
Total length of pipes	600 m
Average daily water use	50 litres/day/person
Daily water demand peak factor (k_1)	1.2
Hourly water demand peak factor (k_2)	1.5

Calculation

Average flow of water carried by distribution system:

$$Q_{av} = 1750 \times 50 = 87.500 \text{ litres/day} = 1.0 \text{ litres/sec.}$$

Peak flow carried by system:

$$Q_{peak} = 1.2 \times 1.5 \times 1.0 = 1.8 \text{ litres/sec.}$$

Water use rate per linear metre of distribution system:

$$q_{unit} = \frac{1.8}{600} = 0.003 \text{ litre/sec. per m}^1$$

Multiplying the cumulative length of pipe, for each individual section, with the unit flow rate gives the tentative design flow from which the pipe diameter can be computed for a selected velocity of flow. The maximum flow carried by plastic pipes is for a design velocity or 0.75 m/sec tabulated in Table 19.1.

Table 19.1.
Maximum carrying capacity of plastic pipes (for $V = 0.75 \text{ m/sec.}$)

Diameter		Max. Flow	Hydraulic Gradient
mm	inches *	l/sec.	m/m ¹
30	1¼	0.6	0.023
40	1½	0.9	0.020
50	2	1.5	0.015
60	2½	2.1	0.011
80	3	3.4	0.009
100	4	6.0	0.007
150	6	13.3	0.004

* approximate

The tentative design calculations are most readily carried out in a tabulated form (Table 19.2).

Table 19.2.
Tentative determination of pipe sizes in distribution system

Sections	Length (m)	Cumulative length (m)	Design Flow (litre/sec)	Pipe Diameter (mm)
A-C	80	80	0.24	30
B-C	80	80	0.24	30
C-F	100	260	0.78	40
D-E	100	100	0.30	30
E-F	80	180	0.54	30
F-G	160	600	1.86	60

Design velocity: 0.75 m/sec.

19.5 Pipe materials

The pipes commonly used in small water distribution systems are of cast iron (C.I.), asbestos cement (A.C.), rigid polyvinylchloride (P.V.C.) and flexible polyethylene (P.E.) plastic. Galvanized steel (G.S.) is sometimes selected because of its resilience, for situations where subsidence of the pipes is expected. Factors influencing the choice of pipe material are: the cost and availability of different types of pipe, the design pressure in the distribution system, the corrosiveness of the water and of the soil in which the pipes are to be laid, and conditions such as traffic overload, proximity to sewer lines, and crowded residential areas.

Cast iron pipes have been, and continue to be used in spite of their high initial cost because they have a long service life and require hardly any maintenance. Cast iron is corrosion resistant even for water that is somewhat corrosive. For more protection a coating may be applied. Asbestos cement pipes are very corrosion resistant, light and easy to handle. They are widely used in sizes up to 300 mm, mainly for secondary pipes and for low-pressure mains.

In soils containing sulphate, asbestos cement pipes are liable to corrosion. Polyvinylchloride pipes have the advantage of easy jointing and their corrosion resistance is good. They can be manufactured in several quality classes to meet the selected design pressure. Galvanised steel is chosen sometimes for situations where high working pressures occur in the distribution system but in small schemes these are usually not needed.

Table 19.3 is provided for ready reference on the available diameters and pressure classes for various types of pipes.

Table 19.3.
Pipe material selection data

Material	Class	Test pressure m of water	Working pressure m of water	Available size (D) range, mm
Cast Iron (C.I.)	A	120	60	50 - 900
	A	180	90	50 - 900
	B	240	120	50 - 900
Asbestos cement (A.C.)	5	50	25	80 - 300
	10	100	50	80 - 300
	15	150	75	80 - 300
Polyvinyl Chloride (P.V.C.)	2.5 kg/cm ²	50	25	90 - 315
	4.0	80	40	50 - 315
	6.0	120	60	40 - 315
	10.0	200	100	16 - 125

Water distribution

Appleyard, J.R.
LEAST-COST DESIGN OF BRANCHED PIPE NETWORK SYSTEMS
Journal of Environmental Engineering Division
American Society of Civil Engineers, 1975 No. 101, EE4

Azevedo Netto, J.M.
LOW-COST DISTRIBUTION SYSTEMS
In: International Training Seminar on Community Water Supply in
Developing Countries (Amsterdam, 1976)
International Reference Centre for Community Water Supply,
The Hague, 1977 (Bulletin No. 10, pp. 258-265)

Babbitt, H.E.; Doland, J.J.; Cleasby, J.L.
WATER SUPPLY ENGINEERING
McGraw-Hill Book, New York, 1962 (6th edition), pp. 319-346

Bonnet, L.
TRAITE PRATIQUE DE DISTRIBUTION DES EAUX
Bordas-Dunod, Paris, 1952.

Ginn, H.N.; Lorey, M.W.; Riddlebrooks, E.J.
DESIGN PARAMETERS FOR RURAL WATER DISTRIBUTION SYSTEMS
Journal Am. Water Works Assoc., New York, 1966

Gomella, C.; Guerrée, H.
LA DISTRIBUTION D'EAU DANS LES AGGLOMERATIONS URBAINS ET RURALES
Editions Eyrolles, Paris, 1970, 4me partie, pp. 177-220

Lauria, D.T.; Kolsky, P.J.; Middleton, R.N.
DESIGN OF LOW-COST WATER DISTRIBUTION SYSTEMS
The World Bank (Energy, Water & Telecommunications Dpt.), 1977
(P.U. Report No. Res. 11)

McJunkin, F.E.; Pineo, C.S.
ROLE OF PLASTIC PIPE IN COMMUNITY WATER SUPPLIES IN DEVELOPING
COUNTRIES
U.S. Agency for International Development, Washington, D.C., 1969

Munizaga Diaz, E.
REDES DE AGUA POTABLE
Ediciones Universidad Catolica, Santiago, 1974

PUBLIC STANDPOST WATER SUPPLIES
International Reference Centre for Community Water Supply,
The Hague, 1980 (Technical Paper No. 13)

Trelles, R.A.; et al
ABASTECIMENTOS DE AGUA POTABLE A COMUNIDADES RURALES
Instituto de Ingenieria Sanitaria, Facultad de Ingenieria
Buenos Aires, 1971, pp. 255-304.

Twort, A.C.; Hoather, R.C.; Law, F.M.
WATER SUPPLY (2nd edition)
Edward Arnold (Publishers) Ltd., London, 1974

annexes

1 sanitary survey

Definition

A sanitary survey is an on-site inspection and evaluation by a qualified person of all the conditions, devices, and practices in the water supply system which pose, or may pose, a danger to the health and well-being of the water consumer. Sanitary surveys may involve all or a part of the water supply system, depending upon their purpose. The importance of a sanitary survey of sources of water cannot be over-emphasised.

No bacteriological or chemical examination, however careful, can take the place of a complete knowledge of the conditions at the sources of supply and throughout the distribution system. Every supply should be regularly inspected from source to outlet by experts, and sampling - particularly for purposes of bacteriological examination - should be repeated under varying climatic conditions, especially after heavy rainfall and after major repair or construction work. It should be emphasised that, when sanitary inspection shows that a water, as distributed, is liable to pollution, it should be condemned irrespective of the results of chemical or bacteriological examination. Contamination is often intermittent and may not be revealed by the chemical or bacteriological examination or a single sample, which can provide information only on the conditions prevailing at the moment of sampling; a satisfactory result cannot guarantee that the conditions found will persist in the future.

With a new supply, the sanitary survey should be carried out in conjunction with the collection of initial engineering data on the suitability of a particular source and its capacity to meet existing and future demands. The sanitary survey should include the detection of all potential sources of pollution of the supply and an assessment of their present and future importance. In the case of an existing supply, a sanitary survey should be carried out as often as required for the control of pollution hazards and the maintenance of the quality of the water.

It is considered that the responsibility of the surveillance authority goes beyond that of merely pronouncing that water as delivered satisfies, or fails to satisfy, a certain quality standard. Surveillance should include the giving of advice on how defects can be removed and quality improved; this, in turn, implies a knowledge of the water supply system, including the treatment processes, and close liaison with the laboratory workers and water supply operators concerned.

When to carry out a sanitary survey

Sanitary surveys should be undertaken:

- (1) When developing new sources of water and in sufficient detail to determine, first, the suitability of the source and, second, the degree of treatment required before the raw water can be considered suitable for human consumption. No new public water supply should be approved without a sanitary survey by, or approved by, an agency with surveillance responsibility.
- (2) When laboratory analyses of a sample taken from the water system indicate a hazard to health, a survey should be begun immediately to identify source(s) of contamination. First attention should be given to the most common causes of contamination, e.g. failure of chlorination.
- (3) When an outbreak of a waterborne disease occurs in or near the area served by the water supply.
- (4) When interpreting bacteriological, chemical, and physical analyses of water samples.
- (5) When any significant change is noted that may affect the water system, e.g. construction of a new industry on the watershed.

The above sanitary surveys are undertaken once only or at irregular intervals.

- (6) Sanitary surveys should also be undertaken on a regular basis. Their frequency and timing will depend on system size and available staff and resources. Treatment plant operators should make their own regular sanitary surveys and note them in the plant logbook. The ideal for the surveillance agency would be to visit each plant at least annually.

Water from large systems affects more people; yet, smaller systems often have proportionately more hazards. Nevertheless, the larger systems should be inspected more frequently because of their larger population at risk and greater cost-effectiveness of surveillance. The smaller systems should also be surveyed, but with realistic frequency. Rural areas offer a special problem with regard to sanitary surveys, principally the physical and economic impossibility of surveying innumerable small water suppliers. Efforts by surveillance agencies must focus primarily on encouragement and stimulation of individuals and community groups to make their own improvements; to provide information

on proven techniques; and to provide technical assistance in site selection, design, and construction. Demonstration of proper practice rather than mere condemnation of the improper is to be sought.

Qualifications of surveyors

The professional judgement and competence of the survey officer ultimately determine the reliability of the data and information collected. Routine external surveillance is generally provided by sanitarians and public health inspectors who are not fully trained in the engineering disciplines related to water supply facilities. Observation of numerous programs indicates that successful surveillance programs can be operated using, under close and qualified supervision, secondary school graduates with one-to-two years' technical instruction and on-the-job training experience. Technical assistance should be available to these inspectors, if needed. Larger or more complex systems should be surveyed by senior staff.

The lack of adequate numbers of qualified personnel should not be taken as an excuse for inaction but as a challenge to establish appropriate training programs. Technical assistance and fellowships are available through several international organizations and other agencies.

Most routine sanitary surveys must be made by plant operators. This may necessitate additional operator training. The principal operator should accompany the survey officer during his inspection, not only to remedy any defects uncovered but the survey should also be considered as a training session. In addition to explaining the "why" of various survey activities and of treatment processes, the operator should be shown, where applicable, proper methods for selection of sampling points, for taking of samples for bacterial and chemical analysis, and measurement of residual chlorine.

An absolute minimum requirement for any system, regardless of size, is that some one individual must be designated as responsible for operation of the system; this individual or his designee must be locatable ("on call") at any time during which a system using surface sources and disinfection is in operation; and, for systems employing chlorination, the principal operator must have on hand devices or equipment for measurement of residual chlorine and be competent in their use, including the indicated adjustments in chlorine dosing rates.

Reliability of the water system during both normal and emergency operation, proper maintenance, and design features build in continuity of operation. Examples include provision of two or more wells for systems with groundwater source, standby power source or provision of elevated storage, and valving of the distribution system to allow partial shutdowns for repairs.

Report forms and records

A considerable aid to both surveillance agency personnel and to water supply operators has been the preparation of printed guidelines, checklists, and forms for undertaking sanitary surveys. These are often mimeographed on inexpensive paper in the national language. Several of the publications listed in the references offer excellent guidance in this respect. In addition to their educational value and their utility as checklists, these forms become part of the permanent record and, as such, as useful for enforcement and follow-up actions.

The report must spell out clearly and unequivocally the recommendations made, the actions which must be taken, and deadlines for action. Any confusion between "suggested" or "desirable" and mandatory action must be avoided.

Sampling and monitoring

Purpose

Samples are taken from drinking water systems to determine if the water supplied is safe for human consumption. In as much as it is impossible to analyze all of the water, the small portion or sample must be representative of the larger quantity being used. If the sample is carelessly taken or taken from locations not truly representative of the system, then the purpose of sampling is thwarted. Such sampling may even be dangerous through its creation of a false sense of security.

One sample from a water system is of limited value. Long records of multiple samples are desirable.

Sampling Frequency and Number

Sampling frequency for public water supplies has traditionally been based on a minimum monthly number keyed to the population served by a given water supply, thus requiring fewer bacteriological samples from smaller supplies. However, the frequency of sampling should also take into account the

past frequency of unsatisfactory samples; the quality of raw water treated, the number of raw water sources, adequacy and capacity of treatment, the risks of contamination at the sources; and, in the distribution system, the complexity and size of the distribution system, the dangers of epidemics arising, for example, at international ports or pilgrimage centres, and the application of chlorination.

Superficially, chlorination might imply that less sampling is needed. However, field studies in developing countries indicate that chlorination of water supplies is often not practiced in smaller water supplies with naturally protected sources; for example, deep wells. Rather, chlorination is practiced in water supply systems with actual or potential contamination of source or distribution where failure of the chlorination system could result in a serious hazard to the health of the population served. Thus, constant checks on chlorine residual concentration and bacterial quality are needed to ensure that immediate remedial action can be taken, should suspect water enter the distribution system.

Because of the many variables outlined above and the wide range in resources available for surveillance, no universally applicable sampling frequency is possible. In principle, bacteriological examination of chlorinated water should be done daily. This is feasible in the largest supplies; but, in the smaller supplies serving a population of 10,000 or less, daily bacteriological sampling may be impracticable, and reliance may have to be placed on bacteriological analyses at weekly or monthly intervals. In the smallest supplies, total reliance may have to be placed on sanitary surveys and, where chlorination is practiced, frequent determination of chlorine residual concentration.

Guideline recommendations for sample numbers and frequency have been published by WHO in the International Standards for Drinking Water. The actual number and frequency of sampling must be decided by the surveillance agency and must take local conditions into account. The criteria or standards adopted for local use must be clearly spelled out, distributed in writing to appropriate surveillance and waterworks staff, and above all must be attainable for the type and size water supplies specified. Field studies in developing countries indicate widespread use "on paper" of sampling numbers and frequencies adopted in the United States, the United Kingdom, and elsewhere; in actuality, with the exception of a few capital cities, there is little adherence to the standard.

Location of Sampling Points

The samples should not be taken from the same point on each occasion but should be rotated through other areas of zones

of the distribution system. A common habit which may yield misleading results is the collection of samples from the same points month after month, typically, the laboratory tap at the municipal building, the police station, or the residence of a waterworks employee.

A majority of the bacteriological and chlorine residual samples should be taken in known problem areas; for example, from areas with poor results in the past, low pressure zones, areas with high leakage, densely populated areas with inadequate sewerage, open or unprotected service reservoirs, dead-ends on pipelines, and areas on the periphery of the system most distant from the treatment works.

Many urban areas use water from several sources, often three or four, and sometimes 20 or more. Location of sampling points in the distribution system should ensure that water from each source is periodically sampled. Greater frequency should be given to the sources serving larger populations, surface water sources, sources serving older distribution systems, and sources with known water quality problems in the past.

A common method of water distribution in many large cities is by use of tank trucks or "tankers". In some cities, over half the population may receive their drinking water by this means. The watering stations where the tank trucks are filled should be periodically sampled; and the water, as distributed from the trucks, should also be randomly sampled without warning to the driver-purveyor.

Sample Collection

Sample collectors must be instructed in sampling procedures including:

1. Location of point of sampling as described above. Sub-professionals should be specifically instructed as to sampling sites.
2. The use and purpose of dechlorinating compounds such as sodium thiosulphate added to the sample bottle.
3. Measurement of OT, OTA, or DPD residual chlorine. These tests must be performed immediately upon taking of the sample.
4. Proper procedures for collection of samples to ensure that they are representative and that, for bacteriological samples, the sterility of the sample bottle is maintained. Where samples are repeatedly contaminated by the collectors, a complacent attitude may develop with regard to samples showing positive for coliforms.

2 well drilling methods

Introduction

The most modern and expensive well drilling rig and tools is not necessarily the best equipment with which to drill a well, although the manufacturers sales brochure may say otherwise. Well drilling belongs to that small group of engineering activities which is so influenced by local factors and perhaps unknown underground conditions that there is rarely a location which invites the application of a precise method of drilling and well construction.

To the inexperienced observer an old cable-tool rig pounding away all day with crude looking tools and unsophisticated machinery may appear to be a retrograde approach but it may well have been this very characteristic of simplicity which dictated the choice of method.

There is no ideal all-purpose drilling rig or system of drilling. If one examines the statistics of the Northern American drilling scene where three quarters of a million water wells were put down by some nine thousand contractors in one year (1978), the strong trend towards rotary drilling is immediately obvious. It will also be appreciated that communications in the U.S.A. and Canada are generally excellent allowing the rapid movement of spare parts and skilled service engineers; in these countries hydrogeological data are in many instances readily available; and high labour costs and keen competition demand a rapid rate of drilling.

In developing countries with limited finance, well drilling in remote areas with largely unskilled labour and a minimum of support, must consider carefully the degree of sophistication which can be tolerated. Yet another set of conditions prevail in Western Europe where the emphasis is on relatively few wells of large diameter installed with high-output pumps delivering water through a wide supply network over distribution areas of considerable size.

Before moving on to describe the various methods of well drilling it must be mentioned that there is some variation between the names given to certain tools in English speaking countries. Where possible, the most common terms are used and occasionally an alternative will be quoted in brackets. Some drilling contractors call themselves 'well borers', others 'drillers'. The terms 'casing', 'tubing' or 'lining' a well should be self

explanatory, but some confusion sometimes arises over the words 'well' and 'borehole'. Generally speaking they refer to the same thing, although the purists may insist that a well is hand-sunk and a borehole is machine-drilled.

Cable-tool (percussion) driller

Cable tool percussion drilling is a very old method; it was already used more than 1,000 years ago in China. The method basically has not changed, but the tools have been vastly improved. It is practicable for drilling both small and large holes, to depths as great as 300-500 m. Cable-tool percussion drilling uses relatively inexpensive equipment. Its greatest disadvantage is that it is a very slow method. This forms a limitation of its use in developing countries, where often a large number of wells need to be drilled as quickly as possible.

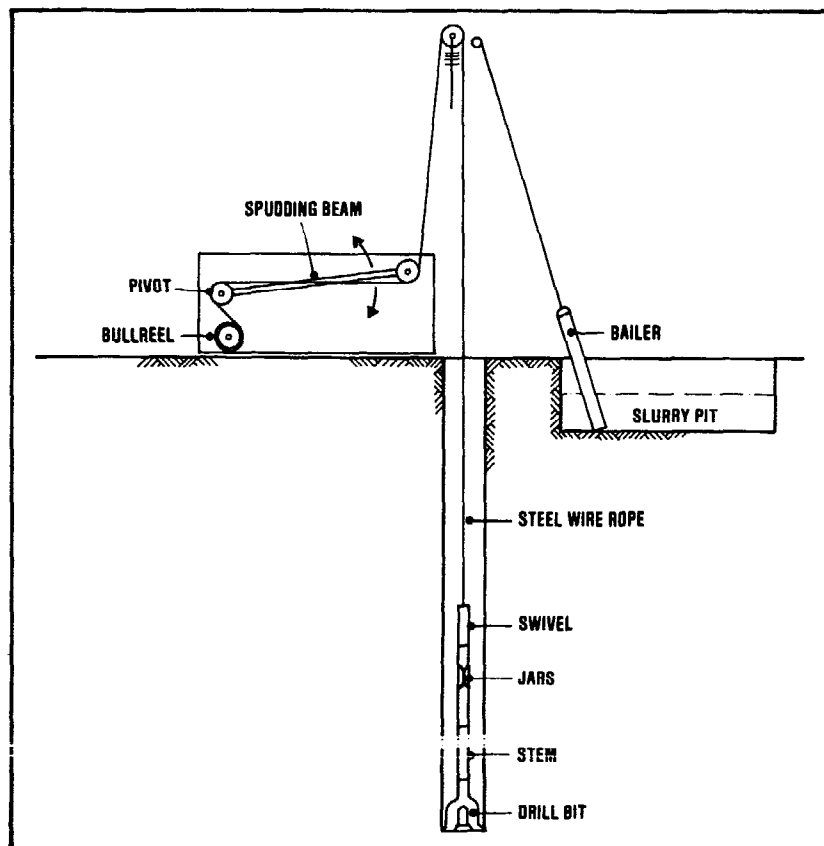

Figure 1
Cable tool or percussion drilling rig

In cable tool percussion drilling, a heavy drill bit is lifted and dropped to crush the rock, and thus work its way down into the formation. A string of tools is suspended on a steel wire rope which is passed over a rubber-cushioned crown sheave at the top of the drill rig and down under a spudding sheave at the end of a beam. It then passes up and over a heel sheave to coil in storage on a braked drum known as the bull reel or main reel (Fig. 1).

A connecting rod transmits motion from a variable stroke crank to the free end of the beam which itself imparts a reciprocating action to the rope and suspended tools.

The string of tools consists of a drill bit (chisel) surmounted by a drill stem (sinker bar), perhaps drilling jars, then a swivel rope socket containing a mandrel into which is secured the wire rope (Fig. 2).

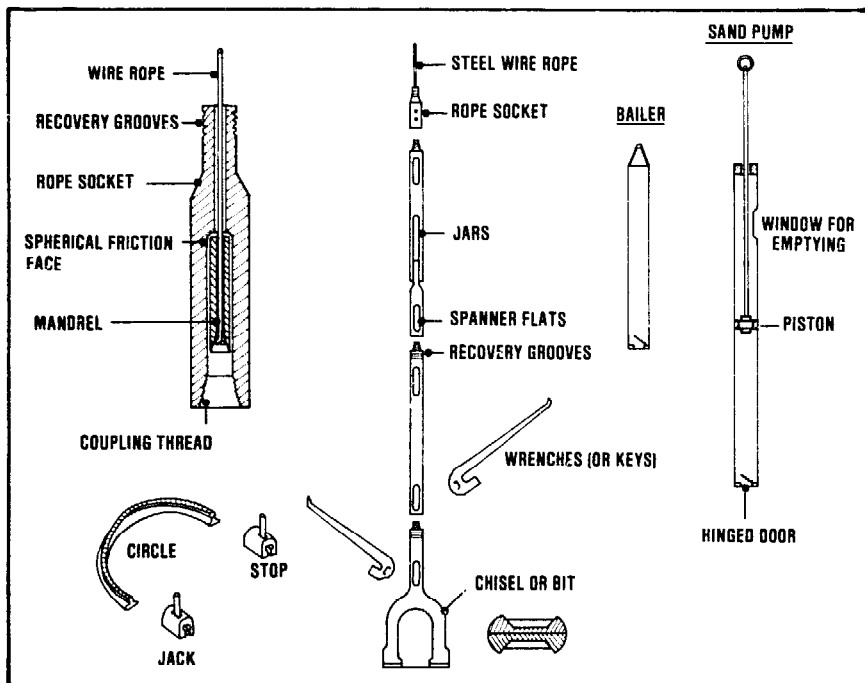

Figure 2
Percussion tools

Bits are forged from high-carbon steel and are required to penetrate, crush, mix and ream. Bits for hard formations have a blunt angle of penetration, a large cross-sectional area (to give strength), and have small 'flutes' or waterways in the sides; bits for a soft clay stratum have a sharp edge, generous clearance angles,

and large waterways coupled with a small area to allow rapid reciprocation through a viscous slurry.

Originally nearly all cable-tool rigs were equipped with a blower to provide air to a forge for bit sharpening and reforming, but most outfits are now equipped with portable electric welding plants with which a moderately hard build-up can be applied to the working face.

The drill stem is located above the bit to provide weight plus directional stability. Also, by its pumping action, it moves the cuttings upwards, away from the bit.

Drilling jars must be fitted above the stem when there exists the risk of pieces of rock falling in and trapping the tools in the hole; they are for the purpose of jarring tools which are stuck out of the hole. Jars in no way aid the drilling function; rather they add to the list of mechanical weakness points and for this reason are often omitted by the driller when prudence should have prompted their inclusion. They are in effect sliding links giving some 150 mm of free vertical movement, designed so as to be of a diameter only a little larger than the stem. They are usually operated by exerting a powerful continuous pull on the cable and tools that are stuck. At the same time a coaxial weight (called a jar bumper) is run down the drilling cable. A blow on the top of the rope socket momentarily closes the jars which snap back smartly to give a positive upward blow.

The topmost item in the tool string is the swivel rope socket. This has the dual function of attaching the wire rope (drilling line) to the tools and imparting a continuous rotation. Inside the socket is a mandrel into which the drilling line is secured. The top shoulder of the mandrel consists of a smooth, hardened surface which is located inside the rope socket and it carries the full weight of the tool string.

The drilling line is of non-performed, left-hand lay, steel wire rope. When drilling begins, the weight of tool unwinds the rope with a clockwise rotation and transmits this torque through the socket/mandrel face to the tools, countering any tendency for the right-handed tool joints to unscrew. The tools thus slowly begin rotating, moving the bit to a new position on each stroke and ensuring a circular well.

Depending on several factors, such as viscosity of cuttings, tautness of line, weight of tools, etc., the drilling line eventually resists this unwinding process and returns to its natural 'lay', and it does this by momentarily breaking the friction between mandrel and

socket. This occurs during each stroke or as infrequently as 60 or more strokes at greater depths. The slowly rotating mass of tools is, of course, unaffected by this sudden line reversal, which is felt by the driller with his hand on the line.

There is now a column of tools weighing between 300 and 4,000 kg reciprocating at 40-80 times per minute at a stroke of between 1.2 and 0.4 m, and slowly rotating. At this stage the driller makes two vital adjustments to his rig controls; firstly, the blows per minute are set so that the tool string is just-and only-just-able to keep up with the motion imparted to it by the reciprocating spudding beam without causing a violent snatch in the drilling line, and secondly the drilling line is paid off the bull reel until the bit just reaches out and gives a sharp, clean blow to the bottom of the well. The reaching-out and rapid withdrawal are assisted by the rubber-cushioned crown sheave and, especially at depth, the natural spring in the drilling line.

The above two settings are absolutely critical and leave little margin for error. Too slow a rate and the bit will make little progress, too fast a rate and the rig will be seriously damaged; too slack a line invites verticality problems and poor progress; too tight a line produces a vertical hole but little footage and the swivel may not function, thus halting rotation of the tool.

Water is fed to the well in small quantities until such time as a natural supply is reached. The purpose of the water is to produce slurry out of the cuttings and to suspend this material above and away from the bit face. Lesser functions are to cool and lubricate the tool string.

With the tools correctly striking the bottom of the hole, the depth of the well will increase and this will alter the two critical settings just discussed.

The driller then adjusts the secondary or 'fine' control on the brake of the bull reel until the reel begins to creep round and so pay off a fraction of drilling line at every stroke.

The drilling rig is now in operation and, assuming no change of stratum, will continue until the driller feels, literally, that the thickening slurry is retarding the tools. He will then either slow the rig blows to keep in step with them for a while, or he will clean the hole out, an inevitable operation sooner or later.

A bailer (or shell) is used for this purpose (Fig. 2). The tools are withdrawn and the bailer is run into the well on a separate line called the sand line. The bailer consists of a steel tube with a hinged door or clack on the bottom. The slurry fills the bailer and is hoisted to the surface and tipped into the slurry pit (Fig. 1), the operation being repeated until the hole is clean.

When drilling hard rock the driller may leave a little slurry in the hole so that the rock chips are in suspension. He may even introduce a little clay for this purpose.

A sand pump (Fig. 2) is similar to a bailer but incorporates a piston within the tube and the piston rod is attached to the sand line. When lowered in the extended position, the tube comes to rest on the bottom of the hole. Further lowering allows the piston to travel to the bottom of its stroke with its disc valve open. Rapid withdrawal draws the piston with closed valve up the tube which sucks slurry through the bottom door. At the top of the stroke the piston reaches its retainer and lifts the complete sand pump to the surface.

When drilling begins, a short guide tube or conductor pipe is always drilled or hand-sunk into the ground. This tube is essential to stabilize the ground around the working area and it has to be placed in a truly vertical alignment in order to start and maintain a vertical hole.

In chalk or firm sandstone with little overburden, it may only be necessary to drill for, and place, some 15 m of permanent tubes as a seal against surface-water contamination. The remainder of the well would be drilled open-hole and present no problems.

The opposite is the case in unconsolidated material, especially if interbedded with hard strata. Under these circumstances it is sometimes necessary to start at 450 mm diameter and insert several tiers of intermediate temporary tubes to produce a finished lined borehole of 150 mm diameter. In any case, if the drilling engineer is anticipating problems, such as boulders, he may opt to start at an extra large diameter, if only to be able to gain some freedom with regard to verticality when inserting the permanent tubes. This may of course introduce an undesirable element in that a larger annular space would require more cement grout, but this is usually compensated by the fact that the greater diameter provides more scope for 'swallowing' boulders and placing emergency tubing.

Two or three decades ago, it was common practice to drive tubes down to their required depth if they became tight, and indeed the standard schedule of percussion drilling tools includes this facility. The tubes were provided with 'drive-heads' and 'driveshoes'. Heavy jacks were standard tools but as most of the tubes were socketed, there were many cases where recovery was impossible and wells were completed incorporating several columns of unnecessary tubes.

The use of flush-jointed temporary tubes and the realization of the need to keep tubes on the move by 'surging' resulted in the application of persuasion instead of force to the tubes, and their recovery is now the rule rather than the exception. In fact, the practice of driving tubes should be avoided where possible and only used as a last resort.

Hydraulic rotary drilling

Direct Circulation - Rotary Drilling

In this system the drilling is carried out by an abrading and crushing roller bit grinding down or breaking up the formation, while the cuttings and the loosened ground are removed from the hole by a continuous circulation of flushing fluid. Rotary drilling is particularly suitable in loose ground formations and soft rock. Large-diameter holes can be drilled to considerable depths. The greatest draw back is the requirement for substantial amounts of water which can be a serious problem especially in water-scarce areas.

The fluid, usually clay-based, is mixed in a mud pit or tank and delivered by a pump at high pressure through a flexible hose to the top of a rotating column of tools called the drill string. It then flows through the tools to the bottom of the well and returns to the surface and back into the mud pit (Fig. 3).

At the bottom of the drill string is the drill bit which is either of the roller cutter type or, less commonly, the plain drag bit type. A roller rock bit carries three or four hard steel toothed cutters which are free to run on bearings. The body of the bit has passage ways to conduct the flow of fluid which cools and lubricates the rollers, cleans the teeth and carries away cuttings.

The bit is applied to the bottom of the hole and rotates at speeds of 3-30 rpm - depending on diameter and strata-and weight is applied within a range of 250-2.750 kg per 25 mm of diameter.

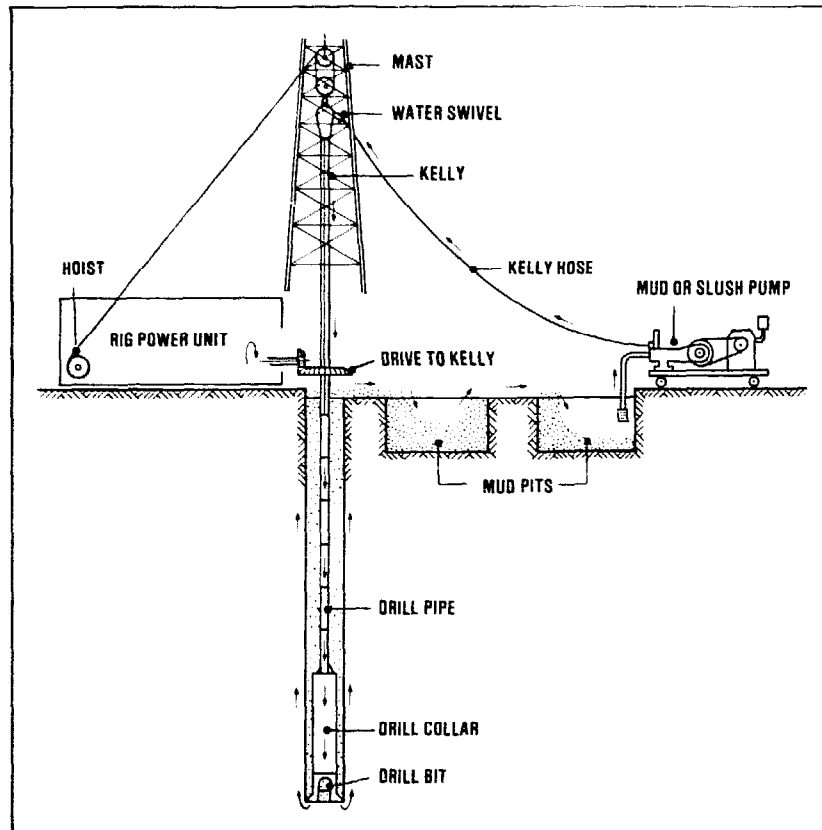

Figure 3
Normal direct circulation rotary drill

In hard rock the line contact of the teeth causes the formation to fail due to overloading; in softer rock the rollers are skewed slightly to add a twisting action, and for soft rock, the teeth are formed to impart a tearing action.

Drag bits carry no rollers. They have three or four hard-faced blades and cut soft strata in a manner similar to a wood auger. They drill rapidly in very soft conditions but tend to stress the drill pipe and overtighten the tool joint if used through hard bands where chatter can occur.

The verticality and straightness constraints mentioned for percussion-drilled holes, apply equally to rotary wells, but rotary drilling suffers from a disadvantage in that a continuous weight must be placed on the bit and gravity consequently has less effect on the tool column. However, a kink-free hole can generally be achieved due to the stabilizing influence of the drill collars.

Drill collars (Fig. 3) are extra heavy pipes which are fitted above the bit to provide the necessary weight, and to assist straight drilling. In addition, as they are of large diameter relative to the well, a smaller annulus results, causing an increased fluid velocity which rapidly carries away the cuttings from the bit vicinity. Ideally, most of the tool string length should be in tension from the crown wheels of the drilling rig but this is not always possible and weight is sometimes added by means of a hydraulic or chain mechanism known as a 'pull-down'.

The main length of the drill string consists of drill pipes (Fig. 3) which are added as depth increases; they extend from the top of the drill collar to the surface. They are usually in lengths of about 3-10 m and the diameter is selected to suit the drilling conditions, e.g. the clear diameter through the pipe and joints must be such as to cause the minimum head loss on the descending fluid and the drill pipe must be large enough to promote a reasonable rising fluid velocity for a given mud-pump size.

The uppermost length of pipe is of special construction and is called the kelly. Its purpose is to transmit rotary drive from the rotary table and it is therefore of a square, hexagonal, or round section with grooves or flutes to fit into a corresponding aperture in the rotary table. This permits free vertical movement and thus allows the kelly either to feed off down the hole as drilling proceeds, or to be withdrawn.

The swivel is located at the top of the kelly. It contains a bearing assembly which carries the complete weight of the tool string. It also has an entry for the drilling fluid passing up from the mud-pump through the kelly hose and a suitable gland to control the passage of the fluid from the static swivel to the rotating kelly.

As drilling proceeds, and cuttings are brought to the surface, the kelly will travel down through the rotary table until the swivel unit reaches the table. Feed off is then stopped, rotation may be slowed, and the circulating fluid allowed to continue for a short time to carry the most recent cuttings up and away from the bit and drill collars. The pump is then stopped, the kelly withdrawn and unscrewed from the drill pipe, while the latter is suspended in the rotary table slips. Another drill pipe is added and lowered with the drill-pipe column until it is at table level, when the kelly is again attached and the circulation re-started. Rotation is engaged and finally the bit is applied once more to

the bottom of the hole. The above procedure is repeated until such time as final depth is reached or the tools withdrawn to change bits.

Reverse Circulation - Rotary Drilling

This method differs from the more common 'direct circulation' system in that the drilling fluid is circulated in the reverse direction. Basically the equipment is similar in general arrangement but considerably larger e.g. the water way through the tools, drill pipe, swivel, and kelly is rarely less than 150 mm in diameter (Fig.4). The minimum practical drilling diameter is in the order of 400 mm while sizes in excess of 1.8 m are not unknown.

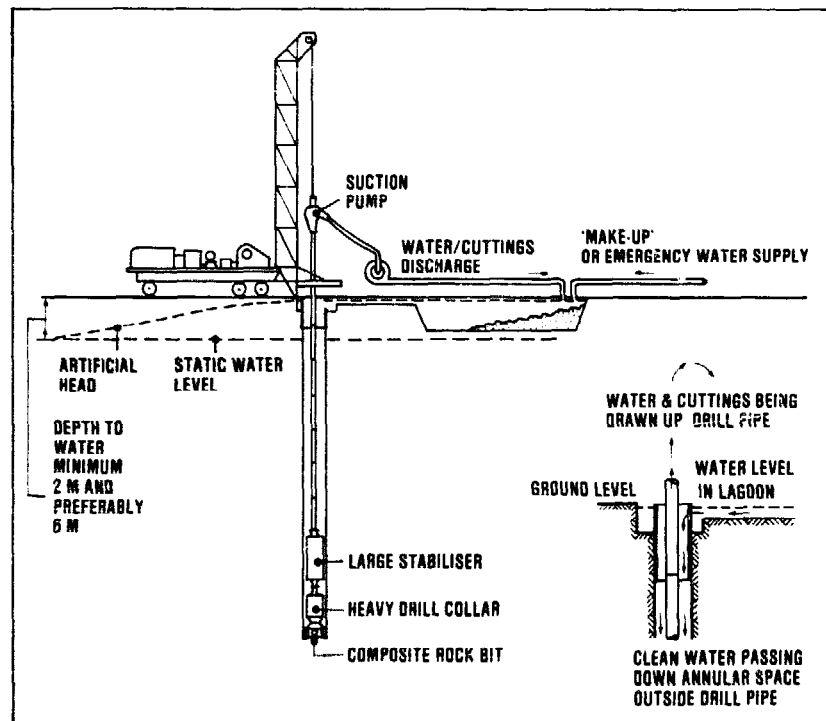

Figure 4
Reverse circulation rotary drill

Conventional tricone bits within the above diameter range would be impractical and it is, therefore, usual to fit a composite roller rock bit. This consists of a sturdy bed plate, to the underside of which are fitted a number of toothed rollers so arranged that the full face of the well is tracked. The bed plate incorporates short

passages which rise to a common bore at the coupling flange. Material dislodged by the drilling action is drawn up through the bit centre and rapidly carried to the surface.

A full diameter flanged tube is bolted above the bit. It contains a central tube of the same bore as the drill pipe. Apertures in the end of the outer tube allow the downward-flowing clean water to pass unrestricted. This assembly is called a stabilizer and restrains lateral wandering of the tools.

A composite bit requires weight to provide penetration and this is achieved, as in other methods, by incorporating drill collars in the drill string. These may be of a considerably smaller diameter than the well. Under some conditions the sequence of stabilizers and drill collars may be rearranged. The bits as described above are suitable for unconsolidated strata, soft clay, and soft rock. Stiff clay would call for the use of a drag bit.

Drill pipe for reverse circulation work must have couplings which present an unrestricted inner bore and are therefore normally of the flanged type. They are also relatively short in order to employ a corresponding short kelly to avoid high suction lifts above ground.

Suction pumps, attached to the kelly hose outlet, used to be of the centrifugal 'paddle' type which drew out the full flow of water containing all the cuttings. As a flow of 4.5 m³/min through a 150 mm system generated a velocity of nearly 213 m/min and debris with a diameter of 140 mm or more was pumped, the pump had a short life. It is now usual to combine the centrifugal pump with a venturi unit producing a suction in a circuit separate from the pump. A few rigs use compressed air only as the vacuum induction circuit above ground.

Water and cuttings are discharged into a large temporary lagoon the size of which is determined by the 'rule of a thumb' that the volume should not be less than three times the volume of the drilled hole. A 750 mm well drilled to 60 m would require a lagoon 12 m long, 8 m wide, and 1 m deep, the spoil of which takes up additional area. This is but one of several factors to consider when selecting the system of drilling and these will be discussed in the next section.

The lagoon is often divided or 'baffled' to encourage settlement of the cuttings in one area well away from the channel returning the clean water to the borehole.

Mud is seldom used because one of the advantages of reverse-circulation drilling is that relatively clean water is imposed upon the aquifer and therefore there is no invasion of the formation. In Europe, for water supply wells of large capacity, rotary drilling with reverse circulation has virtually replaced all other methods.

In the event of clays being drilled in the upper section of the hole, the lagoon should be cleaned out and re-filled with fresh water before proceeding into the aquifer.

The main advantage of this method is the very rapid rate of drilling at large diameters, especially in unconsolidated sands and gravels. Wells are sometimes drilled and lined within 24 hours as no cleaning is necessary (development is a different phase). Indeed, speed is essential in unconsolidated strata as the driller may be relying upon only 1 or 2 m head surcharge in the hole. The drilling should be rapid in order to prevent collapse of the hole and possible loss of tools.

It will be apparent that a head of clean water imposed upon an unconsolidated stratum will involve some water losses. In view of this, one of the prerequisites of reverse-circulation drilling is the ready and close availability of a substantial supply of water for make-up purposes. This is often quoted as 45 m³/hour and in practice can amount to between 9 and 70 m³/hour.

While the average reverse-circulation system utilises suction as the motive power behind the circuit, there are circumstances, such as pipe friction at greater depths, or a low water table, when suction is insufficient. For this reason most drilling rigs have provision for introducing an air-lift into the system. This is accomplished by incorporating air pipes in the drill pipe lengths, either concentrically or paired on the outside, with a mixer jet arranged to discharge inside the drill pipe at a suitable level.

Under ideal conditions penetration rates of 0.6 m/min have been recorded and average rates of 12 m/hour are quite common. It should be noted that the flanged-and-bolted drill pipe connections most commonly used require time-consuming handling and there appears to be room for technical improvement here.

Rotational speeds are within the 8-50 rpm range and drilling depths average 120 m; occasionally 300 m are obtained.

Various drilling methods

Hydraulic Tube Racking

Where there is a requirement for relatively shallow wells with large diameters in loose gravels, sand, boulders, or similar ground formations, one may consider the application of a hydraulic tube racking device in conjunction with a rig or crane.

In this method a short guide tube is hand-sunk into the ground and the first of a column of permanent tubes lowered within it. The bottom edge of the column is serrated and the tubes drilled, perforated, or slotted as required.

A hydraulically-clamped spider, supported on two vertical cylinders, is located on to the tube a short distance above ground level. Long horizontal rams are attached on two diametrically opposite 'ears' on the spider and are used to impart a very slow but powerful oscillating torque to the tube column. At the same time, the two vertical cylinders control downward feed and apply thrust if required.

Under this force the tubes travel down and mud gathers inside them; this is removed by a grab until the top of the first tube is close to the spider table. Then the next tube is placed upon it and the joint welded. The essential principle underlying this system is the maintenance of a 'fluidity' of formation around the contact area of the tubes and it is quite common, therefore, to weld the next tube joint without halting the oscillation.

Tubes of 450 mm - 1.2 m can be worked down to 30 m or so under the right conditions, the advantage of this system being that there is no need for temporary tubes (in percussion drilling) and large lagoons (in rotary drilling). There also is no contamination of the aquifer by drilling fluids.

Auger Drilling

Large diameter auger drilling first appeared over 75 years ago. Horses were used to power auger drills. The deepest wells recorded were in the 100-110 m range. The augers were taken down until a caving formation was reached, after which an iron or steel 'shoe' topped by masonry was used to cut a clearance for further masonry added at ground level.

Auger drilling is worth considering in cases where a number of holes have to be drilled through a firm clay overburden overlying a stratum more amenable to the usual techniques. In such a case, an auger might produce a hole in 15 minutes, which might take a normal rig as much as one and a half days.

Essentially an auger bucket is rotated into the ground on the end of a long kelly and withdrawn frequently for emptying. Apart from the exceptional cases mentioned above, depths were restricted in the past by the need to have a kelly of transportable length, but when telescopic kellys were introduced this made holes of 25-30 m depth possible. Another refinement is the use of solid drill rods with an inclined plane along them. These 'continuous flight' augers carry the spoil to the surface during rotation and it is unnecessary to remove the auger bucket.

Equipment is available covering diameters from 200 mm - 3 m. The larger sizes are favoured in parts of the USA where a combination of soft cohesive ground and weak aquifers make it possible to construct a cheap well of a generous size.

Although auger drilling as discussed in this section is mostly of the machine-powered type, it must be remembered that auger drilling to shallow depths and of diameters less than 20 mm have been successfully carried out using man power only. This assumes a suitable ground and a high water table. Many hundreds of this type of well have been constructed.

Scow Drilling

A scow tool is a tool used in cable-drilling which combines the cutting edge of a chisel with the handling capacity of a bailer. It consists of a heavy, thick-walled tube at the bottom edge of which is a hardened female bevel; it may also carry a bevelled cross-bar.

Inside the tube, a few centimetres from the bottom, there is a pair of hinged doors opening upwards. At the top of the tube, which is open, there is a swivel connection for attachment to the drilling line.

In operation, the scow is run into the hole and the normal reciprocating action applied. Water for drilling is added if not present naturally. Material is dislodged by the cutting edges, and swept into the body of the scow by the 'pumping action' set up by the non-return feature of the doors. A size of tool is selected that

will almost fill the diameter of the temporary tubes in use, thereby helping to 'swallow' boulders and enhance the pump effect. The scow is removed for emptying periodically.

Scows are used in loose, troublesome strata, especially where coarse gravel and boulders occur, and have the advantage of dislodging and lifting the material rather than expending time and power on crushing, as would be the case with a normal bit.

A secondary factor is the shock effect of the water-hammer caused by the rapidly slamming doors. This results in a pulsating vibration throughout the tube column and positively advances them down into unconsolidated ground. A disadvantage is that the drilling rig and cable must be in good condition to withstand the heavy loading created by scow drilling.

Direct Air Circulation

Air was applied to drilling by the quarrying and mining industries to resolve the problems of water haulage and freezing conditions. It was successful and, under favourable conditions, showed additional advantages such as longer bit life, faster penetration, rapid presentation of cuttings at the surface, etc. Other features will be discussed in the section on drilling fluids.

The engineering equipment is basically similar to that used for mud drilling but some differences in detail are found, for example, in the drilling bit design; the passages are modified to provide air to the bearings. The water swivel packing must be capable of dry rotation. Obviously considerable compressor capacity must also be available. Some oil-well drilling rigs use gas rather than compressed air as the cuttings vehicle.

Reverse Air Circulation

One of the problems to be faced when drilling with air, especially as the diameter increases, is the need to produce a rising air velocity of not less than 925 m/min (Fig. 5).

To obtain this figure in, say, a 375 mm hole using standard 112 mm drill pipe would require air at a rate of some 100 m³/min, which is impracticable.

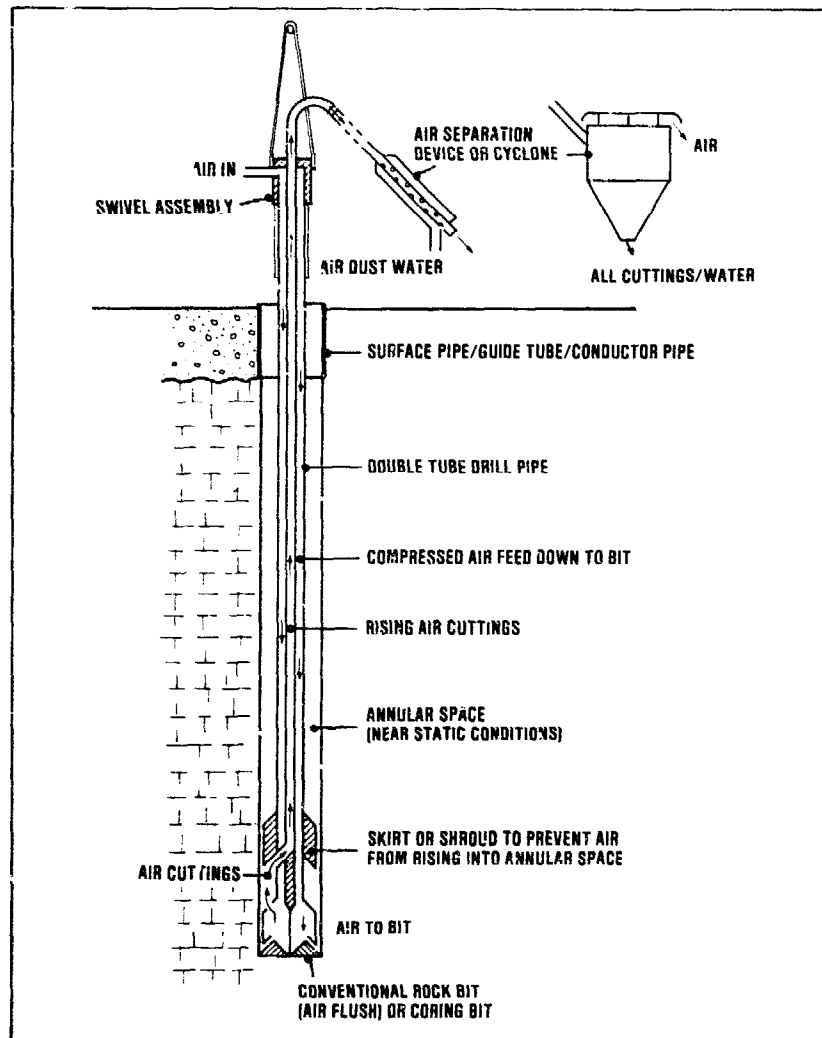

Figure 5
Reverse circulation air drilling

In an attempt to overcome the problem, some drilling has taken place using twin concentric drill pipes. The air is fed through the annular space between the outer and inner pipes and released around the special bit. A shroud or skirt prevents undue escape of air into the annulus outside the rotating drilling tools and thus forces most of the air across the bit and up through its passages, whence it travels at high speed through the inner drill pipe to the surface, carrying the cuttings with it.

An interesting variation has been the application of this double-tube layout to small-diameter coring work. Water is pumped down the drill pipe annulus, carried across the coring crown and conducted up the inner drill

pipe. There is no core barrel as such; instead a special core-breaking device allows the rising water to propel short sticks of core to the surface together with the fine particles of cuttings.

This arrangement obviates the need to remove a conventional core barrel for emptying and enables uninterrupted drilling to take place. Here again, it can only be applied under favourable drilling conditions.

'Down-the-hole' Hammer Drilling

The introduction of the hammer drill marked a significant step forward in the development of drilling tools suitable for hard ground. The 'down-the-hole' drilling method is most valuable for drilling in hard rocks. The principal advantage of this method is its speed. It usually takes only 1-2 days to drill down to 100 m in granite or gneiss. Furthermore, the drill equipment is very light, compared to cable-tool and rotary drilling rigs. No water is required for flushing, which makes this method especially suited for water-scarce areas.

An air-actuated single piston hammer, working on the same principle as the familiar road drill, is fitted beneath a string of drill pipe. A tungsten carbide-set is attached to the hammer (Fig. 6).

The complete assembly is rotated at 20-50 rpm and lowered towards hard rock. The rotation is primarily to change the position of the bit on the bottom of the hole and any 'drilling' benefit is of secondary importance.

The piston, before the tool touches the bottom of the hole, is 'idling' in its cylinder and nearly all the air is exhausted through the bit, and, where fitted, additional parts in the tool body. This is because the anvil carrying the bit is in suspension and free to hang extended out of the tool bottom where it cannot be struck by the piston. This feature is built in to provide extra cleaning facilities when running in to the hole or to expel excessive accumulations of cuttings.

When the tool lands on the bottom of the hole the suspended bit/anvil assembly is pushed up into the tool body where it meets the oscillating piston which can now strike with a frequency of between 500 and 1,000 blows per minute. At the same time the air, previously being exhausted, is directed to drive the piston and is only released through ports in the bit when most of its energy has been expended. The expended air now cools the bit, clears the cuttings and propels them up the annular space to a collecting box at the ground surface.

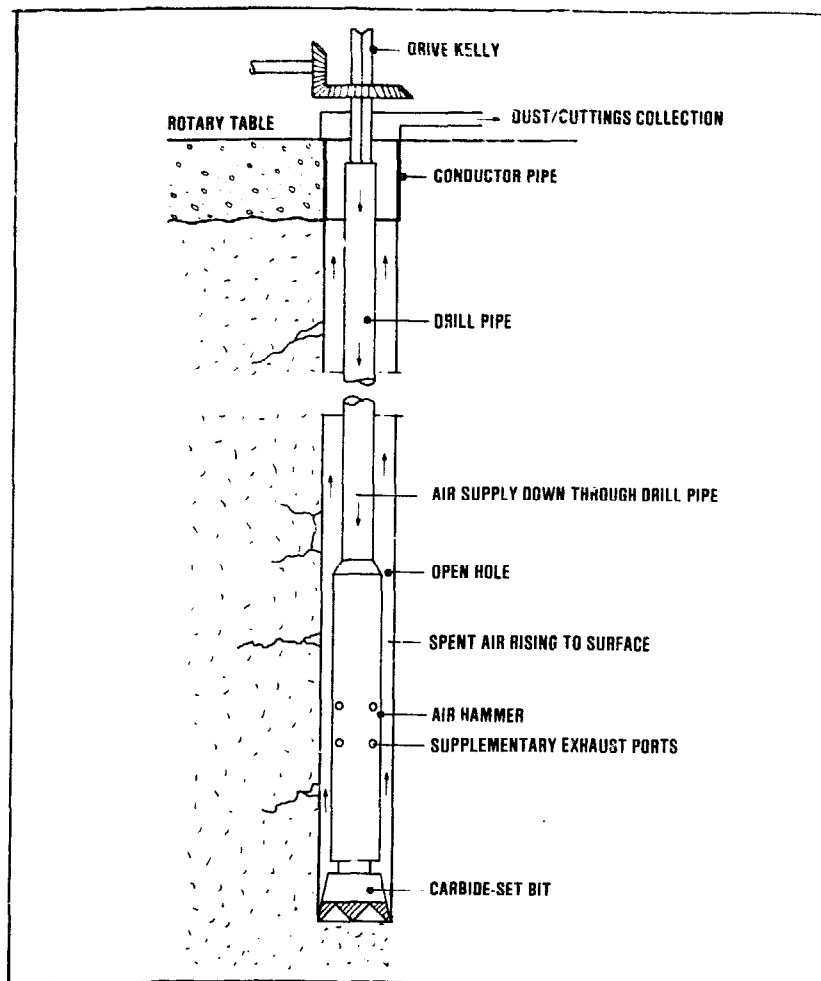

Figure 6
'Down-the-hole' hammer drill

Hammer drills of 50-375 mm diameter are already widely used and tools to drill up to 750 mm have recently been developed. Lifting the dust and cuttings to the surface is a technical problem with large annular spaces, but it may be overcome in part by positioning an open-topped collector tube immediately above the tool. The collector tube is raised and emptied periodically. Alternatively, a shroud and reverse air method might be considered.

The down-the-hole hammer system has vastly improved penetration rates through hard rock. As early as 1960, a model available at that time was capable of drilling 3 m in one hour in very hard basalt compared with 1 m per 10 hour shift by the cable tool method, for a nominal diameter of 150 mm.

As with all specialised drilling techniques, there are disadvantages and problems. The hammer will not operate in unconsolidated ground or clays, and water may make it impossible for the hammer to work. A seepage of water will cause the cuttings to congeal and stick to the walls, although this can be relieved by the injection of detergent into the air supply. A heavy flow of water, however, will be ejected as in 'air-lift' pumping, until a depth below water is reached where all the air power is expended on pumping. Then the hammer is stifled.

Higher working pressure tools were introduced to overcome, in part, the latter problem. Double-tube drill pipe and reverse-air circulation can also help, but very few water drilling companies possess this type of drill pipe.

Drilling fluids

The first recorded drilling fluid was water which was directed through hollow rods on percussion drilling rigs in an attempt to remove cuttings without having to withdraw the tools - a very time consuming operation.

Clay was sometimes added to increase viscosity in order to aid the lifting of rock chippings and gravel.

One of the basic principles of rotary drilling is the use of a circulating fluid and for some 50 years this has been a clay- or bentonite-based mud.

Clay or Bentonite

A natural clay or bentonite mud is the most common drilling fluid in use today for oil and water wells. Its functions are listed as follows:

1. Remove cuttings from the face of the borehole and transport them to the surface.
2. Lubricate and cool the bit and tool string.
3. Promote suspension of cuttings in the borehole whilst adding further drill pipe.
4. Allow settlement of fine cuttings to the bottom of the mud pits.
5. The buildup of a 'wall-cake' to consolidate the formation and to reduce the loss of fluid into the formation.

6. Control sub-surface pressures (artesian flow).
7. Provide some buoyance to long strings of tools or casing in deep boreholes.

Looking at the above list in a little more detail, the cleaning of the bore face is essential to ensure maximum bit life and optimum drilling efficiency. Having done this, the mud should rise to the surface at a sufficient velocity depending upon pump capacity and speed, well size, and drill pipe size. The cuttings however, will not rise at this velocity because they tend to sink under gravity. The 'slip velocity' must never be greater than the annular mud velocity in order to ensure the transport of the cuttings to the surface. If the well has partially collapsed in any section, it will be of larger diameter at that point and so the mud velocity will be correspondingly lower, illustrating one of many requirements for careful control of the system.

In addition to velocity, other factors that influence the removal of cuttings are the density of the cuttings, the size of the cuttings, the viscosity of the fluid, and the density of the fluid. The viscosity determines the lifting power of the mud and depends on the properties and dispersal of the suspended solids in it, while density affects the carrying capacity of the mud through buoyancy, and this is expressed in weight per unit volume of mud.

There is a close relationship between the factors that determine the behaviour of the mud, and careful consideration has to be taken when making any changes. To overcome cuttings slip one may increase the viscosity, but in so doing the pumping pressures may be raised to an unacceptable level. An increase in density may have beneficial effects down the hole but when the mud reaches the mud pit it may fail to drop the fine solids, and the recirculation of these would cause excessive wear of the pumping plant, especially if it is an abrasive material.

Wall-cake buildup is an essential function of the drilling mud. When drilling in a formation with a pore size which prevents the ingress of mud particles, the water portion of the fluid filters into the formation, and leaves behind a 'filter cake' of mud solids. This filter cake remains on the well wall and will control the loss of further water into the formation.

The hydrostatic head exerted by the mud column acts upon the wall cake and enables drilling to continue through loose sands and gravels without the need for a temporary

casing. Too thin a cake and the walls may be broken down by the rotating tools, and heavy water losses can then occur. A very thick cake will make drill string removal difficult and can even cause collapse of the hole due to the swabbing effect of the bit.

Another important property found in natural and commercial clays is that of gelling. The gel is governed by the thixotropic character of the mud. When actively in circulation, the mud has a given fluidity which is substantially reduced when it comes to rest. This feature is used to full advantage when shutting off the flow to add further drill pipe and it is vital to retain debris in suspension; if the solids fall onto the shoulders of the drill collars and bit, the latter may become stuck in the hole. Considerable additional pump pressure would be required to disturb the thixotropy when circulation begins again. A very heavy mud may even overload the system, and prevent the settling of fine mud particles in the mud pit.

There are very many additives commercially available for the treatment and control of drilling mud. They range from ground walnut shells and shredded leather to complex chemical compounds. Drilling mud is a science in itself and the high pressures, temperatures, and great depths associated with oil-well drilling have generated technology to cope with them. Water-well drilling on the other hand, can be and often is, carried out using no more mud control than the experience of the driller on the rig using sight and 'feel' as his only instruments.

Organic Polymers

We have seen in the previous section that an essential mud property is that of forming a wall-cake and it will be clear that under some circumstances not only will the water phase of the mud invade the formation but the clay content as well.

It can be extremely difficult, if not impossible, to remove all the mud from the formation; in fact such mud frequently remains in situ between the screen and the formation for many years, even in a regularly pumped well, and many wells have been labelled as dry only because the aquifer has been 'mudded off'. This is particularly so where there are several weak aquifers of which the sum total yield might have provided a useful yield. Special dispersant chemicals are not always capable of removing clay particles, even if forming part of the well-development programme.

To overcome this problem, organic polymers were introduced. Using water as a base fluid, polymer powder is mixed to form a drilling mud performing the basic essential functions of conventional bentonite but with one vital difference. It has a life of about three days, after which it breaks down to a water-like consistency and is easily drawn out of the formation. In addition, it has only a weak thixotropic property and releases solids much more readily.

Obviously, many wells will take much longer than three days to drill and compounds such as formalin are used to prolong the life of the mud. Some polymer muds can be stabilized indefinitely. To break down the mud at a specific time, an additive such as chlorine (in heavy dosage) can be used. This treatment should not be confused with the light dosage given to combat soil bacteria.

An early problem experienced was the failure of the mud under conditions of varying pH. It is now recognised that the maintenance of a high pH within a fairly close limit will ensure mud stability. Most manufacturers provide their own brand name additives to control the mud fluid according to specific drilling requirements.

At this point it should be noted that although water engineers throughout the world are increasingly accepting the usage of organic polymer muds there have been recorded instances of bacterial problems which may or may not have been associated with its use. It is with this question in mind that manufacturing chemists are experimenting with inorganic synthetised polymers for water well drilling muds. These may soon be available.

Air

The use of air as a drilling fluid has already been discussed in a previous section when it was noted that in appropriate circumstances considerable benefits were obtained. Firm hard rock is an ideal drilling stratum in which to apply this method and fissured zones can be penetrated without the fear of lost circulation associated with muds. There is also no risk of sealing off an aquifer and normally no drilling water is required.

A disadvantage is that air cannot support a caving formation. Problems also arise when small inflows of water are encountered which tend to aggregate the cuttings and it is sometimes necessary to inject additional water into the air supply in order to produce a manageable slurry.

The rapid return of cuttings ensures representative sampling and it is sometimes even possible to evaluate the output potential of an aquifer while actually drilling if the airlift principal comes into operation. However, drilling efficiency falls off with increase in depth below water.

Foam

A foaming agent has been developed to cope with a situation where (a) mud cannot be circulated due to losses or water supply problems and (b) insufficient annular air velocity is available to clean the hole adequately. Under certain conditions a complete well may be drilled using foam. Other circumstances may call for only partial application.

The introduction of additives into the air stream is not new and detergent was used by air drillers some 20 years ago to overcome the aggregation of cuttings in a 'weeping' borehole.

A decade later the technique of injecting a bentonite-foam slurry was developed which provided a measure of support to the formation but still relied on fairly high velocity and compressor capacity. It was found that greater quantities of formation water could be lifted, probably because the slurry caked the wall and provided a smoother well.

Recent development work has resulted in a stable foam which requires quite moderate air quantities, a 'starting guide' being $0.3 \text{ m}^3/\text{min}$ per 25 mm of bit diameter. No mud pit or lagoon is required, as the fluid is mixed in a tank and injected by a pump into the air supply system. It travels down the drill pipe under pressure and passes through the drill bit lubricating and cooling it. Expansion and foaming activity then takes place and sufficient support is developed to carry the cuttings up the annular space at a low velocity, say 12-15 m/min, for air alone. The foam is similar to aerosol shaving cream in consistency and often appears at the surface with a surging pulse, a characteristic believed by some to assist in cleaning the well.

The foam breaks down in 30-45 minutes, releasing its cuttings in the process. It is conducted away from the well head by a collector ring and horizontal pipe.

A typical fluid consists of 100 l of water per litre of foam and 0.2-0.35 kg of stabilizer; it is injected at a rate of 5-7 l/min. Holes of 150-650 mm diameter may be drilled using foam and a special fluid is available for

use with down-the-hole hammers when provision must be made for better lubrication.

Finally, although guide lines for the use of foam exist, it is a system which is still improved through experience. Therefore it is the task of the drilling engineer to adjust the settings to give optimum results under prevailing conditions.

3 experimental studies for water treatment plant design

Sedimentation

For design purposes, a settling tank can be subdivided into four sections, i.e. inlet, settling zone, outlet and sludge deposit zone (Fig. 1).

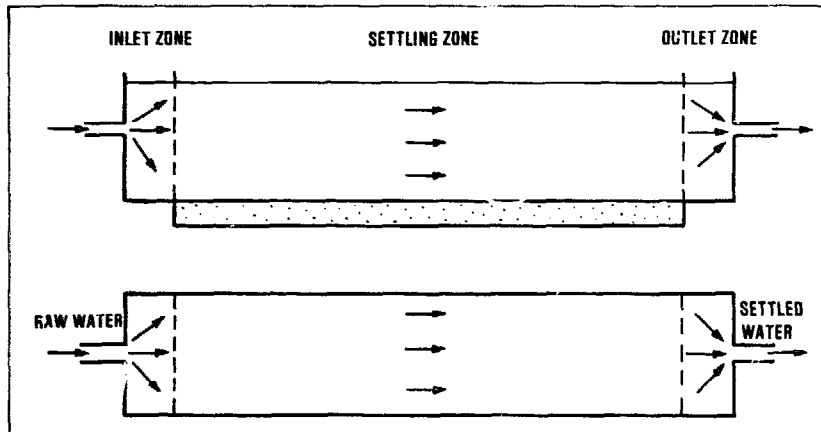

Figure 1
Schematic subdivision of settling tank

The actual work of the tank is done in the settling zone. The inlet zone serves to distribute the raw water evenly over the full cross-sectional area of the tank. The outlet zone collects the clarified water uniformly over the full depth and width of the tank. The sludge zone accommodates the suspended particles removed from the settled water.

The sedimentation process may be a discrete or a flocculent one. With discrete settling no aggregation of finely divided suspended matter into larger flocs takes place. This means that during the entire settling process the size, shape and density of the particles remain unchanged, giving a constant settling velocity. With flocculent settling on the other hand, particles overtaking one another will coalesce and will henceforth go down at the higher rate of the aggregate. This process will repeat itself several times, increasing the settling velocities as the particles grow.

For the discrete settling process, the following analysis is made.

The path followed by a discrete particle in the settling zone depends on two velocities: the horizontal displacement velocity of the water and the settling velocity of the particle. Under ideal conditions, the horizontal velocity of the water and all particles contained in it, will be constant: $v = v_0$. The distribution of the settling velocities, can be determined through an experiment.

For such an experiment, a cylinder is used, preferably made of transparent plastic. Usually, the cylinder diameter is about 20 cm and the height 2 metres* (Fig. 2). The settling test usually takes about one day, and requires only simple equipment.

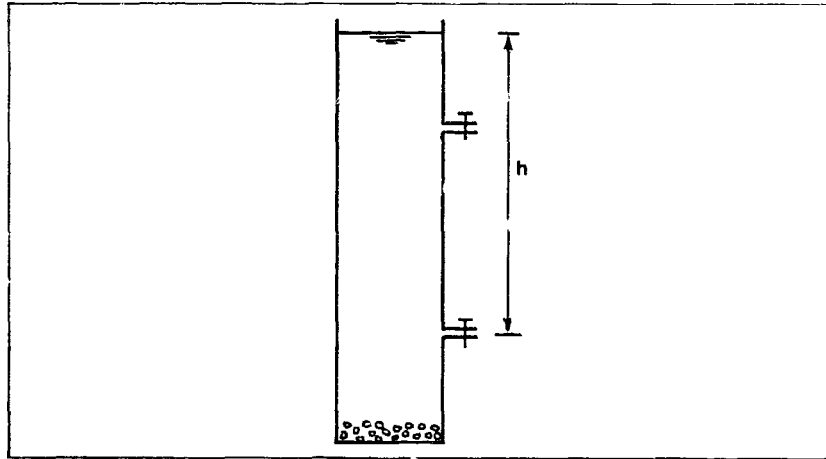

Figure 2
Experimental cylinder for settling velocity analysis

The container is filled with a test sample of the water. After stirring gently for even distribution of the particles over the full depth, the test is started when the water has come at rest. At regular time intervals, water samples are drawn at the sampling taps. They are analysed for turbidity, suspended solids content or any other factor characteristic for the settling process. If the particles settle discretely and at a constant settling velocity, then a sample taken at a time t at a depth h below water surface cannot contain particles with a settling velocity higher than h/t (Fig. 3)

* Two or more taps for water sampling should be available.

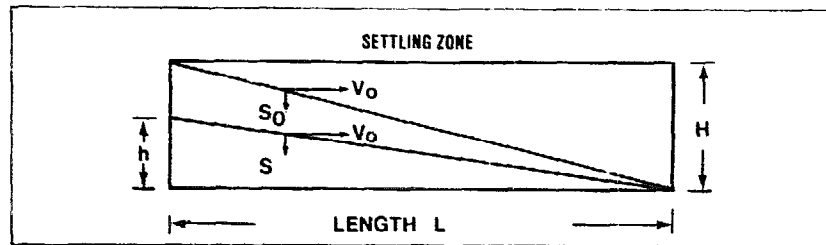

Figure 3
Particles travel path in the settling zone

For example, in such a settling experiment, measurements taken at samples drawn at a depth $h = 1.25$ m, are:

time	$t = 0$	$\frac{1}{4}$	$\frac{1}{2}$	$\frac{3}{4}$	1	$1\frac{1}{2}$	2 hours
suspended solids content c	$= 86$	83	63	49	37	16	6 mg/l

From this, the cumulative frequency distribution of settling velocities can be calculated:

$100 c/c = 100$	96	73	57	42	19	7	%
$s = h/t = \infty$	5	2.5	1.67	1.25	0.83	0.63	m/1.our

When plotted in a diagram, these data produce a cumulative frequency distribution of settling velocities curve (Fig. 4).

To make sure that discrete settling takes place, samples should also be taken at another depth, say 0.5 m and analysed in the same way. When plotted in the diagram they should fall on the same curve.

The settling velocity s varies from one particle to another. All particles with a settling velocity larger than s are completely removed, while particles with a lower settling velocity are partly removed, in the ratio of s/s_o which is the same as h/H .

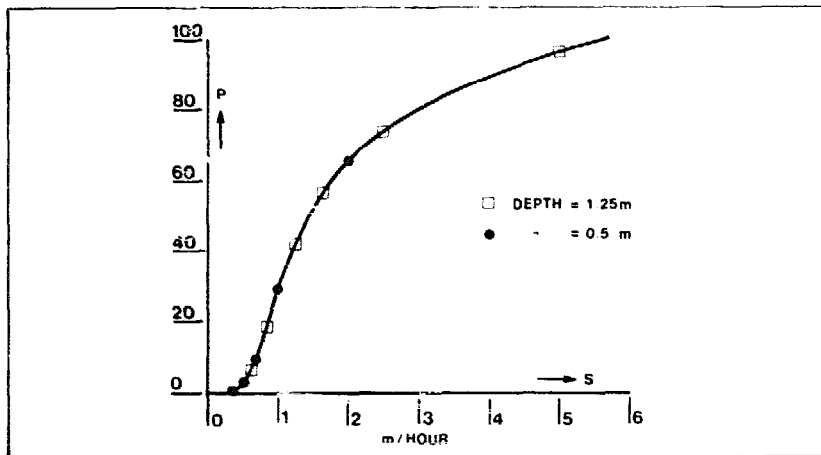

Figure 4
Cumulative frequency distribution of settling velocities

A graphical method to determine the overall removal ratio is illustrated in Fig. 5 using the curve of Fig. 4.

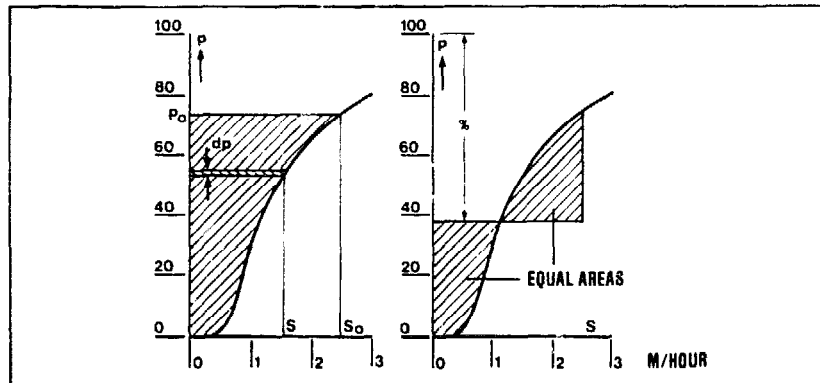

Figure 5
Cumulative frequency distribution of settling velocities

For a random value of s_0 the removal ratio r equals

$$r = (1 - p_0) + \int_0^{p_0} \frac{s}{s_0} dp = (1 - p_0) + \frac{1}{s_0} \int_0^p s dp$$

In the right-hand formula, the integral represents the shaded area of Fig. 5 to the right, the total removal ratio r can now easily be found graphically by drawing a horizontal line in such a way that the two shaded triangles have equal areas. Repeating this procedure for various values of s_0 gives the graph of Fig. 6 in which

for any desired removal ratio r the required value of s_o can be read.

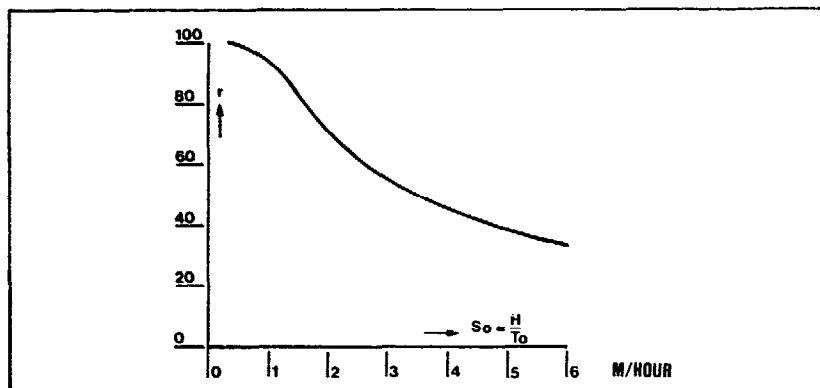

Figure 6
Removal ratio (r) as function of the surface loading (s) for particles having the cumulative frequency distribution of settling velocities show in figure 4).

Earlier it was shown (Fig. 3), that:

$$\frac{s_o}{v_o} = \frac{H}{L} \quad \text{or with } v_o = \frac{Q}{BH}, \quad s_o = \frac{Q}{BL}$$

saying that the removal ratio depends on the so-called surface loading, that is the ratio between the amount of water to be treated and the surface area of the tank, while the depth of the tank would have no influence.

The analysis method presented here, therefore, assumes that the settling process is not hindered by turbulences in the water flow through the settling tank, nor by eddies or cross-currents caused by the wind. The settling efficiency is usually high and a fairly long and narrow tank having a length to width ratio of about 4 to 6.

Slow sand filtration

The results of filtration in terms of effluent quality and length of filter run, are mainly influenced by four design factors: the thickness of the filter bed; the grain-size distribution of the filter material; the rate of filtration, and the depth of the supernatant water.

With slow sand filtration this interaction is quite simple as with a thickness of the filter bed larger than 0.6 m, the improvement in water quality only depends upon the grain-size distribution of the filter material.

The effect of the grain-size distribution on effluent quality, in particular on the presence of coliforms and E.coli, can be determined with a pilot plant, operating experimental filters filled with various types of locally available sand, having effective sizes between 0.15 and 0.35 mm. These filters are easy to build, for instance from a section of concrete or asbestos cement pipe, 3 m long and having a diameter of 0.5-1 m. This is shown in Fig. 7.

On the basis of the first series of experiments, the sand to be applied is chosen so fine that an effluent of acceptable quality will be obtained. The second series of experiments then uses this size of sand. For different filtration rates the length of filter run is determined. For average conditions a filter run of 2 months is appropriate, while minimum values in periods of high turbidity of the raw water should not be less than 2 weeks.

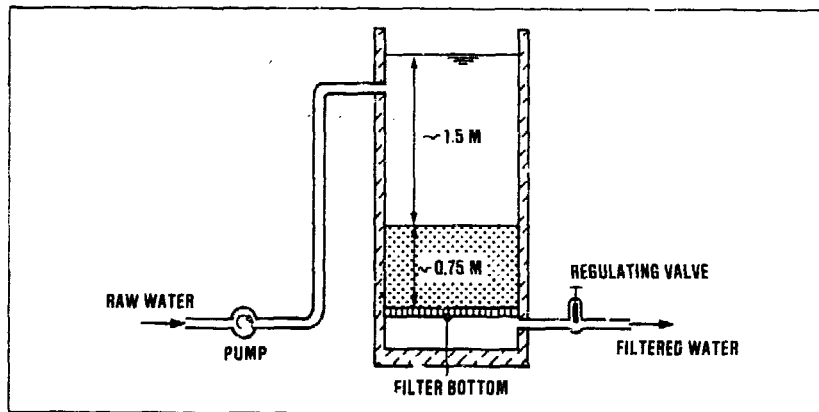

Figure 7
Experimental slow sand filter

The length of filter run also depends on the maximum allowable head loss, which in its turn increases as the depth of supernatant water goes up. With slow sand filtration in particular, negative heads (water pressures below atmospheric) must be avoided under all circumstances as these might cause the liberation of dissolved gases.

Air bubbles will then accumulate in the filter bed, increasing the resistance against downward water movement, while rising air bubbles of larger sizes will make holes in the filter bed through which water passes with insufficient treatment. According to Fig. 8, this limits the maximum allowable head loss to the depth of supernatant water augmented with the resistance of the clean filter bed.

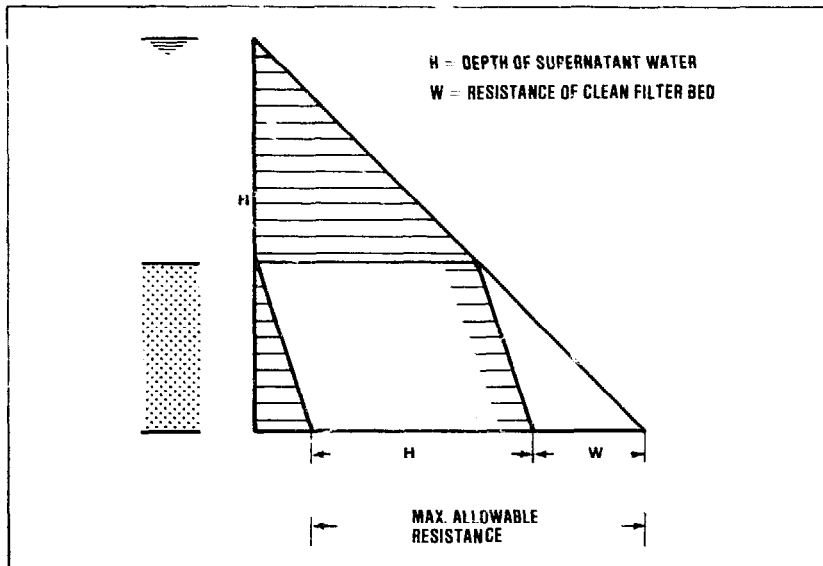

Figure 8
Pressure distribution in a slow sand filter bed

Rapid filtration

For the design of a rapid filtration plant, four design factors have to be selected: the thickness of the filter bed, the grain size distribution of the filter material, the depth of supernatant water and the rate of filtration. These factors are all inter-related, so that both the improvement in water quality and the length of filter run are influenced. However, the influence on the cost of construction is rather different. The grain size distribution has practically no influence on construction costs. A smaller grain size will improve effluent quality, but it will also result in a more rapid clogging of the filter bed, with a reduction of the length of filter run. For grain sizes smaller than 0.8 mm, an additional air scour may be required to keep the filter bed in clean condition. A greater thickness of the filter bed will improve effluent quality, but the influence on filter resistance and cost of construction is small. The depth of supernatant water should be large

enough to prevent negative heads. A larger depth of bed allows a greater head loss and a longer filter run. The influence on the cost of construction is limited. The most important factor is the filtration rate. A higher rate of filtration might result in a lower effluent quality, and a reduction of the length of filter run. It will always greatly reduce the cost of construction as the required filter bed area is less for a higher filtration rate.

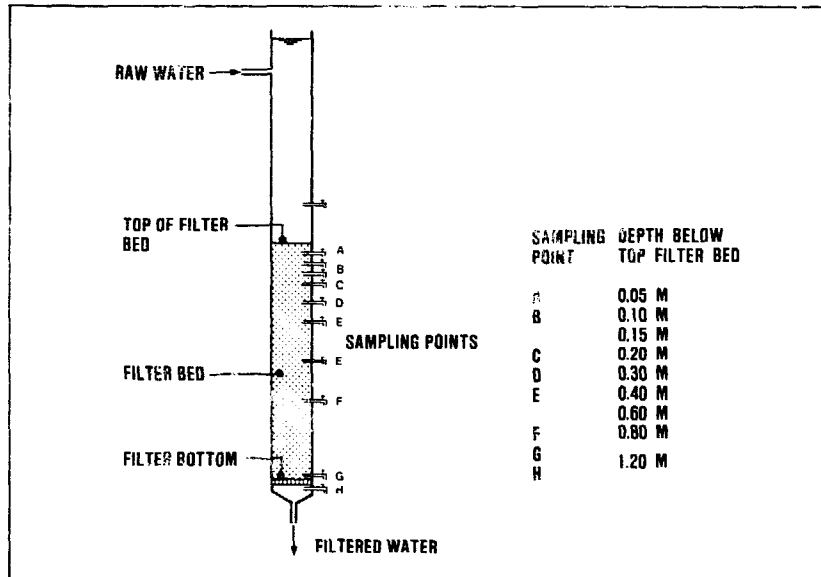

Figure 9
Experimental filter

The design of a rapid filtration plant may be based on the results obtained in a pilot plant, using an experimental filter (Fig. 9).

The grain size of the filter material is first chosen after which the influence of all other factors - filtration rate, filter bed thickness and depth of supernatant water - can be investigated. In case no acceptable combination can be found, the experiments should be repeated with another grain size, finer or coarser as indicated by the results obtained. The reliability of these results, however, suffers from the abstraction of water at the various sampling points, disturbing the main flow through the filter column. For small plants this may be compensated for by a somewhat lower rate of filtration or more economically by a slight increase in filter bed thickness.

On the basis of the preliminary results, three filters are for instance filled with sand of 0.8 mm grain size, to depths of 1.0, 1.2 and 1.5 m and operated at a rate of 10 m/hour, giving the results presented in Fig. 10.

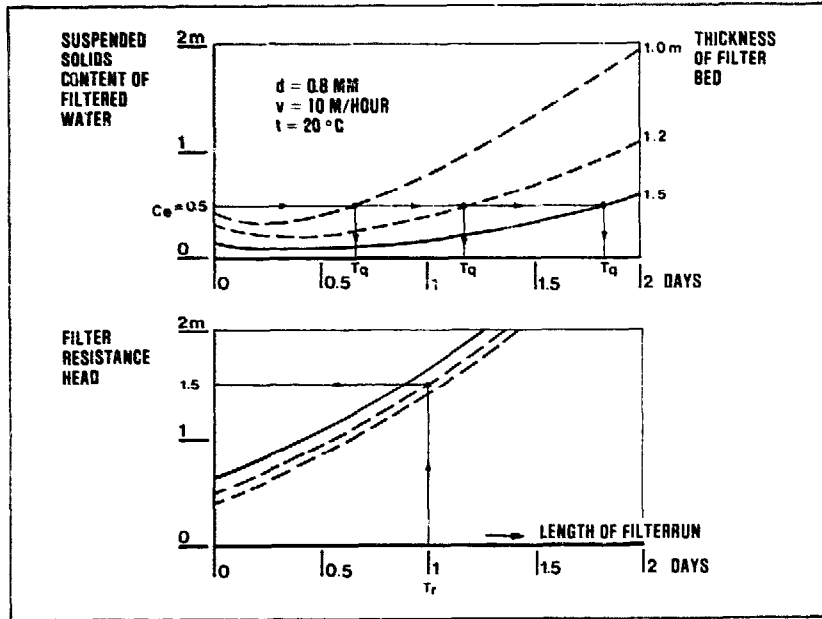

Figure 10
Graph presenting experimental results

When now the desired effluent quality is chosen, for instance a suspended matter content of the filtrate not exceeding 0.5 mg/l, the length of filter run T_q can be read from the upper graph drawn in Fig. 10 as a function of the filter bed thickness.

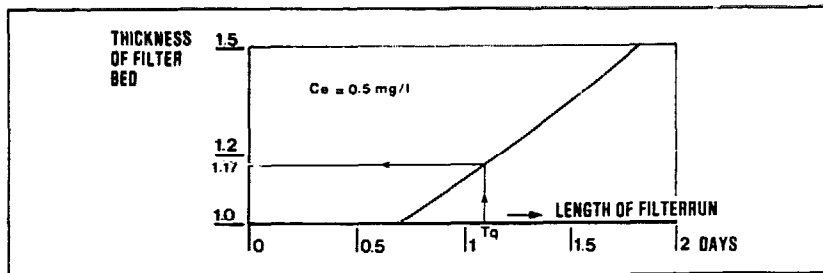

Figure 11
Graph showing relationship of filter bed thickness and length of filter run (based on experimental results presented in figure 12)

As second choice the desired length of filter run must be fixed, for instance at 1.1 day from which in Fig. 11 the required filter bed thickness can be taken at 1.17 m, or rounded off 1.20 m.

As additional factor of safety, the length of filter run T with regard to filter bed resistance is chosen 10% smaller, at 1.0 day, for which in the lower graph of Fig. 10 the resistance is found at 1.5 m. As resistance of the clean bed, at $t = 0$, this graph gives a value of 0.50 m, asking for a depth of supernatant water of 1.0 m to prevent negative heads with certainty. With rapid filters, impurities do penetrate some distance into the filter bed, giving an ultimate allowable pressure distribution as indicated with the dotted line in Fig. 12.

This would allow a decrease in the depth of supernatant water to about 0.85 m. The resulting saving in the cost of construction, however, is small and again as an added factor of safety the original value of 1.0 m will be used. Indeed, many designs use a much smaller depth, 0.4 m for instance, to save on the cost of construction.

Negative heads are then likely to occur, and as the solubility of gases is proportional to the pressure they tend to come out of solution, forming gas bubbles which accumulate in the filter bed, increasing the resistance against downward water movement and prematurely ending filter runs. This will not occur, however, when the raw water contains larger amounts of organic matter or ammonia. During filtration the oxygen content of the water will now drop strongly, reducing the total gas pressure to values of 0.8 or 0.9 atmosphere.

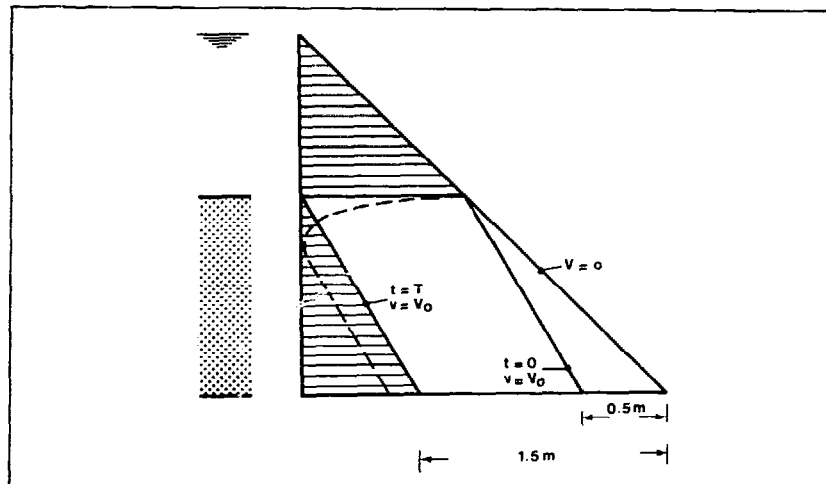

Figure 12
Pressure distribution in bed or rapid filter.

When the experimental results of Fig. 10 have been obtained with an average quality of the raw water, the length of filter run will be longer when raw water turbidities are lower. This will give no operational difficulties, but in order to avoid deep penetration of impurities into the filter bed, the filters should be backwashed at least every 3 days. With the raw water having a larger than average suspended load, filter runs will be shorter.

chemicals used in water treatment

Chemical name and formula	Common name	Use	Available forms	Commercial strength	Shipping containers	Appearance and properties	Subtle handling materials	Usual solution or suspension strength	Feeding	Remarks
Aluminum sulphate $Al_2(SO_4)_3 \cdot 14H_2O$	Alum sulphate of Al	Coagulant	Blocks, sticks, lumps, granules powder	15-17% Al_2O_3	Bags, barrels, bulk	Grey-white to light brown, chrysaline acid proof, brick tanks, acidic, corrosive, slightly lead coated concrete or rubber lined tanks	Dry: iron, steel solution: acid proof, brick tanks, lead coated concrete or rubber lined tanks	8-10%	Wet or dry	pH of 1% solution: 3.4
Aluminum sulphate $Al_2(SO_4)_3$	Alum liquid $Al_2(SO_4)_3$	Liquid	Coagulant	8% Al_2O_3	Iron or steel lined tanks	Brownish solution, acidic, corrosive	acid proof brick tanks, lead coated concrete or rubber lined tanks		Direct or in 1% solution	Costs less than office mix, rotax-dry alum if water and close enough to proportional manufacturing source
Bentonite (Compled) aluminosilicate clay	Colloidal clay	Coagulant	add, flocc weightling agent		Bags	Yellow brown clay	Iron or steel lined tanks		Colloidal solution	Wet (suspension) -
Bleaching Powder	SEE CHLORINATED LIME									
Calcium Hydroxide $Ca(OH)_2$	Hydrated lime slaked lime	pH adjust-ment and softening	Powder	80-95% $Ca(OH)_2$	Bags, barrels or bulk	White powder, caustic	Iron, steel or concrete	Saturated or 1-5% suspension	Dry (hopper) Not very soluble	Lead tanks should be used or wet can be fed in suspension
Calcium Hypochlorite $Ca(OCl)_2 \cdot 4H_2O$	HTH, Per-chloron, available	Disinfectant	Granules, tablets, powder, granules, available	60-70% Cl_2	Cans, drums	White granules of chlorine	Glass, rubber, plastic, stoneware, wood	1-3%	available solution	chemical, store dry, in well-ventilated area

ANNEX 4

COMMON CHEMICALS USED IN WATER TREATMENT

CaO	burnt lime chemical lime, unslaked lime	pH adjust- ment and softening	lump, pebbles, granules, powder	75-99%	Bags, barrels bulk	White to light grey, caustic	iron, steel or concrete	1-5% solution	Dry: allow to slake before applying Wet: can be fed in suspension	Lead tank should not be used. pH of saturated solution: 12.4
Carbon, Activated C	Activated carbon Aqua Nuchar, Hydrodarco Norite	Taste and odour control Dechlor- ination	Granules or powder	Not less than 80% C	Bags or bulk	Black granules or power insoluble	Iron or steel or plastic	Dry: in beds Wet: as slurry suspension	Wet: Drip	-
Chlorinated lime CaO.2CaOCl ₂ .3H ₂ O	Bleaching powder Chloride of lime	Disinfection Powder	Powder	25-37% available chlorine Cl ₂ (when fresh)	Drums	White, hygroscopic unstable, pungent powder	Plastic, stoneware, rubber tanks	1-2%	Wet	Deteriorates on storage losing strength. Store dry in well ventilated area
Chlorine Cl ₂	Chlorine gas Liquid Chlorine	Disinfection Taste & odour control general oxid- ant	Liquified gas under pressure	99-99.8% Cl ₂	Cylinders tanks (under pressure)	Green-yellow, pungent gas, corrosive, heavier than air, dangerous to handle and store	Dry: black iron, copper, steel Wet gas: glass hard rubber, silver	-	Wet using chlori- nator devices	Dangerous chemical, very careful handling required. Gas masks and other safety measures required
Copper sulphate CuSO ₄ .5H ₂ O	Blue vitriol, Bluestone	Algicide Molluscide	Crystals, lumps, powder	90-99% CuSO ₄ 5aq	Bags, barrels, drums	Clear blue crystals and powder	Stainless steel plastics	1-2% solution	Dry: put in linen bags and dragged in boats	-
Ferric chloride										
a) FeCl ₃ solution.	Ferrichlor, chloride or iron	Coagulant	Solution	35-45% FeCl ₃ 12-17% Fe	Ca. boys, tanks	Dark brown syrrupy solution, very cor- rosive	Glass, stoneware rubber and synthetic resins	3-5% solution	Wet pro- portional or drip feed	Optimus pH 4-11
b) FeCl ₃ .6H ₂ O	Crystal ferric chloride	Coagulant	Lumps, sticks, crystal	59-60% FeCl ₃ 20-21% Fe	Barrels	Yellow brown Very hygro- scopic lumps, very cor- rosive	Rubber lined tank or stoneware containers, plastic	3-5% solution	Wet pro- portional or drip feed	Optimum pH 4-11 Store in tight containers
c) FeCl ₃	Anhydrous ferric chloride	Coagulant	Powder crystals	98% FeCl ₃ 34% Fe	Casks kegs	Green-black powder	As above	3-5% solution	as above	Store in tight containers

Ferric Sulphate $Fe_2(SO_4)_3 \cdot 9H_2O$	Iron sulphate Ferrifloc, Ferrisol	Coagulant	Granules, Crystals, lumps	90-94% $Fe_2(SO_4)_3$ 26% Fe	Bags drums	Red brown powder, crystals or granules. Hygroscopic Very corro- sive solution	Dry: iron, steel and concrete. Wet: lead, stainless steel or plastic	3-6% solution	Wet: as above	Stains
Ferrous Sulphate $FeSO_4 \cdot 7H_2O$	Copperas, vitriol, sugar, sulphate	Coagulant	Lumps, granules	45-55% $FeSO_4$	Bags, barrels bulk (plastic)	Green- brownish yellow crystals; Hygroscopic Cakes & lumps on storage above 20° C.	Ash, Asphalt concrete, tin and wood	4-8% solution	Wet: as above	Optimum pH 8.5-10 Lime addition may be required
(when chlorinated known as chlorinated Copperas)										
Lime	see Calcium Hydroxide									
Silicon, activated SiO_2	Silica Sol Activated Silica	Coagulant aid	Produced on site as needed from Sodium silicate	25-30% SiO_2 8-15% Na_2O	Drums or bulk	Clear often opalescent syruddy liquid strongly alkaline	Mild steel Stainless steel or rubber	Wet only. Batches produced by dilution and acidifi- cation and then aged before addition	0.6%	Appliances liable to clogging unless pH adjusted properly
Soda Ash	See Sodium Carbonate									
Sodium aluminate $Na_2Al_2O_4$	Soda alum	Coagulant	Crystalline flakes (or solution)	43-55% Al_2O_3	Bags, drums or solution	White or grey crystals Liquid caustic & corrosive Hygroscopic	Iron, plastic, rubber, steel or concrete	5% solution	Dry with hopper agitation Wet	-
Sodium Carbonate Na_2CO_3	Soda Ash	pH adjust- ment Softening	Powder or crystals	98-99% Na_2CO_3	Bags, barrels or bulk	White powder Caustic	Iron, steel or rubber	1-10% solution	Dry with hopper agitation Wet	Generates heat pH of 1% solution 11.2
Sodium hexameta Phosphate ($NaPO_3$) ₆	Calgon, phosphate, vitreous phosphate	Softening Scale and corrosion prevention	Powder or flakes	60-63% P_2O_5	Bags	Opaque flakes like broken glass	Stainless steel, plastic hard rubber, glass fibre	0.25% solution	Wet only using drip or propor- tional devices	Holds up precipitation Protects mild steel

Sodium Hydroxide NaOH	Caustic soda Lye	pH adjustment softening and filter cleaning	Pellets, flakes, lumps (or solution)	96-99% NaOH	Drums, bulk	White, alkaline, very corrosive, hygroscopic and dangerous to touch	Cast iron, mild steel rubber lined	1-10% solution	Wet: proportioning pumps, orifice box	Protective clothing needed when making solutions. Much heat generated. pH of 1% solution 12.9
Sodium Hypochlorite NaOCl	Hypochlorite solution Bleach solution Eau de Javelle	Disinfection	Solution	10-15% Available Cl ₂ (when fresh)	Carboys, tankers	Pale yellow liquid. Gives off chlorine gas. Corrosive & alkaline	Ceramic, glass, plastic rubber	1-3% available Cl ₂	Wet: drip feed or direct	Handle with care
Sodium Sulphite Na ₂ SO ₃		Deoxygenation De-chlorination	Powder, lumps	90-99% Na ₂ SO ₃	Bags, drums	White powder	Stainless steel, plastics	1% solution	Wet: Proportional pumps	8 mg/l Na ₂ SO ₃ used to remove 1 mg/l O ₂
Sodium Thiosulphate Na ₂ S ₂ O ₃ · 5H ₂ O	Hypo	De-chlorination	Powder, Crystals	95-99% Na ₂ S ₂ O ₃	Bags	White crystals, or granules Very soluble	Cast iron, low carbon steel stoneware	1% solution	Wet: drip feed	-
Sulphur Dioxide SO ₂		De-chlorination or filter cleaning	Gas	100% SO ₂	Steel gas cylinders	Colourless pungent choking acidic gas	Steel	Dry	Dry	-
Sulphuric Acid H ₂ SO ₄	Vitriol	pH adjustment Lowering of alkalinity	Liquid	77% H ₂ SO ₄ or 98% H ₂ SO ₄	Glass, carboys	Colourless syrupy liquid. Extremely hazardous, corrosive, hygroscopic acid	Lead, glass lined steel tanks	1-2% solution Always add acid to large volume of stirred water	Wet dilute solution orifice box drip or rota- meter	Danger: when mixing add acid to water. Large amount of heat evolved & spitting may occur.

5 measurements conversion factors

LENGTH

1 INCH (IN)	= 25.4 MILLIMETRE (MM)
1 MILLIMETRE (MM)	= 0.0394 INCH (IN)
1 FOOT (FT)	= 0.3048 METRE (M)
1 METRE (M)	= 3.2808 FEET (FT)
1 YARD (YD)	= 0.9144 METRE (M)
1 MILE	= 1.6093 KILOMETRE (KM)
1 KILOMETRE (KM)	= 0.6214 MILE

AREA

1 SQUARE INCH (SQ IN)	= 6.4516 SQUARE CENTIMETRE (CM ²)
1 SQUARE CENTIMETRE (CM ²)	= 0.1550 SQUARE INCH (SQ IN)
1 SQUARE FOOT (SQ FT)	= 0.0929 SQUARE METRE (M ²)
1 SQUARE METRE (M ²)	= 10.7639 SQUARE FOOT (SQ FT)
1 SQUARE YARD (SQ YD)	= 0.8361 SQUARE METRE (M ²)
1 SQUARE MILE	= 2.59 SQUARE KILOMETRE (KM ²)
1 SQUARE KILOMETRE (KM ²)	= 0.3861 SQUARE MILE
1 ACRE	= 0.4047 HECTARE (HA)
1 HECTARE (HA)	= 2.4710 ACRE

VOLUME

1 CUBIC INCH (CU IN)	= 16.8871 CUBIC CENTIMETRE (CM ³)
1 CUBIC CENTIMETRE (CM ³)	= 0.06102 CUBIC INCH (CU IN)
1 CUBIC FOOT (CU FT)	= 28.317 LITRE (L)
1 CUBIC YARD (CU YD)	= 0.7646 CUBIC METRE (M ³)
1 ACRE FOOT (ACRE FT)	= 1233.48 CUBIC METRE (M ³)
1 (UK) GALLON* (GAL UK)	= 4.5461 LITRE (L)
1 LITRE (L)	= 0.2200 UK GALLON (GAL UK)
1 US GALLON (GAL US)	= 3.78533 LITRE (L)
1 LITRE (L)	= 0.264 US GALLON (GAL US)

FLOW

1 UK GALLON PER MINUTE (UK GAL/MIN)	= 272.77 LITRES PER HOUR (L/HR)
1 LITRE PER SECOND (L/SEC)	= 13.12 UK GALLON PER MINUTE (UK GAL/MIN)
1 US GALLON PER MINUTE (US GAL/MIN)	= 227.12 LITRES PER HOUR (L/HR)
1 LITRE PER SECOND (L/SEC)	= 15.85 US GALLON PER MINUTE (US GAL/MIN)

MASS (WEIGHT)

1 POUND (LB)	= 0.4536 KILOGRAM (KG)
1 KILOGRAM (KG)	= 2.2046 POUND (LB)

FORCE

1 POUND (LBF)	= 0.4586 KILOGRAM FORCE (KGF)
	= 4.4482 NEWTON (N)
1 KILOGRAM FORCE (KGF)	= 2.2046 POUND (LBF)

PRESSURE AND STRESS

1 POUND PER SQUARE INCH (PSI)**	= 0.0703 KILOGRAM (FORCE) PER SQUARE CENTIMETRE (KGF/CM ²)
1 KILOGRAM (FORCE) PER SQUARE CENTIMETRE (KGF/CM ²)	= 14.223 POUNDS PER SQUARE INCH (PSI)
1 POUND PER SQUARE FOOT (LB/SQ FT)	= 4.8824 KILOGRAM (FORCE) PER SQUARE METRE (KGF/M ²)
1 ATMOSPHERE (ATM)	= 1.0332 KILOGRAM (FORCE) PER SQUARE CENTIMETRE (KGF/CM ²)
	= 0.2048 POUND PER SQUARE FOOT (LB/SQ FT)

POWER

1 HORSE-POWER	= 0.7457 KILOWATT (KW)
1 KILOWATT (KW)	= 1.3410 HORSE-POWER (HP)
1 FOOT POUND PER SECOND (FT LB/SEC)	= 1.3558 WATT (W)

TREATMENT LOADING RATES

1 UK GALLON PER SQUARE FOOT PER HOUR (UK GAL/SQ FT/HR)	= 1.1744 CUBIC METRE PER SQUARE METRE PER DAY (M ³ /M ² /DAY)
1 CUBIC METRE PER SQUARE METRE PER DAY (M ³ /M ² /DAY)	= 0.8515 UK GALLON PER SQUARE FOOT PER HOUR (UK GAL/SQ FT/HR)

* ALSO KNOWN AS: IMPERIAL GALLON

** ALSO: LBF/SQ INCH

irc publications

IRC publishes a Technical Paper Series which provides expertise on selected topics in water supply and sanitation. These documents usually are produced as a joint effort of expert consultants, specialist contributors and IRC staff.

IRC Technical Papers are designed for selective use by various levels of staff engaged in water supply and sanitation: not only professional engineers and decision-makers, but also planning staff, public health officers and technicians.

IRC also publishes a Bulletin Series comprising reports of international expert meetings and seminars organized by IRC, bibliographies, and reference lists. The IRC Newsletter is issued monthly.

IRC publications of related interest to the present handbook include:

HANDPUMPS FOR USE IN DRINKING WATER SUPPLIES IN DEVELOPING COUNTRIES Prepared by F. E. McJunkin (TP 10)	230 pages	1977
SLOW SAND FILTRATION FOR COMMUNITY WATER SUPPLY IN DEVELOPING COUNTRIES – A DESIGN AND CONSTRUCTION MANUAL Prepared by J. V. van Dijk and J. H. C. M. Oomen (TP 11)	173 pages	1978
PUBLIC STANDPOST WATER SUPPLIES, A DESIGN MANUAL (TP 14)	91 pages	1979