

AT MICROFICHE
REFERENCE
LIBRARY

A project of Volunteers in Asia

Manual for Water Systems and Pipe Works

by: Andreas Bachmann and Nirman Joshi

Published by:

Swiss Association for Technical Assistance
P.O. Box 113
Kathmandu
Nepal

Free to serious groups.

Available from:

Swiss Association for Technical Assistance
P.O. Box 113
Kathmandu
Nepal

Reproduced by permission of the Swiss Association
for Technical Assistance.

Reproduction of this microfiche document in any
form is subject to the same restrictions as those
of the original document.

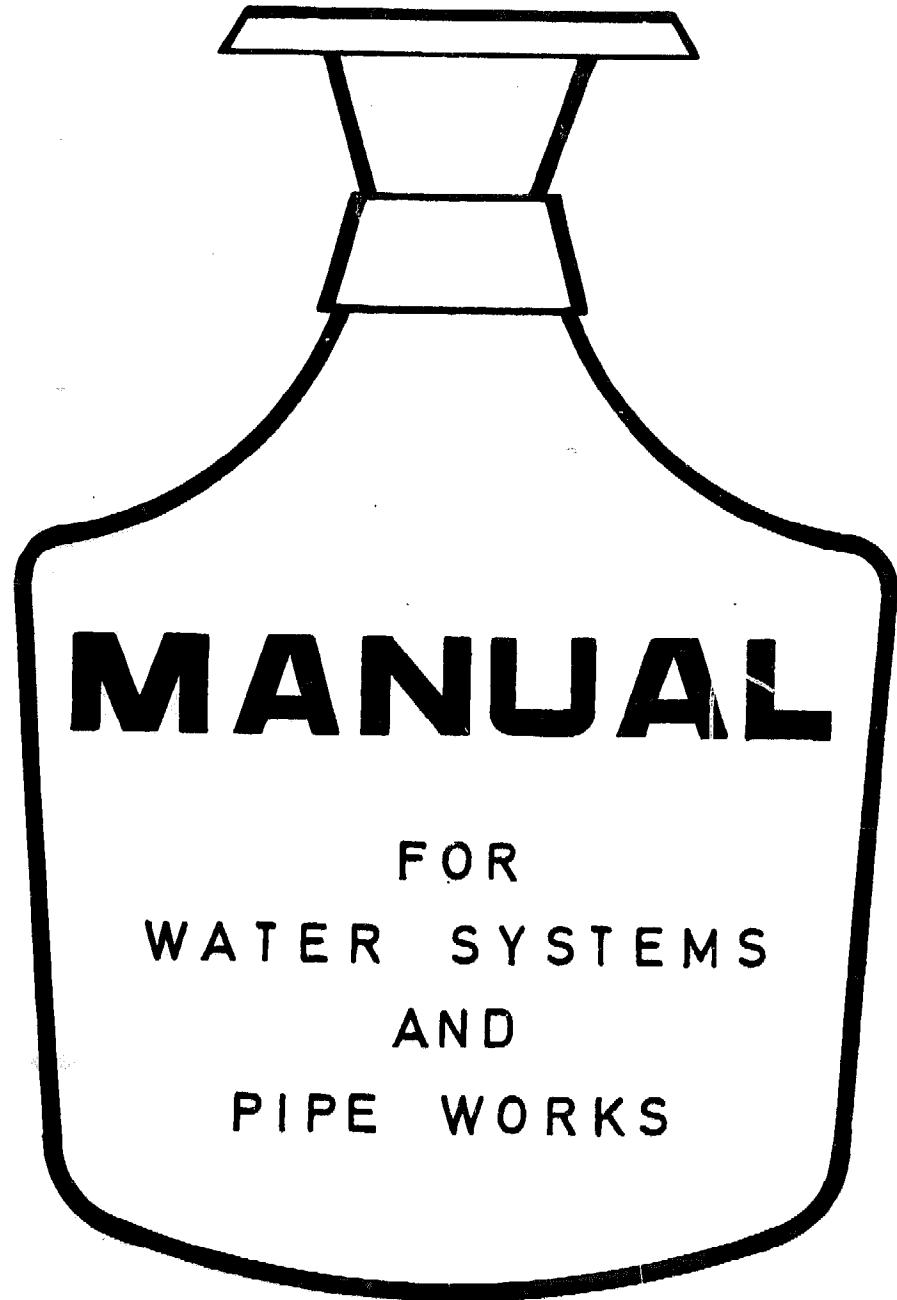
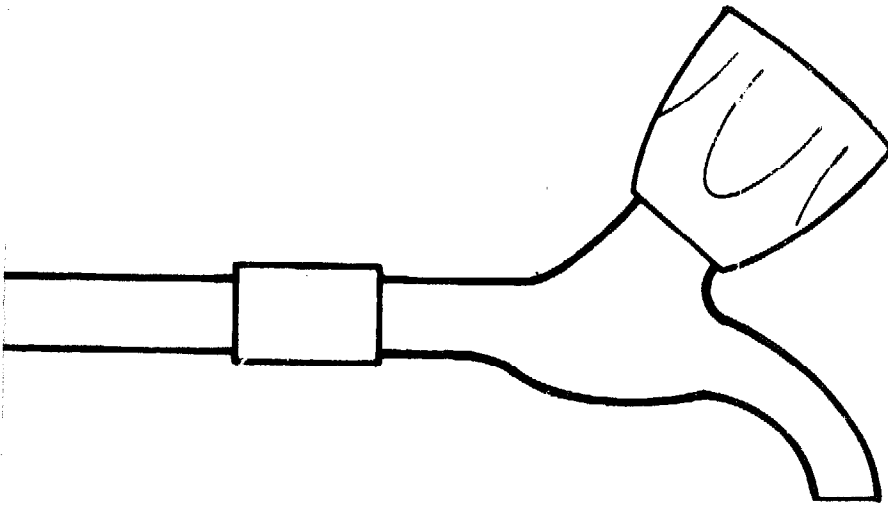

A B R I E F

INTRODUCTION COURSE

FOR THE ESTABLISHMENTS
OF RURAL WATER SUPPLIES
IN NEPAL

PREPARED BY: ANDREAS BACHMANN, SATA
NIRMAN JOSHI, DRAFTSMAN

SWISS ASSOCIATION FOR TECHNICAL ASSISTANCE,
S A T A, P. O. BOX 113
K A T H M A N D U / NEPAL

P R E F A C E

As rural water supplies became one of the prime tasks for the Himalayan Kingdom of Nepal it was soon recognised that plastic pipes would play a major role for the mostly quite difficult hilly terrain.

The first manual was worked out for Peace Corps workers in autumn 1974. It shows the basic principles of pipe work. It has since then been several times reprinted, also at the special request of the Nepal Government, Water Department.

It is hoped that this new edition will be useful for many more field workers willing to assist in improvements of living conditions in rural areas.

Andreas Bachmann
S A T A / Kathmandu
June 1980

C O N T E N T S

1.	<u>Introduction</u>	
1.1.	Importance of water	1
1.2.	Development of sources, quality and quantity ...	2
2.	<u>Water Supplies</u>	
2.1.	Natural Gravity System	3
2.2.	Pumped Gravity System	4
2.3.	Hydraulic Ram	5
2.4.	Loss of Head / Chart	6
3.	<u>Water Conduit</u>	
3.1.	Trenches and Pipelines	7
3.2.	Manhole, Special Standpipe	8
3.3.	Water Prevention Device	9
3.3.	Water Prevention Device / Sketch	10
3.4.	Water Place, Standpipe	11
3.5.	Valves	12
3.6.	Special Valves	13
4.	<u>Galvanized Pipes</u>	
4.1.	Use, rules, pipe measurements, length of threads .	14
4.2.	Thread cutting, watertight joints and threads	15
4.3.	Nipple cutting, connection to concrete	16
4.4.	Galv. Fittings	17

5.	<u>Plastic Pipes</u>	
5.1.	Introduction	18
5.2.	Transport and Storage	19
5.3.	Preparation of Trenches and Laying of Pipes	20
5.4.	Connection of Galv. Pipes and Plastic Pipes	21

6.	<u>P V C - Pipes</u>	
6.1.	Use, rules, preparing of a spigot end	22
6.2.	Solvent cement joints, points to remember	23
6.3.	Sockets and Bends	24

7.	<u>H D P E - Pipes</u>	
7.1.	Use, Rules	25
7.2.	Handling of Pipe Coils	26
7.3.	Welding	27
7.4.	Branch 45°	28
7.5.	Branch 60°	29
7.6.	Branch 90°	30
7.7.	Bends and Elbows 45° + 90°	31
7.8.	Endcap	32
7.9.	Conical Reducer	33
7.10.	Endcap (and 1st. step for low-pressure reducer) ..	34
7.11.	Reducer (low pressure)	35
7.12.	Reducer, for small differences in diameters	36
7.13.	Reduced Branch	37
7.14.	HDPE - Tools	38
7.15.	Blow Lamp	39

1.1. INTRODUCTION

Importance of Water

- Water is essential for life
- Water is essential for health and sanitation
- Water is the principal raw material for food production
- Water is important for many uses outside the home and on the farm
- Water conservation and sanitation are important to everyone

The Water Cycle

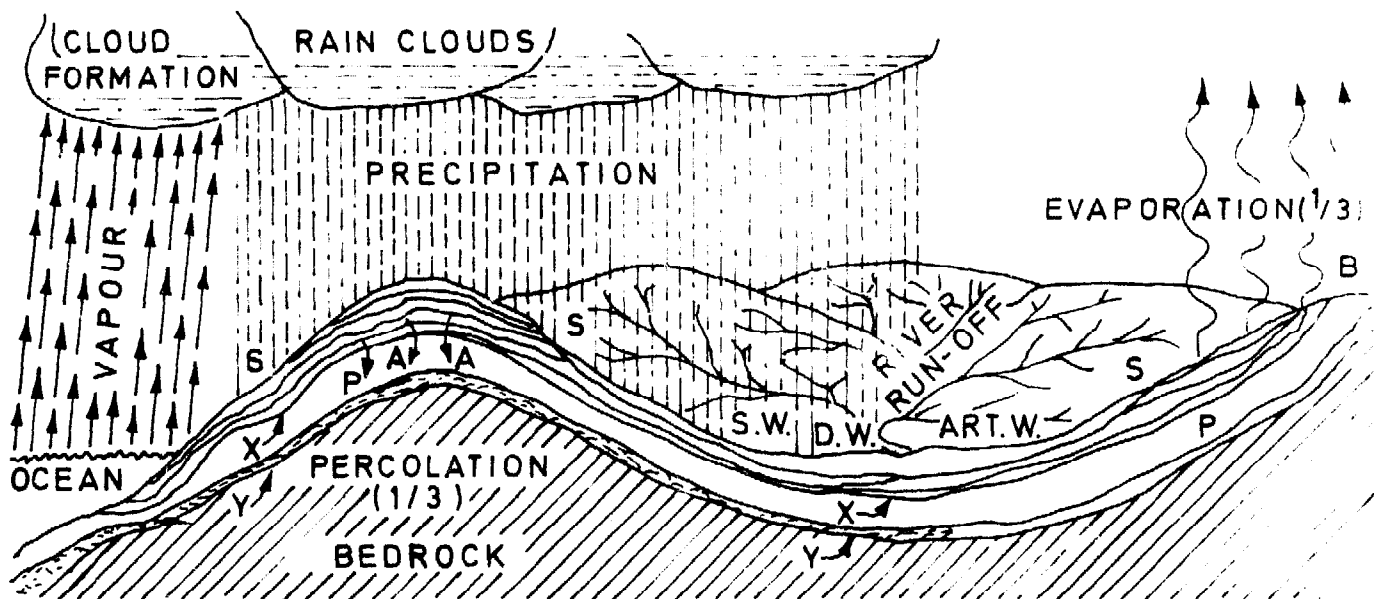

S	=	SPRINGS	P	=	POROUS STRATA
SW + DW	=	SPRINGS OR WELLS	X+Y	=	WATERTIGHT STRATA
ART. W.	=	ARTESIAN WELL			

A cross section of a possible arrangement of the earth crust showing how water may be distributed over and through it.

A part of the rainfall runs off at the surface forming creeks and rivers; a part may soak into the ground and return to the surface at springs or wells.

Yet another portion may percolate deeper through cracks and faults. (A-A and B) into a porous strata (P) where it may be carried many kilometers to the ocean or to artesian wells..

Sources of water for domestic use

- Rain Water
- Natural Surface Water
- Ground Water

1.2. I N T R O D U C T I O N

Development of sources of water

Any new or untried source of water should be examined for quality before expensive development is undertaken.

For watering animals, spraying and irrigation it should at least be clear and free of any materials, minerals, tastes or odors, which would be harmful or objectionable to plants or animals.

Quality

The water must be free of

- harmful bacterias
- objectionable minerals
- tastes or odors
- sediment = to be clear, without color
- temperature low (appr. 10°C (50 °F))

Quantity

need for life - 15 ltr (appr. 3 1/2 gallons)
per day and person

need for life - 50 ltr (appr. 11 gallons)
per day and person

Definations as applied to water

When used in connection with handling water, head refers to the vertical height of a column of water above a certain point, and is considered as causing or counteracting the flow of water. For example, if water stands at a height of 6 meters (20 feet), there will be 6 meters (20') of head in the bottom of the pipe. This pressure is expressed in terms in kg per cm² (or pounds per square inch, psi). A column of water with 10 meters of height (10 meters head) will have a pressure of 1 kg/cm² (At 6 m = 0.6 kg/cm²).

Gravity head is the actual vertical height of a column of water above the reference point.

Pressure Pressure head is the vertical height in meter (feet) to which any given pressure will force water. One kg per cm² will force water to a height of 10 m. (or one pound to a height of 2.3 feet).

Suction head a term applied to pumps, is considered as the total equivalent head in meter (feet) on the suction side of the pump against which the pump must work in order to get water.

The equivalent suction head is made up of

gravity head + friction head

Most pumps are guaranteed to work against 7 m (22') of total suction head at sea level (As more the altitude as less can be the suction head)!

NATURAL GRAVITY SYSTEM

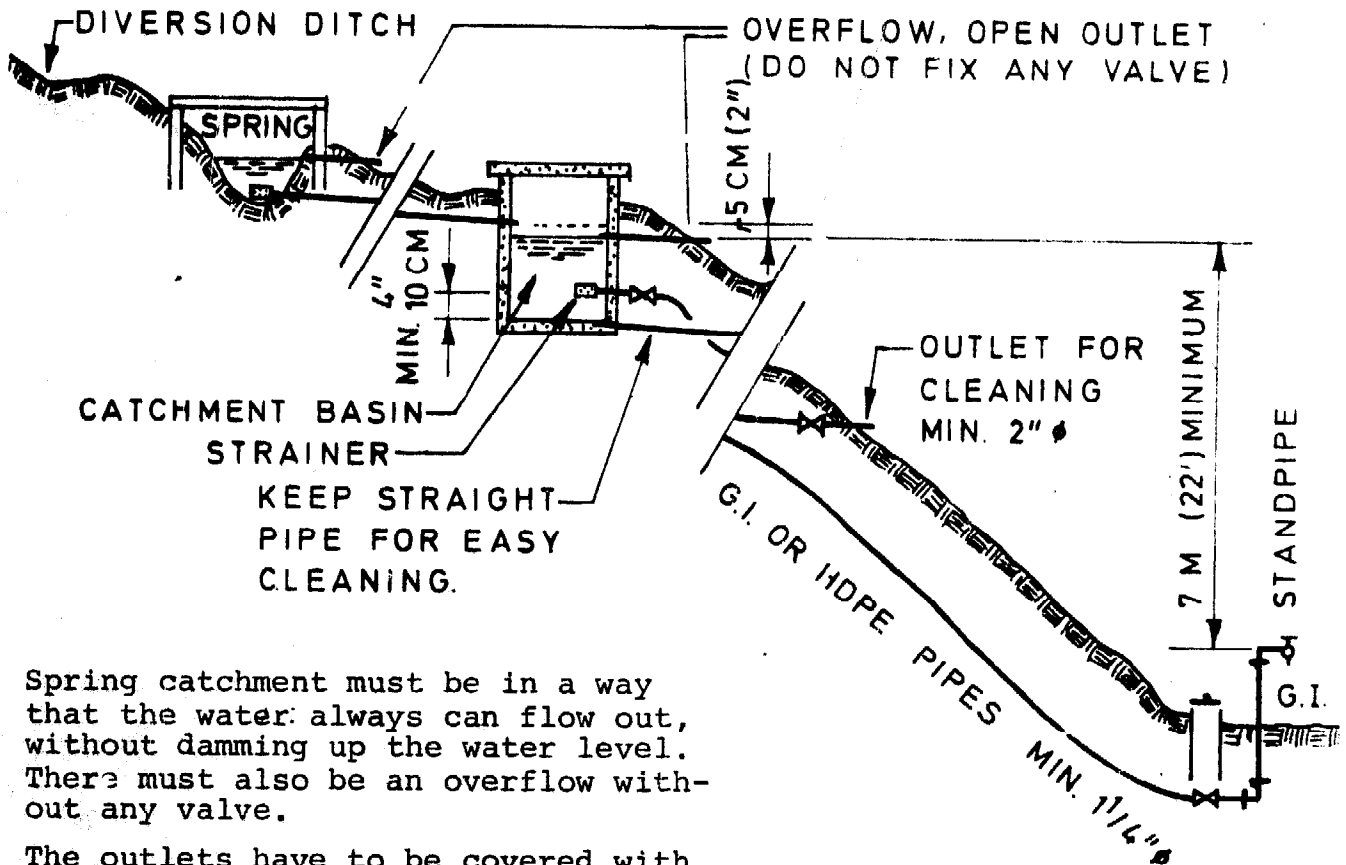

Spring catchment must be in a way that the water always can flow out, without damming up the water level. There must also be an overflow without any valve.

The outlets have to be covered with screen, so that no dirt or animal can block the pipe.

Gravity Type

A gravity water system is one having a tank or a storage reservoir located higher than the faucets from which tank or reservoir water flows to the faucets by the force of gravity.

There are two common types of gravity systems. One is "natural" gravity where the source of the water is high enough above the faucets to provide a satisfactory flow. The other is the "pumped" system where a pump is used to elevate the water to a gravity storage tank located above the faucets.

Natural Gravity System

The natural gravity system should be considered only when the source of water is high enough above the faucets (stand pipes or buildings) to give adequate flow.

Unless the spring has a strong flow, a catchment basin should be built below the spring as shown. For a satisfactory flow there may be at least 7 meters (22') of elevation on the highest faucets. If the system has a great distance, more than 7 meters is desirable.

A source to be developed should provide an adequate year-round supply of good quality water. Special attention should be given to catchment basins, size and material of pipe to use, and protection from contamination or pollution.

2.2. WATER SUPPLY

PUMPED GRAVITY SYSTEM

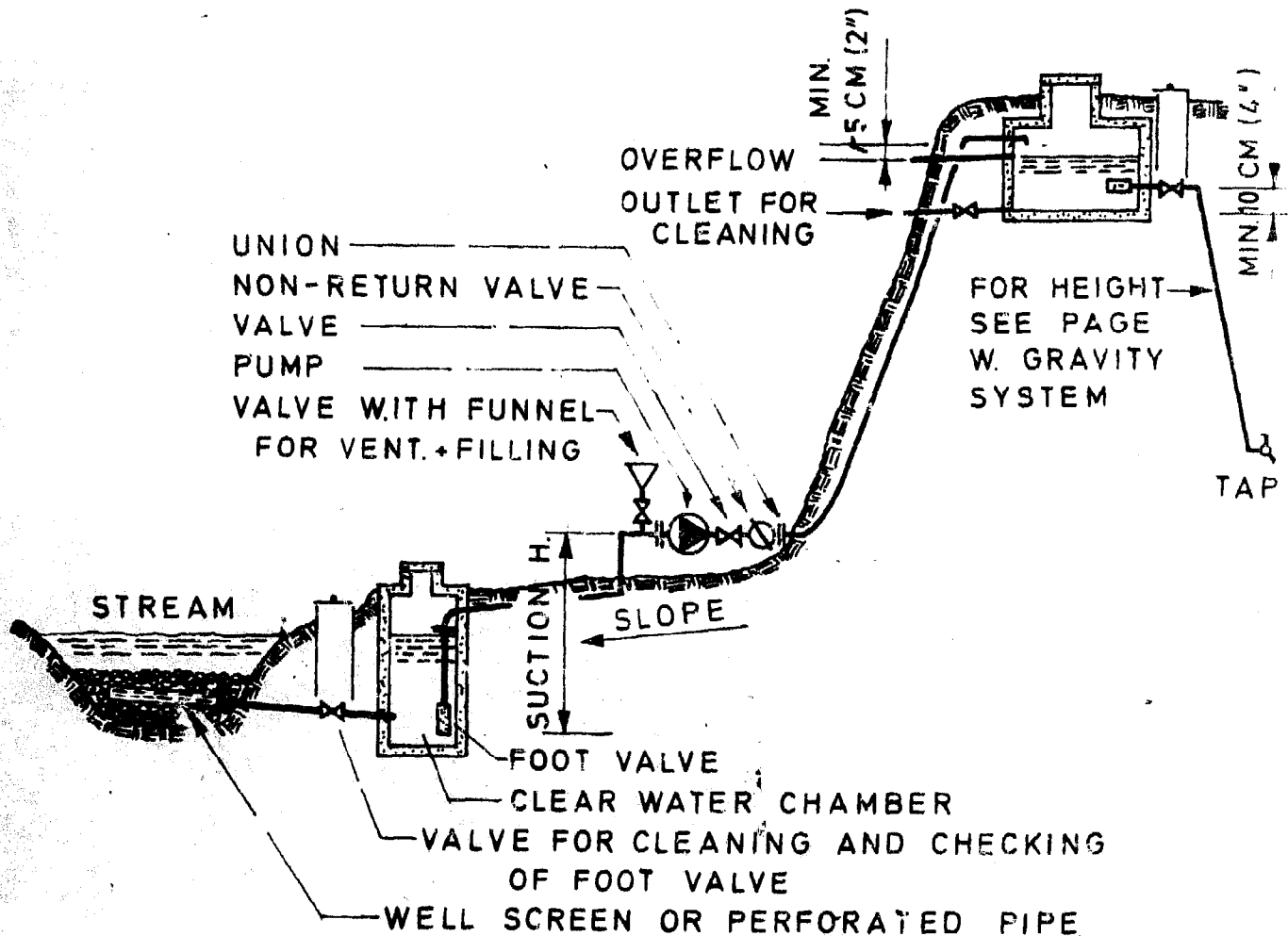

SH= Suction Head. Has to be as low and short as possible. The head is made up of gravity and friction (= loss). The absolutely maximum of head (GH + FH) is 7 m (22') at sea level.

Pumped Gravity Systems

If there is no possibility for a natural gravity system, there remains the pumped gravity system. But they are not always recommendable: pumps are expensive, need quite some maintenance (service through specialists) may use expensive fuel, with the exception of the Hydraulic Ram.

However, for big quantities and/or if there is only this possibility it is a very satisfactory system.

A large storage capacity is desirable to provide water for days, it needs a less frequent starting of the engine.

2.3. WATER SUPPLY

Hydraulic Ram

The Hydraulic Ram is an automatic pump which by means of a relatively small gradient raises a part of the available spring or stream water to a much higher point.

Example: The spring or stream water is being collected in a reservoir. From here a part of this water is to be lifted to the supply reservoir. For this purpose the water is being fed through a pressure pipe into the ram. A part of this volume is then being raised through the supply pipe to the reservoir.

The proportion between pressure pipe quantity + supply pipe quantity can be

from: 100 % up to 3 %
100 % up to 24 %

L = LENGTH OF PRESSURE PIPE 4-5 x H
A = 30-40 cm (12-16")
B = AT LEAST 10 CM (4")

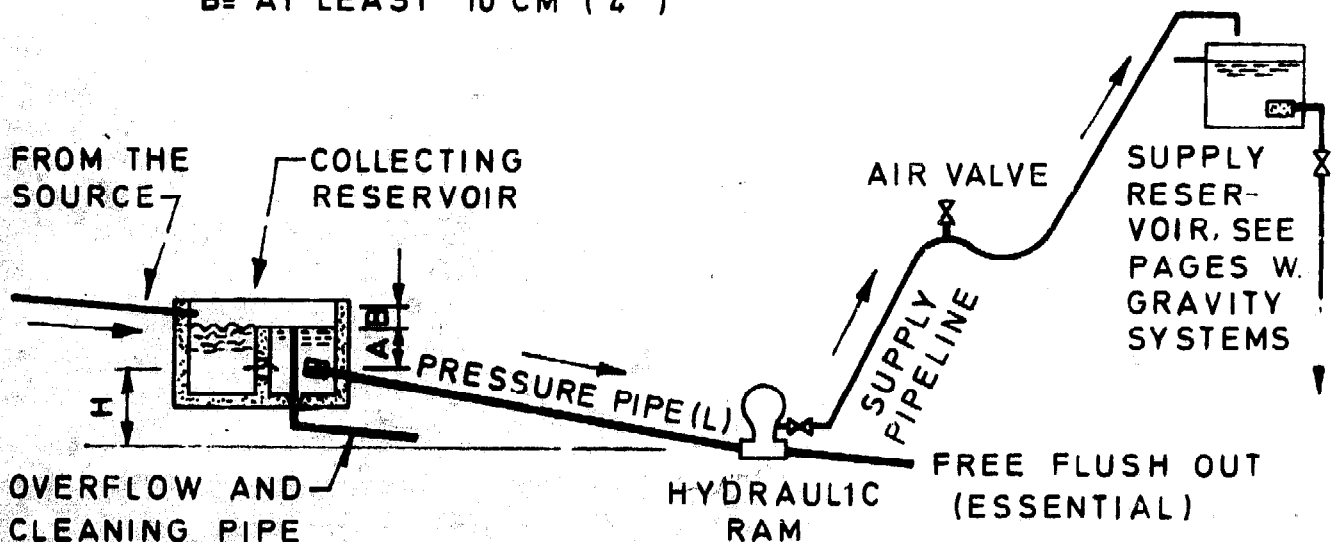

Collecting Reservoir: The water available is collected in a reservoir or basin. As far as the water is taken from a stream, this latter can be dammed up for this purpose. The collecting tank can be made in any desired size. It is however essential, that the pressure pipe intake is always covered under at least 30-40 cm (12-16"). The collecting reservoir must furthermore be constructed in a way which excludes any possibility of air bubbles entering the pressure pipe. Air bubbles in the pressure pipe would hamper the proper operation of the ram.

Pressure Pipe: the pressure pipe line must be installed with a great care. It must in particular be absolutely tight.

Caution: An installation of a ram is a very particular matter, it needs founded knowledge. Before ordering a hydraulic ram, contact a specialist.

LOSS OF HEAD

— GALVANIZED
STEEL

-- PLASTICS
LEAD
COPPER

10
8
6
4
3
2

1.0
.8
.6
.4
.3
.2
.1
.05

FLOW RATE IN LITERS PER SEC.

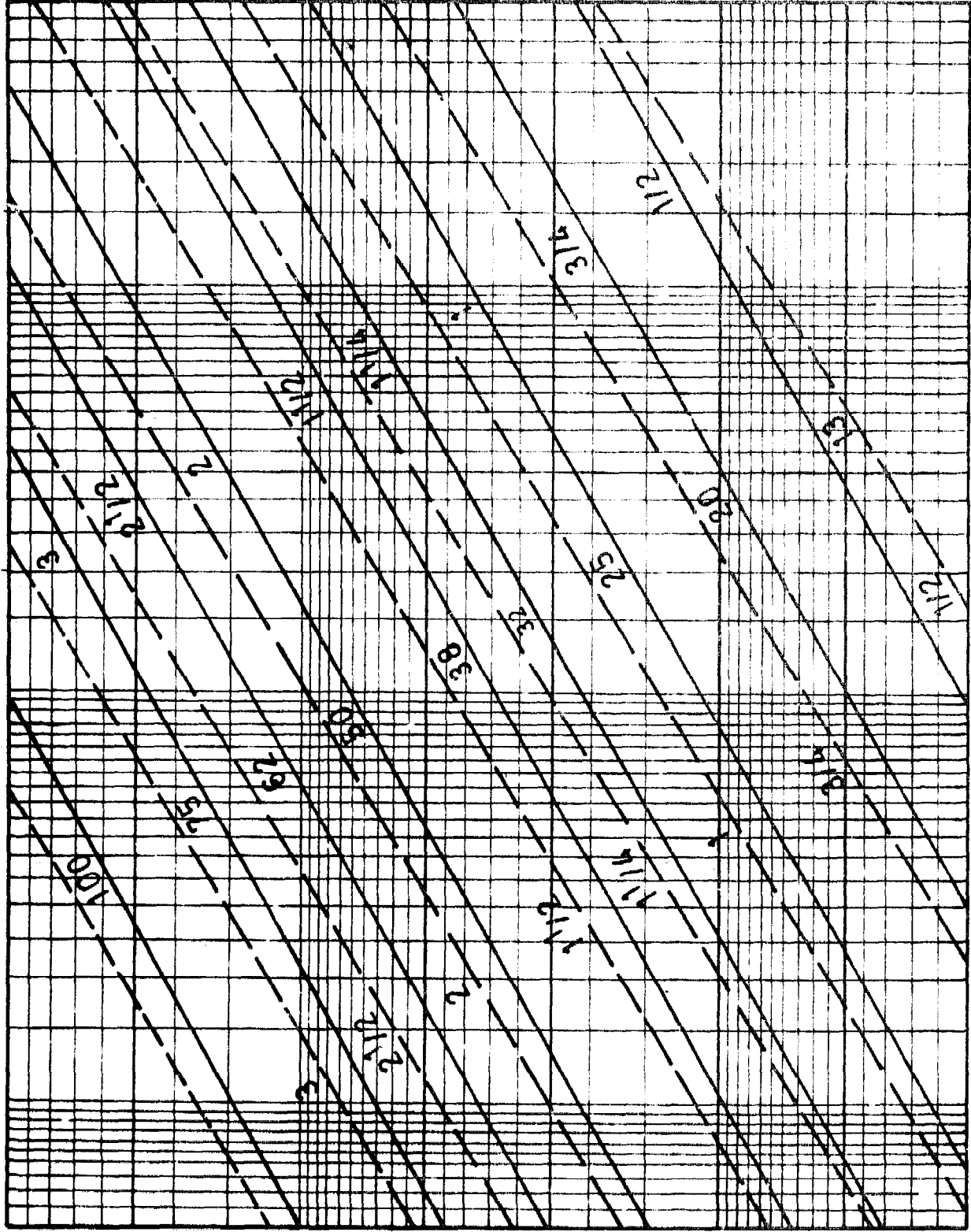

0.001 .002 .005 .01 .02 .05 .10 .2 .3 .4 .6 .8 1.0
LOSS OF HEAD IN METERS PER METER RUN

3.1. WATER CONDUIT

Pipelines: don't bring drinking water to a place before the drainage is assured! (MOISTURE brings insects and illness).

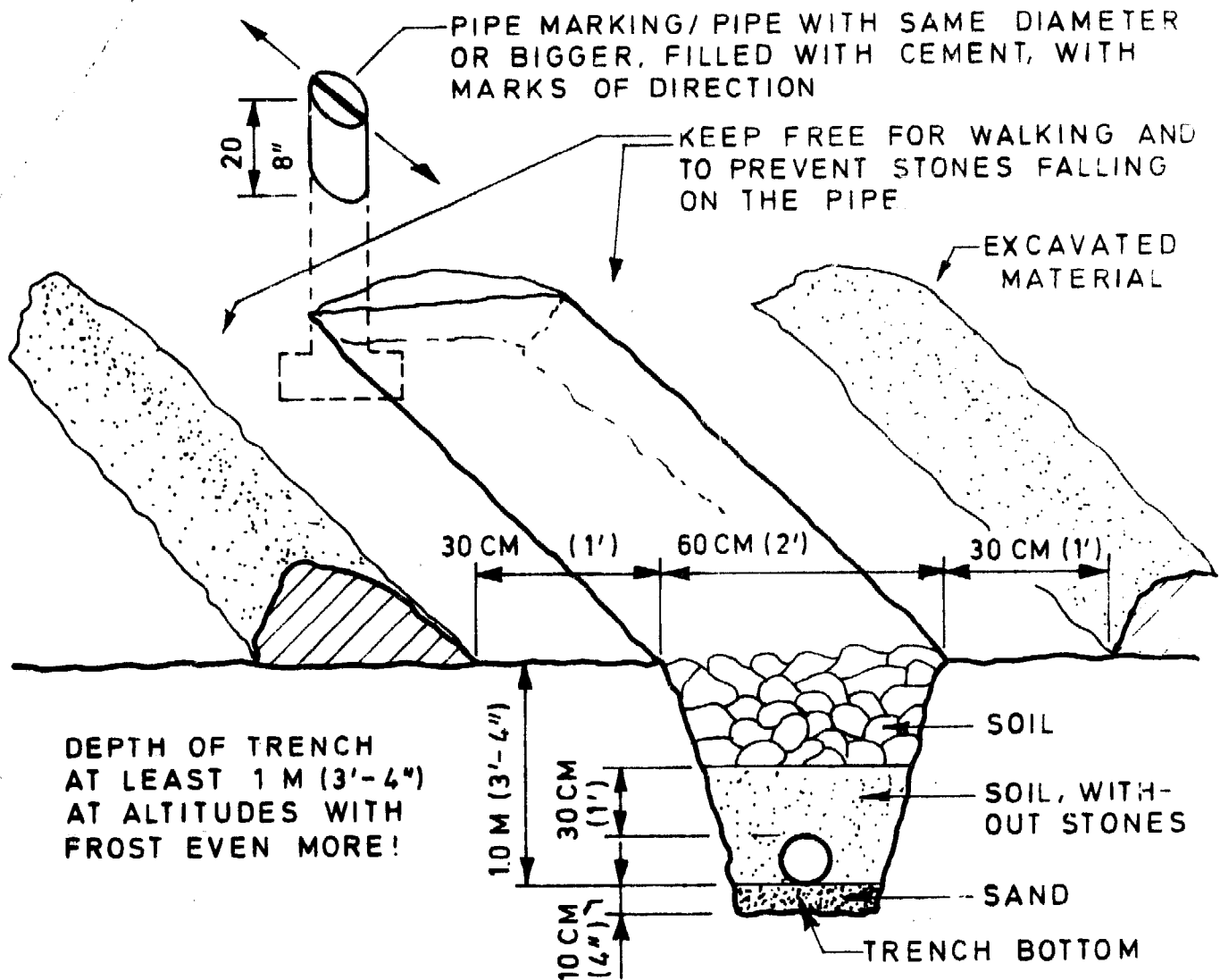

Before refilling a trench:-make sure that the pipe system is tight, waterproof!
-make a plan how the pipe lies in the ground.

Pipes should be in the ground, where they are protected against mechanical damage. The temperature also will be better. The depth of a trench may be at least 1.0 m (3'-4"), otherwise there could be the risk that they will be dug out by the farmers for irrigation.

Don't let pressure in the pipeline before the trench is filled up in the correct way. Otherwise remains the risk, that it will never be done!

Always look through the pipes before you install them and close the open ends immediately, and if it is only for a few minutes!

3.2. WATER CONDUIT

Manhole

By changing the direction in the ground make always big bends. The best solution (by low pressure distribution only) is a manhole. This for the reasons of cleaning and also for blocked pipelines.

Pipelines in the ground should have a diameter of at least 1 1/4". (Exceptions: branchline to standpipes).

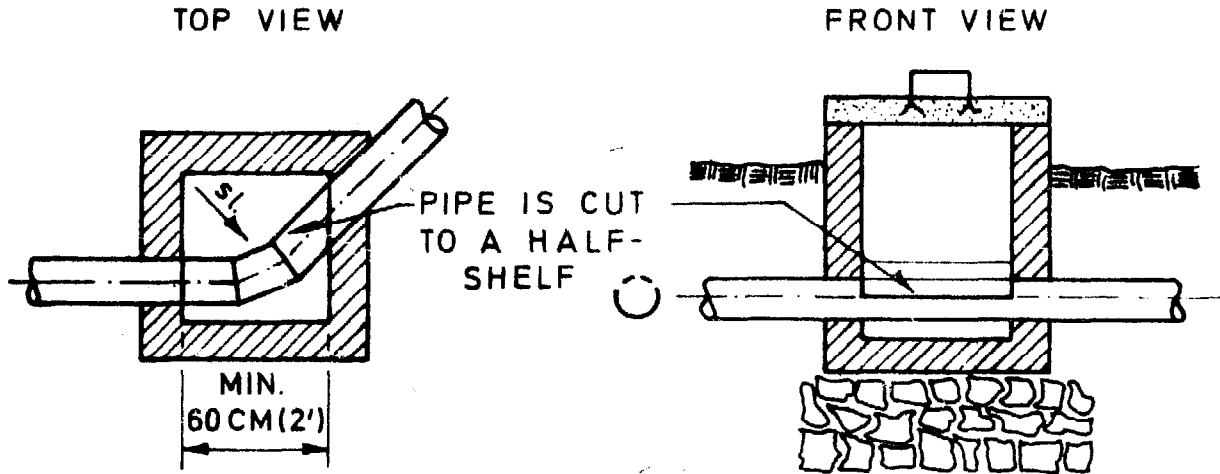

Standpipe with reservoir and pump

Water shortage, remains a good possibility, as shown. Shortage because there is not enough water, or because the people don't close the valve.

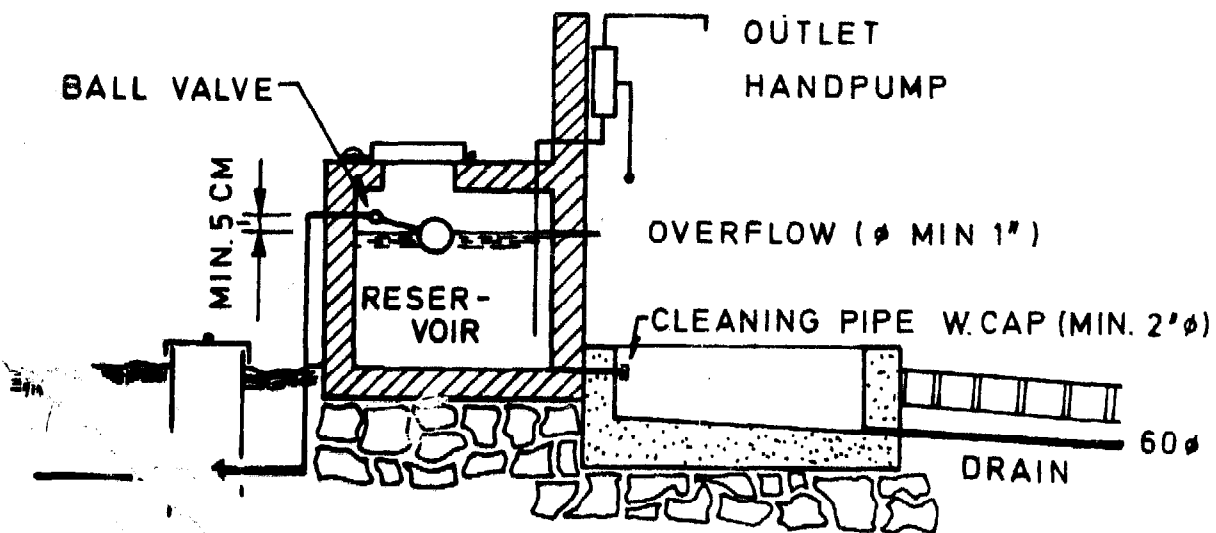

FOR STAND PIPE CONSTRUCTION SEE SEPARATE PAGE!

3.3. WATER CONDUIT

Water Prevention Device (WHO-Design)

This shows an idea for a waste prevention standpipe. This is less applicable to the type of hand-pumped supply, but for gravity or piped systems.

The principle is based on the fact that most common water container used in many parts of the world is a kerosene tin which holds little less than 20 liters. A standpipe constructed of a pipe with 150 mm diameter (6"), inside which slides a free piston. The capacity of the 150 mm pipe in the appr. 1 meter length between the top of the piston in its lowest position and the outlet top is 20 liters.

The piston incorporates a short length of small diameter pipe, say 10 mm diameter which, by passing water from below to above permits the piston to sink slowly by its own weight when the pressure on the two sides is equal, so that its normal position is at the bottom of the standpipe. Its weight is adjusted so that it will raise under the pressure of incoming water when the tap is opened, and sink as described when the tap is closed.

When villagers open the tap, water from the top side of the piston runs into her container, and the piston is raised by the water pressure below. When 20 liters has been withdrawn, the piston reaches its highest position, and the mouth of the 10 mm pipe seals itself against the rubber stop. As long as the tap remains open, the water pressure below holds the piston in this position, and no more water can be drawn off. In order to fill another container, it is necessary to close the tap long enough for the piston to sink its lowest position, where another cycle starts.

(see ref. WHO)

Self Closing Hydrant

The idea is brilliant. When the hydrant is made by professionals it surely works to perfection, but when made at home by a more or less skillful mechanic, it is not quite successful. Unless the mechanic has the necessary tools to make the inside of the tube perfectly smooth, and to give the piston the very close yet free running fit, the hydrant will leak. This has been the experience.

We would suggest a slight change. Instead of having the outlet pipe at the side of the tube to be blocked by the piston put it in the center at the top of the tube. This way the very outlet is plugged, and even if some water does leak past between the piston and tube merely goes above the piston, but simply cannot flow out.

Another useful suggestion: eliminate the tap. Taps manufactured in the Orient are a perpetual source of trouble. Four of our taps that worked well were stolen, one after the other. The open end of the outlet can quite easily be blocked by the user's hand till the piston drops.

(see ref, MINI TECHNOLOGY)

3.3. WATER CONDUIT

Waste Water Prevention

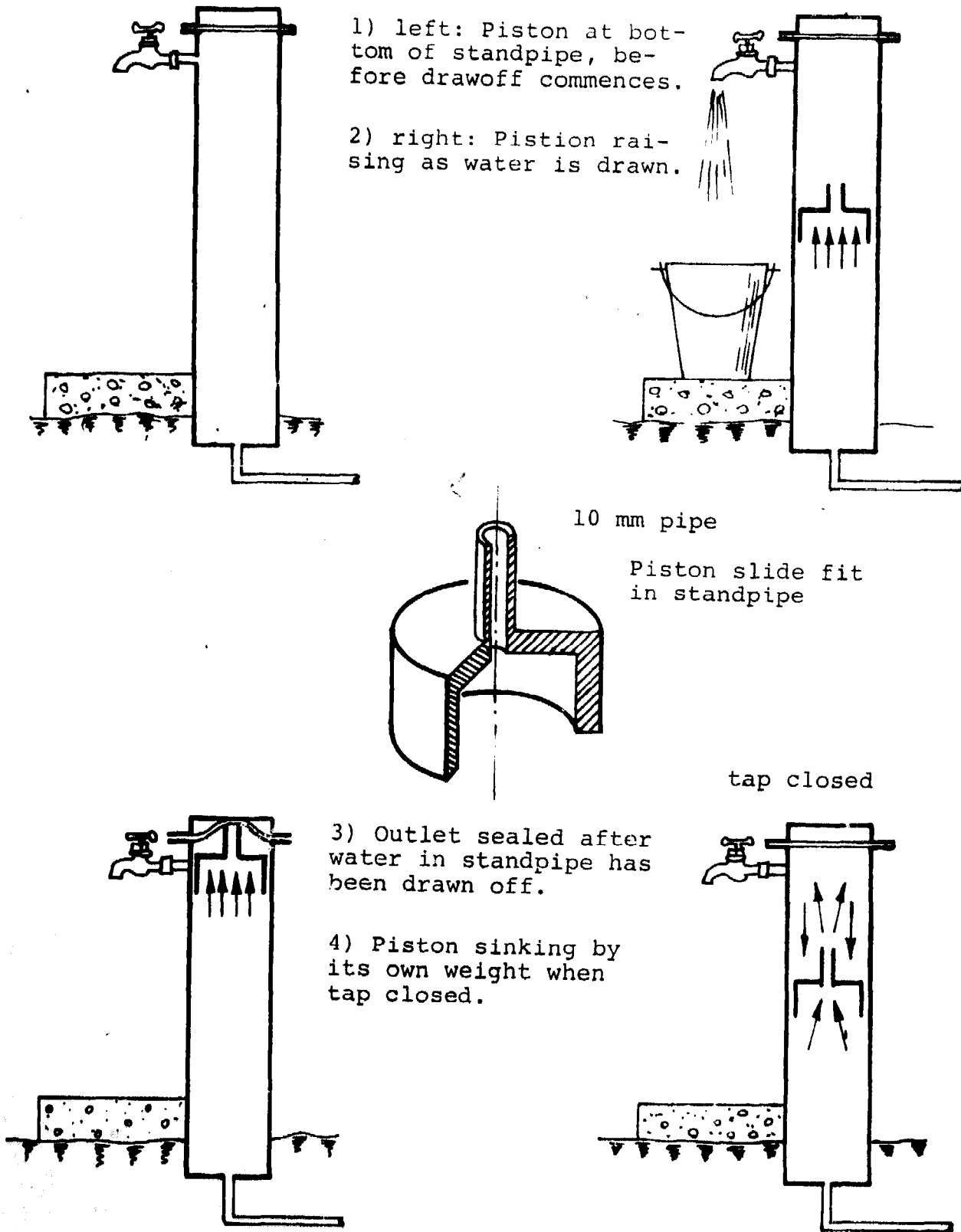

Schematic, not to scale
(see ref. WHO)

3.4. WATER PLACE

Standpipe

A bad water place makes bad situation worse!

Take great care for the place itself, and the place around. The waste water outlet (drainage) is absolutely obligatory (Moisture brings dirt, insects and sickness).

Don't open the system before every work is finished, the risk that it will not be done afterwards is very possible.

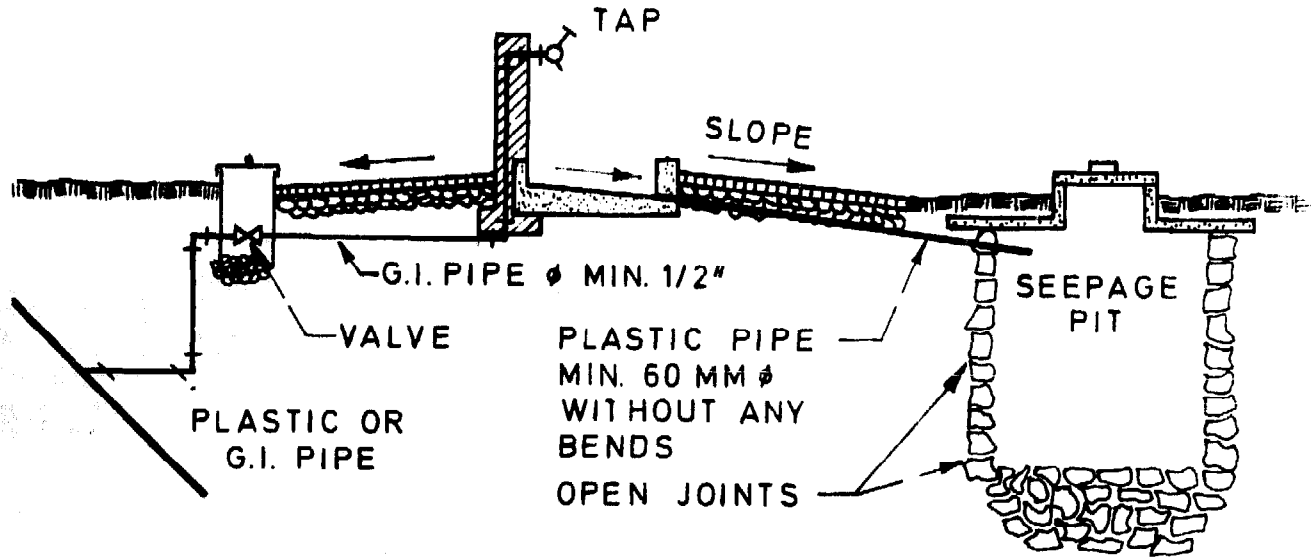

HARD COVER (STONES, BRICKS CONCRETE)

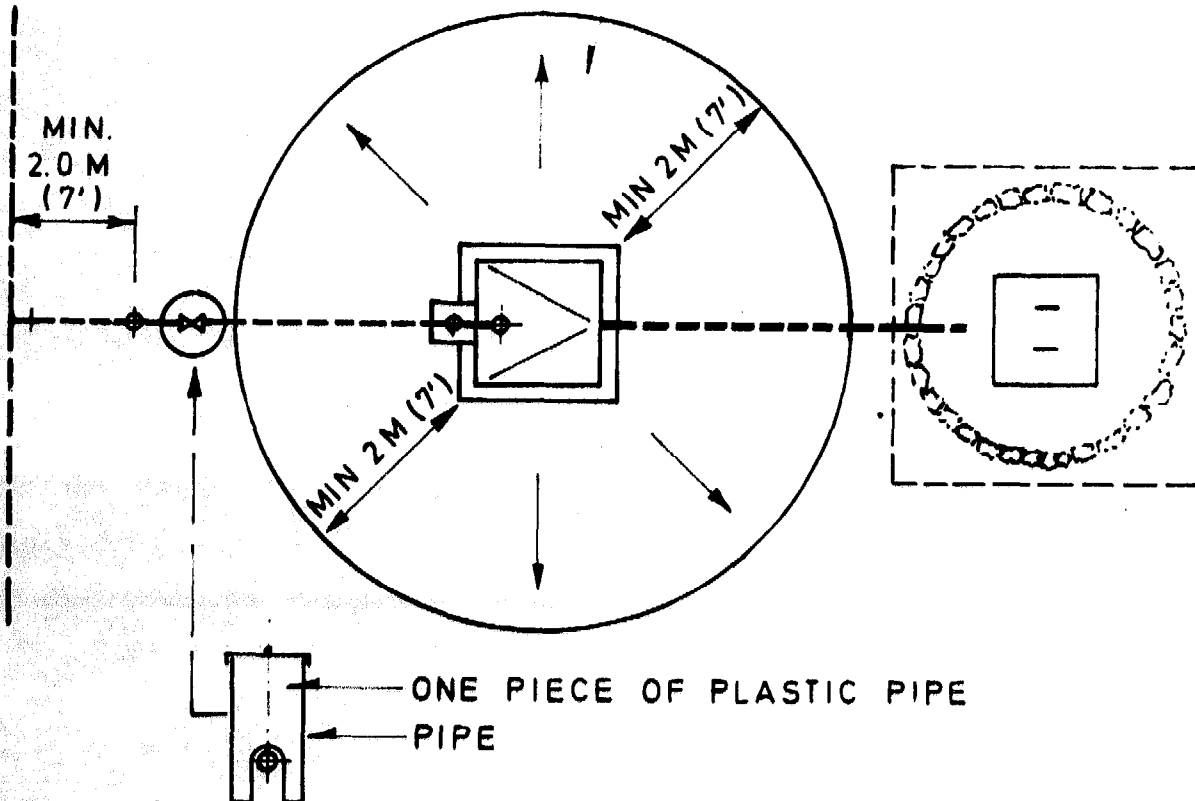

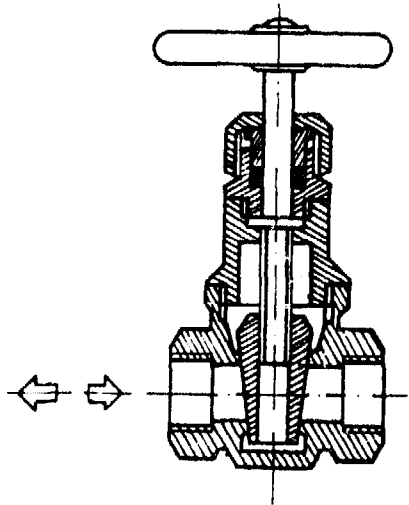

Gate valve (stop valve).

The seat openings are usually of the same diameter as the inside of the pipes. They have very little resistance to the flow of water, when the valve is completely open.

Use: in main-pipelines, before the taps. There where water tightness is not so important.

Not to be used: as outflush valve, (too high speed in the pipeline, and not really watertight) therefore take a good tap (with rubber washer).

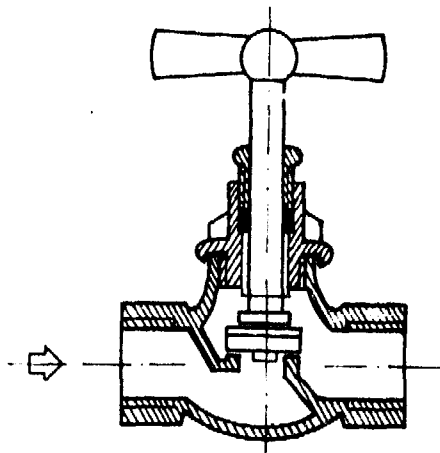

Globe valve (stop cock, fern)

This valve has to be installed with the water pressure under the valve seat.

A globe valve can be repaired quite easily with the change of the rubber washer, and is watertight. But the friction loss is quite high.

Use: for smaller diameters.

Not to be used: as drain valve e.g. outflush valve for reservoirs, etc.

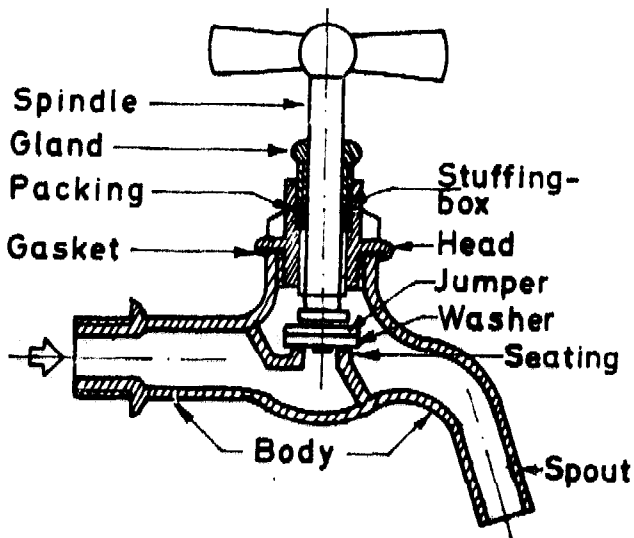

Bib cock (tap, faucet).

The bib cock close against the water pressure. When it is open, the passage is relatively free for the water.

The spout may or may not be threaded (for hose connection).

Foot - valves

Use: for suction-pipes in pumped-systems

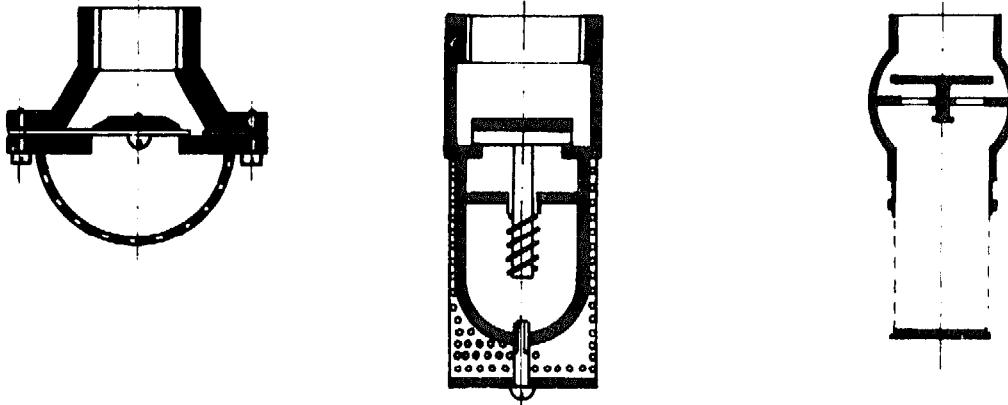

Use: pumped systems, on the end by suction pipes

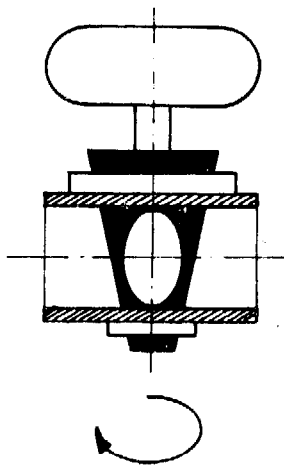

Plug - valve

Use: for gas-installations only.

(They are not watertight and the waterflow is stopped too fast. That may produce water-hammers and damage the pipe-installations).

non-return valves

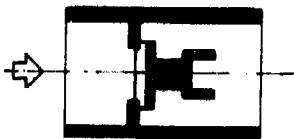

vertical check

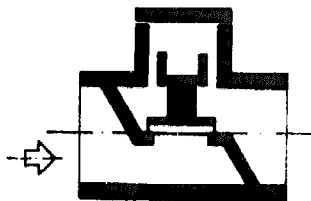

horizontal check

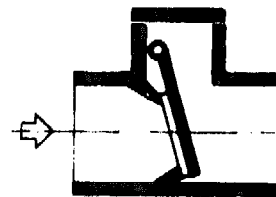

swing check

Use: Prevention of returning of the water; where the water has to remain in the pipes. By pumped gravity systems and by installation of the hot water storage tanks (boilers, geysirs), but also with safety valve (or vent.-pipe) only.

Recommendation Use the check if possible with swing-plate, where low pressure system is made. It has a big passage and little friction loss.

4.1. GALV. PIPES

G.I. Pipes (galvanized iron pipes)

Use: inside buildings (high mechanical resistance),
electrical conducting

- | | |
|--|---|
| <ul style="list-style-type: none"> + mechanical resistance + fittings available + good for smaller diameters + few extension with changes of temperature + good connection with cement (after the removing of the galvanization). | <ul style="list-style-type: none"> - high friction (loss of head = reduction of pressure and quantity) - no possibility to make the fittings (because of galv.) - no resistance against chemical corrosion (rust) - pieces up to 6 m (20') only = many joints - without flanges, only good joints up to the diameter of max. 2" - quite heavy |
|--|---|

Never put union's (or flanges) in the ground or wall (Because there will be no chances of inspection and maintenance)

Painting in ground and walls is necessary as protection against corrosion (danger of rusting).

By using 6.0 m pieces cut of the half of the factory-made thread (with a hacksaw) and cut a new, full length thread.

No bends of G.I. pipes to be made without using the proper fittings (By bending the pipes the galvanization will split off= risk of rusting).

Ø	outside Ø in mm	appr. weight / m in kg *	length of thread (unscrew-length) in mm
1/2	21.3	1.2	13
3/4	26.9	1.5	15
1"	33.7	2.4	17
1 1/4	42.4	3.1	19
1 1/2	48.3	3.6	19
2"	60.3	5.0	24
2 1/2	76.1	6.5	27
3"	88.9	8.4	30

* the weight of the pipe is depending on its quality resp. wall-thickness.

Pressure resistance: (depending on the quality)

1/2 - 3/4 appr. 25 kg/cm² (max)

1" - 4" appr. 16 kg/cm² (max)

4.2. GALV. PIPES

G.I. pipes / Thread cutting

1. Check the quality of the pipe, (correct welded seam, proper galvanization, diameter accurate)
2. fix the pipe in pipe vice
3. cut the length and after the thread (Never cut threads without using oil)
4. check the length of the thread
5. clean it from oil and steel splitters
6. put hemp and joint-paste (putty or animal grease)

Checking: if the thread is properly cut, it should be possible to screw appr. 65% of the threaded portion into a fitting by hand.

Plumber threads are conical. The fittings will spoil if they are unscrewed the whole length; appr. two turns of the thread should remain visible. Protection against rust: apply a layer of paint.

Caution: Gate valves, globe valves and similar items should be easily removeable for overhaul or replacement, without dismantling much of the line. For this purpose long threading, unions or flanges should be fitted close to such parts.

Cutting pipes with pipe-cutter requires that the pipes be reamed for burring. Better use only hacksaw for cutting.

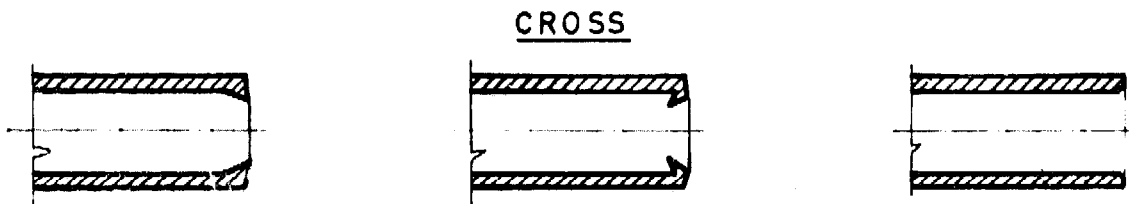

The burr made by
a pipe cutter

Improper reaming

Pipe properly
reamed

Watertight joints on threads

Use dry hemp only (candle wicking) and non-poisonous joint paste, (putty or animal grease). Paint as joint paste is not recommended because it dries hard.

1. Turn hemp in clockwise direction, starting at the beginning (end of the pipe) of the thread, covering the entire thread with hemp.
2. Put pipe joint paste on the hemp of the thread, check that no hemp, oil or joint paste is inside the pipe.
3. Start the fitting on the pipe by hand and tighten with the pipe wrench until reasonably tight. If turned too tight, the fitting may stretch or crack (2 turns should remain visible).
4. Cut off the hemp with an old hacksaw blade, by moving anti-clockwise. Paint the visible part of the thread.

4.3. GALV. PIPES

G.I. Pipes / Nipple cutting

1. Cut thread at the end of a pipe
2. Mark the length of the nipple and cut it off.
3. Cut the end on the other end of the nipple. As it is too short to be chucked in the vice directly, the nipple must be extended. Use a suitable pipe with a socket at the end. On these must be long threading; important: both ends of the pipe must touch inside the socket.
Cutting nipple in this way is only possible for smaller diameters.

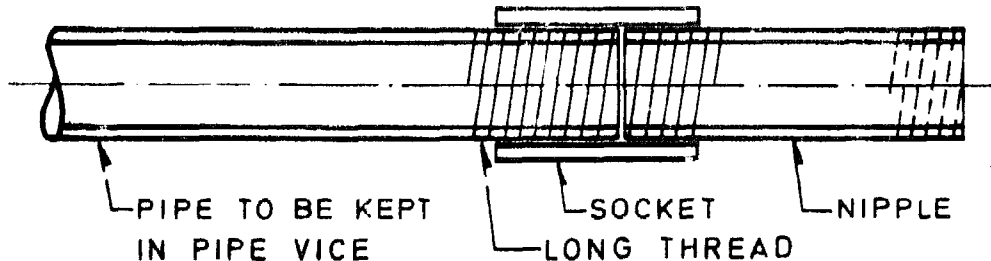







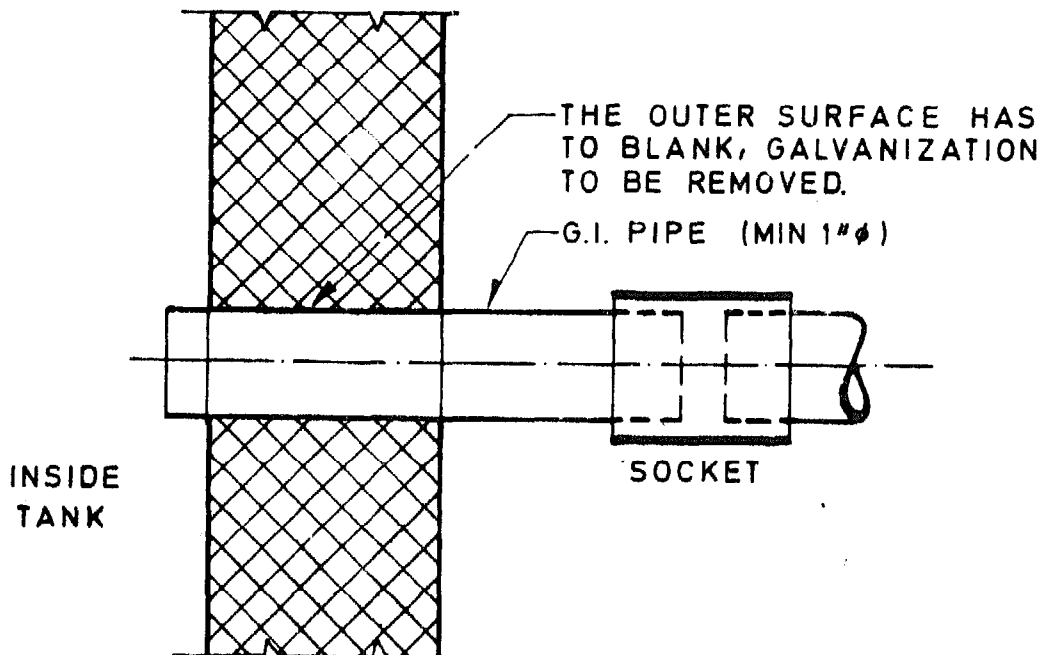



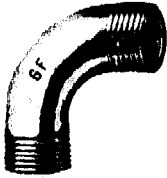







Good connection to concrete tanks

this can be done only with G.I. pipes. For really good connection it is important, that the G.I. pipe is fixed the same time as the wall will be build up (otherwise the joints may leak).

Caution: The galvanization must be removed!

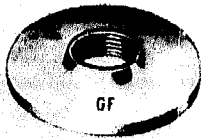

4.4. GALV. PIPES / Galv. Fittings

<p>BEND 90° (made out of steel tubes).</p>  <p>6</p>	<p>BEND 45° (made out of steel tubes)</p>  <p>8</p>	<p>ELBOW 90° female equal + reducing</p>  <p>90</p>	<p>ELBOW 90° male + female equal + reducing</p>  <p>92</p>
<p>TEE female</p>  <p>130</p>	<p>CROSS female</p>  <p>180</p>	<p>SIDE OUTLET ELBOW female</p>  <p>221</p>	<p>SIDE OUTLET TEE female</p>  <p>223</p>
<p>REDUCING SOCKET female</p>  <p>240</p>	<p>REDUCING BUSH female + male</p>  <p>241</p>	<p>RED. HEXAGON male</p>  <p>245</p>	<p>RED. SOCKET male + female</p>  <p>246</p>
<p>SOCKET</p>  <p>270</p>	<p>PLUG</p>  <p>291</p>	<p>BACKNUT</p>  <p>310</p>	<p>CAP</p>  <p>300</p>
<p>FLANGE</p>  <p>321</p>	<p>UNION flat-seat, female</p>  <p>330</p>	<p>NIPPLE</p>  <p>530</p>	<p>-17--</p>

5.1. P L A S T I C P I P E S

Plastic Pipes (HDPE + PVC)

Use: for cold water only, pipelines in the ground, there is no electrical conducting.

Pipes and fittings made from plastic offer many advantages. They have excellent chemical resistance which, combined with smoothness of bore, eliminate build-up of scale and gives good flow characteristics which remain constant throughout their working life.

Being odourless and tasteless, they are suitable for conveying drinking water and many food products; they have good abrasion resistance and weathering qualities, and afford good thermal and electrical insulation. Plastic pipes are light and clean to handle, and may be easily be joined.

The excellent chemical resistance of plastic pipes makes them especially suitable where pipelines are exposed to the risk of external corrosion.

Points to remember about expansion and contraction.

A pipeline should be allowed to expand and contract freely.

Wherever possible, expansion and contraction should be taken up by changes in direction.

Careful positioning of fixed points will enable the direction of expansion and contraction to be controlled.

Expansion loops may be used, but they must be large enough to give adequate flexibility, (at least 2.0 m resp. 7').

Valves and heavy components must independently be supported so that no stresses are imposed on the pipeline.

Where pipework incorporates pumps or other machinery, and there is a possibility of excessive vibration, it may be advisable to insulate the source of the vibration by means of flexible connections.

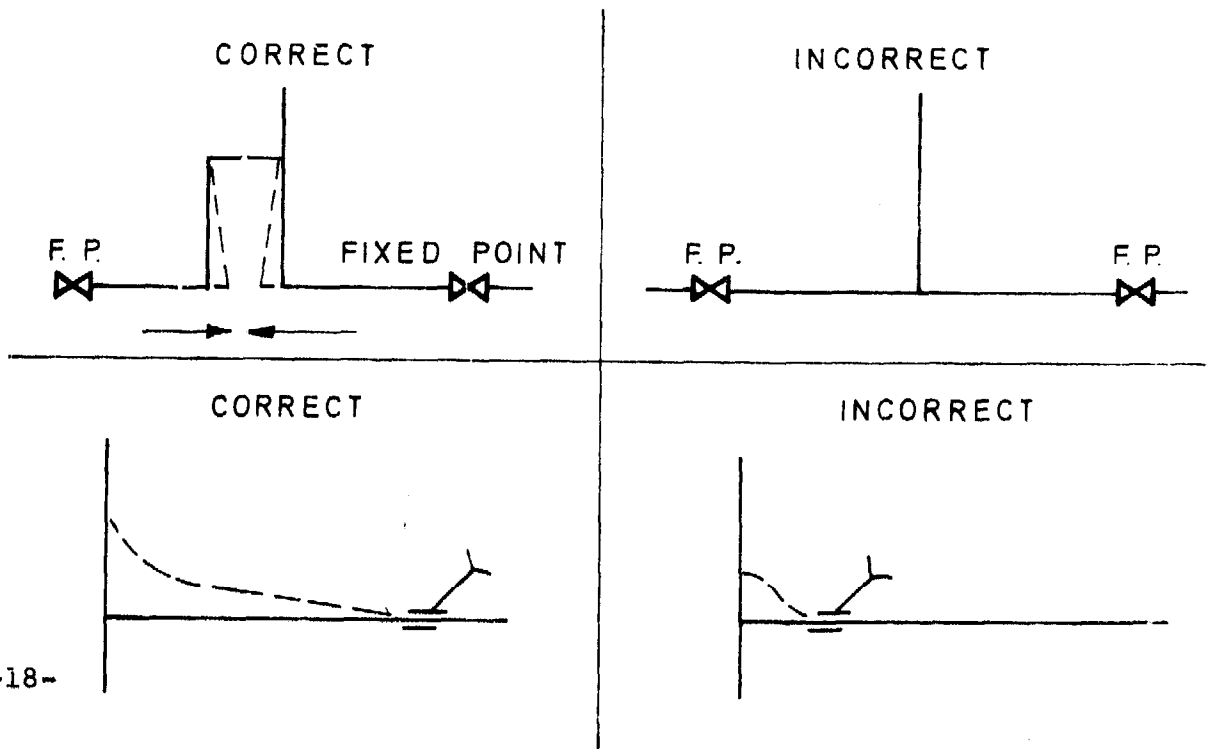

5.2. PLASTIC PIPES

Transport and Storage

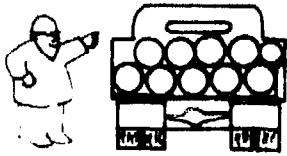

Lay the pipe in the truck in an orderly manner and supported along its entire length.

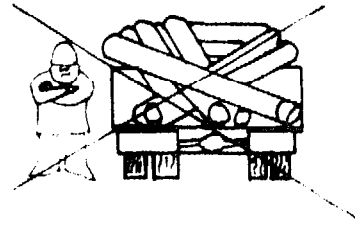

Don't mix up!

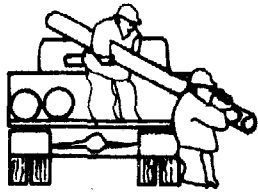

carry the pipes,

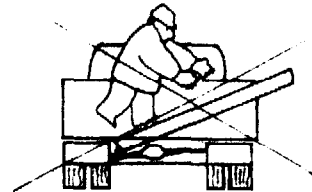

don't throw-down

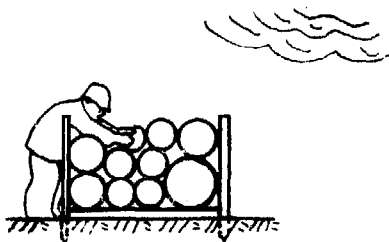

store them on square timber, in the shadow, and in a straight line

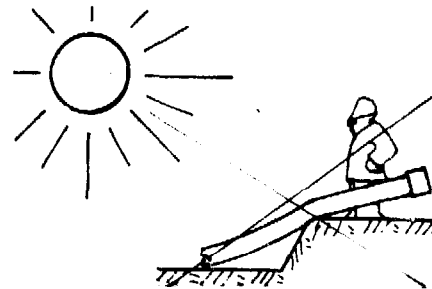

Don't place them on edges or in sunshine (more than 30 °C ' 86 °F)

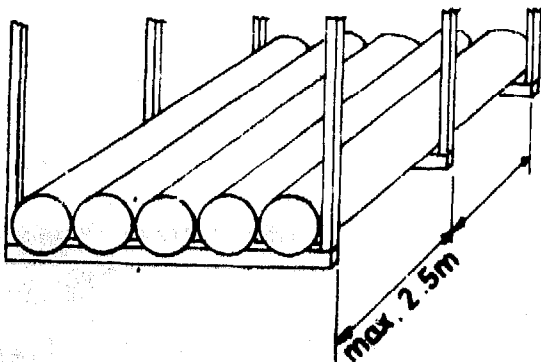

max. 2.5m

HDPE pipe coils

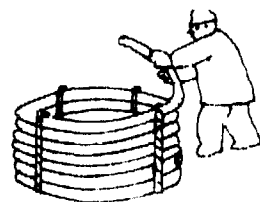

should be laid horizontally, in the shadow, far from fertilizers.

5.3. PLASTIC PIPES

Preparation of trenches and laying the pipes.

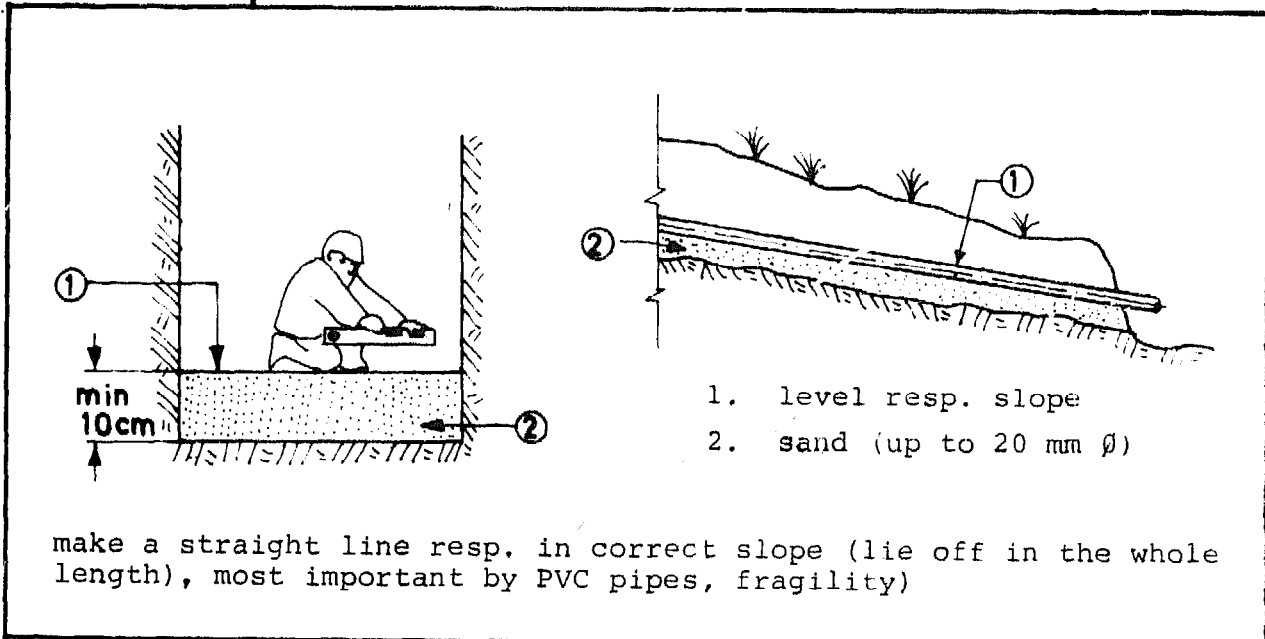

Handle pipes with care (PVC pipes are breakable)

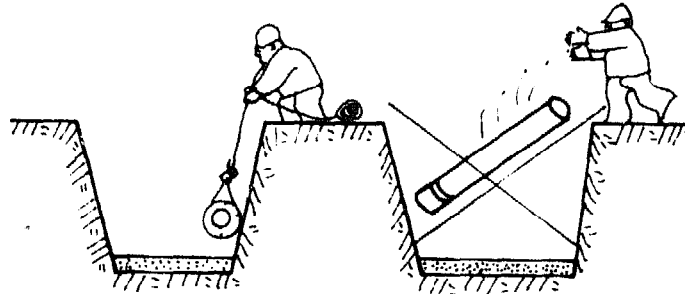

check the watertightness, before covering the trench

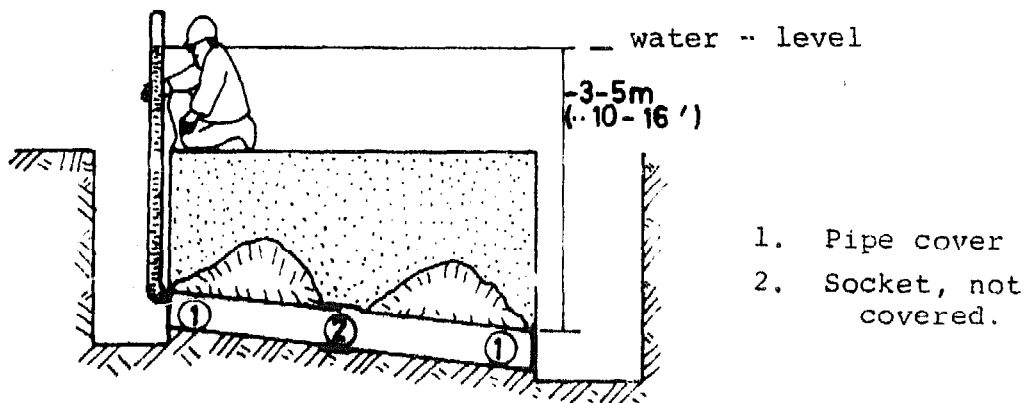

5.4. PLASTIC PIPES

Connections between galv. pipes and plastic pipes (HDPE + PVC)

ADAPTER UNION THE BEST SOLUTION

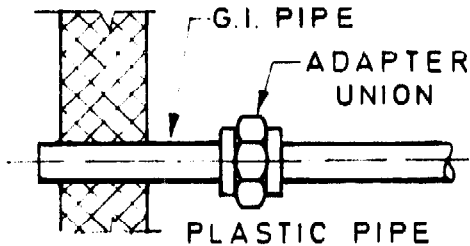

WITH RUBBER RING EV. HEATING: DRAWS TOGETHER

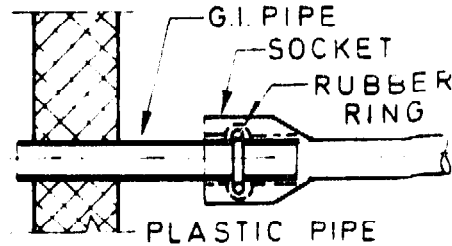

THREAD ON PLASTIC PIPE

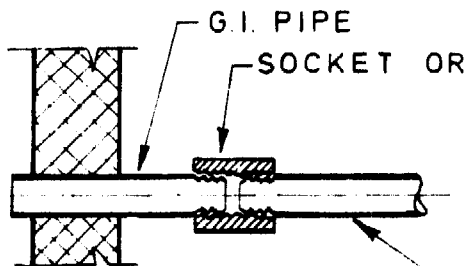

PLASTIC PIPE WITH THREAD

AT HDPE PIPES ONLY

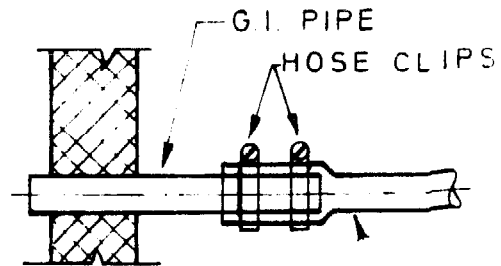

HDPE PIPE -

Concerning connection to concrete walls see special description

Screwed joints on plastic pipes

The outside diameter of the plastic pipes must be according to the G.I. pipes. Because screwed joints necessitate the use of a thick walled pipe; the overall cost of the installation will be higher than for a similar one resp. for low pressure (by PVC pipes with solvent cement joints).

The length of the threads should be according to the G.I. threads. If the thread on the pipe has been properly cut, it should be possible to screw the fitting on by hand for about two-thirds of the thread-length.

Points to remember about screwed joints on plastic pipes

1. New chasers should be used and retained for threading of plastic pipes.
2. The full depth of thread should be cut in one continuous operation.
3. Lubrication of the chasers is not necessary, oil is strictly prohibited.
4. Care should be exercised to ensure that undue strain is not applied when making a threaded joint.
5. The normal type of wrench should not be used, but special tools of strap-type are recommended.

6.1. PLASTIC PIPES

P V C pipes

Name: PVC is a short sign for Polyvinylchlorid
Density: 1.4 kg/dm³
Colour: gray, (normally)
Use: in the ground, for longer distances,
for cold water only (below 60 °C = 140 °F)
Installation: Generally apply the same rules as given for
galv. pipes.
PVC must be installed free from stress and not
in freezing areas.
The clamping distance is appr. ten times the
pipe diameter.
Handle the pipes with care, avoid shocks.
Don't paint the pipes after installing, some
paints will destroy the PVC material.

- | | |
|----------------------------|--|
| + connection with adhesive | - breakable
(little mechanical resistance) |
| + light in weight | - fittings difficult to make |
| + good for making sockets | - length of the pipes only
up to 6.0 m (20') |
| + need few tools | - welding only with special
tools (needs electricity) |
| + low friction loss | - adaption to terrain is
limited. The trench bottom
must be very well prepared |
| | - no direct connection with
cement permitted. |

Preparing of a spigot end

Mark the length with a soft pencil on the PVC pipe and cut it with
a fox saw (or a hack saw) and remove the internal burrs.

slightly chamfer outer edge of pipe (appr. 15° to pipe axis)

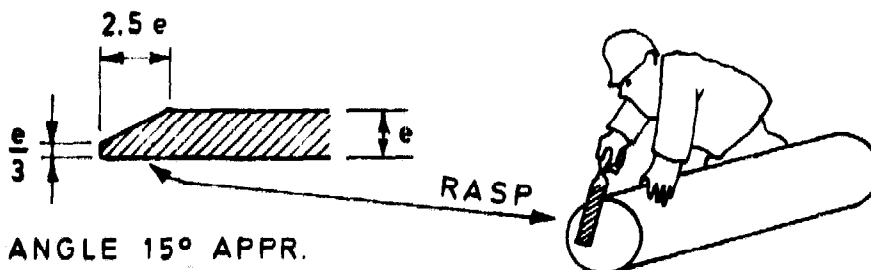

6.2. P L A S T I C P I P E S

PVC solvent cement joints

The cement creates a chemical bond between the pipe and the fitting. It is a simple and efficient method of joining, and because it is also permanent it is important to use the correct technique which is as follows:

1. Cut the pipe end square and remove internal burrs
2. Degrease joint surfaces of pipes and fitting with cleaning fluid, using absorbent paper
3. Slightly chamfer outer edge of pipe (appr. 15° to pipe axis)
4. Roughen joint surfaces, using clean emery cloth or medium glass-paper and clean again
5. Mark on the spigot end the length of the socket (with a soft pencil)
6. Using a brush, apply an even layer of cement to both fitting and pipe in a lengthwise direction, with a thicker coating on the pipe.
7. Immediately push the fitting (or the pipe end with the socket) on to the pipe without turning it, until it reaches the reduced portion of the socket. Then turn pipe at least 1/4 of a full turn. Keep them in this position for a short while, (10 - 20 seconds). Now remove the surplus cement.
8. Leave undisturbed for five minutes, then handle with reasonable care.
9. Allow eight hours before applying the full rated pressure. For lower pressure allow one hour per 1 kg/cm² (15 lbf/in²). For example 3 kg/cm² (45 lbf/in²) would require 3 hours drying time.

PVC points to remember about cemented joints

1. Before applying cement, the mating surface must be absolutely clean and dry.
2. For sizes with a diameter of 3" and above, two persons are required to apply cement simultaneously to pipe and fitting.
3. The tin of cement should be closed immediately after use, as the solvent evaporates quickly.

Caution: Solvent cement is inflammable, and there should be no smoking in the working area. The cement should be used in well ventilated conditions only.

6.3. P L A S T I C P I P E S

PVC sockets

1. prepare a spigot end (according description).
2. Mark the length of the socket (on the pipe for the socket). The depth of a socket is about one time the outside diameter of the pipe.
3. Heat the end of the pipe with a soft flame (or in hot glyzerin oil) until it is soft and rubber like. While the pipe is soft, see that the two pieces of pipe are joined straight in line and then cool them with water. Only then -when it is cool- remove the pipe.

PVC tee connections.

The pieces and other fittings (may be) easily available in the market

PVC bending

By applying heat, PVC pipes may be easily bend to any angle. For bending without sand use a bending radius from at least eight times the outside diameter. For bending with sandfilling use a bending radius from about four times the outside diameter.

1. For small bends: close one end of the pipe with a wooden plug.
2. Fill the pipe with hot, fine sand (warming with a flame) Compress the sand inside the pipe while knocking the pipe outer walls with a wooden stick.
3. Close the other end of the pipe also with a wooden plug.
4. Heat the pipe with a soft flame, while turning the pipe, and bend over the mould.
5. Cool with water.
6. Prepare a spigot end and/or socket.

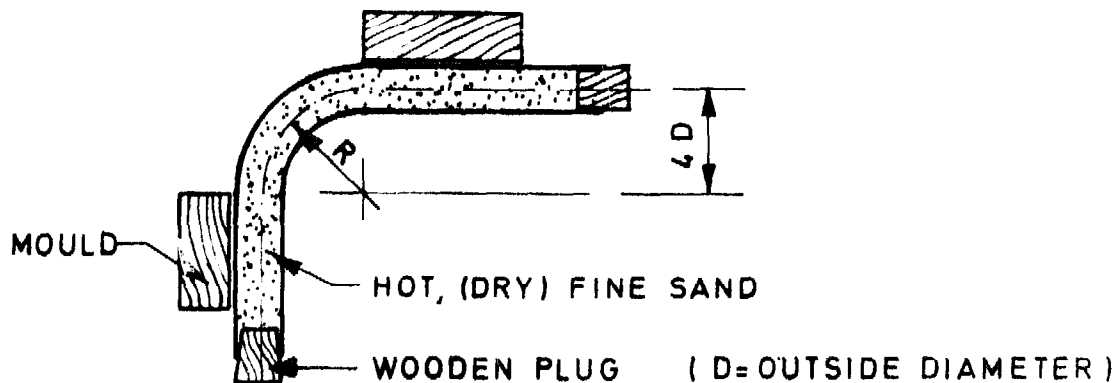

7.1. PLASTIC PIPES

HDPE pipes

Name: HDPE is a short sign for High Density Polyethylene.

Density: 0.9 kg/dm³

Colour: black (normally)

Use: in the ground, for long distances (coils) for cold water only (below 60 °C - 140 °F)

Installation: Generally apply the same rules as given for galv. pipes.
HDPE should be installed free from stress. The clamping distance is approximately ten times the pipe diameter.
Don't paint the pipes after installing. Some paints will destroy the HDPE material.

- | | |
|--|---|
| + connection with welding plate | - Adhesion is not possible |
| + possible to make fittings (tee, bend) quite easily | - Connection with socket is difficult without special fittings. |
| + available in coils (up to 100 m = 330') | - no direct connection with cement. |
| + leight in weight (transportation cost) | - easy to make holes in it (therfore deep trenches) |
| + need few tools (electricity not essential) | |
| + good chemical resistance | |
| + low friction loss | |
| + flexural strength (resist breakage and frost) | |
| + good adaption to terrain | |
| + incrustion-free smooth internal surface | |

7.2. P L A S T I C P I P E S

HDPE / Handling, laying and jointing coiled Polyethylene Pipes

Pipe Coils: Polyethylene pipe can be supplied in coils in a size range 3/8" - 4" and in some instances 6" diameter. Coil length of 150 m (492 ft) in sizes 3" and 4" diameter pipe can be supplied on special drums.

When Polyethylene pipe is coiled this is done at factory ambient temperature of appr. 25 Centigrades (77 °F). The pipe, which is extruded as a straight pipe is mechanically wrapped round a coil former and bound together into a rigid transportable coil. When the binding is cut from the coil, the pipe will tend to revert to a straight pipe and care should be exercised to control this movement on pipe diameters 2" and above as the uncoiled force can be of considerable magnitude and could cause injury to those handling the coil.

When uncoiling pipe, the bound coil should be stood vertically on its circumference. The outer free pipe end should be positioned at the bottom of the coil and as soon as it is cut free from the coil, this end should be anchored to the ground with a stake or metal hoop. The coil should now be rolled out away from the anchored end until the entire coiled length is unwound.

This ends of the coil pipe, though tending to straighten themselves, will for some time retain a degree of curvature. It will facilitate jointing if adjacent pipe ends are arranged so that this curvature is towards each other.

The ends of Polyethylene pipe when cut, after extrusion will tend to reduce in diameter slightly over the last 2" or 3" of the pipe. This short section of pipe should be cut off, and in doing so the pipe end cut truly square.

Alignment for Butt Welding

When jointing pipe by the butt weld technique, it is essential that the pipe ends meet truly square and mate together without external restraint. Bearing in mind that these ends will both be curved, the alignment of the joint may be achieved either in the form of a semi-circle, where the curvature of the pipe ends is in the same direction, or in the form of a large letter 'S' if the curvature of the pipe ends is contrary. Time spent achieving exact alignment is time well spent as the subsequent jointing will be a very simple matter indeed.

Storage

Polyethylene pipes should not be stored along side fertilizers, pesticides, insecticides and chemical compositions such as these, otherwise those pipes are liable to develop cracks.

7.3. P L A S T I C P I P E S

Welding

Only when good alignment has been achieved should the welding process be attempted, the procedure for which is as follows:

1. Assemble pipe ends in clamps leaving appr. 2" of pipe projecting inwards from each clamp.
2. If pipe ends have not previously been squared, the square off using a fine toothed wood saw. Again check alignment.
3. Complete trimming of pipe ends using the trimming tool. This achieves both a very clean and square trim and also exposes a perfectly new face for the weld. Care should be taken that the trimming of the pipe ends is complete over the entire pipe circumference. After trimming nothing should be allowed to touch the newly exposed faces.
4. Remove trimming tool and again check the joint for neat join and true alignment. At no point on joint should there be a gap of more than 0.5 mm (1/64").
5. Check temperature of heating tool with heat crayon, which should be 210 °C (+10, -5 °C) or 410 °F (+50 °, -41 °F). Insert heating tool between pipe ends and adjust pressure of pipe ends on heating tool. Times and pressures for heating are given on attached chart.
6. Remove heating tool and without delay bring pipe ends into contact under pressure and leave under pressure, undisturbed until weld has cooled. Again welding pressures and cooling times are indicated. The actual pressures can be read on the graduated adjustment screws on special welding machines.

Indication of a good joint is given by the uniformity of the bead on the outside of the pipe over its entire circumference.

Unevenness of this bead is an indication of poor alignment and uneven pressure. The bead size should be appr. 2-3 mm thick on pipe size 2" - 6" I.D. Failure to achieve a bead on any part of the joint would be indicative of a suspect joint, and this joint should be cut out and re-made.

Welding of HDPE pipes, pressure for about 30 seconds

∅ 48 mm	ca.	9 kg	(20 lbs)
∅ 56 mm	ca.	10 kg	(22 lbs)
∅ 75 mm	ca.	18 kg	(40 lbs)
∅ 90 mm	ca.	20 kg	(44 lbs)
∅ 110 mm	ca.	30 kg	(65 lbs)
∅ 125 mm	ca.	40 kg	(88 lbs)
∅ 150 mm	ca.	55 kg	(120 lbs)

Important: If the welding-plate is heated with a blow lamp or over a fire, then a teflon-paper has to be fitted over the plate after the heating before the welding can be done! Otherwise the quality of welding will be very bad.

7.4. PLASTIC PIPES / HDPE - BRANCH 450

1. cut pipe

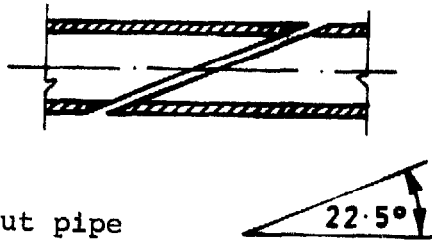

2. check

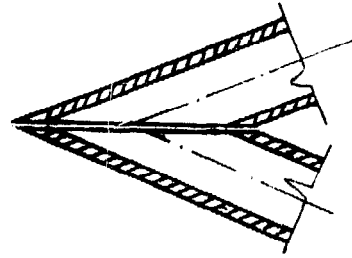

3. file, if necessary

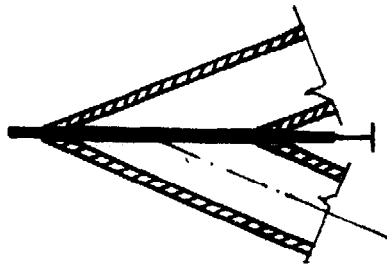

4. weld

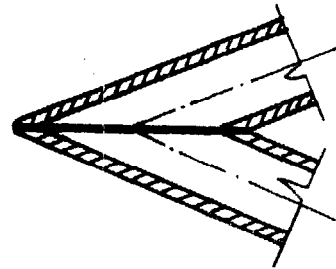

5. cut other part

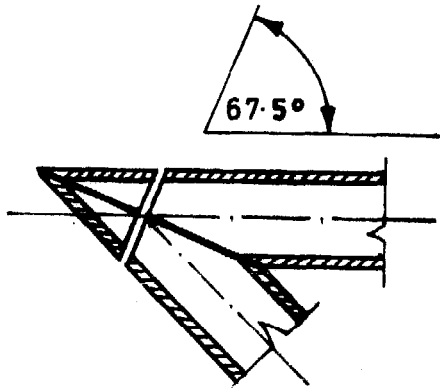

6. cut another piece

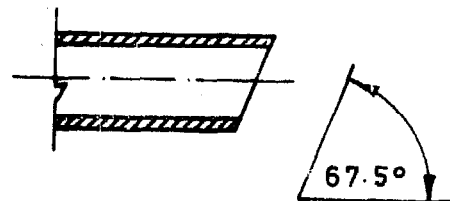

7. check,

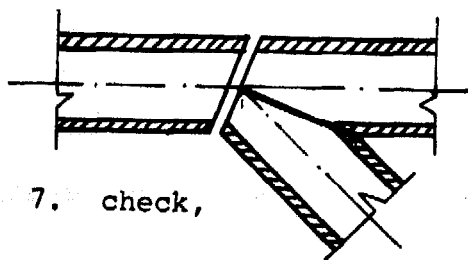

file if necessary

8. weld

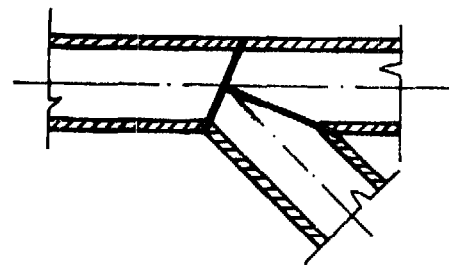

7.5. PLASTIC PIPES / HDPE - BRANCH 60°

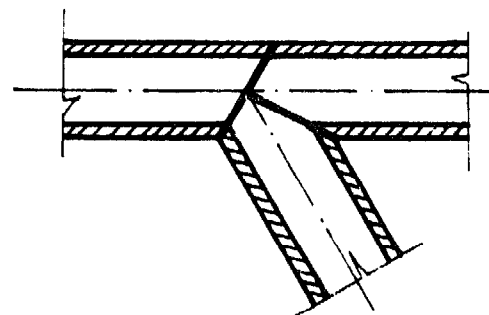
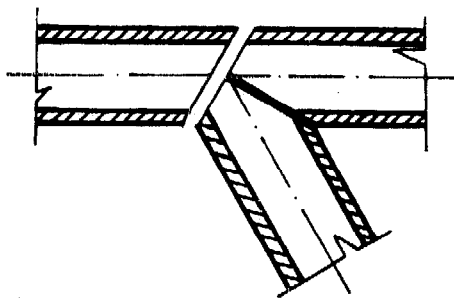
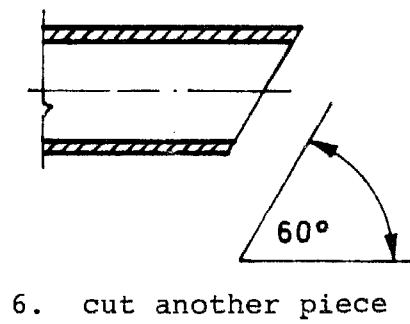
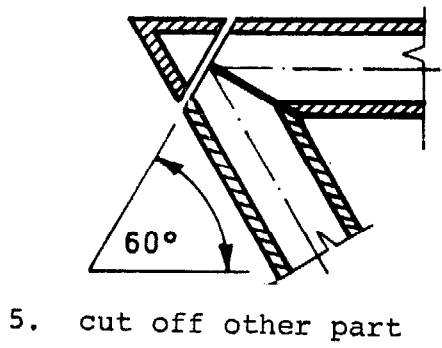
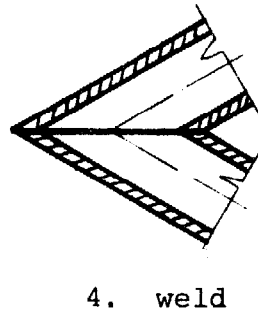
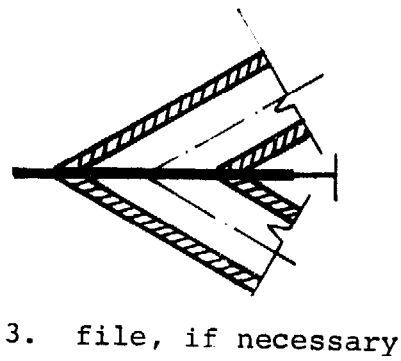
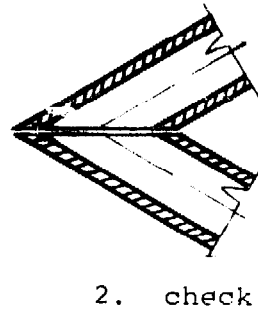
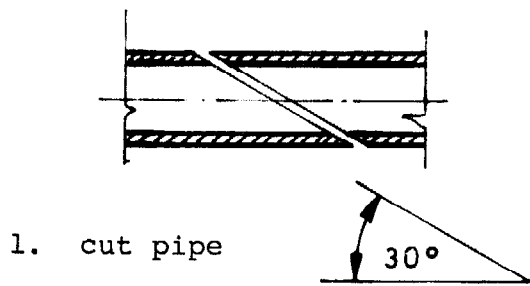

7.6. PLASTIC PIPES / HDPE-BRANCH 90°

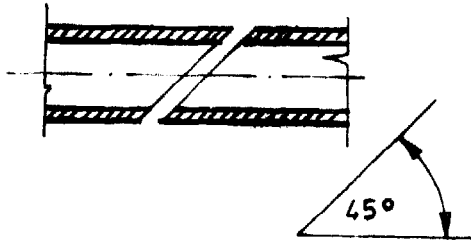

1. cut pipe

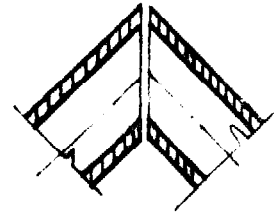

2. check

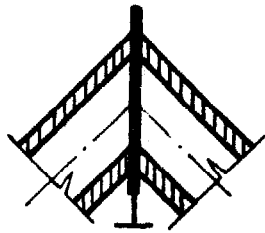

3. file, if necessary

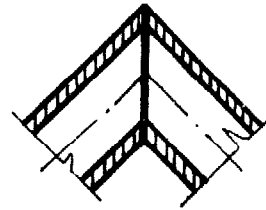

4. weld

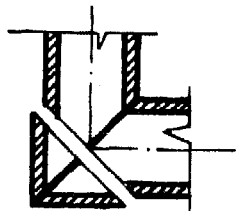

5. cut off

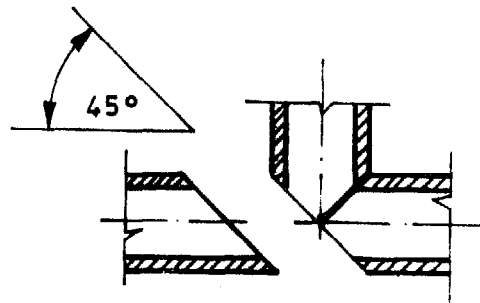

6. cut another piece

7. check,

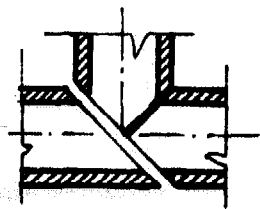

file if necessary

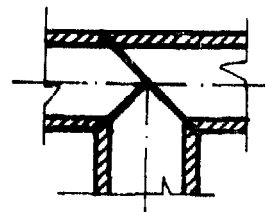

8. weld

7. 7. P L A S T I C P I P E S / HDPE - BENDS

Elbow 45°

2 pieces with 11.25° cut
1 segment piece 2 x 11.25° cut

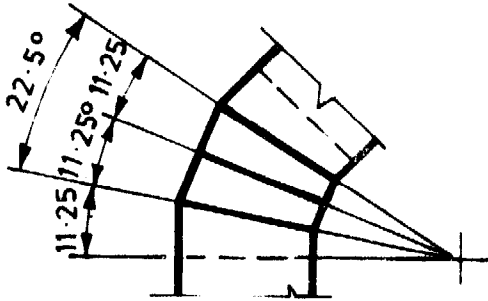

Elbow 90°

2 pieces with 15° cut
2 segment pieces 2 x 15° cut

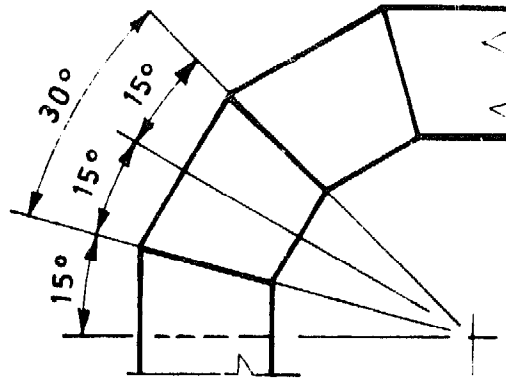

Bend 45°

2 pieces with 5.6°
3 segment pieces 2 x 5.6°

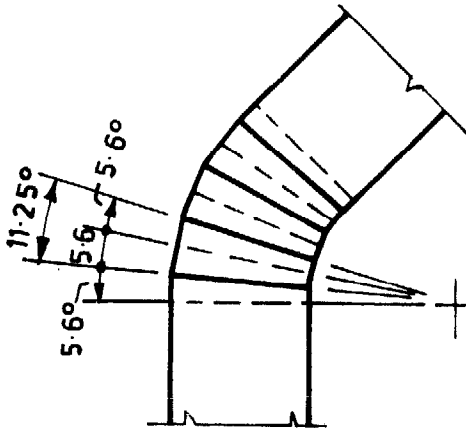

Bend 90°

2 pieces with 7.5°
5 segment pieces 2 x 7.5°

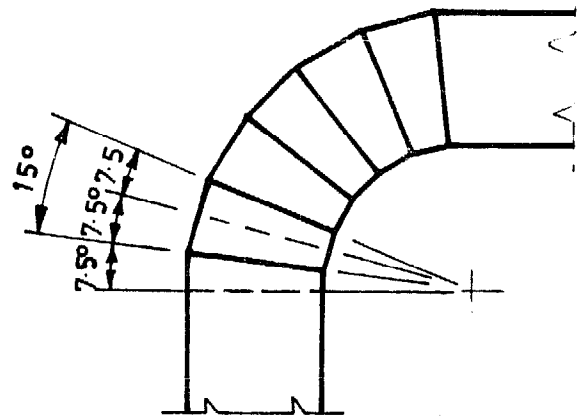

not recommendable

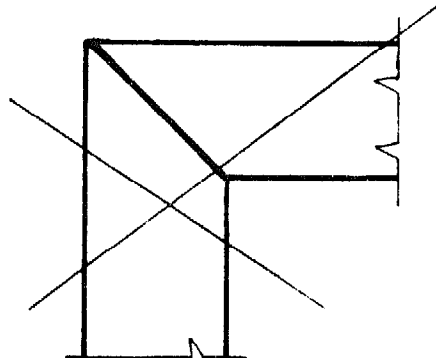
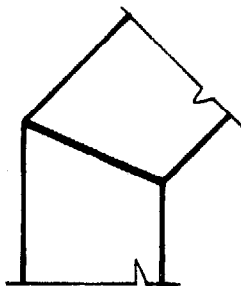

W R O N G

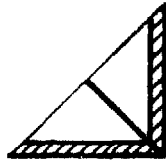

Take the remaining segment of a branch 90°, from the same diameter as the main-pipeline (see 7.6. No. 5)

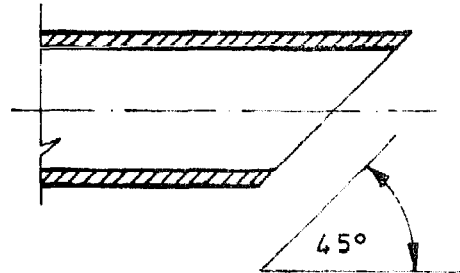

Cut an 45° angle on a straight pipe

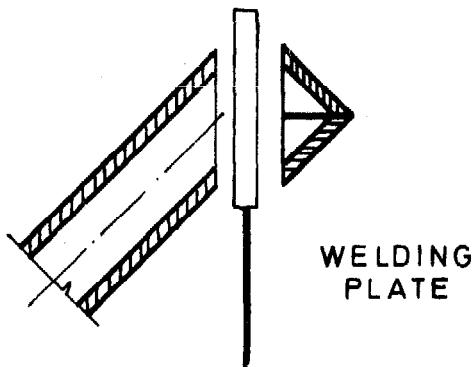

Heat both pieces on the welding plate

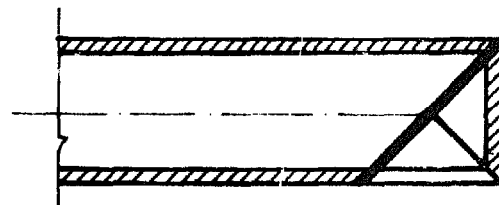

press them together

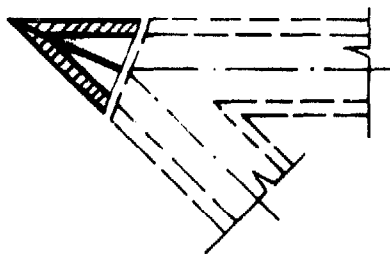

1. Take a segment of a 45° branch
(see 7.4. No. 5)

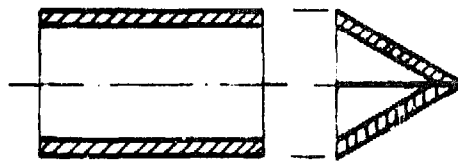

2. Check the diameters from the conical piece to the big diameter pipeline.

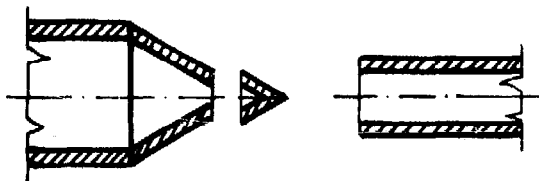

3. Weld the conical piece to the pipe with the bigger diameter.
Cut off the pointed end, the segment has to be smaller than the diameter of the smaller pipe to be fixed.

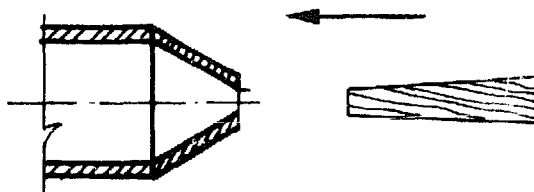

4. Heat the end with hot air and push a conical piece into it.

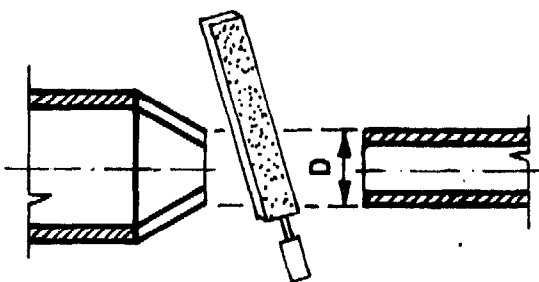

5. After the cooling, the diameter have to be made the same as the piece to be welded on it.

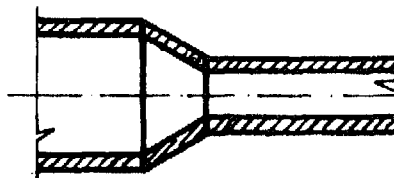

6. Heat both pieces on the welding plate and push them together.

7.10. P L A S T I C P I P E S / HDPE - ENDCAP

also first step for reducer - making

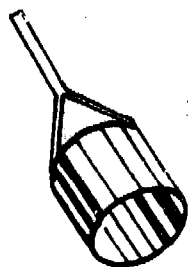

(also a normal piece of G.I. pipe can do).

1. prepare a metal welding tool outside $\varnothing = \text{HDPE } \varnothing + 1 \text{ mm}$ bigger inside $\varnothing = \text{HDPE } \varnothing - 1 \text{ mm}$ smaller than the pipe for which an end cap is required.

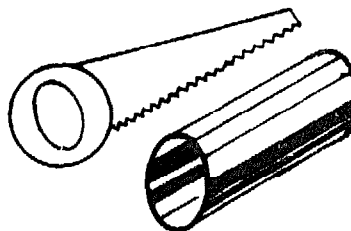

2. Take a piece of HDPE - pipe and cut it in the length side. (= material for the cap).

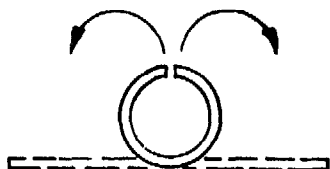

3. Heat the pipe with hot air (and not with the flame) and open it.

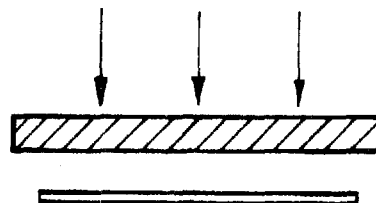

4. Put the HDPE-plate on a flat surface and on it a flat wood, with some weight on it. Wait until it is cold.

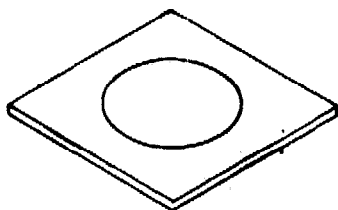

5. Mark the pipe outside diameter and clean the surface properly, necessary for the following welding.

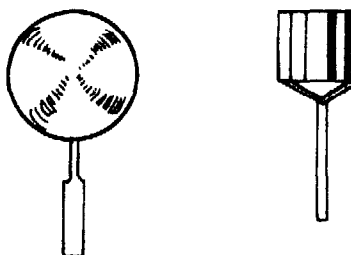

6. Heat the welding tools and put the plastic materials on them. Welding-plate for HDPE-pipe, Welding-pipe for HDPE-plate.

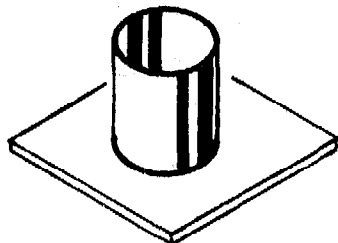

7. Remove the welding tools and connect both plastic parts. Pressing for appr. 30 seconds is essential.

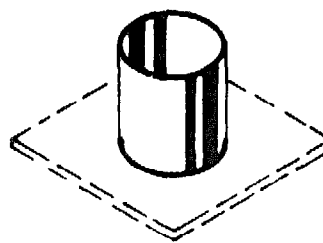

8. The overlapping material can be removed, but the welding seam should not be cut away (Reinforcement)

7.11. P L A S T I C P I P E S / HDPE - REDUCER

(for low pressure and waste water systems)

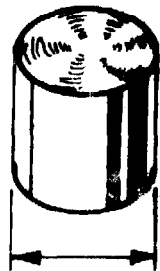

1. Take an end cap (make as before mentioned).
The diameter has to be according to the required bigger one.



2. Prepare a metal welding tool
outside $\varnothing = \text{HDPE } \varnothing + 1 \text{ mm}$
inside $\varnothing = \text{HDPE } \varnothing - 1 \text{ mm}$
than the pipe for which the smaller pipe diameter is required.

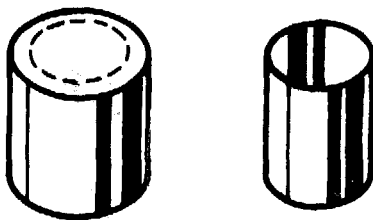

3. Mark the place where the smaller pipe has to be. Clean the surface on the cover plate with a knife or glass paper.

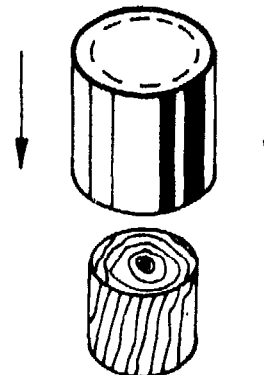

4. Prepare a wooden bloc, for the inside of the bigger \varnothing , as a counter pressure for the welding.

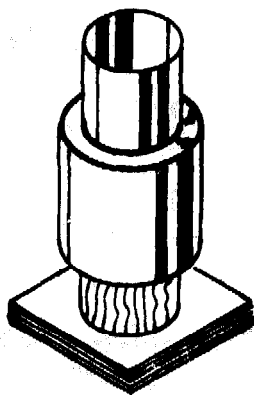

5. Heat both pieces on the welding tools (plate and pipe tool) press the together.

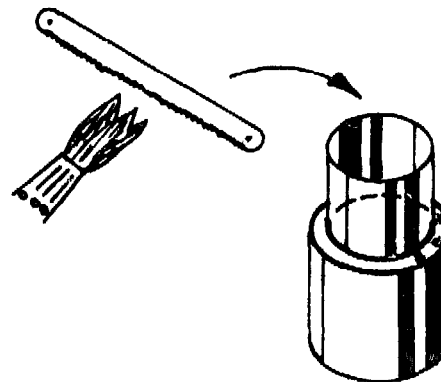

6. Cut out the inside part, but leave the welding seam existing (as reinforcement)

7.12. P L A S T I C P I P E S / HDPE - REDUCER

conical, for small differences in diameters.

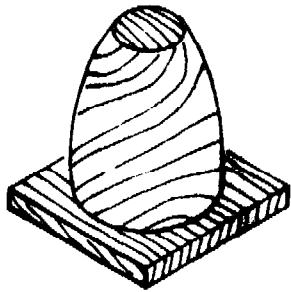

1. Prepare a conical wooden piece

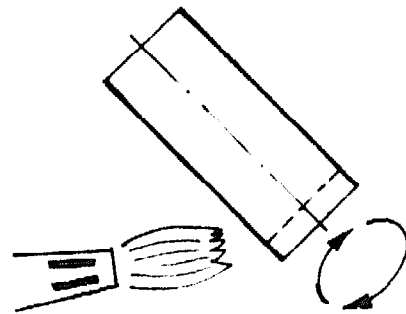

2. Heat the pipe with hot air (on the very end only) until it gets soft, like rubber, prevent over-heating

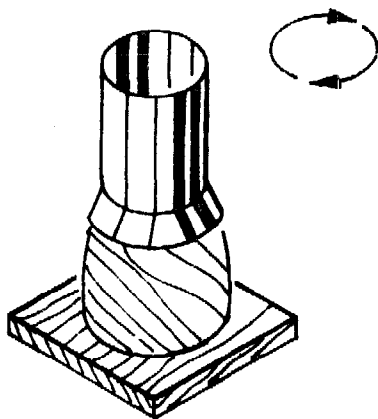

3. Push the piece over the wooden mould while turning.

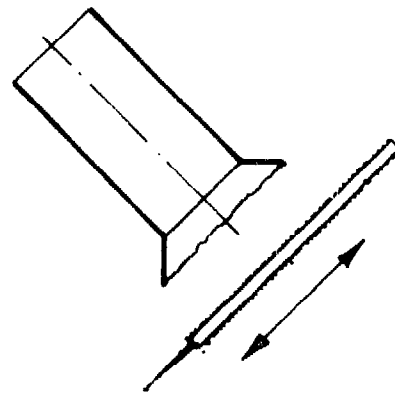

4. After cooling, make the surface equal and according to the required, bigger diameter.

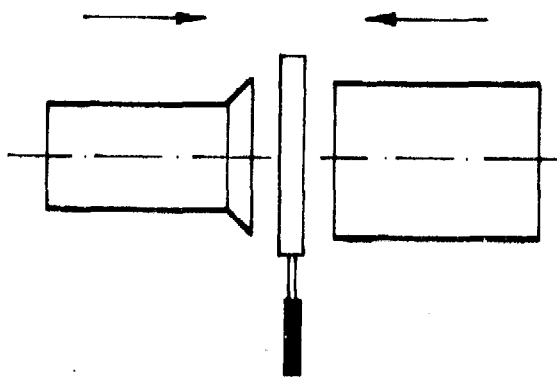

5. Heat both pieces on the welding plate.

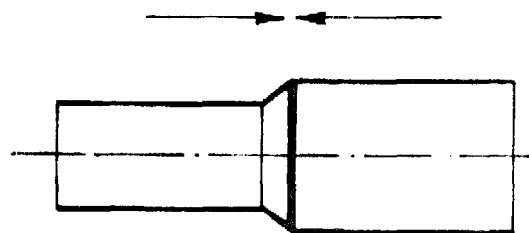

6. Press them together.

7.13. P L A S T I C P I P E S / HDPE - REDUCED BRANCH

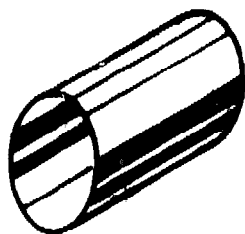

1. Prepare a metal welding tool, outside diameter as main pipe

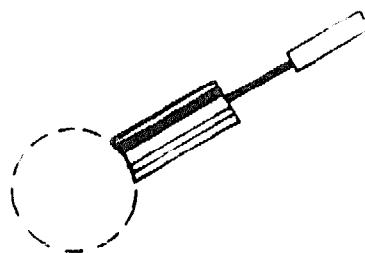

2. Prepare a metal tool with a diameter of + 1mm to the outside diameter and 1 mm smaller than that of the branch pipe

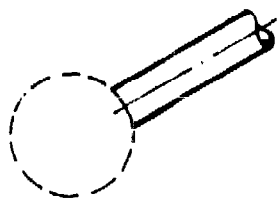

3. File the HDPE branch pipe so that it sits properly on the main pipe.

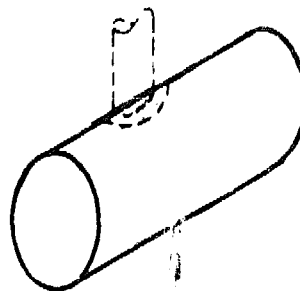

4. Check and mark for cleaning

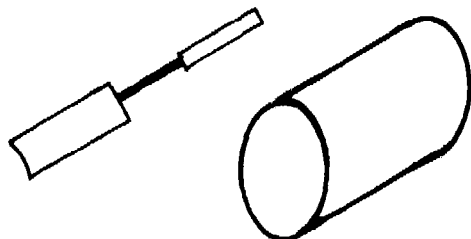

6. Press pipes together.

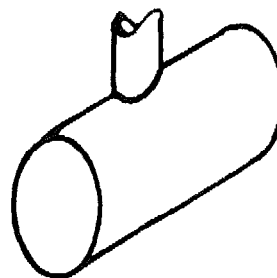

5. Heat both the welding tools Metal cylinder to HDPE branch pipe, Metal branch pipe to heat HDPE main pipe.

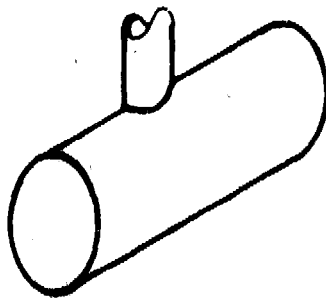

7. Cut out inside of branch, but leave welding seam.

Mould for straight pipe welding

GROOVE, FOR WELDING SEAM

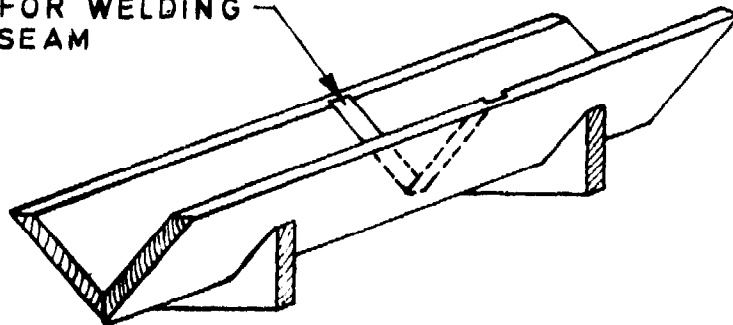

MITER BOX

SLIT

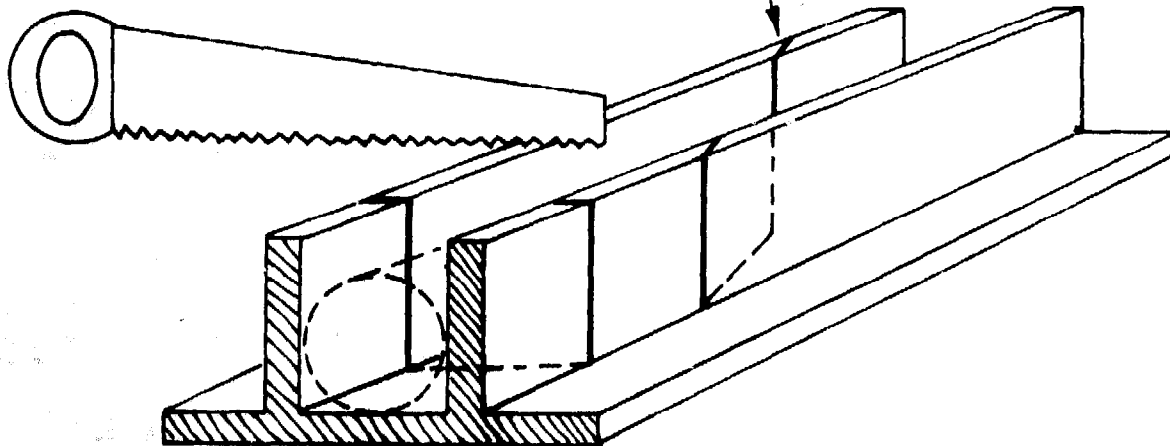

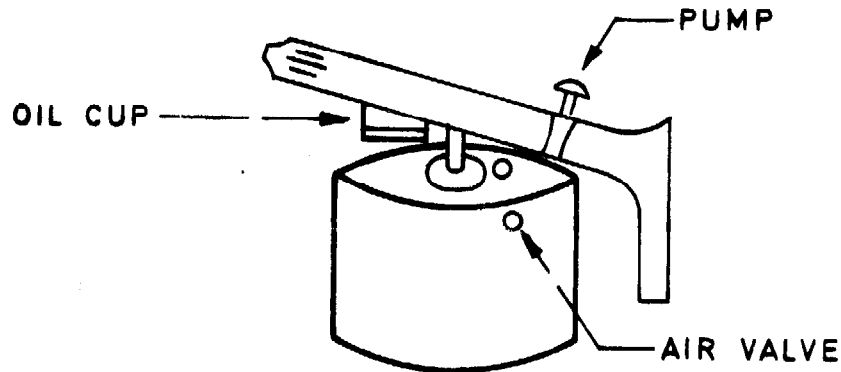

The blow lamp is a portable kerosene torch used by plumbers for securing intense local heat, for melting metals, heating metals and soldering.

Operation of Blow Lamp

1. Fill tank 3/4 with kerosene. Use a funnel with a filter so that dirt will not flow into the tank and cause blockage in the outlet.
2. Open air valve.
3. Fill oil cup with kerosene.
4. Light the kerosene in oil cup and leave the match in the oil cup.
5. Let the kerosene almost burn out.
6. Close air valve.
7. Pump the air pump 15 to 20 times.
8. Lamp should start burning, if it goes out repeat the above operation.
9. To increase flame pump the air pump again.
10. To reduce flame open the air valve slightly.
11. To stop flame open air valve all the way.
12. If flame smokes or fluctuates, clean the outlet with a cleaning needle.

IMPORTANT:

If the welding plate is heated with a blow lamp or over a fire, a teflon paper has to be fitted over the plate after the heating before the welding may be done! Otherwise the quality of welding will be bad.

R E F E R E N C E S

"Drinking Water Installations and Drainage Requirements in Buildings in Nepal", by A. Bachmann et al.

Swiss Association for Technical Assistance, SATA, P.O. Box 113
Kathmandu / Nepal

"Mini Technology", by B.R. Saubolle and A. Bachmann,
Sahayogi Press, Tripureswar, Kathmandu / Nepal

"The Village Tank as a source of Drinking Water", outline for
co-ordinated research and development project. (WHO/CWS/RD/69.1)
WHO, Service de la Distribution, CH-1211 Genève /Switzerland