

AT MICROFICHE
REFERENCE
LIBRARY

A project of Volunteers in Asia

Freshwater Fish Pond Culture and Management

by: Marilyn Chakroff

Published by:

VITA/Peace Corps
P.O. Box 12438
Arlington, VA 22209 USA

Free to development organizations and Peace Corps
volunteers.

Available from:

Information Collection and Exchange
Peace Corps
806 Connecticut Avenue NW
Washington, DC 20525 USA

Reproduced by permission of Volunteers in
Technical Assistance and the Peace Corps.

Reproduction of this microfiche document in any
form is subject to the same restrictions as those
of the original document.

APPROPRIATE TECHNOLOGIES FOR DEVELOPMENT

Freshwater Fish Pond Culture and Management

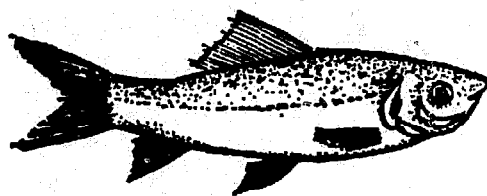

FRESHWATER FISH POND CULTURE AND MANAGEMENT

by

Marilyn Chakroff,
PEACE CORPS

Illustrated by JOAN KOSTER

Edited by LAUREL DRUBEN

VITA

ACTION/PEACE CORPS
PROGRAM & TRAINING JOURNAL
MANUAL SERIES NUMBER 1B

VOLUNTEERS IN TECHNICAL
ASSISTANCE
VITA PUBLICATIONS
MANUAL SERIES NUMBER 36E

September, 1976

FRESHWATER FISH POND
CULTURE AND MANAGEMENT

© VITA, 1976

May be reproduced without
payment of royalty for offic-
ial U.S. Government purposes.

About this manual....

Freshwater Fish Pond Culture and Management is the second in a series of publications being prepared by the United States Peace Corps and VITA, Volunteers in Technical Assistance. These publications combine Peace Corps' practical field experiences with VITA's technical expertise in areas in which development workers have special difficulties finding useful resource materials.

PEACE CORPS

Since 1961 Peace Corps Volunteers have worked at the grass roots level in countries around the world in program areas such as agriculture, public health, and education. Before beginning their two-year assignments, Volunteers are given training in cross-cultural, technical, and language skills. This training helps them to live and work closely with the people of their host countries. It helps them, too, to approach development problems with new ideas that make use of locally available resources and are appropriate to the local cultures.

Recently Peace Corps established an Information Collection & Exchange so that these ideas developed during service in the field could be made available to the wide range of development workers who might find them useful. Materials from the field are now being collected, reviewed, and classified in the Information Collection & Exchange system. The most useful materials will be shared. The Information Collection & Exchange provides an important source of field-based research materials for the production of how-to manuals such as *Freshwater Fish Pond Culture and Management*.

VITA

VITA people are also Volunteers Who respond to requests for technical assistance. In providing solutions, their aim is the most appropriate answers for specific situations. Therefore, VITA specialists often must produce new designs or adapt technologies so that they are of value in developing areas.

Many VITA Volunteers have lived and worked abroad. Most VITA people now work in the United States and other developed countries where they are engineers, doctors, scientists, farmers, architects, writers, artists, and so on. But they continue to work with people in other countries

through VITA. Thanks to their contributions of time and expertise, VITA has been providing technical assistance to the Third World for more than 15 years.

Requests for technical assistance come to VITA from many nations. Each request is sent to a Volunteer with the right skills. For example, a question about fish pond operation might be sent to a VITA Volunteer who has had years of experience working to develop fish ponds in Asia, and who is now a university professor.

THE PURPOSE

Freshwater Fish Pond Culture and Management is a how-to manual. It is designed as a working and teaching tool for extension agents. It is for their use as they establish and/or maintain local fish pond operations. The information is presented here to 1) facilitate technology transfer and 2) provide a clear guide for warm water fish pond construction and management. A valuable listing of resources at the end of this manual will give further direction to those wishing more information on various aspects of fish pond operation.

THE PEOPLE WHO PREPARED IT

The strength of both Peace Corps and VITA lies in Volunteers. These manuals represent an excellent means of communicating important know-how gained through Volunteer experiences and inputs.

The author of *Freshwater Fish Pond Culture and Management*, Marilyn Chakroff, served with Peace Corps in the Philippines for three years. in a number of fisheries programs. Ms. Chakroff, who holds a B.S. in Biology, now is an advanced degree candidate in the field of Environmental Communication at the State University of New York, in Syracuse. This manual is written out of her first-hand experiences as a Peace Corps Volunteer.

Joan Koster, the illustrator, has been a VITA Volunteer for more than 3 years. She is a teacher, professional artist, and writer. Ms. Koster, who has travelled and studied in Greece for a number of years, currently is preparing a manuscript on looms and weaving.

OTHER CONTRIBUTORS

Many thanks are due here to a number of people who aided the preparation of this manual:

Dr. Peter Black, Dr. Robert Werner, Dr. David Hanselman -- Faculty of the College of Environmental Science and Forestry, State University of New York, Syracuse.

Dr. Shirley Crawford, Agricultural and Technical College, State University of New York, Morrisville.

William McLarney, New Alchemy Institute, Woods Hole, Massachusetts.

A.F. D'Mello, Hawkesbury Agricultural College, New South Wales,
Australia.

Richard T. Carruthers, Bioproducts, Inc., Warrenton, Oregon.

Dr. William Ribelin, Department of Veterinary Science, University
of Wisconsin, Madison.

A special note of thanks is due John Goodell, VITA, for his layout work
and staff assistance with this manual.

REPLY FORM

For your convenience, a reply form has been provided here. Please
send it in and let us know how the manual has helped or can be made
more helpful. If the reply form is missing from your copy of the
manual, just put your comments, suggestions, descriptions of problems,
etc., on a piece of paper and send them to:

FISH POND CULTURE
3706 RHODE ISLAND AVENUE
MT. RAINIER, MD. 20822
U.S.A.

PLEASE RETURN THIS FORM

NOTE TO THE USER: This manual was published because Peace Corps and VITA workers and volunteers wish to help in a growing area of worldwide interest. In order to provide the most effective help, the preparers of the manual need to know how it is being used, or how you feel it could better serve your needs. Please fill in the following form and return it to:

FISH POND CULTURE
3706 RHODE ISLAND AVENUE
MT. RAINIER, MD 20822
U.S.A.

WHEN WE RECEIVE THIS FORM, WE WILL AUTOMATICALLY PLACE YOUR NAME ON A MAILING LIST SO THAT YOU WILL RECEIVE:

- . Updates and/or additions and corrections to the manual as they become available.
- . Notice of other publications which may be of interest to you.

If you have questions on the material presented in the manual, or if you run into problems implementing the suggestions offered here, please note them in the space provided. Use additional paper if you have to in order to be as specific as you can about the problem. Wherever possible, we will try to provide or direct you to an answer.

* * *

Date _____

Your Name _____ Your Company or Agency, if any _____

Your Address _____

1. How did you find out about the PC/VITA Freshwater Fish Pond Culture and Management manual? How did you get your copy?
2. Which parts of the manual have you found most useful? Least useful? Why?

3. Did you find the manual easy to read, too simple or complex, complete or incomplete?
4. How has this manual helped your work? What have you done to apply the information?
5. Which plans have you used? Did you make changes in any of the plans? (For example, when you were building a drainage system, did you substitute any materials for the ones mentioned or change the design?) If you made changes, please describe what you did that was different. Include photos, sketches, etc., if possible or important.
6. Can you recommend additional methods or equipment which you feel should be included in a new edition of the manual? If you do know of such methods, etc., please include the information here.
7. What were your successes using the manual or implementing any of the plans or procedures? Problems? Please describe completely.
8. Do you have other recommendations?

Table of Contents

Section		Page
	"About This Manual"	iii
	Reply Form	vii
1	INTRODUCTION	1
2	PLANNING: THE SITE AND THE TYPE OF FISH FARM	11
3	PLANNING: SELECTION OF FISH	33
4	FISH POND CONSTRUCTION	53
5	PREPARING THE POND	79
6	MANAGING THE POND	107
7	HARVESTING THE POND	149
8	PRESERVING FISH	157
9	PROBLEMS OF FISH IN PONDS	165
10	OTHER METHODS OF FISH CULTURE	175
	Glossary	181
	Resources	185
	Measurements Used in This Manual	191

1

Introduction

What is Fish Culture?

Fish culture is the growing of fish in ponds. Growing fish in ponds, from which they cannot escape, allows feeding, breeding, growing, and harvesting the fish in a well-planned way.

Fish culture is one form of aquaculture. Aquaculture is the science which deals with methods of growing (cultivating) animal and vegetable life in water. Some other kinds of aquaculture are concerned with growing frogs, oysters, seaweed, and even rice.

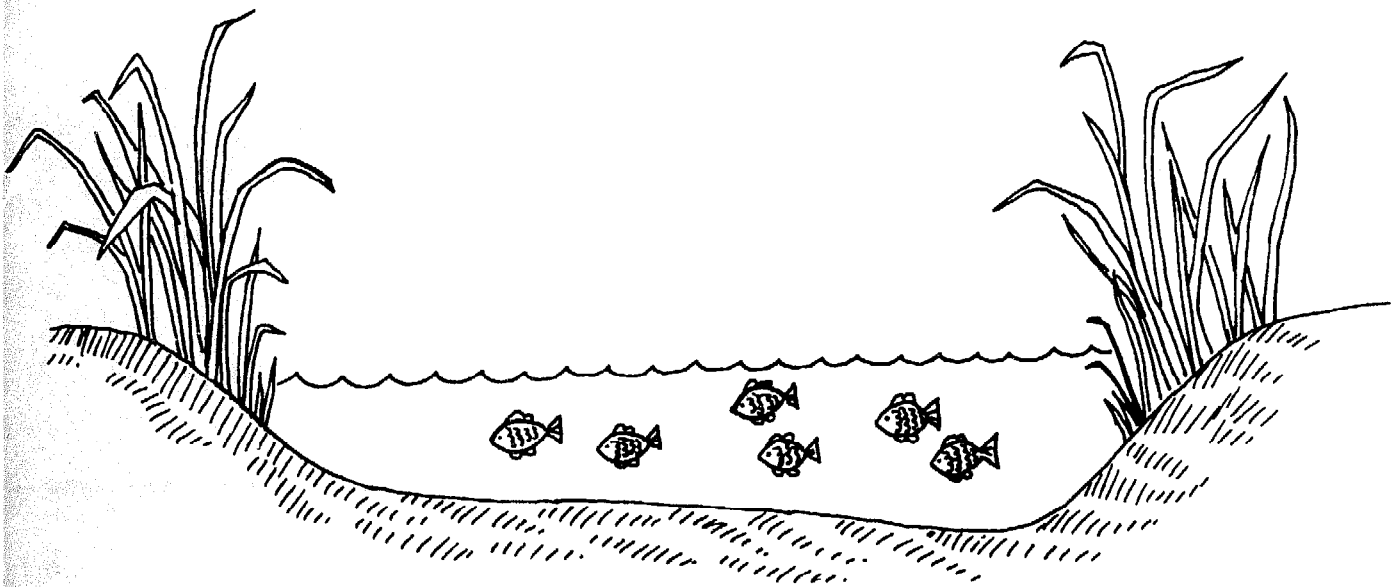

History of Fish Culture in Ponds

Growing fish in ponds is a very old practice. Carp were cultured as long ago as 2698 B.C. in China, where they were grown in ponds on silkworm farms. Fish culture seemed to occur whenever civilization was settled for a long period of time. For example, fish culture was done in ancient Egypt and in China, which has had a continuous civilization for over 4,000 years. The first written account of fish culture in ponds was by Fan Lai, a Chinese fish farmer, in 475 B.C.

The ancient Romans introduced carp from Asia into Greece and Italy. By the seventeenth century (1600's), carp culture was being done all over Europe. A book written in England in 1600 by John Taverner gives the details of good pond management and talks about growing the common carp. Taverner also wrote about pond construction, fertilization and feeding. Another book, written in 1865, gave the details of the stripping methods of spawning fish. The methods of culturing common carp have not changed very much since that time.

The common carp is still a very important pond fish. In addition, today, other fish also are being cultured in ponds. Some of the most well-known are fish of the tilapia genus, like *Tilapia nilotica* and *Tilapia mossambica*. Some of the other Chinese carps -- the silver, grass, and bighead carps -- also are often used in pond culture. Most importantly, countries all over the world are using time and money to discover which of the fish commonly found in their own waters will grow well in fish ponds.

Why Fish are Grown in Ponds

The practice of culturing fish in ponds developed because growing fish in ponds is a more useful practice, for some purposes, than trying to catch fish from lakes, rivers, or streams. For example:

- . Many interested people discover that building a fish pond close to home is possible and far more convenient than going to the nearest market or river. Ponds can be built wherever the soil, shape of the land, and water supply are right. This may sound as if a lot of factors are involved. But since a wide variety of soils, land shapes, and water supplies can be used for pond culture, a fish pond can even be made from a rice paddy or an unused grain field.
- . It is easier to get fish out of a pond than it is to catch a fish from a river or stream. Also, the number of fish taken out of a pond can be controlled. But it is very difficult to know how many fish can be caught in a river or stream or lake at any one time. When the farmer goes to his fish pond to get dinner, he knows he can take out the number of fish he needs -- quickly and easily.

- . Fish growth can be controlled. The fish can be fed extra food to make them better for market; natural enemies can be kept from killing the fish. For a person who relies on fish for his food or his income, these are important factors.
- . The only fish grown in a pond are the ones the farmer wants to grow. When he takes a fish out of his pond, the farmer knows what kind or kinds he will be getting. When he catches fish in a lake, stream, or river, many of the fish will not be the ones that are good to eat or to sell.
- . Growing fish in ponds allows the farmer, or other fish grower, to produce fish cheaply, and to have a supply of fish available on his own land. Fish in ponds belong to the pond owners; fish in the rivers and lakes do not.



Why Growing Fish is Important

There are some very good reasons why a farmer or small land owner might be interested in fish farming:

- . Fish are an important food source.
- . Fish farming can help a farmer make the best use of his land.
- . Fish farming can provide extra income.

There may be additional reasons; you and the pond owners can determine these from the local situation. The three points listed above are very broad, however, and apply, at least in part, to most situations. Therefore, each point is discussed more fully below.

FISH AS FOOD Farmers know that all living things need food, and that without food, living things die. However, they are not as likely to know the characteristics of food which make it valuable (or not) to the body.

Food is important because it provides proteins, vitamins, minerals, fats, and carbohydrates. These things are called nutrients: they are materials that the body must have to live and grow. Every kind of food has different amounts of each of these nutrients. For example, some foods contain more protein; others have more fat than protein.



Because foods contain different amounts of proteins, fats, and carbohydrates, for example, it is necessary to eat a number of different kinds of food to get the right amounts of each nutrient. All the foods together then give the body what it needs to grow.

The food that people eat is called their diet. Eating the right kinds of food -- foods that give the body the right amounts of proteins, fats, etc. -- is called eating a balanced diet. People who eat a balanced diet usually are healthy and strong; people who do not eat the right kinds of food are more likely to be weak and get sick.

Proteins are the most important part of food. Protein is made of carbon, hydrogen, and nitrogen. These are called elements. The combinations of elements in protein make it the most useful nutrient. Foods that contain a lot of protein are especially good for people to eat. And fish contains a lot of protein.

The table on the opposite page shows a list of foods that humans eat. The first number beside the food shows the number of grams of protein in the food when it is fresh. The second number tells how many grams of protein there are in food which has been dried. The table shows that fish -- whether fresh or dried -- is a very good source of protein. (100gm of dried fish contains more protein than 100gm of fresh fish only because dried foods have water taken out. Therefore, 100gm of fresh fish weighs less when it is dried.)



If the farmers in your area already eat a lot of fish, or like fish, fish farming for food may not be hard to introduce and have accepted. If they do not eat fish often, you will have to keep this in mind when you talk about fish as a healthy food. Food just may not be the most important reason, from their point of view, for wanting to grow fish.

PROTEIN CONTENT OF FOODS *

Food	Fresh, gms protein per 100gm	Dried, gms protein per 100gm
FISH		
Fatty (herring)	17	46
Non-fatty (haddock)	16	84
MEAT		
Beef	20	67
Pork, loin	20	67
Liver	20	67
DAIRY PRODUCTS		
Milk	3.4	26
Eggs	12	46
CEREALS		
Wheat	12	14
Maize	10	11
Oats	10	11
Rice	8	9
OIL SEEDS		
Soya	33	37
Cottonseed	20	21
Sesame	21	22
GREEN LEAFY VEGETABLES		
Cabbage	1.4 - 3.3	24
Spinach	2.3 - 5.5	26
ROOTS		
Cassava (manioc)	0.7	2
Potatoes	2.1	9
Yams	2.1	7
Plaintains	1.0	3

* These values are estimates only; the amount of protein varies according to the age, size, and quality of the food, and how it was cooked and stored.

Source: *Aylward and Jul (1975)*

But there are other reasons you can offer a farmer. For example, a farmer may consider cultivating fish if he realizes that fish are easy to grow, cheaper than some kinds of meat, available as food all year round, etc. You will have to see which combination of arguments works best for getting farmers interested.

BETTER LAND USE Some farmers may be more interested in fish farming when they realize they can accomplish two purposes: provide a reliable food supply and make the best possible use of their land.

"Fish farming" is a good thing to call "fish culture" because it can start the farmer thinking about raising fish with the same kind of planning and land-use management ideas that he puts into raising crops.

Whether the farmer raises fish, crops, or animals, he is using his land in certain ways. His aim in all cases is to increase the production of food and the yield from the land. What farmers, and other people, often do not realize is that fish culture can help get more out of the land. Here are a few ways in which fish culture can help support and extend a farmer's land use:

- . Land gets tired when it is used for growing the same crop year after year. These crops use up nutrients in soil, and they begin to grow poorly. Fish ponds can be built on this land and fertilized to provide food for the fish. After a few years of fertilizing and growing fish, the soil inside the pond regains some of the nutrients used up by the growing of crops year after year. The land can then be used for crops again.
- . Some farmers own land that may not be very good for growing crops: it is too sandy, for example. But there are ways of building fish ponds in sandy soil. So the farmer would be able to use land that was once not of much value to him.
- . There are many ways that fish farming can fit into the farmer's plan for his land. The important thing is that all of these ways help the farmer make the best use and get more out of what he has -- readily, and often without much expense. For example, a farmer who grows paddy rice can grow fish in that paddy; fish ponds can be built as part of water supply and irrigation systems; vegetable scraps and animal manures can be collected and used for fertilizing ponds. The farmer should know that a farm with a fish pond or ponds can give a total food yield that is higher than a farm with no fish ponds.

The following diagram illustrates some of the ways in which the fish pond fits into the farm: The same water source is used by both the garden and the fish pond; the mud from the bottom of the pond makes

good fertilizer for the garden; vegetable matter from the garden can be used to fertilize fish ponds; manure from the animals can be used for the pond and parts of fish can be used to feed animals; etc.

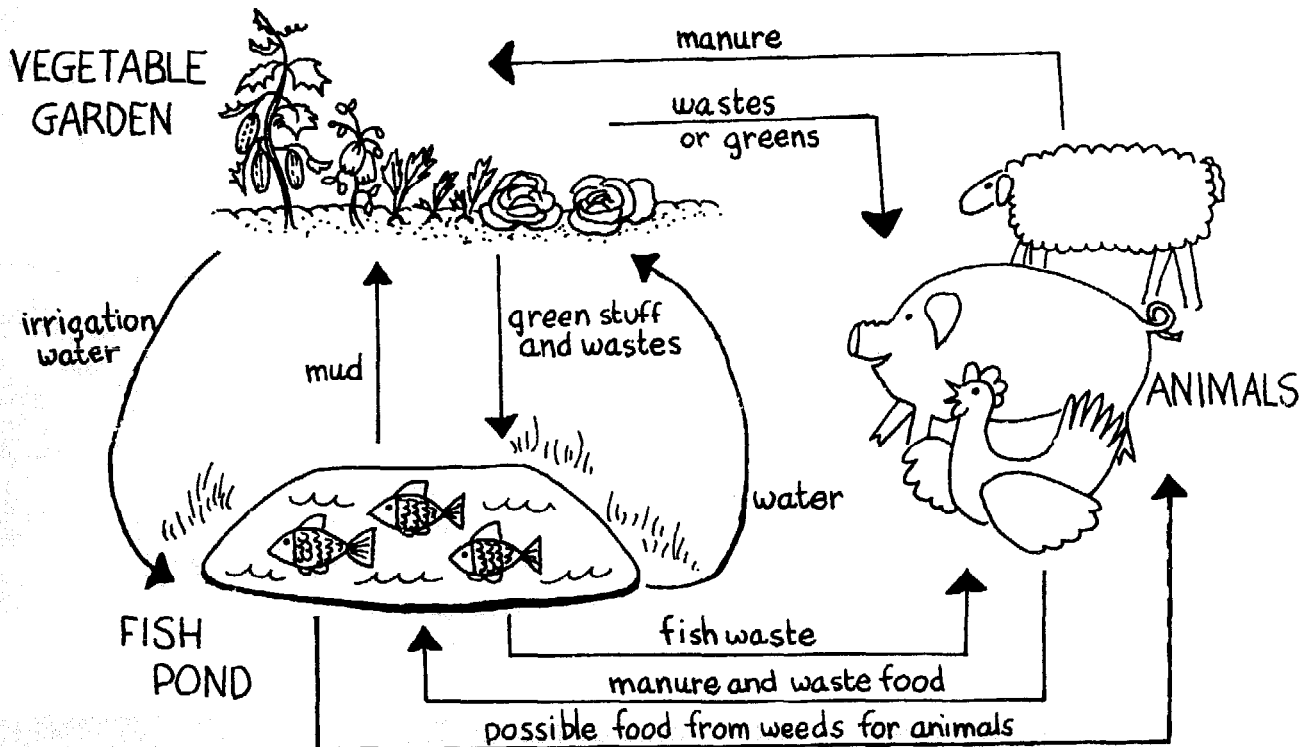

ADDED INCOME Fish ponds can be quite small, or they can be large. They can be made using expensive equipment and drainage systems, or they can be dug using hand tools and drained by a bamboo pipe. Fish can grow successfully in both of these types of pond, as long as the ponds are managed correctly.

If the major reason for building the fish pond is to get increased and better food for his family, a farmer certainly does not need fancy ponds or expensive equipment. Fish ponds can be very inexpensive to keep. Fish do not require fancy foods. Many ponds provide all the food the fish need. But besides the foods they find in water itself, some fish eat leafy garbage, mill sweepings, beer residues, spoiled grains, broken rice, and many other waste products that might not otherwise be used.

A farmer makes his income go further by growing more of the family's food and by selling leftover fish the family cannot eat.



Growing fish to sell can also be very profitable. But the costs involved in getting started and in maintaining the effort are greater: if the farming is to be a solid commercial enterprise, then more ponds, more time, more money, and nearby marketplaces are needed. The business may or may not show a profit right away; in fact, the chances are that it will not. A farmer might be better advised to start small and work into a bigger enterprise slowly as he learns to manage the art of growing fish in ponds.

A Word about Cooperation

Often fish ponds are built by cooperatives. A cooperative is an organization of people in an area who come together to do something they could not or would not do alone. In this way, four or five people or families can pool their resources and build a fish pond operation together. Sometimes an entire village will form a cooperative and will build and operate a pond as a group. This kind of cooperation makes possible better pond construction and management. A fish pond cooperative may be a good way for a village to improve the diet of the community and to sell enough fish to maintain the enterprise. If the farmers in your area are not interested in, or are concerned about, building ponds individually, a cooperative may be a very acceptable idea.

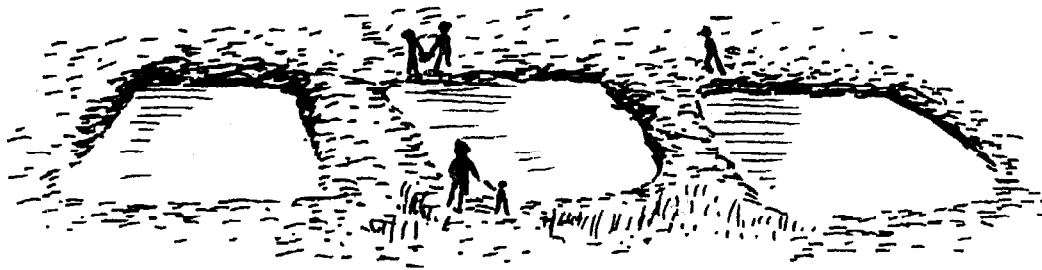

Getting Ready to Plan a Fish Farm

A farmer or other person interested in growing fish should read the following list carefully before going further. The following factors must be considered before the farmer builds his fish pond. Many pond owners have small fish ponds that are only used for their own families, but a farmer who sells fish must look for a market and a way to get his fish to that market. It does no good to harvest fish which cannot be sold or used by the farmer and his family.

- . Is the soil able to hold water for a fish pond?
- . Is there an adequate supply of water for a pond?
- . Is the land a good shape for a fish pond?
- . Is the pond area close to your home?
- . Who owns the land where the pond will be built?
- . Are there enough people to help build and harvest the pond?
- . Can the equipment for building a pond be built, borrowed, or bought?
- . Is there a marketplace nearby?
- . Are there roads from the pond area to a market place?
- . Are the roads passable even in the rainy season?
- . Is there a good way to get the fish to market?
- . Is there a vehicle available for transportation, if necessary?
- . If there is no market nearby, or if it is hard to get to the market, can the fish be kept by drying, smoking, or salting?
- . Is there enough food for the pond fish?
- . Are there fertilizers available?
- . Do the people in the area like fish? Do they eat freshwater fish?
- . Can the people in the area afford to buy the fish produced in the pond?

If the farmer can answer yes to the questions which most fit his situation, he has a good chance of having a successful fish pond. But he must consider these factors. Each is discussed in detail in the "Planning" sections.

2

Planning: The Site and the Type of Fish Farm

Before construction can begin, the farmer must look over his land to choose the place or places where ponds can be built, and decide what kind and how many to build. He must also decide on the kind of fish culture he wants to do, and on the type of fish that he wants to raise. He must look at his resources and his needs very carefully before he actually begins building and operating a fish pond. This section will give information to guide the farmer in the planning of ponds and kind of fish culture.

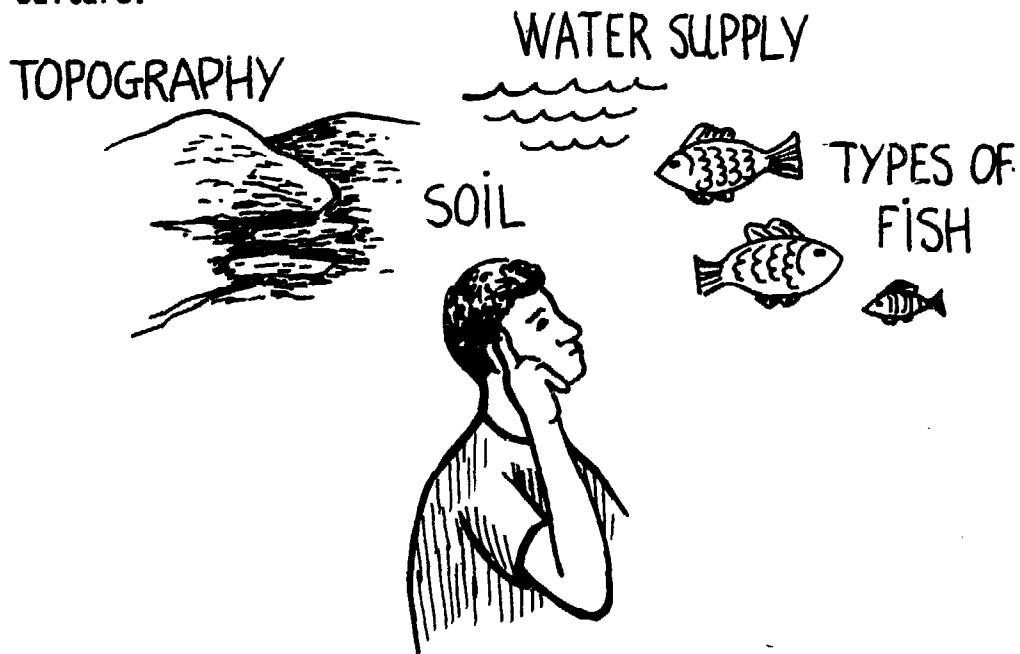

The Site

One of the most important parts of planning is finding the right place (selecting the site) for the pond. Fish ponds use the land in a different way from agricultural crops such as rice or wheat, but fish also are a crop. And when a farmer builds a fish pond, he is choosing one use of

his land instead of some other use. If the site for the pond is well-chosen, the pond can be more productive than the land by itself. But if it is not chosen well, the farmer may lose, or, at best, gain nothing from his fish pond. When considering a site for the fish pond, the farmer should remember and consider several points that were made in the introduction:

- . Often poor agricultural land can be turned into very good fish ponds. In general, the better the soil of an area, the better the fish pond. But this does not mean that a pond cannot be built on poor land. It does mean that the farmer will have to work harder to maintain the pond and the fish.
- . If the pond is built on agricultural land which is not producing good crops, but the pond is cared for well, eventually the pond bottom soil will become more fertile than it was before. If this pond is a large one, after harvesting the fish, the pond can be planted again with a land crop, like corn, and allowed to grow. Then when the corn is harvested, the land can be turned back into a fish pond. This means that a farmer can get two good uses out of his land instead of one poor crop.
- . Other farmers may want to grow fish in rice paddies by digging trenches around the edges of the paddy for fish to swim in. This is another way of culturing fish which will be discussed in somewhat more detail later in the manual.

The point of the discussion above, is that a fish pond is just one use that a farmer's fields can have, and the choice of how the land can be used is important.

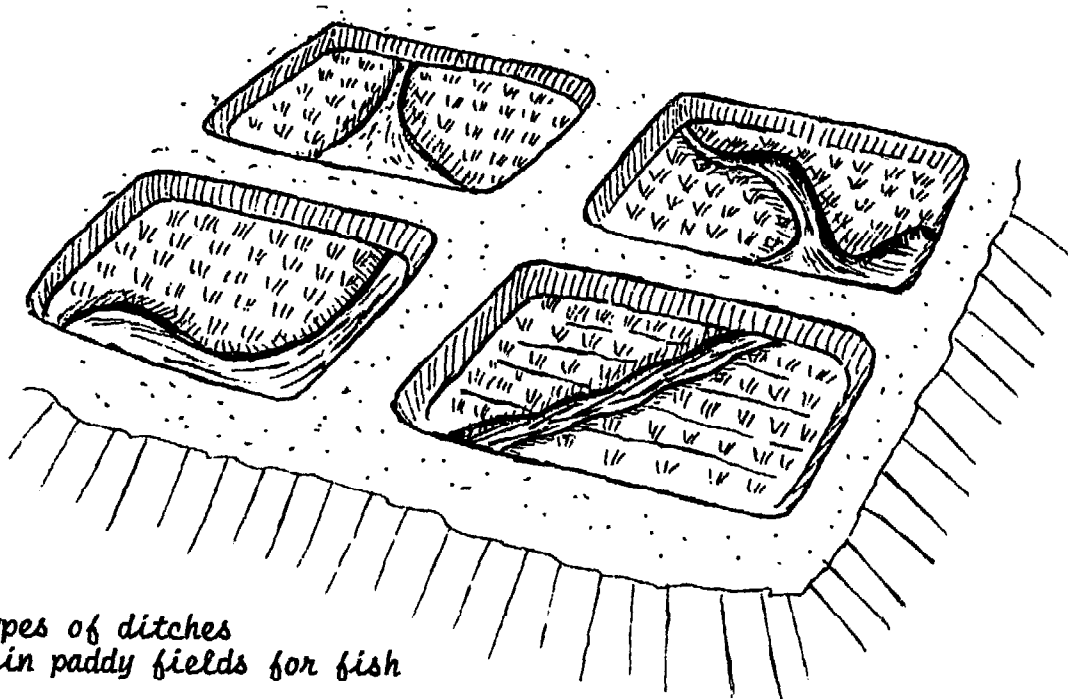

*4 types of ditches
dug in paddy fields for fish*

There are three factors that work together to make a good site for a fish pond:

- . Water supply
- . Soil
- . Topography

WATER SUPPLY Water supply, soil, and topography all are important, but water supply is the most important factor in selecting a site. Fish depend upon water for all their needs: fish need water in which to breathe, to eat, and to grow and reproduce. If a site has water available year-round, that site meets its first test easily. If water is not available all the time but there is some way to store water -- in large tanks, barrels or drums, in depressions, ponds, or wells -- for use when the natural water supply is low, then that site may still be all right. The key, of course, is that water must be available at all times and in good supply.

Where Can Water for Fish Ponds Come From? Water used in ponds comes from many sources:

- . *Rainfall.* Some ponds, called "sky" ponds, rely only on rainfall to fill their need for water.
- . *Run-off.* Some ponds are gravel and sand pits which fill when water from the surrounding land area runs into them.
- . *Natural waters.* Most ponds are filled with water that comes from natural springs or wells, or with water that has been channelled (diverted) and brought in from streams, rivers, or lakes.
- . *Springs.* Some ponds are built where there is a spring to supply water. Spring water is water under the ground that has found a way to get out. It leaves the ground and becomes a stream as it flows away. Spring water is good for fish ponds because it is usually clean (uncontaminated) and has no unwanted fish or fish

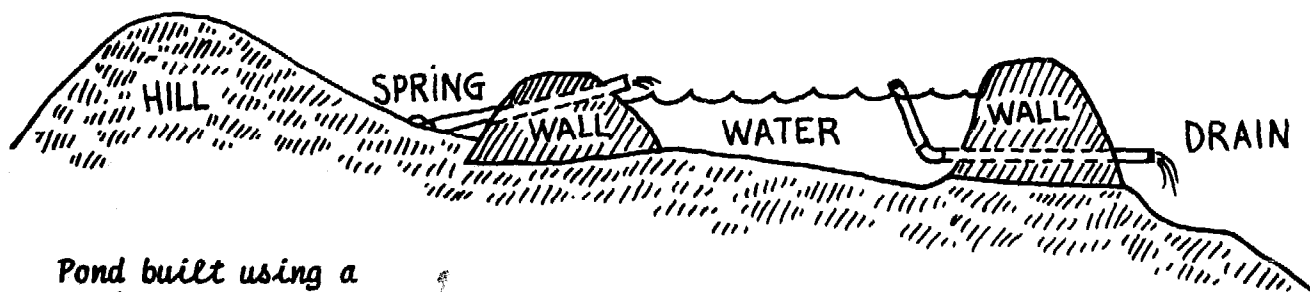

Pond built using a spring as a water source

eggs in it. If the water from a spring has travelled very far, it may need to be filtered before it is used for a fish pond. But filtering is easy to do (see the "Construction" section) and the important fact is that the water supply is available.

- . *Wells.* The best source of water for a fish pond is well water. Well water has few contaminants and, if the well is a good one, the water is continuously available. Well water and spring water, however, are both often low in oxygen content. Fish need to have oxygen in their water to live. Since this problem is overcome easily (see water quality information in the section on "Preparing the Pond") the major factor to be considered here is an adequate water supply.

Most fish ponds use water that comes from a stream, river, or lake. A diversion ditch or channel is dug between the water source and the pond to take water from source to pond. This is a good way to fill a pond because the water can be controlled easily. When the pond is full, the channel can be blocked with a gate or a plug (see "Construction" section), and the water will stop moving into the pond.

There can be problems with this kind of water supply; for example, often in tropical areas streams flood in the rainy season. This extra water can be dangerous to the pond and must be diverted away from the pond by a channel built for that purpose. **IT IS BEST NOT TO CHOOSE A PLACE THAT IS KNOWN TO FLOOD WHEN CHOOSING A WATER SUPPLY AND SITE FOR A POND.** When a pond floods, all the fish escape, and the pond is empty at harvest time.

If the water for the pond is being taken from a stream, lake, or river, then the farmer should plan to filter the water carefully when filling the pond. Water from these sources sometimes contains unwanted fish or fish eggs. Filtering prevents these fish or eggs, and other harmful animals, from entering the pond.

Quality of the Water Supply. Finding an adequate water supply is the first step. Then the farmer has to check that supply to make sure it can be used for a pond. This check of the water should include:

- . looking at the water, smelling it, and tasting it.
- . looking to see if there is a family upstream who take baths in the water before it gets to the pond.
- . making sure that there is no family or village downstream that depends upon the source for their drinking water.

If the water supply seems all right, the farmer must also find the answers to some other questions. Where the water comes from, how far it travels to get to the site for the pond, and what kind of soil it travels over will all affect the quality of the water. These questions and their answers tell what must be done to make the water right for a pond:

- . Is the water very clear? Then the farmer may have to fertilize the pond because there are not enough nutrients in the water.
- . Is the water very muddy? Then it will have to settle before it is used in the pond: a special place will have to be made where the mud can settle out of the water before the water goes into the pond.
- . Is the water a bright green? It probably has a lot of fish food in it.
- . Is the water a dark, smelly brown? It may have acid in it, and the farmer will have to add lime to the water.

There are many things which can be done to make water good for a pond. If the farmer knows his supply and the kind of water he has, he can take the steps necessary to use his supply well.

SOIL The second important part of site selection is the soil of the area. The soil of the pond must be able to hold water. It also contributes to the fertility of the water because of the nutrients it contains.

Ability of Soil to Hold Water. The best soil for a pond contains a lot of clay. Clay soil holds water well. When a place with a good water supply is found, the farmer must test the soil. He can tell a lot about the soil simply by feeling it. If the soil feels gritty or rough to the touch, it probably contains a lot of sand. If it feels smooth and slippery, it probably means there is a lot of clay in it. This smooth soil is good for a fish pond.

A very good way to tell if the soil is right for a fish pond is to wet a handful of soil with just enough water to make it damp.



Then squeeze the soil.

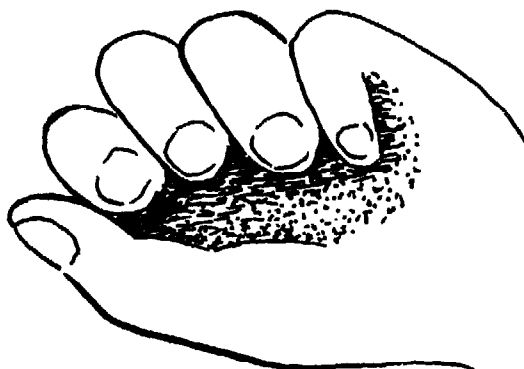

If it holds its shape when the farmer opens his hand, it will be good for a pond. Remember, the more clay in the soil, the better it is for building a pond.

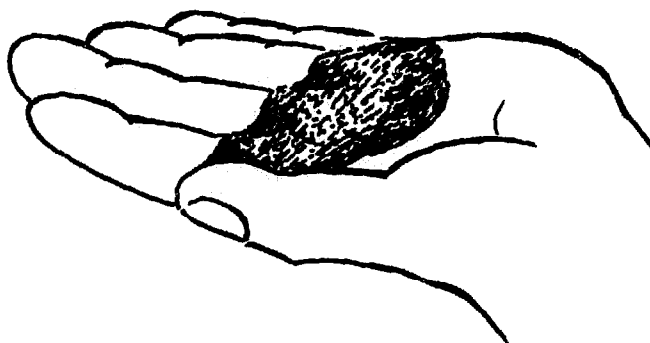

If the soil is sandy, or does not contain much clay, the farmer can still build a pond. There are ways of building ponds in these soils. But he should be aware that building a fish pond in such soils requires more effort and may not be as successful. Digging test holes will tell the farmer what his soil is.

Larger ponds can be built in soils with clay. If the soil is rocky or has shifting sand, etc., only small ponds are possible. If there are other locations available, the farmer would be wise to see if there is another place with soil better suited to the fish pond. More information on soil is included in the "Construction" section.

Ability of Soil to Provide Nutrients. Soil also contributes to the pond's fertility. Fertility is a measure of the nutrients in the pond, and it simply refers to how much food there is available in the pond for the fish to eat. A very fertile pond is one which contains a lot of fish food.

The soil of the pond contains some of these necessary nutrients -- like iron, calcium, and magnesium. In addition, however, soil also can contain acids; these substances often are harmful to fish. Whatever a soil has in it is drawn into the pond by the water and thus comes in contact with the fish. Sometimes after a heavy rainstorm, there are big fish kills in new ponds. This happens because the heavy rain carries larger amounts of acids from the soil into the pond. So the farmer who is aware of the kind of soil he has for his fish pond can prevent this problem before it happens.

REMEMBER: One good indicator of the quality of soil is whether it has been used for growing crops. If crops grow well in that location, the soil will probably be good for the fish pond. If crops did grow well there before the nutrients were used up, then it will probably still be free of harmful substances.

TOPOGRAPHY The third factor in site selection is topography. Topography is a word used to describe the shape of the land -- whether it is flat or hilly, upland or lowland, etc. The topography of the land determines the kinds of ponds which can be built. Ponds can be built in valleys or on flat ground. They can be square or rectangular, or uneven in shape. They can be large or small. All of this is determined by topography of the land, as well as by the farmer's requirements.

The most useful topography for fish ponds is that which allows the farmer to fill and drain ponds using gravity. Ponds built on a slope, for example, can be drained easily. If ponds are located on flat land, the pond must be built with a slope inside it so it can be drained by gravity, or it will have to be drained using a pump.

Slope. If the farmer looks at a hillside, he can see that it rises. It is higher at one point than at another. This difference in height, from high to low point, is the slope of the land. In more scientific terms, slope is the relationship between the horizontal distance (length) and the vertical distance (elevation) over a piece of land.

Slope is usually written as a ratio (1:2) or as a percentage (5%). A slope of 1:2 means that for every change in length of 2 meters, there is a change of 1 meter in height. A slope of 5% means that for every change in length of, say, 100cm, there is a change in height of 5cm. Pond bottoms usually have a slope of 2-5%, whether they are on level ground or in a hilly area. As long as the pond bottom has a slope, it can be drained completely.

A farmer does not require a scientific understanding of slope to build a pond. He does need to know how the shape of his land determines the best place for building ponds. Ponds built in hilly places often are made part of the hill. The picture on top of the next page, of a pond with a spring as a water source, shows how the slope of the land has been used to set up the pond's drainage system.

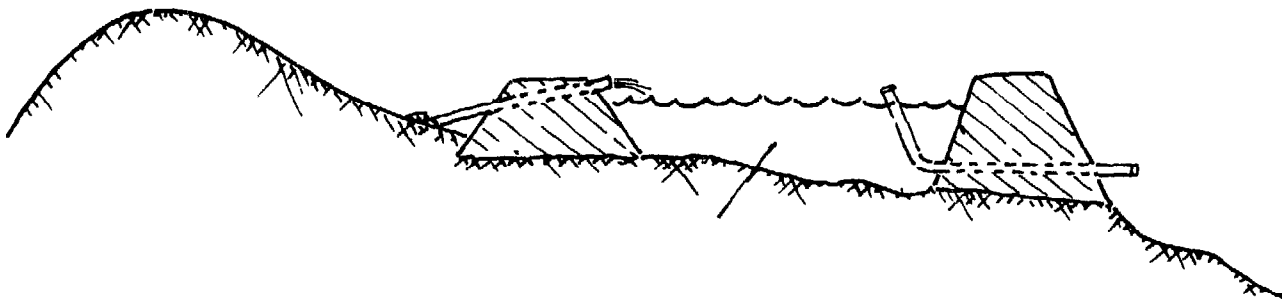

In flatter areas, ponds are usually square or rectangular because it is easier to use a harvesting net in ponds of these shapes.

The farmer will learn quickly to recognize by sight the slope that is best for a pond. Because a slope is so important, the first thing a farmer should look for is a site with a slope and a water supply. If he can use a natural slope for his pond, the pond will be cheaper and easier to construct.

The best places to look for such combinations of slope and water supply are where water collects from streams and flows through the valley at the bottom of a slope. If the pond is built on the slope above the water flow, water drained from the pond can flow directly into the stream. Water might be brought to the pond in a number of ways depending upon the situation -- by streams running down the slope upon which the pond is situated, for example. Another good place to look for a good combination of slope and water supply is on plains or flattish ground between hills. These plains often receive water from brooks or streams.

There are many possibilities. The important thing is that the farmer look for a topography that makes fish farming as easy and as successful as possible.

The Type of Fish Farm

After the farmer has found a site or sites for his fish pond, he must consider what kinds of fish culture are possible in the space he has available. He also must decide what his resources will allow him to get started. This planning is necessary because the answers will determine the number of fish ponds the farmer builds and the kind of fish he will want to culture. The following pages present a range of ideas concerning the kinds of fish farm operations (raising fish or breeding fish); the types of pond used in fish culture; fish culture in one or several ponds; advantages of small and large ponds; and mixing or separating fish types and sexes. A discussion of these subjects will provide the farmer with the background he needs to decide what kind of fish farm is possible for him, given his resources and the kind of fish he wants to raise.

NOTE OF CAUTION Before a farmer even begins, however, it is important for him to include in his planning the fact that some fish will die. This is an extremely important fact for the first-time fish grower to understand. It is very natural for some fish, the weaker fish, to die in ponds. As long as fish are protected in ponds and are well taken care of, weaker fish will die in ponds than would die in natural waters. But a farmer who does not expect some death may get discouraged and give up before he has given his pond a chance to work. It is never too early to produce this idea.

PROBLEMS OF FISH FARM OPERATION In nature, many fish never reach ultimate size because they are eaten by other animals (predators), or they die from disease or lack of oxygen. In fish culture, the farmer tries to control the pond situation in order to produce more fish. In ponds, predators and so on can be controlled so that the pond yields more fish per hectare than do natural waters.

There are two major kinds of fish farms -- those which breed fish and raise the fry, and those which rear fry and fingerlings (the young fish) to market size. So the farmer, after finding possible sites, etc., must decide if he is going to breed his fish and raise the fry. Or if he is going to buy fry and fingerlings and rear them to market size, not getting involved in breeding.

Rearing fish requires more time and more ponds than simply rearing fingerlings. And building more ponds can be more expensive and require more ongoing management. So the farmer must finally determine his reason for raising fish: to eat; to sell; to use his land better; or all of these. He will have to have all these things firmly in mind so that he can:

- . build the right kinds of pond.
- . build the right number of ponds.
- . stock the right kinds of fish.

TYPES OF PONDS The types of pond a farmer can build depend on water supply, soil, and topography, the factors which were just discussed. The two types of pond most often built are barrage ponds and diversion ponds. Many aspects of the construction of these ponds are the same. The main difference between these two types of pond is the water source.

Barrage Ponds. These ponds are usually filled by rainfall or by spring water. A spring, for example, sends water flowing through a small valley or down a slope into a low place. Or a spring bubbles from the ground into a natural depression. The pond is formed by collecting water at the base of the valley and in the low places. The farmer does this by building a wall (dam) which holds the water inside what now is the pond area. The wall keeps the water from entering and leaving except as needed.

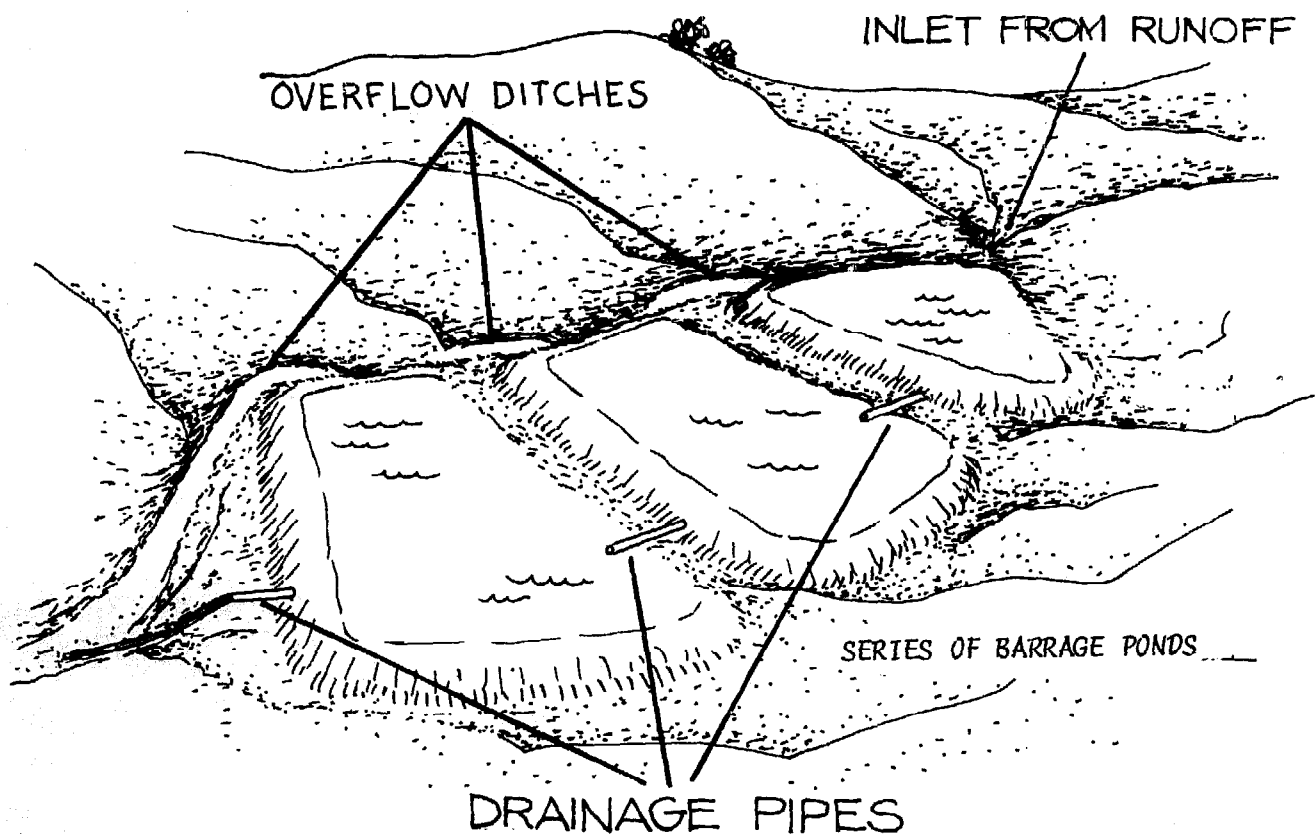

The number of pond walls the farmer must construct depends upon the land and on how he fixes his drainage system. A barrage pond usually needs only one wall -- the main wall between the water source and the pond area. One kind of drainage system called a sluice (see "Construction" section) can be used to let water both in and out of the pond. There are also a number of simple drainage systems which can be used that do not require any complicated construction.

Barrage ponds should not be built where the flow of water is too great: it is difficult to keep the water from breaking down the wall if the pressure of the water is too great. Brooks and streams which flow well, but not too strongly, make good sources for barrage ponds.

Even when the flow of water is not great, however, barrage ponds require overflow channels. Because barrage ponds are usually built in low areas, they are likely to fill up in heavy rains. Overflow channels are any kind of system which can be set up to stop the pond from collecting too much water. The overflow takes extra water away from the pond. If this extra water is not taken out, the pond wall may break. Therefore, the overflow system is needed to help the drainage system handle the flow of water when there is too much water in the pond.

The overflow system can be wide grooves cut into the top of the wall toward the ends away from the middle; it can be large hollow tree trunks which are set into the tops of the wall and work as pipes to drain the water into ditches, or even to carry the water into storage areas for use later when the water supply is low. Another kind of overflow can be ditches, dug into the ground above pond level, which take the extra water away when the water rises to that level.

An overflow often is not screened, because if something large catches on it, the pressure of the water behind it might cause the entire wall to break. This fact results in a loss of fish at time of flooding.

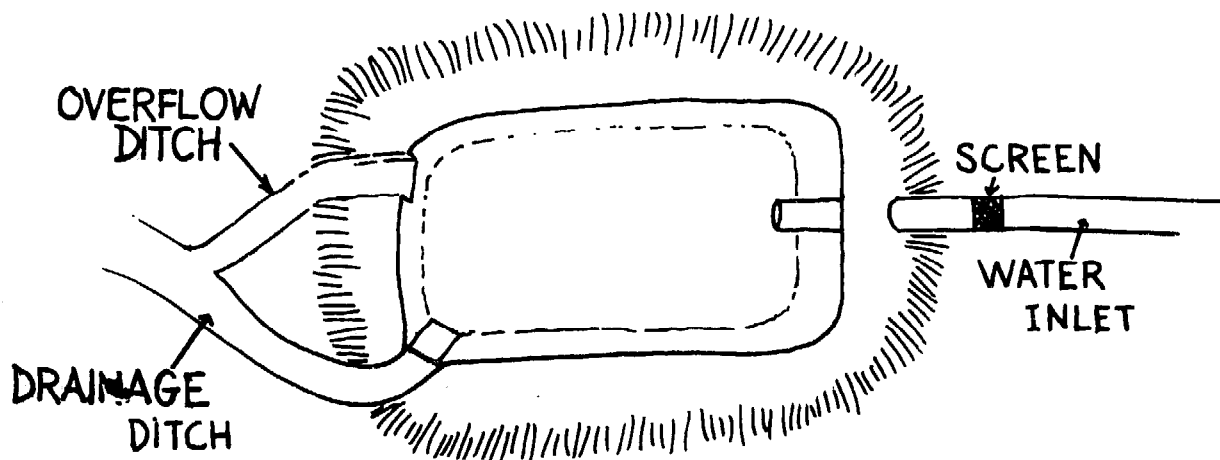

Diversion Ponds. These ponds are made by bringing (diverting) water from another source like a stream or river. Channels are dug to carry the water from the water source to the pond.

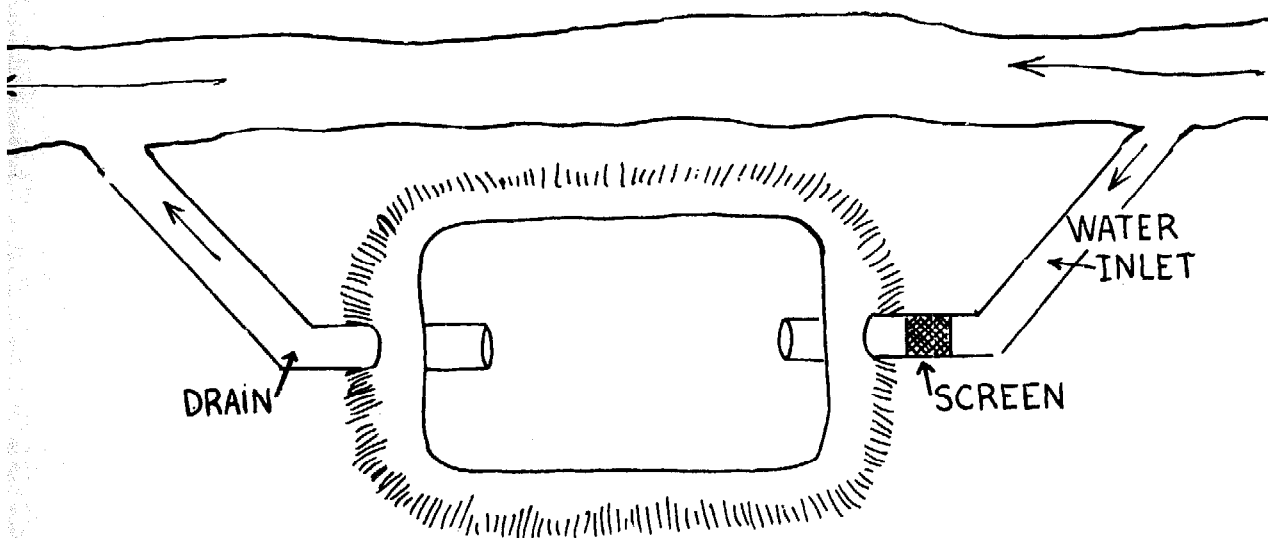

Diversion ponds can be made in a number of ways. Sometimes a pond is dug in flat ground or can be made by slightly enlarging a natural depression in the land.

These ponds, like the barrage ponds, require walls depending upon the topography of the land, the drainage system used, etc. A pond dug in flat ground often requires four walls; a pond built in a natural depression may not.

With a diversion pond, the water is always brought to the pond instead of running directly into the pond. Water can be diverted in a number of ways. For example, a small stream which gets its water from a larger stream nearby can be dammed and used as a diversion channel to feed a pond. Or water can be diverted to a pond from an irrigation ditch which carries water to agricultural crops from a nearby well or lake.

A farmer may have one diversion pond, or if his space allows and the water supply is sufficient, he may have several. When a series of diversion ponds is built, they are built in one of two ways:

- . *Rosary system.* These ponds are built one after another in a string. In this system, all the ponds drain into each other and must be managed as if they were one pond. Therefore, if the first pond in the series (the pond with the water inlet) is full of predators which must be poisoned, all the other ponds in the system have to be harvested (have the fish taken out) and drained before the first pond can be poisoned and drained.

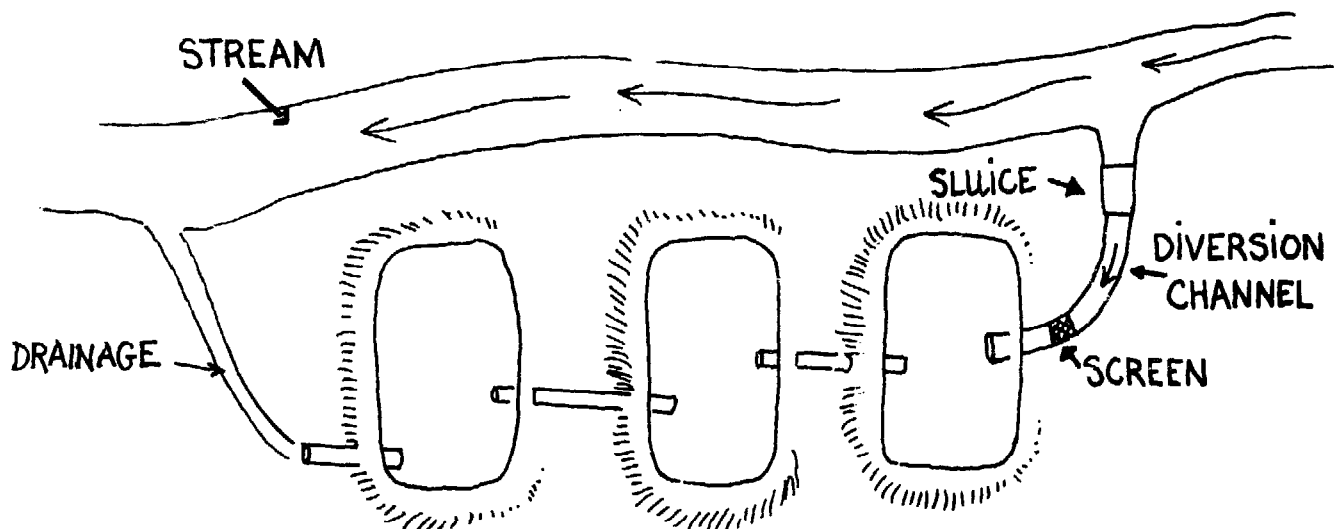

- . *Parallel system.* In this series, each pond has its own inlet and outlet. Therefore, each pond can be managed as a separate pond.

Each kind of pond is going to have advantages or disadvantages depending upon the farmer's situation. A parallel system of diversion ponds, in most cases, is a better system. But rosary systems are cheaper and easier to build, and therefore, more possible for some farmers to undertake. Also, if the water source is good, and can be kept free of predators and unwanted fish, and if the management of the pond is done well, a rosary system can be very successful.

Diversion ponds are often better than barrage ponds because they are less likely to overflow, and the water source is often more dependable throughout the year. But barrage ponds require less construction and are likely to be cheaper. In addition, for some farmers, barrage ponds are the best, and perhaps the only, way for them to use their land for fish ponds.

The art of constructing and planning a fish pond or fish operation is very much an individual thing. There are basic ways of using resources, for example, land and water sources. But the exact shape and type of fish pond must be decided by the farmer for his situation. There are many ways of making fish ponds which will work, and the "right" way for any given farmer is the way which works best for him. Many aspects of fish farming are determined by experimenting with pond operation, but much can be done by good planning before fish pond construction.

Therefore, the farmer must look at his sites and consider the types of ponds he can build from the viewpoint of the number, size, and depth of the ponds he is going to need. If, for example, the farmer thinks he has a good area for a diversion pond, but hits solid rock at 1m and needs a pond 2m deep, he can find this out before he invests a great deal of time and money. If he has room for two small diversion ponds and a barrage pond, or for a large diversion pond and a barrage pond, he can base his decision on what kind of pond to build upon the number, size, and depth of pond he needs for what he will be doing.

The Number of Ponds. The number of ponds depends on the possible sites and on what the farmer plans to do with his fish ponds. If he is going to raise fingerlings to market size, he will need one or a few "rearing" ponds. If a farmer plans a larger operation in which he will breed fish for the eggs and fry, he will need space for nursery pond, rearing pond, and a pond for brood stock. Nursery ponds can hold eggs and fry until they are fingerling size; rearing ponds hold the fingerlings until they are market size; brood ponds hold the fish to be used for breeding.

It is possible to breed fish in a corner of a large, single pond, and a farmer interested in raising fish for his own use may want to do this. But a farmer interested in marketing fish probably will want at least two large ponds. If he has two medium-large ponds, he can use one for rearing fingerlings and one for broodstock. Eggs and fry can be taken care of in very small ponds or even containers.

The Size of Ponds. The size of ponds depends upon the same factors -- topography, water supply, and need. Nursery ponds usually are smaller than rearing ponds because the fry are very small. The size of nursery

ponds depends on the fish species being cultured. In fact, eggs and fry can even be kept in washtubs, oil drums or any other such container which holds enough water for the number of fry and is supplied with enough oxygen.

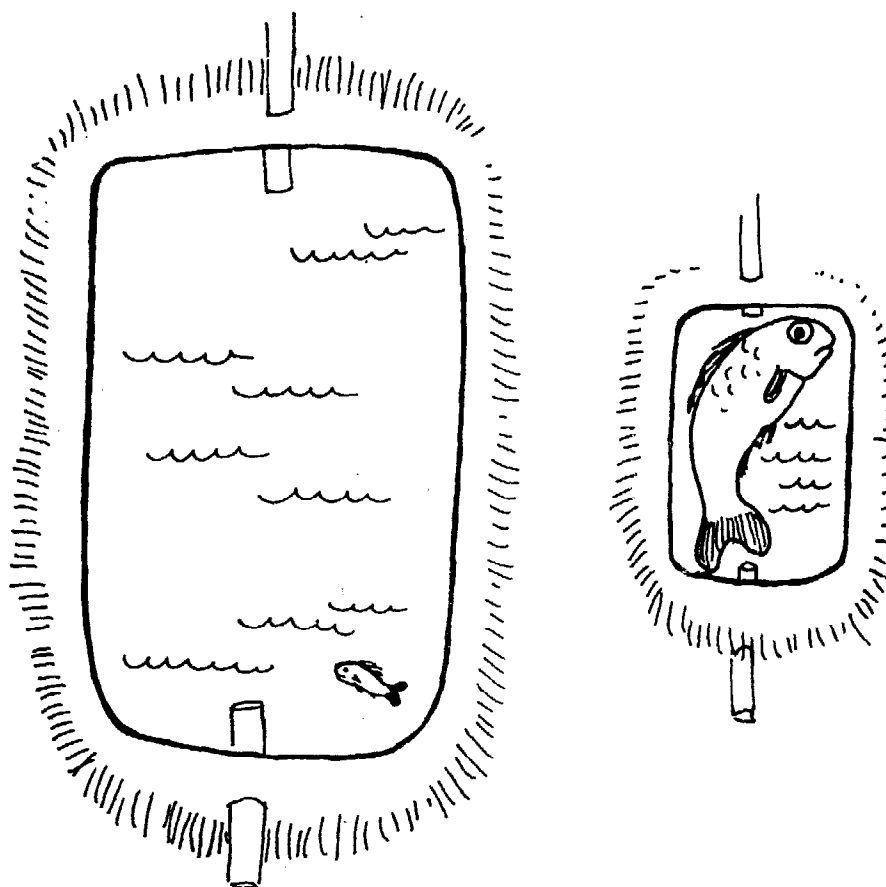

As the fish grow, they need more space. So rearing ponds are usually bigger than nursery ponds, and brood ponds are bigger than rearing ponds.

Sometimes a farmer will have to choose between one large pond or several smaller ponds. His site would allow him to decide either way.

Here are some advantages of small and large ponds:

- Small Ponds:*
- . harvest easily and quickly
 - . drain and refill quickly
 - . treat for disease easily
 - . are not eroded by wind easily

- Large Ponds:*
- . cost less to build per hectare of water
 - . take up less space per hectare of water

- . have more oxygen in the water
- . can be rotated with rice or other crops

For most farmers, a few small ponds are better than one or two large ponds. Farmers must also manage their agricultural crops, and it is difficult for them to manage large ponds. Also, most farmers just do not have a lot of land. A good size for a single fish pond is probably between 1 and 5 ares (100 and 500m²).

Farmers are going to be most interested in working the fish pond into an already going farm as simply and easily as possible. This is why culturing fish in rice paddies is popular in some areas. In fact, fish ponds can be set up in almost any area where a rice paddy can be located -- even on steep hillsides.

Small ponds are easier to care for and construct. As a farmer gains experience, he can go on and build larger ponds. Starting small is a good idea until the farmer feels he knows what he is doing and is successful.

Depth of Ponds. The depth of ponds depends upon the fish being grown. Fish species like different kinds of food, and the depth of the ponds affects the kinds of food produced by the pond. A common carp, for instance, eats worms and other bottom organisms and must have a pond that is not deeper than 2m. But when the carp are fry, they eat only plankton, the tiny free-floating plants and animals suspended throughout the water. So nursery ponds for carp fry are often only 0.5m deep. (As mentioned before, eggs and fry can be taken care of in almost any container which holds enough water and has enough oxygen.)

Other fish feed at other levels in the ponds depending on their life stage and on their own food preferences. A very deep pond will not produce as much food because the sunlight cannot light the water below a certain depth, and the plankton will not be able to make oxygen for the fish (see water quality). On the other hand, a very shallow pond might be turbid, covered by water plants easily, and become very hot. Most pond owners make sure that the water depth at the edges of the pond is at least 75cm to discourage water plants. It is best if the pond is about 75cm deep at the shallow end and up to 2m deep at the deepest end. This will give the best results with most pond fish.

THE ONE-POND OPERATION If the farmer's site can only have one pond, his decision is easy. It is hard to breed fish when only one pond is available. Usually a single pond is used only for rearing fish from fry or fingerlings to market size. This is the case in small, backyard fish ponds that are used to supply fish for only one family. A good minimum size for such a pond is 15m² in area and 1m deep. A smaller pond would probably not be worth the effort to build and maintain.

A single pond is stocked with the fry or fingerlings. For example, a pond of the size mentioned above could be stocked with 60 fingerlings. These young fish are cared for until they reach adult size. Then the

pond is harvested (the fish are taken out). The pond area can then be prepared for a new batch of fish and stocked again.

One pond can provide a good food source for the family. However, rearing fish means that somewhere there must be a source of fry or fingerlings for use in the pond. The farmer must check his area carefully, so that he is sure the young fish are available before he builds one pond.

The source can be a river where he collects the young fish, or a local fish farm which breeds fish to supply farmers who have small ponds, or a government hatchery where the farmer can buy the young fish. If the farmer decides that he wants to breed fish in his pond, it is possible to breed some fish inside small nets placed in the pond. A single pond, though, is usually used just for rearing fry or fingerlings to a good size for food and market.

While one pond usually means that the farmer is wise to concentrate on raising one batch of fish from fry or fingerlings to market size, he still must decide what kind or kinds of fish he will raise in his pond. He can raise one kind of fish alone (monoculture), or he can raise several kinds together (polyculture).

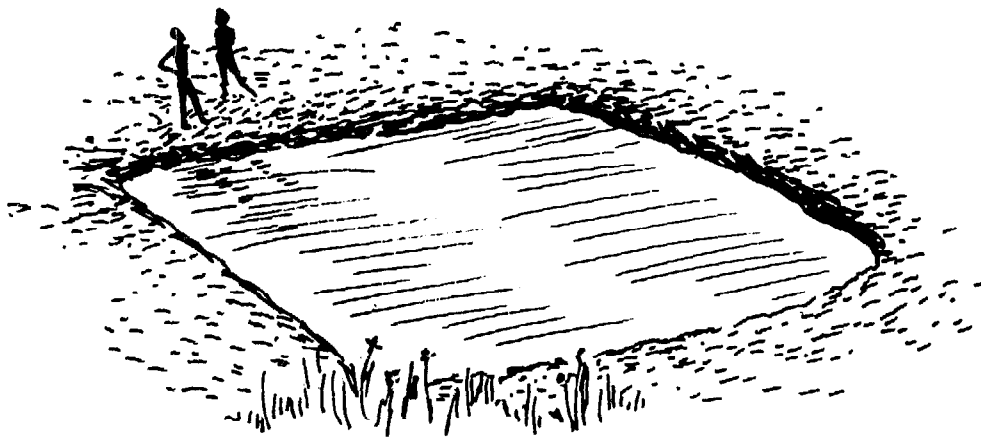

MONOCULTURE Monoculture is the culture of only one species (kind) of fish in a pond. It can be tilapia of one species, common carp, or any other single fish species.

Monoculture has some advantages. One advantage is in intensive fish culture practices, where fish are fed a lot of supplementary foods for fast growth. It is easier to give these foods if there is only one type of fish in the pond. Another possible advantage is that monoculture gives greater control over the age and sex of the fish. In monocultures, fish can be of all different ages and life stages, or they can be separated into fry, fingerlings or brood stock.

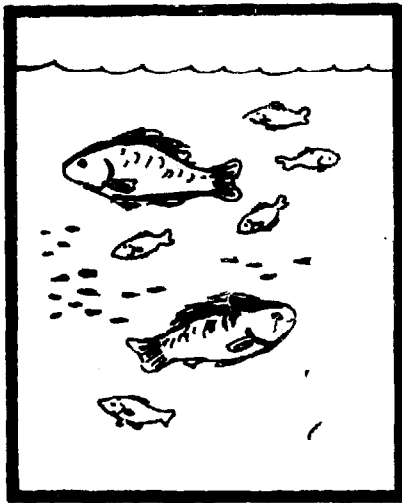

MIXED AGES

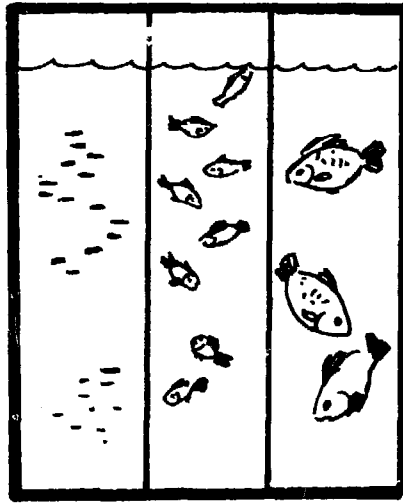

SEPARATED BY AGE

A monoculture allows a farmer who is unfamiliar with fish farming to get to know his one type of fish very well. And there is some advantage to this.

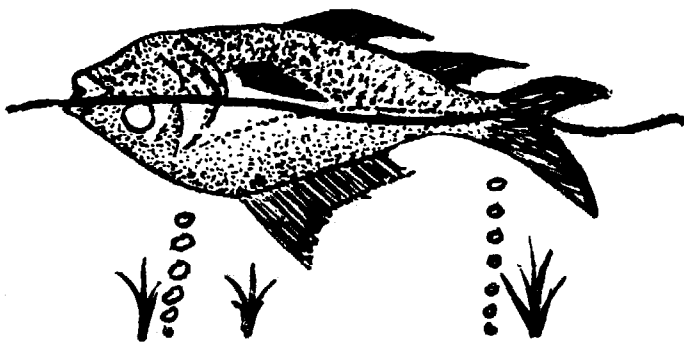

One disadvantage of a monoculture pond is that it is more likely for a single disease or parasite to kill all fish in the pond. Different fish are susceptible to different diseases. If only one fish type is present in the pond, a bad fish disease could easily infect and kill all the fish if it were not stopped in time.

In monoculture ponds, fish are harvested selectively by using nets which have meshes of different sizes. For example, if the farmer wishes to harvest larger fish for market or breeding, the net will not catch or hurt the fry or fingerlings, because they are too small to be caught by a large-mesh gill net. This allows the farmer to keep his pond in operation and producing fish for food all year.

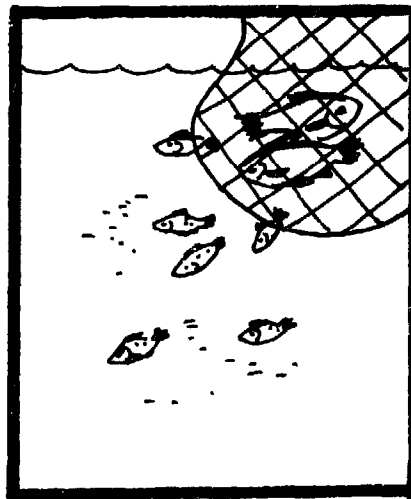

SELECTIVE HARVESTING

Monoculture is the most common kind of pond culture. For a small fish farmer who is most interested in having a nearby, year-round supply of protein (and who does not have a lot of time or interest to give to the pond), a monoculture may be a very good idea.

POLY CULTURE

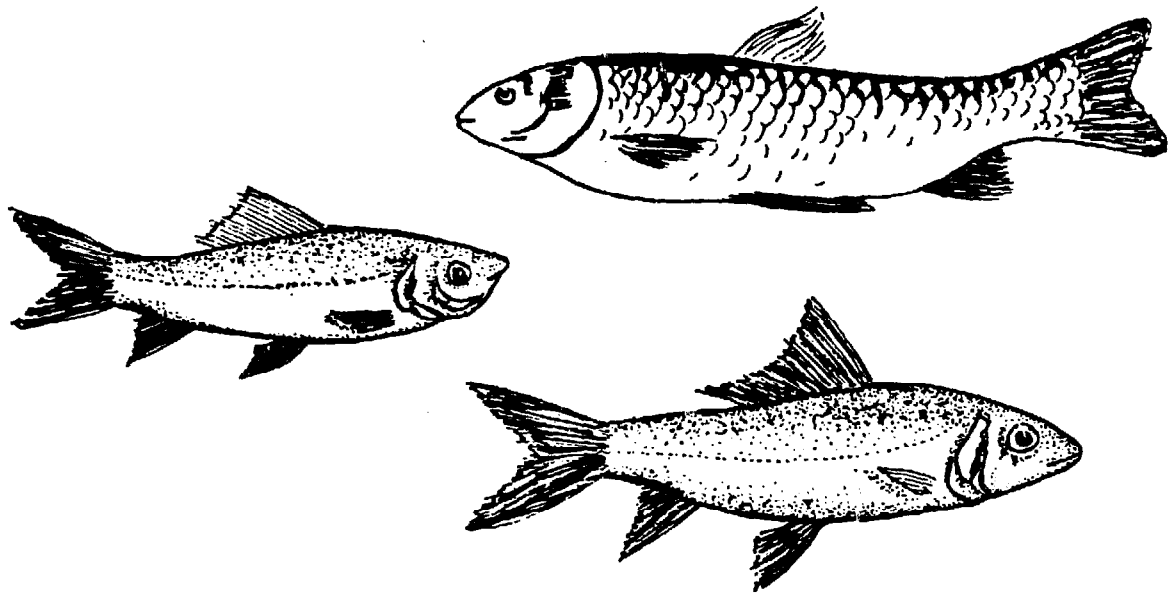

Polyculture is the culture of two or more fish species together in a pond. A good polyculture uses the natural food sources in a pond better: if the polyculture is mixed correctly, each of the species eats a different food from the pond.

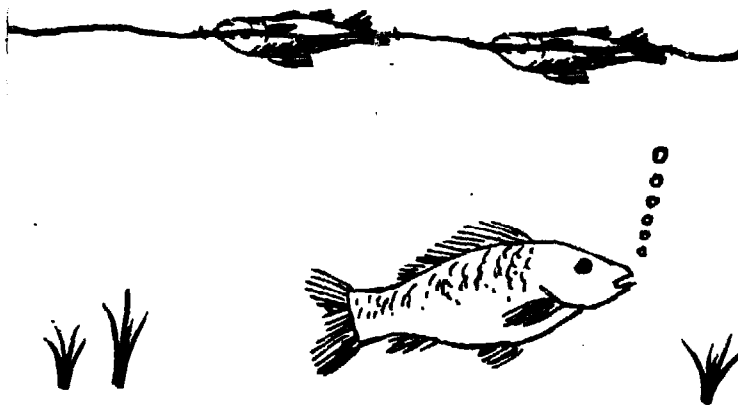

Polycultures are more resistant to disease. Disease, if present, usually attacks the smaller, weaker fish, and the healthier fish continue to live and grow.

Fish stocked in a polyculture must be able to live together. And living together successfully means that the fish put into the pond together do not all need to eat the same food. A polyculture can have fish of any size or age -- as long as a balanced relationship is maintained.

Some examples of polycultures are:

- fingerlings of two or more species stocked together in a fertilized pond and left to grow. A good mixture in this

kind of polyculture is a mixture of Chinese carp -- silver, grass, and bighead carp stocked together. The silver carp eats phytoplankton; the grass carp eats pond vegetation; the bighead carp eats zooplankton.

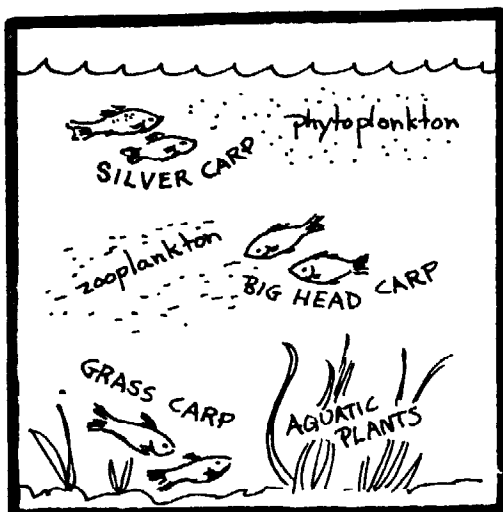

MIXED CARP FINGERLINGS

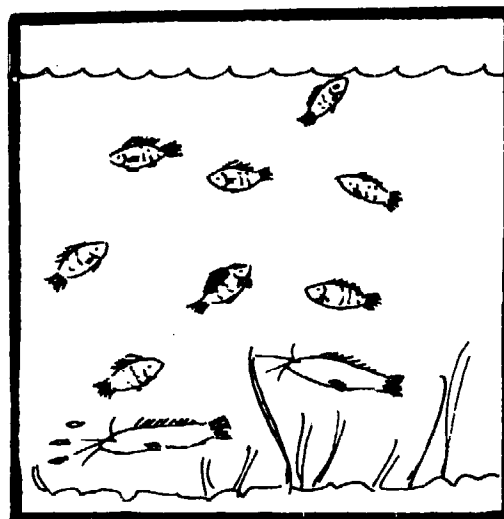

TILAPIA FINGERLINGS + CATFISH

- A few large fish (brood size) are stocked with fingerlings of another species in a pond and left alone. A good example of this is stocking tilapia fingerlings together with a few adult-sized *Clarias* catfish. The catfish feed on bottom organisms and serve as a population control on the fry that are produced in the tilapia ponds. Since one of the problems which can be associated with culturing tilapia is overpopulation, this is a very complementary relationship.

Population
control

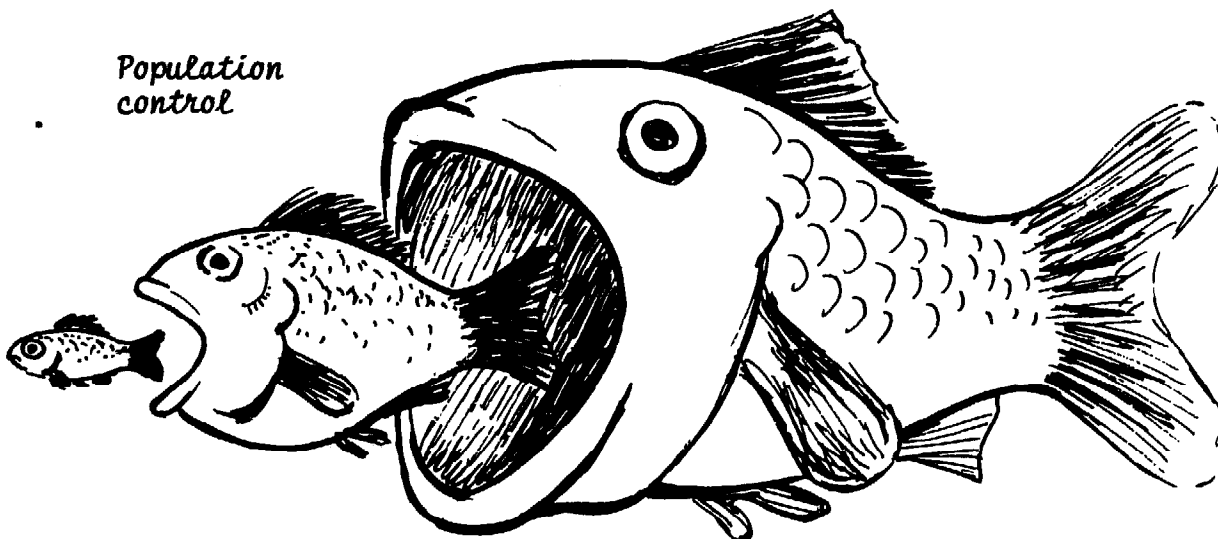

- Another example of this type of polyculture is a stocking of any kind of fingerlings mixed with a few large grass carp for weed control.



A farmer must be careful to avoid the problem of fish competing for food when he plans a polyculture.

Polyculture is a good way to use a pond, especially if there is only one pond to use. A careful examination of local fish and their habits should tell a farmer what kinds of polycultures are possible in his pond. The important thing to remember is that the fish must not compete with each other. If stocked and managed correctly, polyculture ponds can give maximum production to a fish farmer. In very practical terms, the farmer could raise as much as three times more fish in a polyculture of three species than he can raise in a monoculture pond of the same size.

MONOSEX CULTURE A word should be said about monosex culture, even though few farmers will choose or be able to choose this way of operation. Monosex culture means growing only one sex of one species of fish in a pond. When only males or only females are stocked in a pond, all the energy of a fish goes into growth and not into reproduction.

An all-male stocking has faster growth rates than a mixed stock of males and females. So some farmers try to stock only males or females in a pond. One fish species that often is used in monosex culture is tilapia. Tilapia reproduce at a very small size, but when separated by sex, they do not develop their reproductive organs, yet continue to grow.

One way to stock a monosex pond is to separate the fish one by one according to sex during the breeding season. Often, at this time, fish change color, and it is easier to sort fish by sex. Then the fish can be grown to a larger size.

In another method, people have been trying to obtain fish of all one sex by putting two different species of tilapia into a pond. When these fish breed, they produce either a monosex culture or a sterile hybrid. Three crosses do now produce 100% male offspring.

Crosses of Tilapia which Produce 100% Male Offspring:

MALE	CROSSED WITH	FEMALE
<i>Tilapia macrochir</i>	X	<i>Tilapia nilotica</i>
<i>Tilapia mossambica</i>	X	<i>Tilapia nilotica</i>
<i>Tilapia hororum</i>	X	<i>Tilapia mossambica</i>

There are no crosses that produce 100% female offspring as yet. Males are preferred because they continue to grow during the breeding season, when there are no females present -- even though they (the males) continue to build their nests in preparation for mating.

Monosex culture is a valuable method of pond culture, but is usually difficult to do: the hybrid crosses are very new; hand-sorting fish by sex causes many of the fish to die from stress. Even if the fish are sorted without stressing them, one fish of the opposite sex that accidentally finds its way into the pond can ruin the whole monosex culture. So monosex culture is generally not practiced by small-scale fish farmers.

THE MORE-THAN-ONE-POND OPERATION A farmer who has a larger area to work with might wish to consider having two or three small ponds. Perhaps two ponds would be diversion ponds, and the third, a barrage pond fed by a spring. Perhaps the farmer has room for only two barrage ponds. He does not want to keep eggs and fry in the ponds because it is harder to protect eggs and fry in barrage ponds. This does not mean he cannot breed fish. He can keep eggs and fry in an oil drum, washtub, or anything else as long as the water is clean and contains plenty of oxygen.

With three ponds, one pond can be the rearing pond in which fingerlings are raised to market size; one can be used to keep brood stock; and the third, and perhaps the smallest, can be used as a nursery pond where the eggs hatch and the fry grow to fingerling size. If the farmer does not plan to breed fish, then he can use all three ponds as rearing ponds. He should not do this, however, without thinking ahead to the harvest and making plans for marketing the fish he will grow, or preserving the fish for sale or use later.



The major difference between a large farm operation and a small one may be only the number of ponds. Three ponds is enough to have a full-fledged operating fish farm which includes breeding, selling fry and fingerlings to other farmers, and raising fry and fingerlings to market and brood size. Once the farmer is a skilled pond manager, these ponds should do well and provide a good return on his investment.

Until the farmer is experienced, however, it is better for him to start with small efforts and a smaller operation. Small pond failure is not as severe. Once the ponds are working well, the farmer can expand and build more and/or larger ponds. But he should be encouraged to start small. There are a lot of factors in fish pond management that are learned best by experience. But a bad experience will discourage, rather than encourage the pond owner.

A FINAL WORD ON PLANNING PONDS Good planning is a must for a successful fish pond operation. It is during the planning process, before any money or a lot of time and energy is spent, that many problems can be solved.

The farmer should keep in mind while planning that ponds do not have to have expensive equipment in order to work well. Far more important than the equipment are 1) an understanding of the general principles involved, 2) the selection of a fish or fishes that will do well in his pond (see next section, "Selection of Fish"), and 3) good daily management of the pond (see section 6, "Managing the Pond").

3 Planning: Selection of Fish

The farmer now has a firm idea of his site and the types of ponds it is possible for him to build. He also should know what he wants to do with his ponds -- raise fish for food or run a fish-marketing business. Now he must consider very carefully what type or types of fish he is going to raise in his ponds. The success of the pond depends upon choosing the fish that will grow best in the type of ponds and conditions that a farmer is planning.

The following pages give some: 1) general information on characteristics of fish, and 2) detail about certain fish which have proved to be good pond fish and why. This information should serve as a guide to a farmer trying to decide which fish will do best in his ponds.

Characteristics of Fish

The major body parts of all fish perform the same functions, and they are located in about the same places on any different fish's body. But the size, shape, and color are often different, and these differences help tell the fish apart. Knowing how a healthy fish looks is important.

All fish have a tail consisting of the *caudal peduncle* and the *caudal fin*. The fish's fins help it steer through the water and hold it upright in the water. Often a sick fish cannot steer or flops over on its side. Other fins on the body include:

- . *Pectoral* -- usually located on the sides of the fish behind the head.
- . *Pelvic* -- usually located towards the rear of the body where the hips would be if the fish were a four-legged animal.
- . *Dorsal* -- runs along the top of the fish. May be single or double. The second dorsal fin is sometimes called the *adipose fin*.

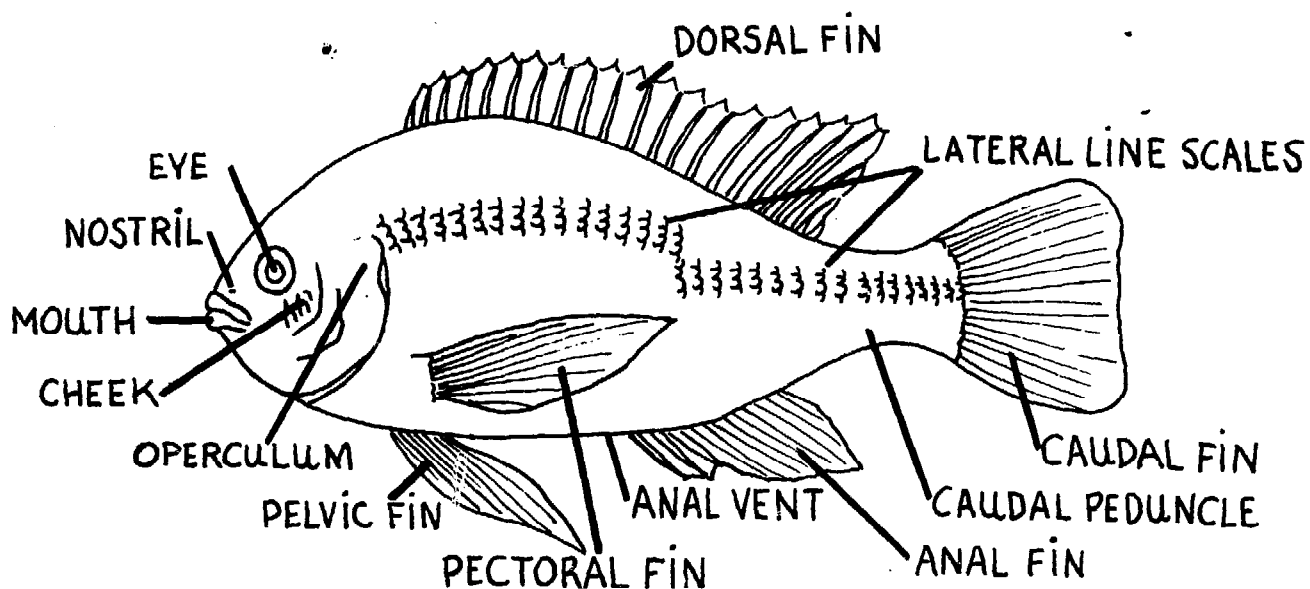

Parts of the tilapia, one of the best of tested pond fish

- . *Anal* -- usually located right behind the *anal vent* (anus) on the rear bottom end of the fish.

All fish have *eyes* and *gills*. The gill is covered by a flap called the *operculum*. Fish can see, but they cannot see very well. The gills are extremely important. Fish take in water through their mouths. The water is then passed through the gills which remove the oxygen and nutrients from the water. The water is then passed outside of the body of the fish through the gill slits.

It is possible to tell a lot about a fish's health and eating habits by looking at its gills. Fish with many, many feathery gill filaments and few if any teeth eat the smaller foods in the pond. Fish with few and larger gill filaments eat the larger particles from the pond. Healthy gills are a bright red color. If the farmer sees fish with gills that do not have this healthy red color, or have white spots all over, for example, he will know that fish is not healthy and should not be bought or placed in his pond. Or if the fish is already in his pond, he knows he must take steps to get rid of the disease before it troubles more fish.

Other identifying parts that all fish have are the *mouth*, the *genital openings* (reproductive organs), and the *lateral line*. The lateral line is a small line of nerve cells which runs along the length of the body about midway on the side of the body. Sometimes the lateral line is covered by a layer of scales; sometimes it is a different color from the rest of the body. In any case, the lateral line is an area of sensitivity that helps the fish feel pressure and temperature changes in the water around it.

Some fish, like catfish, also have *barbels*, small projections that hang down from the sides of the mouth. Barbels help the catfish sense its surroundings, find food, and attract small fish to the catfish so that it can eat them.

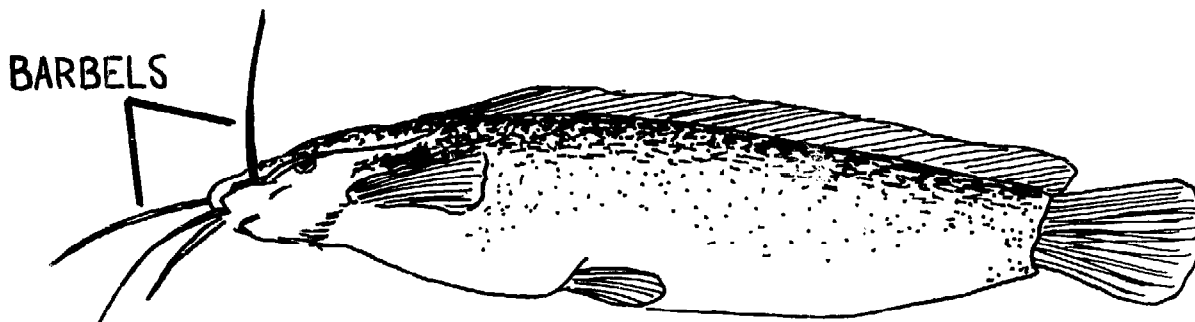

When a farmer breeds fish he will want to be able to tell the difference between male and female fish. This can be difficult with some fish. However, some fish change color in the breeding season (tilapia, for example), so they are easy to identify by sex. Some fish can be classified according to the color and size of their genitals. The separation of fish by sex is best learned by actual experience in the pond.

Sex organs of tilapia

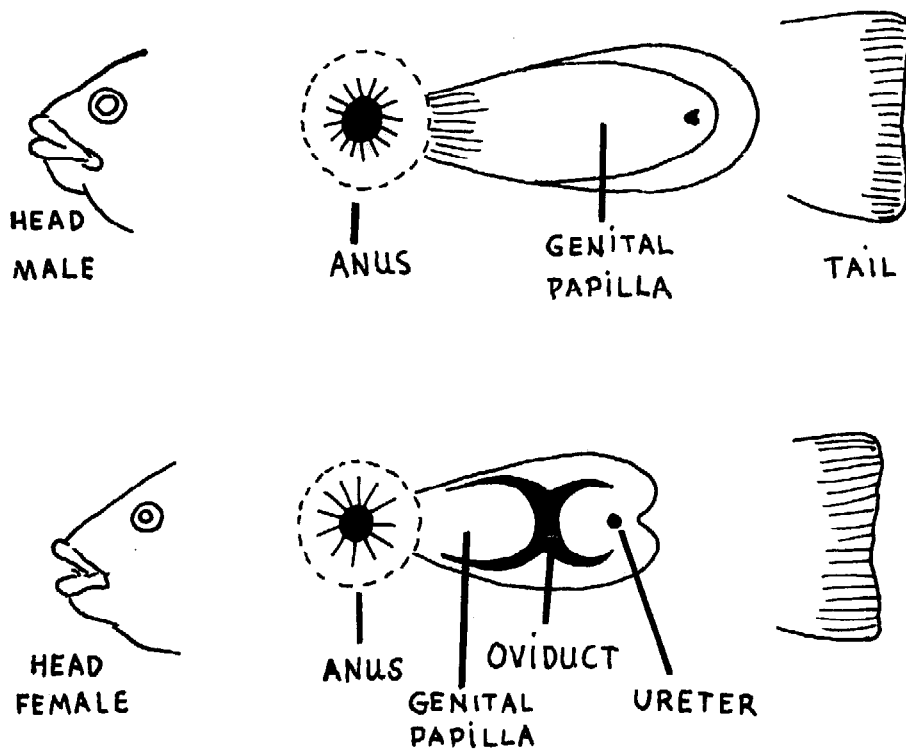

When the farmer goes to buy fish, he must already know what healthy fish look like. It is very important that he be as familiar as possible with each of the fish he decides to raise. He must know the characteristics of that fish and its life cycle, its eating and breeding habits, etc. The farmer who begins any fish pond enterprise without having this kind of information is inviting failure. And if it is a new venture, it is particularly important that the farmer's first effort be as successful as possible.

The Life Cycle of Fish

Fish start life as fertilized eggs. The eggs grow and then hatch into small fish, called fry. The fry are attached to the yolk sac which is the leftover part of the egg they hatched from. The yolk sac provides food for the fry during the first few days after hatching.

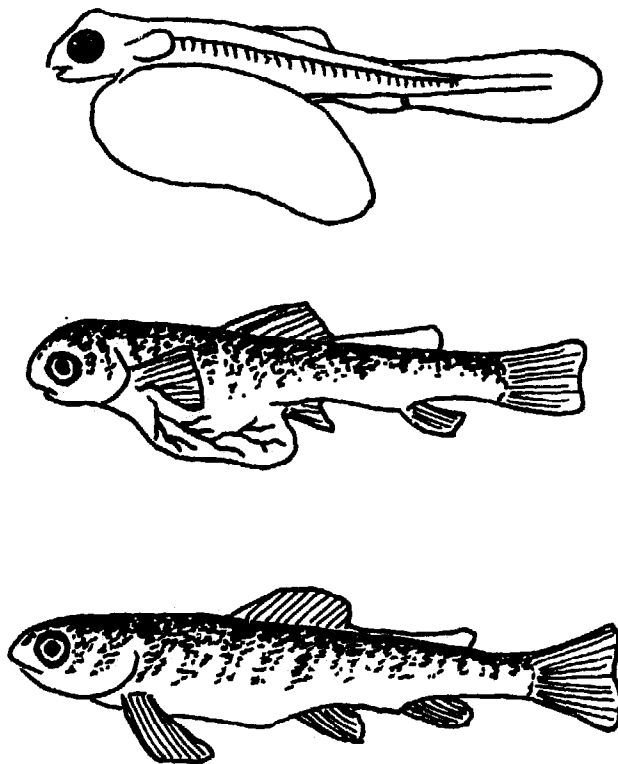

After the yolk sac is gone, the fry searches for food in the water. All fry eat the tiny suspended and swimming plants and animals called plankton in the water. Plankton are hard to see, but if a farmer puts some of his pond water into a glass container and holds it up to the light so that the light shines through the water, he can see the tiny plankton floating in the water. The length of the fry stage depends upon the species of fish. Usually a fish is a fry at least until the yolk sac is absorbed. Fry range from 2mm to 30mm in length. This growth process can take 2 to 6 or 8 days depending upon the type of fish.

As the fry grow bigger, they are called fingerlings. They are called fingerlings because at this stage of the growth cycle, they are about the size of a person's finger. Fingerlings vary in size -- from 4-10cm. Above 10cm, the fish is better called a post-fingerling. The adult fish ranges in size; some can be as large as 2m long and weigh 22kg. An adult fish is a fish which is sexually mature.

Fingerlings have different eating habits from fry; they are now much bigger and can eat larger pieces of food. As fingerlings, the fish begin to show that they like certain foods better than other foods. Each kind of fish chooses its own kind of food, depending upon his needs and what is available. For example, a carp fry will eat plankton; as a fingerling, the carp eats pieces of decayed matter and insect larvae; as an adult the carp will eat plankton, decayed matter, insect larvae, worms, snails, and almost anything that is on the bottom of the pond. Common carp, for example, are called "bottom feeders," because they eat food from the bottom of the pond.

The food preference does not always change as the fish grows. Some fish, like the silver carp, eat plankton their whole lives. When the fish reach adult size, they will sexually mature in the right conditions. Brood fish are sexually mature fish which are chosen as good fish to breed (spawn), produce eggs and begin the whole cycle again. This is called the life cycle of a fish.

Knowing how the fish in the pond grow, and the foods they require at each stage in the life cycle, is very important for good pond management.

*Microscopic
plankton*

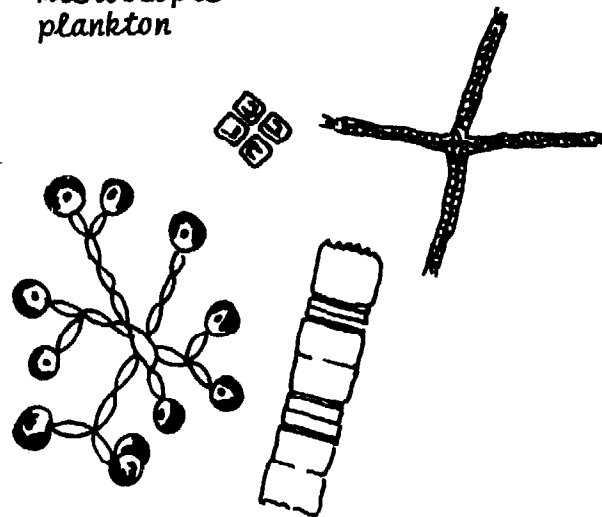

Choosing Pond Fish

Choosing fish to grow in ponds can be difficult. A good pond fish has certain characteristics which help it grow successfully in ponds. There are some fish which will not adapt to pond conditions and cannot be used in pond culture. A pond is very different from a natural waterway:

- . There is usually no water flowing through a pond. Some fish need to live where there is quite a bit of current in the water, rather than in a quiet pool of water.
- . The food that is already in the pond is all that is available to the fish, unless extra food is put in by the farmer.
- . There is only a certain amount of water and pond area in which to move about.

There are many fish that do grow well in ponds. Some of these are fish grown locally; some are fish grown in other parts of the world.

Many governments today are introducing exotic fish species (these are kinds of fish not native to that country) into fish pond programs. They do this for three reasons:

- . Some introduced fish grow better and faster than native fish.
- . Some introduced fish are preferred by people for eating (over local fish).
- . The offspring of a cross between a local fish and an introduced fish sometimes grow faster and taste better than either of the parent fish (this is called *hybrid vigor*).

But exotic fish must be watched and used very carefully. They must not escape into local waters. Some exotic fish which escape create problems in natural waters when they begin to compete with local fishes for food. Also, introduced fish can carry diseases or parasites that are fatal to native fishes.

There are certainly a number of fish in the natural waterways of your area which will grow well in ponds. Native (local) fish are usually easier to use because they are adjusted to local water and climate conditions.

If at all possible, farmers should be encouraged to start their ponds using a tested pond fish which is locally available and is well-liked by people in the area. It can be a fish from the list given here or one chosen from a list prepared in your area. The important points are that the farmer be able to sell any fish he wishes to sell, that the fish can grow in ponds, and that there is brood stock available locally.

Fish Used in Pond Culture

Here are some characteristics that good fish for pond culture will have. Certainly it may not be possible for a farmer to determine whether a certain fish has all these characteristics right away, particularly for those local fish not discussed in detail here or those newly introduced to pond culture. But good pond fish all have certain characteristics: the more certain a farmer can be that the fish he chooses to raise fit these descriptions, the more sure he can be of his success. Good pond fish are:

- . available locally
- . able to reproduce (breed) naturally in your area.
- . able to live in a confined space (the pond).

able to find the right foods in ponds.

fast-growing.

relatively free of parasites and diseases.

known and liked as a food fish in the area.

fish that fit these criteria for good pond fish and are now grown in ponds all over the world are named here. Though they all are grown in ponds, each has certain characteristics which mean that it will grow better in some kinds of ponds better than other ponds. Of course, these are not the only fish that can be used in ponds. But they are named because they have been tested in ponds, and they can grow well under pond conditions. All of these fish are warm water fish.

SCIENTIFIC AND COMMON NAMES OF FISH USED IN POND CULTURE

Please note: Each fish has a scientific name which is always the same. The common name, however, can be different from one country to the next. It is a good idea for anyone who works with fish to know the scientific name.

Genus - species	Common name
<i>Anguilla japonica</i>	eel
<i>Aristichthys nobilis</i>	bighead carp
<i>Barbus gonionotus</i>	tawes
<i>Carassius auratus</i>	goldfish
<i>Carassius carassius</i>	crucian carp
<i>Catla catla</i>	catla
<i>Chanos chanos</i>	milkfish
<i>Cirrhina molitorella</i>	mud carp
<i>Cirrhina mrigala</i>	mrigal
<i>Clarias batrachus</i>	catfish
<i>Clarias macrocephalus</i>	catfish
<i>Ctenopharyngodon idellus</i>	grass carp

NAMES (Continued)

	Genus - species	Common name
13.	<i>Cyprinus carpio</i>	common carp
14.	<i>Helostoma temmincki</i>	kissing gourami
15.	<i>Heterotis niloticus</i>	-
16.	<i>Hypophthalmichthys molitrix</i>	silver carp
17.	<i>Labeo rohita</i>	rohu
18.	<i>Mugil cephalus</i>	mullet
19.	<i>Mylopharyngodon piceus</i>	black carp
20.	<i>Osphronemus goramy</i>	gourami
21.	<i>Serranochromis robustus</i>	-
22.	<i>Tilapia macrochir</i>	tilapia
23.	<i>Tilapia melanopleura</i>	tilapia
24.	<i>Tilapia mossambica</i>	tilapia
25.	<i>Tilapia nilotica</i>	tilapia
26.	<i>Trichogaster pectoralis</i>	snakeskin gourami
27.	<i>Trichogaster trichopterus</i>	three-spot gourami

Following is specific information on some of the more popular pond fish.

COMMON CARP

The common carp, *Cyprinus carpio*, is a favorite warm water pond fish. Common carp are used as a pond fish because they:

- . spawn easily in ponds.
- . do not get sick easily.
- . tolerate wide ranges of temperature and pH (factors of water quality discussed in detail later).
- . eat all kinds of food, from zooplankton to decaying plants.

- . have a very good growth rate.
- . accept supplementary foods.

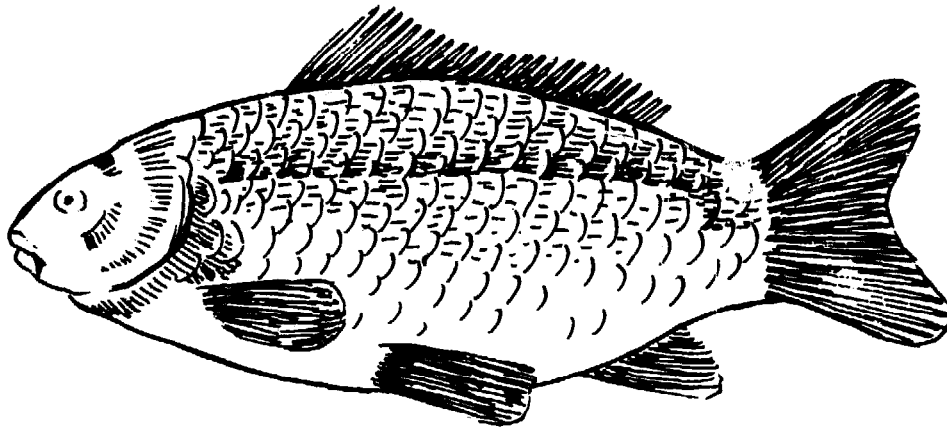

Common carp generally are a grey-green color. However, they also can be gold, yellow, orange, pink, blue, green, or grey. They spawn all year round in warm waters, and they can be made to spawn by the pond owner if they do not spawn naturally. Common carp are good to eat when they are cooked properly. They can be grown in ponds by themselves (monoculture) or in ponds with Chinese or Indian carp (polyculture).

Some of the yields gotten in various countries by stocking common carp in monocultures are shown in the following table.

<u>Country</u>	<u>Culture methods</u>	<u>Yield, kg/hectare</u>
Czechoslovakia	Growth in ponds with ducks	500
Guatemala	Intensive culture in ponds	4,000
India	Natural growth in ponds	400
	Growth in ponds with management	1,500
Indonesia	Intensive culture in ponds	1,500
Japan	Intensive culture in ponds	5,000
Nigeria	Commercial culture with fertilization and feeding	371-1,834
Philippines	Intensive culture in stagnant water	5,500
United States	Intensive pond culture with i inorganic fertilization	314

Source: Bardach, et al (1972)

Conclusion: Common carp are a very easy fish to breed, keep, and harvest, so a fish pond that relies on common carp will probably do well. Common carp are a good fish for a farmer to use for his first effort. With good management, common carp will continue to produce healthy eggs and fry until they are too old (above 5 years of age).

TILAPIA

The *Tilapia* genus (family Cichlidae) contains at least 14 species, which are all good pond fish. The color of the fish differs only slightly depending upon species; tilapia are generally dark brown to black in color. The most common species grown in ponds is the *Tilapia mossambica*, also called the Java tilapia. It has been introduced throughout the world and is easy to find in most places. Tilapia:

- . are hardy fish, resistant to disease.
- . breed easily in ponds.
- . grow rapidly.
- . taste good.
- . can withstand wide temperature ranges.

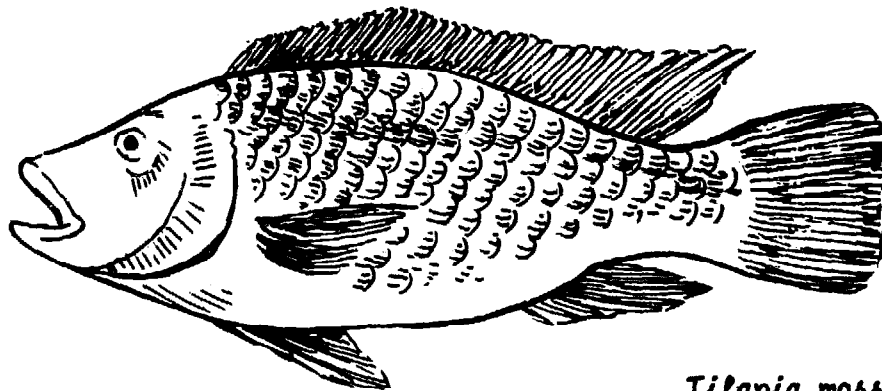

Tilapia mossambica

Tilapia are herbivorous: some species eat higher plants; some eat phytoplankton. Both the Java tilapia and the Nile tilapia (*Tilapia nilotica*) do well in very enriched waters (waters polluted by sewage). All tilapia have slightly different eating habits, depending on the species.

Tilapia reproduce every month or so, once they become sexually mature. They then take very good care of their own eggs and fry in ponds. If the farmer plans to breed and raise fry, this fish is a good choice because the fish themselves take care of the fry at a stage where many fish of other species die easily. The major problem with raising tilapia in fish ponds is that they become sexually mature at a small size, and

begin to reproduce instead of to grow further. It may be necessary to separate the tilapia by sex before they are old enough to reproduce. Or it may be necessary to introduce catfish into the pond to control the population of small fish.

Conclusion: Tilapia species have many possibilities for pond culture. Their fast growth rate, ease of breeding, good taste and hardy bodies make them a good choice, particularly for the first-time fish farmer.

CHINESE CARPS

Other kinds of carp, besides the common carp, often are grown in ponds. Most commonly used are the Chinese carps. Some of these are:

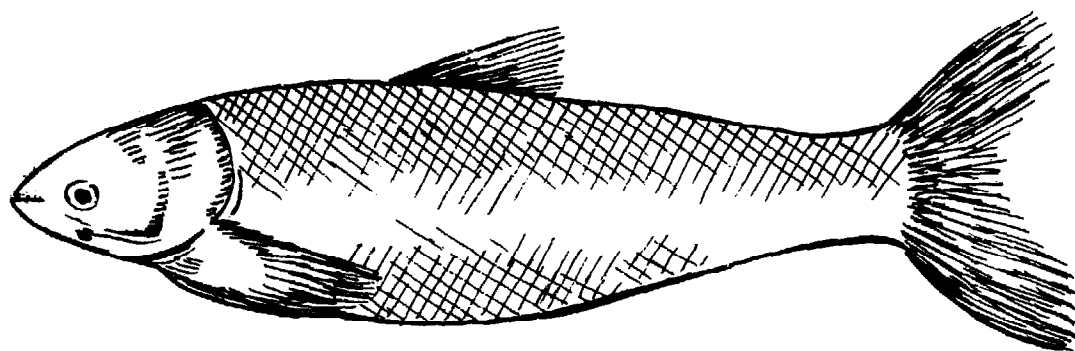

- Silver carp (*Hypophthalmichthys molitrix*). This fish eats phytoplankton, but will accept rice bran and bread crumbs. The silver carp gets its name from its silver color. It has very small scales.

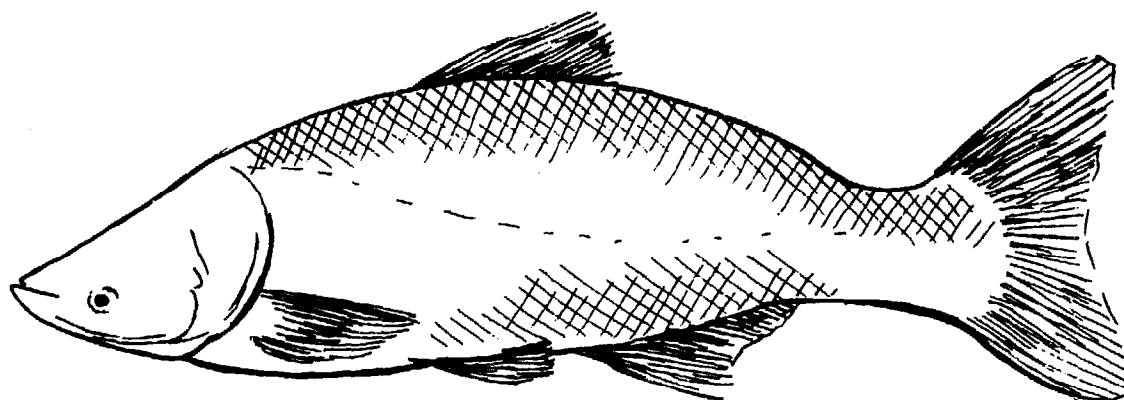

- Bighead carp (*Aristichthys nobilis*). This fish feeds mainly on zooplankton. It is a dusty green color on top, which fades to a pale green color on the abdomen. It also has small scales.

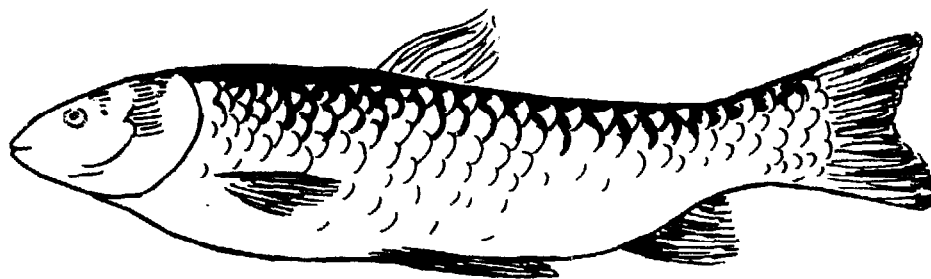

- Grass carp (*Ctenopharyngodon idellus*). This fish is an herbivore and eats water vegetation (but also will eat almost anything). The grass carp is also silver-colored, but has a darker grey area running along the top of the body. It grows larger in size and has larger scales than a silver carp

Other chinese carps like the black carp (*Mylopharyngodon piceus*) and the mud carp (*Cirrhina molitorella*) are bottom feeders. This difference in eating habits is very important in fish pond culture. It is the reason why polyculture, or growing a number of fish species in one pond can be successful. When one kind of fish is stocked alone in a monoculture, the foods in the water not eaten by that type of fish are wasted. In a polyculture of the above three species of Chinese carp, for example, three kinds of food are being eaten.

The following table gives some examples of polyculture mixes and of how many fish of each kind can be stocked in a pond. For example, Pond I is stocked with silver, bighead, grass and common carp.

STOCKING RATES OF CHINESE CARPS IN PONDS
3 TO 7 METERS DEEP IN KIANGSU PROVINCE, CHINA

<u>Species</u>	<u>Weight of Yearlings, grams</u>	<u>Number of Yearlings per hectare</u>			
		I	II	III	IV
Silver and bighead carp	500	4,500	4,500	9,000	9,000
Grass carp	500	600	-	3,000	-
Black carp	500	-	450	-	3,000
Common carp	200	<u>200</u>	<u>200</u>	<u>200</u>	<u>200</u>
TOTAL:		5,300	5,150	12,200	12,200

Source: Bardach, et al (1972)

The preceding table shows polyculture mixes: as you can see, common carp can also be used in polyculture with Chinese carp. Chinese carp are grown in ponds because they grow well in polycultures, and they are very good to eat. The silver carp grows faster and is tastier (according to some farmers) than common carp. The grass carp is most often used to control weeds in the pond. In fact the grass carp does a better job of weed control than do chemicals. The grass carp is perhaps the most interesting of the Chinese carp and is now being studied by scientists in many countries to find better ways of breeding it in ponds.

A farmer might run into problems raising Chinese carp -- if he does not look into his local situation very well. Farmers will have to have a source of Chinese carp fry from a government hatchery or a local breeder before trying to raise Chinese carp. The carp only breed once a year, and then, in most cases, only with help from man. Also, Chinese carp are very susceptible to diseases. Then, because they are delicate fish, they must be handled very carefully, or they will be injured.

Conclusion: A farmer just beginning a fish pond probably would not want to breed Chinese carp, but he certainly should be familiar with these fish and how they might help his ponds. For example, even two or three large grass carps placed in a pond with many fish of one other species could be valuable for keeping a pond balanced.

INDIAN CARP

There is one last group of carp often cultured in ponds. These are the Indian carp. Indian carp are further divided into minor and major carp. The major carp of India are the catla (*Catla catla*), the rohu (*Labeo rohita*),

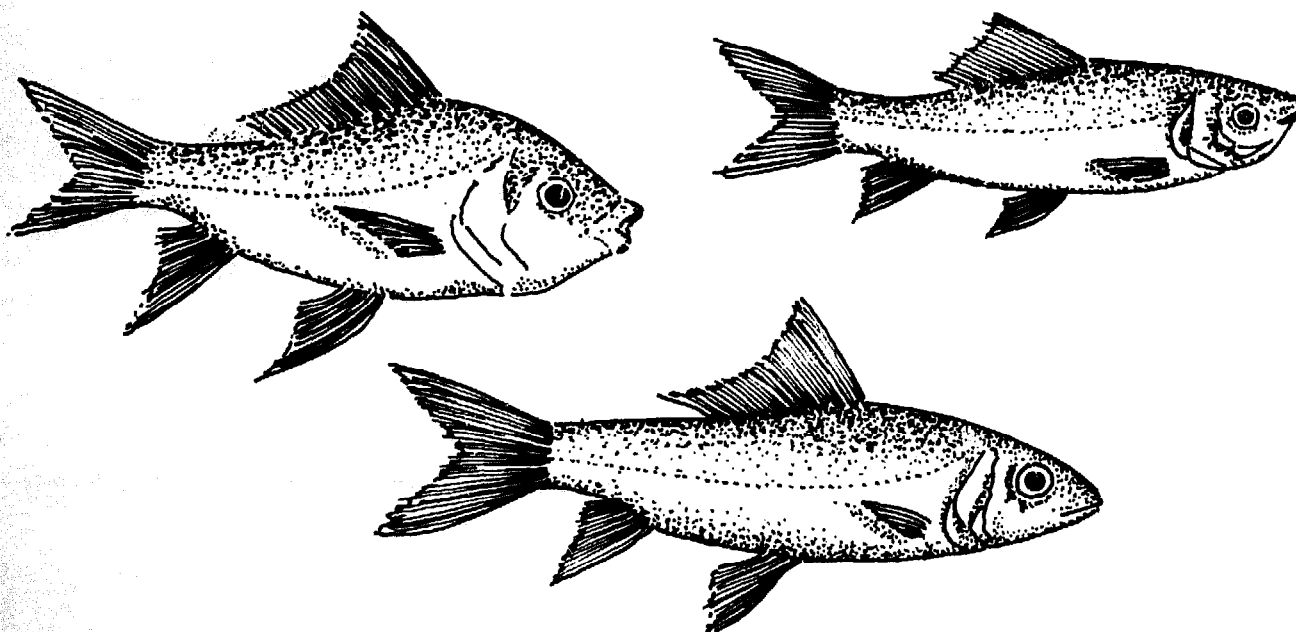

and the mrigal (*Cirrhina mrigala*). The minor carp are the reba, the bata, the sandkohī, and the nagendram fish. The Indian major carp will not spawn in standing water, so special ponds are built in India to provide a flow of water for these fish, who must have running water in which to spawn. The Indian carp can be made to spawn by man, but this is a difficult process (see "Managing Brood Stock"). However, there seems to be no reason why the Indian carp cannot be spawned in ponds in places where ponds can be constructed to provide constantly running water.

Conclusion: A farmer who has only a small pond should not try to breed Indian carp. Indian carp can be grown in polycultures with common carp, but are not as good or fast growing in ponds as the Chinese carp. Indian carp are also susceptible to many diseases. This is a fish for an experienced fish farmer who is interested in, and able to, experiment.

GOURAMI

The gourami (*Osphronemus goramy*) is a very good pond fish. It is originally from Indonesia, but now is grown all over Southeast Asia. Gourami possess an accessory air-breathing organ, which means that they can survive in waters that are low in dissolved oxygen. This makes it an important fish in areas where the temperature remains high and there is little water for certain periods of the year. Gourami spawn all year round in warm water conditions. Gourami:

- . spawn easily all year round in warm waters.
- . taste good.
- . are easy to breed.
- . accept a variety of foods.
- . are hardy.

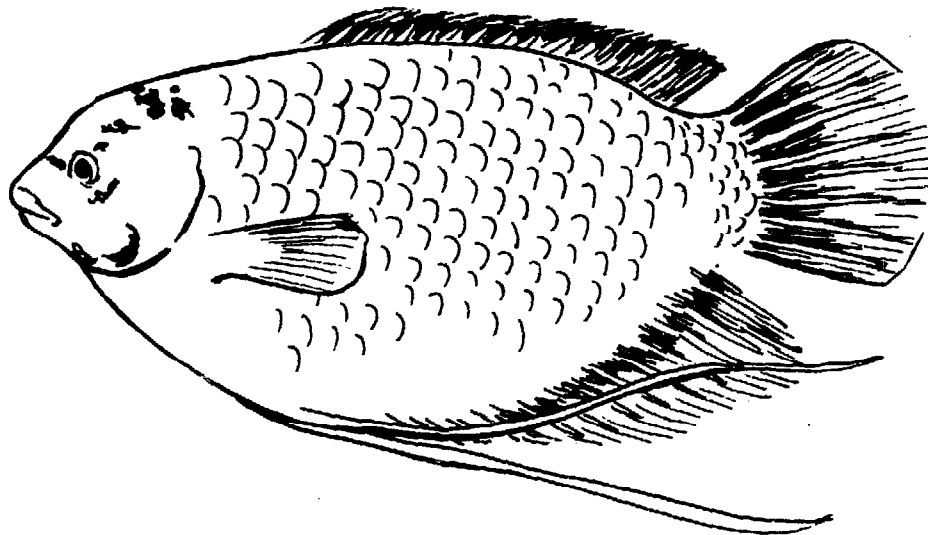

Conclusion: Gourami are good fish for a first-time fish farmer. And they are certainly a fish to be considered very thoughtfully by farmers who live in areas that remain very hot and dry for periods of the year. The gourami is used to these conditions, and there are other pond fish which would not do well at all under these conditions.

CLARIAS CATFISH

Clarias catfish are found throughout Asia, India, and Africa, as well as the Middle East. The species most often used as pond fish are *Clarias macrocephalus* and *Clarias batrachus*. *Clarias macrocephalus* is preferred for its good taste; *Clarias batrachus* grows faster.

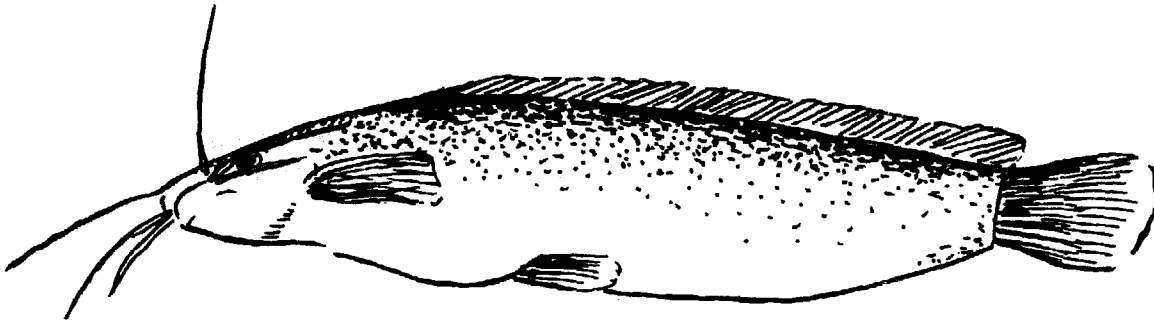

These catfish have accessory air-breathing organs; they can even crawl out of ponds to look for food. Because they can live in shallow ponds, these catfish are sometimes used in culture with rice (see paddy culture). They are scavengers, which means they will eat just about anything. However, they prefer to eat worms, snails, and other fish. They are often used in polycultures with tilapia where they serve as predators on the very small tilapia. They will eat supplementary foods, and give very high production in ponds. In Thailand, *Clarias* catfish yield about 97,000kg/ha when they are fed supplementary foods. These catfish are hardy: they sometimes get external parasites, but these do not kill the fish.

Conclusion: The catfish are another good fish to be raised in areas where high heat and long dry spells are found. They are good to eat, easy to keep, and can be used in ponds in a number of ways. Certainly a farmer who already cultures paddy rice might be interested in considering adapting his paddy to catfish culture.

TAWES

The common name tawes is applied to three species of fish -- *Barbus gonionotus*, *Puntius javanicus*, and *Puntius gonionotus*. These fish usually are used in fish ponds for vegetation control, in polycultures with Chinese carp. Tawes are able to spawn all year round, but they most often spawn in the rainy season. Tawes need well-oxygenated water

with a strong current to spawn. Tawes feed on soft water plants, but will also take rice bran. There is not a great deal known about the tawes at present, but it can be used in polycultures when the grass carp is not available.

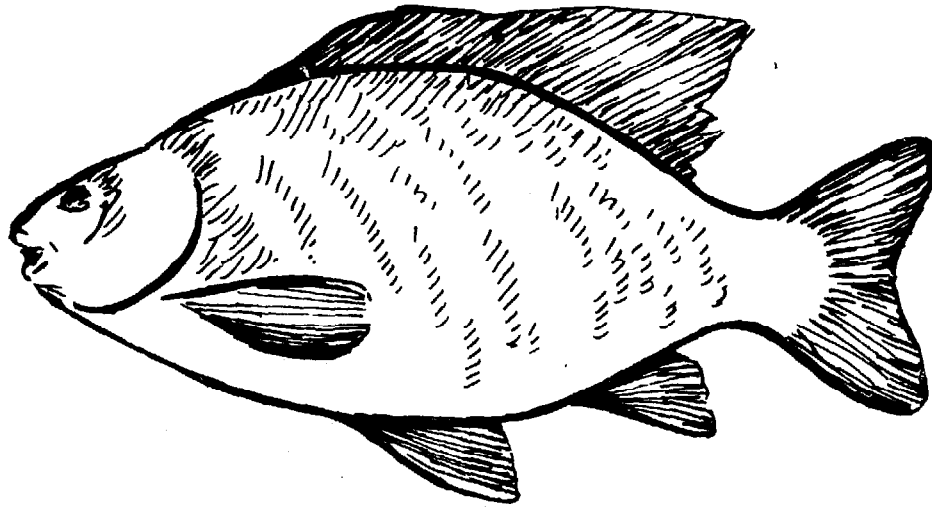

Conclusion: A farmer starting a polyculture certainly might be interested in using this fish. However, first-time fish farmers with limited space would not want to try breeding this fish.

HETEROTIS NILOTICUS

The *Heterotis niloticus* spawn easily in ponds. The mature fish will build a grass-walled nest in the weeds at a pond's edge and spawn inside this nest. They spawn when water is low and very warm, at the end of the dry season. The mature fish feed only on plankton, but in a pond they will accept supplementary food. This fish has a swim bladder which can serve as an accessory air breathing organ.

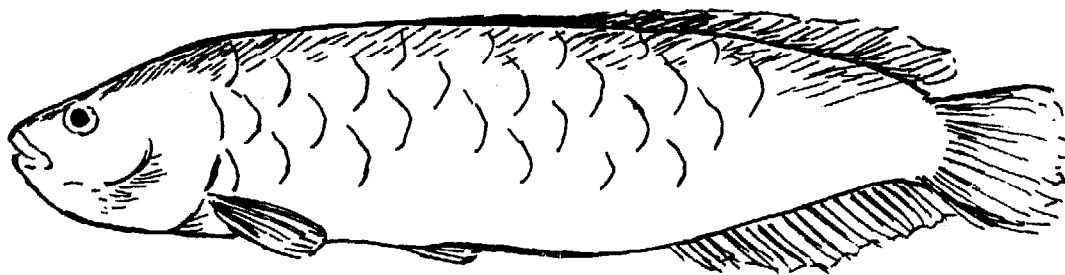

Conclusion: There is not yet a great deal known about the *Heterotis niloticus* as a pond fish. But it seems that it is a good choice of fish for warm climates and warm waters. A farmer who lives in such a climate might find raising, and even breeding, this fish quite easy -- particularly in a very well-fertilized pond.

OTHER GOURAMIS

These are the snakeskin gourami (or Sepat Siam -- *Trichogaster pectoralis*), the three-spot gourami (*Trichogaster trichopterus*), and the kissing gourami (*Helostoma temmincki*). All of these fish taste good. And they breed easily in well-oxygenated, warm water. They do require a pond which has a good growth of vegetation (particularly *Hydrilla verticillata*).

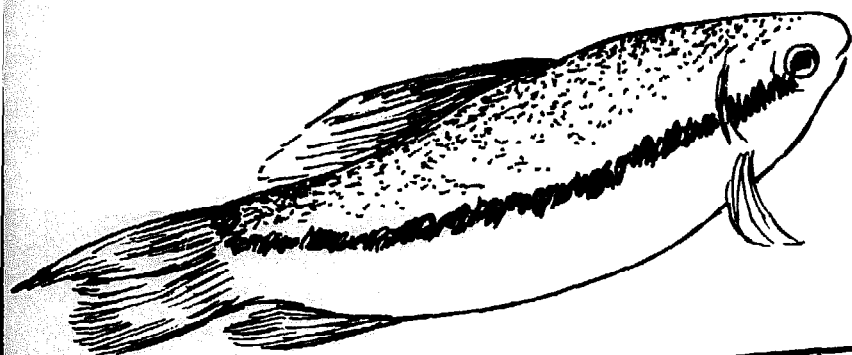

Snakeskin gourami

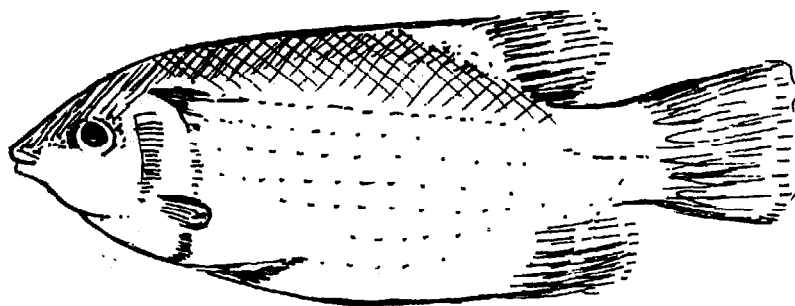

Kissing gourami

Conclusion: In a pond situation such as that outlined above, these gouramis are easy to breed and raise. They are a good fish to use in polycultures with other gouramis, tilapia, and common carp.

MILKFISH CULTURE

The milkfish (*Chanos chanos*) can be raised in freshwater even though it is primarily a brackishwater fish, and will not breed in ponds. The fry are caught along the shoreline at breeding season (the rainy season) and transferred to freshwater ponds. Milkfish culture is done for the most part in the Philippines and in some other Southeast Asian countries, like Indonesia and Taiwan.

Adjusting (acclimatizing) the fry from the saltwater to the freshwater pond is hard to do; many fish die if the adjusting process is not done well. Therefore, milkfish usually are cultured in brackishwater ponds only; the use of milkfish in freshwater ponds is not widespread. Milkfish feed on a complex of bottom algae, and, recently, it is reported they also feed on phytoplankton. Milkfish are prized for their beauty and their good taste, though they have many, many small bones.

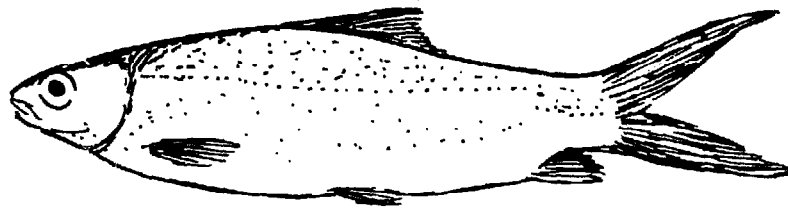

Conclusion: This is not a fish for the first-time fish farmer. In fact, it is not a good choice for any farmer unless he has a saltwater pond; is interested in trying to acclimatize the fish to a freshwater pond; or can buy milkfish from a source that has them already in a freshwater pond.

EEL CULTURE

Eels (*Anguilla* sp.) have been cultured in Japan and Taiwan for years. Eels are very much a luxury food and are not normally grown alone in ponds outside of these two countries. The eels are grown in ponds in polyculture with other fishes and are particularly useful in polyculture with species of tilapia because they eat the smaller tilapias. The eels used in Taiwan (*Anguilla japonica*) spawn in the sea and the fry (called elvers) swim upstream and are collected by dealers. Eels must be fed supplementary feeds like pellets made of trash fish.

Conclusion: It is not recommended that farmers work with eels because they must be fed protein and are not very efficient converters of food. Also, eels cannot be bred in fish ponds.

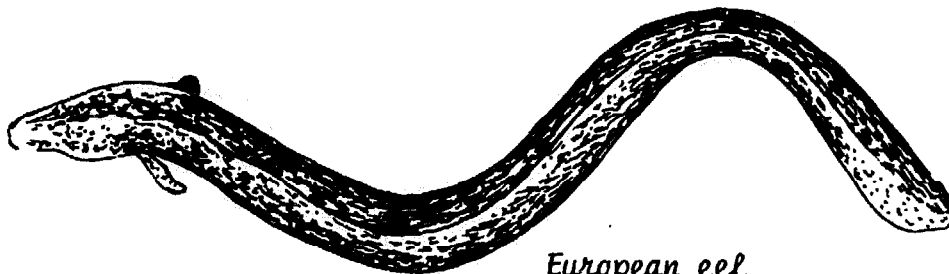

European eel

OTHER POND FISH

Some other fish grown in ponds are the goldfish (*Carassius auratus*), the crucian carp (*Carassius carassius*), and *Serranochromis robustus*. Any of these fish can be grown in polycultures with Chinese, common carp, and tilapia.

Conclusion: The use of one of these fish in a pond stocked with other, more important fishes, results in an increase in yields of both species. In polycultures these species can utilize other food sources and also act as predators and weed controllers.

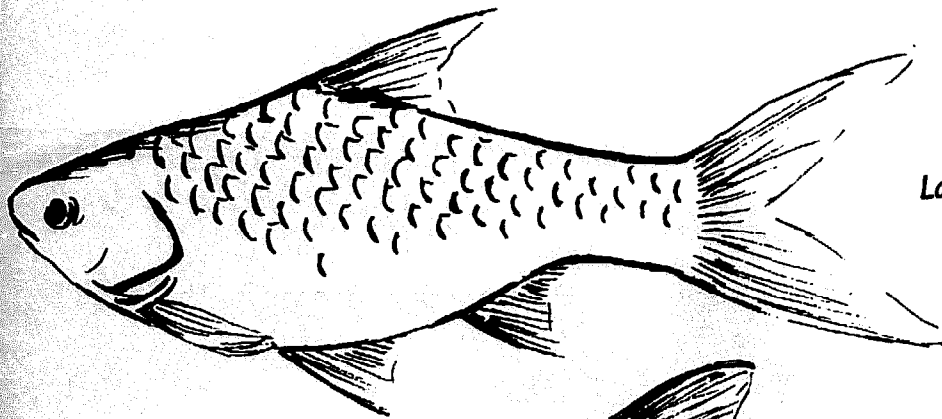
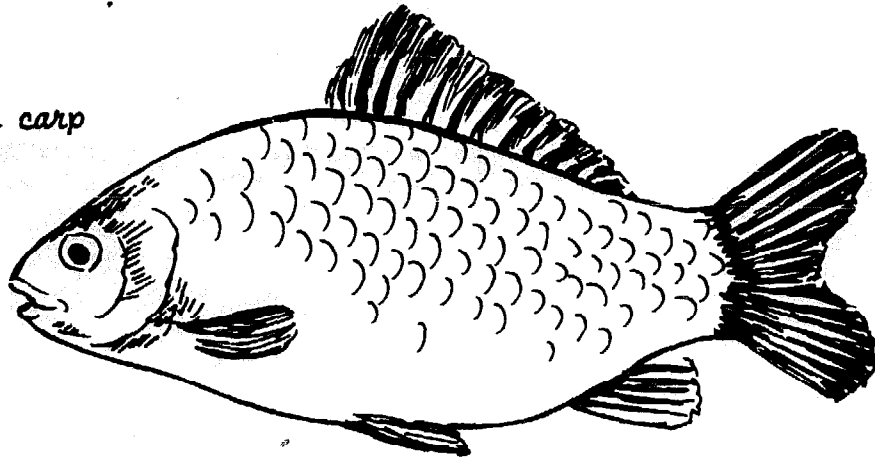
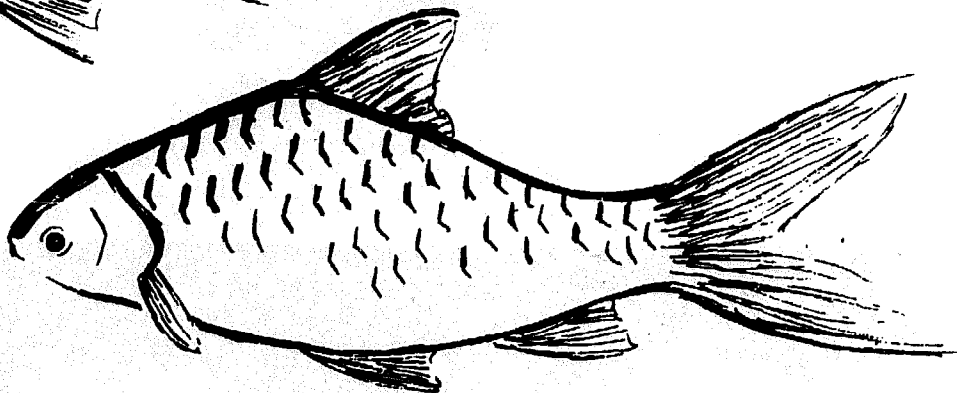
Crucian carp*Lampan siam**Lampan java*

One other fish species used in freshwater ponds is the striped mullet (*Mugil cephalus*). Like the milkfish, the mullet is primarily a salt-water fish, and its fry are collected as they swim upstream. Recently the mullet has been made to spawn by man, but this is difficult to do because mullet are very sensitive to handling. However, mullet can survive in wide temperature ranges and are herbivores, so some farmers may want to try mullet.

A CLOSING NOTE ON FISH

All these fish have been and are now being cultured in fish ponds around the world. However, as stated before, they are not the only fish which can be grown in ponds. In every area there are a number of fish in natural waters that could be grown in fish ponds. So you might find it

a good idea to experiment with local fish in your ponds, to find those fishes that might be available to farmers in your area for use in their ponds. It is better for an extension worker to do the experimenting than it is to have a farmer risk wasting his time or money, or even more importantly, risk failure. If a farmer fails, he may not want to try again.

4

Fish Pond Construction

Construction of a large pond can be very expensive if labor is hired, machines are used, and expensive equipment is rented. For example, in the Philippines, a one-hectare pond having two concrete gates and walls 3m high x 3m wide recently cost US\$1,522.56. Another pond, about 100m x 25m, with only a Rivaldi valve cost about US\$680.

An interesting fact about fish pond construction is that whether the pond is large or small, expensive or inexpensive, ponds are all very much the same. A larger, more expensive pond will not necessarily be a better pond.

Here is an example of a good beginning for a new and small fish farmer:

A "backyard" fish pond was planned and sited very carefully by a farmer. The pond was dug by the farmer and constructed with bamboo pipes for water inlets and outlets. The construction itself cost no money. The farmer's only expense was a supply of fingerlings purchased from a nearby market. This fish pond, managed by the farmer and his family, produced enough fish for the family and some extra income from fish sold or bartered for goods needed by the farmer. The family ate well and suffered no major illnesses during the year.

Next year, the farmer plans to add another pond and to produce more fish for market. He will add a Rivaldi valve or a wooden monk to this new pond, because either of these will make on-going management somewhat easier, now that there will be two ponds to manage (the bamboo pipe sometimes got clogged. This was no problem to correct when there was only one pond. But it would take up needed time in a two-pond operation). Whichever the farmer chooses, the valve or the monk, he will make it himself with materials found locally, using money from the sale of his fish:

This farmer began his operation well. He started small and worked into a larger operation. However, even for the larger fish farm, he planned an expansion which was within his means. This kind of careful planning increases the farmer's chances of success -- and yours. And the scope of the project is something he can undertake on his own. He gained the knowledge and experience that he needs to expand his operation.

The following section presents a range of ideas for constructing fish ponds. The farmer can pick a combination of construction possibilities which best fit his own needs and resources.

IMPORTANT: Stress that the "right" way in any situation is the way which:

- . the owner can afford
- . the owner can manage easily
- . fits the owner's needs most completely

Construction should begin only after careful planning such as that outlined in the preceding sections on "Planning."

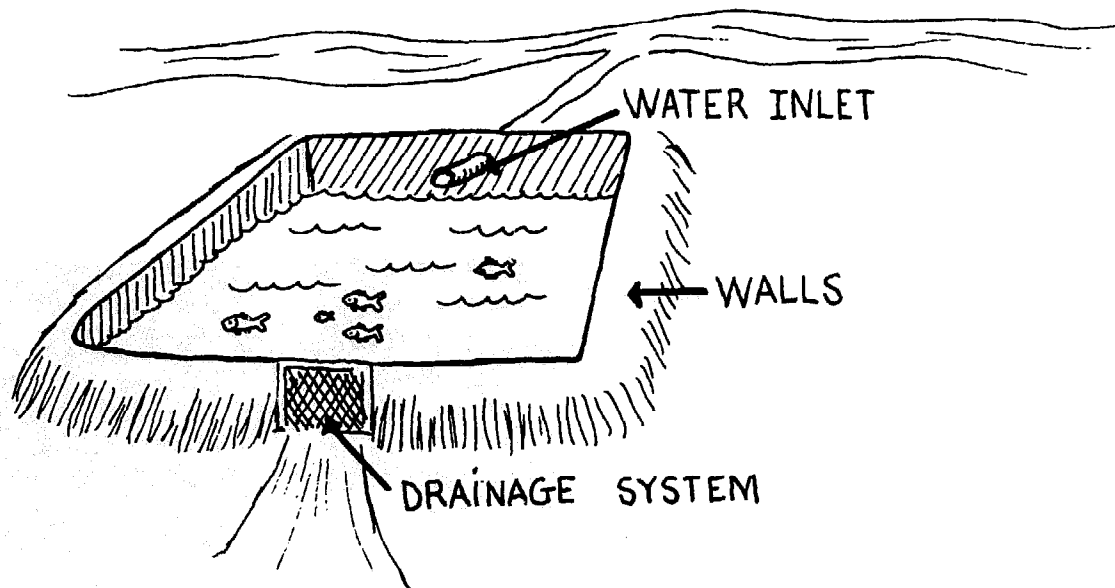

A fish pond has three main parts: the walls, the water inlet, and the drainage system. Walls are also called dams, dikes, levees, or bunds. This manual uses "walls." Whatever they are called, walls hold the water in the pond. They can be built using soil taken from inside the pond, or they can be built with soil taken from another place. They must be strong enough to withstand the pressure of all the water inside the pond: water constantly pushes against the walls. They must also be water tight (impermeable), so the pond does not leak.

The water inlet, located above the pond water level, is used to let water into the pond and is closed off after the pond is filled.

The drainage system is used to empty the water from the pond when the farmer is ready to harvest the fish.

There are many ways of making inlet and drainage systems: the most important criterion is that they work. But the walls are especially important: they are all that keep the fish inside the pond. The walls must be built carefully.

Pond construction follows the same principles whether the pond is a single backyard pond or part of a large fish hatchery. These are the steps in pond construction:

- . Survey the land
- . Mark out the area of the pond
- . Measure and mark out the walls
- . Excavate the pond bottom, if necessary
- . Build the drainage system
- . Build the water inlet
- . Build the walls
- . Seal the pond bottom

Each of these steps will be discussed in detail in the following pages.

Survey the Land

The first step in the construction of a fish pond is marking the area of the proposed pond. If the site chosen is a natural slope, the first thing to be done is to find out where the main wall will be built. The main wall should be marked off at the lower end of the pond, where the pond will be the deepest and the slope the greatest. This is where the pond's drainage system will be put. If the pond is to be on a flat area, the pond bottom itself must be made with a slope so the pond will drain. This is done by digging one end deeper than the other end. Remember: the main wall is always at the deeper end.

DETERMINING THE SLOPE

Even flat ground usually has some kind of slope, although it may be very little and hard to see. So, before constructing the pond, the land is surveyed to find out which way the land slopes and what that slope is.

There are a number of ways which can be used to determine slope. The way outlined here probably would not be used by many farmers if they were building a pond on their own, but this is an accurate method of determining slope and should be encouraged if at all possible.

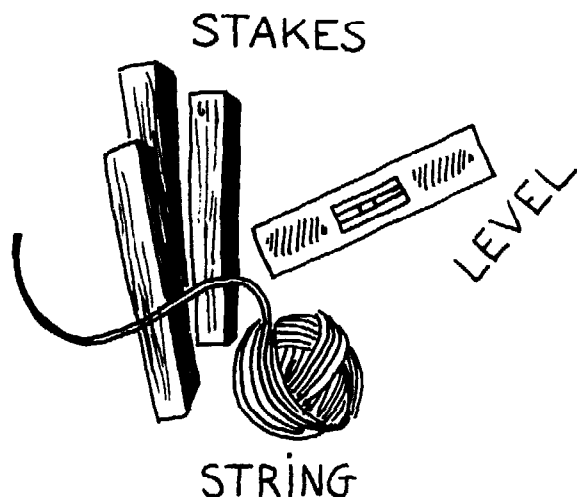

To survey the land for slope, some stakes (long, straight pieces of wood), some string (fishline, etc.), and a carpenter's level are needed.

Most farmers will not be familiar with the level, a device that has an air bubble trapped inside which rests between two drawn lines. When the level is placed on the ground, it shows whether the area is flat or sloped: if it is straight or flat (level), the bubble stays in the middle between the lines; if the land slopes, the bubble will move to the right or left of the lines, depending upon the direction of the slope.

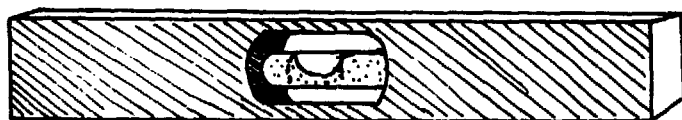

Carpenter's level

Farmers who cannot find a carpenter's level can make a level by getting a small lightweight container. They should then place the container on a known horizontal surface, add water, and draw a line around the inside of the container at the water level. Then, if this container is placed on a slope, the water will shift away from the line to show the slope.

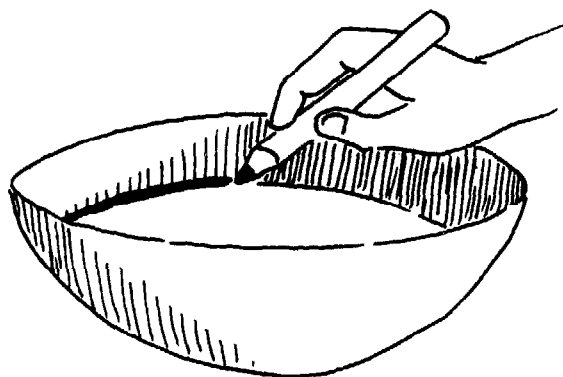

When all the equipment is gathered, measure the slope.

- . Look at the land and decide which part is higher.
- . Drive a stake or a piece of wood or bamboo into the ground at the highest point.
- . Walk away downhill from the stake about 100cm. Drive another stake into the ground at this point.

- Tie string or fishline or vine (whatever is being used) between the two stakes. Attach the level to the string. Then move the string up and down on the stakes until the bubble is between the lines on the level, or the water level is even with the line marked on the container. This will mean the string is level between the stakes, even though the stakes are in the ground at different heights.
- Measure the height of each string by measuring from ground level to the place where the string is tied.

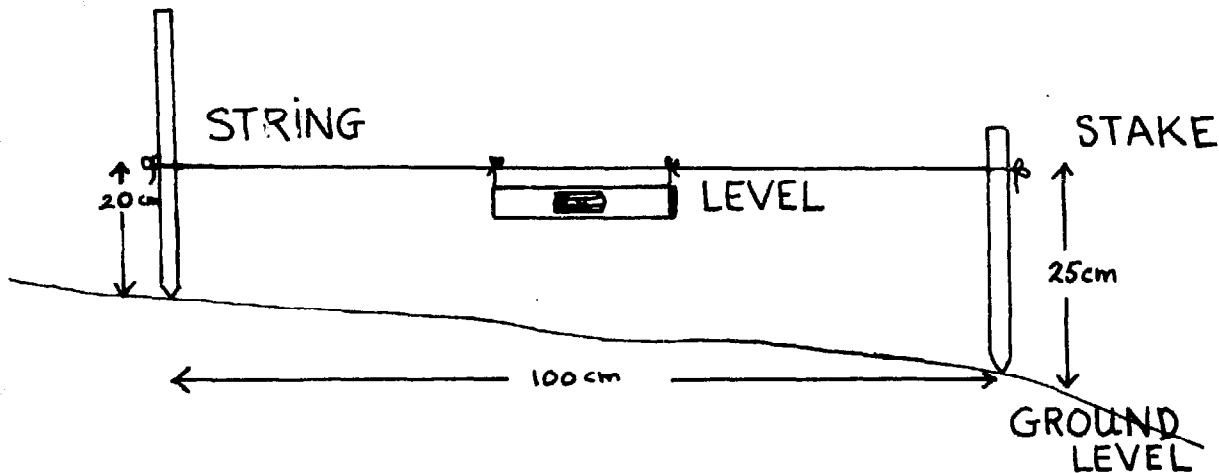

This drawing shows that one string is tied at 20cm; the other is tied at 25cm. Therefore, one end of the area is 5cm lower than the other. The distance covered by the string is 100cm, so the slope is 5% (over 100cm of ground, the elevation changed 5cm). Since a slope of 2-5% is good for a fish pond, this site has a satisfactory slope for a pond.

Other Ways of Determining Slope. As mentioned earlier, the above method of measuring slope is a good one, but it may be difficult for some people to do. It is possible to calculate slope roughly. A farmer, who realizes that what he is looking for is a way to place his pond so that the water can enter from the water source and drain away well, can figure the slope of his land by doing such things as rolling a ball or other round object and watching carefully to note where and how quickly the ball rolls. A good slope would mean a slow-rolling ball. A variation of this involves throwing a quantity of water, or a mixture of water and dye, on the ground and watching the path it takes and its speed as it moves along the ground.

It is important to consider slope carefully. A well-placed pond with good drainage is easier to care for and has more chance to be successful. It may be necessary for the pond owner to measure his land only once to find a good location. Or it may be necessary to repeat the measuring a number of times. This is probably a good thing to encourage since locations which look alike to the eye often have enough difference in slope to make a big difference to a fish pond. Also, determining slope

is a larger project if more than one pond is being built. Then the ponds must be laid out in relation to each other.

There may be several areas which have the correct slope, but only one which is good in terms of getting the water into the pond from the water source and out of the pond easily. For example, the farmer might like to drain his pond so that the water irrigates his fields. Therefore, he will want to keep this in mind when he decides upon the exact placement of his pond. Likewise, if he is building a pond on a hillside in back of his house, the slope may be perfect, but he will need to avoid drainage into his buildings.

Once the slope is found, the location of the main wall can be determined. Of course, if the pond is built on flat ground, it will have four walls. If the pond is a barrage pond, it may only have one wall. The number of walls depends upon the land. The shape of the land may mean that one wall or two walls or four walls will be needed.

Mark out the Pond Site; Measure the Walls

Now that the slope is known, the place of the main wall is known. The main wall is at the end of the pond which will be deepest, and is the wall where the drainage system will go.

Mark out the main wall, and any other walls that will be built, with stakes. The walls, when finished, will be wide: it does not matter so much where the stakes are placed within the width of the planned walls, for they are to be used as height markers.

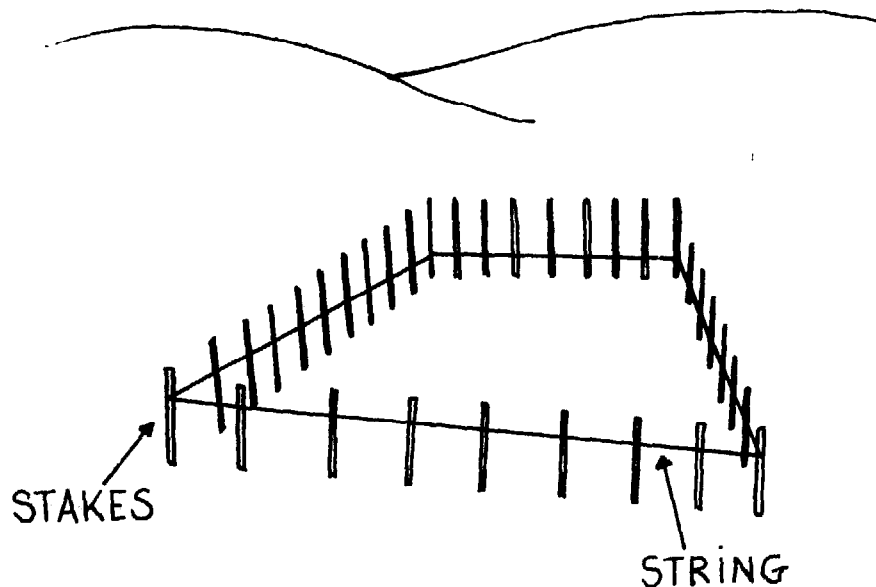

The farmer has to plan the depth of his pond and the height of his wall. If the pond is going to be 2m deep at the deepest end, for example, the walls should always be at least 30cm higher than the water level for a small pond, and at least 50cm higher for a large pond. Also, the walls will settle after they are finished, so it is best to make the wall 10% higher than the desired final height of the wall. A 2m deep pond, therefore, would have walls with a total height at the deepest point of 2.5 or 2.6m [height of wall before it settles = depth of pond + 30cm (for small pond) or 50cm (for large pond) + 10% of depth and 30 or 50cm].

Tie strings to the stakes along the main wall line, at a height of 2.5 or 2.6m for a pond whose deepest end will be 2m. Use a levelling device to connect strings to the stakes marking the other walls, if the pond has other walls, at the same level as the string marking the height of the main wall. The strings are the building markers. When the walls reach the strings, they are the right height.

Dig the Pond Bottom

As stated before, the pond bottom must slope downward from the shallow end to the deep end to help drainage. The pond bottom usually has a slope of from 2 to 5%. (A slope of 2% would mean that for every 100cm change in length there is a 2cm change in height.)

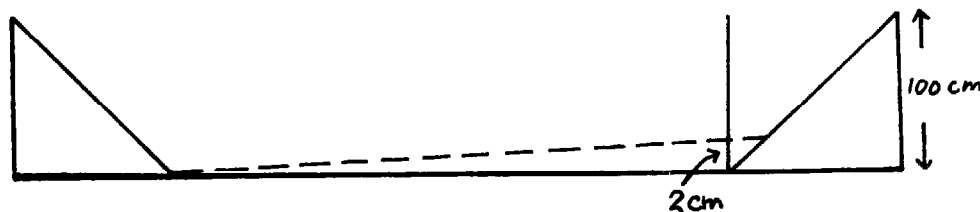

The pond bottom must be clear of rocks, roots, trees, and stumps so that later, when a net is used to harvest the fish, the net will not get caught and tear. If the pond bottom is already smooth and slopes well, it can be left alone. Or, if the pond bottom only has grass on it, the grass does not need to be removed before the pond is filled. In fact, once water is added to the pond, the grass will die and rot and add nutrients to the water.

If the pond bottom does not already slope downward, excavate (dig out) the bottom area of the pond until a good slope for drainage is made.

Adjust the height of the strings tied to the wall markers if digging the bottom has changed the height.

Keep the soil which was dug out of the pond: when the pond walls are finished, the soil can be placed on top and planted with grass. This fertile topsoil will root grass easily; this grass will help keep the walls from eroding (washing away).

The pond bottom can be excavated by hand or by using machines, like bulldozers, if they are available. Remember: if the land for the pond is chosen well with regard to the natural topography, only a small part of the pond bottom will need to be dug out. The most important thing is to have the pond bottom slope so that the pond can be drained.

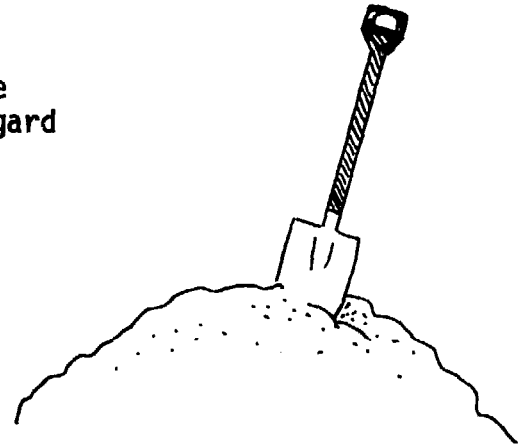

Build a Drainage System

A drainage system is anything that is used to empty the pond. It consists of the outlet system for letting water out of the pond and the drainage ditches which carry the water from the pond away.

As stated before, the best and easiest way to have a good drainage system is to build the pond in a place which provides a good slope -- on a hill, for example. This is the first step. Then, there are many different drainage systems which can be put into the pond. Some of these drainage methods are expensive; others are very inexpensive.

The drainage system must be built before the pond walls because some drainage devices go through the walls. (In some countries the drainage is done by knocking a hole in the wall of the pond. When the pond is dry and empty, the hole is patched up.)

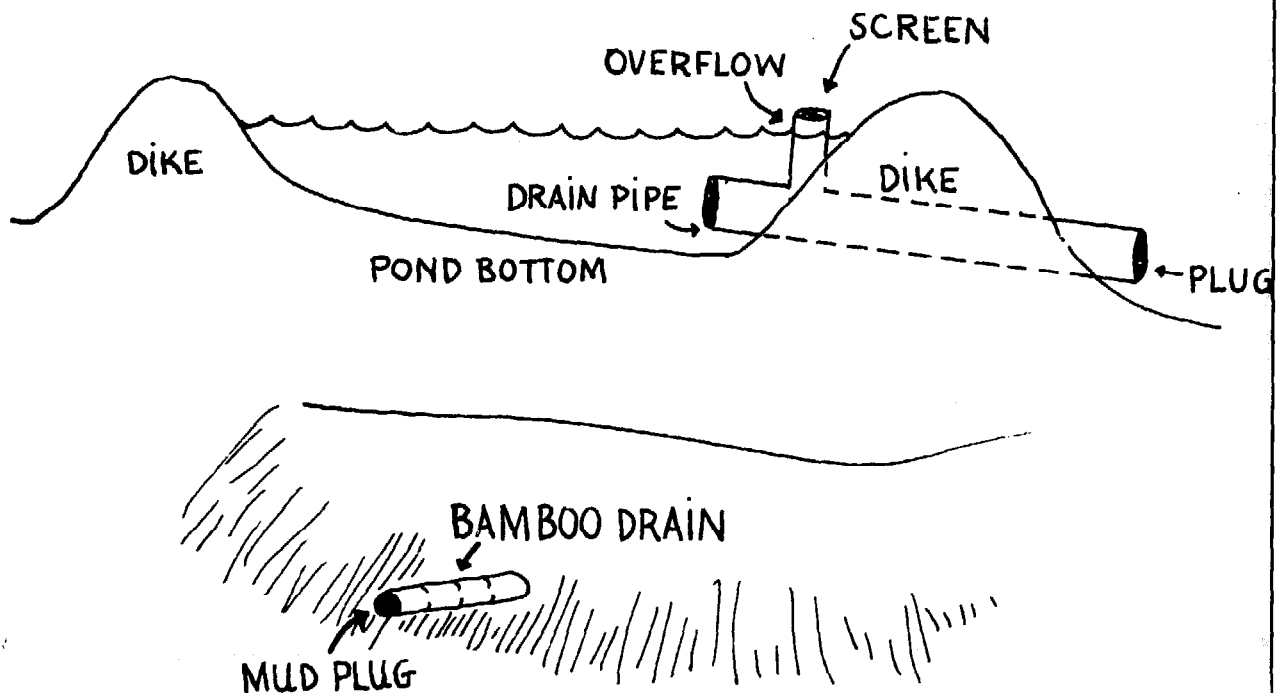

One of the easiest ways to drain the pond is to place a bamboo or plastic pipe through the base of the wall into the middle of the pond. The end of the pipe which is inside the pond has a screen over it to keep fish from entering the pipe. The other end of the pipe, the end that is outside the pond, is plugged with wood or clay. To drain the pond at harvest time, the plug is pulled out.

Two other methods of draining the pond which work but are not used as often, are the siphon and the pump. A siphon is merely a flexible plastic or rubber tube. One end of the tube is in the pond near the bottom; the other end is placed on the ground outside the pond. A vacuum is produced in the pipe by sucking at the end outside the pond until water begins to flow out. The end of the pipe inside the pond must be kept in the water or the siphon will not work.

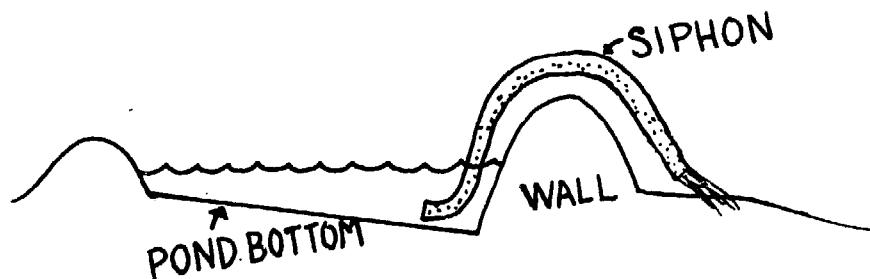

The pump is usually not a good idea for a farmer because the engines that are used to run the pumps are costly and often not available, or gasoline to run them is costly, or they must be given frequent attention so they will not break down.

All ponds must be drained for harvesting fish. Also, it is a good idea to let a pond dry out completely once every year or so to get rid of any unwanted fish and/or disease-causing organisms.

The following are some tested, effective drainage systems a farmer can consider for his pond.

RIVALDI VALVE This valve was named after a farmer in Paraguay who first used the system. It is an easy and good method to use in a small fish pond. A farmer who is building only one small pond for family use would find this valve a good choice for his needs.

The Rivaldi valve is a flexible plastic pipe. Place the pipe on the ground before the wall is built. Build the wall. Then turn up and tie the pipe to a stake. Tie the pipe end at a level which is somewhat above the usual level of the water in the pond. Keep the pipe up and tied to the stake until it is time to drain the pond. Then, untie the pipe and let it lay on the floor of the pond until the water is out of the pond. At other times, the pipe works as an overflow to let out water after a heavy rain: when the water level in the pond reaches the top of the pipe,

water will flow down the pipe and out of the pond.

The Rivaldi valve should have a screen over the end inside the pond to keep fish from going out of the pond while the pond is being emptied or drained.

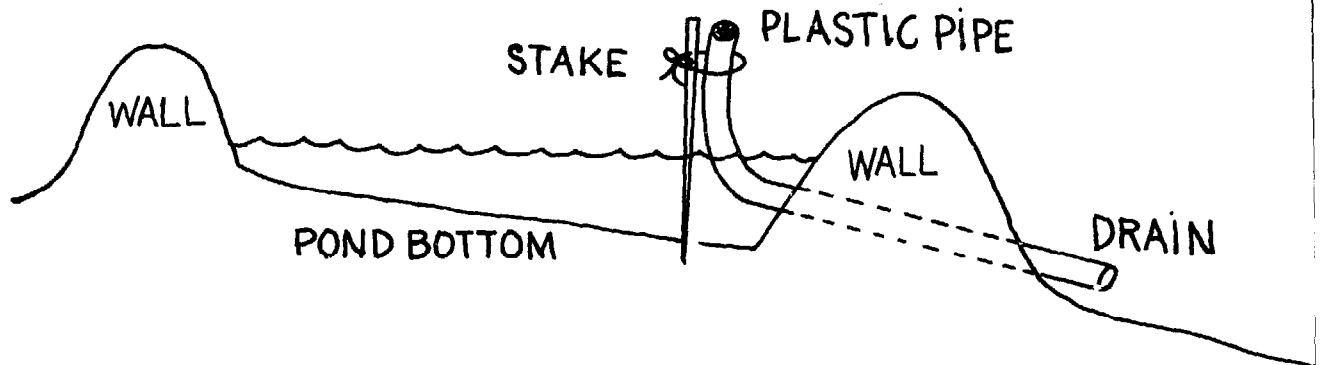

ELBOW JOINT A variation of the Rivaldi valve, this consists of two metal or plastic pipes connected by an elbow joint. The joint lets the upper pipe be turned down to drain the pond. The joint is screwed onto the ends of the two pipes, one of which extends under the wall and the other above the surface of the water. This drainage method is also called a "turn-down" pipe because it is actually turned on its side to drain the pond.

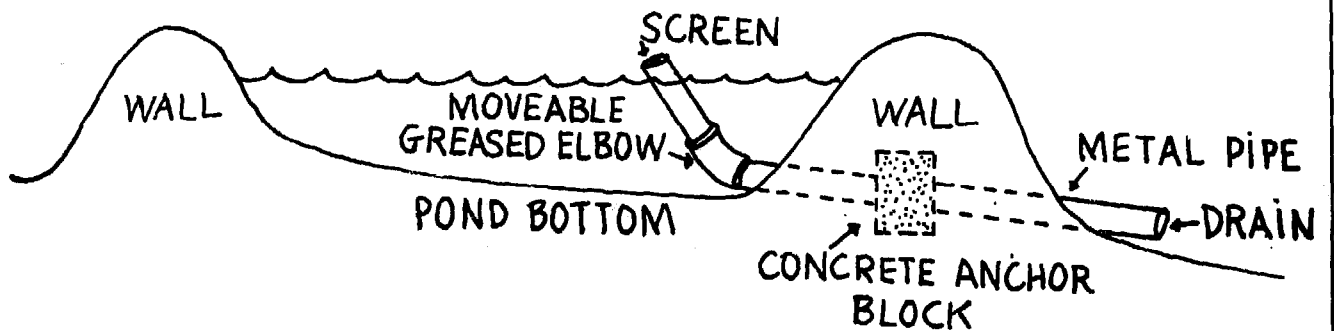

BOTTOM-WATER OVERFLOW This drain takes water directly from the bottom of the pond where oxygen levels are the lowest. The Rivaldi valve and elbow joint do this also, but each of these requires that the pipe be lowered so the pond can be drained. The bottom-water overflow regulates the depth of water without any need for moving the pipes. When new water is added to the pond, the less-oxygenated water at the bottom drains out automatically.

This type of drain is relatively complicated and usually difficult to build. For a small fish farm operation, it would probably not be worth the effort.

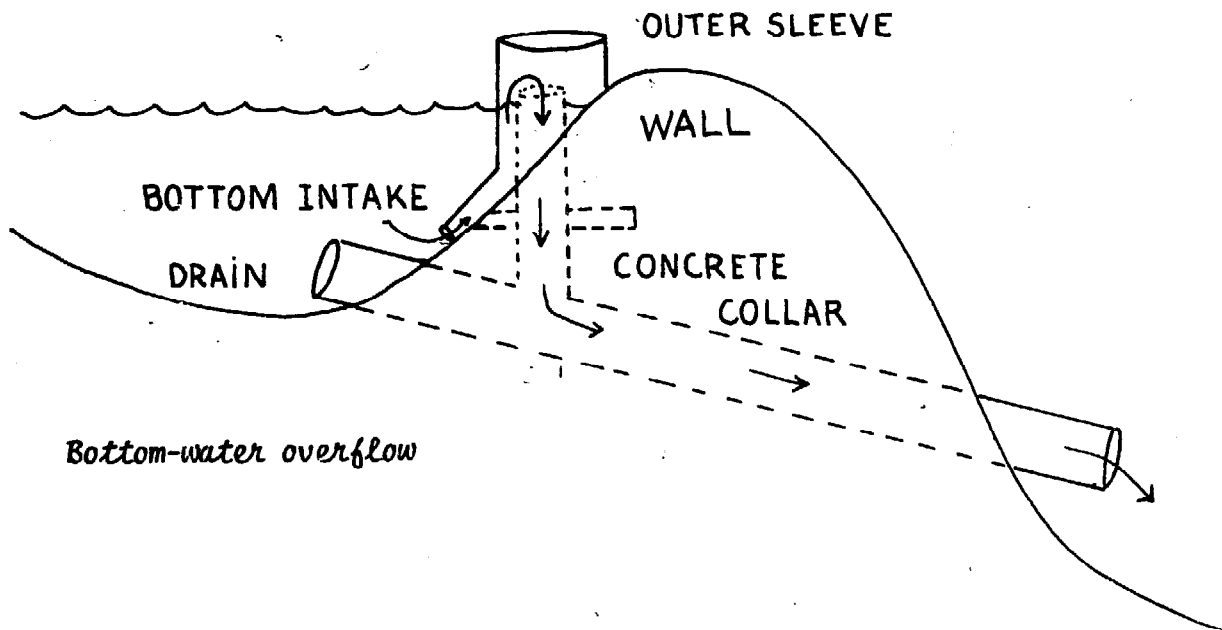

Bottom-water overflow

DOUBLE SLEEVE OVERFLOW This drainage system is built like the turn-down pipe, except a large pipe is placed over the section of pipe which extends above the pond's surface. This outer pipe should be longer and wider than the inner pipe, which is placed so that it is about equal in height to the depth of water desired in the pond.

When fresh water is required in the pond quickly because the water is too warm for the fish or because the oxygen levels are low, all the farmer has to do is to add water to the pond. The double-sleeve overflow automatically drains the stale water from the bottom of the pond.

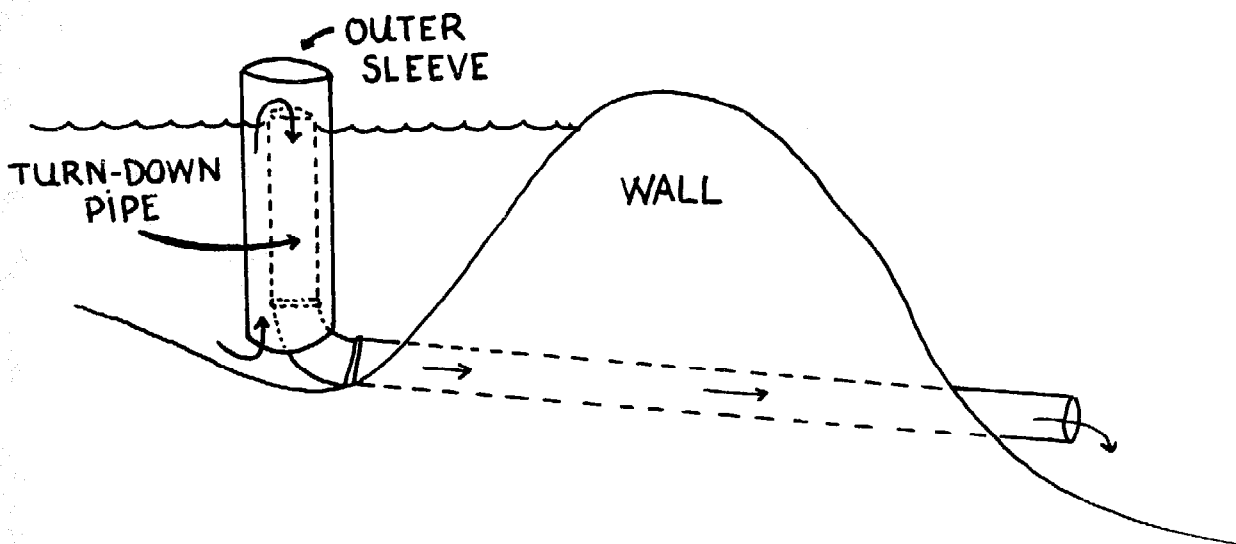

SLUICE A sluice can function in a number of ways in a pond. It can be a screened gate in a water channel going into the pond, or a drainage gate leading water out of the pond.

In a pond, a drainage sluice gate is anchored into the main wall by extending the sides of the sluice into the wall so the sluice structure stands upright. The sluice is constructed at the center of the main wall before the dike is built.

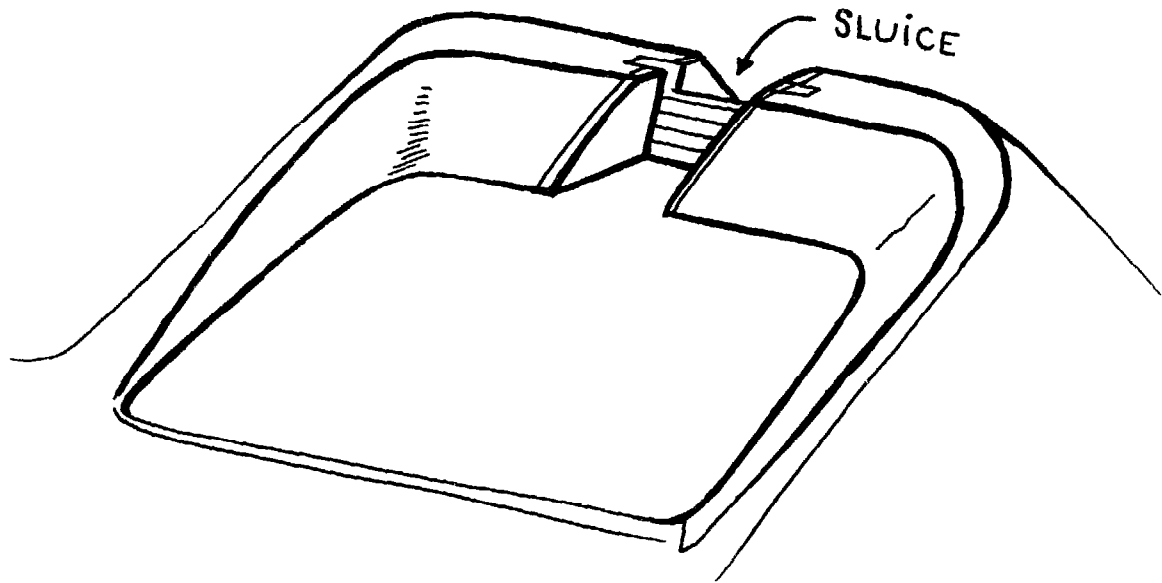

The sluice can be made of wood, cement, or brick. It can have one or two wooden gates which are removed to empty or fill the pond. A sluice also can have a screen gate to keep unwanted fish from entering at an inlet and pond fish from leaving at the outlet.

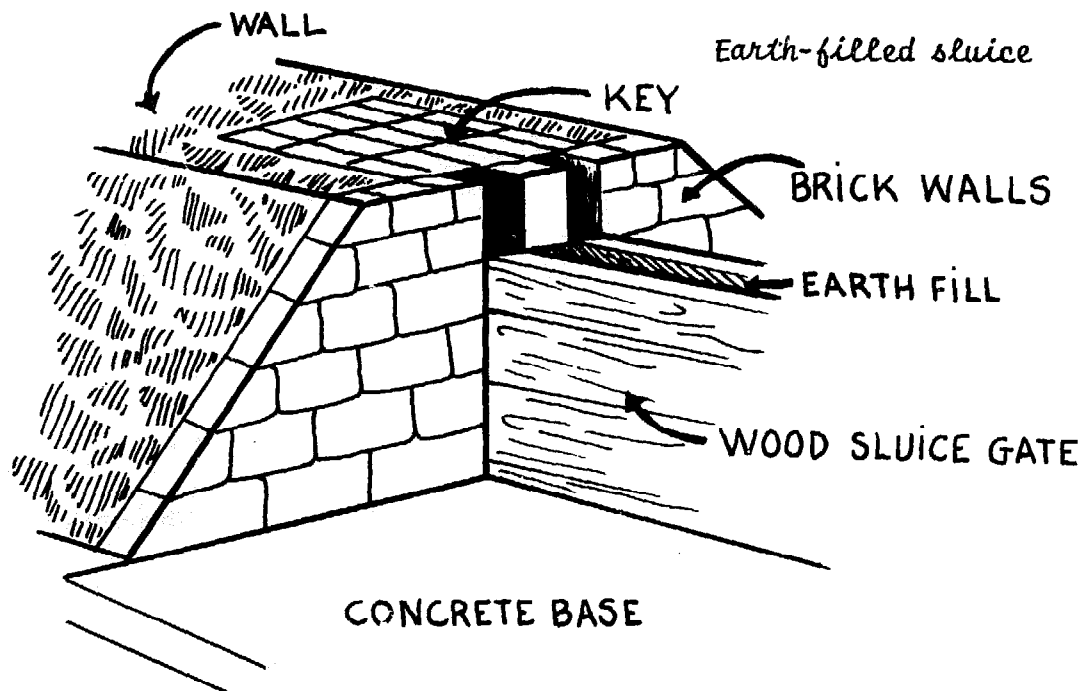

IMPORTANT: The wooden gates of the sluice must fit into the slots well, but easily. The wood will swell to make a tighter seal as it is soaked by the water in the pond. The slots (grooves) can be filled with several strong, long, narrow boards which have been bevelled or notched so that they fit together tightly. Or the slots can be filled with single pieces of wood. When single pieces of wood (or a number of boards which have been fastened tightly together) are used in a sluice, the pond is drained and the water flow regulated by lifting the entire wooden structure out of the groove to a height which allows some or a lot of water to flow out of the pond. When separate boards are used in the grooves, the boards are taken out one at a time. If a small flow out of the pond is desired, only one board may be taken out. To drain the pond, all the boards are removed. In a sluice having two wooden gates, the space between the gates can be packed tightly with earth. This will help seal the water into the pond.

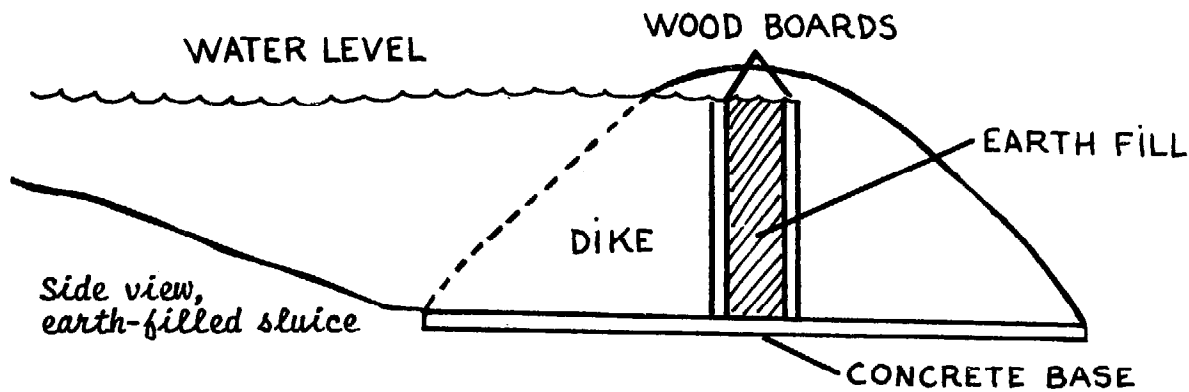

MONK The monk is very much like the sluice, but it is not built into the pond wall the way the sluice is. Sometimes the back of the monk does touch the wall, but it is not built into the wall. Also, a monk is never used at the inlet as a sluice can be.

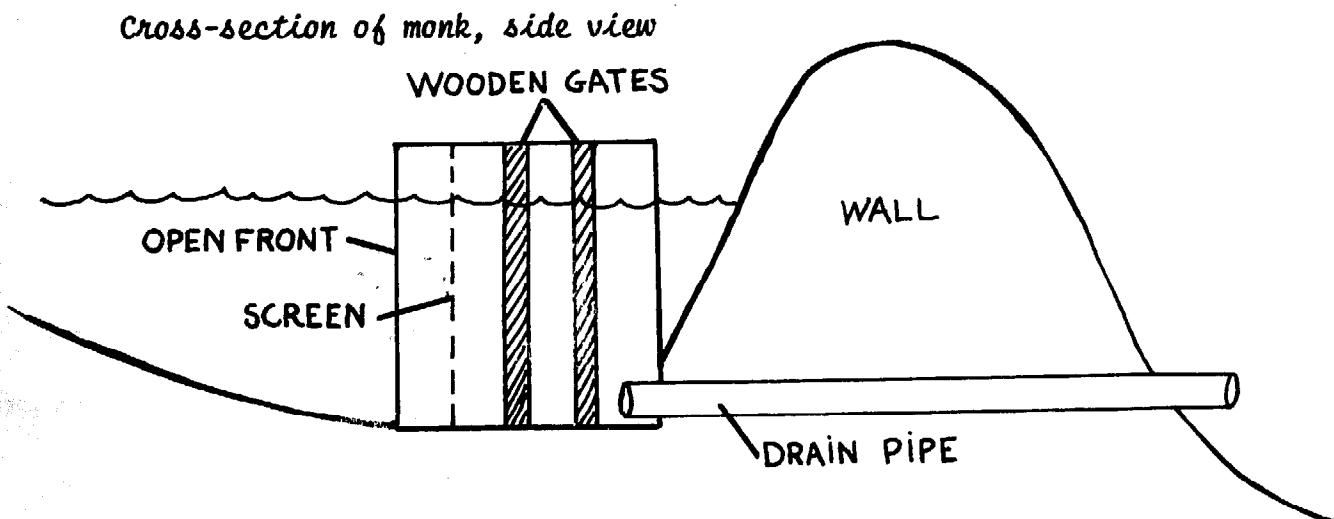

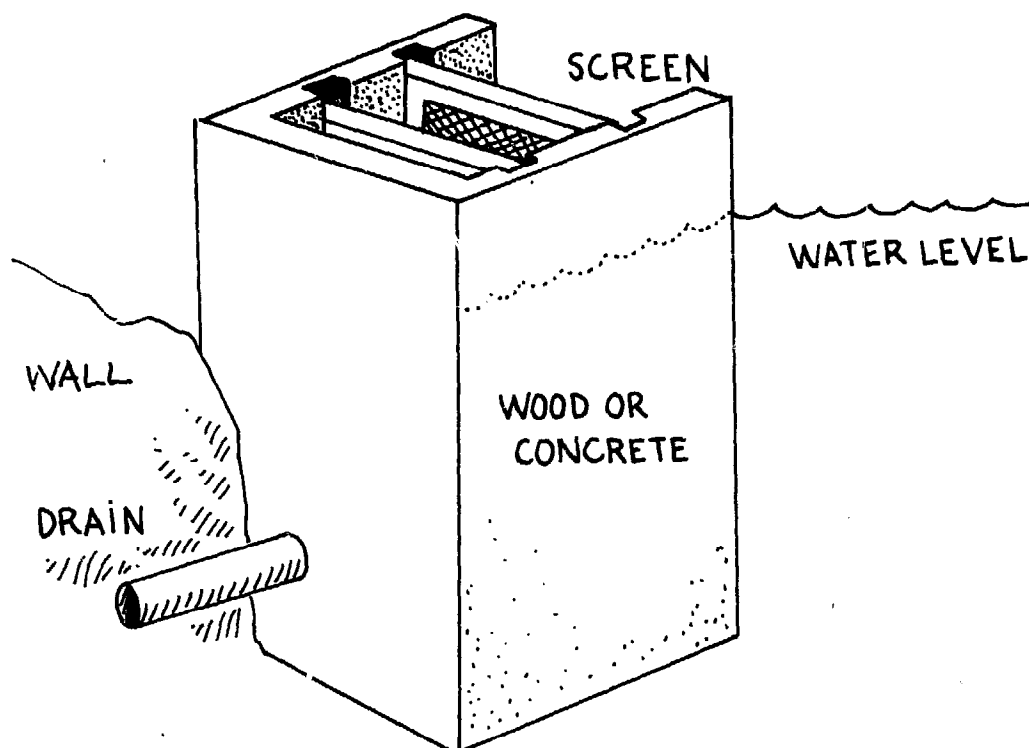

A monk-type drainage system controls the level of water and prevents fish from escaping when the pond is being filled. It also allows for good drainage of the pond. The completed structure consists of a horizontal drainage pipe and the vertical structure, or monk. The drainage pipe must be placed before the walls are built; the monk may be built outside the pond, and placed inside later.

The drainage pipe runs from the back of the monk under the pond wall. It should be between 20 and 40cm in diameter; if piping of this diameter is not available, two pipes may be used. For good drainage, place the pipes 30 to 40cm lower than the pond bottom. Make sure the drainage pipe is on solid ground so that the pipes do not bend. Bent pipes are difficult to clean out when clogged.

The monk itself is a structure which is closed on three sides and open in the front. The open side should face the inside of the pond and should be at least 30cm wide; the entire monk should be at least 40cm above the surface of the water.

The two parallel sides of the monk, and the bottom, have grooves cut in them: a monk may have two or three grooves. One groove, or part of a groove is always for the screen. The other groove(s) is for the boards.

Monks can be made of wood, concrete or brick. A wooden monk should use strong wood -- 4 to 5cm thick.

A concrete monk should be reinforced with metal. Before the concrete is poured, a wooden form shaped like the monk is made and oiled. A frame,

slightly smaller than the wooden form, is made of chicken wire, or some other strong wire, and set down inside of the wooden form. The concrete is then poured into the form. A good concrete mixture for monks is 1 part cement, 2 parts clean sand, and 4 parts crushed stone, by volume.

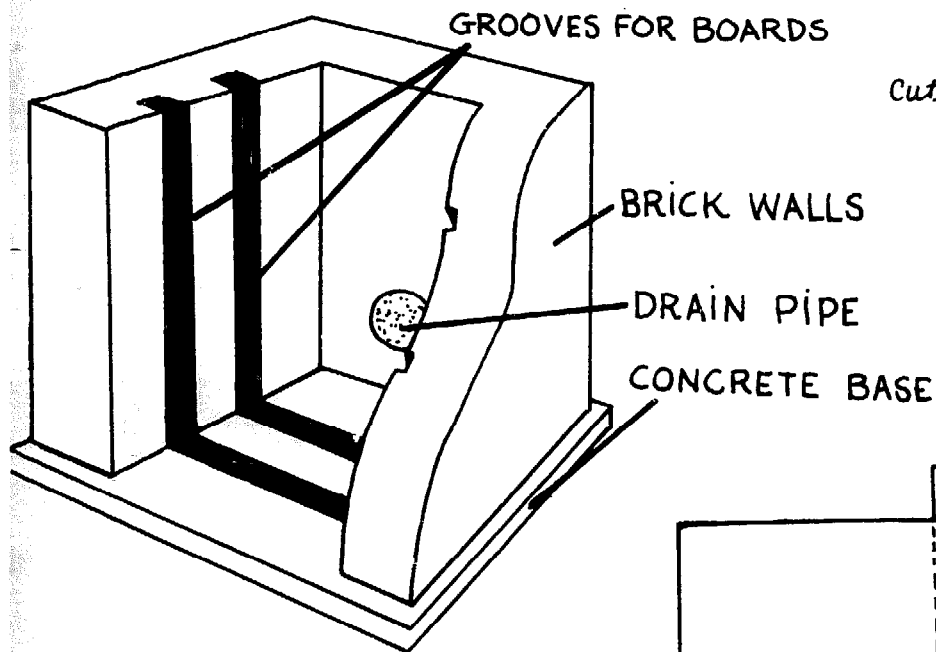

Cutaway of monk

Top view of monk

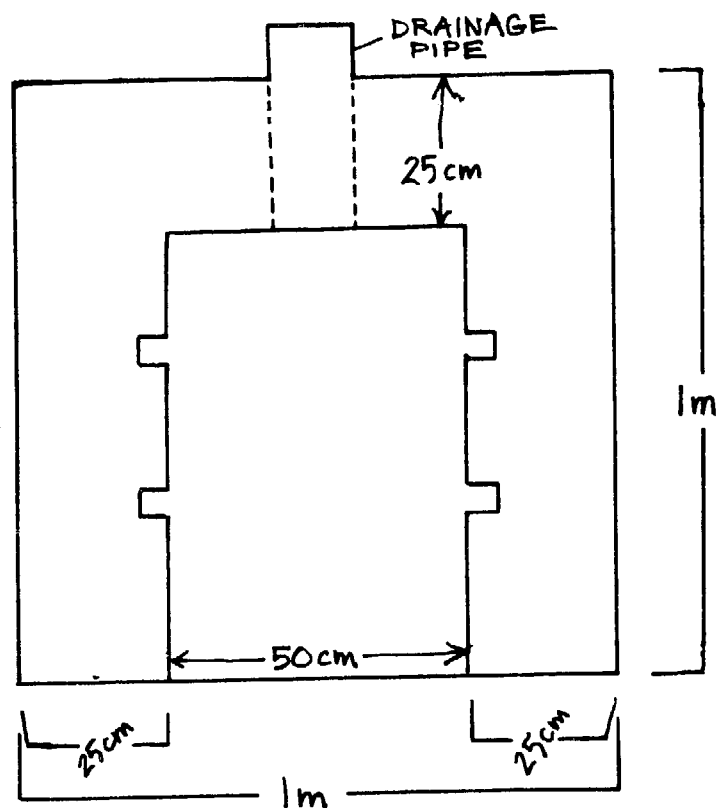

If the monk is made of concrete, the grooves can be shaped by bending iron rods into a "U" shape. Remember, the grooves must be sunk into the sides and bottom of the monk.

The grooves are filled by using a series of boards -- wide enough to fit the grooves well and between 20 and 30cm high. Each board has a hook on it so it can be lifted from the groove easily; the boards may also be bevelled or notched so that they fit together well.

If the monk has three grooves, the first groove can be a large screen. The screen is what keeps the fish from escaping as the pond drains. However, if the monk has only two grooves, a smaller screen can be placed above or below the boards in the first groove. Placing the screen at the bottom allows water to drain out from the bottom of the pond.

HERRGUTH MONK This is a monk with three grooves. A large screen is in the first groove. The large screen is better than a smaller one because it does not get clogged up as easily as a small screen.

The second groove holds a series of boards. The lowest board can be a small screen. Water flows through the large screen in the first groove, and through the small screen in the bottom of the first series of boards, up and over the third series of boards into the drainage system.

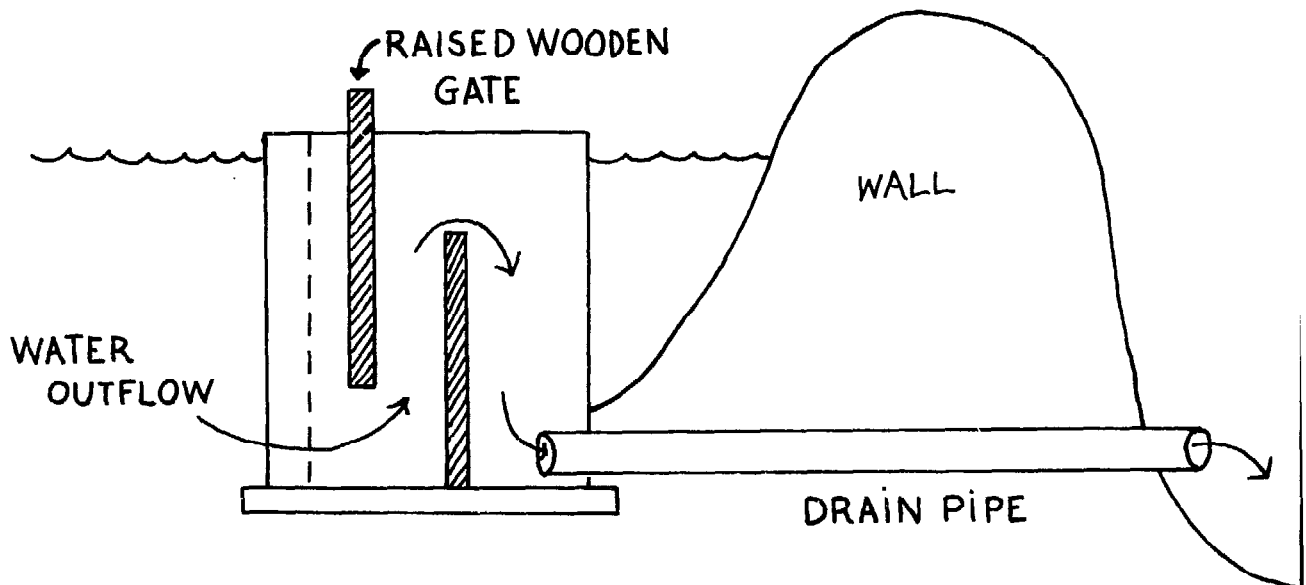

There are other ways this kind of monk can be built. For example, the second groove could be filled by a large wooden gate (one piece of wood or several fastened together) which could be raised and held up to allow a flow of water from the bottom of the pond. It is this flow of water from the bottom of the pond which is important.

The Herrguth monk would probably not be used in a pond which is filled by rainwater. In these ponds -- sky ponds -- a regular monk is used, and the space between the two wooden gates is packed with mud to make a watertight seal which lasts for the fish-growing season and is removed when the pond is drained for harvest.

SOME NOTES ABOUT MONKS Be careful with screens. Bamboo slats can be used instead of screening if the fish are large. But for fry, the holes should be less than 2mm in diameter. Often the screens are made by poking small holes in sheet metal. The screen mesh can get larger as the fish grow.

A valve is sometimes placed on the drainage pipe behind the upright part of the monk. This is used to control the draining speed and is easier to do than to move the boards in the grooves.

A large catching ditch can be made in front of the monk to help with taking fish out of the pond when the pond is being drained for harvest.

DRAINAGE DITCHES Drainage ditches are channels which should be dug on the bottom of the pond to help the water flow out. Lining the ditches with stones helps the water flow. A small family pond does not require this system of drains. The only real requirement for drainage is a gentle slope.

This is the time to build other ditches which may be needed. For example, if the farmer wants to use the water from his fish pond to irrigate his land, he will want to construct the ditches or channels which will carry the water from the pond to the field or to storage tanks for use later. Therefore, the farmer must consider carefully where the water which is draining from a pond is going to go. If the pond is being fully drained, and the pond is built on flat ground, he should build drainage ditches around the outside of his pond to drain the water away from the walls. These ditches should be 30-40cm deep.

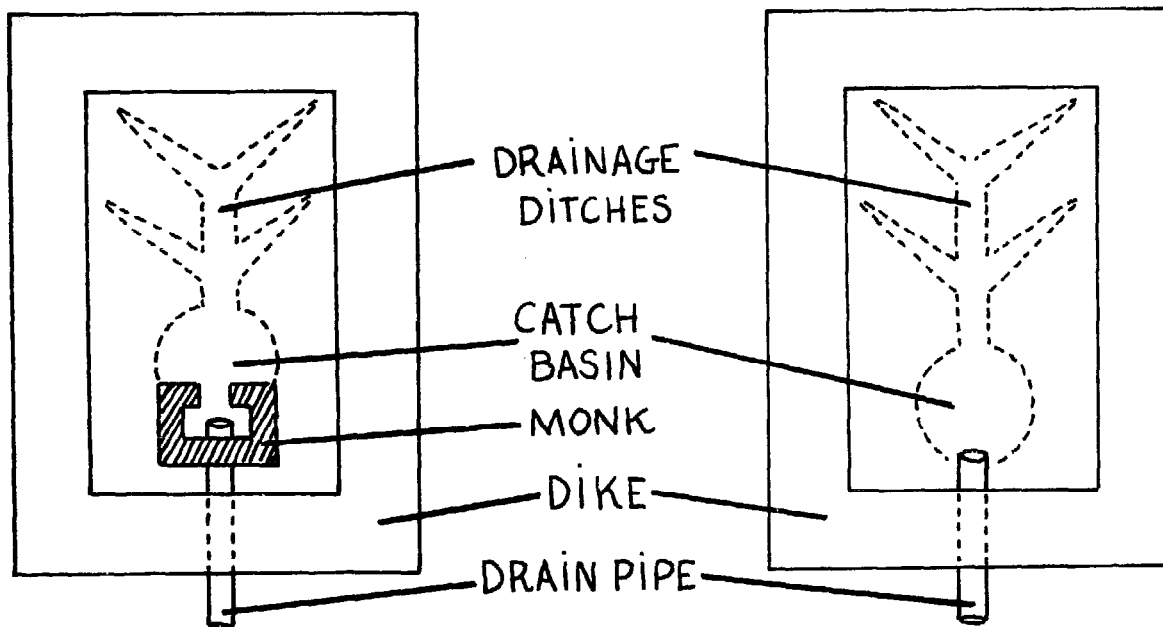

Water Inlet

All ponds, except for those filled directly by a spring or by rainwater, need water inlets. The water inlet must be constructed so that it supplies adequate quantities and quality of water, and so that it does not allow unwanted fish or other materials to enter the pond. This usually means there must be a channel of some kind to bring the water to the pond from the source and a filter of some kind to keep the water which goes into the pond clean and free from predators.

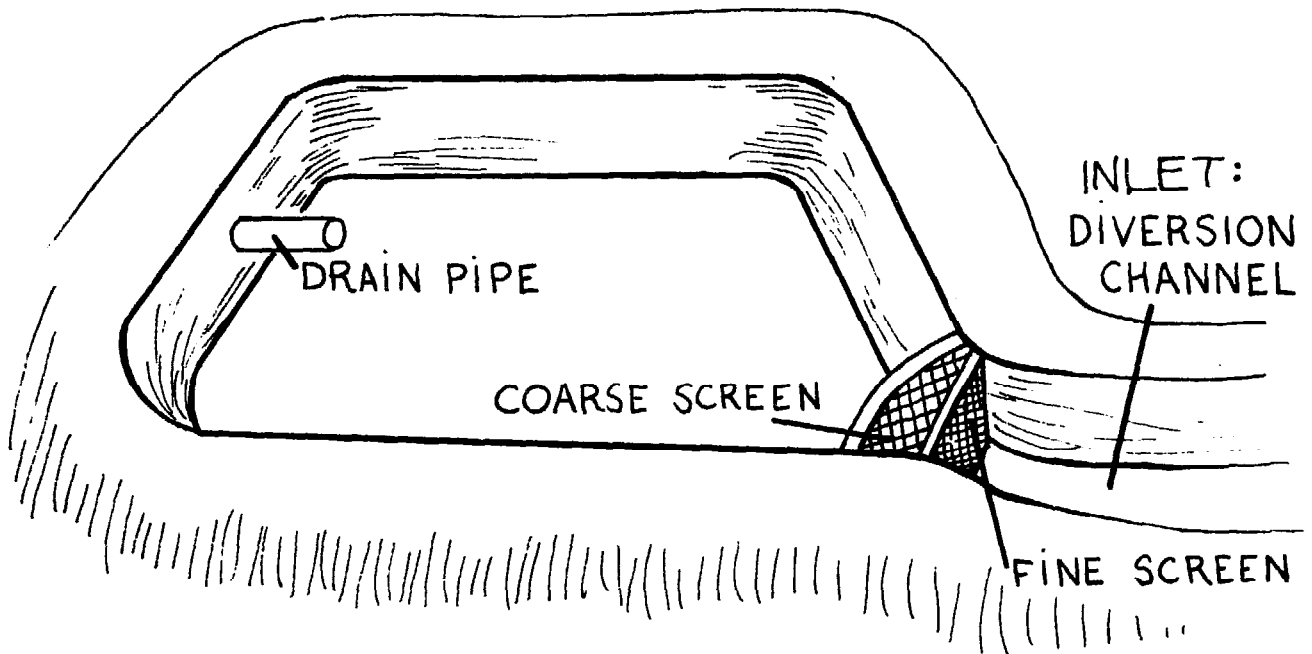

A water inlet can be as simple as a bamboo pipe of good diameter running from a water source through the wall into the pond. Remember: the inlet pipe should be placed above the water level so that incoming water drops into the pond. In some areas, such things as bamboo strips are tied to the end of the inlet pipe which is placed over the pond. The water flow into the pond is broken up by the strips and the water picks up and takes more oxygen from the air into the pond water.

If the pond is large or is a stream-fed barrage pond, a sluice makes a very good water inlet. The sluice can be one piece which controls flow when it is lifted to various heights, or the sluice can be a series of boards slipped in and out of the grooves.

It is better to filter most pond water as it goes into the pond. Filters are not needed if the water is clean and clear and the farmer knows the source is free from unwanted fish. But if the water is muddy, or has lots of leaves or debris in it, a filter helps keep the water quality good.

A filter can be placed at the beginning, middle or end of the channel which brings water to the pond. Usually filters work best near the water inlet. Filters can be made very simply. Remember they must keep unwanted fish out and pond fish in.

A wire screen makes a good filter. The picture above shows a sluice with a gate with fine screening to strain incoming water of pieces of debris and other unwanted fish and materials. Note the screen fits into the water channel exactly.

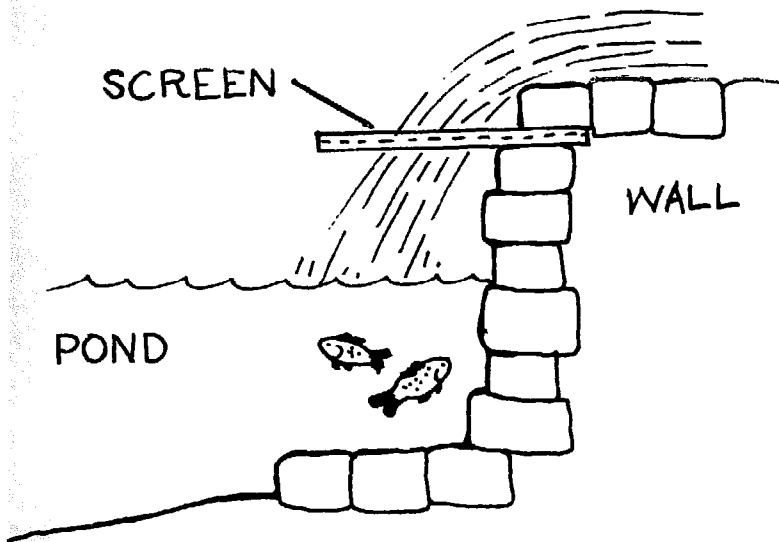

The horizontal screen at the left is very effective. Here the screen is placed so that the water passes through as it falls into the pond. This screen merely juts out from the wall at the inlet.

In the version below the horizontal screen has a vertical screen wall attached to it. This short wall prevents fish from going over the screen.

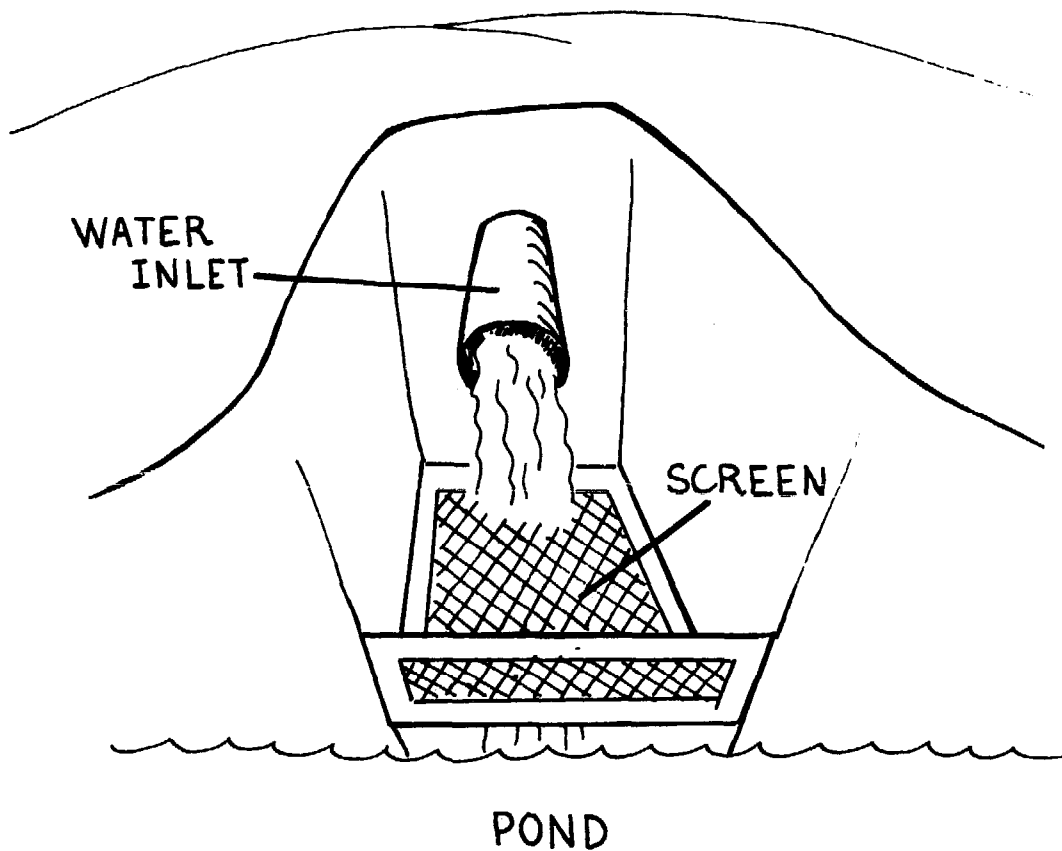

In any variations of these kinds of filters, the screens should be assembled into one piece for easy removal as a unit for cleaning.

There are other ways of filtering the water:

A nylon mesh bag makes a good filter, as long as it is partially submerged in the pond so that it does not tear as the bag catches fish or other material from the water source. Check it periodically.

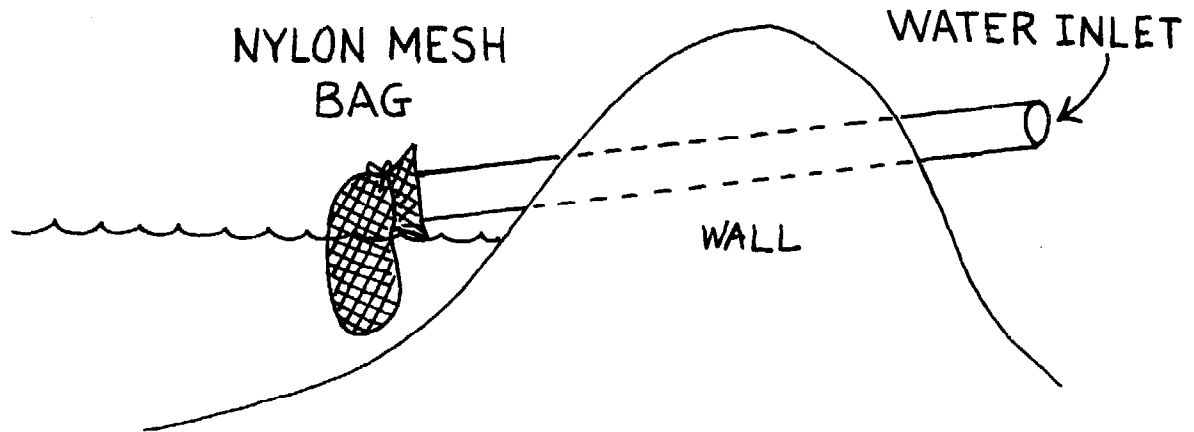

A sand and gravel filter is particularly useful for cleaning out fish and eggs. It requires building a smaller pond or tank at the water inlet. If a filter is built in the earth it must be lined with a waterproof liner.

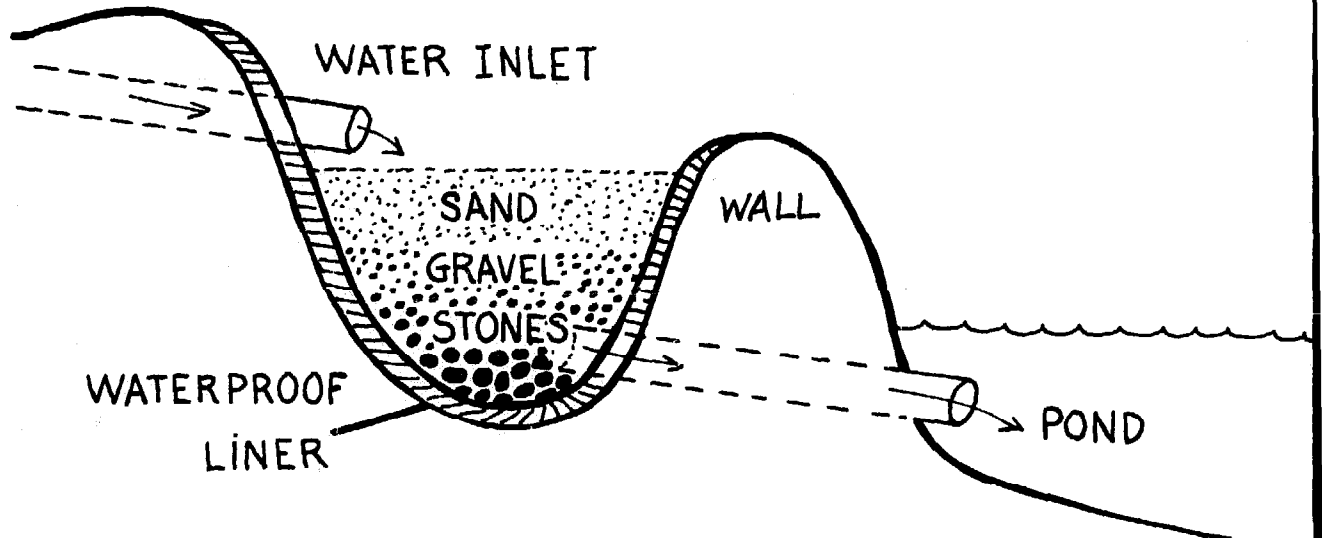

A saran fiber filter is basically like a wire screen that is placed horizontally underneath the water inlet. However, it is placed in a box standing in the water and uses saran fiber material instead of wire. (See drawings next page.)

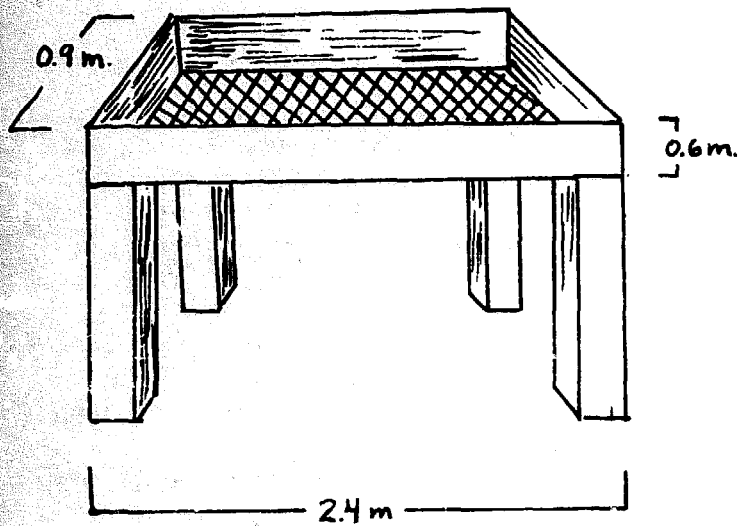

Saran fiber filter

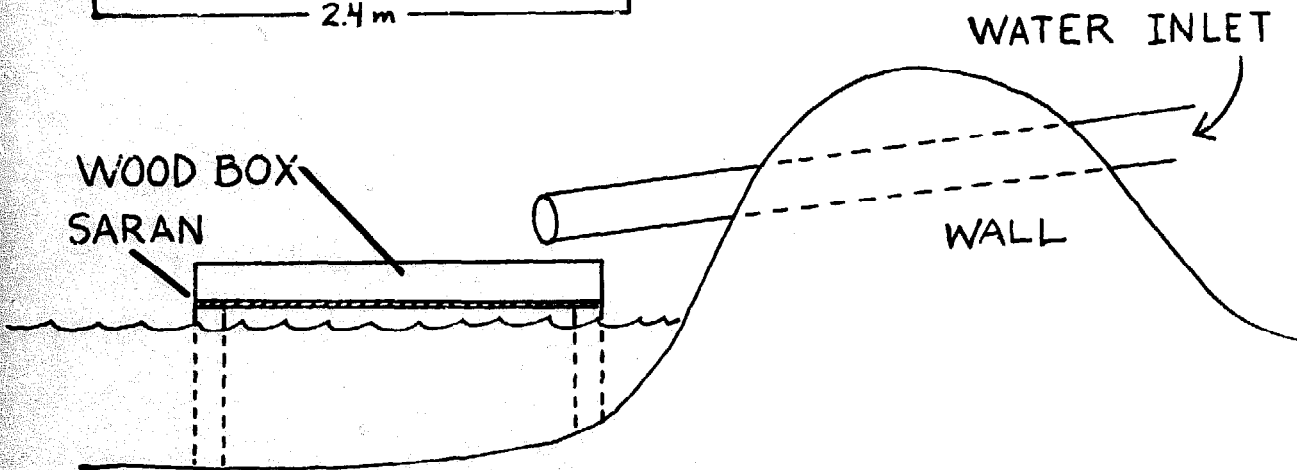

These filters all have good and bad points. All must be cleaned often to remove debris that collects in them from the water source. The best filters are the sand and gravel filter, and the saran filter, but these are more costly than the others.

The farmer should examine his water source carefully before deciding on the kind of filter. If the water is very muddy, or has lots of leaves and grass in it (organic matter), he can use the wire screen. If the water source is free of organic material, the mesh bag will work because it is not likely to be torn. If the water contains unwanted fish and eggs, as well as a lot of organic matter, the saran filter or the sand and gravel filter is best.

To clean the filters, remove them and clean them with a brush and fresh water. Or flush the filter with water in the opposite direction of the normal water flow. This is called backwashing.

IMPORTANT: Filters must be kept clean to be of any use. These filters should be cleaned each time water is let into the pond.

SILTATION TANK One other structure which should be built at the water inlet, when necessary, is called a siltation tank. Silt is the mud that is suspended (floating) in water. Silt can become a problem when it clogs the gills of the pond fish so they cannot breathe. If the water source has a lot of mud in it, a siltation tank should be built at the inlet to the pond, or at the inlet to the first pond, if it is one of a series.

The siltation tank can simply be a smaller pond. The water flows into this pond and is kept there until the mud falls out of the water and settles on the bottom. Then the clear water is let into the fish pond. Siltation could also be done in a storage tank made out of old oil drums, etc. The important thing is that something be constructed or set up so that the silt has a chance to fall out of the water before that water goes into the pond.

The silt must be removed from the siltation tank or pond every so often. The silt which is removed should be used in gardens and fields: it is very fertile.

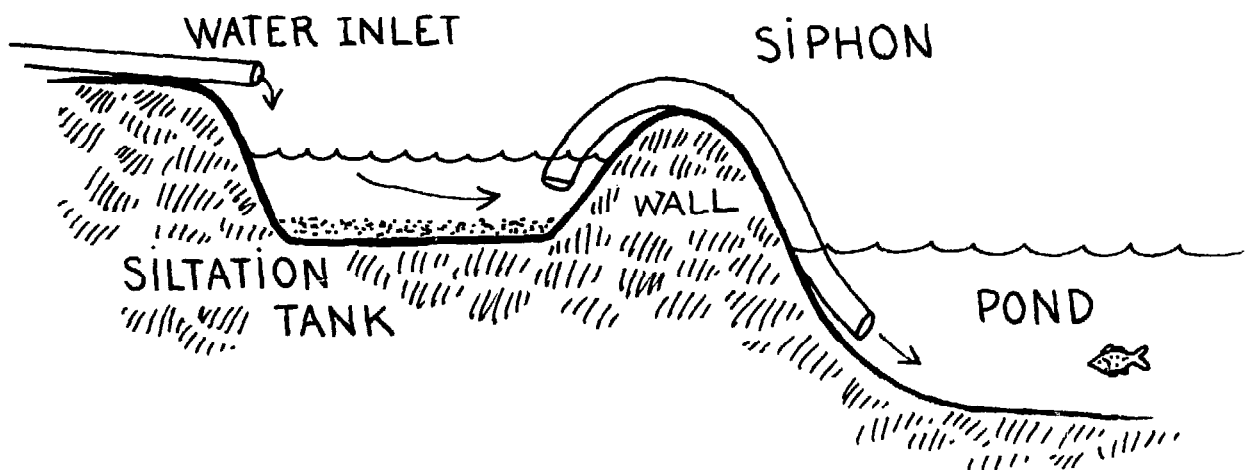

Build the Walls

The walls (dikes, dams, levees) have to withstand the pressure of all the water in the pond. They also have to be watertight to keep the water inside the pond.

The construction of the walls depends upon the kind of soil in which the pond is being built.

A soil which is a mixture of sand and clay is best. If pure clay is to be used, it must be mixed with other soil before it can be used. Pure clay will crack and leak. Do not use turf, humus, or peaty earth. All stones, pieces of wood, and other materials which might rot or otherwise weaken the wall must be removed before building begins. If the soil contains enough clay, the walls can be built by placing layers of soil 20cm deep over the drainage pipes and tamping each layer down until it is compact.

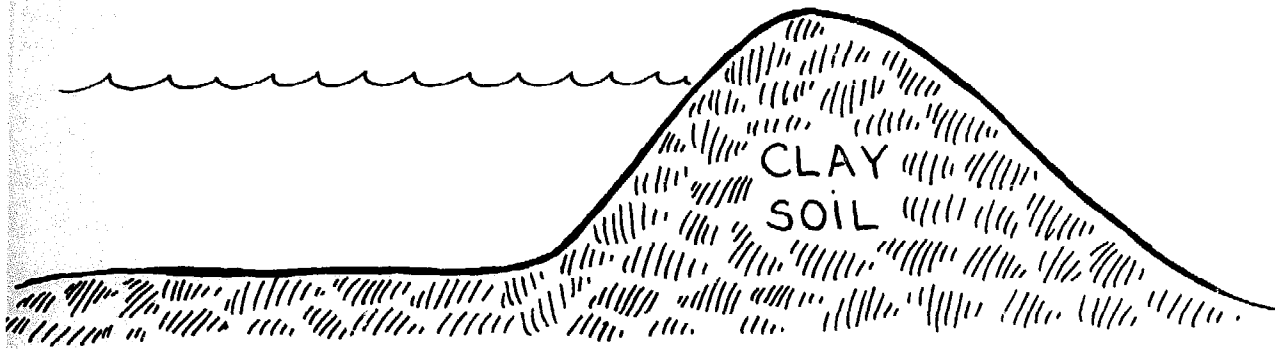

The finished height of the wall should be about 30cm above water for small ponds and 50cm above water for large ponds. The width of the wall at the top should be about equal to its height. For a large pond, the wall is never less than 1m wide at the top; most walls are built so that two people can walk side by side along the top.

Tamp the soil down with a simple tamping tool. Some people use a large rock or even their own weight by jumping up and down on the soil. The important thing is that the soil must be packed down very tightly.

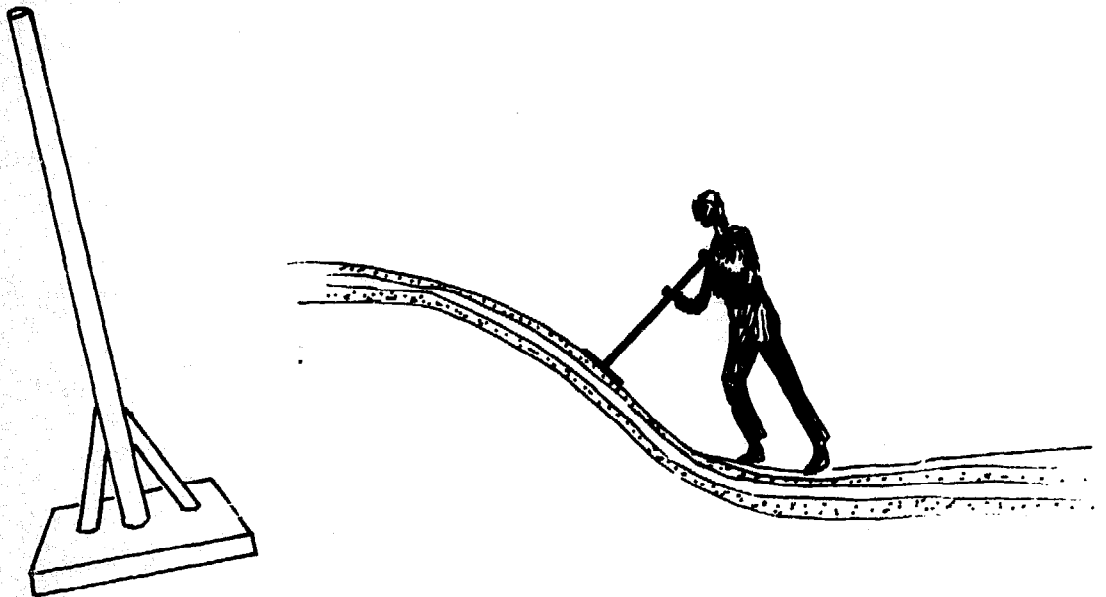

One way to build pond walls in soil that does not have a lot of clay or is very sandy is to build a "key." The key is made of clay soil (it can be pure clay) and adds strength to the walls. To make a key, dig a trench (or shallow hole) about 1m deep and 1m wide in the center of the places where the walls will be. Then bring clay soil and pack it tightly into the trench. Also put a thick layer of clay soil on the pond bottom and pack that down tightly. The clay layer on the bottom and the key run together as shown. This connection of the bottom and the key helps prevent leaking. The drainage pipe should be placed in the clay lining.

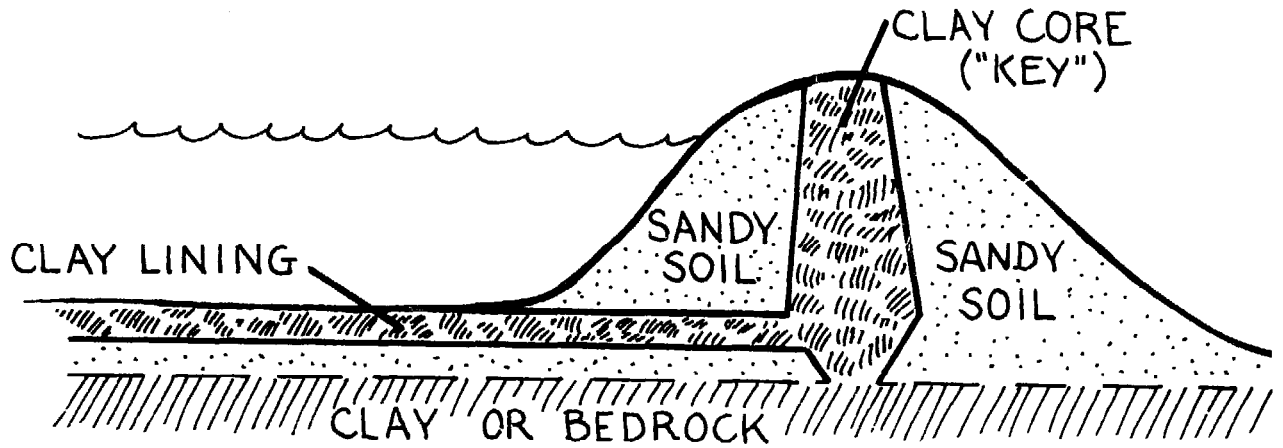

If the farmer has a soil which is a mixture of clay and sand, and he is not sure it is strong enough, he may still wish to build a clay key. Or he can build a key using the same soil used in the wall. This key must be packed down very tightly.

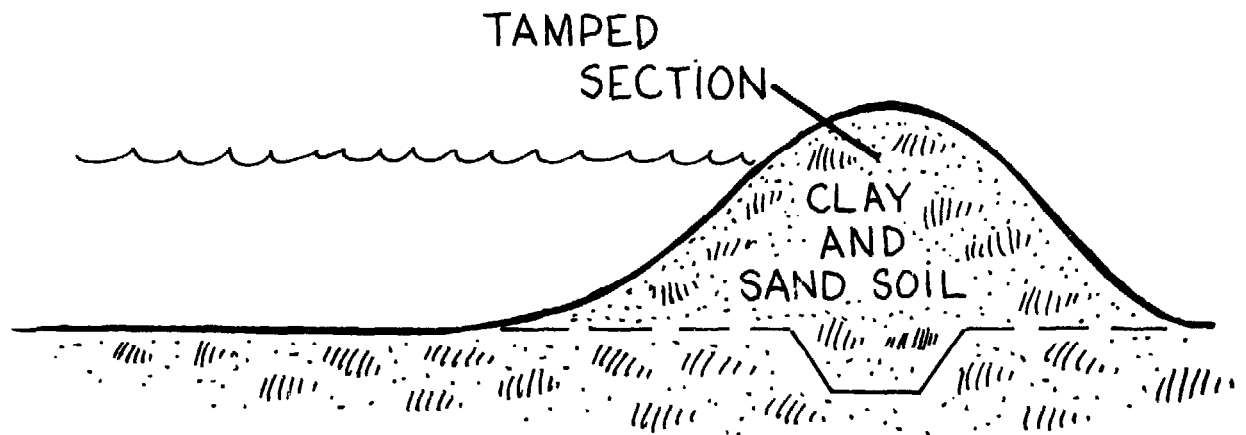

The type of soil determines the ways in which the pond can be prepared so water does not leak out (see "Seal the Pond Bottom", next page).

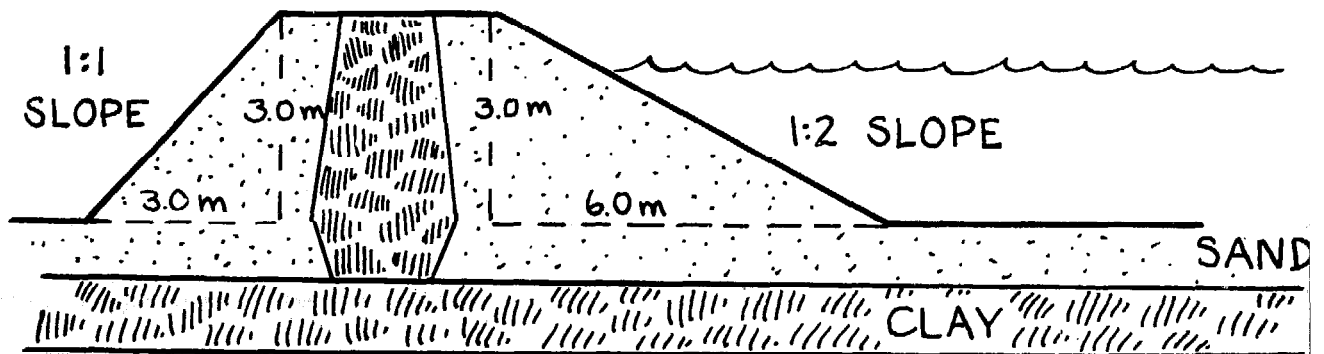

The soil also determines the slope of the walls. Soil with a lot of clay in it can have a greater slope on the outside wall than on the inside wall. A typical wall is built with an outside slope of 1:1 and an inside slope of 1:2. A slope of 1:2 means that for every change in length of 2m there is a change of 1m in height.

Once the walls are constructed, the farmer should plant grass on them. The grass roots help to hold the wall together and prevent erosion of the soil. However, NEVER plant trees on the wall. As the tree roots grow they will crack and destroy the wall.

Seal the Pond Bottom

The last step in pond construction is sealing the pond bottom so that it does not leak. If the soil has a lot of clay in it, no special sealing is needed. If the bottom is sand or gravel, it should be sealed to help it hold water. One way to seal the pond is to build a clay core into the wall and extend the clay over the bottom of the pond as a lining. This kind of sealing must be done when the walls are built. After the walls are built, there are other methods you can use for sealing the pond.

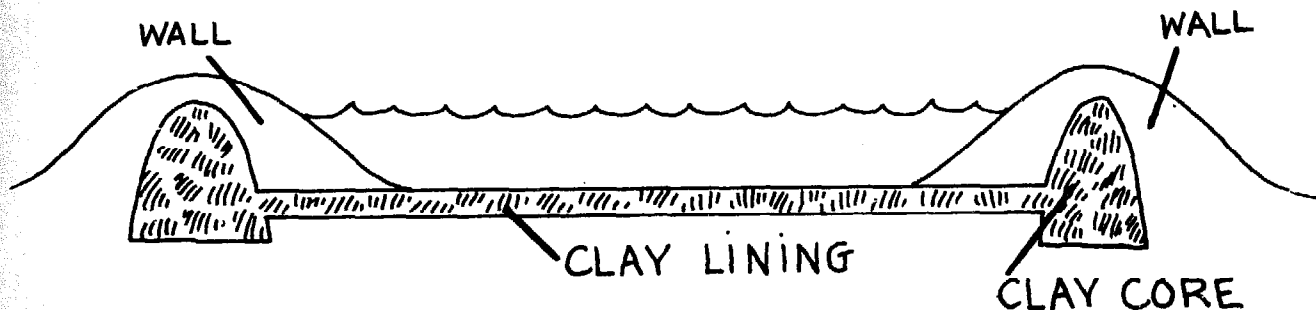

A pond can be sealed using hollow cement blocks, but this is expensive. Another method of sealing the bottom calls for using a sheet liner made of polyethylene plastic, or a rubber liner. The waterproof sheet is placed on the pond bottom and around the sides in one piece (the farmer may have to tightly seal several sections together), then covered with soil.

Another technique, recently developed in the USSR, is called a "gley" or "biological plastic." "Gley" can be made in the pond in this way:

- . Clear the pond bottom of debris, rocks, and all other materials.
- . Cover the pond bottom and sides completely with pig dung. Apply the dung in an even layer.
- . Cover the pig dung layer with banana leaves, cut grasses, or any vegetable matter. Make sure all the pig dung is covered.

- . Put a layer of soil on top of the vegetable layer.
- . Tamp the layers down very well.
- . Wait 2 to 3 weeks before filling the pond.

5

Preparing the Pond

The last pages of the construction section presented several ways of sealing the bottom of the pond so it will hold water better. This section tells what has to be done to prepare the completed pond for the fish.

Conditioning the Pond

If the pond is an old one from which the fish have been harvested, plow it completely. Plowing turns the ground over so that it dries well. Clear the bottom of any twigs, stumps, branches, or dead fish. Any predators (snakes, frogs, etc.) must be taken out by hand or poisoned (see *Problems of Fish in Pond* for more information on this subject). Then smooth the bottom out again. When the pond is dried enough, the soil will have large cracks in it.

After the pond is plowed, cleared, and smoothed, it should be conditioned with lime.

Whether the pond is old or new, a layer of lime should be placed on the bottom of the pond. Place the lime on the pond two weeks before the water is put into the pond.

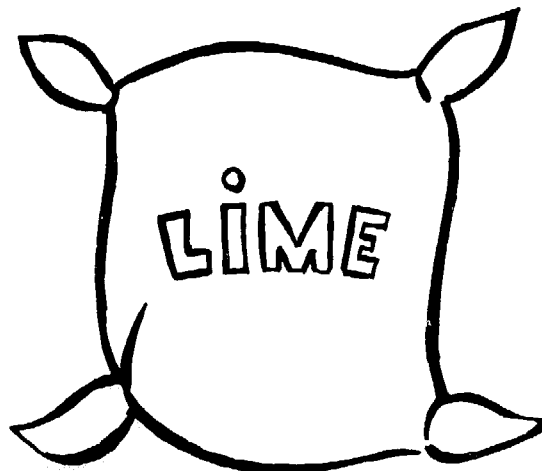

Lime conditions the soil of the pond. It is not a fertilizer, but it helps fertilizers work. It is especially important to use lime if the soil has acids in it which might harm the fish. Lime can control these acids so they are not a danger. A farmer who is not sure whether the soil of his new fish pond has acids in it --

because he had no place to get his soil tested, or because he has never farmed the land -- is always safer if he puts lime on the bottom of the pond.

Lime comes in several forms: ground limestone; agricultural lime; hydrated (builders') lime; or quicklime. Of all these types, hydrated lime is cheapest to use because it is more concentrated.

Quicklime must be used carefully: it can burn if it touches the skin and is harmful if breathed into the body. Farmers should be warned to use quicklime only with extreme care.

Lime should be put on the pond bottom at the following rates for a new pond:

Ground Limestone	1140kg per hectare
Agricultural Lime	2270kg per hectare
Hydrated Lime	114kg per hectare
Quicklime	200kg per hectare

A word about limestone: In many areas of the world, limestone can be found locally. It is a soft stone and may be ground by the farmers themselves. It is a good idea to let farmers know whether or not limestone is available locally and to help them identify it if they can not already do so.

Filling the Pond

After the lime has been on the pond bottom for at least two weeks, let the water in slowly. The water should fall from the water inlet into the pond below, so that the water mixes with oxygen from the air as it falls into the pond.

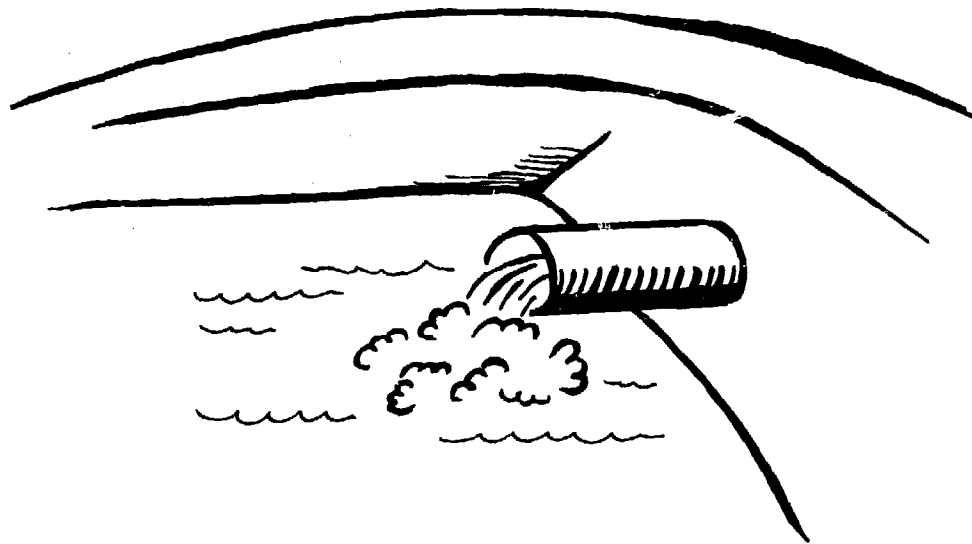

The water should not go in too quickly. If the water goes in too fast, the pond bottom will get stirred up and make the water muddy.

Let the pond sit for a few days after it has been filled. Then check the quality of the water in the pond -- before adding the fish.

Fish growth depends greatly on the quality of the water used in the pond. And the quality of the water depends upon where it comes from and what kind of soil it travels over. Testing the water quality means making sure that all the factors which relate to water are right for the fish. These factors are: temperature, oxygen content, pH, turbidity, hardness, alkalinity, and nutrient availability (source of food for the fish). The farmer does not need to know these particular words to raise fish well, but he does require a working knowledge of the factors that are part of the water world in which the fish live.

TEMPERATURE

Fish are cold-blooded animals; that is, their body temperatures depend upon the temperature of the water in which they live. Every fish species has a temperature range within which it grows quickly. This is called the optimum temperature range, and it means that this fish grows best at temperatures within that range. In a fish pond, the fish should live at their optimum to grow well. However, since fish have different temperature requirements, the farmer must choose the fish which will grow best in the temperature range of his pond.

Here are some of the common pond fish and their temperature ranges:

<i>Genus, species</i>	<i>Common name</i>	<i>Temperature °C</i>
<i>Tilapia mossambica</i>	tilapia	25-35
<i>Osphronemus goramy</i>	gourami	24-28
<i>Puntius javanicus</i>	tawes	25-33
<i>Cyprinus carpio</i>	common carp	20-25
<i>Ctenopharyngodon idellus</i>	grass carp	25-30
<i>Anguilla japonica</i>	eel	20-28

This chart shows that all the fish on this list could live in water that is 25°C (77°F). The chart also shows that an eel can live and grow well at 20°C, but that the tilapia and the grass carp will not do well at 20°C because this temperature is below the range in which they are comfortable. When the temperature goes higher or lower than this optimum, fish will not grow. Eventually, if the temperature goes too high or too low, the fish will die.

The farmer must watch the temperature in the pond water carefully, especially if the weather becomes unusually hot or cold. If it is possible, it is a good idea for a farmer to use a thermometer to find the temperature of his pond water. This can be done by using a

thermometer which is used for taking temperatures when people are sick. The most important step is to guide the farmer to stock fish which will do well in the normal temperature ranges of his area. Then the temperature of the water will not generally be a problem, except in cases of unusual weather.

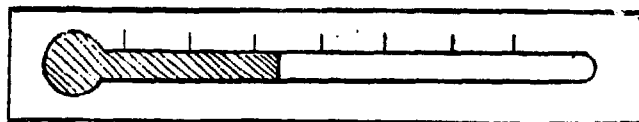

Some experienced fish growers can judge the water temperature by putting their arms in the water. Most people cannot tell temperature this way. But if the right kind of fish has been chosen for the pond, the farmer need only watch the fish to be able to judge the temperature of the pond water. If the water is becoming too hot, the fish will not eat and will move very slowly.

If the farmer sees this behavior in his fish pond, he can take out some of the pond water and put in new, cooler water. Another way of protecting the water from getting too hot is to find a way to shade the pond, so that the sun does not shine directly on the water. The shading should be temporary because sunlight is important to the success of the pond.



The picture on the previous page shows a fish pond being shaded by palm tree branches stuck into the ground around the edges of the pond. As soon as the temperature of the water goes down, the branches are removed.

Temperature, however, usually does not act alone. If the fish are showing signs of distress because of hot weather, it is often a problem caused by high temperatures and low oxygen content.

OXYGEN

The farmer cannot see oxygen, so it may be hard for him to realize its importance. But it is worth taking the time to help a pond owner understand oxygen as a critical factor in the success of his fish pond. Oxygen lack is a problem which can occur at any time during fish pond operation, and there is a good chance the farmer will have to depend only upon his own knowledge of the problem and its cause to solve it immediately.

Fish, like all animals and human beings, need oxygen to breathe and, therefore, to live. Through a process called respiration, fish and human beings take in oxygen and give off carbon dioxide. Fish will not grow well when the oxygen supply is low; and if the oxygen level gets too low, they will die.

Oxygen is a gas. Human beings get the oxygen they need from the air. They cannot see it, or smell it, but without it they would die. Most fish can only get oxygen from the water in the fish pond. The farmer cannot see the oxygen in the water either, but he should realize that it must be there in sufficient quantity for the fish to live.

Oxygen troubles arise in a pond when the supply of oxygen is used up faster than oxygen is put into the pond. This happens to human beings too -- if too many people are shut into a room with no windows or air-holes, the respiration of all these people uses up the oxygen. Soon, there is too much carbon dioxide in the air. The people have trouble breathing until a window is opened and fresh air containing oxygen is let in.

This is exactly what happens to fish in the fish pond. The fish are shut up in the pond, and if there is not enough oxygen entering the pond, they will have trouble breathing. And, if the problem continues, they will die.

Water contains tiny plants and animals called plankton. Most plankton are so very small that they cannot be seen without using a microscope.

The plants are phytoplankton:

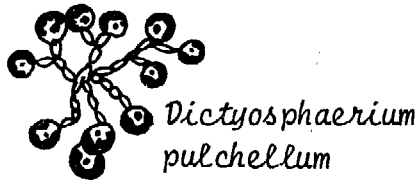

The animals are zooplankton:



Water also contains higher orders of vegetation. These plants are much larger than the phytoplankton.

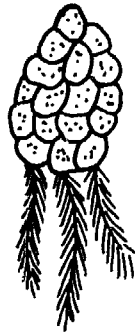

Azolla pinnata

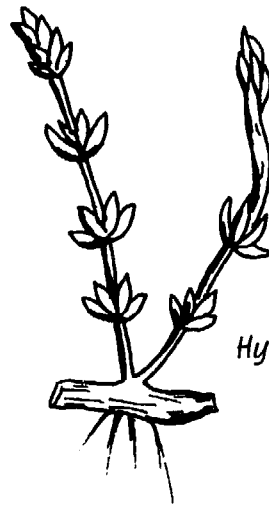

Hydrilla verticillata

A favorite food of the gourami.

The fish and the zooplankton use oxygen and give off carbon dioxide in respiration; the phytoplankton and higher plants use carbon dioxide and sunlight to produce oxygen during a process called photosynthesis.

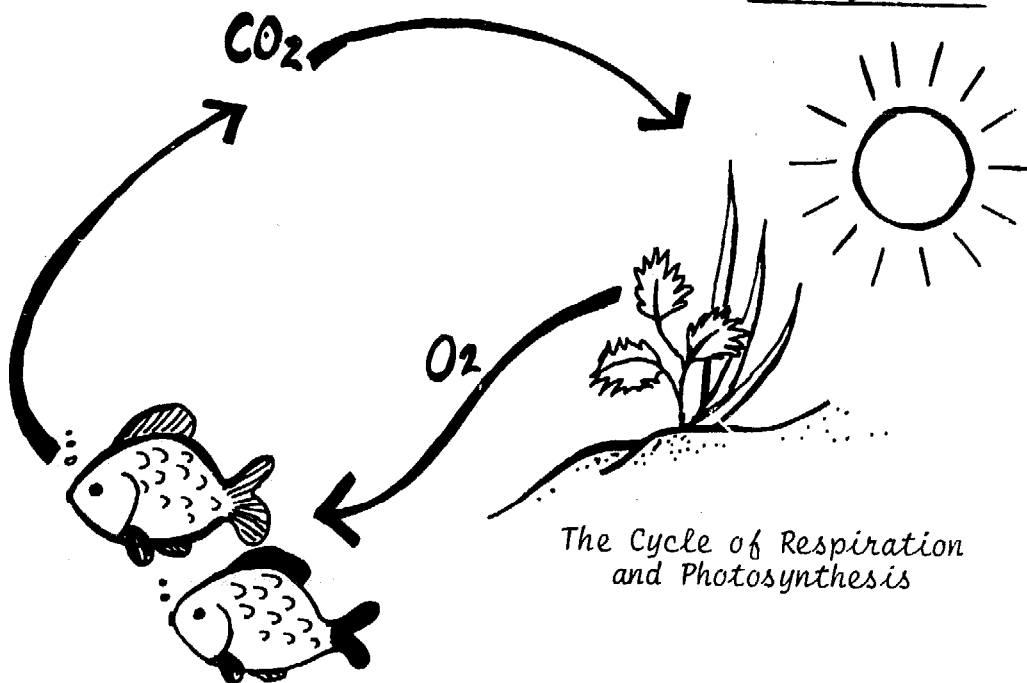

The oxygen in a fish pond also is used up by the process of decay. Dead organic matter -- leaves, fish, other plant and animal material present in the pond, use up oxygen in the decay process called oxidation. Oxidation and respiration go on both day and night, while photosynthesis can take place only during sunlight hours.

Therefore, there are times during the day when the oxygen levels in the pond can be very low, and oxygen may have to be added to the water. Oxygen can be added to the pond water by taking out some of the old water which is low in oxygen and adding new water.

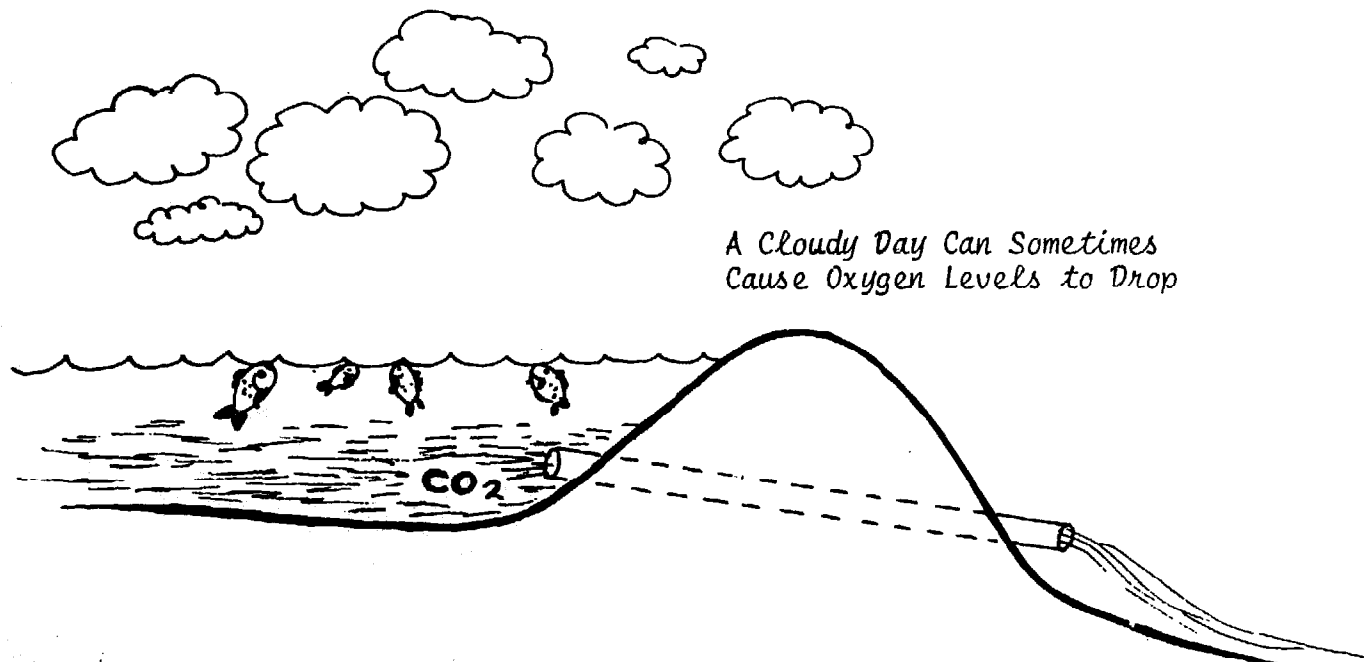

A Cloudy Day Can Sometimes Cause Oxygen Levels to Drop

The new water should be sprayed or bubbled into the pond so that the water picks up oxygen from the air as it falls into the pond.

Oxygen also can be added to pond water by:

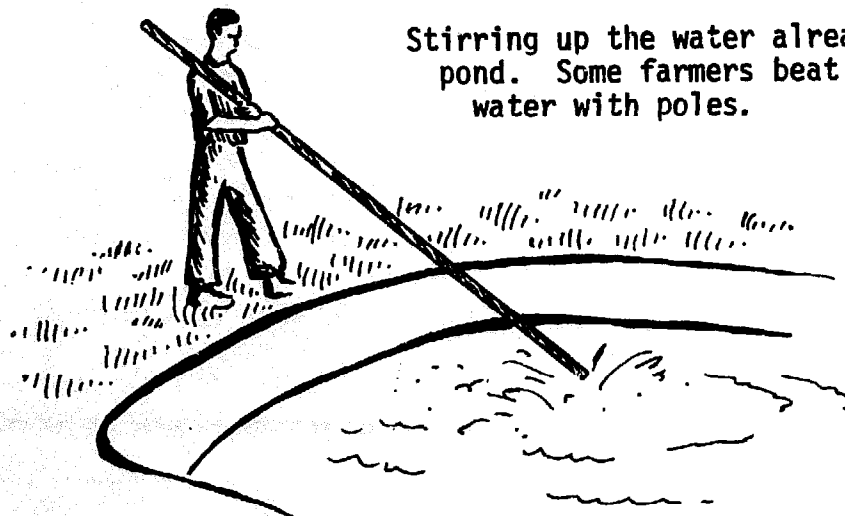

Stirring up the water already in the pond. Some farmers beat and stir the water with poles.

Some pond owners use oars to stir the water.



Other owners run small motors to bubble the water in the pond.

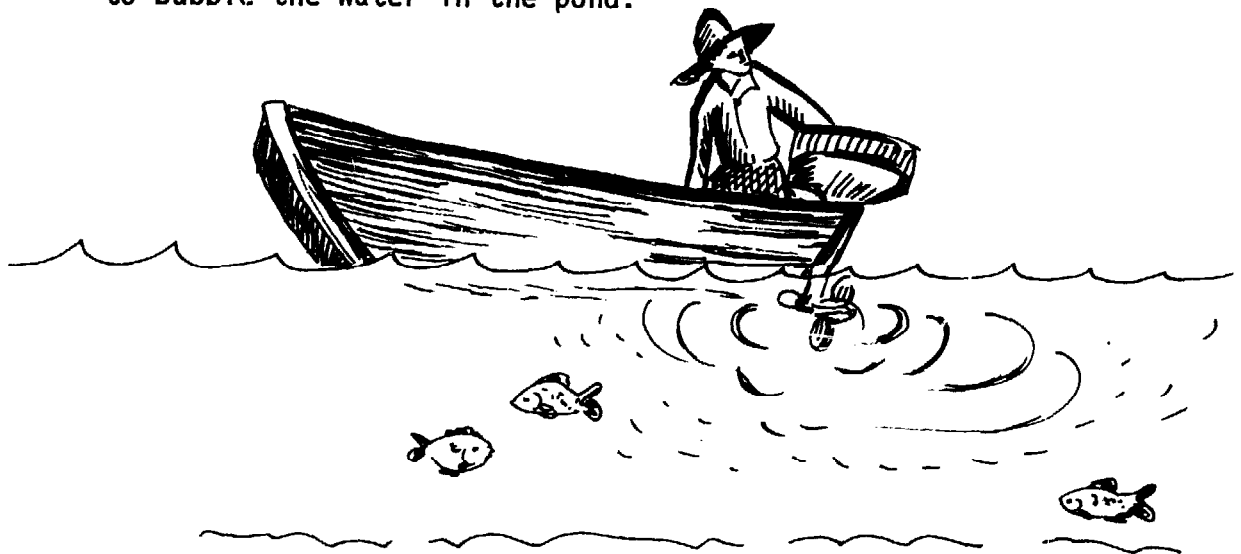

In addition, winds which are strong enough to ripple the surface of the water in the pond help the air and water to mix. Remember: any disturbance of the water made by man or by nature helps put oxygen into (aerates) the water.

Life under the water is a new idea to many farmers. And it is sometimes difficult to understand that the balances which exist on land are also present in the water. Oxygen is produced and used both above and below

the surface of the water. The fish pond does well only when oxygen production and oxygen use are in balanced relationship.

If the farmer understands the balance -- how oxygen is added and how it is used up, he will know how to watch for trouble before it happens. For example, if the color of the water changes from green to brown -- in a few hours or a day -- the phytoplankton are not producing enough oxygen. If the fish are at the

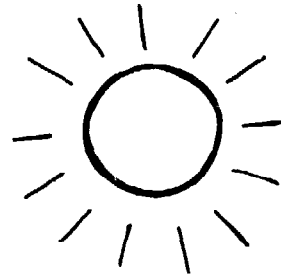

OXYGEN LEVELS RISE
DURING THE DAY AND
FALL AT NIGHT.

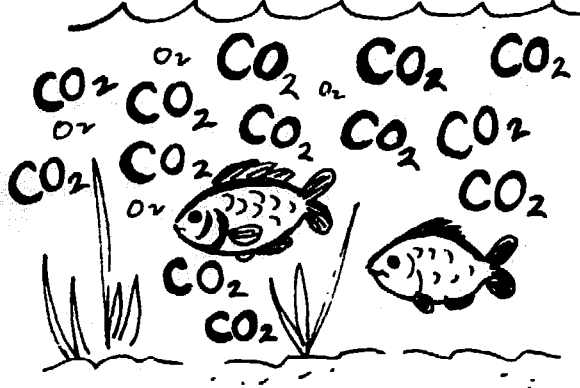
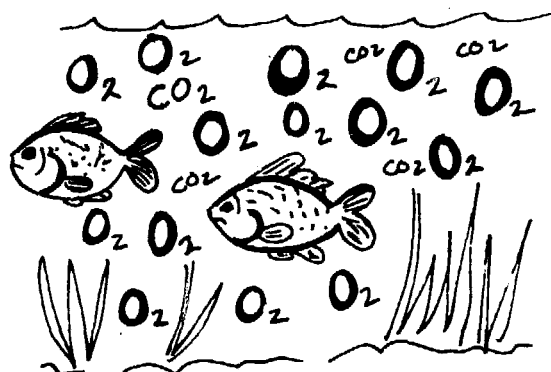

surface of the water and seem to be gulping air, they may need oxygen. Early in the morning, before the sun comes up, or a long period of no sunshine can be bad times because the phytoplankton need the sun to produce oxygen. Long periods of hot weather can create oxygen problems because the pond water gets warmer, and warm water cannot hold as much oxygen as cool water can.

The following table shows the difference in oxygen levels at various points in the day. For example, at 6 am, the temperature has remained steady, but the dissolved oxygen level has dropped to 6.3mg. At 6 pm, after a sunny day, the dissolved oxygen level is 16.3mg.

This table also shows that on a typical day a pond's temperature does not vary greatly. This illustrates why oxygen as a separate factor is much more important than is temperature.

OXYGEN CONTENT COMPARED WITH TEMPERATURE

<u>Time of Day</u>	<u>Temperature °C</u>	<u>Dissolved Oxygen, mg/l</u>
2 am	29	9.8
6 am	29	6.3
10 am	29	6.7
2 pm	30	9.4
6 pm	29	16.3
10 pm	29	10.7

Oxygen is measured in either milligrams per liter (mg/l) or parts per million (ppm). One milligram per liter of oxygen means that there is one milligram of oxygen dissolved in one liter of water. One part per million is approximately equivalent to one milligram per liter.

Fish begin to be stressed when the oxygen level falls below 4mg/l. For best growth, the oxygen levels should be above 5mg/l, but not more than 15mg/l. Above this level of oxygen, the condition of supersaturation results (too much oxygen).

Sometimes, if there is a lot of sun and a lot of wind activity at the same time, and if the temperature is low, the water can become supersaturated with oxygen. Supersaturated water has a dissolved oxygen content above 15ppm. This condition can also be a problem and place stress on fish. However, it does not happen very often in small ponds because the wind is not usually able to aerate pond water as thoroughly as it can in a large pond.

To determine the exact oxygen content of a pond, certain chemicals and equipment are needed. Dissolved oxygen is usually determined in the laboratory by the Winkler Method. Now, however, there are field kits available (Hach, LaMotte). These kits are, however, expensive, and certainly will not be available to most farmers.

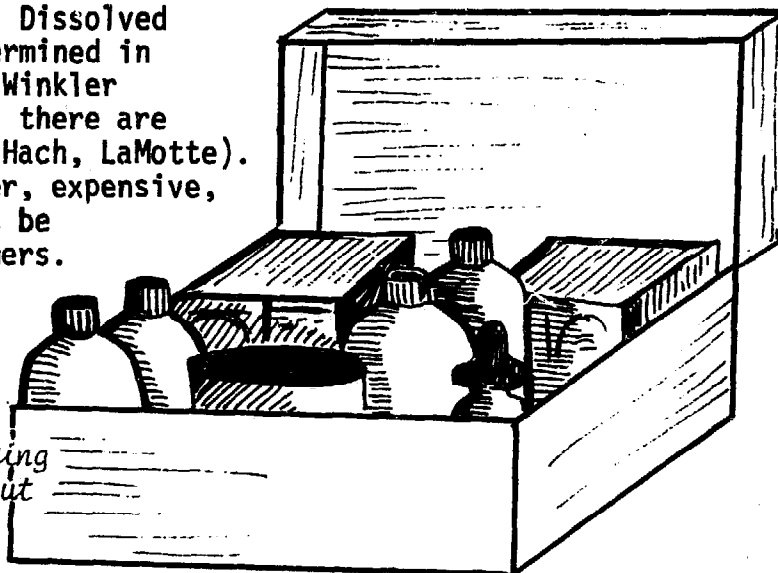

*A Field Kit for Testing
Pond Water Costs About
\$30 (U.S.)*

pH, HARDNESS, AND ALKALINITY

These three factors are not the same thing -- each one is a measure of a certain characteristic or characteristics of the water in a fish pond. Each of these factors can be measured exactly if samples of pond water can be taken to a laboratory to be analyzed, or if chemicals are available for testing the water in the field. Certainly if such testing is possible, it should be done.

However, many pond owners are not able to get their water tested and they do not have the right chemicals and equipment to do the tests themselves. For these people, it is best to stress the importance of using lime in their ponds. Lime is the proper treatment to correct imbalances in these factors, each of which is discussed in some detail here.

pH. pH is the measure of hydrogen ions (H^+) in the water and is measured on a scale of 1 to 14. If the pH is between 0 and 7, the water is considered to be acid. If the pH is at 7, the water is neutral (not acid or basic). A pH of 7 to 14 means the water is basic. Fish grow best in a pH of between 6.5 and 9.0. Fish are very sensitive to low pH, or, in other words, to water which is acid. Most pond fish will die if the pH falls below 4 for a very long period of time.

Sometimes the pH of a pond can change quickly. For example, a heavy rain may carry acid from the soil in the dikes into the pond water. The best way to get the pH back to neutral is to add limestone (calcium carbonate) to the water by spreading it on the pond bottom or on the surface of the water. A fish like tilapia can tolerate pH from 3.7 to 10.5, but below a pH of 5, they are stressed and they will not eat.

Some people measure pH by tasting the water. If the water tastes bitter or salty, it has too much acid in it. Another way to find out pH is to know where the water is coming from. If the water comes from a swamp, bog, or other place where the water is pretty stagnant and contains a lot of decaying material, it may be acid. Most water, however, has a pH which is very close to neutral. If the water comes from a river or lake, it is not likely to have a pH that will harm the fish. If the local fish do well in the water, the pond fish probably will do well also.

Litmus Paper. Some farm owners find out their pH by using litmus paper, or pH paper. These are thin strips of paper which have chemicals on them so that they change color when they are placed into the water. If the water is acid, the paper will turn one color; if the water is basic, the paper turns a different color. The color on the paper is compared to a color chart which will give the pH for that color. There are also electronic meters which measure pH, but these are expensive and not necessary in a field situation.

Hardness. Hardness is the measure of total soluble salts that are dissolved in the water. These salts, usually calcium (Ca^{++}) and magnesium (Mg^{++}), help the fish grow healthy bones and teeth. Also, the foods the fish eat, like the phytoplankton, need calcium and magnesium for growth. Water that contains many salts is called "hard" water; water that contains few salts is called "soft" water.

Hardness is related to the pH of the water, but unlike the pH, hardness stays constant throughout the day. Hardness can be measured in a laboratory or by using a field kit with chemicals. Hardness should be between 50 and 300ppm in the pond for best fish growth.

There are several ways a farmer can tell if he has very hard water without using chemicals. One method is to look closely at the pond walls where the water line is. If there is a white line on the wall of the pond where the water was touching the pond before the water level fell, there are salts present in the water which have dried on the pond walls. This water probably has a lot of salts. Hardness is important to fish; the harder the water, the better.

Another way a farmer can tell if the water is hard is to wash his hands with it at the side of the pond. If the soap takes a long time to lather, and if the lather does not stay very long, the water is hard. If the water is soft and does not contain many salts, it lathers very easily and is hard to wash off.

If the water is too soft, the farmer can increase the hardness by adding lime to the water.

Alkalinity. Alkalinity is a measure of the acid-combining capacity of the water; or it is also called its buffering ability. Alkalinity measures the amounts of carbonates and bicarbonates in the water. These are materials which mix with acid in the water. The result of the mixing is that the acid is not as strong. Waters which have an alkalinity of 50 to 200ppm are the most productive for fish. Alkalinity, like pH and hardness, can be corrected and controlled by adding lime to the pond. The relationship among alkalinity, hardness, and pH can be summarized like this:

Low Alkalinity = Low pH = Low Hardness

REMEMBER: THESE THREE FACTORS ARE NOT THE SAME THING, BUT THEY ARE RELATED. IN FISH PONDS, ALL THREE CAN BE CONTROLLED BY ADDING LIME TO THE WATER.

TURBIDITY

Turbidity is the term for the suspended dirt and other particles in water. Turbidity can be a problem, especially in shallow ponds, if the dirt and particles prevent sunlight from reaching the plankton, so that the phytoplankton cannot produce oxygen. An operating pond can be turbid if there

are bottom feeders such as common carp stirring up the bottom mud. Or, turbidity can result from a water source which has a lot of silt in it.

Turbidity can be measured by just looking at the pond water. Or turbidity can be measured by using a device called the Secchi disc. The Secchi disc is also used to determine the total productivity of the pond.

A SECCHI DISC

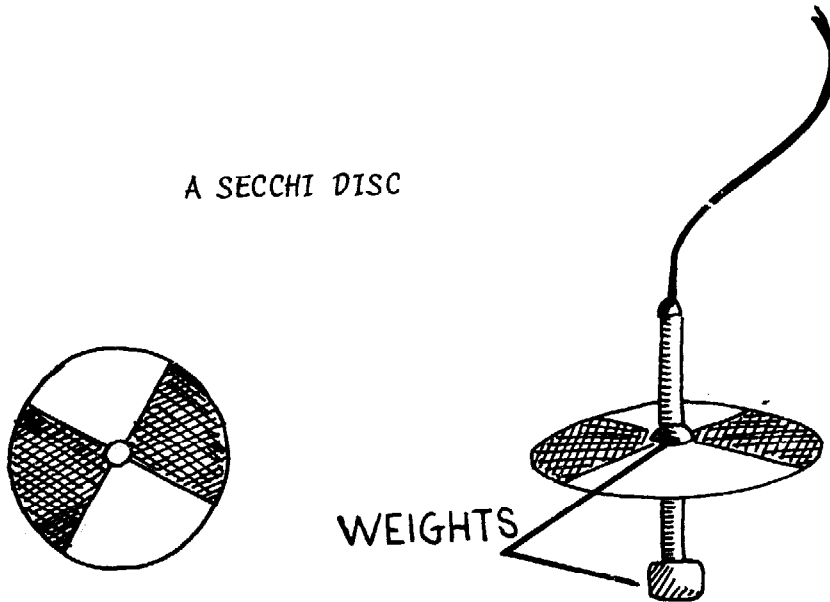

A Secchi disc is about 30cm in diameter, painted white and black or just white, and has weights or heavy objects hanging on it to make it sink straight down into the water. The disc is suspended on a rope or a long piece of wire that is marked off in centimeters from the disc up. A Secchi disc can be made out of wood or metal -- as long as it will sink. The disc does not have to be very complicated. It does not have to be round, either. It can be any shape, as long as it has some white paint on it to help it be seen under the water. The disc can be made from a tin can pounded for this purpose.

When the Secchi disc goes into the water, it will sink straight down and disappear from sight at some depth. If the disc disappears at 30cm in depth, the pond is not turbid. If it disappears immediately, either it is very turbid (brown in color), or it is very fertile (productive), if green in color.

