

AT MICROFICHE
REFERENCE
LIBRARY

A project of Volunteers in Asia

Crosscut Saw Manual

by Warren Miller

Published by:

US Department of Agriculture Equipment
Development Center
Missoula, Montana

Available from:

Superintendent of Documents
US Government Printing Office
Washington D.C. 20402
USA
(order Stock No. 001-001-00434-1)

Reproduced by permission.

Reproduction of this microfiche document in any
form is subject to the same restrictions as those
of the original document.



Crosscut Saw Manual

About the author

Warren Miller is a Forest Service wilderness ranger on the Moose Creek Ranger District, Nezperce National Forest in Idaho. Crosscut saws have been a professional interest and hobby of his for a number of years. He prepared this manual while on detail to the Equipment Development Center at Missoula, Mont.

Crosscut Saw Manual

By Warren Miller

June 1978

Forest Service
U. S. Department of Agriculture
Equipment Development Center
Missoula, Montana



Photo courtesy of Culver Pictures, New York, N. Y.

For sale by the Superintendent of Documents, U. S.
Government Printing Office, Washington, D. C. 20402
Stock No. 001-001-00434-1

This publication was first issued in June 1977 as Missoula
Equipment Development Center report 7771 2508

Acknowledgments

This manual would never have been possible without the willing and patient teaching of Martin Winters, accomplished filer from the days when the crosscut saw reigned.

Also special thanks to Clem Pope, friend and coworker with a mutual interest in crosscuts, and William Harlow, professor emeritus of wood technology, State University of New York, for their many helpful comments and contributions to the text.

There are persons too numerous to name here who contributed knowingly and unknowingly to this manual: sawyers, filers, and others, all of whom have something in common, knowledge about the crosscut saw and a willingness to share that knowledge. To these important individuals I give my appreciation.

Finally, my thanks to staff members of the Equipment Development Center at Missoula for their suggestions during the preparation of this manual.

The use of trade, firm, or corporation names in this publication is for the information and convenience of the reader. It does not constitute an official endorsement or approval by the U.S. Department of Agriculture of any product or service to the exclusion of others that may be suitable.

Contents

	Page
GLOSSARY	v
INTRODUCTION	1
THE CROSSCUT SAW	2
HOW A SAW CUTS.	5
SAW VISE.	6
FILING THE SAW	8
Cleaning the Saw.	8
Hammering or Straightening	9
Jointing the Saw	10
<i>Short Jointer</i>	10
<i>Long Jointer</i>	11
Raker Fitting.	12
<i>Fitting Straight Rakers</i>	14
<i>Fitting Swaged Rakers.</i>	15
<i>Repairing Bent Rakers and Cutter Teeth</i>	17
<i>Broken Raker Tip</i>	17
Pointing Up Cutter Teeth	17
Setting.	19
TESTING A SAW	23
CHOOSING AND USING A SAW.	24
HANDLE POSITIONS	26
STORING SAWS.	26
FINDING SAWS AND TOOLS.	27

Glossary

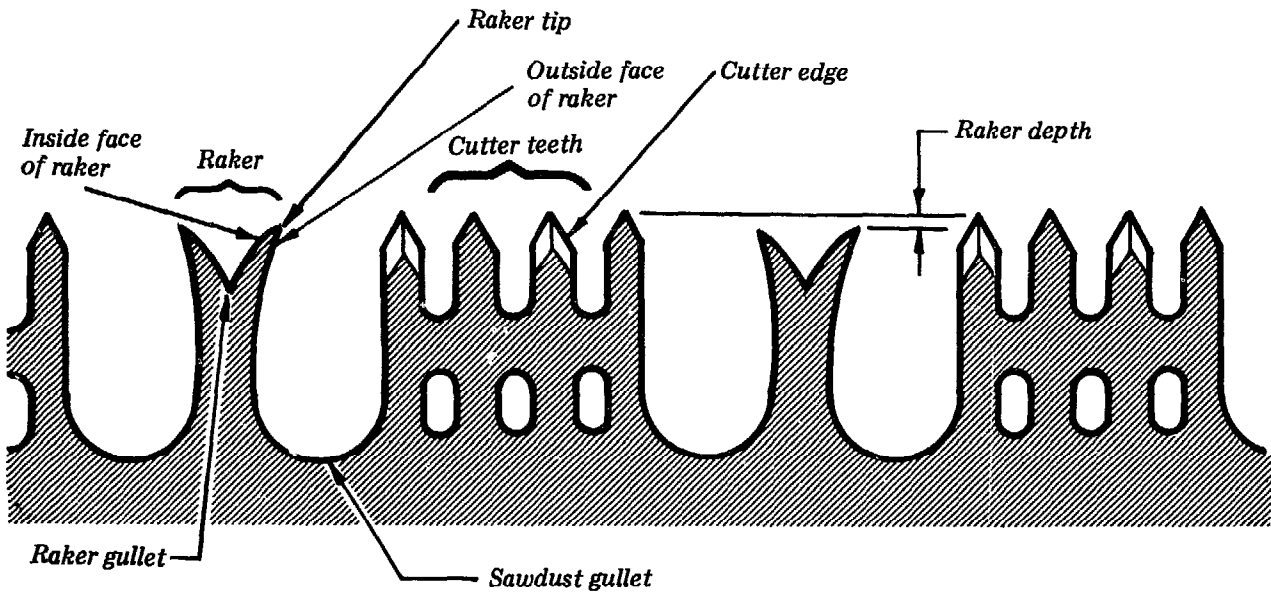
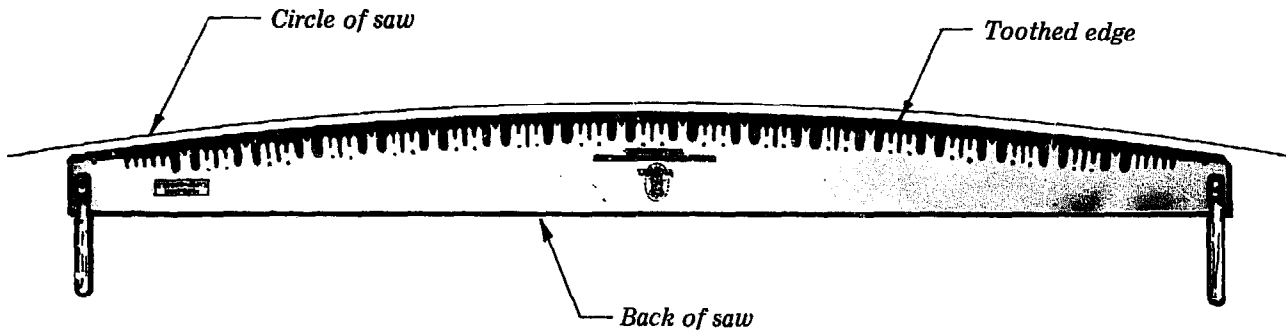

PARTS OF A CROSSCUT SAW

Back of Saw. The edge opposite the toothed edge.

Bevel. The bevel of a cutting tooth is the angle the intersection of the two filed surfaces makes with the plane perpendicular to the plane of the saw.

Circle of Saw. The toothed edge of most crosscut saws lies on the arc of a circle.

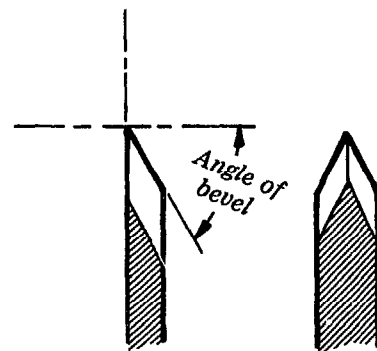

Clearance Angle. The angle the inside face of the raker tip makes with the direction of saw travel.

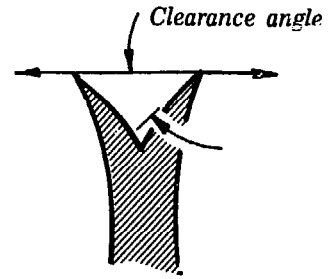

Cutter Tooth. The tooth that scores the wood on each side of the kerf.

Inside Face. Face of a cutting raker tip that faces the raker gullet.

Jointer. Tool used to file the cutter teeth so the tips all lie on the circle of the saw.

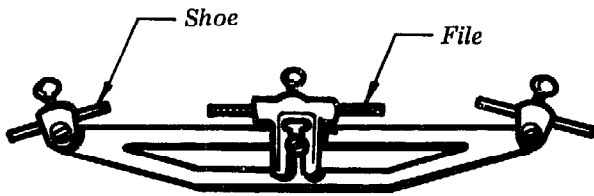

Atkins jointer.



Gibbs jointer.

Kerf. Slot the saw makes while cutting.

Outside Face. The face of a cutting raker tip that faces the saw-dust gullet.

Pin Gage. Gage used to determine when the raker has been swaged to the desired depth.

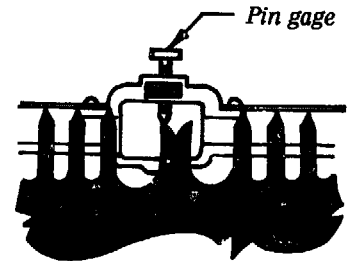

Plane of Saw. The plane that passes through the saw equidistant from both sides of the saw.

Rake Angle. Angle that the outside face of a raker tip makes with the line perpendicular to the tangent of the saw circle.

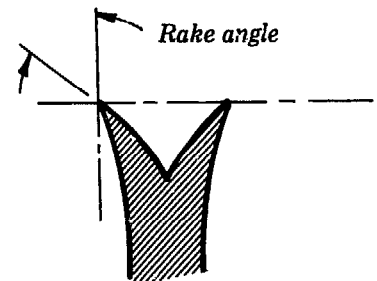

Raker. The tooth on a crosscut that clears the shavings from a kerf.

Raker Gage. Used to gage the final raker depth.

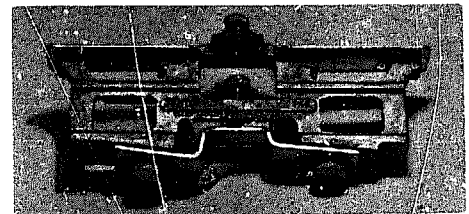

Typical raker gage.

Raker Depth. The difference in height between raker and cutter teeth.

Raker Gullet. The "V" notch in a raker tooth.

Raker Face. See outside and inside face.

Raker Tip. Supports the cutting edge of a raker.

Sawdust Gullet. The gullet between a raker and a cutter tooth.

Set. The distance by which the tip of a cutter tooth is bent away from the plane of the saw.

Set Anvil. A block of metal over which the tip of a cutter tooth is bent when setting.

Set Stake. A tool used as an anvil for hammer setting the cutter teeth.

Spider. A gage used to determine when the set is correct.

Swaging. Putting a curve in the outside face of a raker tip, generally by hammering on the inside face.

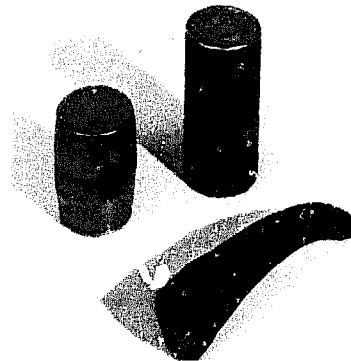
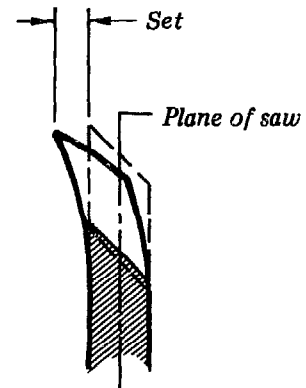

Several types of set anvils.

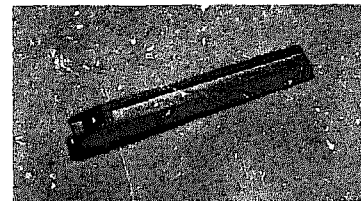

Set stake.

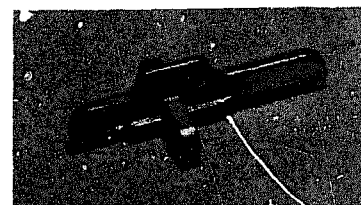

Spider.

The Crosscut Saw

The two-man crosscut saw was evidently known by the Romans though little used by them. It wasn't until the middle of the 15th century that the crosscut saw came into fairly common use in Europe. Records exist of the crosscut being used for cutting logs in the United States between 1635 and 1681. About 1880, Pennsylvania lumbermen began felling trees with the crosscut. Before that time all trees had been ax-felled and crosscut into lengths.

Until the 15th century, the two-man crosscut saw was of a *plain* tooth pattern. The *M* tooth pattern seems to have been developed and used in south Germany in the 1400's. Even as late as 1900 most of the European

crosscuts still used the *plain* tooth pattern with a few exceptions of *M* tooth being used. Not until fairly recently was the saw with a raker or "drag" developed.

In the case of *plain*, *M*, and *Great American* tooth patterns, each tooth both cuts the wood and clears out the shavings. In the case of the *champion*, *lance*, and *perforated lance* tooth, however, cutter teeth cut the wood fibers and the rakers remove the scored wood from the cut.

By the time crosscut use was at its peak, a large number of tooth patterns had been developed, each presumably suited to a particular set of conditions.

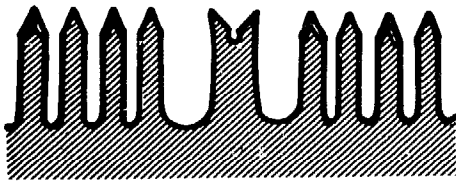

Lance Tooth

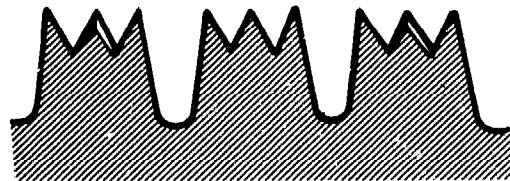

Great American

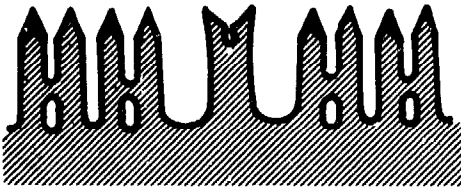

Perforated Lance Tooth

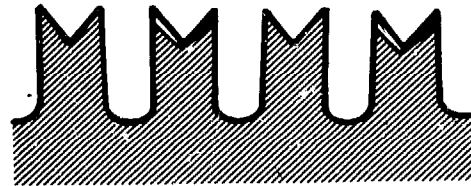

M Tooth

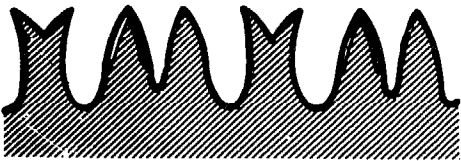

Champion Tooth

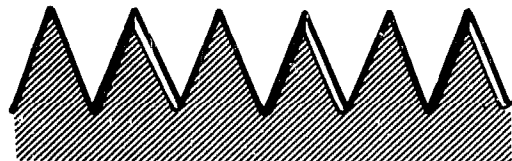

Plain Tooth

Introduction

Many readers undoubtedly have run crosscut saws in the past; and a lot of you know the difference between a good running saw and a poorly filed one. A poorly filed saw deserves the name I have often heard attributed to it, "misery whip." A well-filed saw, however, is efficient and can be satisfying to use. Only in recent years was a chain saw developed that could beat a topnotch buckler in contest. There is a record of a 32-inch Douglas-fir log cut in 1 minute 26-2/5 seconds by one buckler.

Saw filers of any quality are becoming very difficult if not impossible to find. This manual was written so those of you who use

crosscut saws can maintain them yourselves and overcome some of the misery of that ol' whip.

The manual provides a basic description of how and why a crosscut saw works, tips on building a saw vise, and some experience-tested methods as a guide for achieving a well-running saw.

Only saws having raker teeth are discussed because they are by far the most common saws found today. This includes lance tooth, perforated lance tooth, and champion tooth patterns.

Saws can be divided into two types: two-man and one-man. Generally speaking, a one-man saw is shorter, but its defining characteristic is that it is asymmetric. Both one- and two-man crosscuts can be used by either one or two persons.



One-man saw.

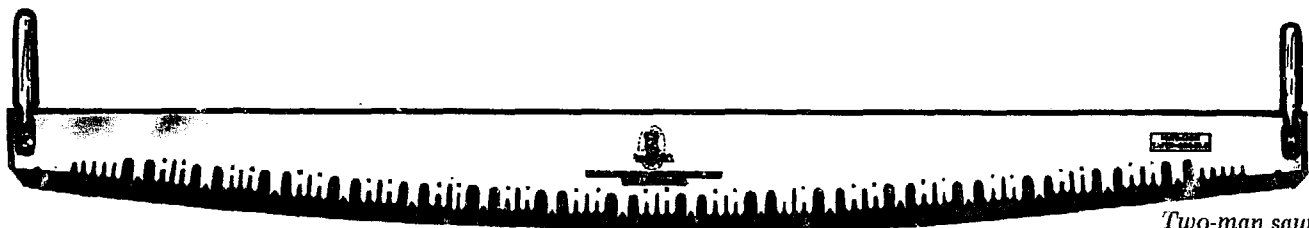

Two-man saw.

At one time, one-man crosscuts were made in lengths from 3 to 6 feet. Two-man saws were made in lengths from 4 to 12 feet for the Pacific Northwest, and 16 feet for the California redwoods. If a longer saw were needed, two shorter saws were sometimes brazed together.

There are two basic saw patterns for the two-man saw: the felling pattern for felling trees and the bucking pattern for cutting up trees once they are on the ground. Each has characteristics suited to its use.

The *felling saw* has a concave back and is relatively light and flexible. It is light so

less effort is needed to move it back and forth when felling a tree. It is flexible to conform to the arc a sawyer's arms take when sawing, and it is narrow tooth-to-back enabling the sawyer to place a wedge in the cut behind the saw sooner than with a wide saw.

The *bucking saw* has a straight back; it is much thicker tooth-to-back than the felling saw, so it is heavier and stiffer. A bucking saw traditionally is run by one person, so it is a fairly stiff saw to help prevent buckling on the push stroke. The more weight put on a saw, the faster it will cut, so the weight of a bucking saw is an asset.

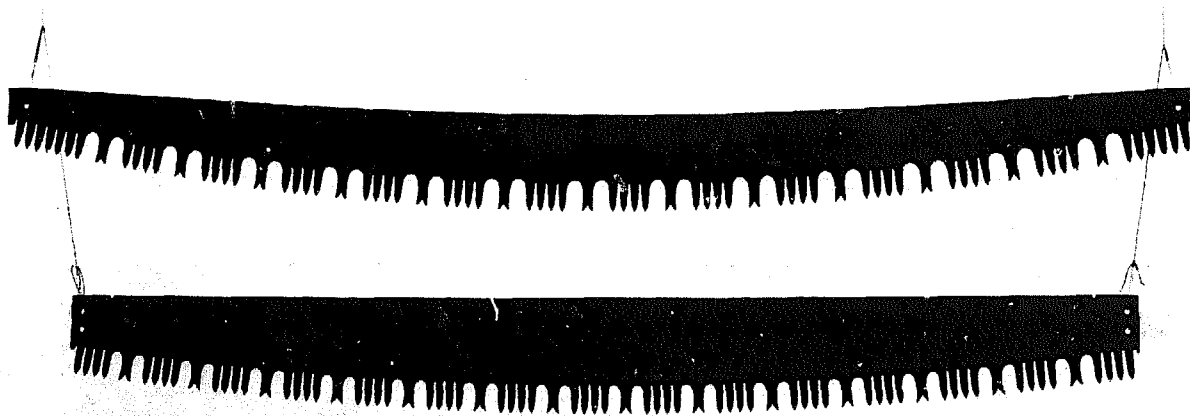

Felling saw and bucking saw.

The points of the teeth of nearly all crosscut saws lie on the arc of a circle. This results in an easier and faster cutting saw than a straight saw. A circular contour is much simpler to maintain than a contour of any other shape (except straight).

There are three ways that the sides of a saw are finished (ground) when manufactured; each affects the thickness of the saw in a particular way. These are: *flat*, *straight taper*, and *crescent taper*.

A *flat* ground saw is one whose thickness is everywhere the same. *Straight taper* ground saws and *crescent taper* ground saws are ground to a configuration indicated below. A taper ground saw has an advantage over a flat ground saw: It is not as likely to bind in a cut, especially if the kerf is closing behind the saw as will happen if the wood being cut is under compression. Another

advantage is that a taper ground saw requires less set than a flat ground saw.

The difference between the *straight taper* and *crescent taper* is that the lines of equi-thickness for the straight taper ground saw are straight and those for the crescent taper ground saw are concentric to the circle of the saw. This means that the teeth of the crescent taper ground saw are all the same thickness; whereas the teeth of the straight taper ground saw are thicker toward the center of the saw.

The uniform tooth thickness of the crescent taper ground saw is an obvious advantage over the varying tooth thickness of the straight taper ground saw. Therefore, the best saws are *crescent taper* ground. Trade-marks indicating crescent taper ground saws are "Crescent Ground," "Precision Ground," "Segment Ground," and "Arc Ground."

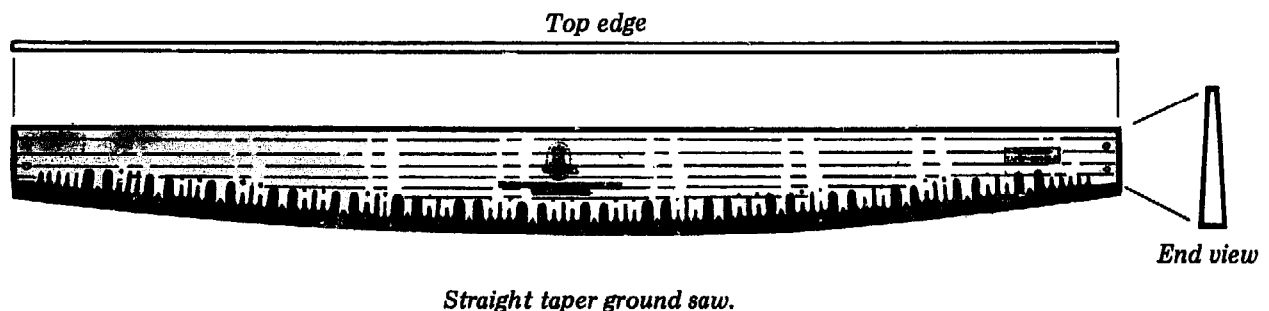
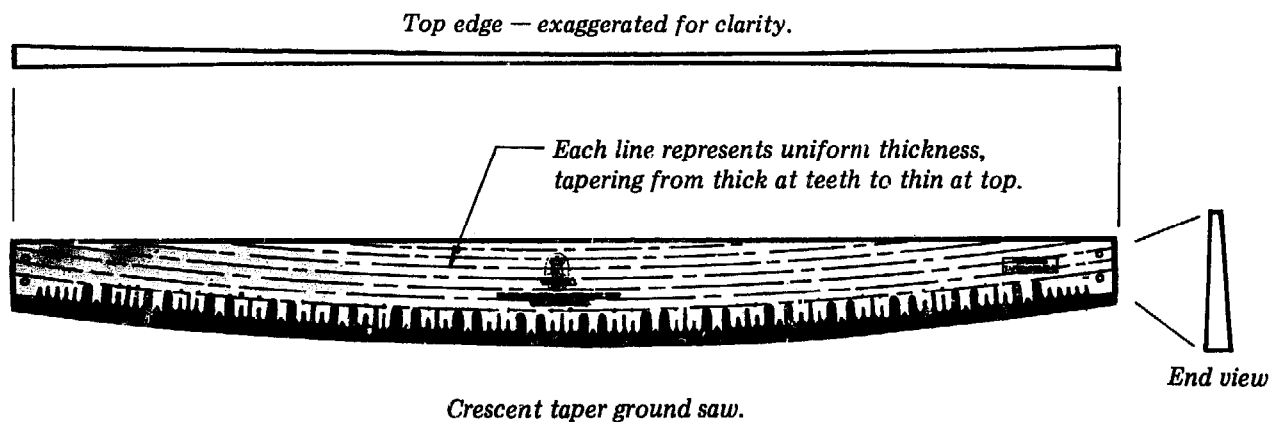

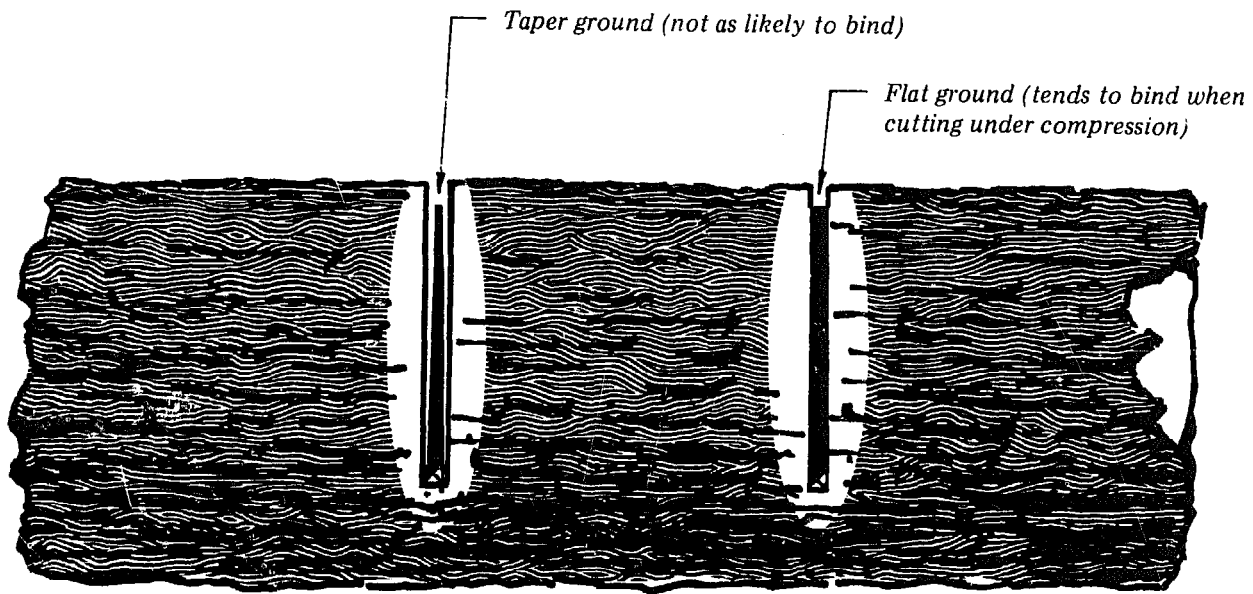

How a Saw Cuts

The cutting teeth of a crosscut saw sever the fibers on each side of the kerf. The raker teeth, cutting like a plane bit, peel the cut fibers and collect them in the sawdust gullets between the cutting teeth and the raker teeth and carry them out of the cut. A properly sharpened crosscut saw cuts deep and makes thick shavings. For large timber, where the amount of shavings accumulated per stroke is considerable, a large gullet is necessary to carry out the shavings to prevent the saw from binding.

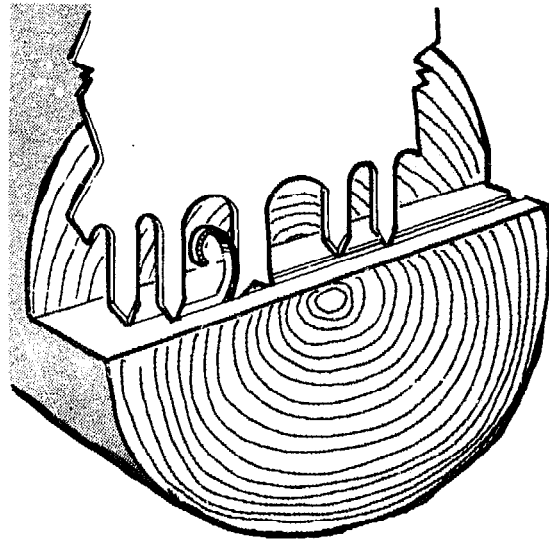

Saw Vice

When possible, a saw should be filed in a saw vise. A vise helps a filer do a good job.

The essential qualities of a vise are a *flat* surface against which a saw can be rigidly held in such a position that the teeth can be conveniently worked on.

A carpenter's handsaw vise can be used if only a few saws are sharpened, but a vise especially built for crosscut saws is best.

One way of making a vise is to use a straight, clear board, 3 by 8 inches or 3 by 10 inches, which has one edge shaped to fit the curve of a saw. If you can't obtain these sizes, two 2- by 8-inch or 2- by 10-inch boards can be glued and bolted or screwed together. Take care to assure that the surface remains flat. You can use a single 2- by 8-inch or 2- by 10-inch board, but I don't recommend this because of the lack of rigidity. The saw is held against the board with hardwood strips about 1-1/2 inches wide, 1/4- to 3/8-inch thick, and 6 to 8 inches long. Fasten the strips to the board at positions coinciding with every other raker tooth. Fasten each strip with bolts or screws. The ends of the strips should not project beyond the curved edge of the board. On each bolt or screw install a washer as thick as the saw blade between the strip and board so the strips tighten snugly against the saw blade and hold the saw firmly against the board.

The saw should fit the vise so that the teeth project above the curved edge of the board far enough so they can be filed without the file touching the vise.

Another method of making a vise is to use two shaped 2 by 8's or 2 by 10's and clamp the saw between them. Several bolts and wingnuts through the bottom part of the vise can be used to clamp the saw between the two boards.

Mount the vise so it will rotate around its long axis. This allows the filer to change the saw from the vertical where most of the operations are done, to an oblique angle where the cutter teeth are filed or "pointed up."

To mount the vise in this way, insert a piece of threaded rod (say 5/8 inch) into each end of the vise and glue or pin it securely, leaving 4 to 6 inches sticking out. Then position the vise so threaded rods are between uprights of bench brackets that hold the vise a couple of inches above elbow height (or what is comfortable for the filer). Wingnuts tightened on the rod ends hold the vise securely.

The vise can also be mounted with hinges directly to a workbench so it can be tilted back for the "pointing up" operation. Several stops behind the vise hold it firmly at the desired angle.

1

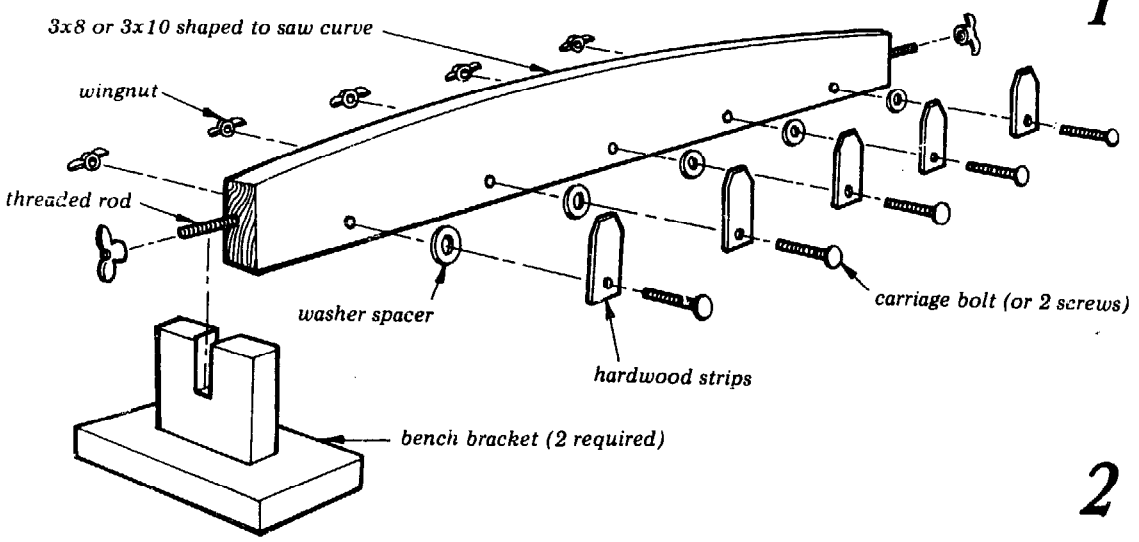

2

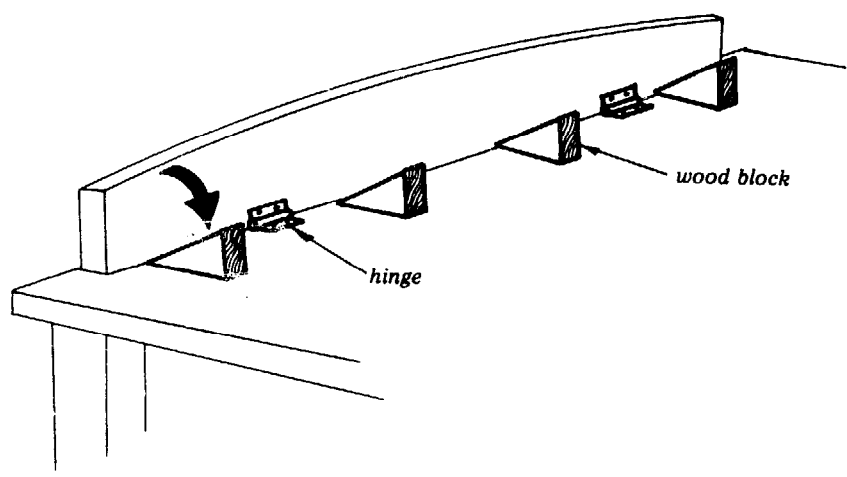
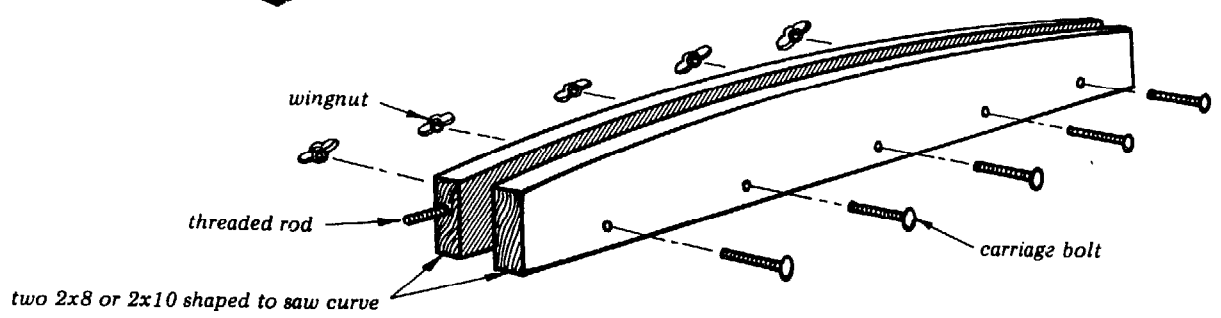

SAW VISES

Filing the Saw

Opinions vary among saw filers on the order of steps followed in filing a saw. Guidelines offered by saw companies differ significantly. After examining the reasons for the different orders, I've concluded the following order is preferable.

Cleaning — removing rust or pitch.

Hammering — straightening a saw if it has bumps, kinks, or twists in it.

Jointing — the means by which the tips of all the cutter teeth on the saw are made to conform to the circle of the saw.

Raker fitting — includes shaping the raker gullet and swaging and sharpening the raker.

Pointing up cutter teeth — filing the teeth sharp.

Setting — bending the tips of the cutter teeth away from the plane of the saw, causing the kerf to be wider than the saw.

Tools necessary for:

Hammering — two steel straightedges about 10 to 14 inches long; a 3- to 4-pound cross-pein saw hammer (some manufacturers call them cross-face hammers), and a fairly flat anvil. Hammers and straightedges are available from R. Hoe & Co., Portland, Oreg., and Hanchett Manufacturing Co., Salem, Oreg.;

straightedges are also sold by Disston, Inc., Seattle, Wash., and Simonds Cutting Tools, Portland.

Jointing — jointer (short or long), 7- or 8-inch special crosscut file (mill bastard blunt file), saw vise.

Raker fitting — 7- or 8-inch slim taper (triangular) file, pin gage, raker gage, hammer for swaging (8- to 16-ounce tinner's riveting hammer), 6-inch slim taper file with "safe" corners (corners ground smooth), 6-inch mill bastard file, saw vise.

Pointing up cutter teeth — 7- or 8-inch special crosscut file (mill bastard blunt file) for lance tooth saws, 6- or 8-inch Great American crosscut file for champion tooth saws, saw vise.

Setting — 8-ounce set hammer (or tinner's riveting hammer), setting stake or set tool or anvil and spider; saw vise.

CLEANING THE SAW

Often a filer must clean a rusty or pitchy saw. One good method is to lay the saw on a flat surface and clean with an ax stone or a pumice grill stone. Liberally douse the saw with kerosene or diesel oil to cut pitch and keep the stone from plugging up with debris. Small kinks show up as bright areas for high spots and dark areas for low spots. Use only enough pressure on the cutter teeth to clean them; if metal is taken off the tips, both set and tooth length will be affected.

HAMMERING OR STRAIGHTENING

Few saws are completely straight. Although slight kinks or bumps will not cause much trouble, a straight saw requires minimum set and is less likely to buckle during the push stroke when one person is sawing. And it will cut straighter.

The saw to be straightened is hung vertically from one of the handle holes.

Hold the straightedges lightly — one on each side of the saw — so they are directly opposite each other. By moving the straightedges back and forth as well as along the saw any kinks or bumps can be found. If you move the straightedges with a slight twisting motion, quite small kinks can be found by the difference in resistance to twisting the straightedges. A straightedge contacting the convex side of a kink will twist easier than one on the concave side.

When a kink is located, determine its shape and axis by moving the straightedges over its surface. Mark its shape with chalk or grease pencil (a wetted finger works well too); put the concave side down flat on the anvil and with the appropriate face of your cross-pein hammer strike the saw several times over the kink. (The appropriate face is the one that is fairly parallel to the kink axis). Check with straightedges and determine further action. Take care to strike the saw with the face of the hammer and not the edge. If done properly the hammer should leave no visible mark. A slightly round-faced, 3-pound hammer can be used but results aren't as good as with a cross-pein hammer.

If it is not possible to acquire a straightedge specifically for saw work, acceptable substitutes exist. The characteristics of a desirable straightedge are that it be light, stiff, and reasonably straight. A thickness from 0.050 to 0.100 inch is acceptable with the thinner dimension being desirable. Possible substitutes might be draftsman's straightedges, machinist's straightedges, or the rule from a combination square.

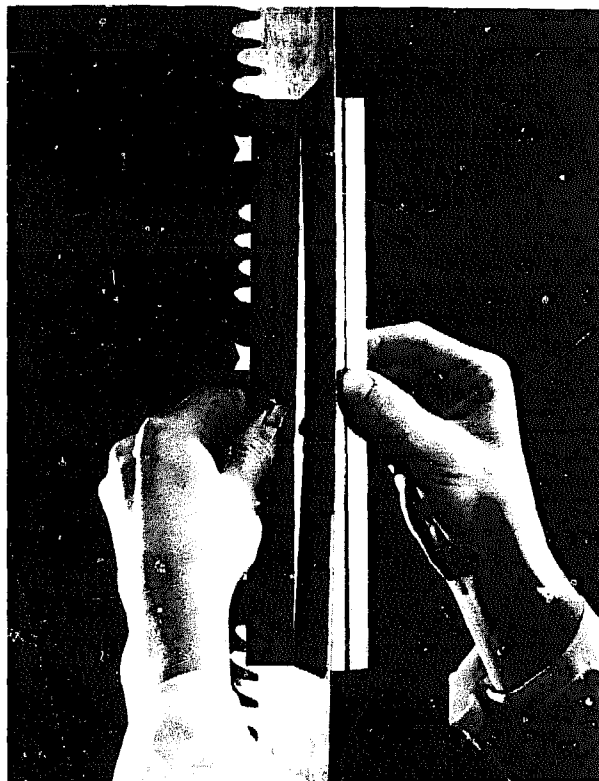

Locating kinks with two straightedges.

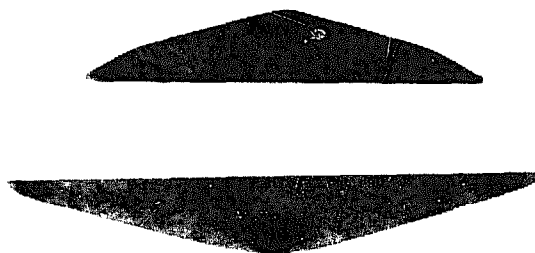

Examples of saw maker's straightedges.

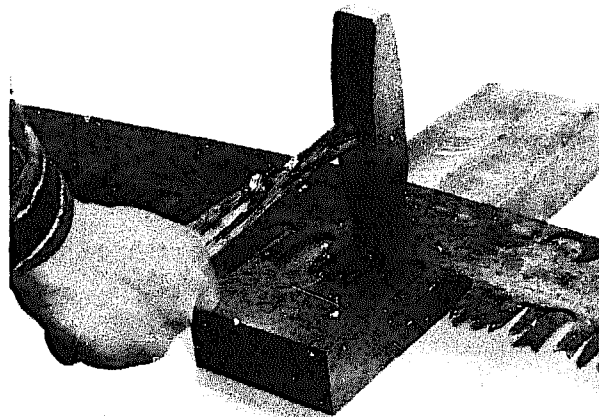

Hammering out kink.

JOINTING THE SAW

The number and variety of jointers are considerable, but the principle is the same for all. They hold a file in such a way that it can be run over the saw teeth to insure they all lie on the circle of the saw. There are short and long jointers. The short jointer, generally part of a combination saw tool, is by far the more common.

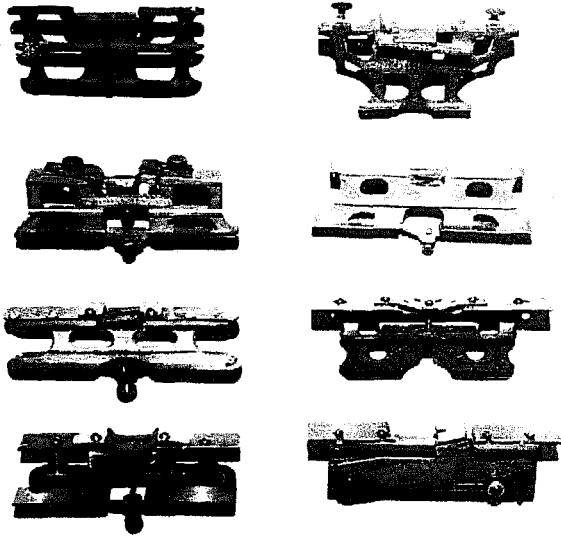

Examples of combination saw tools.

Short Jointer

To use the short jointer, insert the file so it rests *flat* on the file supports (lugs) and adjust the screw so the file bends to conform to the circle of the saw. Make sure the surface of the file is square with the guide rails on the body of the jointer. The file may be warped or improperly seated on the supports. Insert the file so it runs in the normal filing direction. (If a file is used backwards, its life will be severely shortened.) Because a new file often will cut faster than desired, a worn-

out 7- or 8-inch special crosscut file with the tang broken off works well.

Place the jointer on one end of the saw. Holding the jointer so the file rests on the cutter teeth, run the jointer the length of the saw using uniform downward pressure. This is important if the circle of the saw is to be maintained. It is also important to hold the guide rails on the body of the jointer in contact with the side of the saw at all times to assure that the file is square to the saw.

After the jointer has been run the length of the saw, look at the teeth. If each tip has a shiny spot where the file has just touched it, jointing is complete. If some teeth are so short they weren't touched, repeat the process until all teeth show the mark of the file. If a tooth has been chipped or broken so it is much shorter than the rest, don't worry about it. No sense jointing the life out of a saw to make it perfect.

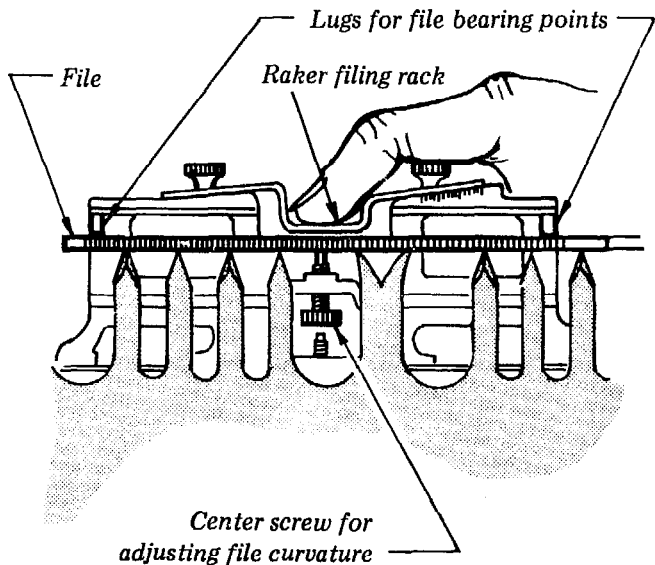

Jointing the cutter teeth.

Long Jointer

If a long jointer is available, use it. It achieves superior results and guarantees a round saw if properly used. A saw that has deviations from its circle (bumps or troughs) won't run smoothly.

The long jointer operates on the principle that three points in a plane uniquely define a circle, or there is only one circle that will simultaneously pass through three given points in a plane.

The long jointer consists of two shoes about 12 inches apart with a file mounted between them. The file can be moved up and down relative to the two shoes. Whether the shoes or file moves is immaterial. The two shoes and the file constitute the three points necessary to define a circle. Only two long jointers were ever commercially manufactured. One, a Gibbs jointer, was marketed by Simonds Saw and Steel Co. and the other by E. C. Atkins and Co. The shoes on the Gibbs jointer move and the file on the Atkins moves.

As with the short jointer, it is a good idea to make sure the file is square with the guide rails on the body of the jointer. This can be checked with a small square.

With the saw in a stable position, preferably in a saw vise, place the jointer approximately in the center of the saw. Adjust the jointer so that both shoes and the file contact the

saw and tighten the adjusting nuts. By moving the jointer along the saw and observing whether the jointer rocks on the file or has space between the file and the teeth, the high and low places easily can be observed. When the high and low spots are found, adjust the jointer so the file clears all but the higher spots. This is done by placing the jointer on a high spot and adjusting it so file and shoes will contact the saw.

These are important steps. If the initial jointer adjustment were made with the file over a relatively low spot and the saw jointed with that setting, it would be impossible to get the saw into round without taking excess material off the center teeth.

With the jointer adjusted and placed on the saw, pass it lightly and evenly from one end of the saw to the other. The very end teeth also should be jointed in this process. This will mean dropping one shoe or the other off the end of the saw to run the file over the end teeth. The file will cut the tips off the high teeth. If, as is often the case with really worn saws, the file will not make contact toward the end of the saw, the end teeth are too long. This can be corrected by jointing the ends more severely than the center of the saw. If the teeth are particularly long, a lot of time can be saved by cutting these teeth down with a hand-held file, checking your progress periodically with the jointer.

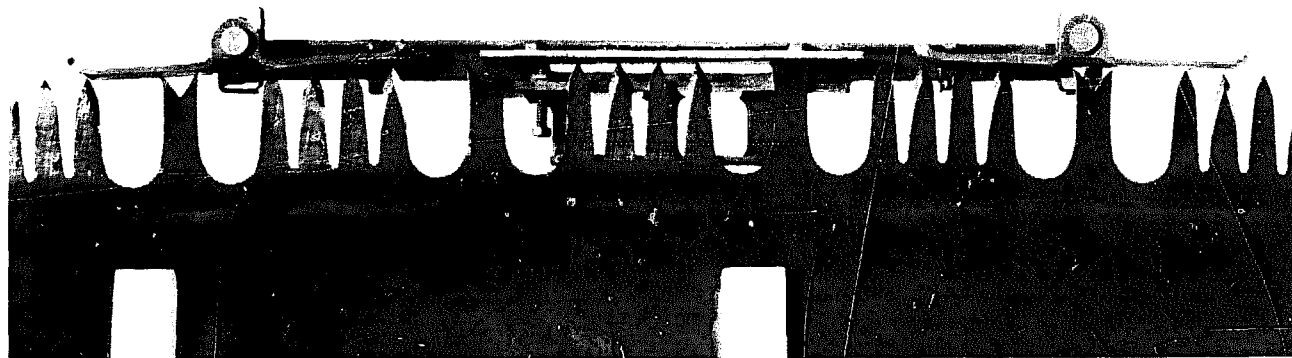

Jointing a saw with a long jointer.

As with the short jointer, the saw should only be jointed until all the teeth have been marked by the file (except extremely short or broken teeth). The less metal taken off the teeth, the less work the filer must do later in pointing up the teeth, and the longer the saw will last.

The end teeth of a solid ended saw cannot be effectively jointed with a long jointer unless the solid section is filed to or below the circle of the saw.

It is possible to cut the solid end off a saw and repunch the holes for the handles.

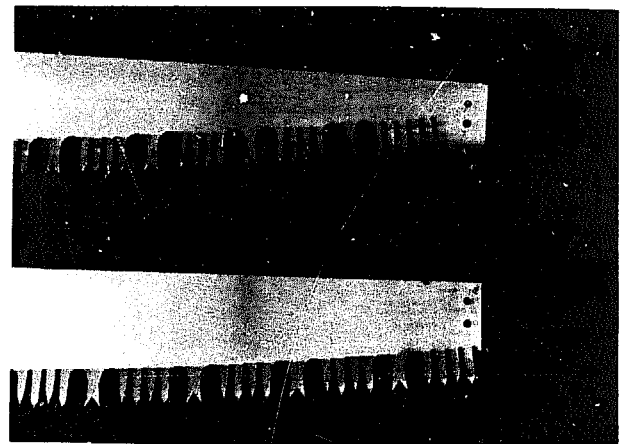

Modifying saw for jointing.

RAKER FITTING

The raker teeth remove shavings that the cutter teeth have severed from the wood. For a saw to operate efficiently the raker must remove all the wood severed by the cutter teeth, but no more. If too little wood is removed (too short a raker), energy will be wasted because of unnecessary friction between the cutter teeth and unremoved wood. If too much wood is removed (rakers too long), it is necessary for the raker to break the uncut fibers along the edge of the chip, resulting in wasted energy and a "whiskered" shaving.

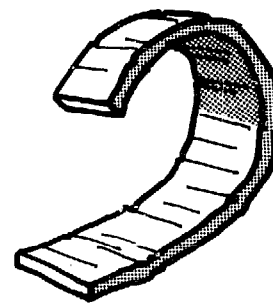

Good shaving.

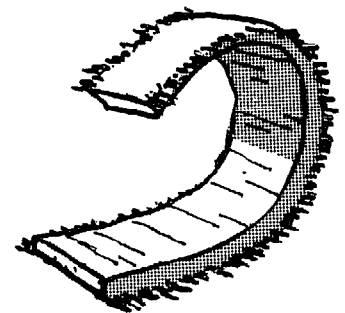

"Whiskered" shaving.

Because the cutting teeth exert pressure on the wood as they cut, a certain thickness of wood is compressed and springs back after the teeth pass over. As a result, fibers are not severed quite as deeply as the teeth penetrate. Consequently, the rakers following the cutter teeth must be shorter by the amount the wood springs back, so no unsevered wood is removed. The amount of springback varies with wood type, moisture content, saw weight, and cutter tooth shape. Optimum raker depth depends on all these factors.

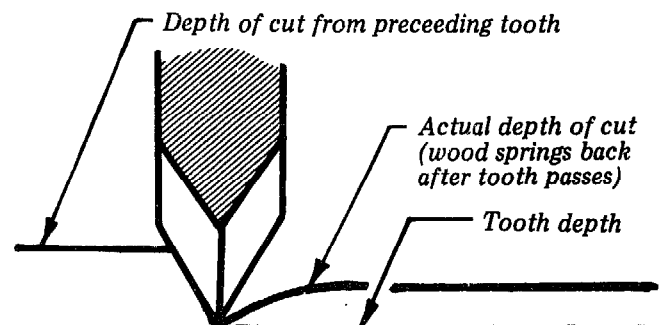

How a cutter tooth cuts.

Optimum depth is obtained by experiment, but figures vary from 0.008 inch for hard or dry wood to 0.030 inch for soft, springy wood; 0.012 inch is a good average figure to begin with.

The depth of the rakers below the cutter teeth is determined by using a tool called a raker gage or raker depth gage.

The raker depth gage is generally part of a combination saw filing tool of which numerous varieties were manufactured. The essential feature of all of them is a hardened steel filing plate with a slot cut in it a little wider than the thickness of a saw and a little longer than the distance between the two tips on a raker. This is held on a frame in such a way that when the gage is placed over the raker, the top of the filing plate is the same level as the desired raker depth. The raker tips are cut to the level of the plate with a file. The height of the filing plate is adjustable.

Adjustment of the depth gage is straight forward. In the simpler gages, such as the common Morin gage, two screws hold the filing plate to the frame, and the adjustment is made by putting pieces of paper between the frame and the filing plate. In the Simonds precision saw tool, the adjustment is made by sliding the filing plate up and down two ramps. A scale on the side of one of the ramps indicates the depth of the top of the filing plate. Each division of the scale corresponds to 0.004 inch difference in the height of the filing plate. A notch in the filing plate opposite the scale indicates the desired raker depth. In the Anderson gage, the adjustment is made by moving the plate up and down with a screw. With the Anderson gage, only minor adjustments should be made using the screw. Large deviations could break the brittle filing plate. Paper between the filing plate and the tool frame can be used for large adjustments. The Anderson gage is the only known

gage with a sloped filing plate. Instead of filing the raker tip off flat, it establishes a 15-degree clearance angle.

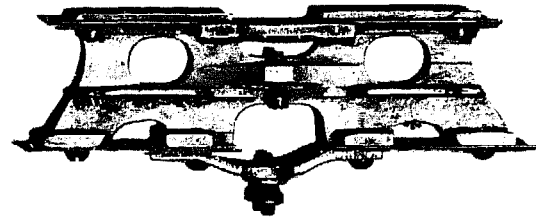

Morin raker gage.

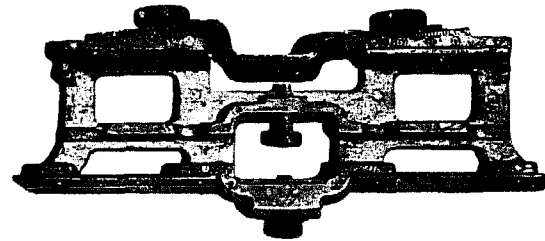

Simonds precision saw tool.

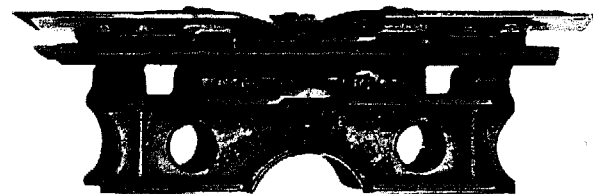

Anderson raker gage.

One way of checking the setting of a raker gage is to file a raker using the gage. By placing a straightedge between the two cutter teeth on each side of the filed raker you can measure the relative height with a feeler gage placed between the raker and straightedge.

There are two basic ways a raker can be shaped before it is filed to its proper depth using the raker depth gage. These are known as straight (plain) and swaged rakers. There are advantages and disadvantages to each method. The straight raker is by far the easier to file, but it results in a relatively "slow" running saw. The swaged raker is considerably more difficult to shape but results in a superior running saw. The reason for the difference is apparent when one remembers that the raker acts like a chisel to remove the shaving. Much less energy is required to remove wood from a board if a chisel is held at a low angle to a board than if it is held vertically. Swaging results in a raker tip that is similar to a chisel held at a low angle to the wood.

Fitting Straight Rakers

The teeth of a saw are formed by punching, so the gullets of most saws are rough. With a 7- or 8-inch slim taper file, dress (smooth) the outside face of the rakers from the raker tip to the bottom of the sawdust gullet. Make sure the file is held square with the saw. This will provide clean, sound metal for the cutting edge of the raker, cause less friction between the outside face and the shaving, and aid shaving removal.

Next, file the raker to the proper depth. Place the properly adjusted raker gage on the saw so the raker fits in the slot in the filing plate. Hold the gage so it rests firmly against the tops of the cutter teeth as well as the side of the saw. Run a file across the raker tips until they are even with the top of the filing plate. Once the raker tip has been filed, the raker must be sharpened. With a 7- or 8-inch slim taper file, shape the raker gullet to the approximate shape shown below, rounding the gullet out to the tip until the flat spot on top almost disappears. If the tip is overfiled it changes the raker depth. If not filed enough, the flat spot acts like a "sled runner" and does not permit the edge to work properly.

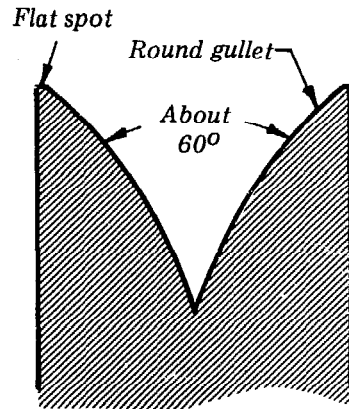

Shaping a raker tooth (straight raker).

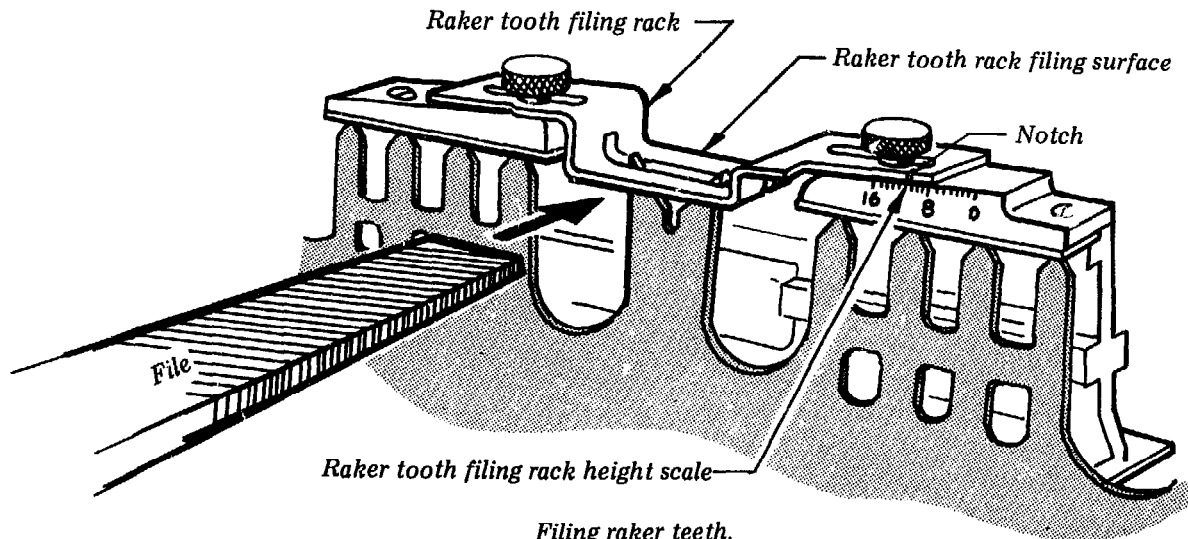

If you're using an Anderson type gage, this step is not critical; the clearance angle has been established and a good-sized "flat" spot can be left. Make sure the end of the filing slot in the Anderson gage is held firmly against the tip of the raker. If not done, the raker tip will be filed too low.

Fitting Swaged Rakers

Swaging is forming the leading edge of the raker into a curve so it more efficiently picks up the shaving. It is done by striking a prepared raker tip on the inside face with a hammer to bend the tip outward in a smooth curve.

Tools necessary are a pin gage, 8- to 16-ounce hammer for swaging (16-ounce hammer preferred), raker gage, 6-inch slim taper file with "safe" corners, and a 6-inch mill bastard. A pin gage generally is part of a combination saw filing tool.



6-inch slim taper file.



6-inch mill bastard file.

I know of no hammers specifically designed for swaging. A swaging hammer should have a face small enough to permit you to strike the raker tip with the center of the hammer face. The best substitute for a swaging hammer appears to be a tinner's riveting hammer. A swaging hammer should weigh about 16 ounces. A lighter (8-ounce) hammer can be used, but a 1-pound hammer is easier to use.

To prepare the raker, file it approximately to the shape shown below with the slim taper file. The exact shape depends on whether the raker is straight or if it has been swaged before. The objective is to shape the tip so it can be bent without breaking but retain enough thickness to prevent bending during use. For starters the cutting angle should be between 30 and 40 degrees.



Swaging hammers.

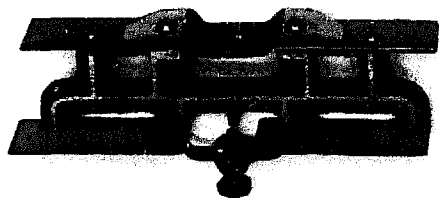

Combination saw filing tool and pin gage.

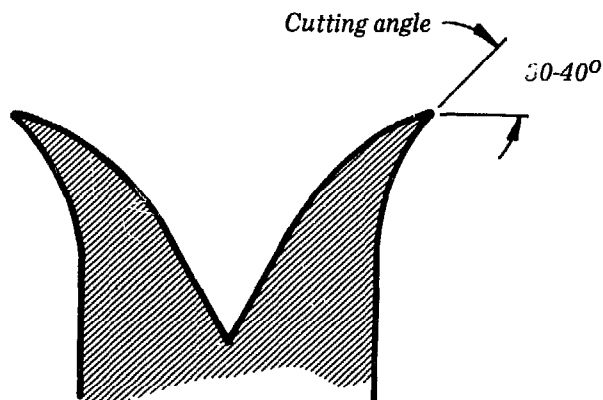

Preparing a raker. This is also a good shape for a finished raker.

The raker is now ready to be "swaged to the pin." This means bending the raker by striking the inside face of the raker tip with a hammer until the tip just clears a preset screw (called a pin) on a combination saw tool.

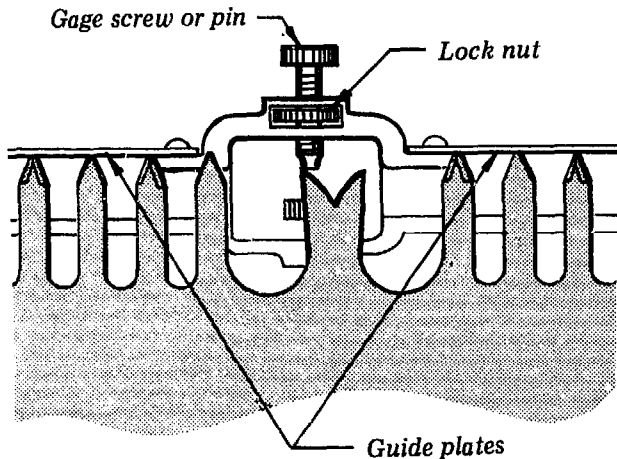

Gaging rakers with the pin gage on the combination saw tool.



Striking the inside face of the raker tip with a hammer.

The pin is adjusted so the swaged raker is 0.002 to 0.003 inch higher than the finished raker depth. This is done by first filing a raker to depth using the raker gage (which has already been set using methods described on page 13). Next, place the pin gage over the raker and adjust the pin (screw) depth so a

0.002- or 0.003-inch feeler gage will just pass between the raker tip and the pin. Check clearance again after tightening lock-nut.

To swage a raker, strike the raker tip a square blow; check the height with the pin gage. If it is still too high, continue alternately swaging and checking until the raker tooth just clears the pin. Keep an eye on the shape of the bend. The outside face of the raker should bend in a smooth arc. A kinked raker tip will be difficult to swage next time the saw is filed, and it will quite possibly break. If the tip begins to kink, the hammer probably is being used too high on the tip. If it won't bend, the tip may be too thick or the hammer is being used too low on the tip. Often in the case of a new saw or a used saw with straight rakers, it will be necessary to partially swage the tip then thin the tip some more with the file and continue swaging.

There is no pat answer to the question: "At what angle is the raker struck?" This will vary with the shape of the raker tip and must be learned from experience. Keep an eye on the desired swage shape; knowing where to strike the tip will come with experience.

Some saws are so hard and consequently brittle there is a possibility of breaking raker tips when swaging. If a saw is so hard that a fairly new file keeps slipping while the filer is shaping the raker gullets, or if a raker actually breaks when being swaged, the rakers should be tempered.

To temper the raker, polish one side of each raker until it is shiny. Place the saw in a vise. Heat the top three-fourths of the tooth uniformly using a propane torch. As it gets hotter, the color will go from light straw, to brown, to deep purple, to dark blue, to light blue, to a light yellow color. There are differing opinions on how far to temper the

rakers (what color to heat to). A compromise seems to be between light blue and the second yellow. A suggestion would be to first temper to light blue and if trouble is still experienced, temper again to the second light yellow. Don't heat into the body of the saw; it may cause the saw to warp. Be very careful about playing the torch flame on the raker tips; they heat very fast making it extremely easy to overheat them. This causes a soft raker that will bend in hard wood and will not hold an edge.

Once the rakers are "swaged to the pin," the tips are dressed on the outside face. To dress the swaged tip a 6-inch slim taper file with "safe" corners is run lightly across the under edge of the swage to square it up and establish the rake angle. It is most important not to nick the raker with the edge of a file. A nick can cause the tip to break off during swaging or in use. This is the reason for the ground "safe" corners on the dressing file. After dressing the outside face and rake angle, joint exactly as with the straight-style raker. As with straight rakers, a trial depth of 0.012 inch for average conditions is good.

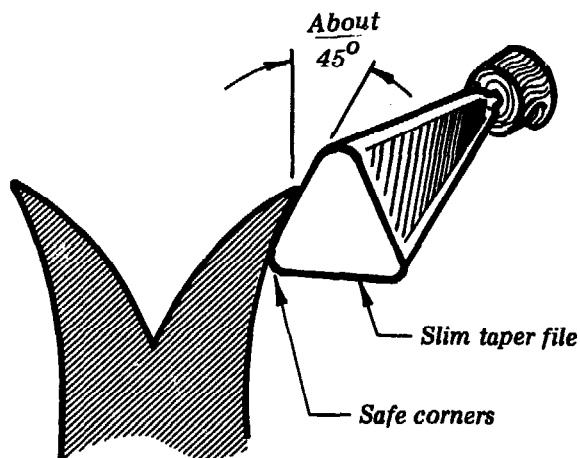

Dressing a raker.

The last step is to dress the sides of the rakers. The swaging process often widens the raker at the tip. This can be corrected by holding a 6-inch mill bastard file flat against the raker and saw and making one or two light vertical strokes.

Repairing Bent Rakers and Cutter Teeth

To check for bent rakers make up a spider (set gage) for zero clearance on an unbent raker. A bent raker can easily be found by using the spider in the same manner as for checking cutter tooth set (see "Setting").

To straighten a bent raker, the concave side of the raker is placed on an anvil and hammered until tooth is straight. Badly bent cutter teeth could be straightened the same way.

Broken Raker Tip

A broken raker tip allows the other tip on the raker to bite too deeply on the cutting stroke, causing the saw to catch just as it does with a long raker. File the unbroken tip shorter, say 0.005 inch for starters. If it still catches, file shorter yet.

POINTING UP CUTTER TEETH

To point up the cutter teeth, tilt the vise away from you about a 45-degree angle. With the vise tilted, the flat spot on each tooth caused by jointing should appear bright. To accomplish this, the main light source needs to be in front so you can see a good reflection off the flat spot. A wide set of windows (preferably facing north to avoid direct sunlight) works well. Two 4-foot fluorescent lights mounted end to end on a wall supply uniform lighting regardless of weather. If possible, avoid point sources of light such as incandescent bulbs and direct sunlight.

For filing the teeth, a 7- or 8-inch special crosscut file is used. A tooth shape like this is a good general purpose shape:

A good general purpose cutter tooth.

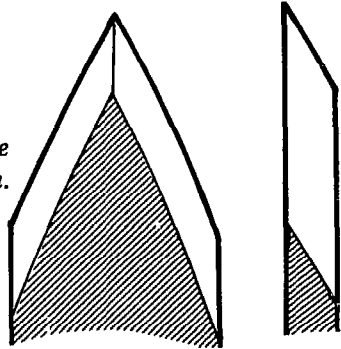

The stroke should be more nearly up and down the tooth than across the tooth. The main point to keep in mind when filing a cutter tooth is to file just enough to *almost* make the flat spot from the jointing operation disappear. Overfiling upsets the relation between the cutters and the rakers and also results in a weak point. A slight rolling or rocking motion of the file generates a slightly convex filed surface and results in a more durable tooth. Because of the set, a tooth whose filed surface is flat will develop a concave cutting edge and a thin, weak point.

Thin, weak point →

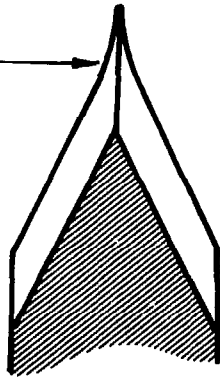

A poorly filed cutter tooth.

The more pointed a tooth is filed, the deeper it will sink into the wood and the "hungrier" a saw will be. A sharply pointed tooth, however, will wear faster than one less sharply pointed. The consensus is that there should be less bevel on a cutter tooth for hard wood than for soft wood, (but I have been unable to determine figures).

As the tooth is being filed, it is a good idea to periodically remove the burr that forms on the back side of the tooth, because the burr can obscure the true tooth shape. Remove the burr with whetstone or a *light* stroke of the file across the tooth back — *just enough to remove the burr*. The back side of the tooth must not be filed because it may cause the saw to bind. The burr can also be removed with a piece of hardwood.

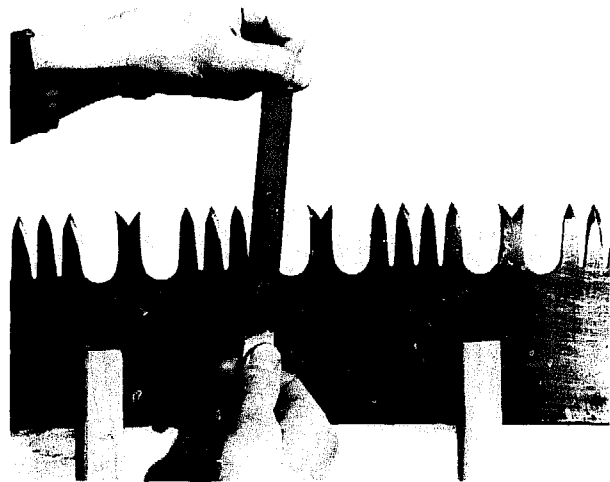

Filing a cutter tooth.

After all the teeth are filed, run over them with a fine stone held flat against the saw to remove any residual burrs, especially at the tip of the tooth. A burr under the spider would cause an error in the tooth set.

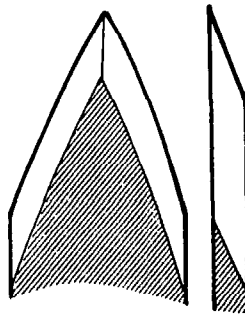

Cutter tooth shape for softwood.

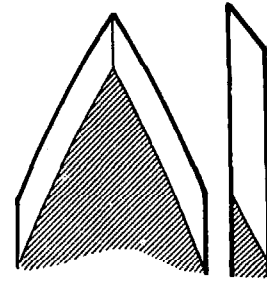

Cutter tooth shape for hardwood.

SETTING

To set a saw is to bend the tip of each cutter tooth away from the plane of the saw a slight amount. Just as alternate teeth are sharpened opposite each other, they are set opposite to each other. Setting helps prevent binding by resulting in a kerf that is slightly wider than the saw. The amount of set required depends on the type of saw used and the type of wood being cut. A saw should be set only as much as required to keep the saw from binding. More set than necessary results in more work to make a wider kerf and a saw that flops in the cut with the possibility of a curving cut. The set required can vary from almost nothing for a crescent taper ground saw in dry hardwood to 0.030 inch for the same saw in soft, punky wood. A set of 0.010 inch is a good figure to start with. Flat ground saws require more set.

There are two basic methods of setting: spring setting and hammer setting. Spring setting is done by using a tool with a slot in it that fits over the top of the cutter tooth. The tip of the tooth is then bent the required amount. This method is not recommended because of the possibility of bending the whole tooth and the fact that a tooth doesn't seem to hold a spring set well.

There are several ways of hammer setting a saw, only one of which is recommended. Two other methods are briefly discussed for familiarity.

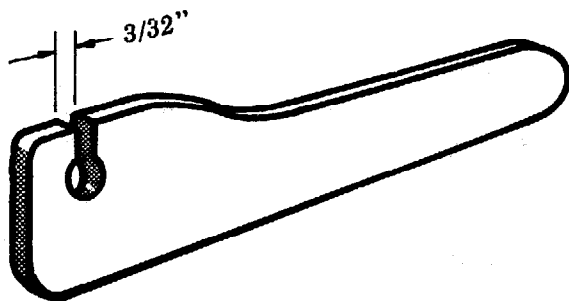

Spring set tool.

One setting method uses a setting stake. The setting stake is placed on a log or block and the wedge fully driven in to keep the stake in a firm position. The blade of the saw is then laid on the stake with the point of the cutter tooth projecting over the bevel about 1/4 inch. The tooth is then struck with the set hammer as shown below.

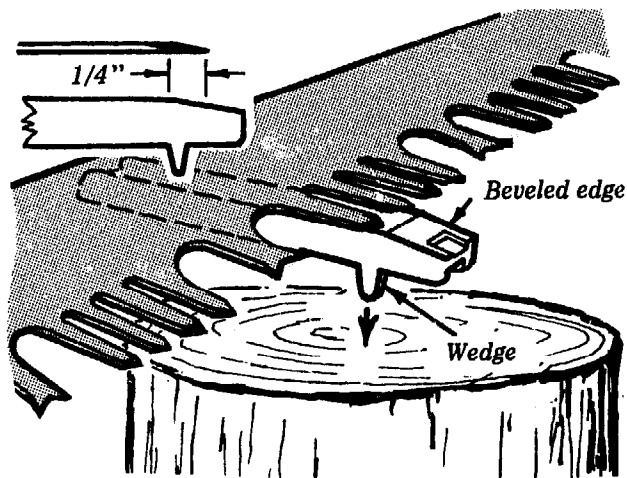

Using a setting stake on a stump.

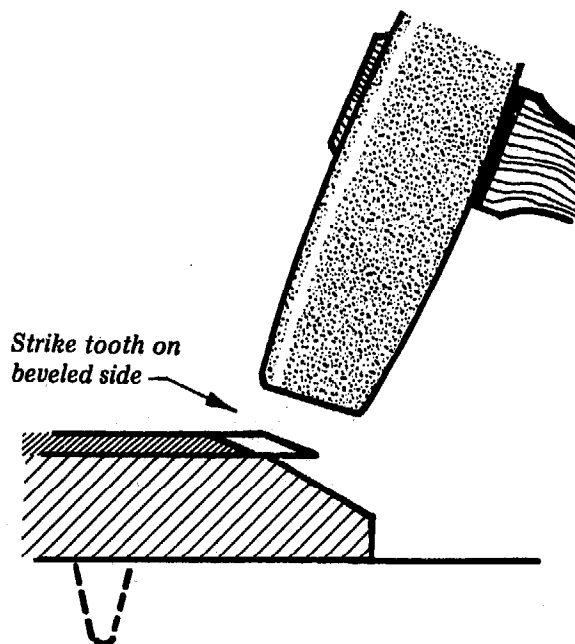

Setting a cutter tooth.

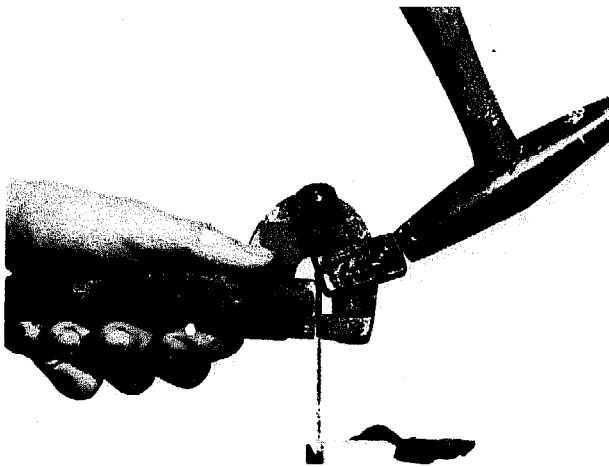

Using a setting tool to set cutter teeth.

Another method uses a tool that is placed over the cutter tooth and is struck with a hammer.

A third method uses a hand-held anvil and a hammer.

The principle is the same for the three methods: the tooth is bent over an anvil with a direct or indirect hammer blow.

The first two methods have definite disadvantages over the third. They each require a specialized tool, and they are slow. To check the set in the first method the saw must be lifted off the setting stake.

The second method is a little more efficient in that the saw doesn't have to be moved; the tool can be used with the saw in a vise. There is no chance of an ill-directed hammer blow marring the tooth. However, there's a good chance of banging and dulling the tooth tip with the tool, and the tool isn't really designed for removing set if too much is put into the tooth.

The third method is recommended because of its speed and accuracy. Necessary tools are an 8-ounce set hammer, a set anvil, and a spider (set gage).

There doesn't appear to be a current manufacturer for a hammer specifically designed for setting. A setting hammer should have a fairly small face. A large face such as most ball-pein hammers have is difficult to use for setting without hitting adjacent teeth. The best substitute for a setting hammer appears to be a tinner's riveting hammer that weighs about 8 ounces.

Anvils were manufactured in a variety of sizes and shapes. Most had a bevel to bend the tooth over and were made of hardened steel. There is no known current manufacturer for hand-held anvils. Any piece of steel that can be held comfortably in the hand and has a flat face and weighs about 2 pounds will work. A piece of 1-1/2-inch diameter shaft about 5 inches long works admirably. It is not necessary to have a bevel; simply setting the tooth over the edge of the face works fine.

The spider (set gage) is used to measure the tooth set. To measure the set for which the spider is adjusted, place it on a flat surface so that the feet on the three short legs contact the surface. With light pressure on the three short legs measure the clearance under the



Several types of spiders.

fourth foot (or longer leg) with a feeler gage. A piece of plate glass or a mirror will work for the flat surface, though it is wise to check the spider several places on the surface so errors caused by irregularities can be averaged out.

As indicated earlier, a set of about 0.010 inch would probably be satisfactory for average work for a felling saw. More set is required for a heavy bucking saw, say 0.015 inch.

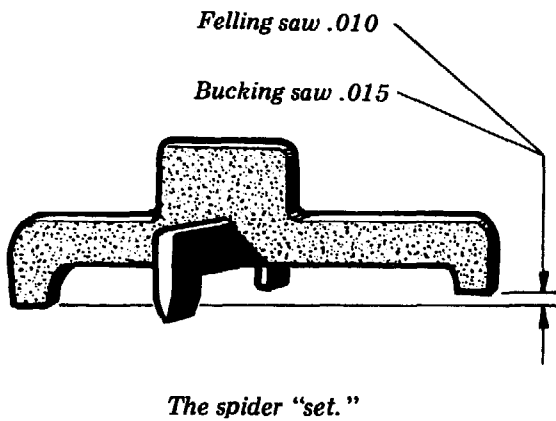

To adjust the spider for less set, place it on a flat carborundum stone and while putting pressure on the short crosspiece, grind the feet down until it measures right. For more set shorten either end of the long crosspiece. It is important that the foot at the end of the long leg is flat and parallel to the plane defined by the other three feet. This assures a constant reading no matter where the tip of the cutter tooth contacts the foot. This can be checked by lightly grinding that foot while the two feet on the short crosspiece are in contact with the stone and observing the resulting pattern on the foot.

To set the saw, place an anvil on the point side of the tooth and strike the tooth on the beveled side with a set hammer. The bevel on the anvil should be about 1/4-inch below the tip of the tooth and the direction and placement of the hammer blow such that the

tip of the cutter tooth is bent over the bevel. Be sure to strike the tooth squarely. If the tooth is struck a glancing blow with the edge of the hammer face, the point of impact will be badly marred. This sometimes work-hardens the metal enough that a file won't cut it. And it may make the tooth more susceptible to breaking.

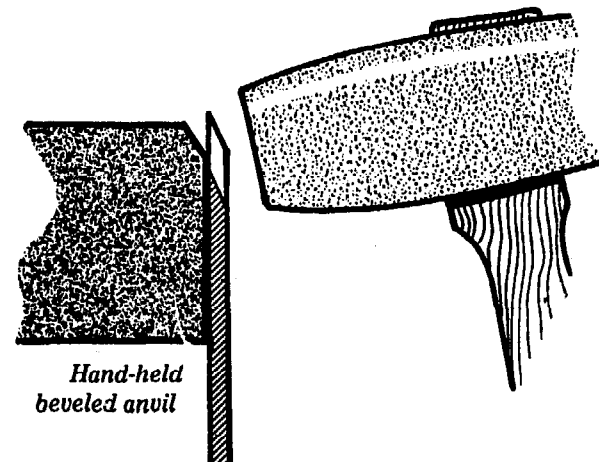
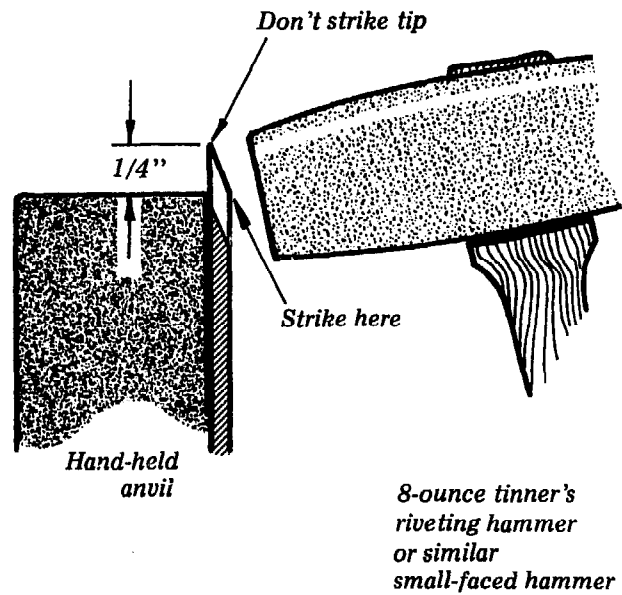

Setting cutter teeth with hand-held anvils.

It is also important to keep the face of the anvil parallel to the plane of the saw when setting. If it is held at an angle, the tooth will be twisted when set. Check the set with the spider. If the vertical legs rock, there is insufficient set and the above procedure should be repeated. If the horizontal legs rock, there is too much set and some must be taken out. This is done by moving the anvil nearly to the top of the cutter tooth and striking a light blow.

Sometimes a tooth will have been bent from a point below the filed part of the tooth. This can be determined by checking with the spider up and down the tooth. If this is the case, place the anvil on the tooth just below the bend and straighten it by hammering the opposite side of the tooth just above the anvil.

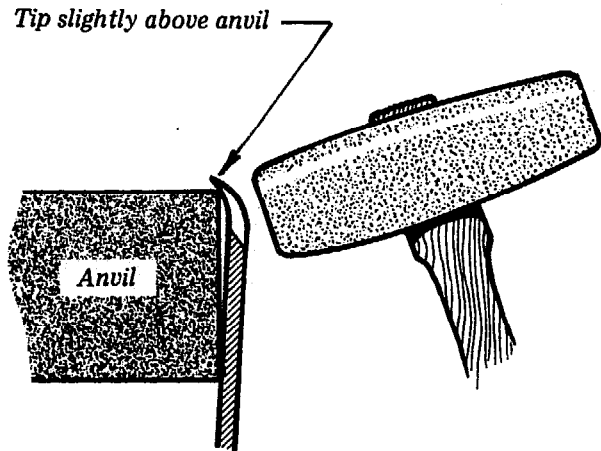

Correcting an "over-set" cutter tooth.



Setting cutter teeth.

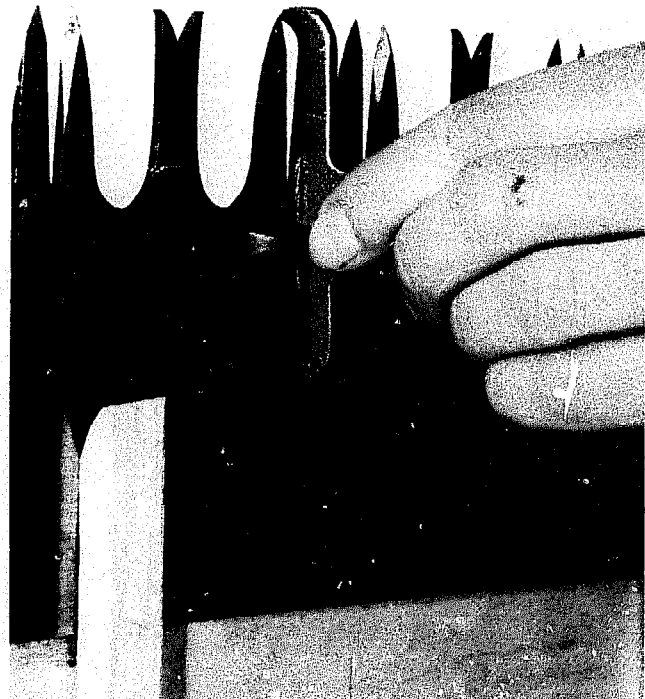

Checking set of cutter teeth with a spider.

Testing a Saw

Make a cut in an average log. A properly running saw runs without jumping or catching, doesn't bind, makes a straight cut, and makes thick shavings without "whiskers."

Jumping or catching is most often caused by a raker out of adjustment. Check the shavings: if a raker is too long ("high"), it will show up by pulling shavings with whiskers. If the rakers were filed carefully, the most likely cause of a "high" raker is overfiled cutters. To correct a high raker, lay the raker gage lightly over the offending raker and file it down. Use as little pressure as possible so the points of the cutter teeth in contact with the raker gage are dulled as little as possible.

If most shavings have whiskers on just one side, either the filing plate on the raker gage is not square to the plane of the saw (resulting in an unsquare raker cutting edge) or the file in the jointer was not square to the plane of the saw (resulting in the cutter teeth on one side being longer than the other). The solution is either refile the saw after correcting the tool problem or use the saw as is.

If the saw runs hard and pulls whiskered shavings, the rakers are too long (too little raker depth).

If thin papery shavings are pulled, the rakers are likely too short. To check further, push down hard on the saw while cutting. If this



Thin shaving
(Raker teeth probably too short).



"Whiskered" shaving
(Raker teeth probably too long).

does not produce thicker shavings with whiskers, the rakers are probably too short. Another test is to saw a small pole, or saw so only a few teeth are in contact with the wood. If whiskers are not produced the rakers are too short.

Another cause of a catchy or jumpy saw is uneven set.

Binding can be caused by too little set or a curving cut.

A curving cut can be caused by several things: A kinked saw, too much set allowing the saw to flop in the cut, uneven set that pulls the saw to one side, a sawyer bending or twisting the saw as he cuts (not a fault of the saw, but a problem that might be blamed on the saw).

Choosing and Using a Saw

Felling saws have been used by trail crews instead of bucking saws for several reasons. They are light and flex easily to conform to a backpack or horse pack. Although they are generally used by two persons, a felling saw, if it is filed properly and the cut is close to vertical, can be run easily by one. However, with cuts much off the vertical, the free end will droop on the push stroke and oscillate violently on the return stroke.

Saws made today have solid ends (the teeth don't run to the ends of the saw). These saws are adequate for bucking and felling where it is not necessary to use the end of the saw. But for finishing some cuts, for example, a log lying in the dirt, you need a saw with teeth right to the ends. If you have a choice when acquiring a crosscut saw, choose the toothed-ended saw.

An effective saw guard can be made of a section of old firehose, preferably rubber-lined, that has been slit along its length. A guard often removed can be made to fasten with Velcro to speed removal and replacement.

To carry a saw lay it flat across your shoulder with the teeth guarded and facing away from your neck. Remove the rear handle so it won't catch on brush or limbs. In a group, you should walk last in line.

When transported, saws should have better protection than firehose. An accidental blow with a tool or against the sides of a vehicle will cause the teeth to cut through the hose and be dulled. One effective way to transport saws is between two pieces of plywood that are firmly bolted together.

The first step in cutting a log is swamping. Remove *any* brush, plants, etc., that may interfere with the saw. Something as seemingly insignificant as a blade of grass between the teeth and kerf can jam a saw.

Check the lay of the log and decide what will happen when the log is cut. Will it roll? Will it jump? Will it drop? Plan your cuts accordingly. Sometimes it will only be safe to have one person sawing. This is often the case if the log is on a slope. Saw from the uphill side.

Before making the cut, remove the bark where the saw will pass. Bark often has dirt in it and some say bark itself dulls a saw rapidly.

When cutting green wood, sap may stick to the saw blade and gradually build up in thickness to where the saw blade will bind in the kerf. To prevent this, the saw blade should be lubricated with kerosene occasionally or when the blade begins to get sticky.



An old firehose used for a saw guard.

Kerosene for this purpose can be kept in a small flat hip flask that can be carried comfortably in the back pocket. If the cork in the neck of the flask has two to three small grooves cut down its length, the blade can be covered evenly with a thin film of kerosene, by whisking the corked bottle along the saw blade.

Make sure the saw doesn't get in dirt or rocks at the end of a cut. Make the last few strokes with the end of the saw; then if it does get in the dirt, only the end teeth are dulled. Put a piece of bark under the log if possible when there's a chance of running the saw into the dirt. If necessary, dig the log free where the saw will pass. The object is to keep the saw sharp as long as possible.

Though not recommended, a saw can be touched up in the field. An improvised vise can be made by cutting a slot in a stump or log and wedging the saw in the slot with some wood slivers. Usually only a file is available in the field, so only the cutter teeth can be touched up. Remember, don't overfile. It is better to leave the saw just a little dull than to shorten the tooth by overfiling.

If a saw has a raker that is catching badly, it can be shortened a slight amount until the saw runs smoothly again. Be sure to shorten only the offending raker; it is sometimes difficult to determine which one is catching.

A leaning tree will have grown so the fibers are quite compressed on one side. In this case it may be possible to only sink the teeth in a couple inches before they bind. If this happens, grab an ax and start chopping. Saw a few inches and chop out the severed wood.

Often a log will be lying such that the kerf begins to close on the saw before a cut is completed. This occurs when the wood is under compression as when a log is supported

at the ends and the cut is in the middle. In some cases, the cut can be continued by driving a wedge into the kerf behind the saw. Where this won't work, as when there is not room to drive a wedge or the wedge won't open the kerf, the log must be cut from the bottom, or "underbucked."

Generally, this should be done by one man with one handle removed from the saw. This reduces the chance of a saw's being kinked or broken if the log carries it to the ground. To underbuck, plant an ax in the log so the handle can be used as a support for the back of the saw. Cut a small notch in the handle for a guide. Some oil in the notch will let the saw run easily and reduce ax handle wear. The spring of the ax handle will hold the saw in the cut with uniform pressure. A log or rock can be placed under one side of the cut to hold the log up so it will be less likely to carry the saw to the ground as the cut is completed.



Using an ax for support to "underbuck" a log.

Handle Positions

How a saw cuts is determined to some extent by how the handle is put on the saw and how the handle is held. Assume the saw is making a vertical cut with the teeth pointing down. With the handle pointing up, a pull stroke will be easier the farther toward the end of the handle the hands are held. The push stroke will be harder. On the other hand, with the handle pointing down, the opposite occurs. In saws that have two holes on each end (generally bucking saws), changing the handle position from the lower to the upper

hole will have the same effect as moving the hands several inches up the saw handle.

The difference in force necessary to make a saw stroke under different handle positions is due to the different downward forces applied to the saw. For example, with the handle up, a push stroke increases the downward force on the saw causing the teeth to sink deeper into the wood. (This results in a deeper cut that requires more energy.) On the pull stroke a slight upward force is applied to the saw.

Storing Saws

A saw should be stored straight. Leaving a saw bent (around a firepack) will bow the saw. A stored saw should be well oiled with a heavy oil. Grease dissolved in gasoline to a consistency that can be painted also works well.

Finding Saws and Tools

Until the advent of the chain saw, crosscut saws were a common item and manufactured by several large companies. Now, I know of only one company manufacturing crosscut saws in the United States: Jemco Tool Corp., Saw Division, 60 State St., Seneca Falls, N.Y. 13148. The company distributes a catalog of its saws.

Crosscut saws are available to Government agencies through the General Services Administration (GSA), which purchases its saws from this company.

Other sources of saws and tools are second-hand stores, the odd hardware store that still has saws and tools in stock, and saws on surplus from different Government agencies.

A tool kit for crosscut saw reconditioning is available from the Century Tool Co., Inc.,

Ginkgo Industrial Park, 102 Richard Rd., Ivyland, Pa. 18974. It also can be ordered from GSA under National Stock No. 5180-00-596-1488; description: Tool Kit — Crosscut Saw Reconditioning Per Federal Specification GGG-T-551. The kit contains a jointer/raker tool gage, a spider (set gage) 3-1/2 inches by 2 inches, a setting stake (block), and a steel carrying case.

Special crosscut files are manufactured by Simonds and Nicholson companies. Special crosscut files are available through GSA though they are not listed in the catalog and are not a stock item. The stock number is 5110-00-596-6340. This is an 8-inch type XIII Class I style A mill blunt American pattern file; Federal Specification GGG-F-325.

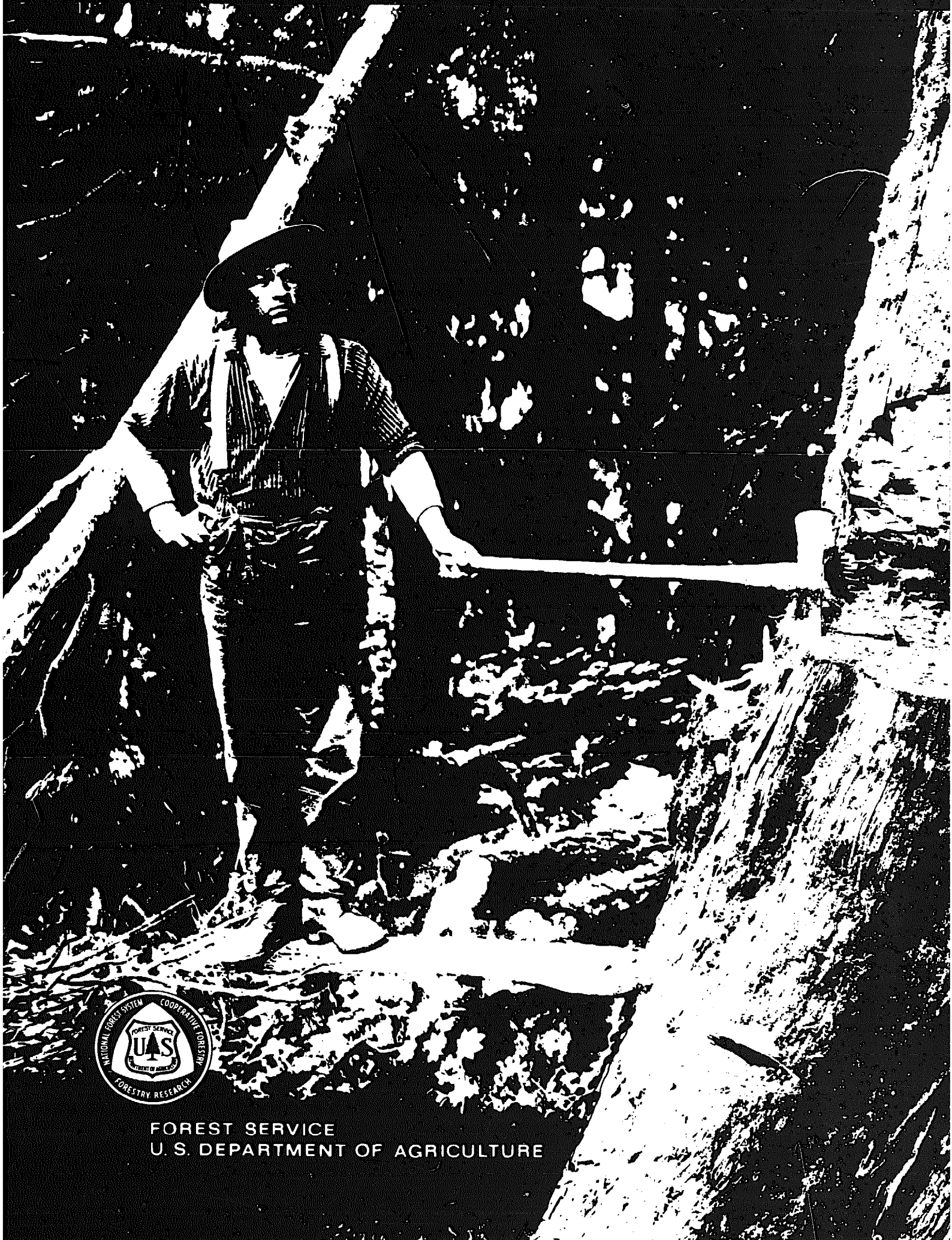

FOREST SERVICE
U. S. DEPARTMENT OF AGRICULTURE