

# **AT** MICROFICHE REFERENCE LIBRARY

A project of Volunteers in Asia

## Survey of Solar Agricultural Dryers

Published by:

Brace Research Institute  
MacDonald College  
McGill University  
Ste. Anne de Bellevue 800  
Quebec, Canada H9X 1C0

Paper copies are \$ 9.00.

Available from:

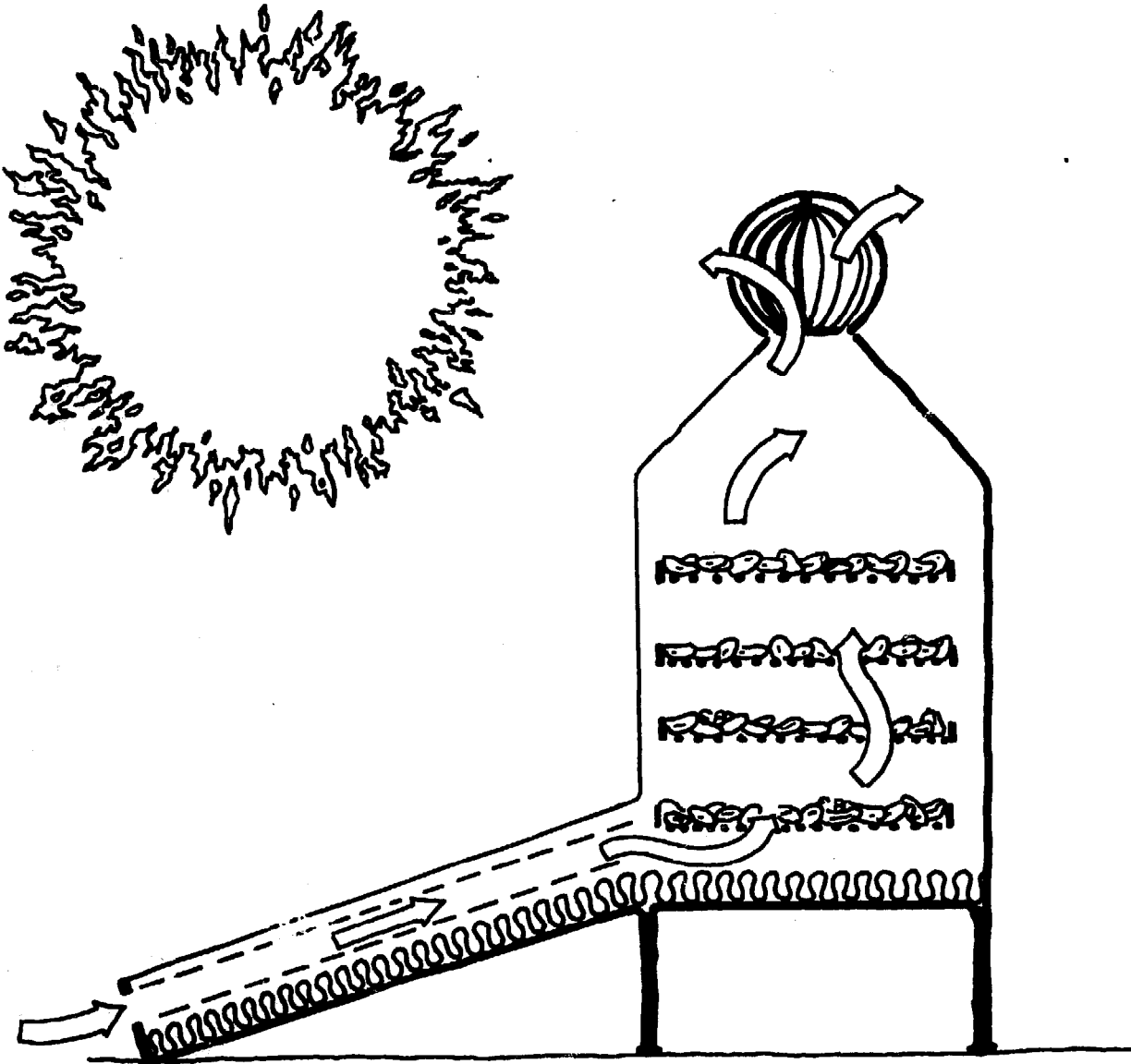
Brace Research Institute  
MacDonald College  
McGill University  
Ste. Anne de Bellevue 800  
Quebec, Canada H9X 1C0

Reproduced by permission of the Brace Research  
Institute.

Reproduction of this microfiche document in any  
form is subject to the same restrictions as those  
of the original document.

McGill University  
Faculty of Engineering  
BRACE RESEARCH INSTITUTE

# A SURVEY OF SOLAR AGRICULTURAL DRYERS



Technical Report T99

December 1975

BRACE RESEARCH INSTITUTE  
Macdonald College of McGill University  
Ste. Anne de Bellevue  
Quebec, Canada  
HOA 1C0

# Survey of Solar Agricultural Dryers

Brace Research Institute  
Macdonald College of McGill University  
Ste. Anne de Bellevue  
Quebec, Canada  
H9X 3M1

This work has been supported by a grant provided by the Non-Governmental Organization Division of the Canadian International Development Agency, Ottawa, Canada.

## Introduction

The increasing population of the world necessitates the provision of a greater supply of food. This raises the question of the preservation of agricultural surpluses. One of the methods traditionally used to preserve surplus produce is drying of the material in the sun. The industry is extensive and practiced on a world wide basis.

In more recent times, attempts have been made to increase the effectiveness of these traditional sun drying techniques in order to:

- a. make better use of the available solar radiation as well as other climatological factors,
- b. produce a more evenly dried product of higher quality,
- c. reduce the noxious effects caused by dust, dirt and insect infestation,
- d. reduce the dangers of incomplete drying caused by sudden rainfalls, high humidities, etc.,
- e. reduce , wherever possible, the time taken to dry the agricultural product.

This equipment is referred to as solar agricultural dryers. This report attempts to review some of the dryers actually built by experimenters and practitioners in the field.

Several criteria have been used in preparing this report:

1. there is a focus on work adapted for use in rural areas of developing regions,
2. generally, small scale dryers have been studied in order that the report might be of use to individuals and organizations in these areas wishing not only to apply this technology but also to improve it, adapting it to local conditions,
3. a representative, but by no means exhaustive, cross-section of different types of dryers from a variety of areas around the world have been selected. It is possible that these dryers might find application in a number of different areas. Also it is recognized that new designs of solar dryers are continuously being developed, so that this type of report will require frequent updating,

4. it is hoped that this type of report will, in time, encourage direct exchange between various persons actually in these activities in different parts of the world. In order to facilitate this interchange, French and Spanish language versions of this report are also being prepared.

Finally it is essential that persons wishing to utilize solar drying techniques have readily available information in a condensed fashion, which can help render their own work more complete. It is desirable that as much research and development, and local adaptation, as possible be undertaken in the areas where the equipment is to be used in order to develop really appropriate Technological systems.

This survey of solar dryers is part of a larger Handbook on solar agricultural dryers and will be eventually incorporated into this manual. The data presented herein for a large part resulted from answers to a questionnaire circulated by this Institute and reprinted on the following pages. The response was encouraging. Every attempt has been made to reproduce in an unchanged fashion, the information, remarks and comments of the principal investigators as indicated in their replies. We indeed are grateful to the contributors who have kindly agreed to share information on their activities in this field with others.

The data is presented as case studies, in a reasonably standardized format. Units have been listed throughout according to the Système International Postal addresses of the various individuals or organizations working in the field have also been given for ease of communication. For further information, enquiries might best be addressed to the respective organizations rather than specifically to individuals.

These case studies deal with descriptions of the dryers, experimental results, photos, drawings and the like. Theoretical evaluations and other matters relating to the field of solar drying will be dealt with separately in the Handbook. It is appreciated that the latter will be more complete in the totality of its presentation; these case studies are made available at this time primarily for descriptive purposes.

The information on the solar dryers has been prepared from replies to the questionnaires as well as the review of specific data available on this subject.

The titles of the case studies have been tabulated on the following page and are divided into five sections. Each section applies to a different heat mode characterizing the classification of solar dryers. The principal section titles are defined following the tabulation. It must be realized that there is necessarily some overlapping from one section to another. The case studies are presented starting from the natural or sun drying experiences leading on to a variety of helio technological developments in this field.

In the interest of standardization, all data dealing with costs are given in United States of America dollars (\$ U.S.). Where applicable, a conversion is listed for the local country currency, at the rate effective at the time that the particular study was undertaken.

LIST OF CASE STUDIES ON SOLAR AGRICULTURAL DRYERS

<u>SECTION</u>	<u>CASE STUDY</u>	<u>TITLE OF CASE STUDY</u>
NATURAL AND SUN-DRYERS	A	Coffee dryers (Colombia)
	B	Drying grapes on racks (Australia)
	C	Natural vertical dryer (Colombia)
DIRECT SOLAR DRYERS	D	Solar fruit dryer (Brazil)
	E	Solar cabinet dryer (Syria)
	F	Solar cabinet dryer (India)
	G	See-saw dryer (Ivory Coast)
	H	Solar dryer for cereal and grains (Great Britain)
	I	Glass-roof solar dryer (Brazil)
MIXED MODE SOLAR DRYERS	J	Solar fruit and vegetable dryer (U.S.A.)
	K	Preheated circulation solar dryer (Turkey)
	L	Orchard type solar dryer (Turkey)
	M	Laboratory type solar dryer (Turkey)
	N	Natural convection dryer (Trinidad)
	O	Solar wind ventilated dryer (Syria)
INDIRECT SOLAR DRYERS (with forced ventilation)	P	Solar herbs and flowers dryer (U.S.A.)
	Q	Batch shallow bed coffee drying bins (Puerto Rico)
	R	Solar supplemental heat drying bin (U.S.A.)
	S	Large scale solar agricultural dryer (Barbados)
SOLAR LUMBER DRYERS	T	Solar timber seasoning kiln (India)
	U	Solar lumber dryer (Puerto Rico)
	V	Wood pre drying unit (Japan)
	W	Solar heated lumber dryer (U.S.A.)
	X	Lumber dryer (Madagascar)

DEFINITION OF TERMS USED TO CATEGORIZE  
DIFFERENT SECTIONS OF THE SOLAR DRYER CASE STUDIES

The solar dryers have been classified according to their heating modes, or the manner in which the heat derived from the solar radiation is utilized. In this regard, several general categories have been set up which are defined below. At the top of each case study, several descriptive terms have also been listed in order to classify the solar dryer and its operations. These terms have also been defined below. In general, a dryer has been classified according to its principal operating mode. Some of the direct and mixed mode dryers also use circulating fans, and are strictly not totally passive systems.

SOLAR DRYER CLASSIFICATIONS:

- Passive Systems - dryers only using solar or wind energy for their operations.

SUN OR NATURAL DRYERS:

These dryers make use of the action of solar radiation ambient air temperature and relative humidity and windspeed to achieve the drying process!

SOLAR DRYERS - DIRECT:

In these units, the material to be dried is placed in an enclosure, with a transparent cover or side panels. Heat is generated by absorption of solar radiation on the product itself as well as on the internal surfaces of the drying chamber. This heat evaporates the moisture from the drying product. In addition, it serves to heat and expand the air in the enclosure, causing the removal of this moisture by the circulation of air.

SOLAR DRYERS - MIXED MODE: (Direct and Indirect)

In these dryers, the combined action of the solar radiation incident directly on the material to be dried and air pre-heated in a solar air-heater furnishes the heat required to complete the drying operation.

- Hybrid Systems - dryers in which another form of energy, such as fuel or electricity is used to supplement solar energy for heating and ventilation.

SOLAR DRYERS - INDIRECT: (with forced ventilation)

In these dryers, the solar radiation is not directly incident on the material to be dried. Air is heated in a solar collector and then ducted to the drying chamber, to dehydrate the product.

SOLAR LUMBER DRYERS

These dryers have been put in a special category as they constitute an important application of this technology. In most cases forced ventilation is used as proper circulation of air helps control the drying rate so as to avoid case hardening.

OTHER DEFINITIONS:

- Chamber Dryer - is one in which the material to be dried is dried in an enclosure.
- Rack or Tray Dryer - is one in which the material to be dried is placed on an open rack or tray.

QUESTIONNAIRE ON SOLAR DRYING MANUAL

Please return to:  
Brace Research Institute  
Macdonald College of McGill University  
Ste. Anne de Bellevue 800  
Québec, Canada

S  
A  
M  
P  
L  
E  
Q  
U  
E  
S  
T  
I  
O  
N  
N  
A  
I  
R  
E

NAME OF ORGANIZATION

ADDRESS

NAME(S) OF PRINCIPAL INVESTIGATORS

DATE THIS FORM FILLED IN

TYPE OF DRYING UNIT (TITLE)

DESCRIPTION (PLEASE INCLUDE DIMENSIONS)

LOCATION(S) OF DRYER

HOW LONG HAS THE UNIT BEEN IN OPERATION, INDICATE PERIOD OF USE (e.g. OCTOBER 1968 - MARCH 1971): (A) ON EXPERIMENTAL BASIS

(B) IN FIELD OPERATION

MATERIALS DRIED (PLEASE LIST)

OPERATING PROCEDURES: QUANTITIES DRIED

OPERATING CONDITIONS

DRYING TIMES

COMMENTS ON DRYER

(A) IS THE MODEL TESTED IN THE EXPERIMENTAL STAGES, OR HAS IT BEEN FIELD TESTED?

(B) HOW MANY UNITS HAVE BEEN IN USE IN THE PAST?

(C) HOW MANY UNITS ARE CURRENTLY IN USE?

(D) WHAT ARE THE LIMITING FACTORS FOR THE EXTENSION OF USE OF THESE DRYERS? TECHNICAL? ECONOMIC? SOCIAL? PLEASE COMMENT BRIEFLY ON THE LIMITING FACTORS.

MATERIALS OF CONSTRUCTION OF THE DRYER (INCLUDE UNIT COST)

(A) TRANSPARENT COVER

(B) FRAMES

(C) INSULATION

(D) DRYING TRAYS

(E) IF FORCED CONVECTION IS USED, PLEASE SPECIFY DETAILS

(F) PLEASE COMMENT AS TO WHETHER THE MATERIALS LISTED IN (A) TO (E) ABOVE ARE IMPORTED OR LOCALLY AVAILABLE

ECONOMIC DETAIL:

- (1) PLEASE SUPPLY, IF POSSIBLE, AN ITEMIZED COST OF THE MATERIALS AND CONSTRUCTION EXPENSES. IF THE ABOVE IS NOT AVAILABLE, PLEASE SEND A RESUME OF COSTS OF THE UNIT, INDICATING THE PROPORTION OF MATERIALS AND LABOUR.
- (2) KINDLY GIVE AN INDICATION OF THE ANNUAL OPERATING EXPENDITURE.
- (3) DO YOU HAVE ANY COSTS OF DRYING AS RELATED TO A UNIT OF MATERIAL DRIED?
- (4) CAN YOU PLEASE ESTIMATE THE EFFECTIVE LIFE OF THE DRYER?
- (5) PLEASE INCIDATE THE PRINCIPAL CONSTRUCTION AND OPERATION PROBLEMS, AND WHETHER THEY ARE OF A TECHNICAL, ECONOMIC OR SOCIAL NATURE.

WOULD YOU ALSO PLEASE COMMENT ON THE USE OF THE FOLLOWING ASPECTS AS RELATED TO SOLAR DRYING.

- (A) FOOD TECHNOLOGICAL PRE- AND AFTER TREATMENTS OF THE DRYING PRODUCTS (CUTTING; BLANCHING, DIPPING, SULPHURING, SULPHITING ETC)
- (B) CLIMATOLOGICAL DATE OF THE LOCALITY, WHERE AND WHEN THE DRIERS OPERATE (SUNSHINE HOURS' TEMPERATURE' RELATIVE HUMIDITY OF THE AIR, LATITUDE ETC.)

GENERAL NOTES:

- (1) PLEASE ENCLOSE AT LEAST ONE OR MORE GOOD QUALITY PHOTOGRAPHS (APPROXIMATELY 7 cm x 12 cm), ILLUSTRATING THE PRINCIPAL FEATURES OF THE DRYER DESCRIBED.
- (2) PLEASE INCLUDE SKETCHES AND WORKING DRAWINGS OF THE DRYER. THESE SHOULD BE IN BLACK AND WHITE AND OF GOOD REPRODUCING QUALITY (REPRODUCTION BY PHOTO-OFFSET). THESE SHOULD BE ON STANDARD SHEETS 8-1/2" x 11" or 21 cm x 28 cm APPROXIMATELY).
- (3) IF AVAILABLE, CAN YOU PLEASE INCLUDE A SET OF "HOW-TO-BUILD-IT" INSTRUCTIONS, INCLUDING DRAWINGS, FOR EACH SOLAR DRYER DESCRIBED.



## ETUDE SUR LES SECHOIRS SOLAIRES POUR LES FINS AGRICOLES

INSTITUT DE RECHERCHES BRACE  
Collège Macdonald de l'Université McGill  
Ste. Anne de Bellevue  
Québec, Canada  
HOA 1CO

Cet ouvrage a bénéficié d'une subvention de la part de la division non-gouvernemental de l'Agence Canadienne pour le Développement International.

### Introduction

L'accroissement de la population mondiale nécessite que l'on rende disponible une toujours plus grande quantité d'aliments - ceci pose le problème de la préservation des surplus agricoles. L'une des méthodes traditionnelles pour conserver les aliments est le séchage au soleil. Ce type d'entreprise représente un marché important et est pratiqué partout dans le monde.

Plus récemment, on a tenté d'accroître les capacités et performances de ces méthodes traditionnelles de séchage afin:

- a. d'utiliser au mieux le rayonnement solaire et les autres facteurs climatologiques;
- b. de produire un produit de meilleure qualité et un séchage plus uniforme;
- c. de réduire les mauvais effets tels que la poussière, les débris, l'infestation par les insectes et autres contaminations;
- d. de réduire les dangers causés au séchage par des précipitations soudaines; le taux élevé d'humidité, etc;
- e. de réduire le plus possible le laps de temps nécessaire pour sécher les produits agricoles.

Tous ces procédés et équipements sont identifiés sous la dénomination de séchoirs solaires pour fins agricoles. Ce rapport se propose donc de faire une évaluation de quelques uns de ces séchoirs construits et utilisés par des chercheurs et des praticiens spécialistes en ce domaine.

Plusieurs critères ont été utilisés pour préparer ce rapport d'étude:

1. on a surtout insisté sur des travaux particulièrement adaptés aux régions rurales de zones en voie de développement;
2. en général, des séchoirs de petite capacité ont été étudiés afin que le rapport final soit d'une certaine utilité aux individus et aux organisations oeuvrant dans ces régions, surtout si ceux-ci sont désireux de mettre en pratique cette technologie et même d'y apporter quelques améliorations tout en l'adaptant aux conditions locales.

3. Quelques types de séchoir représentatifs de diverses régions du monde ont été sélectionnés. Il est possible que ces séchoirs puissent trouver application dans des régions différentes. Des nouvelles conceptions voient le jour régulièrement et par conséquent ce type même de rapport nécessitera d'être révisé fréquemment. Les séchoirs présentés ici ne représentent qu'une partie seulement des séchoirs déjà expérimentés ou couramment utilisés.
4. On peut espérer aussi que ce rapport encouragera un échange direct entre les diverses personnes déjà impliquées dans ce type d'activité dans les différentes régions du monde. Afin de faciliter cet échange, une version anglaise et espagnole de ce document est en préparation.

Enfin il est essentiel que les personnes désireuses de pratiquer le séchage solaire puisse avoir accès à une information concise et capable de les assister dans leur travaux. Il serait bon qu'une quantité suffisante de recherche et de développement ainsi qu'une pratique d'adaptation locale soit réalisée là où l'équipement doit être utilisé: ceci est indispensable à la création de véritables systèmes de technologies appropriées.

Cette compilation est une partie d'un Manuel plus vaste sur les séchoirs solaires agricoles et elle sera éventuellement incorporée dans ce manuel. Les données ci-incluses sont en grande partie le résultat de réponses à un questionnaire distribué par l'Institut de Recherches Brace. Nous estimons que le nombre et la qualité des réponses à ce questionnaire est très encourageant. Nous avons reproduit celui-ci dans les pages qui suivent. Tout a été fait pour que la reproduction de ces travaux soit aussi conforme que possible à la réponse originale. Nous ne pouvons qu'exprimer notre reconnaissance à ceux qui ont contribué et partager avec d'autres le fruit de leur travaux.

L'information est présentée sous la forme d'étude de cas et le format est raisonnablement standardisé. Toutes les unités sont conformes au système international. L'adresse des divers individus et organisations est incluse pour faciliter la communication. S'il y a lieu d'obtenir de plus amples informations, les requêtes devraient être adressées aux organisations plutôt qu'aux individus.

Ces études de cas se contentent de décrire le fonctionnement des séchoirs, des résultats d'expérience, des photos, des diagrammes. Les évaluations théoriques ainsi que tout ce qui concerne la partie technique et physique du séchage seront étudiées en détail dans le manuel. Celui sera donc un outil beaucoup plus complet. En attendant, ces études de cas permettent une appréciation descriptive des travaux effectués dans ce domaine.

Rappelons aussi que l'information sur les séchoirs solaires fut préparée à partir des réponses aux questionnaires et d'une revue de données spécifiques disponibles au sujet du séchage solaire.

Les titres de ces études de cas que l'on peut séparer en cinq sections sont inscrits sur la page suivante. Chaque section se rapporte à l'une des différentes méthodes de chauffage établie dans la classification des séchoirs solaires. La définition de chaque section apparaît à la suite de la liste.

On s'apercevra aussi qu'il existe un certain recoupement d'une section à l'autre; aussi, l'on a établi une suite chronologique partant de l'expérience de séchage au soleil jusqu'au divers développements héliotechniques dans le domaine des séchoirs solaires.

Dans le but de standardiser le plus possible, les données monétaires sont exprimées en dollars américains (\$E.U.). Dans les cas où c'était possible, le taux de change monétaire a été indiqué selon le pays et l'année où l'étude en question a été entreprise.

LISTE DES ETUDES DE CAS DE SECHOIRS SOLAIRES POUR PRODUITS AGRICOLES

<u>SECTION</u>	<u>ETUDE DE CAS</u>	<u>TITRE DE L'ETUDE</u>
SECHOIRS NATURELS OU SECHAGE AU SOLEIL	A	Séchoirs à café (Colombie)
	B	Le séchage des raisins au soleil (Australie)
	C	Un séchoir naturel vertical (Colombie)
SECHOIRS SOLAIRES DIRECTES	D	Un séchoir solaire à fruits (Brésil)
	E	Un séchoir-cabinet (Syrie)
	F	Un séchoir-cabinet (Inde)
	G	Un séchoir à bascule (Côte d'Ivoire)
	H	Un séchoir solaire pour grains et céréales (Grande Bretagne)
	I	Un séchoir solaire à toit vitré (Brésil)
SECHOIRS SOLAIRES MIXTES	J	Un séchoir solaire pour fruits et légumes (Etats-Unis)
	K	Un séchoir solaire à air préchauffé (Turquie)
	L	Un séchoir solaire pour verger (Turquie)
	M	Un séchoir solaire expérimental (Turquie)
	N	Un séchoir à convection naturelle (Trinidad)
	O	Un séchoir solaire ventilé par l'énergie du vent (Syrie)
SECHOIRS SOLAIRES INDIRECTS (AVEC VENTILATION FORCEE)	P	Un séchoir solaire pour les herbes et fleurs (Etats-Unis)
	Q	Séchage du café en caissons peu profonds (Porto Rico)
	R	Silo de séchage supplémenté par chaleur solaire (Etats-Unis)
	S	Un séchoir solaire agricole à grande capacité (Barbades)

SECHOIRS SOLAIRES POUR LE BOIS	T	Un séchoir solaire pour le séchage du bois (Inde)
	U	Un séchoir solaire pour pièces de bois (Porto Rico)
	V	Une unité de pré-séchage du bois (Japon)
	W	Un séchoir à bois chauffé par le soleil (Etats-Unis)
	X	Un séchoir à bois de construction (Madagascar)

---

#### DEFINITION DES TERMES UTILISES POUR LES DIFFERENTES SECTIONS DES ETUDES DE CAS SUR LES SECHOIRS SOLAIRES

Les séchoirs solaires ont été classifiés selon leurs modes de chauffage; c'est à dire selon l'utilisation de la chaleur provenant du rayonnement solaire. A cet effet, l'on a établi plusieurs catégories définies ci-dessous. Au début de chaque étude, on précisera par quelques termes descriptifs le type de séchoir et son mode d'opération. En général un séchoir sera classé selon son mode d'opération principal. Quelques séchoirs direct et mixte font utilisation d'un ventilateur pour activer la circulation de l'air et ceci les différencie d'un système totalement passif.

#### CLASSIFICATION DES SECHOIRS SOLAIRES:

##### Systèmes passifs

Séchoirs utilisant le soleil et l'énergie éolienne pour leur opération.

##### SECHAGE AU SOLEIL OU SECHAGE NATUREL:

Cette méthode utilise les radiations solaires, la température de l'air ambiante, et l'humidité relative, ainsi que la vitesse du vent pour permettre le séchage.

##### SECHOIRS SOLAIRES - DIRECT:

Le matériau à sécher est placé dans un enceinte dont le couvert ou bien les côtés sont constitués de matériaux transparents. La chaleur provient de l'absorption des rayons solaires sur le matériau à sécher ainsi que sur les surfaces internes du séchoir. Cette chaleur permet l'évaporation de l'humidité contenu dans le produit et cause une expansion de l'air situé dans l'enceinte; ce qui entraîne une circulation d'air chargé de l'humidité enlevée au produit vers l'extérieur.

##### SECHOIRS SOLAIRES - TYPE MIXTE (Direct et indirect)

Dans ce type de séchoir l'action combinée des radiations solaires incidentes sur le matériau séchant et de l'air préchauffé dans un chauffe-air solaire

fournit la chaleur nécessaire à l'opération de séchage.

### Systemes Hybrides

Ce sont des séchoirs dans lesquels une autre forme d'énergie comme le pétrole, le gaz ou l'électricité est ajoutée pour suppléer au chauffage et/ou à la ventilation.

### SECHOIRS SOLAIRES - INDIRECT: (Ventilation forcée)

Dans ces séchoirs le matériau à sécher n'est pas exposé au rayons solaires directs. L'air est tout d'abord réchauffé dans un capteur solaire puis pulsé dans la chambre de séchage pour effectuer la déshydratation.

### SECHOIRS SOLAIRES A BOIS:

Ceux-ci ont été mis à part car il sont une application très importante de cette technologie. Dans la plupart des cas une ventilation forcée est utilisée pour contrôler le taux de séchage et pour prévenir le surséchage à la surface des pièces de bois.

### AUTRES DEFINITIONS:

Enceinte de séchage - Espace fermé dans lequel on procède à l'opération de séchage

Séchoir à treillis ou à plateau - Type de séchoir sur lesquels les matériaux sont disposés, et exposés à l'air libre.

QUESTIONNAIRE POUR LE MANUEL SUR LE SECHAGE SOLAIRE

Veillez le retourner à l'adresse suivante:

Institut de Recherches Brace  
Collège Macdonald de l'Université McGill  
Ste. Anne de Bellevue 800  
Québec, Canada

ECHANILLONS

NOM DE L'ORGANISATION

ADRESSE

NOM(S) DES RECHERCHISTES

DATE A LAQUELLE CETTE FORMULE A ETE REMPLIE

TYPE DE SECHOIR (TITRE)

DESCRIPTION (INCLURE LES DIMENSIONS)

LIEUX D'UTILISATION DU SECHOIR

PENDANT COMBIEN DE TEMPS L'UNITE A FONCTIONNE, INDIQUER LA DUREE DE L'UTILISATION

(Ex: October 1968 - mars 1971): (A) STADE EXPERIMENTAL

(B) STADE OPERATIONNEL

MATERIAUX SECHES (FAIRE UNE LISTE S.V.P.)

PROCESSUS DE FONCTIONNEMENT: QUANTITES DE MATERIAUX SECHES

CONDITIONS DE FONCTIONNEMENT

DUREE DES OPERATIONS DE SECHAGE

COMMENTAIRES SUR LE SECHOIR:

(A) LE PROTOTYPE EST-IL AU STADE EXPERIMENTAL OU DEJA OPERATIONNEL?

(B) COMBIEN D'UNITES ONT DEJA ETE UTILISEES?

(C) COMBIEN D'UNITES SONT ACTUELLEMENT EN OPERATION?

(D) QUEL SONT LES FACTEURS LIMITANT UNE UTILISATION PLUS VASTE DE CES SECHOIRS? TECHNIQUES, ECONOMIQUES, SOCIAUX, COMMENTEZ BRIEVEMENT

MATERIAUX UTILISES POUR LA CONSTRUCTION DU SECHOIR (PRIX DE L'UNITE)

(A) COUVERT TRANSPARENT

(B) CADRES

(C) ISOLATION

- (D) PLATEAUX DE SECHAGE
- (E) SI UN SYSTEME DE CONVECTION DE RENFORT EST UTILISE, SPECIFIEZ LES DETAILS
- (F) VEUILLEZ DETERMINER SI LES MATERIAUX DE (A) a (E) SONT DE PROVENANCE ETRANGERE OU LOCALE

DETAILS ECONOMIQUES (UTILISEZ UNE PAGE SUPPLEMENTAIRE SI NECESSAIRE)

- (1) POUVEZ VOUS FOURNIR UN DEVIS, SOIT LE PRIX DE CHAQUE MATERIAU AINSI QUE LE COUT DE FABRICATION? SI NON, FAIRE UN RESUME SPECIFIANT LE COUT DES MATERIAUX ET DE LA MAIN D'OEUVRE
- (2) POUVEZ VOUS NOUS FOURNIR DES INDICATIONS SUR LE DEBOURSE ANNUEL D'OPERATION?
- (3) POUVEZ VOUS NOUS FOURNIR DES RENSEIGNEMENTS SUR LE PRIX DU MATERIAU SECHE PAR RAPPORT A SA VALEUR INDICATIVE?
- (4) POUVEZ VOUS ESTIMER LA DUREE MOYENNE DE LA VIE DE CE SECHOIR?
- (5) VEUILLEZ DECRIRE LES PRINCIPALES CONTRAINTES DE CONSTRUCTION ET D'OPERATION. SONT-ELLES DE NATURE TECHNIQUE, ECONOMIQUE, OU SOCIALE?

NOTES GENERALES

- (1) VEUILLEZ INCLURE AU MOINS UNE OU PLUSIEURS PHOTOGRAPHIES (7 x 12 cm) ILLUSTRANT AINSI LES CARACTERISTIQUES MAJEURES DE SECHOIR MENTIONNE.
- (2) VEUILLEZ INCLURE SCHEMAS ET PLANS DE CONSTRUCTION DU SECHOIR. CEUX CI DEVRAIENT ETRE EN NOIR ET BLANC ET ASSEZ NETS POUR LA REIMPRESSION (REPRODUCTION PAR PLAQUE) LE FORMAT DEVRAIT ETRE APPROXIMATIVEMENT DE 8½" x 11" ou 21 cm x 28 cm.
- (3) SI POSSIBLE INCLURE UNE NOTICE DE MONTAGE (DESSINS A L'APPUI) POUR CHACUN DES SECHOIRS.

POURRIEZ-VOUS DECRIRE VOTRE EXPERIENCE QUANT AUX ASPECTS SUIVANTS DU SECHAGE SOLAIRE.

- (A) PRE-TRAITEMENTS ET TRAITEMENTS QUE VOUS AVEZ FAIT SUBIR AUX PRODUITS A SECHER (COUPE, BLANCHIMENT, TREMPAGE, SULFURAGE, SULPHITAGE, ETC...)
- (B) DONNEES CLIMATOLOGIQUES DE LA LOCALITE, EPOQUE DE SECHAGE (HEURES D'ENSOLEILLEMENT, TEMPERATURE, HUMIDITE RELATIVE DE L'AIR, LATITUDE, ETC...)



**CASE  
STUDIES**

**ÉTUDES  
DE CAS**

COFFEE DRYERS (Colombia)Overview:

Status: operational

Heating mode: natural

Type: tray-dryers and  
partial-chamber dryers

Air circulation: natural air flow

A number of natural and solar dryers, employing natural sundrying techniques, have been used for small and medium scale drying operations on Colombian farms for many years. The types of dryers described are utilized throughout the coffee producing regions of Colombia. Maize, beans and cocoa are also dried in these units. Their performance is studied with respect to the drying of coffee.

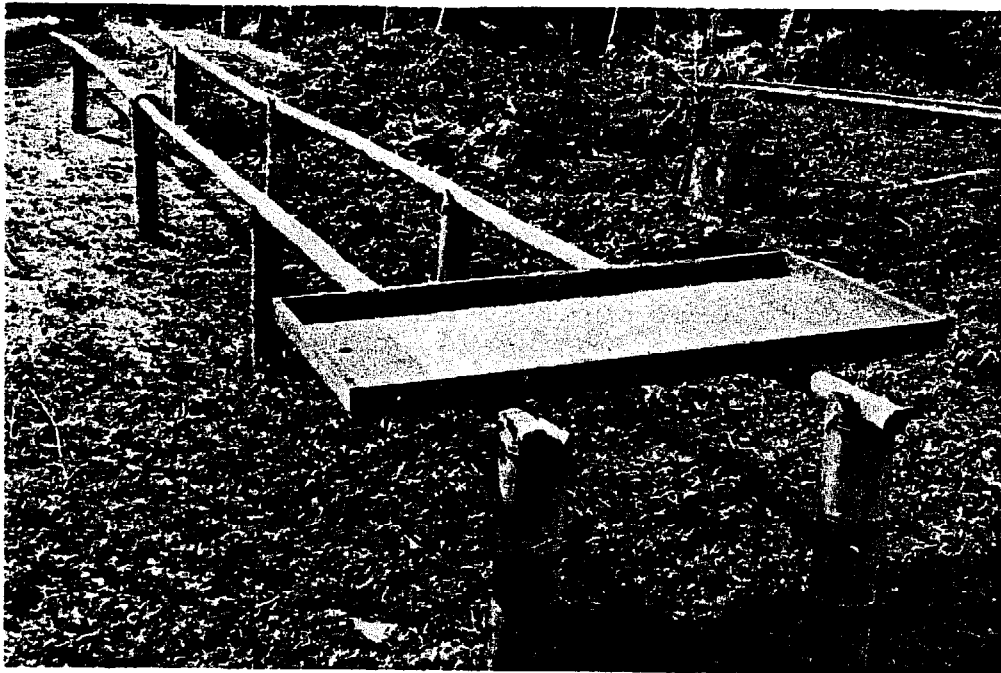


Figure 1 - The picture shows a "pasera" supported by a bamboo frame to avoid direct contact with ground

Description of the Different Types of Dryers Employed:

The dryers described here are basically very simple to operate. Insulation is not used in any of the systems described. All of these dryers work solely with natural air convection. All the construction materials are locally available. Depending on the farmer's requirements, the dryers have different shapes and dimensions.

The photographs show typical examples of the various types of dryers described below. The names in quotation marks are the local name for each type of dryer.

- A. "Paseras" (Fig.1). For the construction of the trays or "paseras", wood is used. During the drying process, the coffee beans are directly exposed to solar radiation, and during rainy periods and at night time they are stored under a cover.

- B. Coffee drying carts "carras para secor cafe" (Fig.2a,2b) are again made out of wood. Iron wheels fixed to the carts' frames allow them to be moved easily on wood, cement or iron tracks. The roof of the shelter is made of corrugated metal sheets and serves to protect the drying coffee beans against rain and dew.
- C. Concrete courts "patios de cementos" (Fig.3,4). The concrete courts are cast 10 cm thick and have a slight slope to drain off the rain water. Fig.3 illustrates how the product can be pushed under the small roof for protection against unfavourable weather. In Fig.4, the principle of operation is the same as in Fig.3, except that a mobile roof can be set over the drying product during the night or in case of bad weather conditions.
- D. Marquees of polyethylene and glass "marquesinas de polietileno y vidrio" (Fig.5,6). Fig.5 shows a transparent cover set permanently over the drying produce spread on a wooden surface which is elevated above the ground. Fig.6 represents a variation of the marquee dryer of Fig.5. The structure is somewhat different, having all the sides open to ambient air and a floor made of concrete.
- E. "Elba" house dryer "secadero Elba" (Fig.7). This is another type of dryer extensively used throughout Colombia. The Elba dryer is usually built on top of a flat roof house or storage shed. It has a concrete or wooden floor and concrete walls. The main feature is its hinged roof made of corrugated metal sheet that can be opened for drying and shut during night and rainy periods.

From the description above, the dryers can be classified as (a) tray type dryers and (b) terrace type dryers. "A" and "B" belong to the first group and "C", "D" and "E" belong to the second group.

Location:

These dryers are spread out over the coffee growing zone of Colombia. This region is located between latitudes 1°N and 11°N and meridian 72°W and 78°W, with a height above sea level between 1 200 and 1 800 meters.

Climatological data: Chinchina, Caldas, Colombia

Latitude	75°36'N
Longitude	4°53'W
Altitude	1360 m
Annual Precipitation	2 510,4 mm
Rainy Days/Annum	237
Relative Humidity	75%
Sunshine Hours	1 956,9 hr (45,6%)
Maximum Temperature	30,3°C
Minimum Temperature	14,1°C
Average Ambient Temperature	20,6°C
Observation Period	1941 - 1970

Period of operation:

For many years now, in the coffee producing regions, small and medium production farms have used these types of dryers. CENICAFE does not have information about when the dryers began to be used.

The dryers are used during the harvest period, i.e. from March to May and from September to December, although in some regions they are used all year long at the same time that the crop is being harvested.

At CENICAFE the dryers are tested in field operations and also on an experimental basis.

Drying data:

The dryers are mainly used to dry coffee but they are also used to dry other crops such as maize, beans and cocoa.

Operating procedure:

The procedure outlined here is typical for the drying of parchment coffee. Normally, the beans are placed in the dryer or on the drying surface of the dryer with a moisture content, wet basis, of 50 to 52 percent. These coffee beans also contain some superficial water after washing. Some water is naturally drained off and some is evaporated by solar radiation; the drying process takes place until the moisture content of the beans, wet basis, reaches 11 percent.

The coffee beans are stirred many times, with hand-operated wooden tools, during the drying process. The loading density in the dryer is normally 24 kg of freshly harvested coffee per square meter. The weight of the final product is 12,5 kg per square meter of dry parchment coffee with 11 percent moisture content, wet basis. The drying time is on the average 8 to 9 days. There are about 100 daylight hours during this period, with about 40 sunny hours.

Drying time:

To study the drying time of coffee in the drying trays ("carros para secor cafe") (Fig.2), a test was performed using different quantities of coffee spread on the trays. The results are shown in Table 1.

TABLE 1: Drying Time at Different Layer Thicknesses on Trays

Test number	Thickness of coffee beans on the trays (mm)	Tray Loading Density (kg/m <sup>2</sup> of dry coffee at 11 percent moisture content, wet basis)	Number of Days for Drying (days)	Daylight Hours during Drying Period (hours)	Sunshine Hours during Drying Period (hours)
C/1	8,3	3,125	2,78	33,37	16,5
C/2	16,7	6,250	4,07	48,85	25,9
C/3	33,3	12,500	8,45	101,45	39,5
C/4	50,0	18,750	12,11	145,33	53,6

During the test period the sunshine hours were recorded with a Heliograph and the solar radiation with an Actinometer. Measurements were taken to find out the efficiency of the drying process. The results are shown in Table 2.

TABLE 2: Efficiency of the Drying Process with Different Layer Thicknesses of Coffee Beans

Test number	Thickness of Layer of Coffee beans (mm)	Moisture Removed from Coffee beans Kg/m <sup>2</sup>	Heat Required to Remove Water (kwhr/m <sup>2</sup> )	Total Solar Heat Received (Kwhr/m <sup>2</sup> )	Efficiency (Percent)
C/1	8,3	2,90	1,95	14,2	13,73
C/2	16,7	5,60	3,76	20,5	18,41
C/3	33,3	10,85	7,3	36,7	19,87
C/4	50,0	17,05	11,5	50,7	22,56

At the same time that the above tests were performed, the effect of different types of floors or trays was studied. Four types of floors were chosen and installed on a structure 80 cm high and covered with stabilized polyethylene. The materials tested were: (1) screening; (2) bamboo matting; (3) wood and (4) concrete.

A layer of coffee of thickness 33,3 mm was used (12,5 kg of dry parchment coffee/m<sup>2</sup>). The initial moisture content was 50 to 52 percent wet basis and the final moisture content was 11 percent wet basis.

TABLE 3: Drying Coffee Under a Polyethylene Covered Roof on 4 Different Drying Surfaces

Surface Tested	Moisture Removed from Coffee beans (Kg/m <sup>2</sup> )	Number of Days for Drying (days)	Daylight Hours during Drying Period (hours)	Sunshine Hours during Drying Period (hours)	Heat required to remove water (kwhr/m <sup>2</sup> )	Total Solar Heat Received (kwhr/m <sup>2</sup> )	Efficiency (Percent)
Screen	10,862	11,44	137,33	49,75	7,3	47,8	15,27
Matting	10,925	11,67	140,06	50,78	7,35	48,6	15,12
Wood	11,075	12,02	144,31	53,18	7,45	50,4	14,76
Concrete	11,100	12,50	149,95	54,98	7,45	52,3	14,30

Note: The final weight of dried coffee in each one is 12,5 kg/m<sup>2</sup> (33,3 mm thick)

It should be pointed out that the outside solar radiation received was recorded by means of an instrument located at the meteorological station of CENICAFE. The radiation transmitted through the polyethylene sheeting was not measured.

Comparing test C/3 of Table 2 (33,3 mm layer thickness) which refers to tests without plastic cover, and any one of the tests of Table 3, it was found that there exists a significant difference between the reported efficiencies. This

difference is no doubt due to the polyethylene sheeting energy losses.

The average temperature of the coffee during the tests was 35°C and this figure was used to calculate the energy needed to evaporate the water, assuming a latent heat of vaporization of 0,67 kwhr.

#### Economic Details:

- (1) The costs of the dryers vary depending on the size and regions. On the average, a tray "pasero", Figure 1, is about 2,40 m long x 0,80 m wide and 0,15 m high, and its cost varies between \$2.40 to \$4.00 U.S.\* As the surface of the tray is approximately 1,9 square meters, the cost per square meter of tray area is \$1.25 to \$2.10 U.S.

The cost of the trays (Figure 2) is approximately \$280.00 U.S. and the metal frame end \$200.00 U.S. As the roof and floor surfaces total in area 50 m<sup>2</sup>, the cost per square meter is then \$9.60/m<sup>2</sup> U.S.

The cost of a concrete court (Figure 3) can vary between \$2.00 U.S. to \$3.00/m<sup>2</sup>, without including the roofs to cover the coffee during the night and rainy hours.

A polyethylene marquee costs about \$2.00/m<sup>2</sup> U.S. when made in the simplest way and with the most economical materials. It has an area of 45 m<sup>2</sup>, (9 x 5 m). Using better construction techniques and superior materials, the price will increase. The best ones are made with glass and cost about \$12.00/m<sup>2</sup>, with metal frame and concrete floor.

The "Elba" house type is a unit that adapts the drying roof and its cover to a construction type which serves as a house or a storage area. In this case, the cost varies with the type of construction.

- (2) The dryer is used during the harvest period, from March to May and from September to December, i.e. 7 months per year.
- (3) It is difficult to evaluate the cost of drying per unit of dried materials because it depends on the cost of the unit, the number of workers and the quantity of material dried.
- (4) It is very difficult to estimate the useful life of the dryer but it has been found that the trays "paseras" and carts have a life of 5 to 10 years and the larger dryers such as the "Elba" houses can last 20 years or more depending on the maintenance provided.
- (5) There are no particular technical problems reportedly associated with the construction and operation of the types of dryer herein described. Economic considerations and regional requirements will determine the type of dryer to be used.

#### Comments on the Dryer:

The described models are those used by the farmers and tests were performed to determine their efficiency. The Colombian coffee farmer has traditionally used a similar method, drying coffee on trays and especially on wooden floors.

\* \$1.00 U.S. = 25 colombian pesos

Farmers with less economic means usually dry coffee on concrete or wooden terraces. A farmer with medium resources normally uses plastic or glass transparent covers to protect the beans from the rain.

The sun drying of coffee is widely practised in Colombia. Approximately 70 percent of the yearly national production, i.e. 400,000 tons of dry parchment coffee, is dried by means of solar energy.

The sun drying techniques are well suited to the small and medium scale farm holdings in Colombia. It has been reported that there are two limiting factors for the use of sun dryers for coffee processing in Colombia. The first is that for production larger than 12 tons per year, the drying surfaces required become quite expensive. The second is the weather. The rainy season coincides with the harvest period. Often this tends to lengthen the sun drying process.

Principal Investigator:

Valencia Alvero

Federacion Nacional de Cafeteros de Colombia  
Centro Nacional de Investigaciones de Café (CENICAFE)  
Chinchina, Caldas  
Colombia

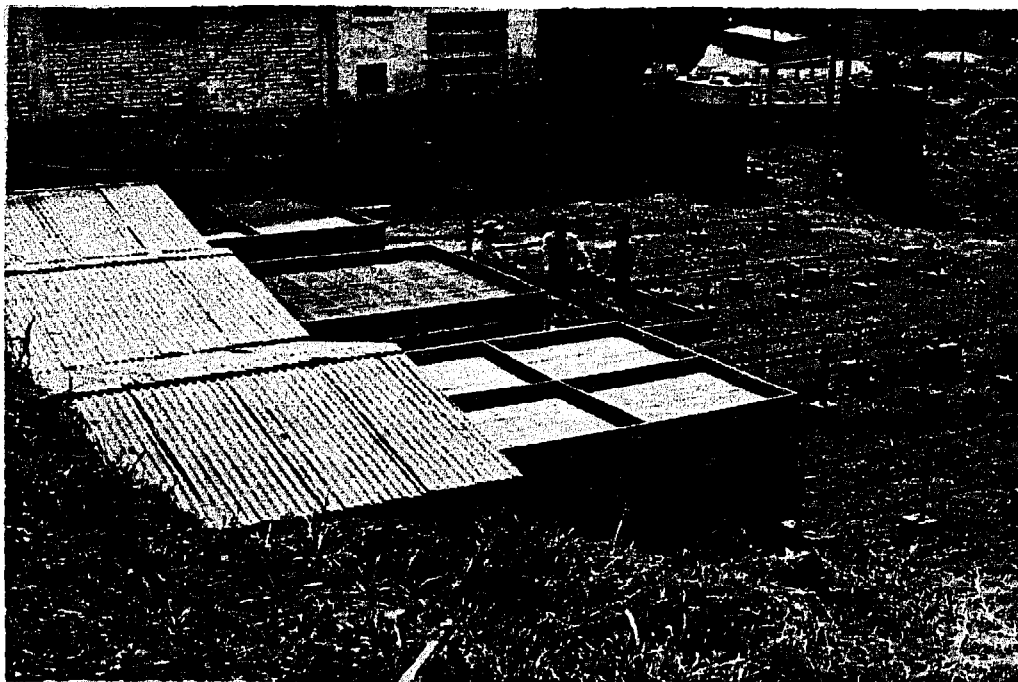


Figure 2a - Coffee drying carts. Each tray has a drying surface of 10 m<sup>2</sup>

Figure 2b. This indicates the operation of the drying carts.

Cette photo montre le fonctionnement des chariots de séchage pendant l'opération.

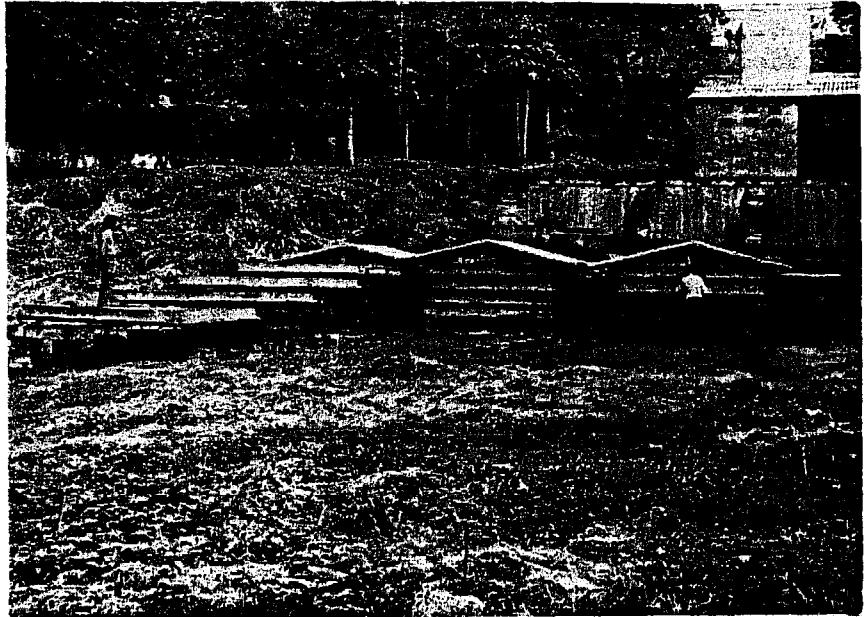


Figure 3. Cement court with small roof to protect the coffee against rain.

Sur cette surface de ciment, des toits mobiles permettent de protéger les grains de café de la pluie.

Figure 4. In the photo, cement courts with moveable roofs are indicated in the right. On the left, a typical "Elba" house for weather protection.

Sur la photo à droite, on aperçoit des terrasses de ciment à toit mobile qui sont utilisées pour le séchage. A gauche, une maison "Elba" typique.

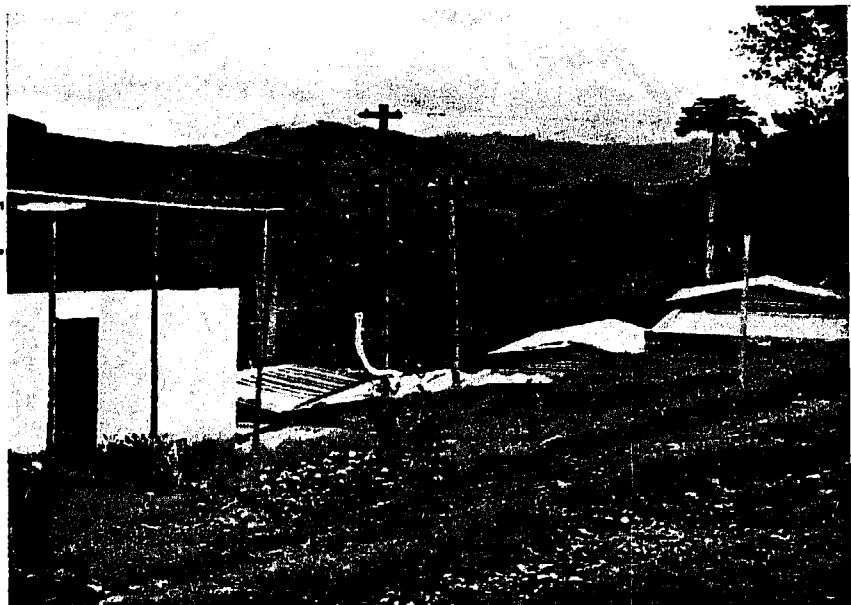




Figure 5. Marquee elevated on posts and covered by a polyethylene cover.

Séchoir marquise monté sur pilotis et recouvert d'un film polyéthylène.

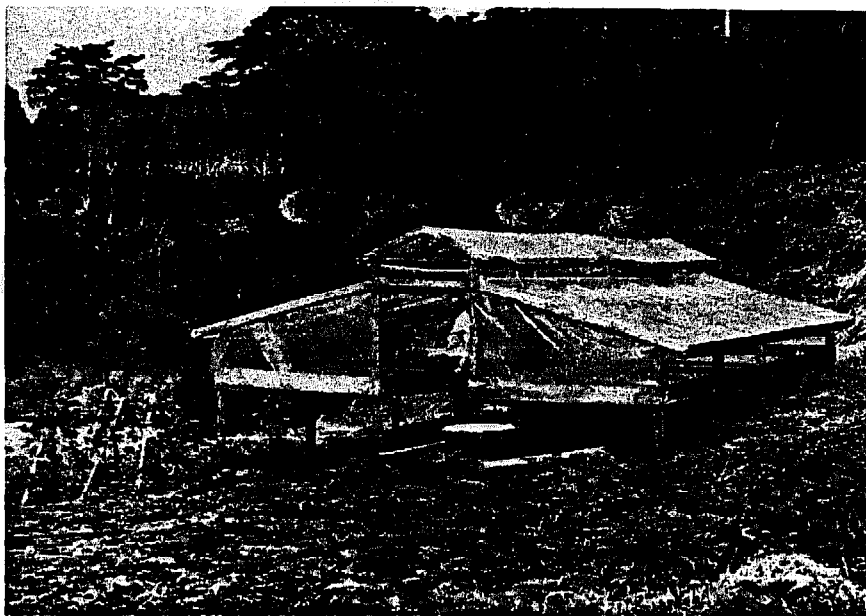
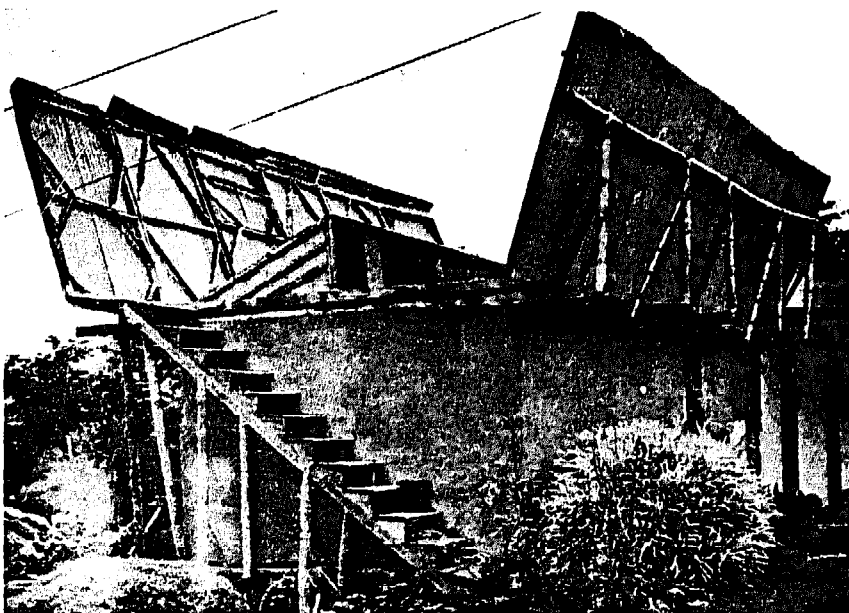


Figure 6. Marquee with cement floor and PVC roofing.

Séchoir marquise avec plancher de ciment et recouvert de PVC.

Figure 7. "Elba" house dryer  
The roof is put back on the house pignon for nights and rainy periods.

Le séchoir maison "Elba".  
On referme le toit sur le pignon de la maison pendant la nuit et durant les périodes de pluie.



DRYING GRAPES ON RACKS (Australia)Overview:

Status: operation

Heating mode: natural

Type: rack-dryer

Air circulation: natural  
airflow

In Australia, natural and sun drying of grapes on racks has been used for quite some time. Large scale drying racks are widely used in the grape growing areas of Australia and in 1972, they dried about 100,000 metric tons of fresh grapes in 8 to 14 days. One 50 meter drying unit is generally considered to provide enough rack space to dry the fruits from three acres of vines during the drying season. (11,640 square metres)



Figure 1 - Grapes drying on racks

Characteristics:

The drying rack consists of 8 to 12 galvanized wire netting tiers spaced vertically. At 3 m intervals along the racks, pairs of intermediate upright posts, imbedded in the ground, carry cross pieces that support the tiers. The wire netting is reinforced lengthwise along both edges with fencing wire. At each end of the rack, the load is taken by two heavy posts, sloped and stayed against the strain with part of their length below ground level.

It should be noted that the rack illustrated in Figure 1 is covered by a sheet metal roof. These roofs are often very practical as they protect the raisins against rain or excessive sun, thus leading to a better quality product. The roof is constructed of corrugated iron sheets fixed crosswise, with equal overhang on both sides of the rack. There should

be no pitch to the roof so that when wind from any direction accompanies rain, it will blow the water on the roof away from the fruit. When there is no wind, the overhang ensures that water drips away from the drying racks. Certain raisin species obtain a superior quality when shade-dried, thus hessian side curtains are often placed on the rack to provide this condition. These curtains are to be avoided in wet climates where excessive humidities will favour mould development. Figure 2 shows the essential components of the structure of the drying racks. It should be noted that the drawing represents only part of the length of the drying rack.

Dimensions: The drying rack is usually 50 to 100 m long, 2,5 m. high and 1,5 m wide. See drawing - figure 2.

Vertical trays spacing: 25 cm

wire netting (5 cm mesh): 1,2 m wide

Two-end sloped posts for taking the load: 3,5 to 4,5 m long set 1,5 m apart and imbedded 1,5 m under the ground

roof: 2,4 m lengths of corrugated iron

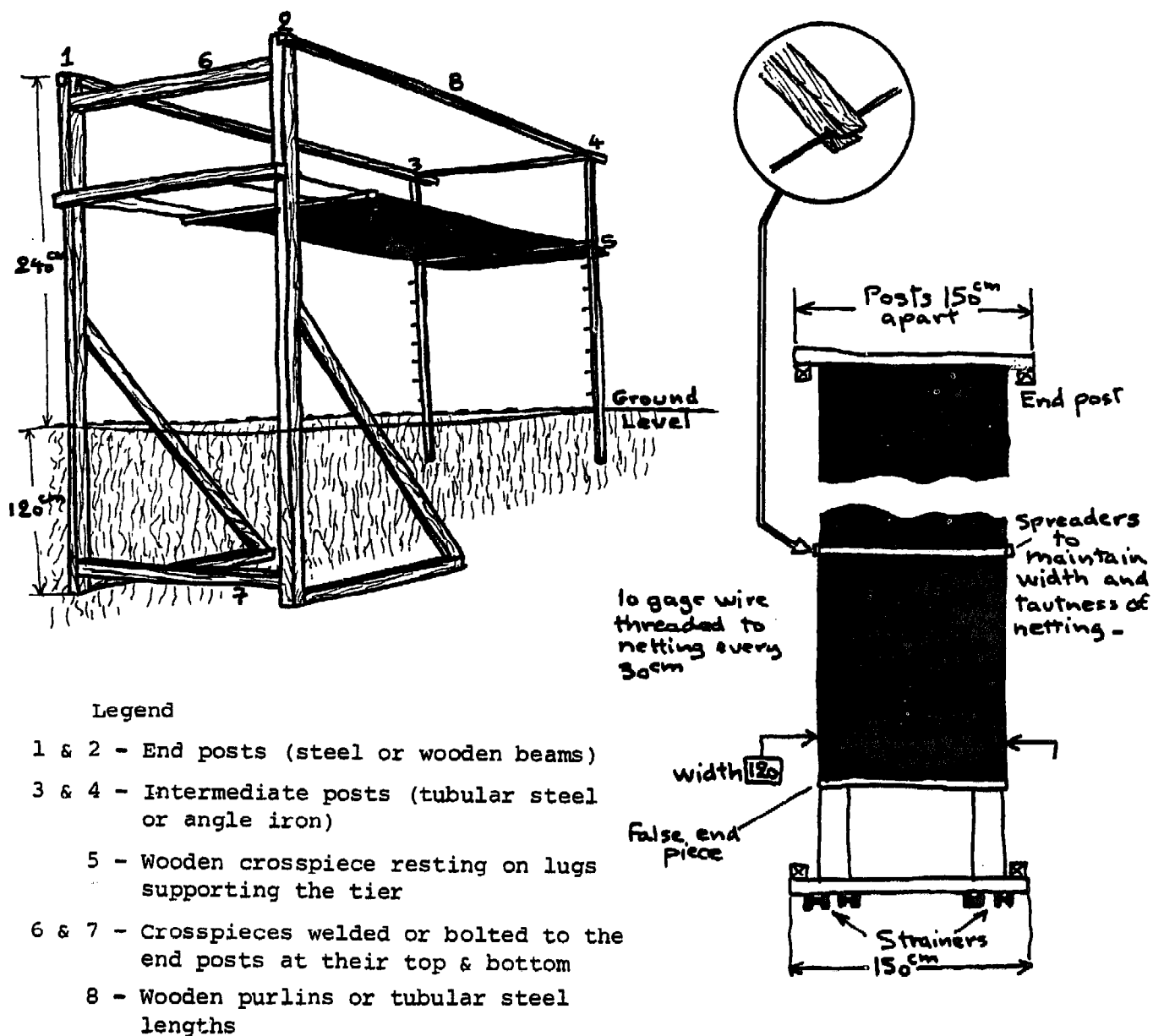


Figure 2 - A widely used method for the construction of the drying racks for grapes.

Materials of Construction:

Frames: Usually steel tubing and/or wooden posts.

Trays: Wire netting

The materials are made in Australia but not all in the immediate locality.

Location of Dryers:

Throughout grapegrowing areas along the Murray River Valley of Australia, especially around Mildura.

Latitude: 34°12'S

Longitude: 142°12'E

Climatological Data:

	Climatic data for Mildura				
	February	March	April	May	Annual
Hours bright sunshine per day	10,3	9,4	7,6	6,2	-
Evaporation (mm)	190	167	102	67	-
Rain (mm)	21	20	16	26	259
Max. temp. °C (mean)	31,1	28,8	23,3	19,4	-
Min. temp. °C (mean)	10,1	12,8	9,5	6,6	-
Relative humidity (15:00 hours) (percent)	32 (Jan)	63 (July)			

Drying Data:

Type of Grapes	Pretreatment	Quantities Dried (tons)		Final Moisture content, wet basis (percent)	Drying time
		Green	Dry		
Currants	None	10	2,5	15,0	2 weeks
Sultanas	Cold dipping*	10	2,5	13,5	8-14 days
Walthem Gross Muscot Gordo Blanco	Hot dipping**	10	2,5	14,0	2 weeks

The quantities dried are given in tons per 50 m of drying rack. It should be noted that the drying times are reduced from about 4 to 5 weeks for untreated rack dried sultanas to 8 to 14 days for treated sultanas dried on a similar rack under average conditions.

\* Cold Dip: 10 Kilograms (Kg) of Potassium Carbonate in 400 litres (lt) of water plus 6 to 8 lt of oil. The oil is a mixture of ethyl ethers of fatty acids and free oleic acids. The solution is used at ambient temperature. The maximum dipping time is 30 min.

\*\*Hot Dip: a) 1,8 Kg of Sodium hydroxide per 450 lt of water at 93°C.  
b) 1,4 Kg of Sodium hydroxide per 450 lt of water at boiling point. The dipping time is 4 seconds.

Practical Operation:

Number of units used in the past: approximately 2 000

Number of units currently in use: approximately 2 000

Periods of Operation:

(a) On experimental basis: 1914-1915

(b) In field operations: 1915 - to date

Operating Conditions:

It is preferable to use these racks in climatic regions characterized by hot, dry weather and gentle winds. The racks may be used under many climatic conditions, and their performance will be contingent on the prevailing local weather. Occasionally, when deemed necessary, the whole rack can be enclosed in plastic, or other sheeting, and heated air pumped in at one end so that it acts as an artificial dehydrator. The racks should preferably be aligned on a North-South axis lengthwise, in order to effectively make use of the early morning and late afternoon solar radiation. It is preferable to locate the racks on a rise of land, clear of any obstructions to permit free air flow. If many racks are used in one location, they should be at least 9 to 12 meters apart. To compensate for slower air movement near the ground, the lower racks are often given a greater tier spacing, up to 36 cm, and the upper racks spacing can be reduced to 18 cm.

Economic Details:

Cost of materials: Not reported. Labour content high.

Annual Operating Expenditure: Maintenance costs almost negligible.

Cost of drying related to the Amount of Materials dried: Not reported.

Estimated Life of the Dryer: 20 to 40 years

Comments on the Dryer:

The loading of the racks with fresh fruit tends to involve a good deal of strenuous effort. In fine drying weather, there are few problems but if rain falls and is not quick followed by drying winds, the fruit can go mouldy on the racks.

Further Information:

Possingham, J.V.  
Chief, CSIRO Division of Horticulture Research  
GPO Box 350, Adelaide  
South Australia 5001  
Australia

Reference:

- (1) Grape Drying in Australia, Dried Fruits Processing Committee, Australia 1973, (CSIRO, Melbourne - ISBN-0-643-00053-4), 23 references, Glossary of Terms

NATURAL VERTICAL DRYER (Colombia)

Overview:

Status: experimental and operational

Heating mode: natural only

Type: vertical-tray dryer

Air circulation: natural  
air flow

This case study presents the main results obtained from testings made on a vertical wire mesh drying system specifically designed for the drying of cassava particles. This drying system utilizes more efficiently the available energy of the ambient air to evaporate the moisture content of cassava. The drying method gives a high quality cassava that is easy to store and handle.

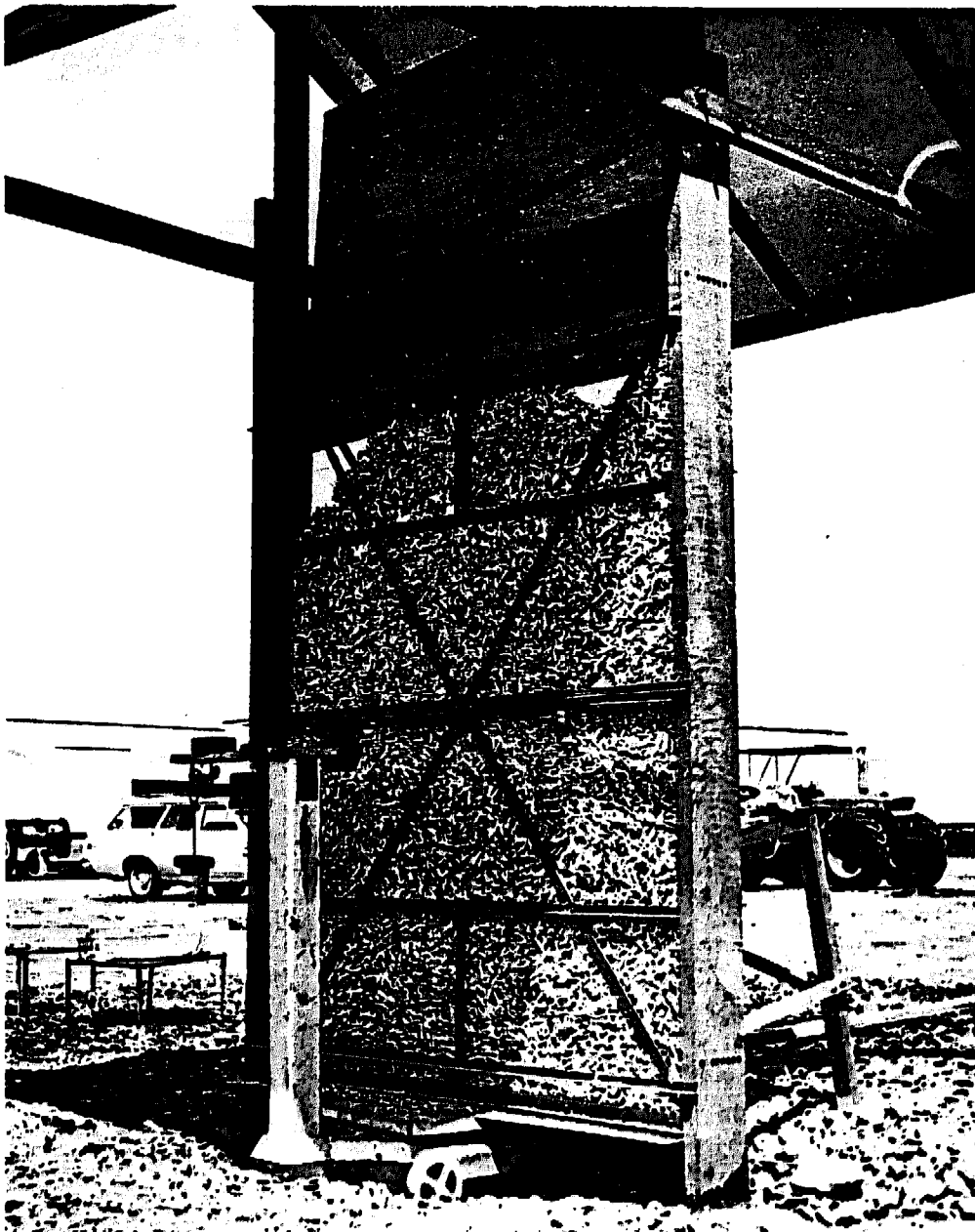


Fig. 1. The natural vertical dryer, loaded with cassava sticks

Characteristics:

The vertical dryer shown in Figure 1, consists of two wire mesh panels pinned on two wooden uprights which are set in the ground and act simultaneously as supports and end walls. Top and bottom openings make the dryer easy to load and unload. The distance between the wire screen walls has been made variable in the experimental prototype so as to allow the drying space to be charged with different loading densities of cassava per square meter of exposed surface. The unit is covered with a wooden roof to protect the product from rain and to allow the drying to continue overnight. This vertical dryer was developed from experiments on several similar prototypes of smaller size. Figure 2 shows a number of these small units under testing.

Dimensions: wire mesh panels: 1,5 m wide x 2 m high  
wooden uprights: 2,6 m high rafters

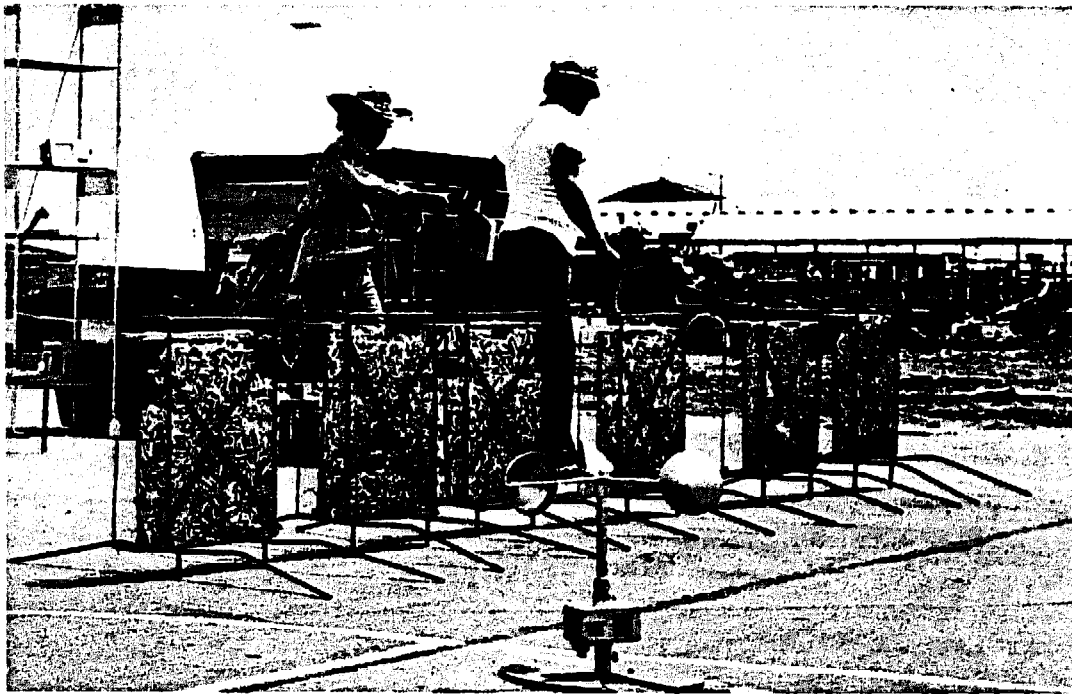


Fig. 2. Small vertical dryers under testing

Materials of Construction:

All the wood used in the construction was locally available. The two uprights were joined on each side by three angle iron bars set horizontally. The vertical wire mesh walls are reinforced with metal crossbars to ensure an even thickness through the drying section.

Location: Centro Internacional de Agricultura Tropical  
C.I.A.T. Experimental Station  
Cali, Colombia

Latitude: 3,5° North  
Longitude: 76,5° West

### Climatological Data:

No general data has been given, but during the series of experiments undertaken, the following data was reported:

Relative humidity	40 to 95%
Wind velocity	0 to 4,5 m/sec
Dry bulb temperature	20 to 35°C
Solar radiation	0 to 75 cal/cm <sup>2</sup> /hr

### Practical Operation:

Number of units used in the past: one

Number of units currently in use: one

### Periods of Operation:

(a) On experimental basis: April 1973 - June 1973

(b) In field operations: (simulated farm conditions: same dates)

### Drying Data:

Cassava pieces with approximate dimensions of 1 cm by 2 cm of section and length variable from 1,0 to 5,0 cm were made using a disc cutter mechanism. These sizes and shapes were determined to maximize the use of wind and natural convection in the drying process. The cut particles were dipped in a 50% alcohol solution for 2 minutes before drying:

Initial moisture content:	66.7 percent wet basis on average
Preferred final moisture content (critical):	14 percent wet basis (Fig.3)
Drying time:	3 days - at optimum layer thickness for the climatic conditions prevailing at time of experiments

Cassava chips, unless they reach 50 percent moisture content (wet basis) in the first day of drying, will deteriorate rapidly in quality. With this condition in mind, charts have been developed which indicate the quantities of Cassava which can be dried given the specific set of climatological conditions occurring on a specific drying day. The charts are presented in Figure 4.

### Operating Conditions:

Cassava chips being white, have a very high reflectivity and do not absorb much incoming solar radiation. This is the reason why this dryer has been designed mainly to improve the use of the air flow. (see Fig.5).

### Economic Details:

Cost of materials:	frame:	\$7.00 U.S./sq.m. of dryer
	wire mesh and frame:	\$4.00 U.S./sq.m. of dryer
	total cost:	about \$20.00 U.S./sq.m. of dryer, including the roof and labour

Significant reductions in costs are expected by using a more simple unit and less expensive materials. No restriction in cost was attempted in the experimental unit.



Cost of Drying related to a Unit of Material Dried:

The first tentative figures are: U.S. \$10.00 per dried ton of cassava of which \$2.50 corresponds to labour cost.

Estimated Life of the Dryer: 10 years

Comments on the Dryer:

- . Construction and operation are simple.
- . Vertical racks are more difficult to fill than inclined wire mesh trays: 20 to 30 minutes are required to load the experimental unit and 10 to 20 minutes to unload the processed product.
- . Drying in vertical dryers takes about one-half the time required for floor and wooden tray sun drying. See Figure 5.
- . Overexposure of the product when drying is completed should be avoided due to possible insect infestation.
- . As cassava is normally grown for periods of 10 to 24 months, the harvesting during the dry season, where the drying conditions are more favourable, is recommended.
- . If the relative humidity on a day is higher than 75%, supplemental heat should be used to assist the drying process. Solar dryers will be the ideal complement of the natural vertical drying racks for this purpose.
- . A mathematical model developed so as to predict with good accuracy the drying performances of the vertical dryer under different climatic conditions. (Figure 4).

Principal Investigator(s): Roa, Gonzola

Department de Ingeniera Agricola  
Universidad del Valle  
Apartado Aereo 21-88  
Cali, Colombia

References:

- (1) Natural Drying of Cassava, Roa, G., Cock, H.J., Proceedings of the Third Symposium of Tropical Root Crops, 2-9 December 1973, Ibadan, Nigeria
- (2) Natural Drying of Cassava, Roa, G., Unpublished Ph.D Thesis, Agricultural Engineering Department, Michigan State University, East Lansing, Michigan, U.S.A.

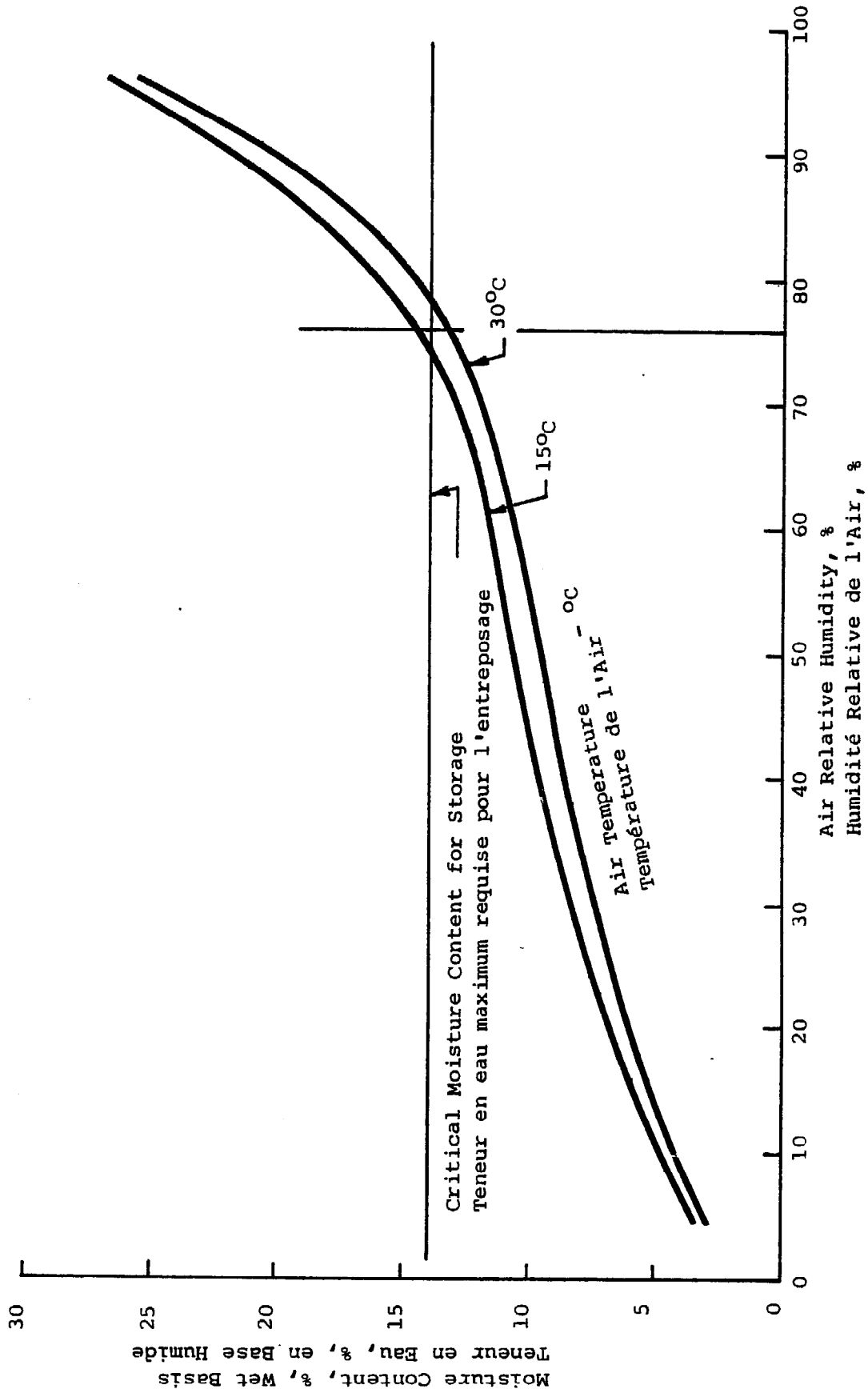


Figure 3. Equilibrium Moisture Content Curves of Cassava  
 Courbes de la Teneur en Eau du Manioc à l'Equilibre

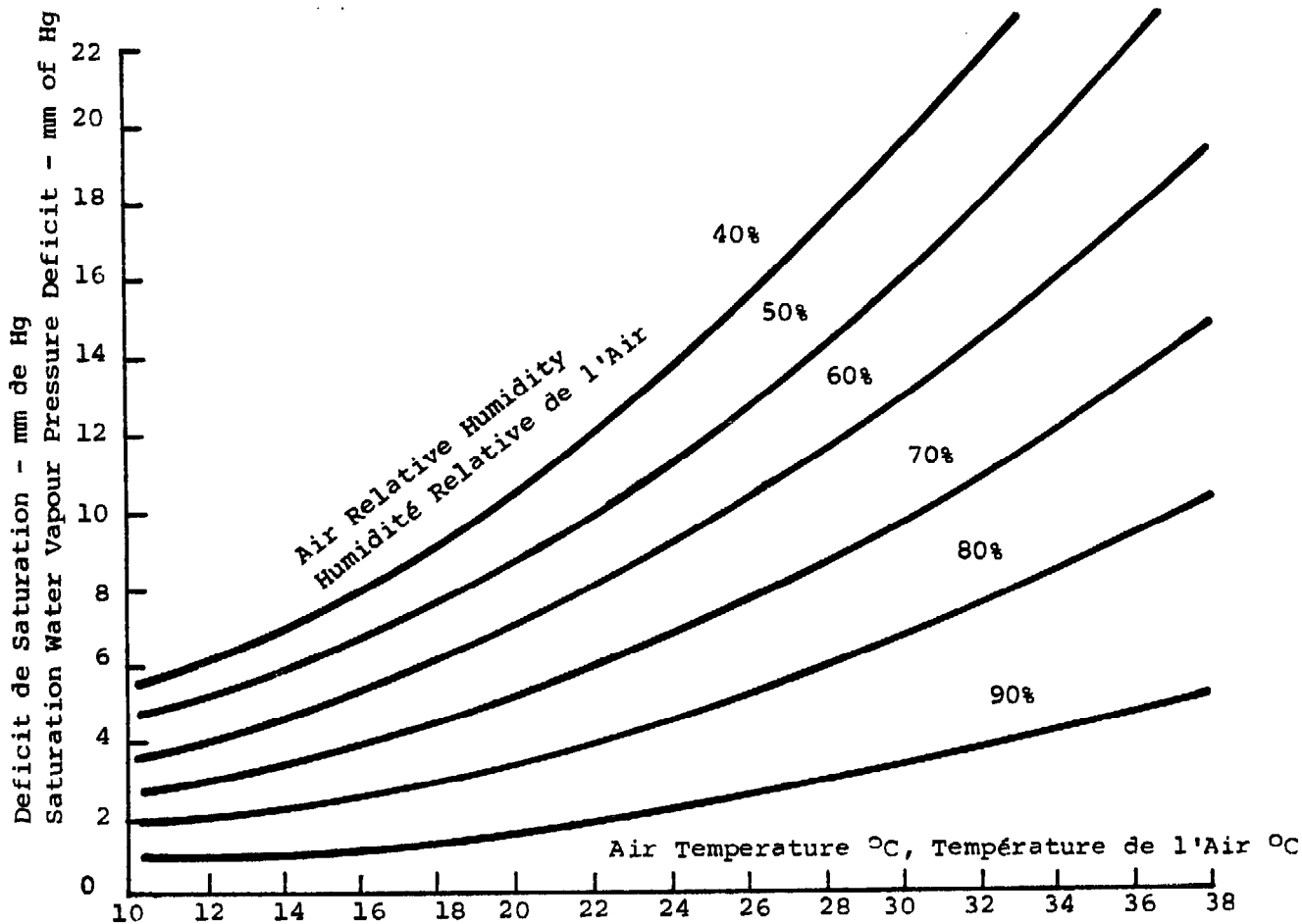
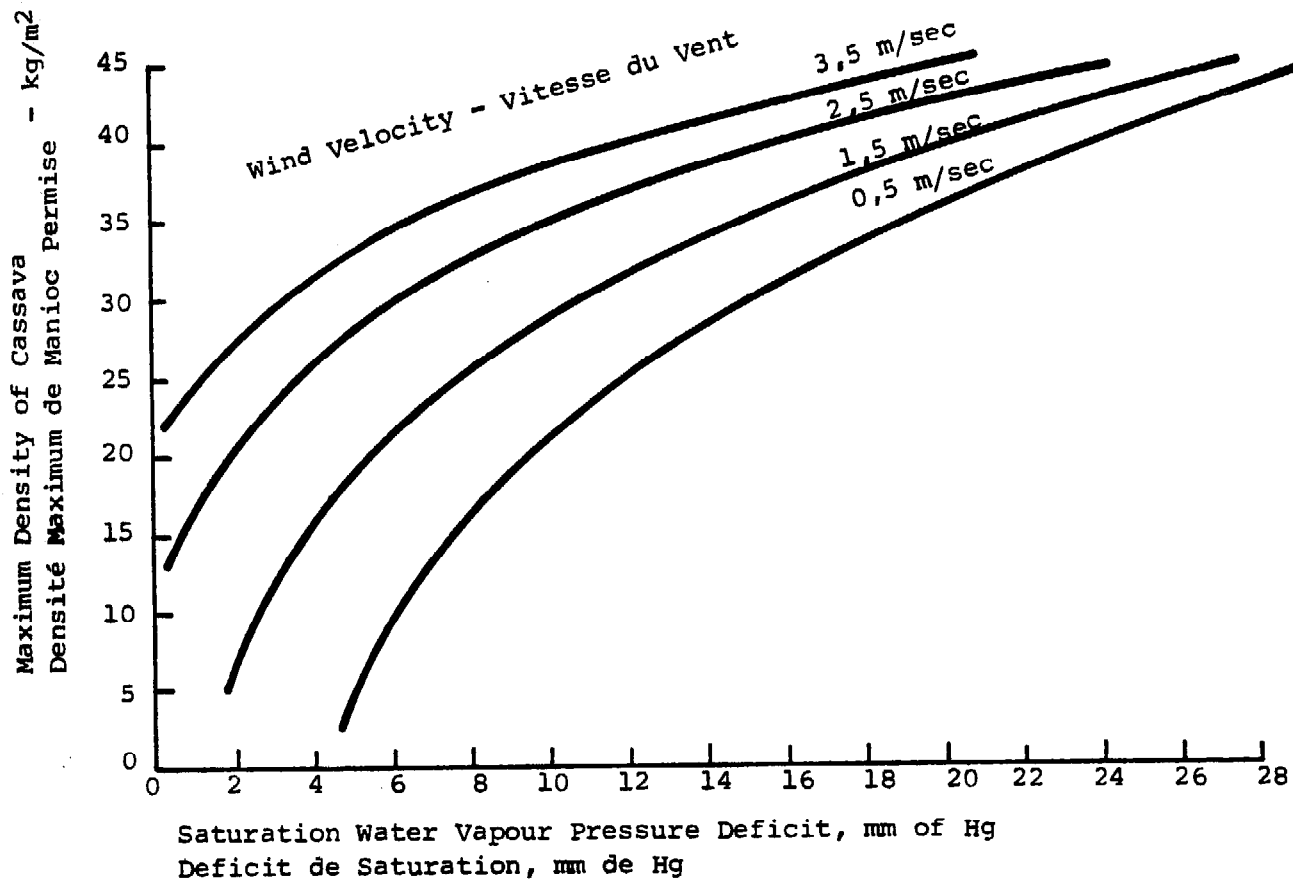
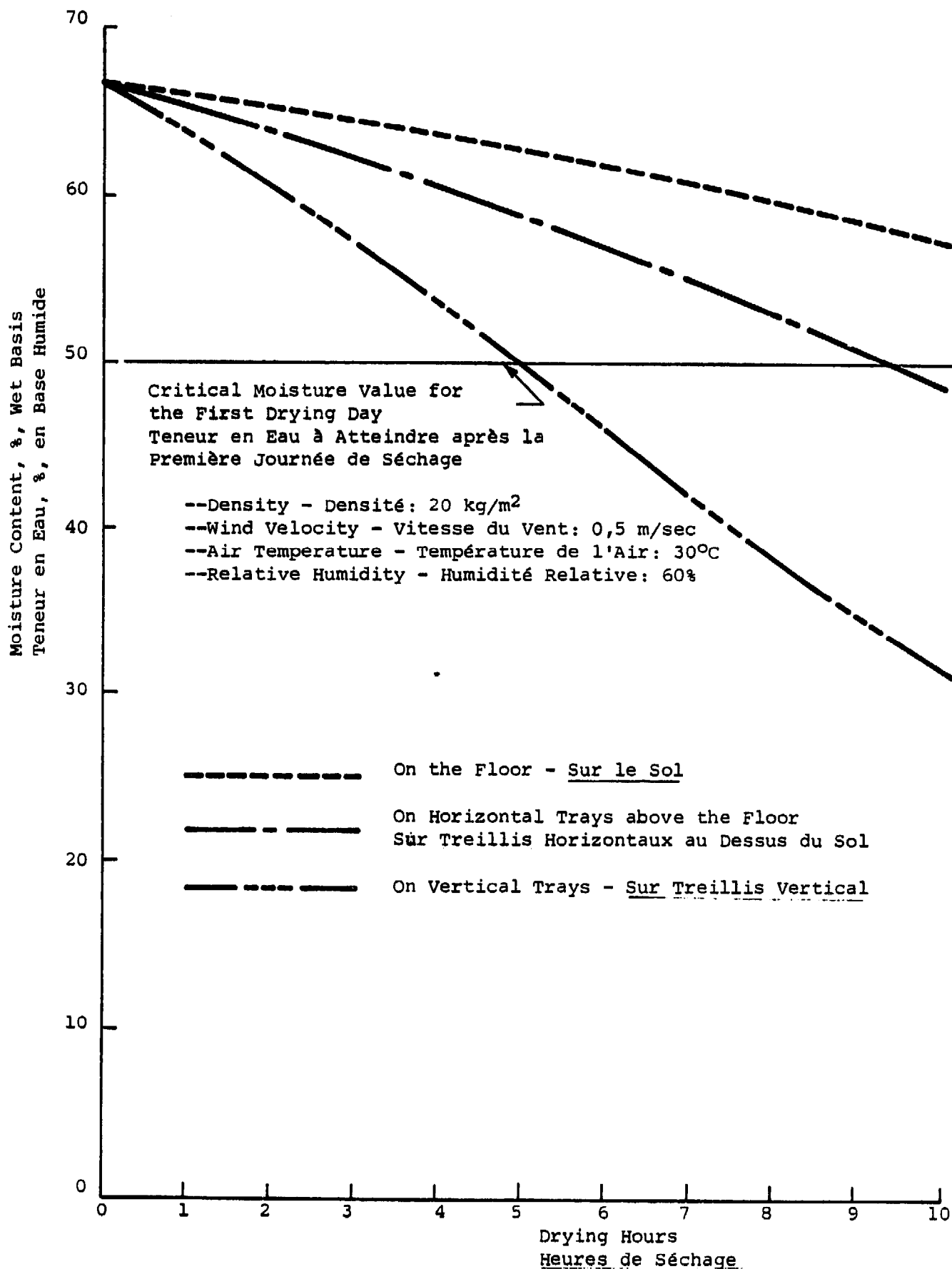


Figure 4. Maximum Density Permissible Under Different Weather Conditions for Use with Vertical Drier Using Disc Bars of Cassava. Time: 11 hrs.

Densité de Chargement de Manioc Permisse pour Différentes Conditions Atmosphériques avec le Séchoir Vertical. Temps: 11 hres.



**Figure 5.** Drying Curves as a Function of Different Drying Systems Using Bars 0,9 x 0,9 x 5,0 cm (Simulated)  
 Courbes de Séchage de Morceaux de Manioc (0,9 x 0,9 x 5,0 cm) pour Différentes Méthodes de Séchage (Simulation)

SOLAR FRUIT DRYER (Brazil)Overview:

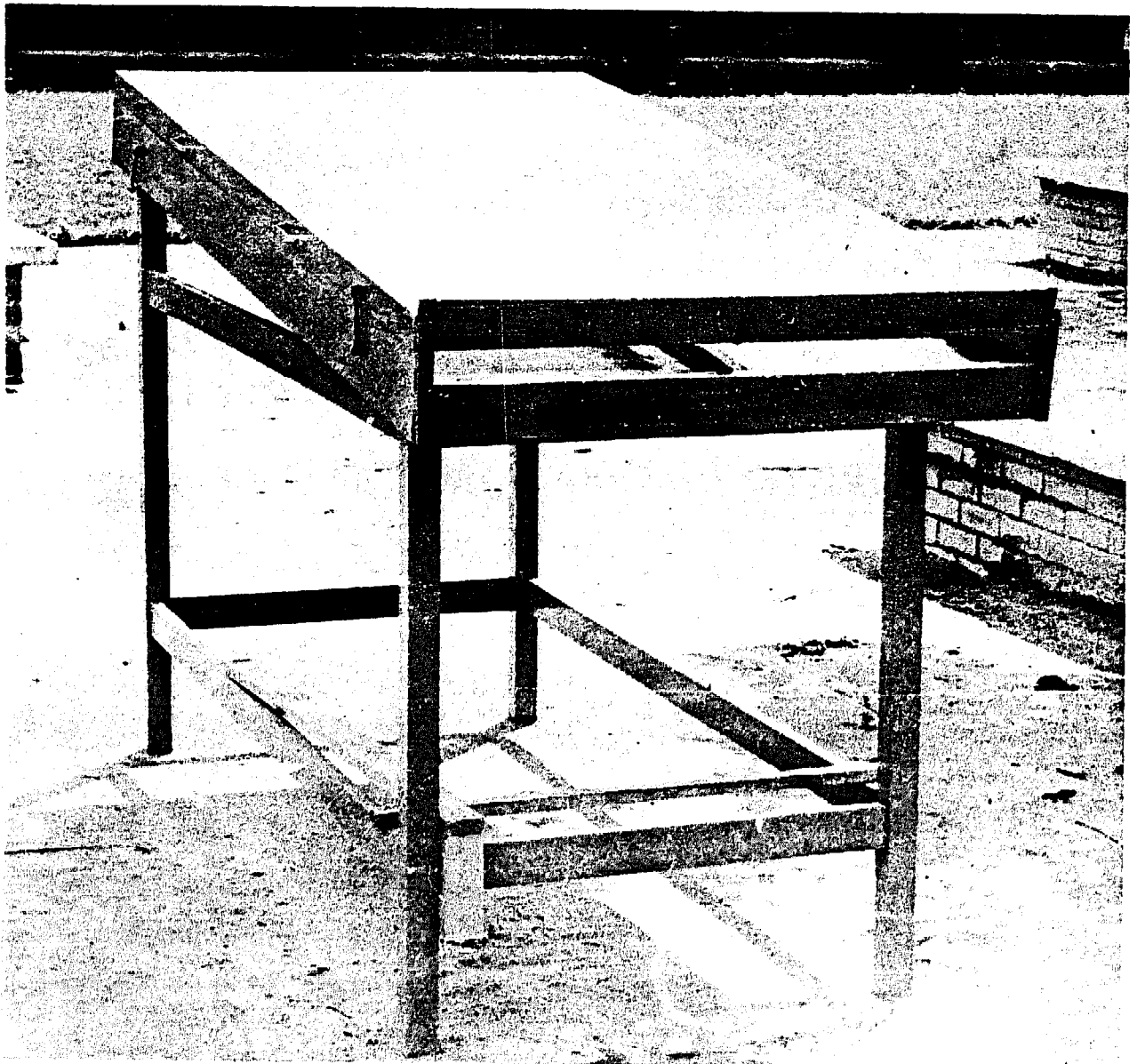
Status: operational

Heating mode: direct

Type: chamber dryer

Air circulation: natural  
convection

This simple dryer has been developed in Brazil and tested for the drying of local fruits. It is very simple to build and the performance reported makes it attractive for the needs of a small community.

Figure 1

### Characteristics:

This small-scale solar dryer is essentially a wooden rectangular box covered by two layers of glass separated by an air gap. The bottom of the dryer is insulated with glass wool sandwiched between an underside plywood sheet and an innerside blackened metallic collector surface. The fruits are spread on the collector surface for drying. The drying chamber is mounted on an upright wood structure and tilted 7° Northward. Only natural convection air circulation is used. The collector heats the inside air which flows over the drying fruits and escapes at the top of the dryer, allowing fresh air to enter at the dryer air inlet.

Dimensions of the dryer: See Figure 2.

### Materials of Construction:

#### Drying Chamber:

Transparent cover: 8 sheets of glass, 3 mm thick  
Frames: a plywood sheet, 12 mm thick and 15 m of  
70 x 30 mm wooden bars  
Insulation: 2 Kg of glass wool  
Trays: 2 m<sup>2</sup> of galvanized iron sheet, 0,8 mm thick.  
Fixed trays are used.

Location: Campus of Escola de Agronomia at Areia, Paraiba, Brazil

Latitude: 6°59'S  
Longitude: 36°10'W  
Altitude: 618 m

### Climatological Data:

Sunshine hours: 2 400 per year, 54,8% of the theoretical total  
Annual rainfall: 1 470 mm  
Relative humidity: 80%  
Average temperature: 23°C  
Maximum temperature: 26,7°C (average)  
Minimum temperature: 19,1°C (average)

### Practical Operation:

Number of units used in the past: 2  
Number of units currently in use: 4

### Periods of Operation:

(a) On Experimental Basis: -  
(b) In Field Operations: May 1973 to present

Drying Data:

<u>Material</u>	<u>Number of fruits dried per load</u>	<u>Pre-treatment</u>	<u>Percent dehydrated</u>	<u>Hours of insolation</u>
Banana	200	peeled & sliced	60%	10-14
Banana	200	peeled & sliced	over 85%	15-24
Pineapple	6	peeled & sliced	88%	10-15
Cashew	200	peeled	85%	10-14

Economic Details:

Cost of materials:

<u>Material</u>	<u>Unit</u>	<u>Unit Cost U.S. \$</u>	<u>Total U.S. \$</u>
glass sheet	m <sup>2</sup>	5,88	11,76
glass wool	Kg	1,40	1,40
plywood	m <sup>2</sup>	8,50	17,00
wooden bars	m	0,50	7,50
galvanized iron	m <sup>2</sup>	6,62	13,24
screws, hinges, etc.	-	-	1,00
mastic	Kg	0,40	0,40
construction	-	-	10,00
painting	-	-	1,80
<b>TOTAL</b>			<b>64,10</b>

All of these materials are locally available.

At this point in time there is not enough data to calculate the annual expenditures and the costs per unit of material dried.

Estimated Life of the Dryer: about 5 years

Comments on the Dryer:

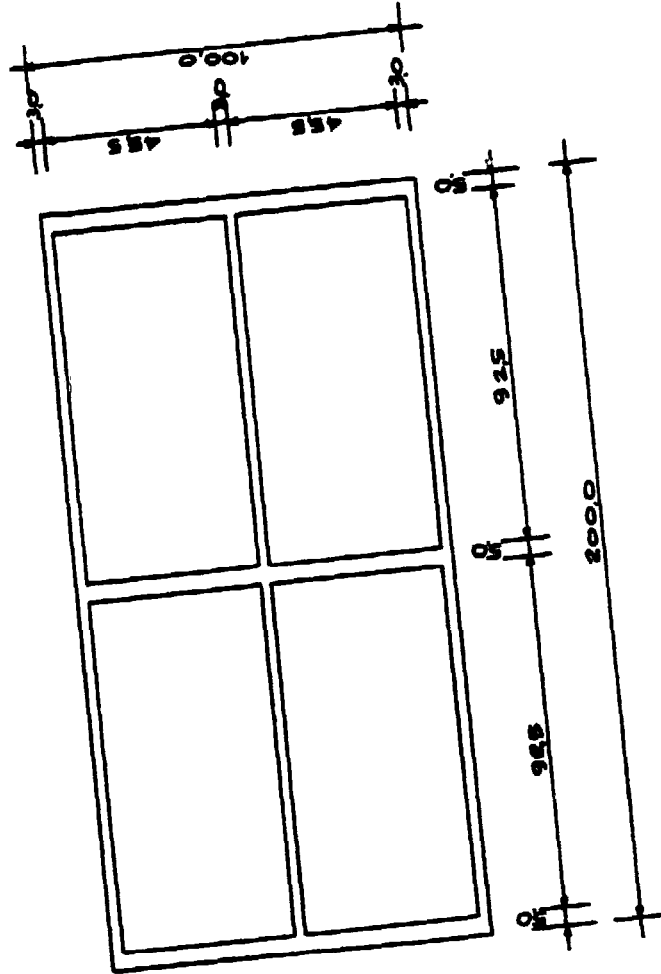
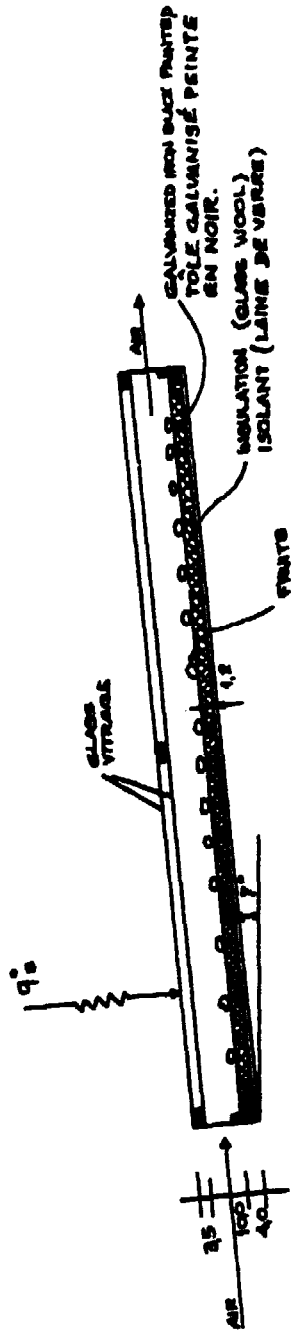
The principal operational problem is that the mastic used does not completely seal the joints and allows the penetration of rainwater in the space between the glass sheets.

The limiting factor for the extension of use of the dryers is mainly the absence of a tradition in the use of such a technology.

Principal Investigator(s):

Pinheiro Kluppel, Rogerio  
Martins de Abreu, Paulo

Laboratorio de Energia Solar de U.F.Pb.  
Centro de Tecnologia - Cidade Universitaria  
Joao Pessoa, Paraiba  
58000 - Brazil



SCALE - ECHELLE - ESCALA 1 / 20  
 DIMENSION EN/M CENTIMETRES - MEDIDAS EN CENTIMETRO

FIG. No. 2



SOLAR CABINET DRYER (SYRIA)Overview:

Status:	operation	Heating mode:	direct
Type:	chamber dryer	Air circulation:	natural convection

This dryer type is a widely available design of direct solar dryer. It is easy to build from almost any kind of available building materials and simple to operate, maintain and control. It is a small-scale dryer versatile in operation and it can be used to dry a wide variety of agricultural products. Tested and utilized in many countries and under many different climates, this dryer has proven to be a very effective and useful device for small-scale food preservation.

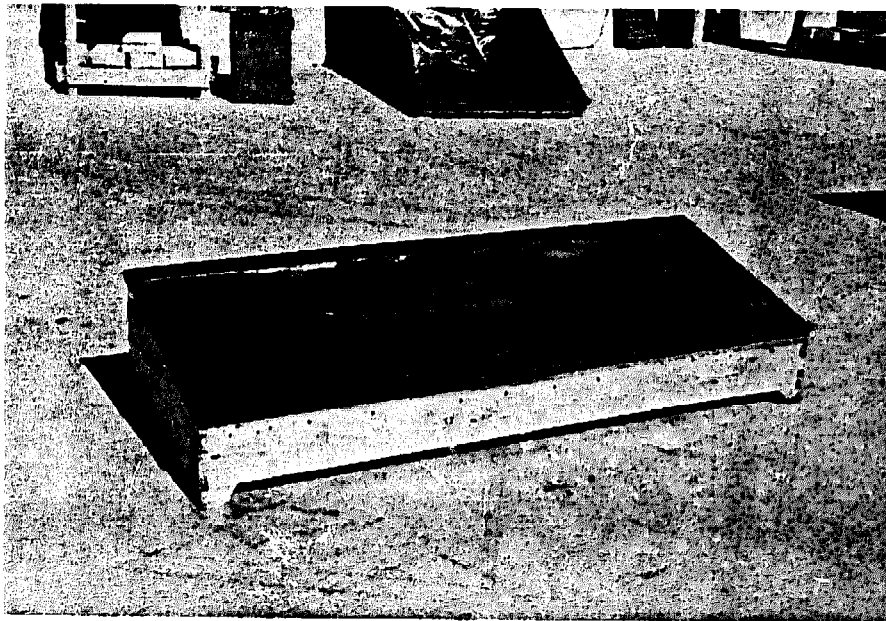


Figure 1

Characteristics:

The dryer is essentially a solar hot box, in which fruit, vegetables or other matter can be dehydrated on a small-scale. In essence it consists of a rectangular container, insulated at its base and preferably at the sides, and covered with a double-layered transparent roof. Solar radiation is transmitted through the roof and absorbed on the blackened interior surfaces. Owing to the insulation, the internal temperature is raised. Holes are drilled through the base to permit fresh ventilating air entry into the cabinet. Outlet ports are located on the upper parts of the cabinet side and rear panels. As the temperature increases, warm air passes out of these upper apertures by natural convection, creating a partial vacuum and drawing fresh air up through the base. As a result there is a constant perceptible flow of air over the drying matter, which is placed on perforated trays on the interior cabinet base.

Dimensions: See Figure 2 and also the following case study.

### Location and Climatological Data:

This type of dryer has now been in use successfully in many locations throughout the world and in varying climatic conditions. Originally, the solar cabinet dryer was developed and tested in Douma, Syria and in Barbados, West Indies.

### Methods and Materials of Construction:

There are many forms which the construction of such a dryer can take. Nevertheless, the following general recommendations can be applied to all dryers of this type: (see figures No. 1 and 2)

- (1) the length of the cabinet should be at least three times the width so as to minimize the shading effect of the side panels.
- (2) the angle of the slope of the roof covering should be taken from Figure No. 3. This gives the optimum angle for drying seasons as a function of the latitude. The graph is equally applicable to areas north and south of the equator. Note that for latitudes less than 20° North or South of the equator, the slope of the transparent roof is constant at 6°. This is to allow a minimum difference in elevation from one side of the collector to the other in order to permit adequate convective air circulation over the drying area.
- (3) the transparent cover should be made from two layers of either of the following:
  - (a) Glass panes (2 mm thick)
  - (b) Plastic film (about 0,13 mm thick)

In general, the covers made with plastic film have a limited life. It is therefore necessary to use films which have been treated to give protection against ultra-violet radiation. The latter can be polyester, polyvinyl chloride or polyethylene. Generally films of the polyethylene or cellulose acetate types should not be used due to their limited life. They would have to be replaced at the end of each drying season and might not give as favourable results in service. Although it may be advantageous to replace covers seasonally in certain cases, trouble may occur with films not being able to withstand the high cabinet temperatures generated. These may reach as high as 80 to 100 degrees centigrade in some dryers. We would advise people interested in this type of unit to use ordinary window glass, supported by a suitable frame to their installations. The use of a sealant to hold it to the frame is a possibility, but if a sealant is not used, the glass should be held firmly in place by a suitable frame, painted black.

- (4) In general, the framework of the cabinet may be constructed as follows:
  - (a) Portable Models: wood, metal, hardboard, plywood for the more sophisticated units or basketwork, wicker or bamboo for the more primitive units. Perforated cabinet bases and side panels might possibly be fabricated by placing insulation between layers of blackened wicker or open basketwork. This would cut down costs and make use of local industry.
  - (b) Permanent Structures: adobe, brick, stone or concrete.

- (5) The insulation should consist of locally available materials such as wood shavings, sawdust, bagasse, coconut fibre, reject wool and animal hair. In areas affected by wood ants, termites or other noxious insects, the susceptible materials should be properly protected before being placed in the insulation base.
- (6) The hot box should be constructed along the lines outlined in figures No. 1 and 2. The insulating layers should be at least 5 cm thick, both at the base and side sections. Holes should be drilled in the insulated base and fitted with short lengths of plastic and rubberized garden hose (or bamboo, etc., if available). Where insect infestation is prevalent, all cabinet apertures should be covered with fine mosquito netting, (preferably fibreglass) or gauze. Generally the high temperature of the cabinet interior discourages insects, rodents, etc., from entering and feeding on the drying produce. Furthermore, in arid areas where there is a high concentration of airborne dust and debris, the transparent cover eliminates product contamination.
- (7) The transparent cover can be attached to a frame which can then be fixed to the chassis of the cabinet. Care must be taken to ensure that the cover is completely watertight so as to avoid deterioration of the interior and wetting of the insulation. All components of the cover framework should be painted black or some other convenient dark colour to absorb the maximum solar radiation. Hold down strips should be secured to the upper exterior rim of the cover frame to protect the film against excessive wind suction lift.
- (8) Once the cover and chassis are secured, several holes should be drilled in the rear and side panels. These provide the exit ventilation ports to remove the warm, moist air. The number of holes is dependant on the climatic conditions and the nature of the drying material. A satisfactory method is to initiate the dryer with a minimum of side ventilation ports and to drill further holes as needed so as to prevent internal moisture condensation. This method prevents an excess of ventilation ports being drilled.
- (9) The rear panel should be fitted with access doors to give entry into the cabinet. All doors should be placed on the rear side to prevent excessive shadowing of the dryer during handling operations.
- (10) Trays should be constructed as indicated, of galvanized chickenwire or some similar material. They should be placed on runners a few centimetres high so as to ensure a reasonable level of air circulation under and around the drying material.
- (11) The interior of the cabinet should be painted black. The exteriors of the side, rear and base panels should be painted with aluminum paint. If desired, the interiors of the side and rear panels can be covered with a layer of aluminum foil. If the latter is not available, paint these surfaces black.

#### Operation of the Dryer:

The dryer operation is not complicated. The produce to be dried should be pretreated in the usual manner (i.e. blanched and fumigated) and placed on the perforated trays, at a loading rate of about 7,5 kgs/meter<sup>2</sup> of drying area. A small thermometer inserted into one of the ventilation ports will

prove very handy. The thermometer bulb should be shielded from the direct rays of the sun. The upper temperature limits which can be withstood by agricultural produce vary substantially.

Where the drying produce might suffer from the direct sun-rays or where the light colour of the produce reflects much of the incident radiation, it is advisable to cover the loaded trays in the dryer with a black plastic mesh or black gauze. This should not inhibit the flow of air through the trays, but will absorb the radiation and transmit the heat to the produce through conduction and convection. The resultant temperature increase can be controlled by opening the rear access doors. This approximate temperature control system can easily be mastered with time and experience.

The following table on drying data gives some indication of the temperature limits and possible throughputs available with a dryer of the size and specifications shown in this case study. The table give yields for dry, arid, cloudless Mediterranean type climates. The yields should be suitably modified for the cloudy, more humid temperate and tropical regimes.

#### Drying Data:

<u>Produce</u>	<u>Amount of Fresh Matter Dried per Unit Time (Kgs)</u>	<u>Maximum Allowable Temperature (°C)</u>
Apricots	4,0 per two days	66
Garlic	2,6 per two days	60
Grapes	5,7 per four days	88
Okra	3,0 per two days	66
Onions	3,0 per two days	71

#### Capital Costs:

An evaluation of a similar unit in Damascus, Syria where the initial development work was undertaken, showed a total cost of \$14.00 U.S. (\$12.75 per square meter) as compared with about \$21.00 U.S. (\$19.00 per square meter) for Barbados. In each case the labour costs were identical. However more of the materials required are manufactured locally in Syria resulting in a lower materials cost. Experiences in India and Africa show that this type of dryer can be constructed for approximately the same price.

#### Operating Costs:

The amount of annual maintenance on the dryer is small, consisting mainly of keeping the transparent covers and interior of the cabinet clean. The unit could perhaps be repainted annually; however, this is not expensive. In humid tropical climates, assume the total life of a plastic covered unit as 5 years.

Cost/Year \$U.S.

Depreciation of Dryer (5 years life)	4.20
Annual Maintenance Costs	.60
Interest on Capital Investment (6%)	1.25
Contingencies (5%)	.30
	<hr/>
Annual Operating Costs	6.35

This represents an operating cost of \$5.50 (U.S.) per square meter of drying area. Again when contrasted with a similar study in Syria, the operating cost there was about \$2.75 (U.S.) per square meter. If a glass cover were to be used, a longer life duration might be expected. In general, it has been found that this type of dryer results in an average production cost increase of 3%.

Comments:

In some cases it is preferable to have a plastic cover rather than a glass cover, to prevent breakage by flying stones, etc. However, the glass would normally have a longer life so that, in the final analysis, the farmer himself must decide which is the more economical and acceptable for him. Presumably if the dryer was placed on a building roof, the glass might last 10 to 20 years without breakage.

With regard to labour costs, it must be stressed that all the construction to be undertaken is quite simple and could be performed easily by the farmer himself using simple hand tools. This would reduce the financial outlay of the farmer by about 25%.

A very practical auxiliary application of the dryer is for warming foods and other materials. It is particularly advantageous as a self-contained source of heat at 70-80 degrees centigrade in the field and in isolated farm areas.

Principal Investigator(s): Lawand, T.A.  
Brace Research Institute  
Macdonald College of McGill University  
Ste. Anne de Bellevue  
Québec H3A 1C0, Canada

References:

- 1) Lawand, T.A. A Solar Cabinet Dryer, Solar Energy, Vol. 10, No. 4, pp. 158-164, October 1966.
- 2) Brace Research Institute, Leaflet No. L-6, How to Make a Solar Cabinet Dryer for Agricultural Produce, 11 pages, March 1965, Revised March 1973.

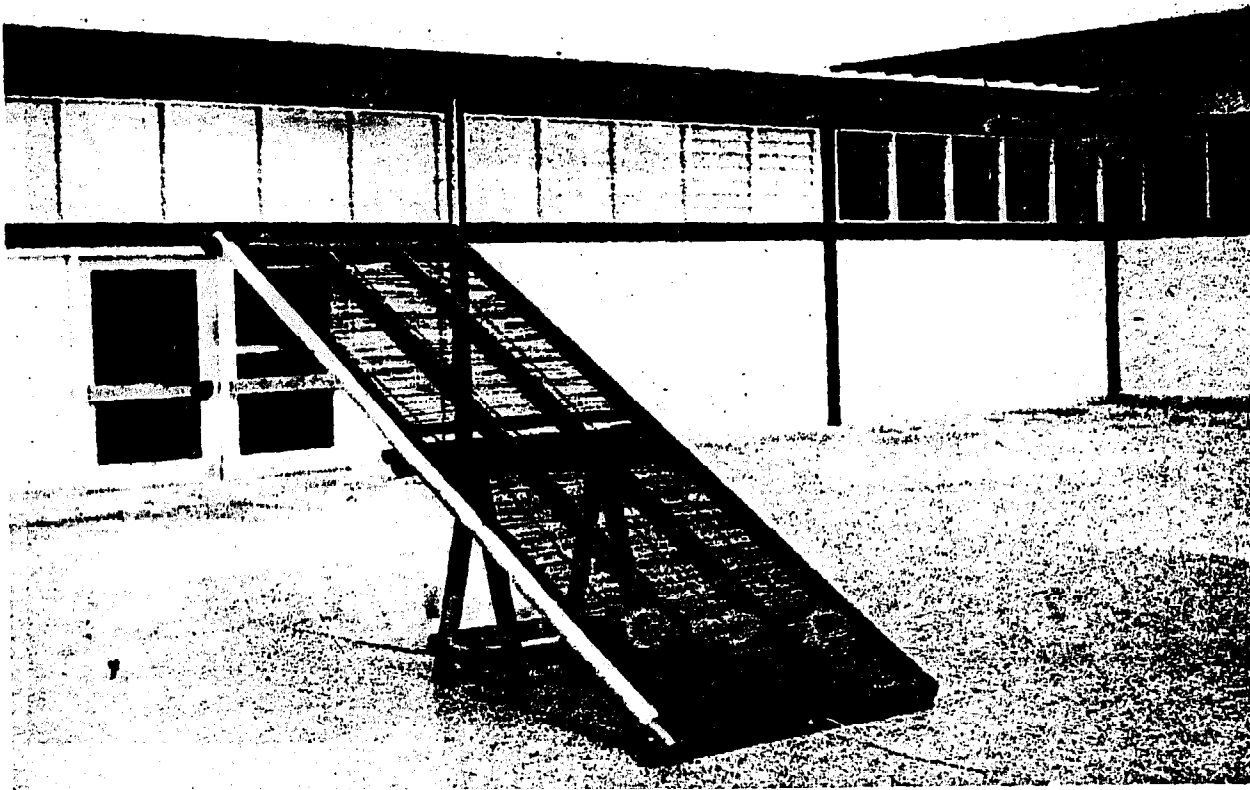


Figure 1. First Position of the Drier at 30°.   
 Position initiale du Séchoir - 30°.

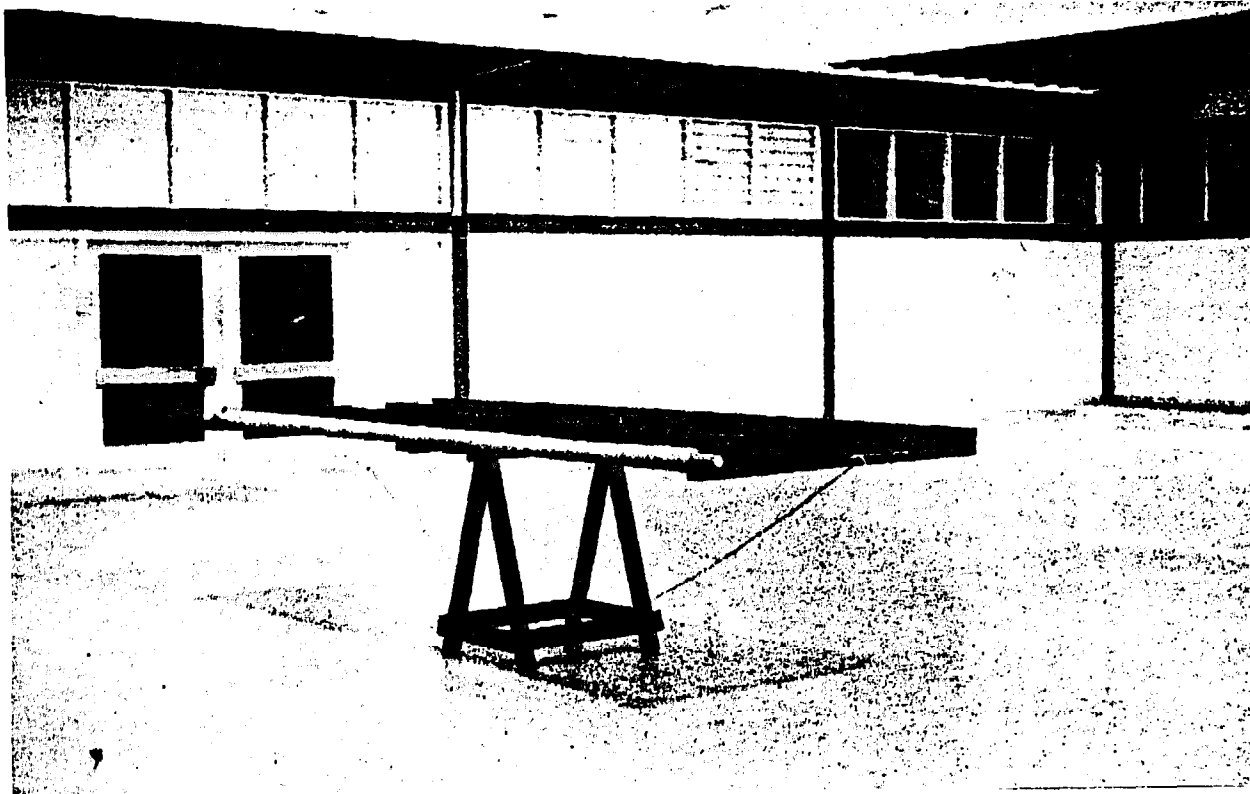


Figure 2. Horizontal Position   
 Séchoir en Position Horizontale

Climatological Data:

Not reported.

Practical Operation:

Number of units used in the past: not reported

Number of units currently in use: not reported

Only tested on an experimental basis to date.

Drying Data:

Quantities Dried:

The quantity of cocoa that can be handled depends mainly on the climatic conditions at the time of loading. With strong sunshine and low humidity, about 45 Kg of fermented cocoa per square meter of effective surface can be loaded. If the climatic conditions are unfavourable, (high humidity, low solar intensity), the cocoa load should not exceed 20 to 25 Kg/m<sup>2</sup> of useful surface.

Drying Time:

Compared with natural and sun drying techniques, the drying time can be reduced by two days when the climatic conditions are unfavourable. On the other hand, in a climate favourable to drying, this difference is less important. The water content of cocoa at the end of the drying period is within 7 to 8% (wet basis) which is impossible to reach with other methods.

Operating Conditions:

It is absolutely essential to stir the cocoa at least once a day. For practical operation, the thickness of the cocoa layer should not exceed half the depth of the dryer.

Economic Details:

The economic details presented here apply to a different see-saw dryer than the one described before, in that its overall dimensions are 5 m x 1,5 m x 8 cm.

<u>Cost of Materials:</u>	wood for frame	5,35	\$U.S.
	beading, nails	2,50	
	bamboo or raffia base	2,85	
	plastic cover, P.V.C.	1,75	

(\$1.00 U.S. approximately worth 280 Fr.CFA) 12,45 \$U.S. (1968)

These are estimated costs to which must be added labour cost. An estimate of the construction costs of a see-saw dryer of the dimensions included in the attached set of plans was prepared in Ghana in 1970 and gave a total price of about \$18,00 U.S., including work. An Ivory Coast cocoa plantation produces about 1000 Kg of cocoa per hectare per season. This production is harvested in many collecting operations made every 2 weeks, the largest of which can yield 200 Kg of fermented cocoa at 50% moisture content (wet basis), ready for the drying operation. Assuming a total price of \$18,00 for each unit, then the investment amounts to \$72 00 divided by 1000 Kg of freshly harvested cocoa; that is 7,2 cents per Kg. As the unit life expectancy is about 3 years, it would appear reasonable to assess yearly redemption of less than 3 cents per Kg of fresh cocoa.

Estimated Life of the Dryer: 3 years

Comments on the Dryer:

It has some technical problems such as condensation of water vapour in regions where temperature variations are high, and low resistance of P.V.C. cover.

In some regions, where the income level of the local population is very low, the price of the dryer might prove to be limiting. If the dryer can be easily made of materials almost entirely available to the local inhabitants, then the dryer seems quite appropriate, in particular for the drying of material needing stirring.

Principal Investigator(s): Richard, M.  
Vincent, M.  
  
Institut Français du Café et du Cacao  
34, rue des Renaudes, 75017 Paris  
France

Reference:

- (1) Richard, M., Un nouveau type de séchoir expérimenté en Côte d'Ivoire, Café, cacao, thé, Vol. XIII, #1, janvier - mars 1969, pp. 57-64
- (2) Ministry of Planning, Institute for Tropical Agricultural Product, See-saw sun dryer perfected by ITIPAT, Abidjan, Technology and Industrialization, B.P. 4549, Abidjan, Côte d'Ivoire, June 1966, 20 pages
- (3) McLean, K., Principles of sun drying with special references to a see-saw dryer., FAO, Rome 1972, Report AGS, SF/GHA7, 40 pages.

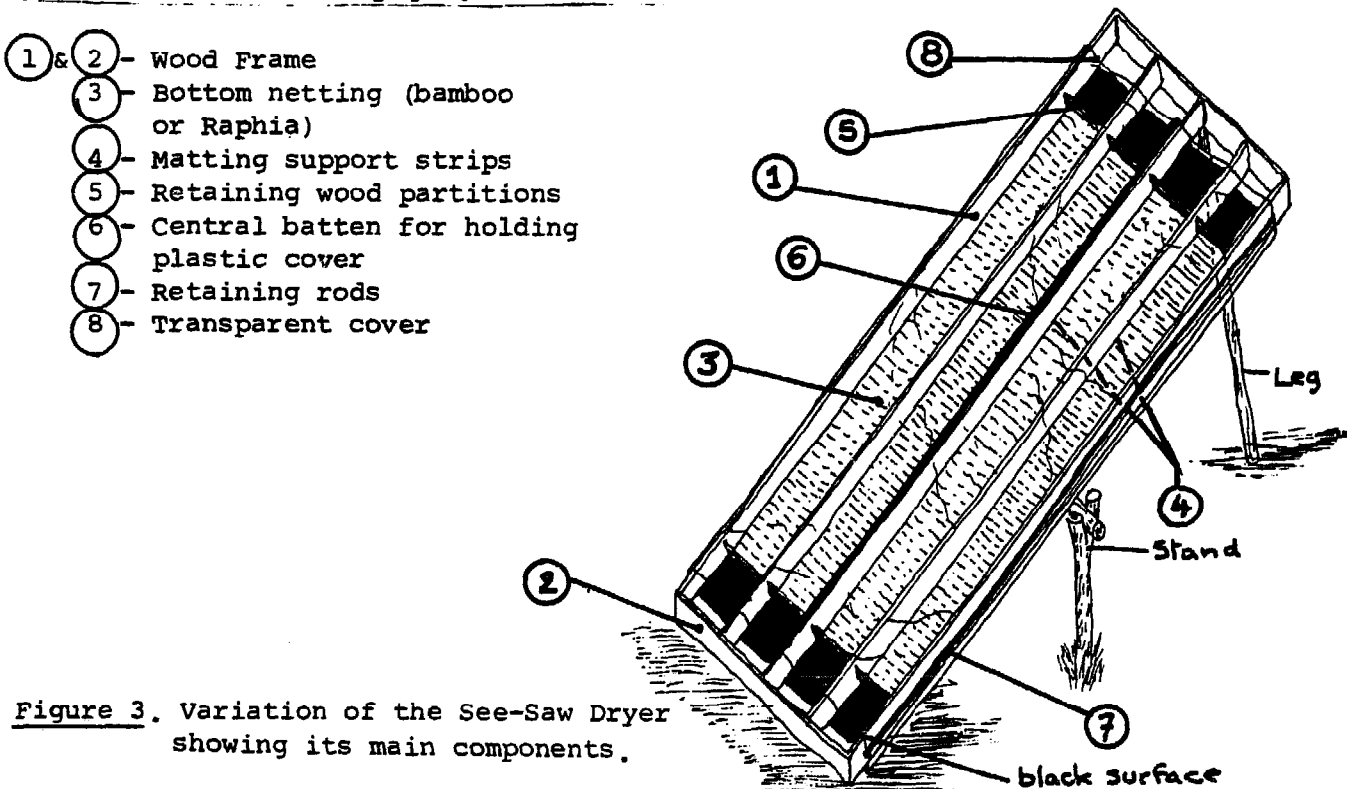


Figure 3. Variation of the See-Saw Dryer showing its main components.



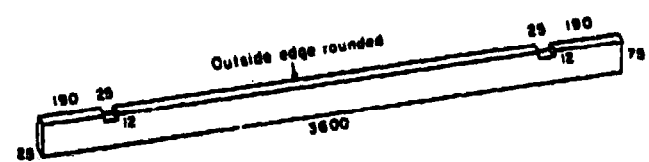
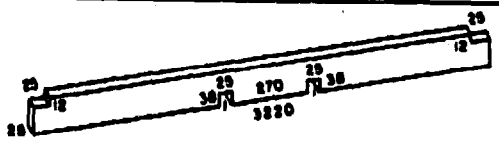
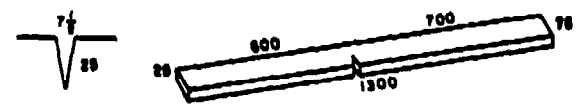
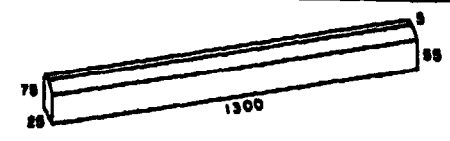
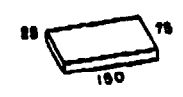





FRAME			(Timber sawn finish)	
REF.	ITEMS	No.	DIMENSIONS (in millimetres)	DETAILS
A	Side member	2	3600 x 75 x 25 (142" x 3" x 1")	
B	Channel divider	2	3200 x 75 x 25 (127" x 3" x 1")	
C	End cross members	2	1300 x 75 x 25 (51" x 3" x 1")	
D	Central cross members	2	1300 x 75 x 25 (51" x 3" x 1")	
E	Trestle stop	2	150 x 75 x 25 (6" x 3" x 1")	
F	Roller chock	2	55 x 75 x 25 (2 1/4" x 3" x 1")	
G	Produce retaining bar	4	1150 30 25 (45" x 1 1/2" x 1")	
H	Mat outside edge fixing lath	4	1625 x 25 x 12 (64" x 1" x 1/2")	
I	Mat intermediate fixing lath	4	1550 x 25 x 12 (61" x 1" x 1/2")	
Ja)	Blind support	2	1200 x 25 x 12	
Jb)	Mat end fixing lath	4	45" x 1" x 1/2"	

Figure 4 Parts list - frame


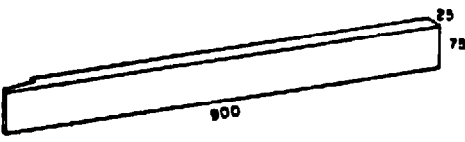
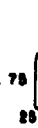


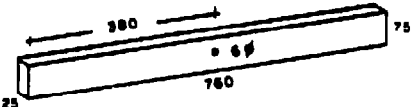

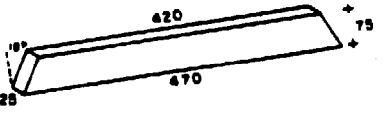
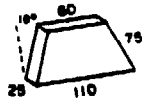
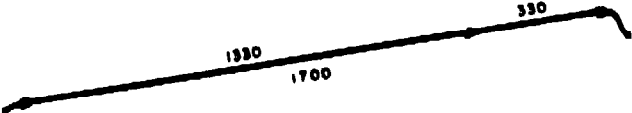

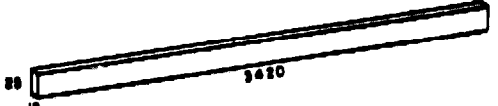
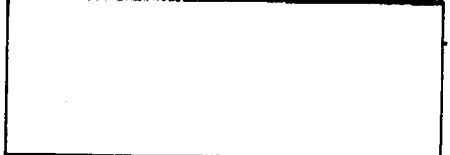
STAND				(Timber sown finish)	
REF	ITEMS	No.	DIMENSIONS (in millimetres)	DETAILS	
K	Leg	4	900 x 75 x 25 (35 $\frac{1}{2}$ " x 3" x 1")		
L	Frame supporting bar	1	815 x 75 x 25 (32" x 3" x 1")		
M	Side cross members	2	760 x 75 x 25 (30" x 3" x 1")		
N	End cross members	2	470 x 75 x 25 (18 $\frac{1}{2}$ " x 3" x 1")		
O	Fish plate	2	106 x 75 x 25 (4 $\frac{1}{4}$ " x 3" x 1")		
P	Ropes	2	2000 x 6 phi (78" x $\frac{1}{4}$ " phi)		
COVER					
Q	Roller (planed)	1	3600 x 45 phi (142" x 1 $\frac{3}{4}$ " phi)		
R	Fixing lath (sawn finish)	2	3420 x 25 x 12 (137" x 1" x $\frac{1}{2}$ ")		
S	Plastic sheet	1	3420 x 1900 (137" x 60")		

Figure 5 Parts list - stand, transparent cover

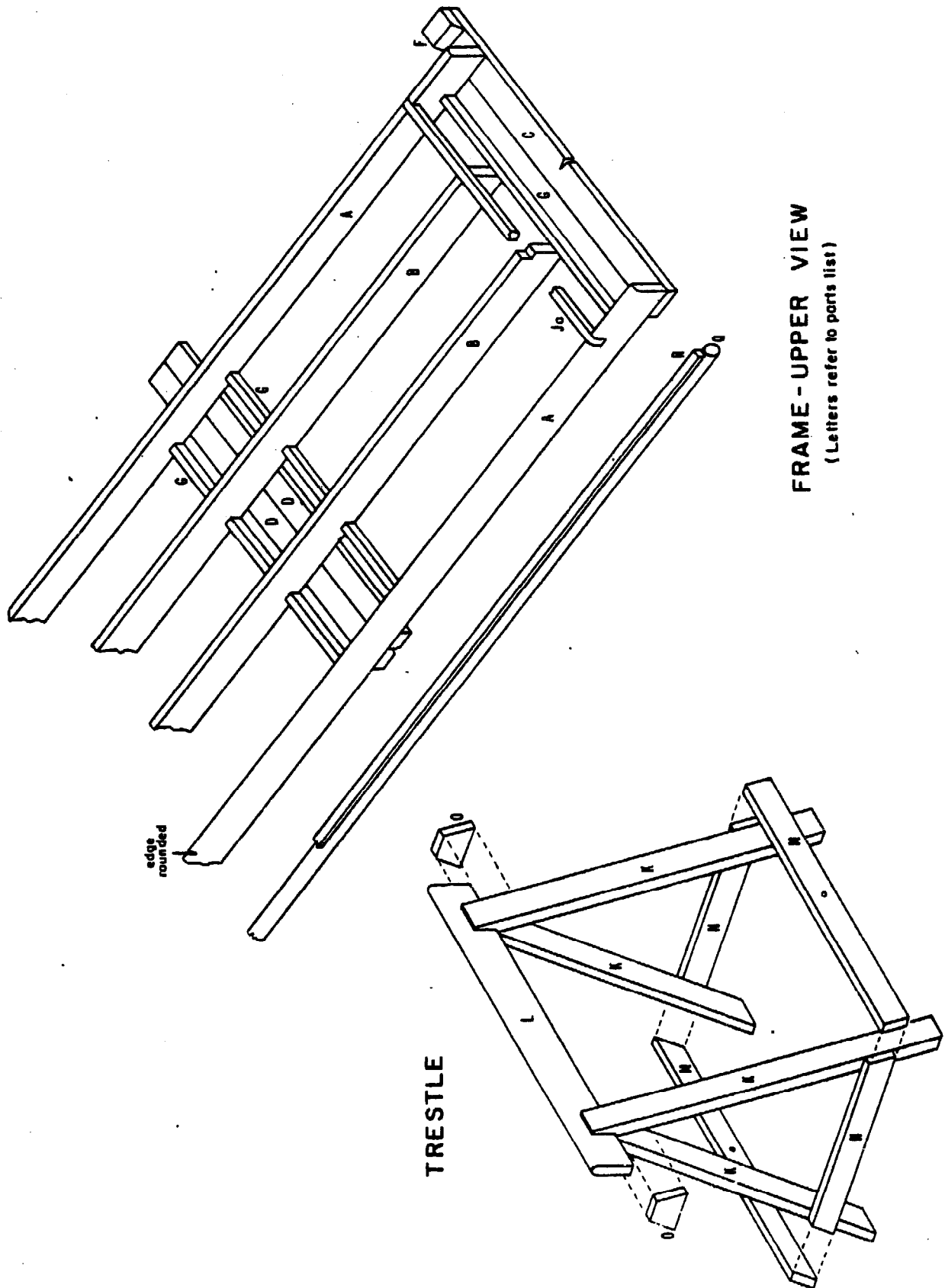
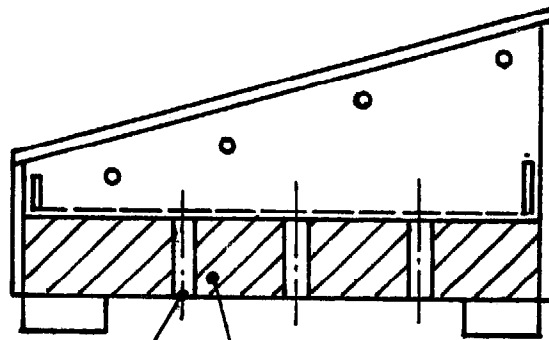


Figure 6 Assembly details - trestle, frame, upper view



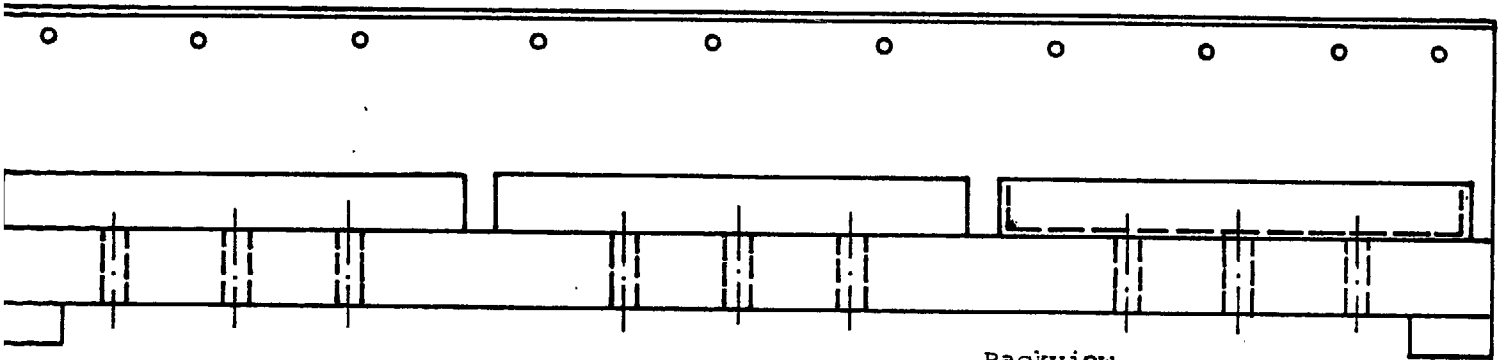
Section AA  
Coupe AA

Pipes for Bottom Ventilation  
Holes

Insulation

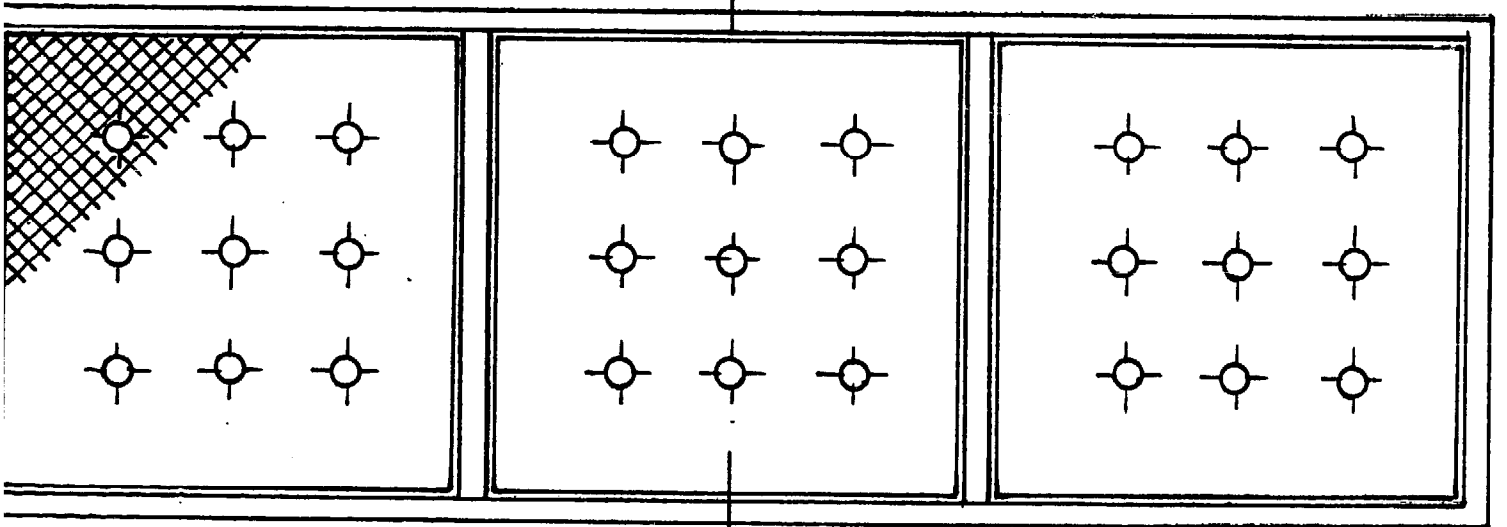
Tuyaux pour les Orifices de  
Prise d'Air

Isolant



Backview  
Vue Arrière

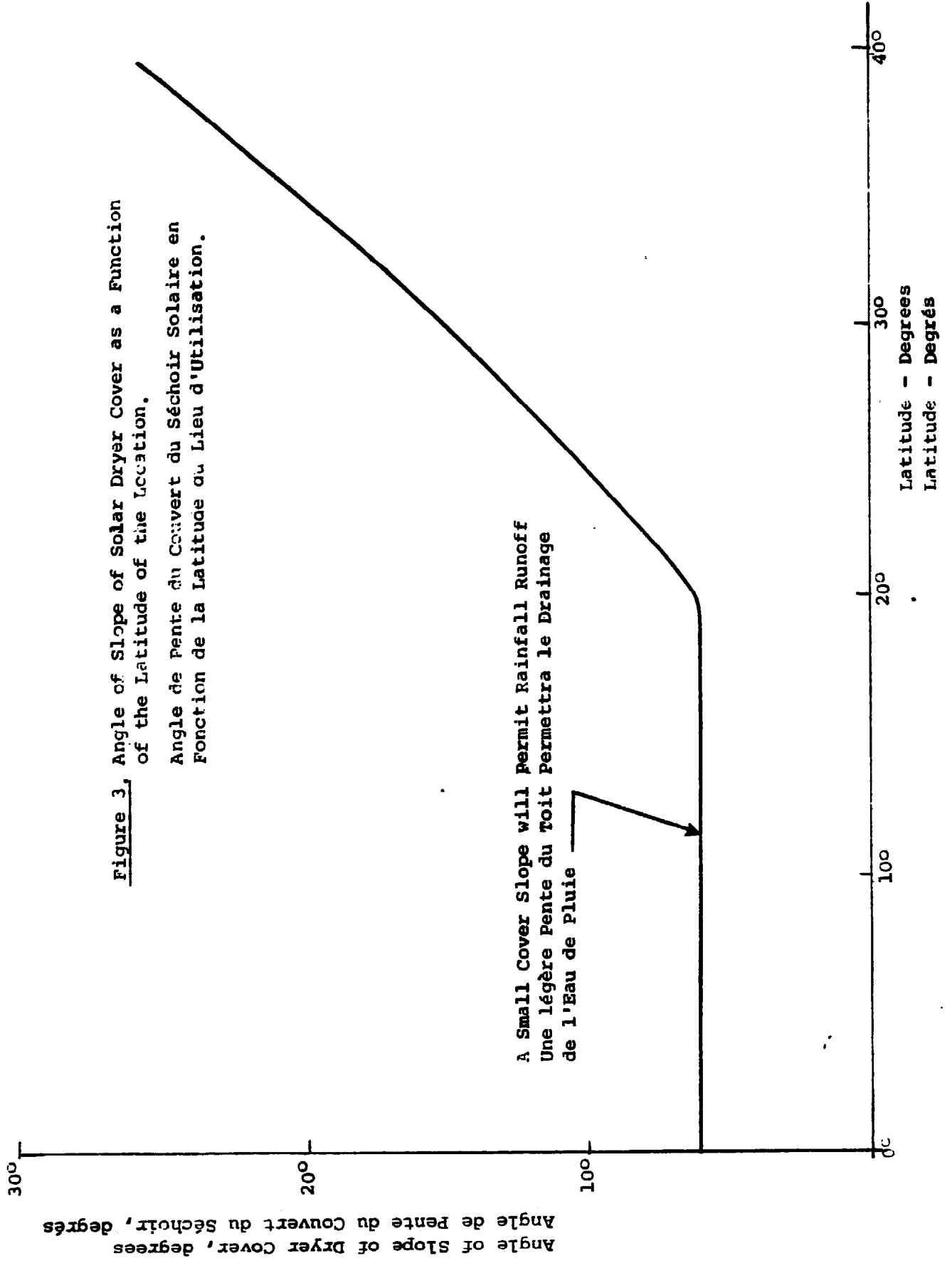
A ←



Top View  
Vue en Plan

Figure 2. Plan of the Solar Cabinet Dryer  
Plan du Séchoir Solaire

Scale - Echelle 1 mm = 1 cm



Angle of Slope of Dryer Cover, degrees  
 Angle de pente du Couvert du Séchoir, degrés

**Figure 3, Angle of Slope of Solar Dryer Cover as a Function of the Latitude of the Location.**

**Angle de Pente du Couvert du Séchoir Solaire en Fonction de la Latitude du Lieu d'Utilisation.**

**A Small Cover Slope will Permit Rainfall Runoff  
 Une légère Pente du Toit Permettra le Drainage de l'Eau de Pluie**

SOLAR CABINET DRYER (India)Overview:

Status: experimental

Heating Mode: direct

Type: chamber dryer

Air circulation: natural  
convection

A specific example of the performance obtainable with a solar cabinet dryer is given in this case study. The model was built and tested for the particular climatic conditions of Kanpur, India. Comparison is made of the drying rates and final product quality with those obtained by drying in the open sun. The experimental work deals with the drying of several fruits and vegetables in common use throughout India.

Characteristics:

This solar cabinet dryer was designed for Indian climatological and economic conditions, using materials readily available at the local market. The optimum tilt of the dryer was found to be  $13^{\circ}15'$  in summer and  $40^{\circ}$  in the winter at Kanpur location. The principles of operation are described in the preceding case study.

Dimensions: see plans on figure 1

Materials of Construction:Drying Chamber

Transparent Cover: glass  
 Frames: Indian chir wood  
 Insulation: locally available wood-wool  
 Trays: wire mesh on wooden frame

Location: Campus of the Indian Institute of Technology  
 Kanpur, India

Longitude:  $80^{\circ}22'E$

Latitude:  $26^{\circ}26'N$

Climatological Data:

Maximum temperature in summer	$45^{\circ}C$
Minimum temperature in winter	$10^{\circ}C$
Hours of sunshine per year	4000
Days of no sunshine per year	30

Practical Operation:

Number of units used in the past: two  
 Number of units currently in use: none

Periods of Operation:

The dryer was used on experimental basis only from July 1971 to July 1972.

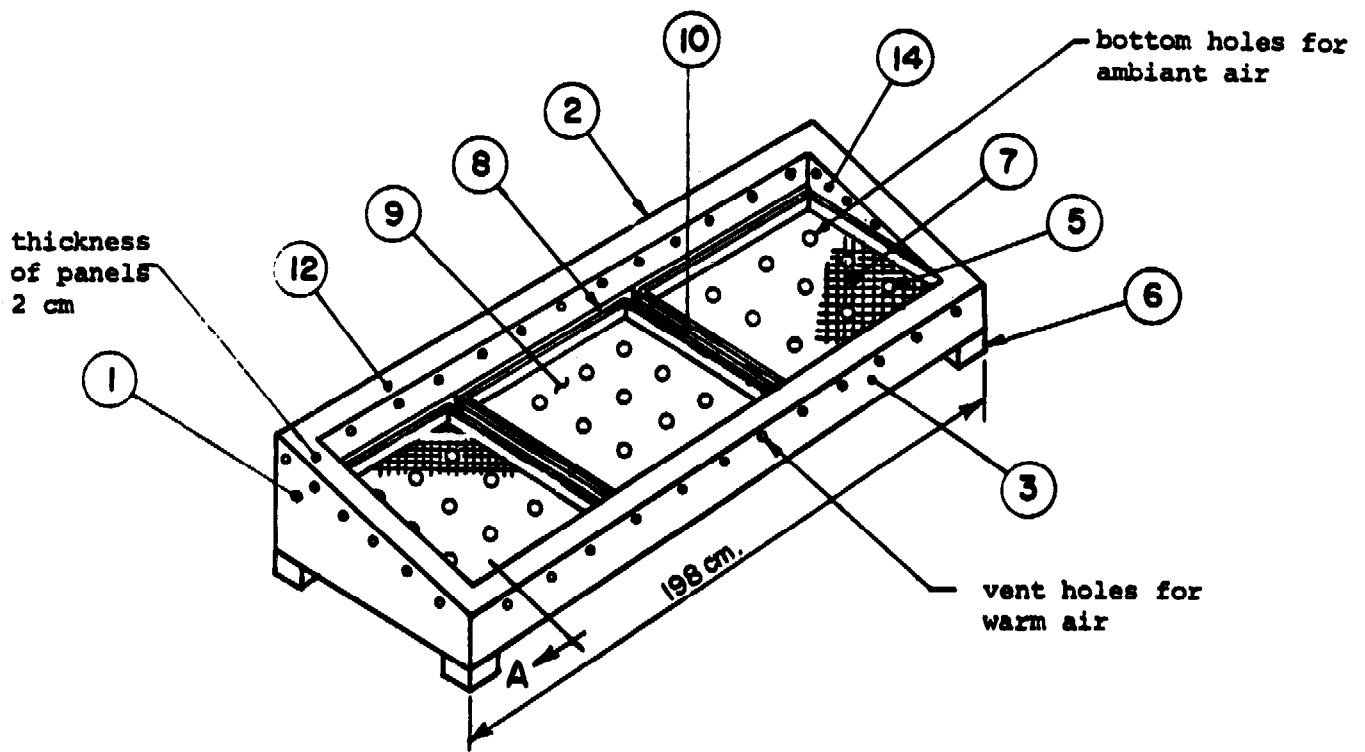
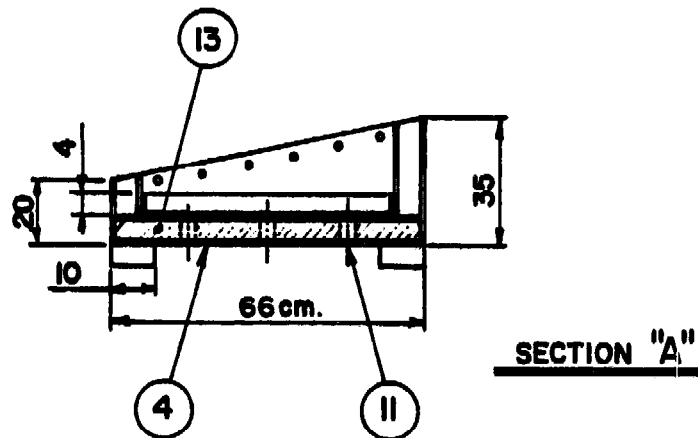


Figure 1 Plan of the Cabinet Dryer



14	INTERNAL SIDE WALLS	ALUMINIUM	2
13	INSULATION	WOOD WOOL	-
12	COVER FRAME	WOOD	1
11	NETTING	FIBRE GLASS	27
10	TRAY RUNNERS	WOOD	4
9	TRANSPARENT COVER	GLASS	3
8	DOORS	WOOD	3
7	TRAYS	WOOD & STEEL MESH	3
6	LEGS	WOOD	4
5	PIPE FOR BOTTOM HOLES	POLYTHENE PIPE	27
4	BASE	PLYWOOD SHEET	2
3	FRONT PANEL	WOOD	1
2	REAR PANEL	WOOD	1
1	SIDE PANEL	WOOD	2
	DESCRIPTION	MATERIAL	NO. REQUIRED

Drying Data:

Material	Quantity Dried grm.	Pre Treatment	Moisture Content		Maximum Allowable Temp. °C	Drying time hr.
			Initial %	Prefered Final %		
prunes	750	sulphuring	85	15 to 20	77	18
peaches	275	none	80	5 to 6	77	11
peas	420	blanching	80	5 to 6	66	5
cauliflower	200	none	85	5 to 6	66	2.5

Operating Conditions:

It was observed that an average temperature of 75°C was attainable inside the dryer as compared to an average outside temperature of 35°.

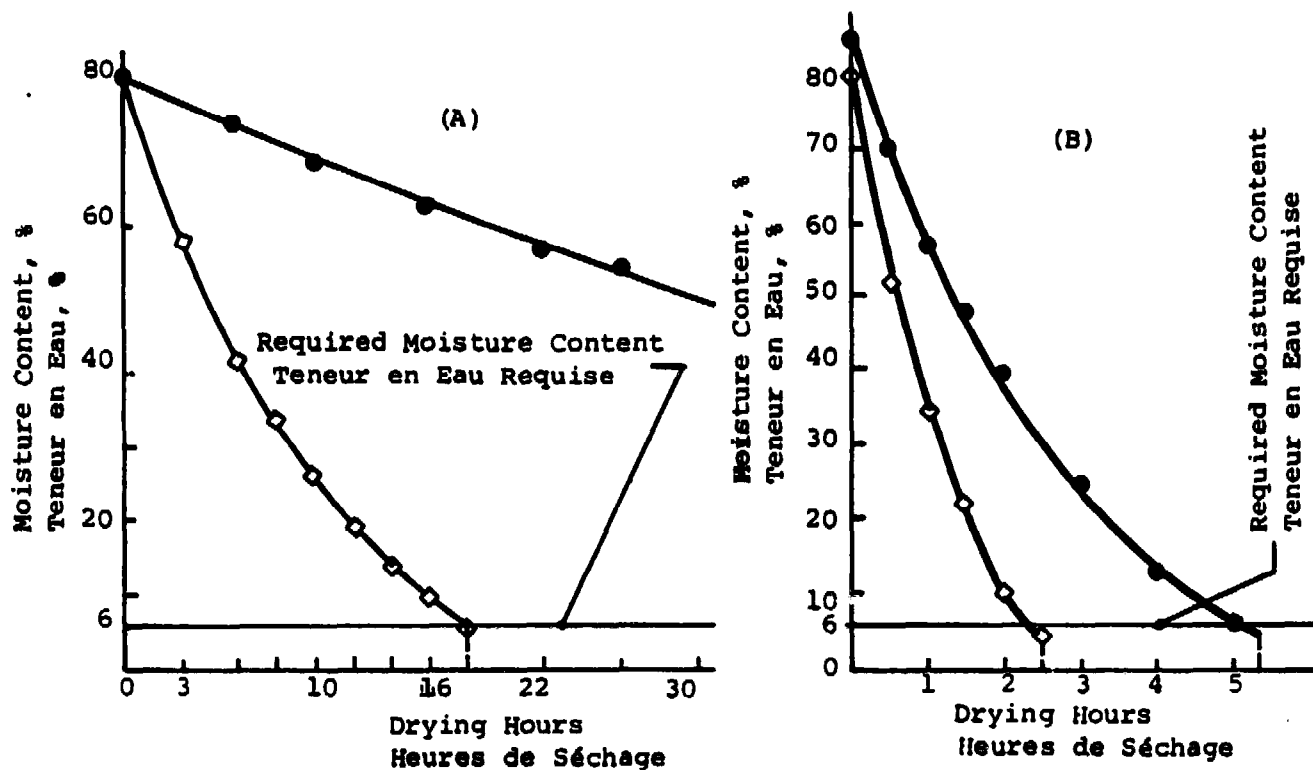


Figure 2. Drying Characteristics of Fruits and Vegetables  
 Courbes Comparatives pour le Séchage des Fruits et Légumes  
 A) Prunes  
 B) Cauliflower - choux-fleur

- ◇ Inside the Solar Dryer - Dans le Séchoir Solaire
- Under the Open Sun - Séchage au Soleil



Economic Details:

Cost of materials: (refer to sketch)

<u>Item</u>	<u>Number of pieces required</u>	<u>Dimensions</u>	<u>Total Cost Rupees</u>
Glass sheet	3	61 x 62 cm	30,00
Indian chir			
Wood (volume)	0,045 cu.m.	-	60,00
Plywood sheet	2	198 x 66 cm	18,00
Aluminum sheet	2	2456 cm <sup>2</sup>	8,00
Mesh for trays	3	62 x 62 cm	25,00
Polythene pipes	25	12,7 diameter x 6 cm long	2,00
Miscellaneous	-	-	5,00
Labour charges	2 days	-	12,00
		(\$1,00 U.S. = 8 Rupees )	160,00 (1973)

Annual Operating Expenditure:

Depreciation of the unit per year	16,00 Rs
Interest on capital (at 10%)	16,00 Rs
Contingencies	<u>8,00 Rs</u>
<b>TOTAL</b>	<b>40,00 Rs</b>

Cost of drying related to a Unit of Material Dried:

The researchers estimated this cost to be about 20% of the cost of the raw material.

Estimated Life of the Dryer: 10 years

Comments on the Dryer:

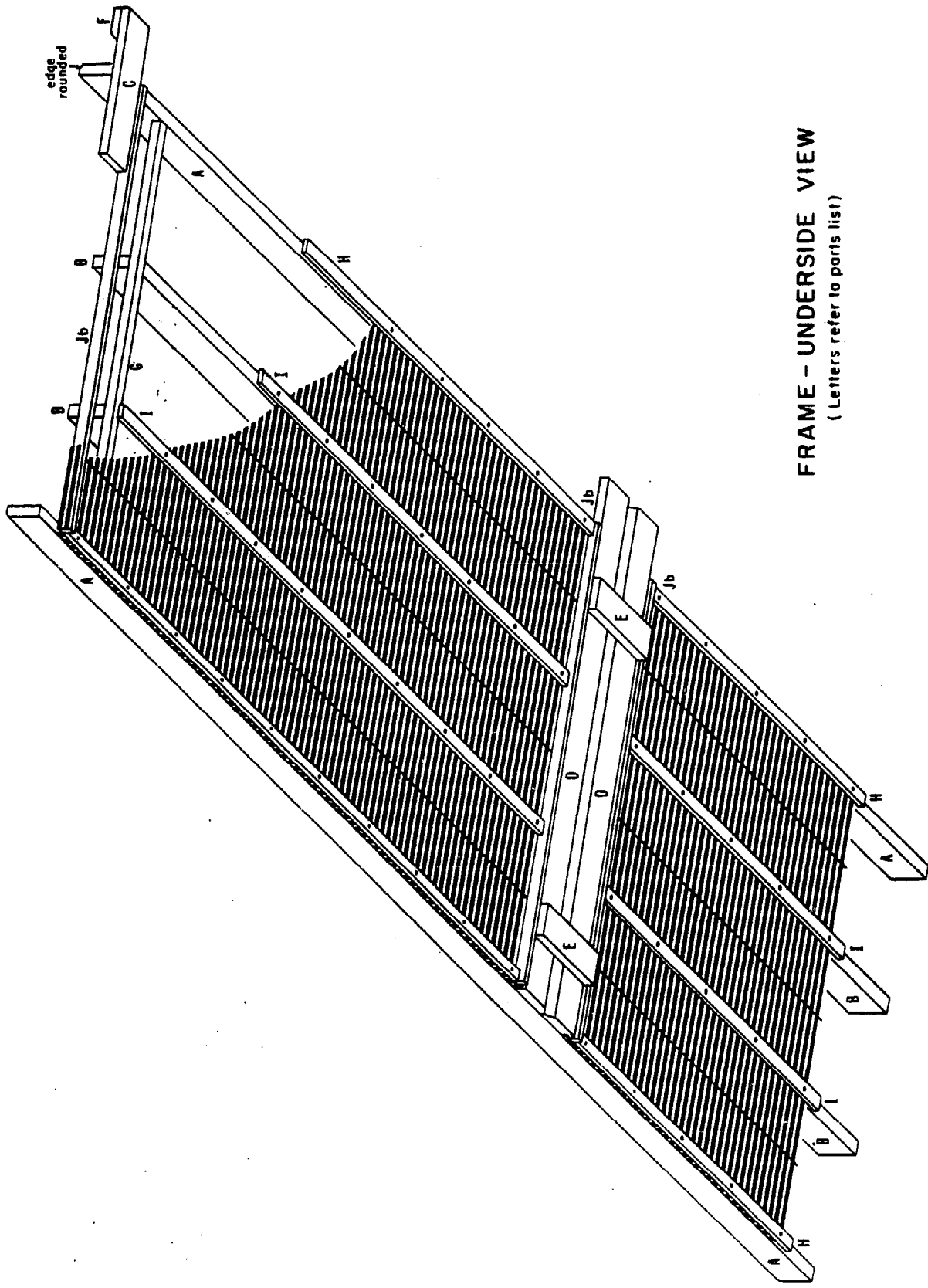
It is found that solar drying saves considerable time. Also the final product quality obtained from the dryer was found to be superior in taste and odour without being contaminated by dust and insect infestation.

Principal Investigator(s): Agrawal, H.C.  
Kapoor, S.G.

Indian Institute of Technology  
Department of Mechanical Engineering  
Kanpur, Uttar Pradesh  
India

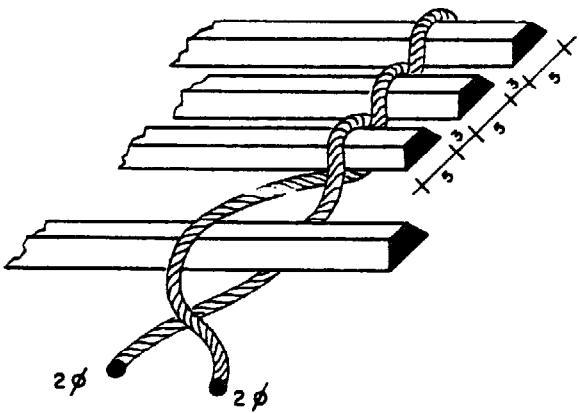
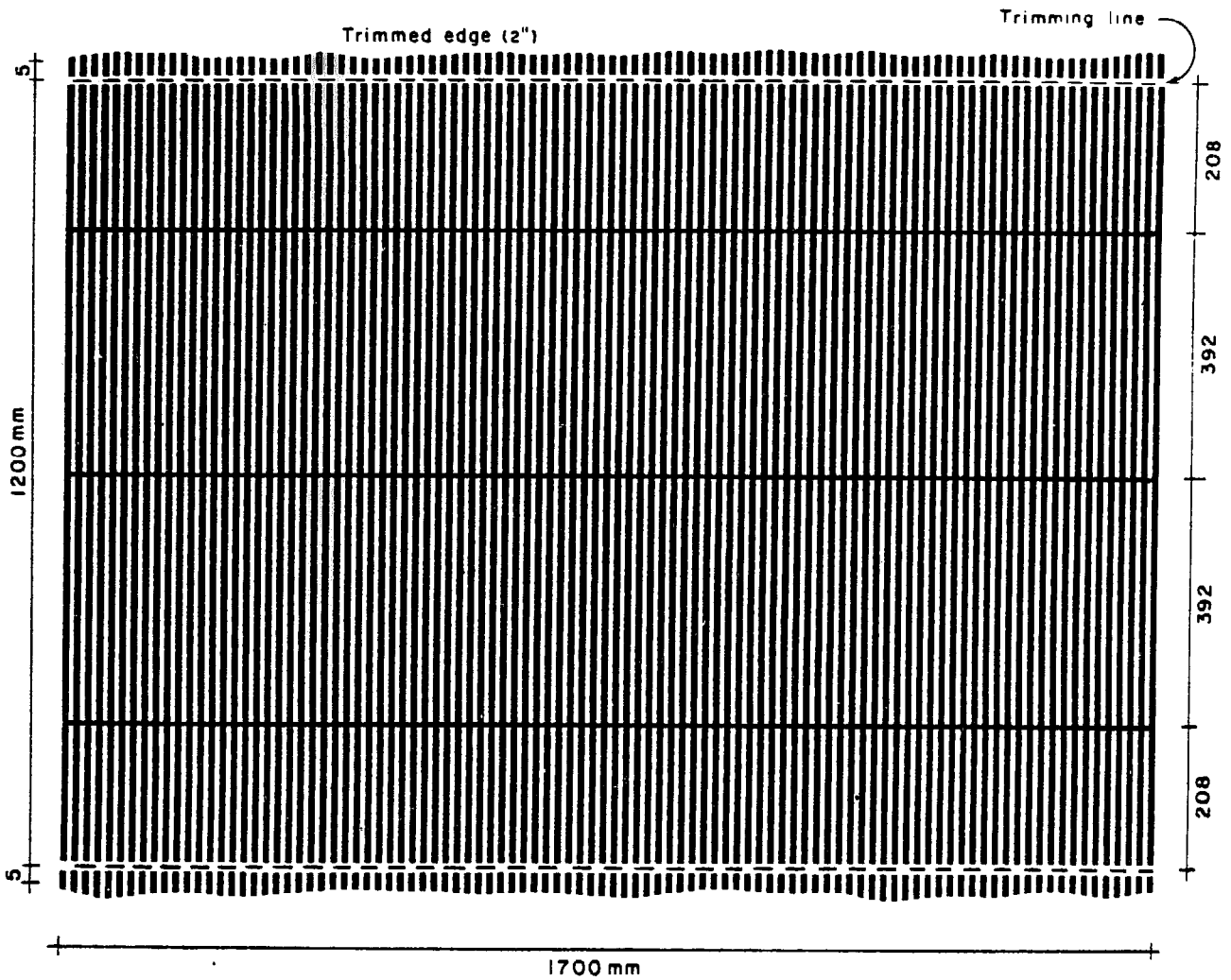
Note: The unit described is based on the design presented in Case Study No. E.





FRAME - UNDERSIDE VIEW  
( Letters refer to parts list)

Figure 7 Assembly details - frame, underside view



Method of weaving mat  
 String thickness determines  
 gap between cross-members.  
 2 mm thickness will give  
 approximately 3 mm gap.

Figure 8 Plan and details of mat

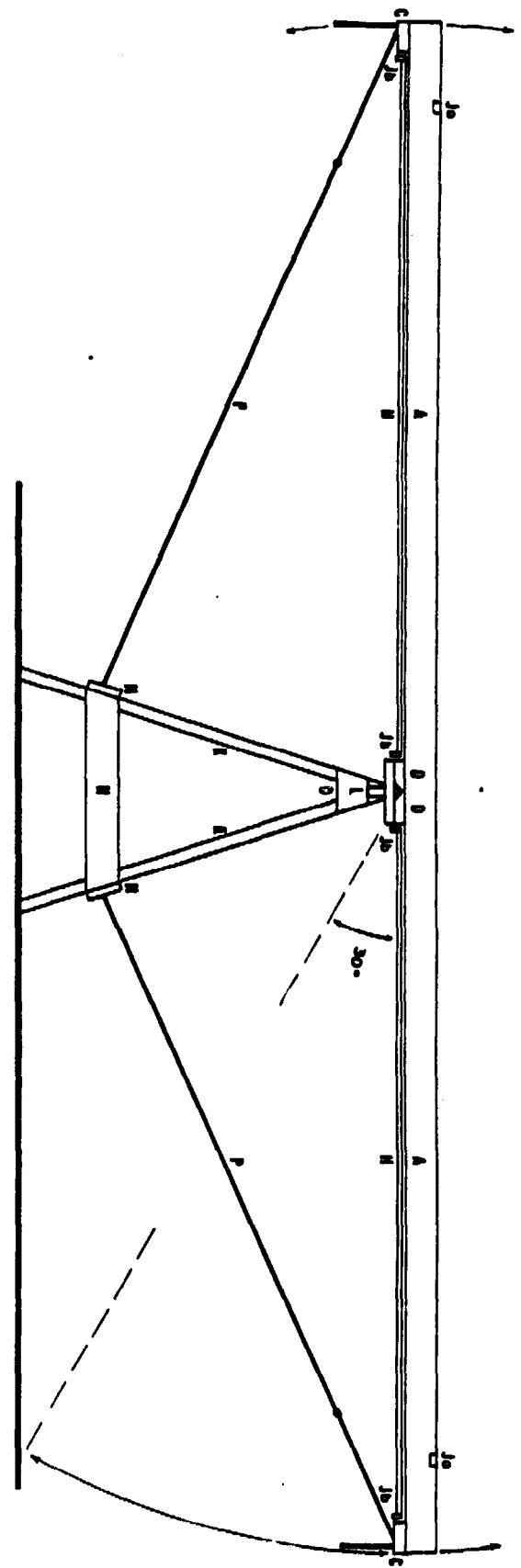
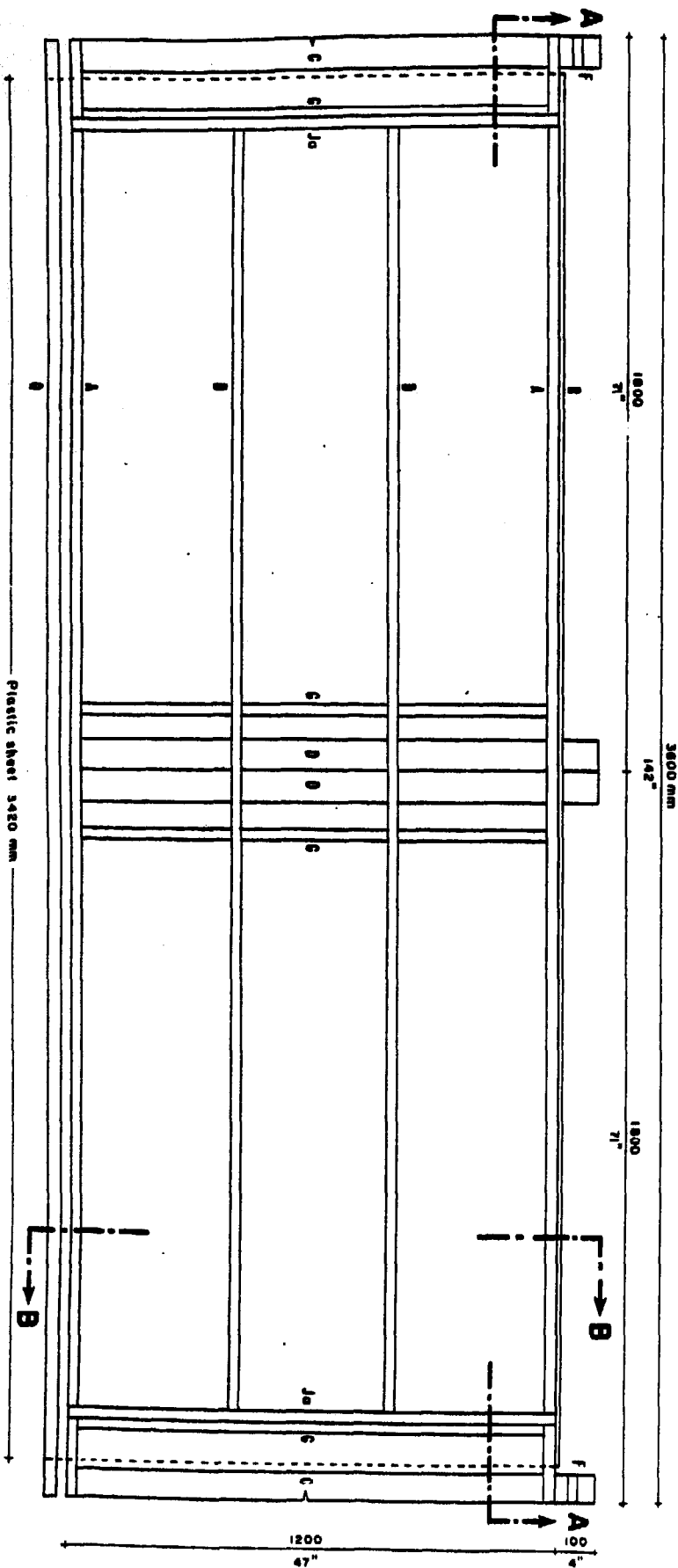


Figure 9 Assembled driers - side elevation and plan

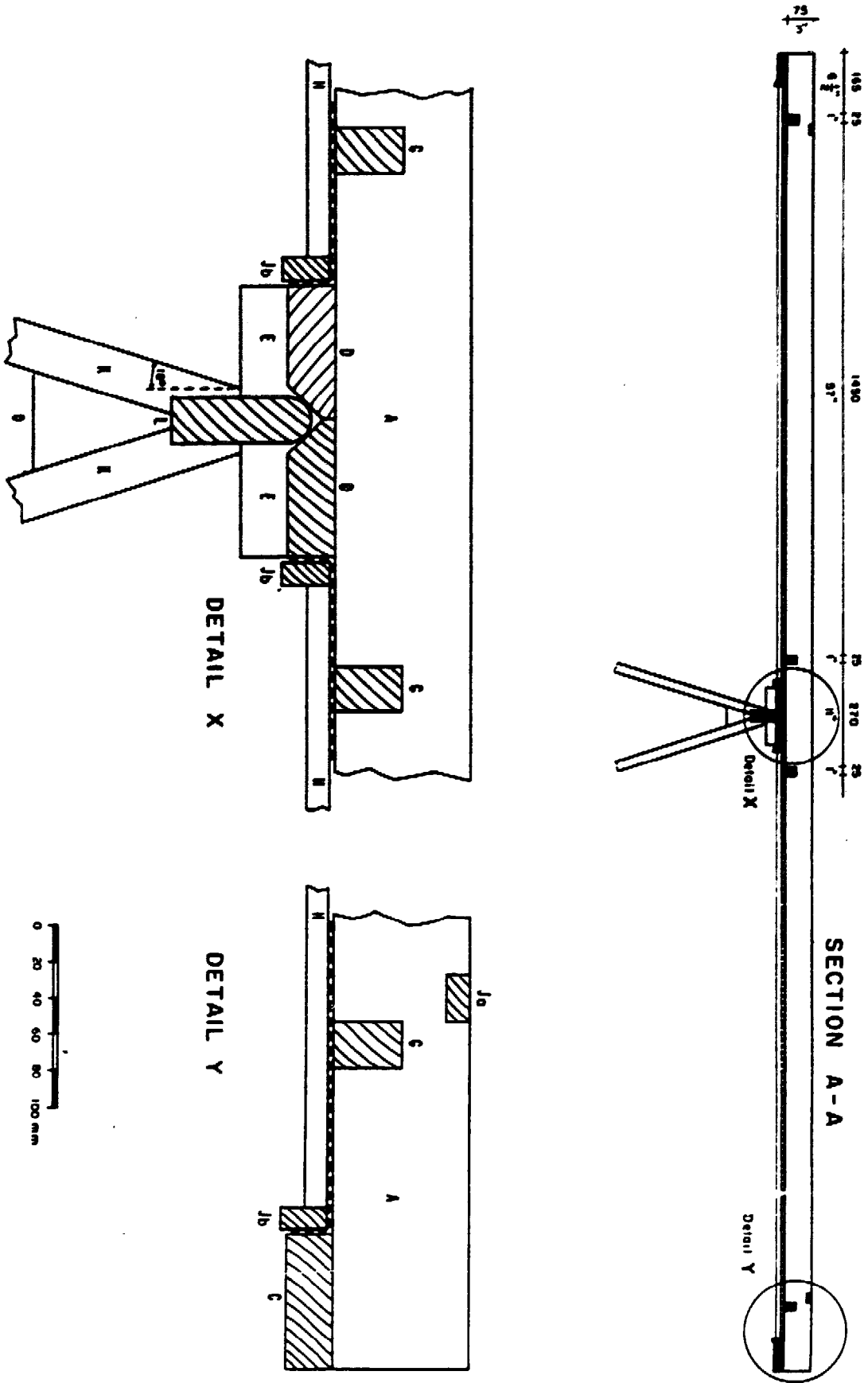
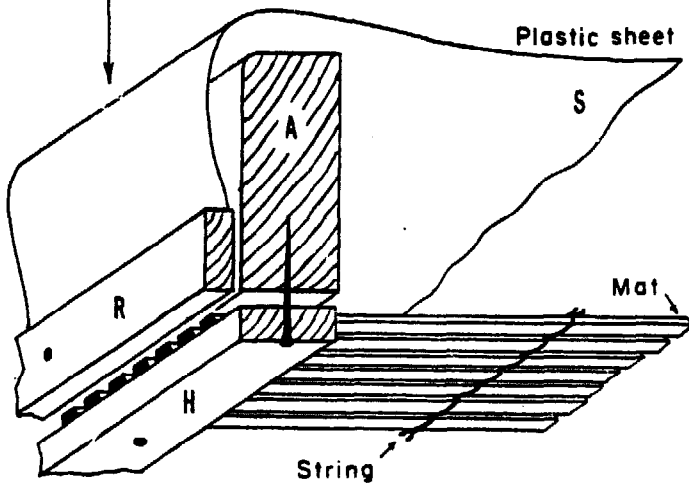
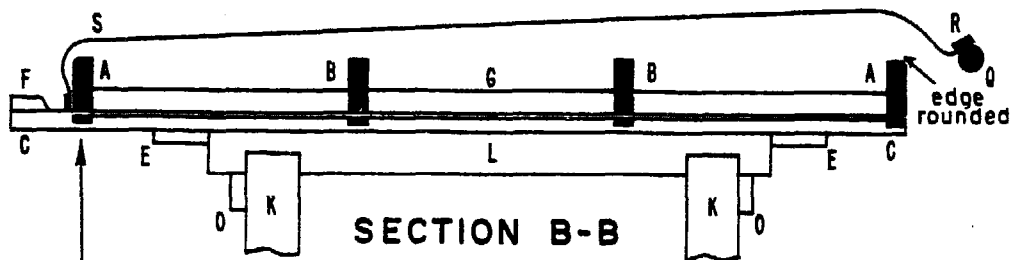
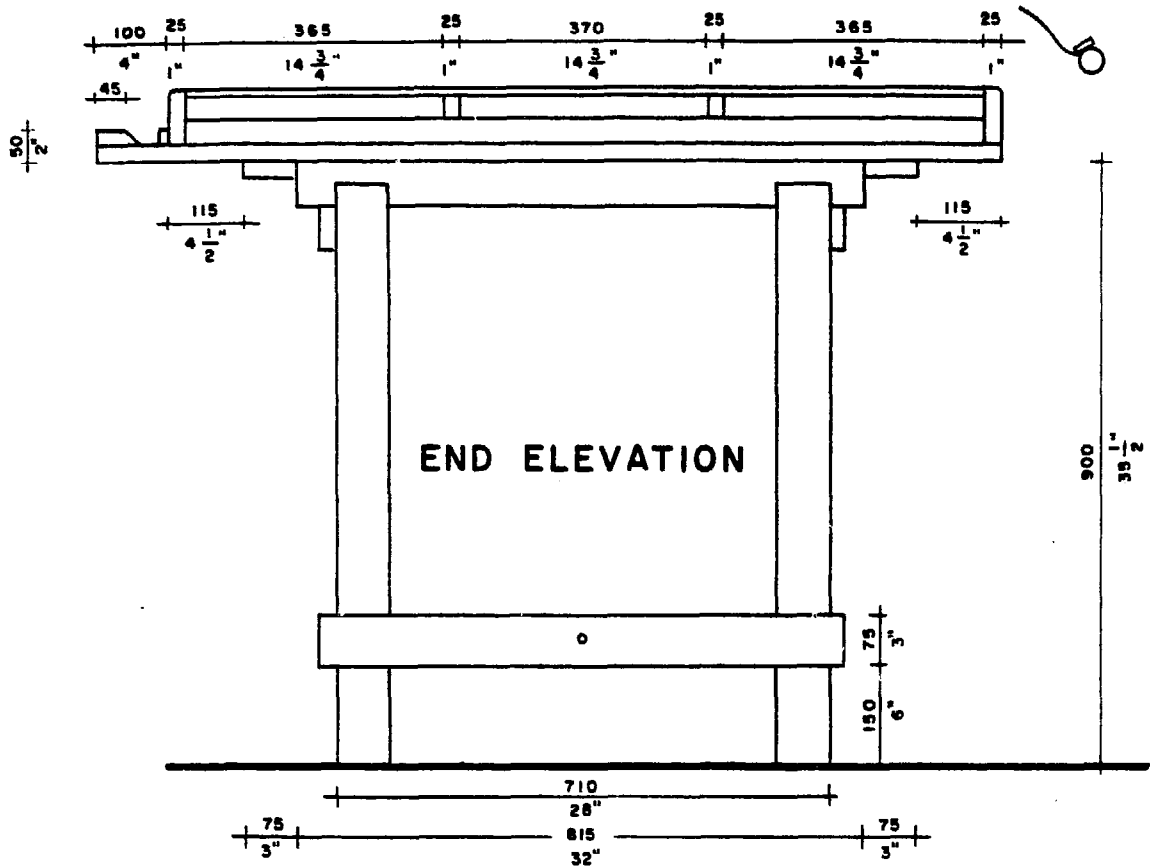


Figure 10 Assembled drier - Section A-A



Assembly-side with blind attached  
 (all internal surfaces of frame and mat finished matt black paint)

Figure 11 Assembled drier - Section B-B end elevation

SOLAR DRYER FOR CEREAL AND GRAINS (GREAT BRITAIN)Overview:

Status: experimental

Operating mode: direct

Type: chamber-tray dryer

Air circulation: fan forced  
convection

The dryer presented here is a direct solar dryer used and tested on an experimental basis. The main conclusions show the improvement that can bring on heat utilization and drying time, the use of a small controlled air flow passing through the depth of the grain during its travel across the tray-dryer box.

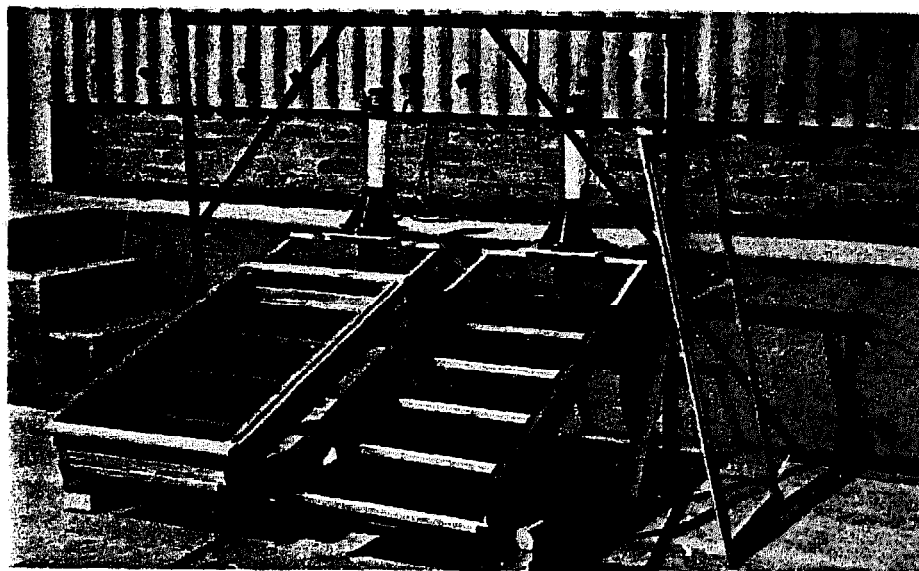


Figure 1. This Picture shows the Experimental Set-Up. On the Left, the Downdraught Dryer and on the Right, the Crossdraught Dryer.

Characteristics:

This dryer, the downdraught dryer, was used only experimentally for comparison tests against a similar dryer with its inlet and outlet above the level of the grain surface (crossdraught dryer). Their performance was compared to an Allgate dryer in which material is placed on a plastic sheet directly on the ground.

The dryer (see figure 2) comprises of a sloping tray at about 20° to the horizontal. The tray is fitted with a false floor of perforated metal on which the grain to be dried is laid. The tray is divided into four equal compartments by wooden partitions. Both its ends are blocked, apart from small apertures above the level of the grain surface at the lower end and a single hole at the top end below the perforated metal through which air is extracted by a small exhaust fan (0.25 m<sup>3</sup>/min). Air entering the bottom just below the transparent cover is drawn through the grain supported on the perforated sheet at a rate determined by the fan damper. This rate is indicated by a float-type airflow meter. The unit is currently not in existence.

Dimensions: Overall dimensions of the dryer are 61 cm x 122 cm.



Materials of Construction:

**Drying Chamber**

Transparent cover: cellulose acetate on softwood frame  
Frames: hardwood body  
Insulation: none used (bottom of trays are damp resistant hard board)  
Trays: perforated steel sheet

The drying trays were originally painted black so that in a unit without a fan, the black surface of any unfilled compartment would induce convection of air. This precaution was unnecessary as trays were always covered with grain in the final version and the airflow was regulated by a fan.

Location: National Institute of Agricultural Engineering (NIAE)  
Wrest Park, Silsoe  
Bedfordshire, England

Climatological Data:

Reported at time of experiments only.

Sunshine hours: about 10 per day

Shade temperature: 18 to 21°C

Relative humidity: 40 to 60%

Practical Operation:

Number of units used in the past: one

Number of units currently in use: none

Periods of Operation:

(a) On experimental basis: September 1963 without fans; August, September 1964 (down and crossdraught dryers) with fans

(b) In field operations: Nil

Drying Data:

Barley and wheat: no specific treatment was used. Germination should not have been affected at temperatures used. The temperatures inside the drying space varied between 32° and 50°C.

Quantities dried: from 13 to 30 Kg per tray, corresponding to depths of about 2,5 to 5 cm.

Drying times: a 23 Kg batch was reduced from 21% to 15% moisture content (w.b.) in about 9 hours.

Operating Conditions:

During experiments: mainly sunny, light wind, light clouds

Insolation: 0,4 to 0,58 Kwhr/(m<sup>2</sup>.hr)

Economic Details:

Not known; the experimental unit was for research only and much more costly than a practical dryer of this type would be. The economics would have to be assessed in light of the country in which the dryer would be used as it can be built from locally available materials.

Estimated Life of the Dryer:

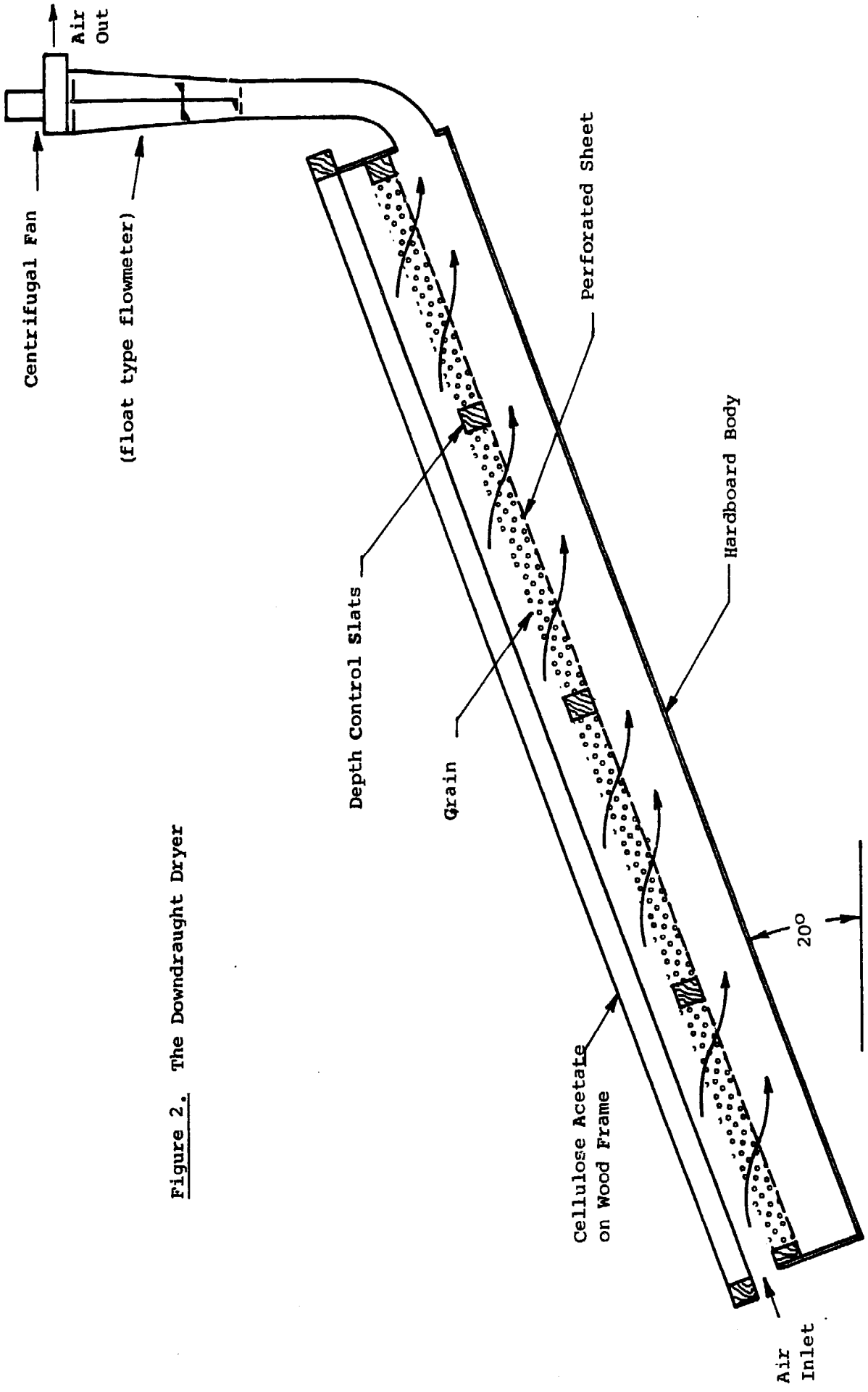
Several years, but cellulose acetate sheet would have to be renewed bi-annually.

Comments on the Dryer:

- . Construction is basically simple.
- . Especially useful for the drying needs of a few people.
- . The results of the series of tests give clear indication that heat utilization in a covered solar dryer with uncontrolled air flow is only of the same order as when material is laid on the ground to dry. The heat utilization is considerably improved when air flow is controlled and directed downwards through the material to be dried (downdraught dryer) by means of a small fan. The downdraught dryer presented here utilizes the solar heat three (3) times more effectively than a sun drying process does and the unit is at least 60% more efficient than the crossdraught system.
- . The fan could be electric, wind or hand powered.
- . A solar air heater could be added for generating a thermally induced draught for application where the use of even a small fan is unpractical.

Principal Investigator(s): Bailey, P.H.  
Williamson, W.F.

National Institute of Agricultural Engineering  
Scottish Station  
Bush Estate, Penicuik, Midlothian  
KH26 OPH  
Great Britain



**Figure 2.** The Downdraught Dryer

GLASS ROOF SOLAR DRYER (Brazil)Overview:

Status: operational

Heating mode: hybrid

Type: chamber dryer

Air circulation: natural  
convection

A solar dryer for small and middle scale drying operations of cacao has been optimized and its performance compared with the traditional sun drying platform or "barcaça" used in Brazil. The prototype is less expensive and uses solar radiation more efficiently. It is supplemented with gas heaters for rainy and night periods.

Characteristics:

In general, the unit is similar to a regular greenhouse structure and has a special roof peak cap acting as a flue and protecting the inside of the dryer against rain. This cap, made of folded zinc sheet, allows the heated air charged with the moisture removed from the cocoa to escape, thereby permitting the entry of fresh air through the side shutters provided in the structure. The dryer is aligned lengthwise along a north-south axis. Basically it consists of two parallel rows of drying platforms with a central passage for an operator. A fixed glass roof above the drying platform allows the radiation of the sun to penetrate inside the dryer and also prevents the ingress of rain or dew at night. All surfaces inside the dryer are painted black to facilitate the absorption of solar radiation. See Figure 1 and 2.

The drying surface is made of galvanized iron wire mesh laid over wooden beams fixed across the platform. Strong metal wires stretched perpendicularly over the wooden beams and under the wire mesh provide additional support to the loaded wire mesh during the drying operation. This permits the solar or gas heated air to pass easily through the wire mesh on which the drying product is spread.

In the prototype dryer, the gas heaters are situated underneath one of the two rows of drying platforms and are intended to serve during rainy or night periods only for shortening the drying time.

A free vertical space between the lower edge of the glass roof and the outer edge of the platform allow for the proper ventilation of the dryer. Six wooden shutters on hinges are located in this space along the length of the dryer on each side, and they can be opened or closed independantly to regulate the air flow inside the dryer during the solar drying hours. (see figure 3) .

Dimensions: The overall dimensions of the dryer are 12,80 m long x 5,20 m wide x 2 m high at the centre and 1 m high at the outer edges. The drying platforms are 12 m long x 1,76 m wide and are located at 0,8 m from the base of the dryer. The drying platforms are provided with a 10 cm ridge along their edges. The drying surface lays over wooden beams set at a spacing of 0,5 m. The metal wires reinforcing the wire mesh drying surface are set at a pitch of 0,4 m. The vertical space where the ventilation shutters are located is approximately 10 cm. See also the drawing Figure 5.

## Materials of Construction:

### Drying Chamber

Transparent cover: glass panels, 3 mm thick  
Frames: all frame work made with wood  
Insulation: wood and waterproof composite panels (eucatex) for walls, and windows. The dryer is designed so as not to be completely insulated.  
Trays: drying platforms made of wire mesh supported over wooden frame and metal wire reinforcement.

All materials used are locally available.

Location: Centro de Pesquisas do Cacau  
Itabuna, Brazil  
Latitude: 14°47'S  
Longitude: 39°16'W

### Climatological Data:

Summary of records over a period of 10 years.

	<u>January</u>	<u>July</u>	<u>Annual</u>
Mean maximum temperature (°C)	30,3	26,5	28,7
Mean minimum temperature (°C)	20,3	17,2	19,2
Mean daily temperature (°C)	25,3	21,8	23,9
Total precipitation per month (mm)	118,3	159,2	1 535,2
Total sunshine hours per month (mm)	228,3	164,6	2 081,0
Daily solar radiation (kwhr/(m <sup>2</sup> day)	5,76	3,66	4,56
Relative Humidity (percent)	78,4	82,9	80,6
Wind speed (m/sec)	4,0	3,1	3,3
Direction constantly South-East			

### Practical Operation:

Number of units used in the past: none, it is the first prototype  
Number of units currently in use: one, two other units are under construction  
(September 1973)

### Periods of Operation:

- (a) On experimental basis: September 1971
- (b) In field operations: September 1971

The prototype dryer is still in use.

### Drying Data:

Cocoa beans, cocoa pad (husks, maize cobs were dried)

The drying rate of cocoa beans has been compared with that in a common barça, the traditional sun drying platform located at 30 m from the glass roof dryer. The end point of the drying period is reached in the glass roof dryer one day before that of the barça drying platform, that is 7 days instead of 8 days. (see figure 4) The tests showed a higher drying efficiency for the glass roof dryer over the common barça. When using solar energy, a layer of cocoa beans 3 to 4 cm thick, is spread on each platform at a time and, without any artificial heating, a drying period of 6 to 10 days is needed per batch, depending on weather conditions.

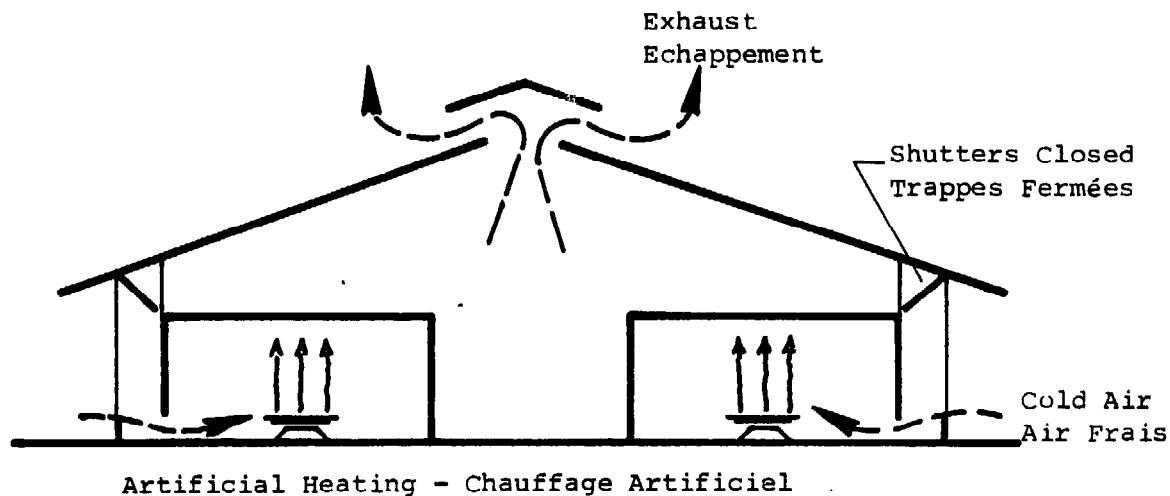
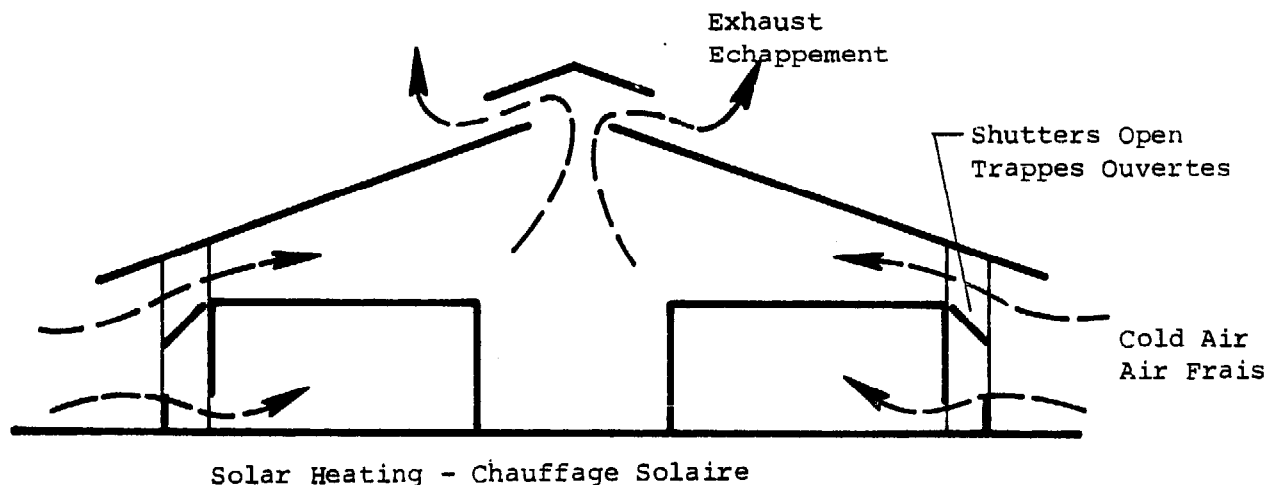


Figure 3. Air Circulation in the Glass-Roof Dryer for its Two Heating Modes  
Circulation de l'Air dans le Séchoir à Toit-Vitré pour ses Deux  
Modes de Chauffage



Operating Conditions:

The mean maximum temperature inside the dryer, at around mid-day is approximately 20°C to 25°C higher than ambient, while the minimum relative humidity at the same time of day inside the dryer is around 15 to 20% lower than the ambient.

When gas is used for artificial heating the maximum drying temperature is maintained at around 70° to 75°C in the initial stages and is gradually lowered as the moisture content is reduced to around 15 to 20%.

Economic Details:

Cost of materials: Estimated cost of the prototype unit;

Material	\$ 600,00 U.S.
Labour	\$ 400,00 U.S.
<hr/>	
TOTAL (1971)	\$1 000,00 U.S.

Annual Operating Expenditure:

General cleaning and maintenance cost per year is approximately \$100,00 U.S.

Cost of drying related to a Unit of Material dried:

For only solar drying of cocoa beans, the estimated cost in labour is less than 3 cents per Kg of cocoa (dry).

Estimated life of the Dryer: 10 years

Comments on the Dryer:

There are no limiting factors for the extension of the use of the dryer; however, an economic evaluation of the system is being carried out at present by CEPEC before generally recommending it to the farmers.

The use of glass panels, 1 x 1 m, for the construction of the roof necessitates careful handling during the construction.

The glass roof dryer has been specially designed and developed to meet the drying requirements of cocoa beans; however, it is also versatile in design and can be easily adapted for use with other crops. For solar drying, no structural alterations are considered necessary, while for artificial drying by gas, it would be necessary to carry out preliminary experiments to determine the range of drying temperatures suitable for each crop.

Principal Investigator(s):

Ghosh, Biswa Nath

Centro de Pesquisas do Cacav (CEPEC)  
Km 26, Rodovia Ilhéus-Itabuna  
Caixa Postal 7  
Itabuna, B.A. Brazil

Reference:

Ghosh, B.N.,

A new glass roof dryer for cocoa beans and other crops,  
Proceedings of the International Congress, "The Sun in the Service  
of Mankind", Paris, July 1973, 17 pp.

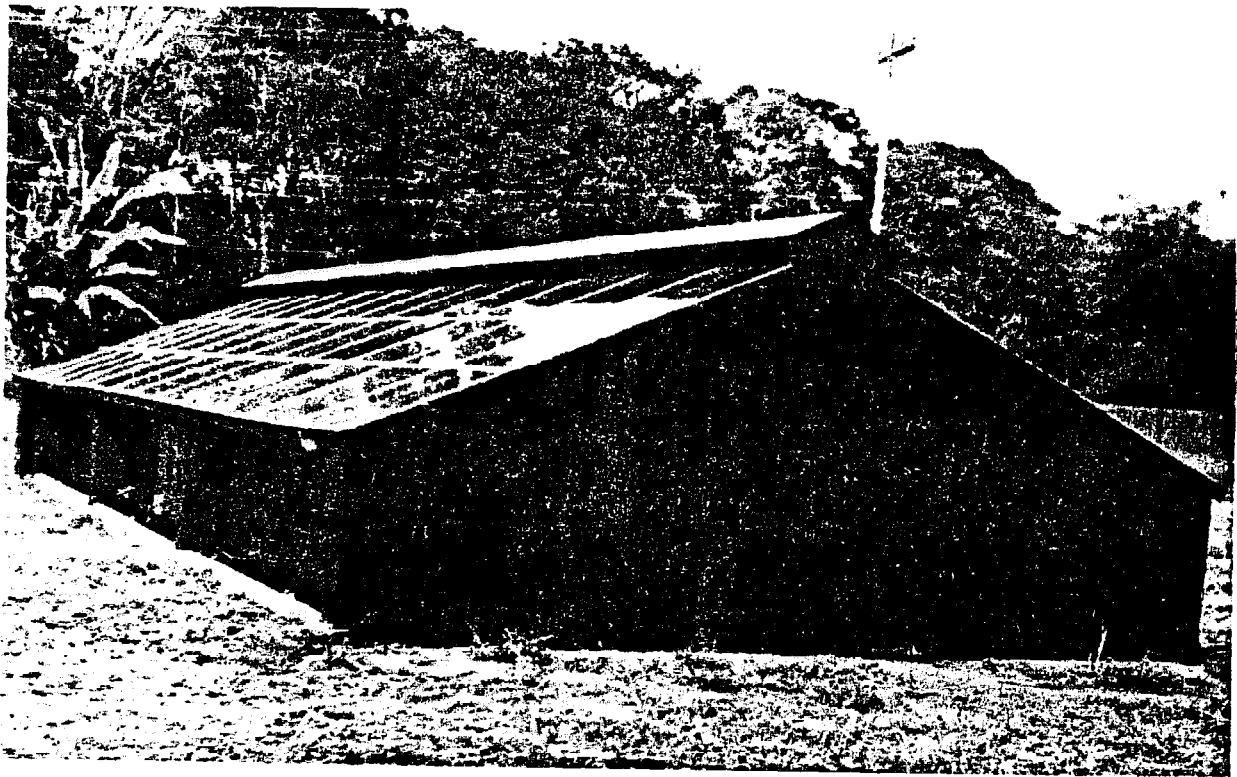


Figure 1. General View of the Prototype Glass-Roof Dryer  
Vue Extérieure du Prototype de Séchoir à Toit Vitré

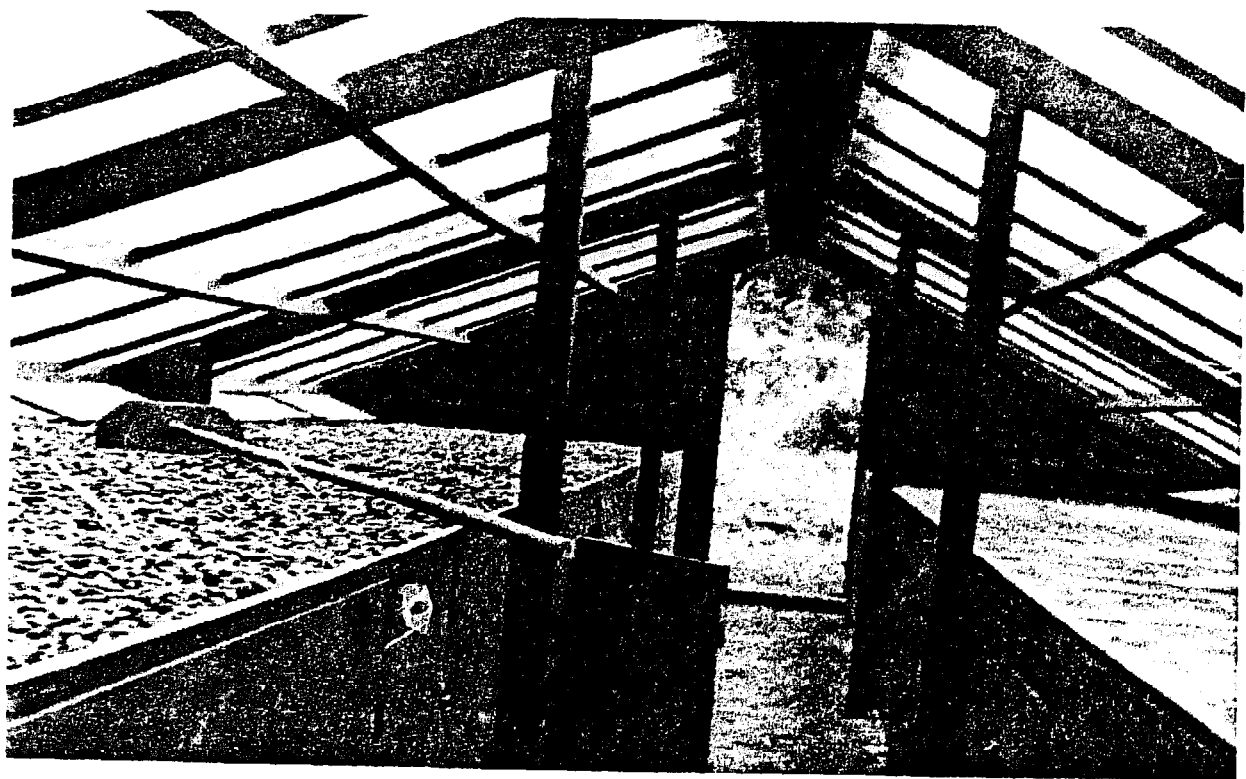


Figure 2. Interior of the Glass-Roof Dryer Showing the Two  
Platforms with a Central Passage. Drying Cocoa beans are  
Spread out on the Left Platform

Intérieur du Séchoir à Toit Vitré Montrant les Deux Plateformes  
de Séchage et le Passage central. On peut voir les Fèves de  
Cacao sur la Plateforme Gauche.



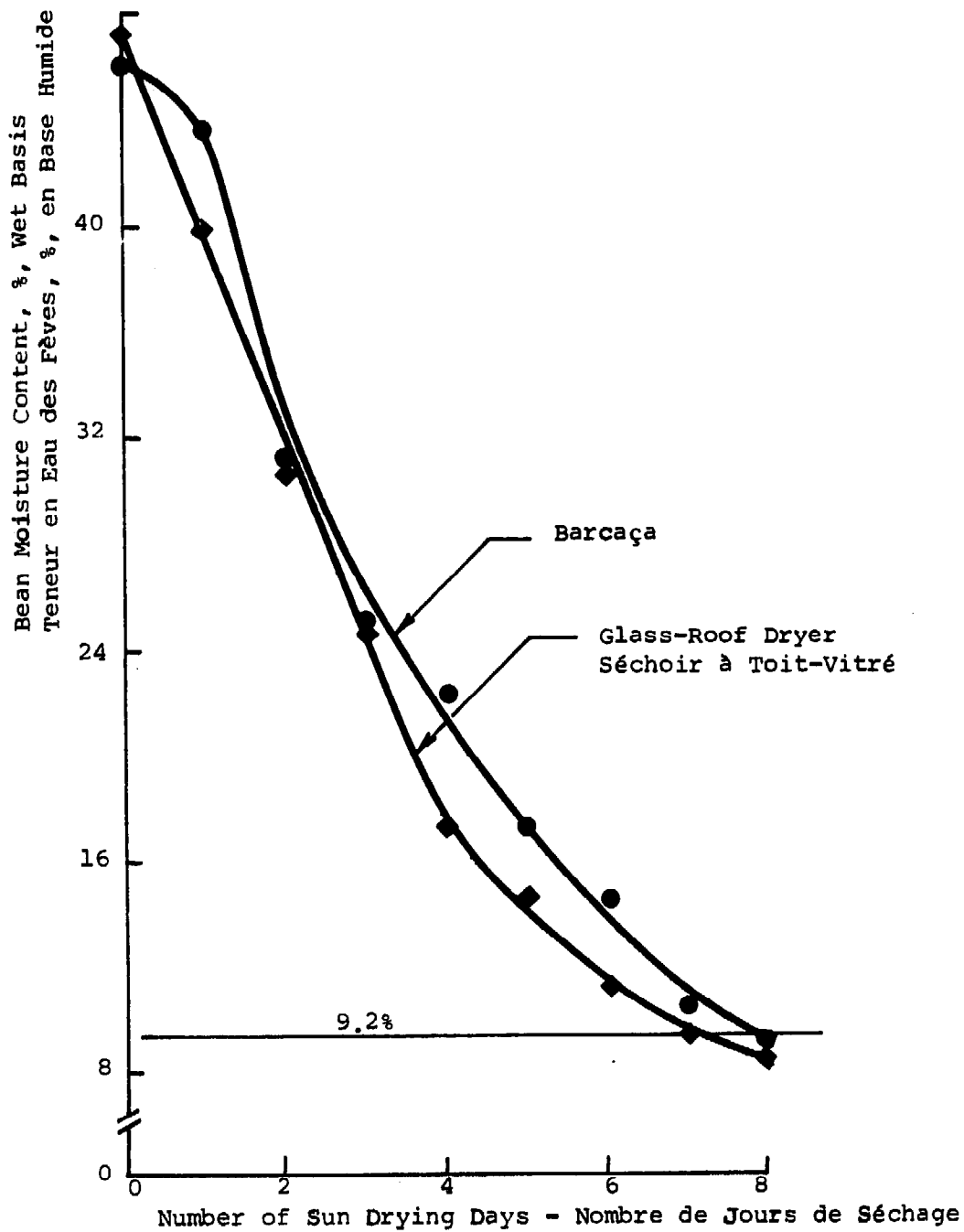
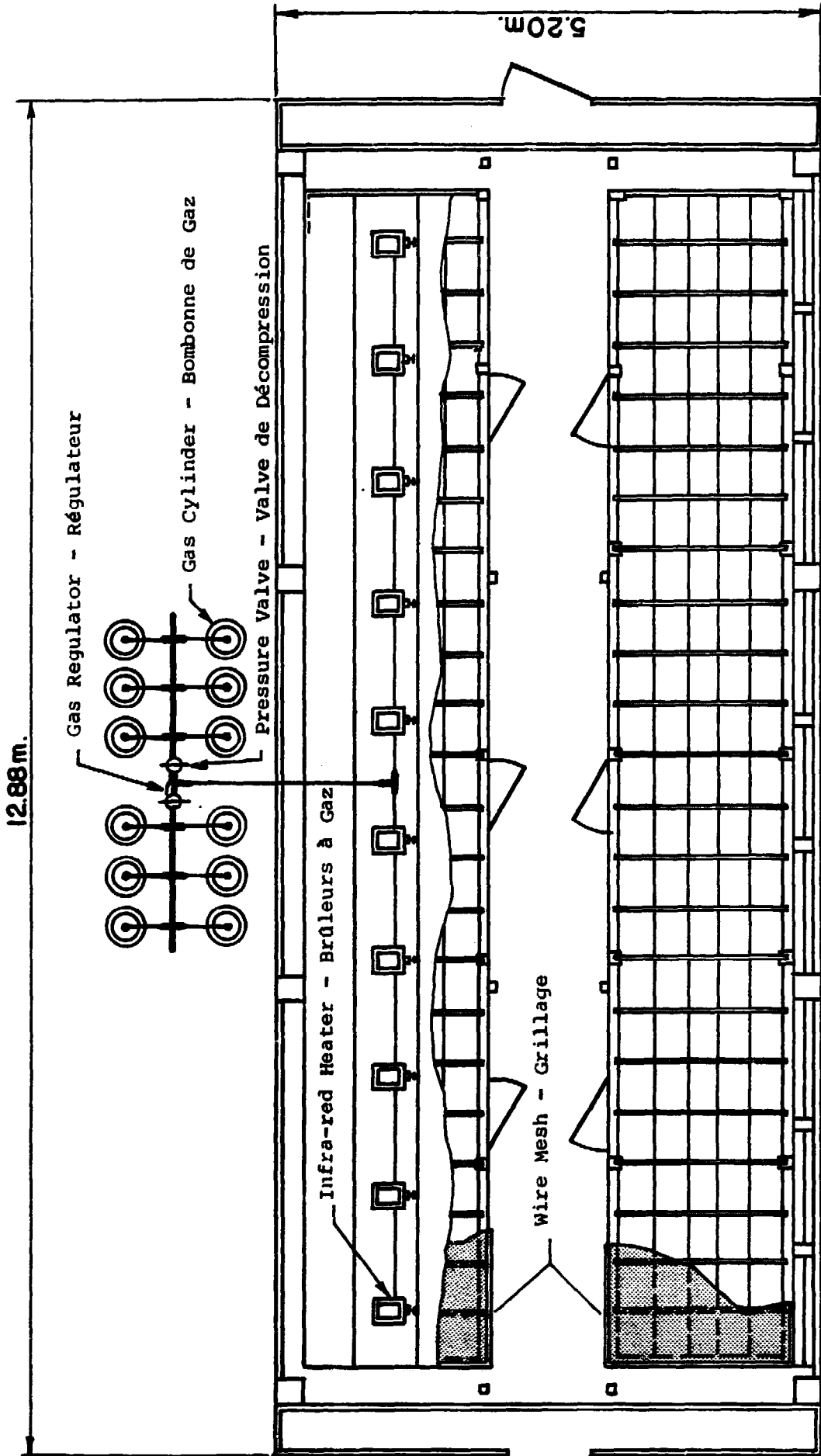


Figure 4. Drying Rate of Cocoa Beans with Solar Energy  
 Taux de Séchage de Fèves de Cacao pour Deux Méthodes de Séchage



CS/EC-I-7

Figure 5. Plan of the Glass-Roof Dryer, with Gas Heating Installation under one Platform.  
 Plan du Séchoir à Toit-Vitré Montrant l'Installation du Système de Chauffage au Gaz sous l'une des Plateformes.

SOLAR FRUIT AND VEGETABLE DRYER (U.S.A.)Overview:

Status: operational

Heating mode: mixed

Type: chamber dryer

Air circulation: natural  
convection

This simple chamber type dryer operates in both the direct and indirect mode. It was designed to dry food for domestic needs as well as for a small size restaurant, etc. It was successfully used for drying a wide variety of food products, ranging from fruits and vegetables to herbs and meat.

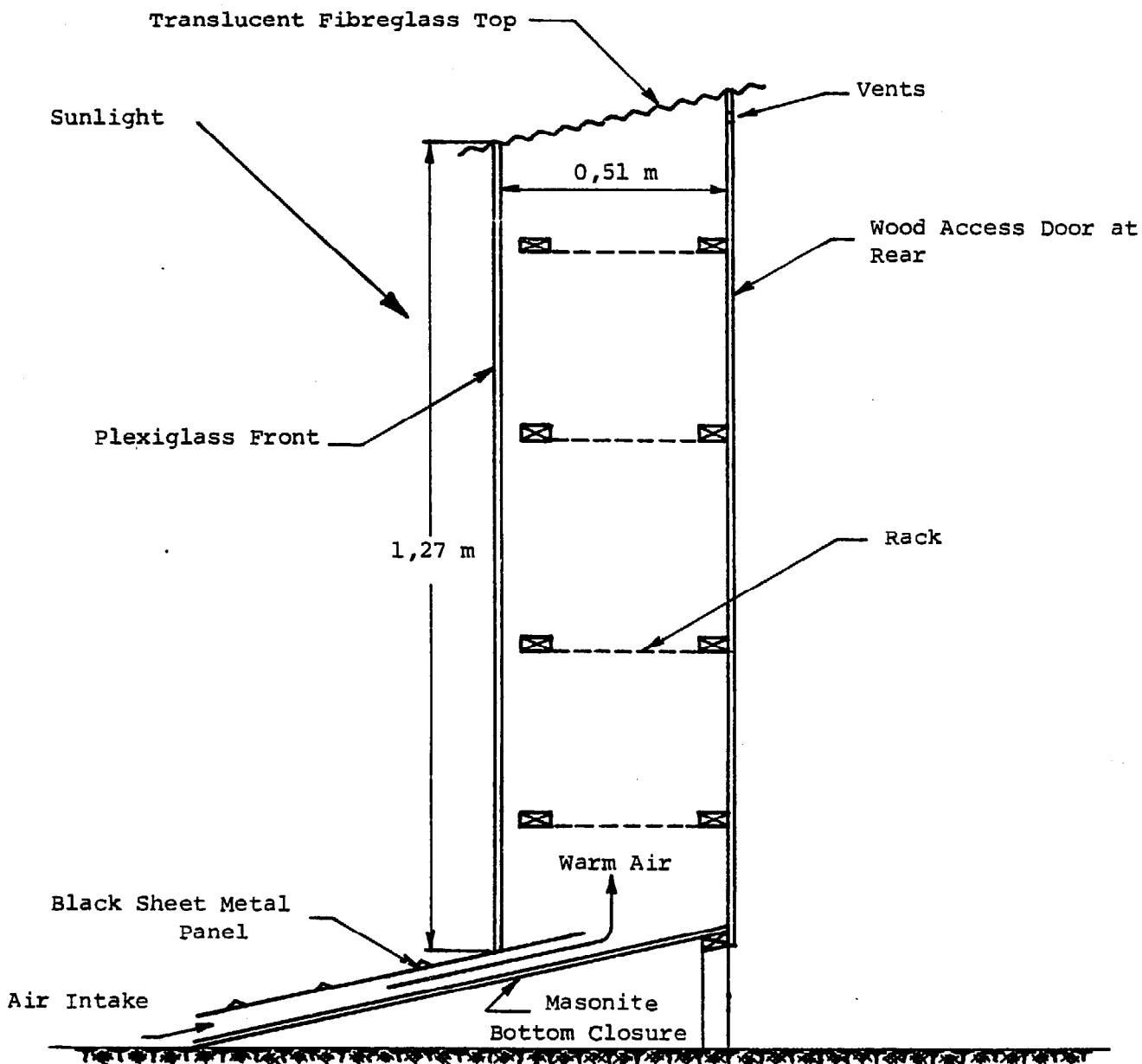


Figure 1. Section View of the Fruit and Vegetable Dryer

Characteristics:

Air, preheated in a solar air heater located at the base of the dryer, is admitted to the base of the drying enclosure. From there, it rises through the drying racks, dehydrating the product laid on them and is then exhausted with its moisture content by natural convection through openings located at the top, rear wall of the chamber. The drying process is also carried out with the help of direct sun reaching the product through plexiglass sides, front and top panels. The dryer faces south.

Dimensions: The drying box measures 2,45 m wide (8ft.), 1,27 m high (50 inches) and 0,51 m deep (20 inches). The air heater is 0,61 m long (2ft.) and runs all the width of the dryer base. See also the drawing - figure 1.

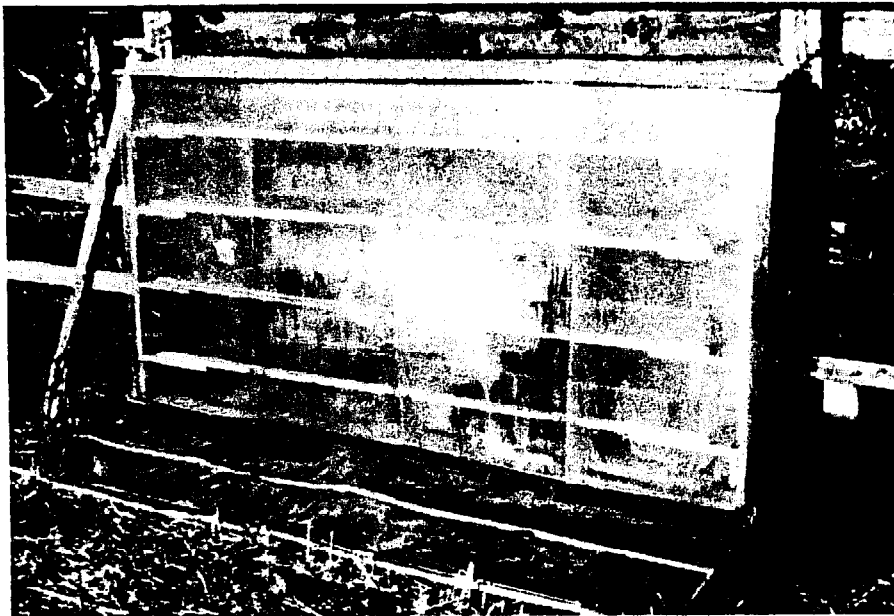


Figure 2. View of the Installation of the Dryer. The Four Drying Racks are Easily Seen.

Materials of Construction:

Drying Chamber

- Transparent cover: 3 mm plexiglass plate (glass could be used as well), and translucent fiberglass top
- Frames: wood
- Insulation: none used
- Trays: stationary wood frame racks, covered by stretched nylon mesh

**Solar Air Heater:**

Transparent cover: none  
Absorber: black sheet metal panel, which serves as a chamber plate and cover for the air heater  
Insulation: none  
Frames: wood frame with a masonite bottom

Location: El Rito  
New Mexico  
U.S.A.  
Latitude: 36°20'N  
Longitude: 106°12'W  
Elevation: 2 100 meters

Climatological Data:

Type of climate: semi-arid, sunny  
Air temperature: early fall days - usually 24°C to 26,5°C  
Relative humidity: 30 to 40 percent

In this region, the actual number of sunshine hours is approximately three quarters of the total possible hours of daylight throughout the year.

Practical Operation:

Number of units used in the past: one  
Number of units currently in use: one

Periods of Operation:

Field operation: from March 1972 to present. The dryer is used for domestic needs and small restaurant provisioning.

Drying Data:

<u>Materials</u>	<u>Quantity dried</u>	<u>Pre-Treatment</u>
apricots	about 5,5 Kg per load	quick blanching, halving and pitting
apples	---	peeling, coring, spiral cutting
peaches	--	--
squash	--	hand peeling and slicing
mushrooms	--	--
herbs	--	--
beef	--	sliced in strips

\*-- Data not reported

Drying time:

The author reported that one day of drying is sufficient under the most favourable conditions; two or three days are necessary if intervals of cloud are frequent. The dried materials were kept in a dry cool place.

Operating Conditions:

Usually sunny weather and normally fairly dry days made the drying process very easy.

Economic Details:

Cost of materials:	plexiglass plate, 3 mm thick	\$16,00
	fibre glass roof panel	5,00
	black metal sheet	4,00
	masonite back-up	4,00
	second-hand wood	5,00
	labour	self-employed spare time
	<b>TOTAL MATERIAL COST</b>	<hr/> \$34,00

Annual operating expenditures: none

Operating cost of drying per load of Material dried:

1 to 2 hours of domestic labour are required to prepare the materials to be dried and to fill the drying chamber.

Estimated Life of the Dryer: 20 years

Comments on the Dryer:

- . simple carpentry skill needed
- . not expensive
- . the main drawback is the lack of interest and initiative of people

Principal Investigator(s): Van Dresser, Peter

El Rito  
New Mexico 87530  
U.S.A.

PREHEATED CIRCULATION SOLAR DRYER (Turkey)Overview:

Status: experimental

Heating mode: mixed

Type: chamber dryer

Air Circulation: natural  
convection or  
fan-forced air

The dryer consists of a single flat rectangular box structure, set at a tilt to optimize solar collection. The space inside the drying box is used very efficiently because of the particular arrangement of the basket-trays. The unit was tested for 4 years.

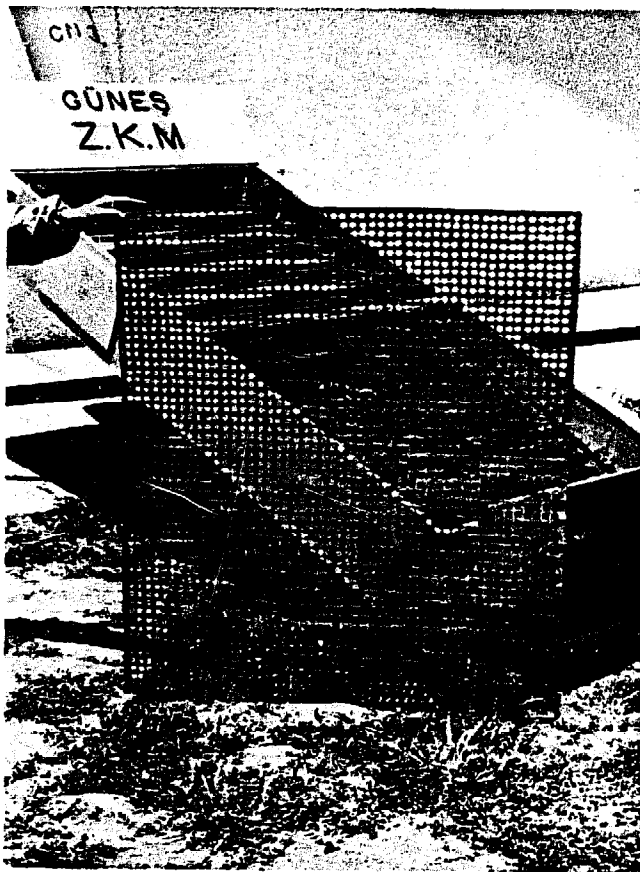


Figure 1. The Picture Shows in the Foreground the Perforated Copper Plate of the Air Heater. In the Background, the 5 Lattice Wire Baskets can be Seen Hooked on Strings.

Characteristics:

The drying box and the collector are built in a one piece enclosure covered with glass panels. The air heater (collector) is made of two absorber plates, one being a blackened corrugated iron plate, the other being a perforated copper plate, treated with a selective surface to increase its absorptive capacity for solar radiation and to reduce heat losses. The area of both the drying box and the air heater is one square meter each. Air circulation is achieved by either natural convection or a forced circulation provided by an electric fan. The product to be dried is put into lattice wired baskets, each one being hinged to a rigid rod fixed to the two side walls of the drying box section.

Dimensions: See Figure No. 2 and 3.

Materials of Construction:

Drying chamber

Transparent cover: glass of 3 mm thickness (plastic is good also)  
Frames: wood  
Insulation: glass wool (wood shavings can be used)  
Trays: lattice wire baskets

Solar Air Heater:

Transparent cover: glass of 3 mm thickness (plastic sheet is also suitable)  
Absorber: one perforated copper plate treated with a selective surface under which is placed one corrugated iron plate painted matt black  
Insulation: glass wool (wood shavings can also be used)  
Frames: wood

Location: Ankara, Turkey

Latitude: 39°23'N  
Longitude: 32°23'E  
Altitude: 900 meters above sea level

Climatological Data:

Sunshine hours: 2700 hours - 64% of theoretical sunshine hours  
Average annual radiation intensity: 3.5 Kwhr (m<sup>2</sup> . day) with a maximum in July and a minimum in December. The difference between the maximum and minimum values of the radiation intensity during the year is about 4.65 Kwhr/(m<sup>2</sup>.day)  
Relative humidity: varies from 20 to 80%  
Average ambient air temperature: 22°C in July, 3°C in December

Practical Operation:

Number of units used in the past: four collectors with different areas and absorption plates tested

Number of units currently in use: three

Periods of Operation of the Unit:

- (a) On experimental basis: July 1968 - November 1972
- (b) In field operations: not reported



### Drying Data:

<u>Material</u>	<u>Pre-treatment</u>
apricot	halving and sulphuring
peach	cutting in 4 pieces and sulphuring
apple	peeling, cutting in 4 pieces, sulphuring
pear	peeling, cutting in 4 pieces, sulphuring
plum	washing, cleaning
parsley	washing, cleaning
mint	washing, cleaning
aubergine	cutting
pepper	no treatment
string beans	cleaning, halving, blanching 5 to 10 minutes

Drying times are different for each material. It was found that peppermint had the shortest drying period (2 hours) and that the longest drying period occurred with peaches and apricots (50 to 60 hours).

### Operating Conditions:

The temperature increase in the drying box due to solar radiation intensity can be defined as follows; as proposed by the author.

$$y = -15,03 + 54,86x$$

where

x = is the average solar radiation intensity on the horizontal plane (cal/cm<sup>2</sup> per minute)

y = is the temperature increase of the drying box for one hour with respect to the outside air temperature (°C)

The drying process was continued by forced circulation (fan) when the natural convection was too low inside the dryer. Even without the fan, the results were still satisfactory.

### Economic Details:

Cost of materials:	fan	13,00	\$U.S.
	holed copper plate	14,00	
	glass cover	5,00	
	insulation	6,60	
	wood frame	13,30	
	labour	14,30	

TOTAL COST \$U.S 66,20 (about 1 000 TL - 1970)

\$1.00 U.S. = 15 TL (Turkish Lira)

### Annual Operating expenditure:

The cost of repair and maintenance work per year is about 4 percent of the unit's total cost.

Cost of drying related to a Unit of Material Dried:

Using the dryer 90 days per year, unit costs were about 0,30 Tl per Kg.  
(amortissement ratio 20%)

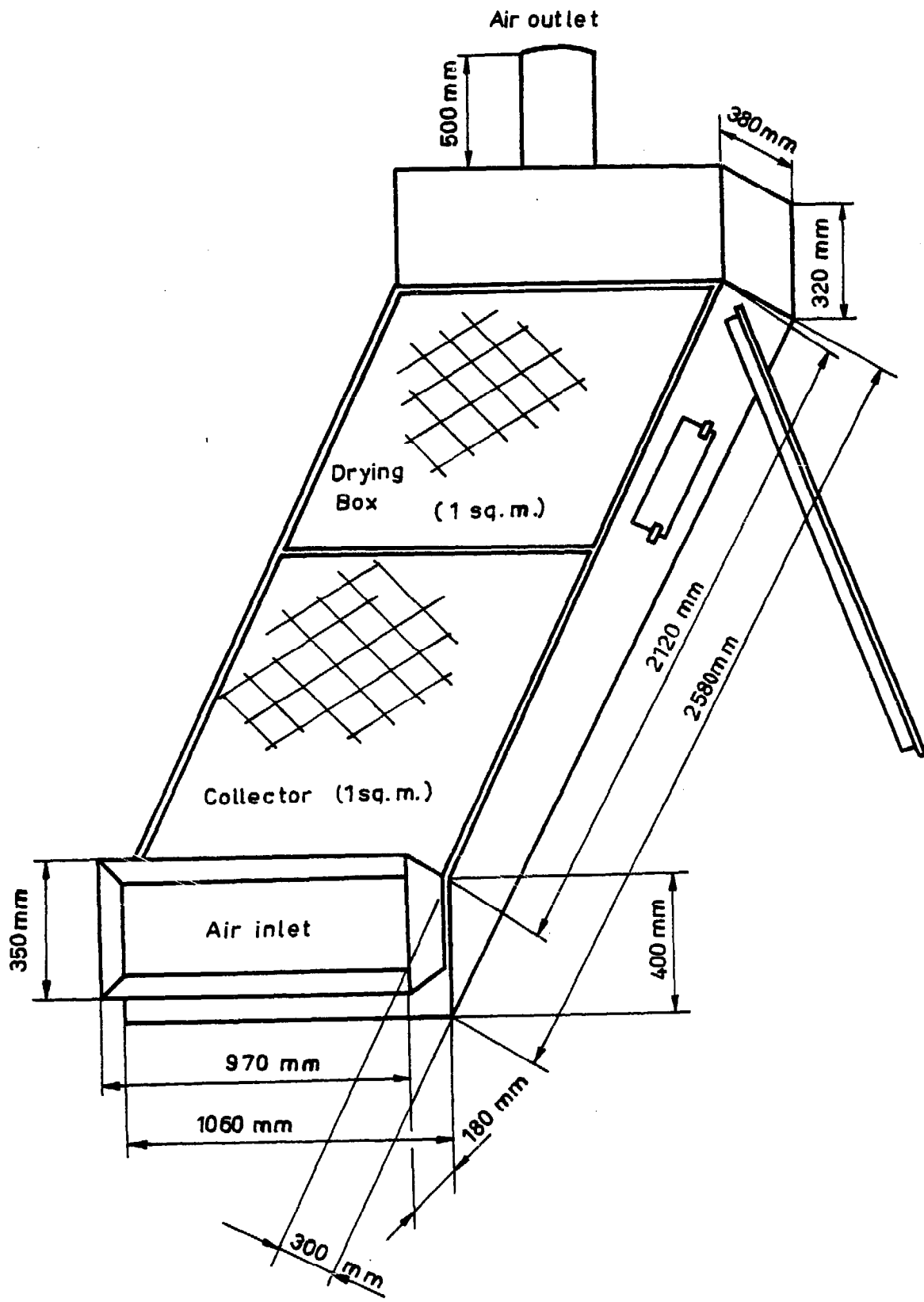
Estimated Life of the Dryer: 5 years

Comments on the Dryer:

- . increasing the capacity, the costs per square meter of useful drying space will decrease. It is thus advisable to use large capacity devices.
- . it might be still more economical to use local labour and locally available materials.

Principal Investigator(s): Mustafa Ozcan Ultanir

Ankara Universitesi Ziraat, Facultesi Zirai  
Kuvvet Makilanair Kursusu, Aydinlikevler  
Ankara, Turkey



**FIGURE 2. GENERAL VIEW AND DIMENSIONS**

ORCHARD TYPE SOLAR DRYER (Turkey)Overview:

Status: operational

Operating mode: mixed

Type: chamber dryer

Air circulation: natural  
convection

This solar dryer is of simple construction and maintenance and utilizes readily available materials. The authors claim that the cost of dehydration per unit of dried products for this dryer is less than for all other known systems and techniques of drying. The quality of the dried product is preserved and the drying times are reduced significantly. The dryer is well suited for small and middle scale requirements.

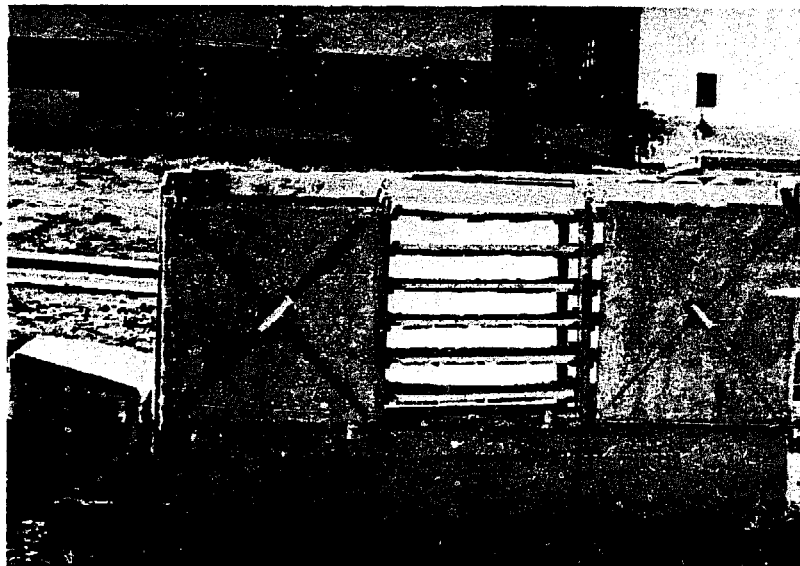
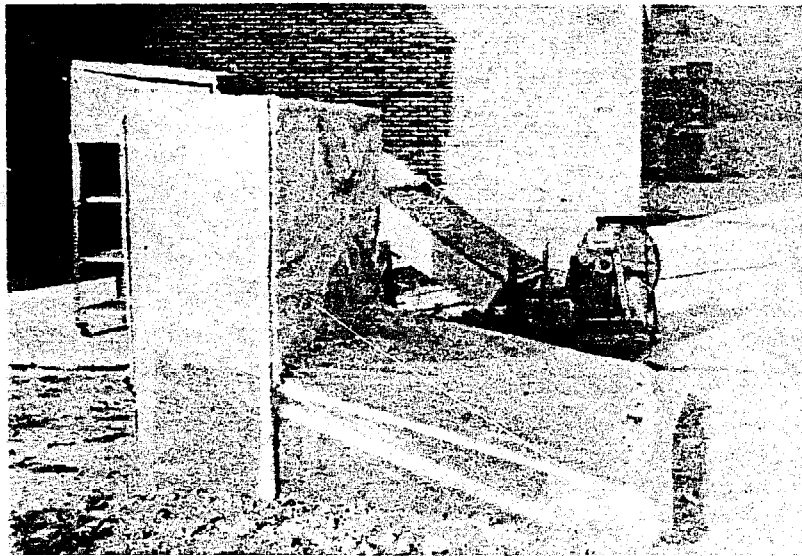


Figure 1. Views of the Orchard Solar Dryer

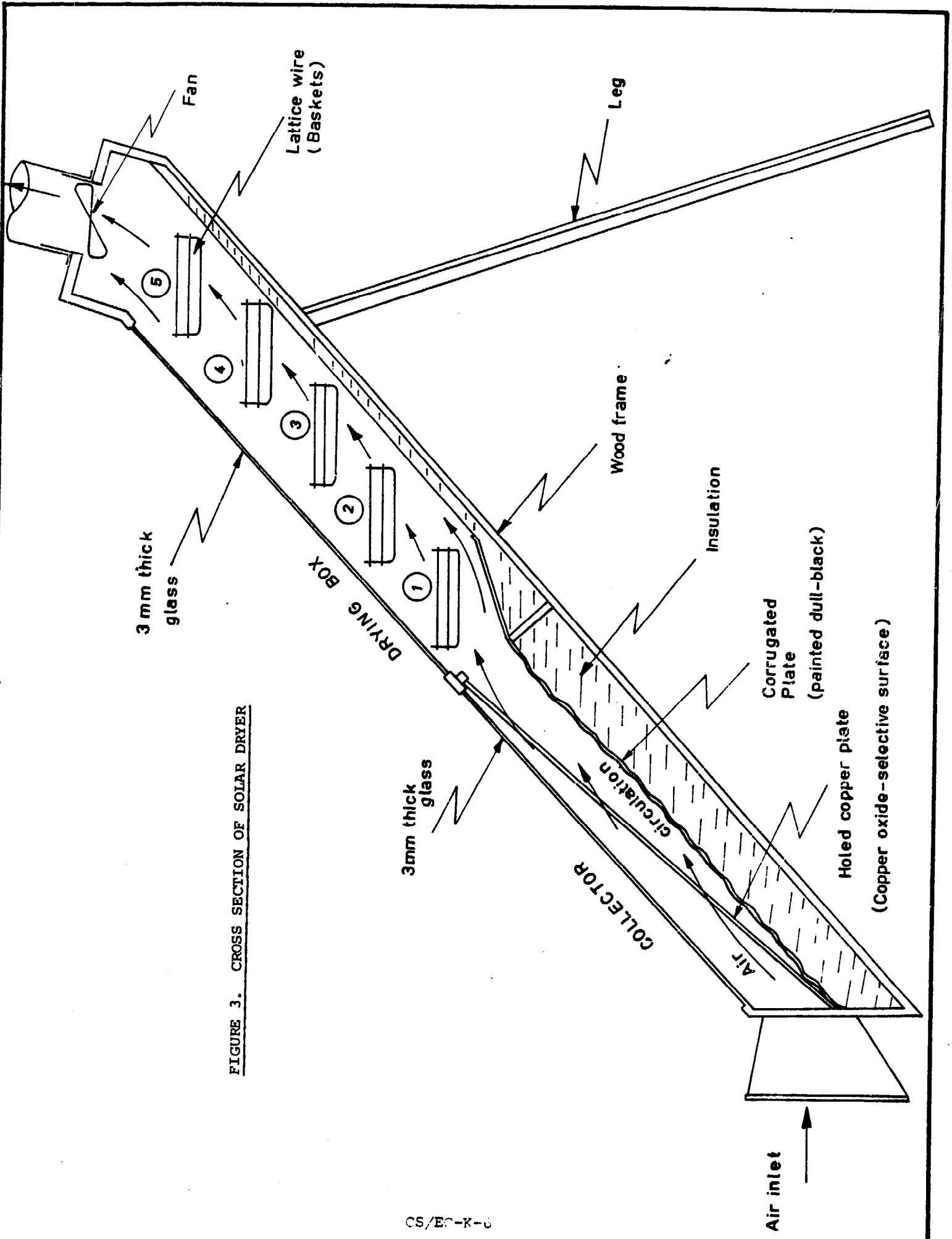


FIGURE 3. CROSS SECTION OF SOLAR DRYER

### Characteristics:

The first prototype of the orchard dehydrator (O.D.) consisted of a solar air heater joined to a vertical multi-story array of wooden shelves and covered with cotton tulle. This gives an effective drying area of 7 square meters. The air heater, comprised of an inclined matrix of steel shavings ten centimeters thick was essentially the same as that used in the laboratory type of dryer (see preceding case study). The ambient air enters the heater from the lower south edge, is heated in the hot matrix and is then admitted to the insulated mixing chamber. The heated air then rises through the 18 cotton tulle-covered shelves and is exhausted through adjustable vents on the top northern edge. Two layers of polyvinyl chloride (PVC) plastic enveloped the exterior surfaces of the entire dehydrator. In each drying test, comparison tests were done on a control shelf for sun drying, and in another shelf (so-called shelf 1) located in the laboratory type of dryer. Only natural convection was used in the orchard dryer. Further slight improvements of the O.D. led to the improved orchard dryer (I.O.D.) whose design can be seen in Figure 2.

Dimensions: See Figure 2 for the dimensions of the improved orchard dryer.

### Materials of Construction:

#### Drying Chamber:

Transparent cover: 2 PVC layers  
Frames: wood  
Insulation: rockwool  
Trays: wooden slats

#### Solar Air Heater:

Transparent cover: 2 PVC layers  
Absorber: 10 cm of steel chips on chicken wire  
Insulation: rockwool  
Frames: wood

All materials locally available.

Location: Middle East Technical University  
Ankara, Turkey

Latitude: 40°N  
Longitude: 32°E

### Climatological Data:

Relative humidity is usually low in the drying season (July to September), averaging about 80% in the nights and 40% at noon. There is usually no rain from June to October.

### Practical Operation:

Number of units used in the past: one  
Number of units currently in use: none

### Periods of Operation:

- (a) On experimental basis: May 1971 to October 1971  
(b) In field operations: The investigators consider these units about ready to go into field operation.

### Drying Data:

<u>Material</u>	<u>Quantities Dried (Kgs/m<sup>2</sup>)</u>	<u>Pre Treatment</u>	<u>Drying Time (hours)</u>	<u>Preferred Drying Ratio</u>
Mulberries (1)	5		100	4,5 to 9,0
Peaches	10	lye peeled, cut into eights and sulphured (2hrs)	110	4,0
Seedless Grapes*	8,2	lye dipped	156	3,5
Zucchini*	10,0		120	

\* It was found that the cotton tulle was not suitable for tray netting because during the initial hours of dehydration of both mulberries and peaches, the juice was accumulated on the central part of the netting, hindering the passage of air. The juice then dripped onto the lowest shelves and glued the products to the cotton tulle. Therefore, the last two products tested were laid on parallel beachwood strips, 1 cm x 1 cm set 1 cm apart.

(1) See Figure 3.

### Operating Conditions:

The sun drying control shelf gave, in each run, a very low quality final product due to the interference of birds, insects and mold growth. The drying times in the laboratory dryer were always shorter than those recorded in the orchard dryer, due principally to a more uniform heat flow.

It was noted that in the orchard dryer, the shelves on the eastern end dried more slowly than those on the western end of the dehydrator.

### Economic Details:

#### Cost of Materials: Solar Collector:

Steel chips	\$ 4,00 U.S.
PVC cover	2,70

#### Drying Chamber:

wood	\$21,70 U.S.
insulation	3,00
PVC	4,00
miscellaneous	1,70
total labour	10,80

TOTAL COST \$47,90 U.S.

The author gives figures for a scaled up model that has been extrapolated from the unit described here for a village. That model would have an effective drying area of 100 square meters for a total cost of approximately \$280. U.S. (4200 Turkish lira).  
\$1,00 U.S. = 15 Turkish lira

Annual Operating Expenditure:

Renewal of PVC cover	\$1,70 U.S.
Labour	<u>1,40</u>
TOTAL	\$3,10 U.S.
	\$6,70 U.S. for the scaled-up model

Cost of Drying Related to a Unit of Material Dried:

\$0,02 U.S./Kg for peaches  
0,03 U.S./Kg for grapes  
0,09 U.S./Kg for dried peppers

Estimated Life of the Dryer: Approximately 10 years

Comments on the Dryer:

- (1) To overcome the problem of slower drying time on the eastern end of the dryer and to uniformize the drying process, it was decided to rotate the dryer by 90° towards the west. This led to the improved orchard dehydrator of Figure 2. The authors reported that the performance was increased in most of the shelves by 25%, while the drying rates of the slower drying shelves in the orchard dryer were not affected. Also, it was observed that there was a slight improvement in the uniformity of drying in the individual shelves.
- (2) Materials of construction are readily available.
- (3) Construction is quite simple.

Principal Investigator(s):

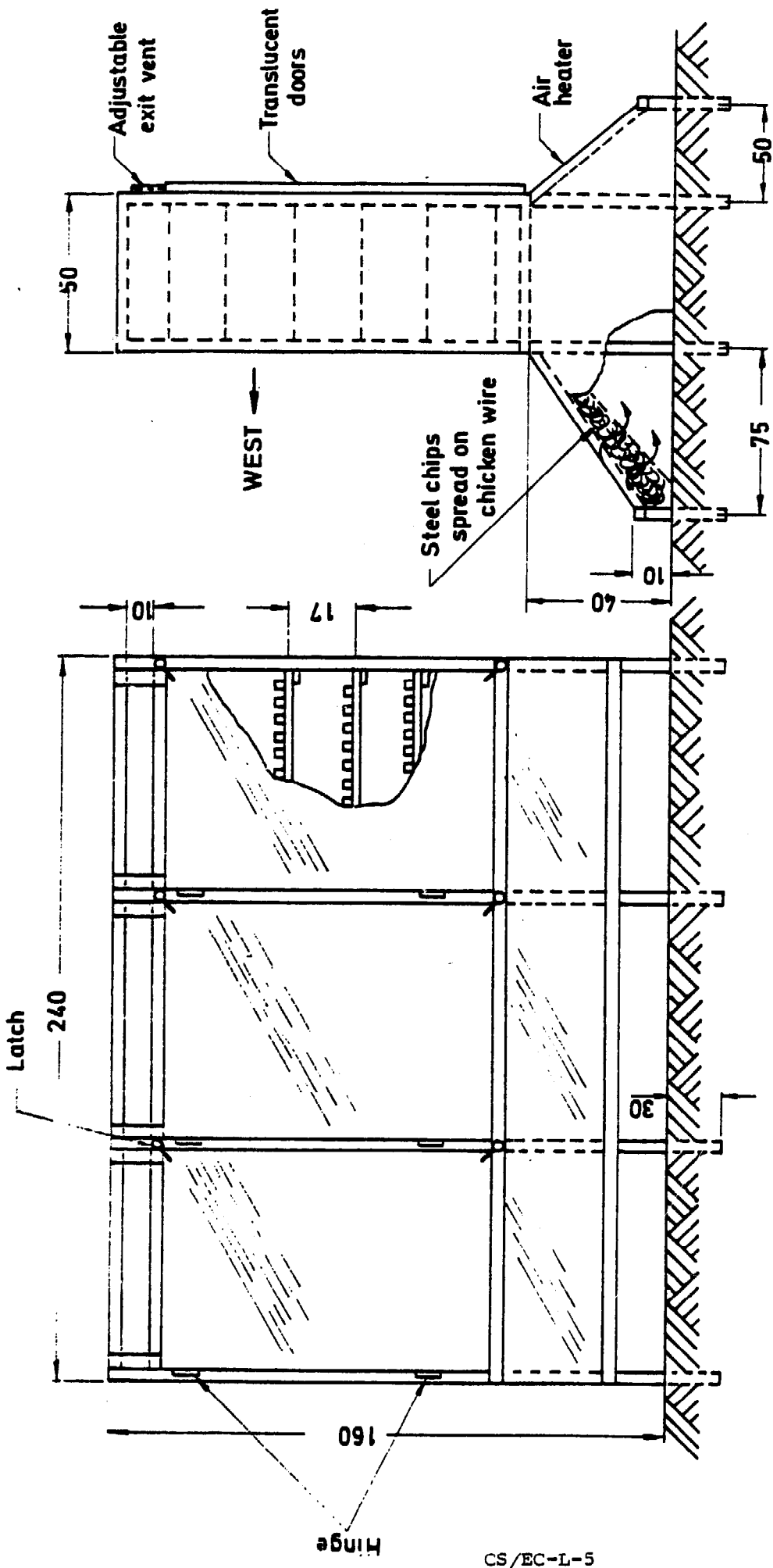
Akyurt, M., Ozdaglar, I.

Middle East Technical University  
Mechanical Engineering Department  
Ankara, Turkey

References:

- (1) Akyurt, M., Ozdaglar, I., Selçuk, M.K., A Solar Dehydrator for Orchards, Coopération Méditerranéenne pour l'énergie solaire (COMPLES) Bulletin, April 1973, pp. 47-50, 5 references
- (2) Selçuk, M.K., Ersay, O., Akyurt, M., Development, Theoretical Analysis and Performance Evaluation of Shelf Type Solar Dryers, Solar Energy No. 2, October 1974, pp. 81-88



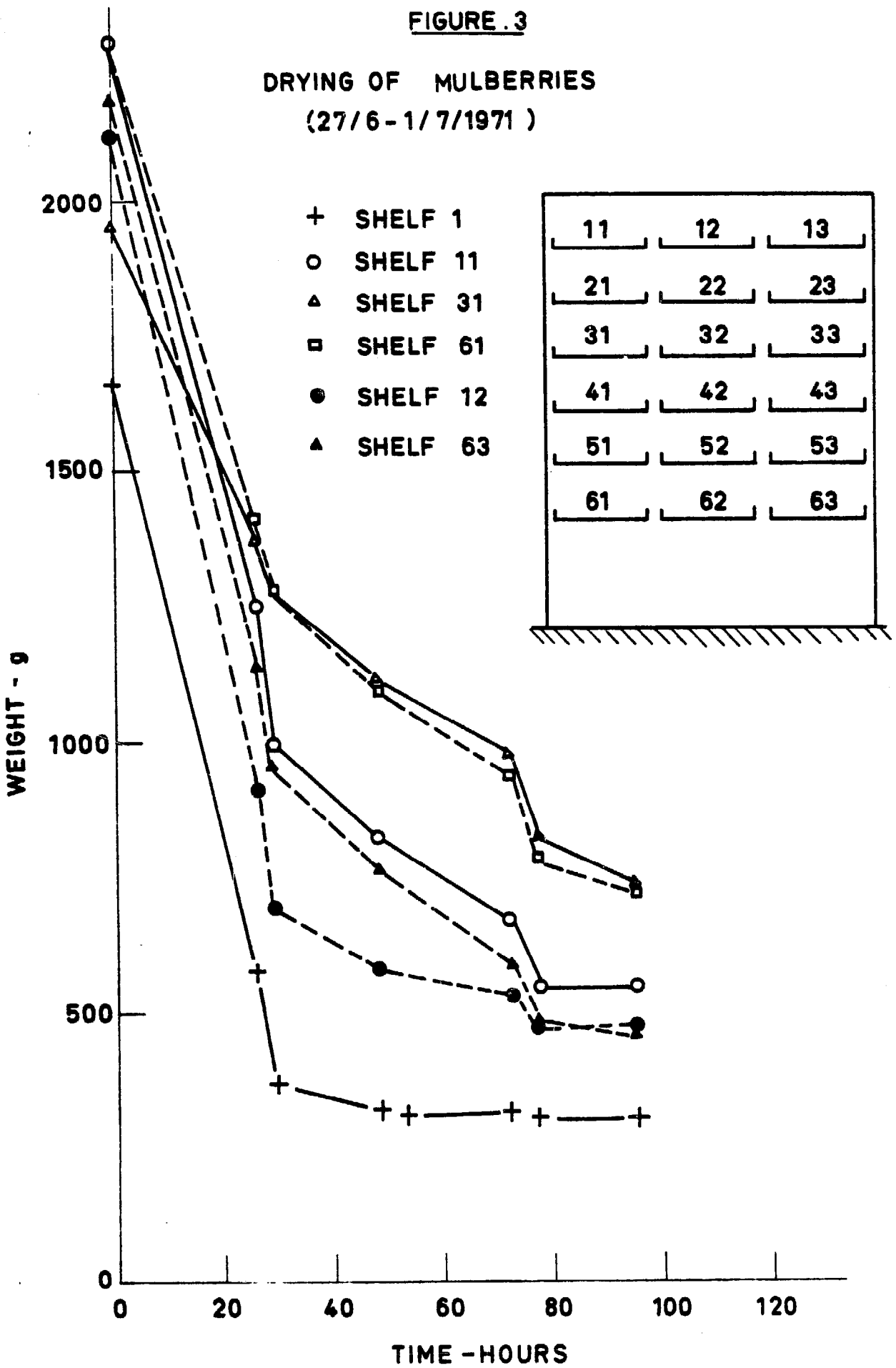


Main columns are of 5x5 cm pine.  
 Strips of wood for the trays are of 1x1 beechwood.  
 The 0.1 mm thick polyethylene sheet covers (in two layers) the entire exterior surface.  
 All dimensions are in centimeters.

**FIGURE. 2 FINAL DESIGN OF THE VILLAGE DEHYDRATOR.**

FIGURE .3

DRYING OF MULBERRIES  
(27/6 - 1/7/1971)



LABORATORY TYPE SOLAR DRYER (Turkey)Overview:

Status: experimental  
Type: chamber dryer

Heating mode: combined or hybrid  
Air circulation: natural  
convection or  
fan-forced air

The solar dryer presented in this study was developed as a prototype and solely for laboratory use. Under a wide range of weather conditions, it dried green pepper and grapes to commercially acceptable moisture levels with good final product quality. An auxiliary heating system was coupled to the dryer for periods of bad weather.

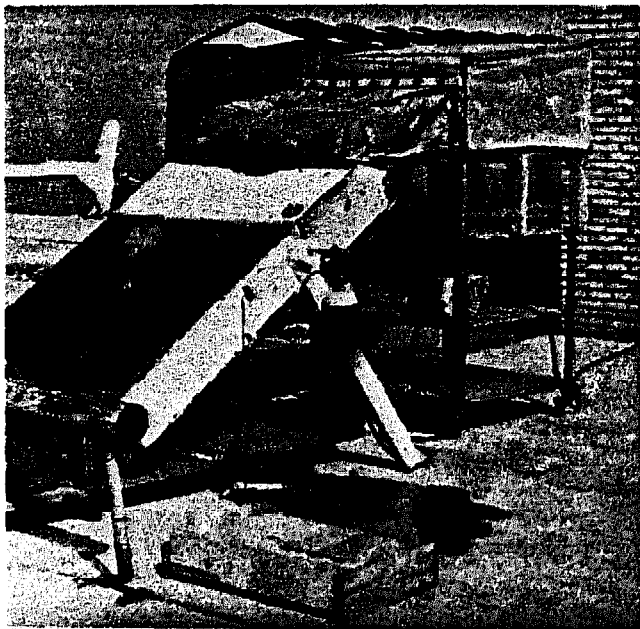


Figure 1. Views of Solar Dryer



### Characteristics:

The drying chamber has translucent east and west walls and a roof consisting of four layers of polyvinyl chloride sheets separated by air gaps. As well as providing good insulation, up to 75% of the incoming radiation is transmitted, permitting full colour development of the drying product. With this design, the exposure of the drying goods to undesirably high direct radiation intensities is prevented as well. Shelves of plastic covered wire mesh were designed for protection against sulphur dioxide (SO<sub>2</sub>) corrosion as this chemical was used in pretreatment of the products.

The collector, with a net collection area of one square meter, consists of a single layer glass cover and a 10 cm thick pillow of steel chips encased in chicken wire. The matrix was painted black and fitted in a wooden frame with insulated side walls and bottom.

The dryer has an auxiliary heating system which is parallel to the solar collector. A gas burner was installed inside the tunnel connecting the collector to the drying chamber.

### Materials of Construction:

#### Drying Chamber

Transparent cover: PVC sheet, 4 layers  
Frames: wood  
Insulation: rockwool  
Trays: plastic covered wire mesh

#### Solar Air Heater

Transparent cover: glass, 3 mm thick  
Absorber: 10 cm thick pillow of steel filings encased in chicken wire  
Insulation: rockwool  
Frames: wood

Location: Middle East Technical  
University, Ankara, Turkey  
Latitude: 40°N  
Longitude: 32°E

Climatological Data: Not reported.

#### Practical Operation:

Number of units used in the past: one  
Number of units currently in use: none

#### Periods of Operation:

- (a) On experimental basis:  
August 1970 - September 1971  
(b) In field operations: --

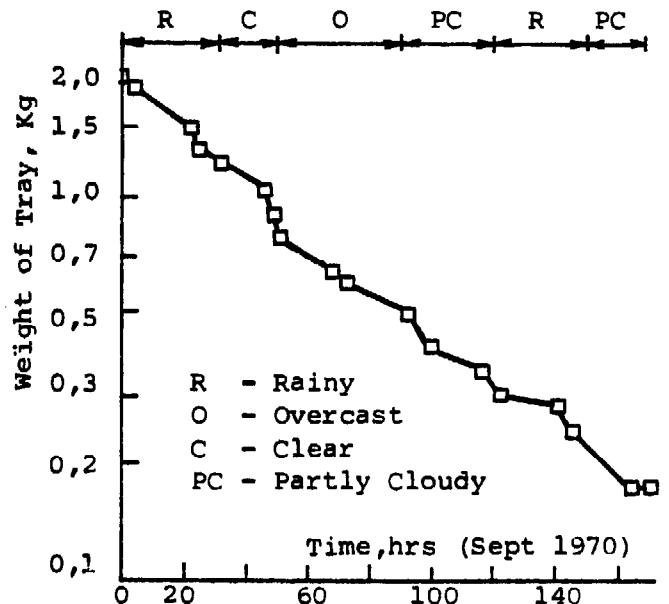


Figure 2. Weight Loss vs. Time for Sliced Green Bell Peppers

Drying Data:

Material Dried	Quantities of Fresh Material Dried (Kg/sq.m.)	Drying Time (hrs.)
green bell peppers	10	160
sultana grapes	15	400
onion rings*	6	48

\* in this test an auxiliary heater was used.

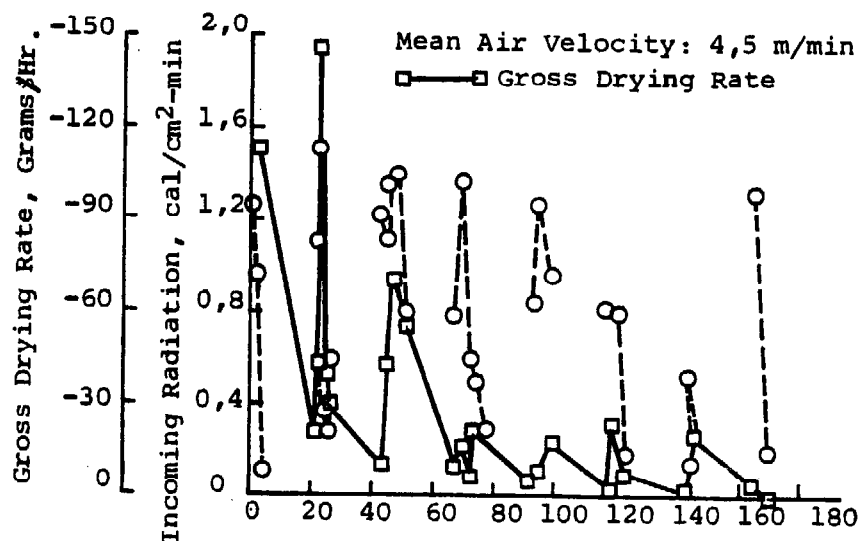


Figure 3. Gross Drying Rate and Total Radiation Intensity for Sliced Green Bell Peppers for a Typical Tray

Operating Conditions:

When natural convection only was used, it was demonstrated that in the solar collector, air could be heated up to 40°C above ambient temperature.

Economic Details:

Cost of Materials: Collector	-	glass, 1m <sup>2</sup> x 3 mm thick	1,85 \$U.S.
		steel chips, 10 Kg	,30
		wooden frame	6,65
		insulation	2,00
		paint & miscellaneous	1,00
		Sub-total	11,80
Drying Chamber		linoleum	6,65
		insulation	2,00
		wooden frame	3,30
		PVC sheets	,65
		shelves and guides	10,00
		Sub-total	22,60
Labour		Sub-total	16,60
\$1.00 U.S. = approximately 15 Turkish lira (1970)		TOTAL	<u>\$51,00</u>

Annual operating expenditure:

Polyvinyl chloride sheet replacement and labour \$4,50 U.S.

Cost of Drying related to a Unit of Material Dried:

Estimated: 0,08 \$US/Kg of dried grapes

0,23 \$US/Kg of dried peppers

3,30 \$US/Kg of dried onions (with auxiliary heating)

Estimated Life of the Dryer:

Approximately 10 years requiring an annual renewal of polyvinyl chloride (PVC) cover.

Comments on the Dryer:

This dryer has only been developed for laboratory use. The experience gained indicated that in essence the unit is structurally and functionally operative. Even under unfavourable weather conditions, the unit is able to produce good quality dried products.

The authors would not advocate this dryer for commercial operation, since it is not intended for economy, but for research.

Principal Investigator(s): Akyurt, Mehmet  
Selçuk, Kudret

Mechanical Engineering Department  
Middle East Technical University  
Ankara, Turkey

Reference:

- (1) A solar dryer supplemented with auxiliary heating systems for continuous operation, Akyurt, M., Selçuk, K., Solar Energy 1973, Vol. 14, pp. 313-320
- (2) A continuous solar dryer, Akyurt, M., Selçuk, K., Akyurt, S., 4 pp. Presentation at COMPLES Conference, Athens, 4-9 October 1971.

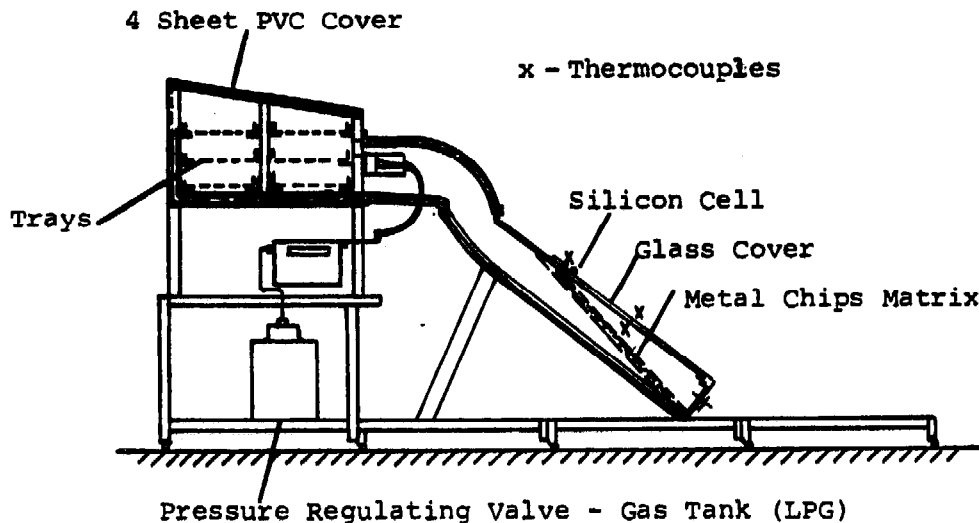


Figure 4. Section View of Solar Dryer Indicating Experimental Set-Up

NATURAL CONVECTION DRYER (Trinidad, West Indies)Overview:

Status: experimental

Heating mode: mixed

Type: chamber dryer

Air circulation: closed cycle  
natural  
convection

The main feature of this unique dryer is that it works in a closed cycle by natural convection generated by the mass transfer condensation on the dehumidifier integrated to the unit. It thus produces both dry crops and water.



Figure 1. Drying Cabinet Showing Drying Trays. Ripe Bananas are Being Dried in this Case.

### Characteristics:

The basic principle of operation of this natural convection, air-recirculating unit is as follows:

Air heated in the solar air collector passes into the drying cabinet and removes moisture from the crop. As the air removes the moisture from the crop, it cools and falls in the dehumidifier where it deposits its moisture on the dehumidifier roof. From there, the air re-enters the solar air heater (collector) to be reheated and the cycle starts again. The rectangular air box is sloped at 20° and is covered with two layers of glass. The collector has a tinned black absorbing surface to maximize the heat transfer to the air stream. The top of the collector box is connected to the top of a drying cabinet whose roof acts as a supplementary collector. This cabinet contains five drying trays with wire mesh bottoms. Two apertures connect the bottom of the drying cabinet with the rectangular dehumidifier box which is covered by a layer of glass. Short ducts connect the dehumidifier with the lower end of the flat plate collector.

### Dimensions:

Drying cabinet roof: 1,22 m x 0,91m (volume 0,5 m<sup>3</sup>)  
Dehumidifier box: 1,22 m x 0,91 m x 0,15 m  
Short ducts: 0,30 x 0,15 m of cross section  
Flat plate collector: 1,83 m x 1,22 m

### Materials of Construction:

#### Drying Chamber:

Transparent cover: glass, 2 sheets  
Frames: these were fabricated from rectangular cuts in a 0,457 mm (26 gauge) galvanized mild steel plate using a metal folder and a welding machine  
Insulation: Styrotex  
Trays: 6,4 mm galvanized wire mesh

#### Solar Air Heater:

Transparent cover: Glass, 4 sheets  
Absorber: iron sheet  
Insulation: vermiculite  
Frames: made with 0,457 galvanized steel

### Location:

University of West Indies  
St. Augustine, Trinidad  
West Indies

Latitude: 10°38'N  
Longitude: 61°24'W



Climatological Data:

Dryers operate during the dry season, approximately January to April.

Sunshine hours                    8-10 per day  
Ambient temperature            28-32°C  
Relative humidity               70-85%  
Solar energy received         5,4 to 6,0 Kwhrs/(m<sup>2</sup>.day)

Practical Operation:

Number of units used in the past: none  
Number of units currently in use: one

Periods of Operation:

- (a) On experimental basis: January to April 1972
- (b) In field operations: none

Drying Data:

<u>Material</u>	<u>Quantities (Kg)</u>	<u>Drying Times (sunlight hours)</u>
Yams	100	20
Sweet potatoes	200	15
Cassava	20	15
Nutmeg	50	15 - 20
Grass	100	8
Sorrel	200	10
Ripe bananas	20	15
Peanuts	-	12

Operating Conditions:

The crop is placed in drying trays. If it is in large pieces like yam or potato, it should be sliced or chopped. Cassava and sweet potato have been chopped into small chunks, 1 cm<sup>3</sup> and smaller before drying. Yam has been sliced into thin strips 1 to 3 mm thick before drying.

Economic Details:

Cost of materials:	<u>U.S. \$</u>
19 sheets, 0,457 galvanized steel	50.35
7 sheets, 1,22 m x 0,91 m x 3,17 mm glass	25.20
22,5 Kg, 50/50 tin-lead solder	87.50
3 tubes silicone sealant	13.50
2½ Kg styrotex beads	6.90
1 Kg vermiculite	.50
5 m, 6,35 mm mesh galvanized wire	3.12
4 hinges, rivets and paint	<u>4.10</u>
TOTAL COST of materials:	191.17
Labour, 120 man hours	<u>96.00</u>
TOTAL COST (1971)	287.17

**Annual Operating Expenditure:**

On the average, the unit will dry 11 Kg in about 10 hours and 22 Kg in about 15 hours since the lower trays dry more slowly. About 30 minutes per day is required for filling and charging trays. Operating costs are therefore about 1 person-hour of labour per 22 Kg load.

Capital costs, depreciation and interest rates will have to be calculated for each locality and will vary.

In Trinidad, capital charges are about 38.00 \$U.S. per year, assuming an interest rate of 10%, an insurance cost of 5.00 \$U.S. and a life expectancy of 10 years. At 1 100 Kg per year (assuming 100 days of drying) operating costs are 75.00 \$U.S. Hence drying cost about 10.3 ¢ per Kg. This is for a seasonal crop where the load factor is about 30%; with higher load factors, costs will be lower.

Balance of money for the production of dried sorrel, under Trinidad conditions:

Expenditures:	cost in U.S. \$
50 Kg of fresh sorrel	12.00
removal of seeds (about 50% of total weight)	4.00
drying (25 Kg at 10.3 ¢ per Kg)	2.58
transport, storage, etc. (2,5 Kg at 10¢ per Kg)	0.25
<b>TOTAL COST</b>	<b>18.83</b>

**Incomes:**

Sales during the off-peak season

2,5 Kg at 11.00 \$U.S. per Kg	27.50
net profit	8.67

i.e., it is possible to obtain a profit of nearly 50% on sorrel if it is dried, stored and then sold during the season when it is scarce.

Estimated Life of the Dryer: 8 to 10 years

Comments on the Dryer:

Construction problems are mostly technical; they require the use of a reasonably good sheet metal workshop. If however, the unit is built with wood, then construction is simple.

This unit is experimental and it is too expensive to be built on a large scale.

Principal Investigator(s):

Headley, Oliver  
Springer, Basil

University of West Indies  
St. Augustine, Trinidad  
West Indies

No. 1 Dryer

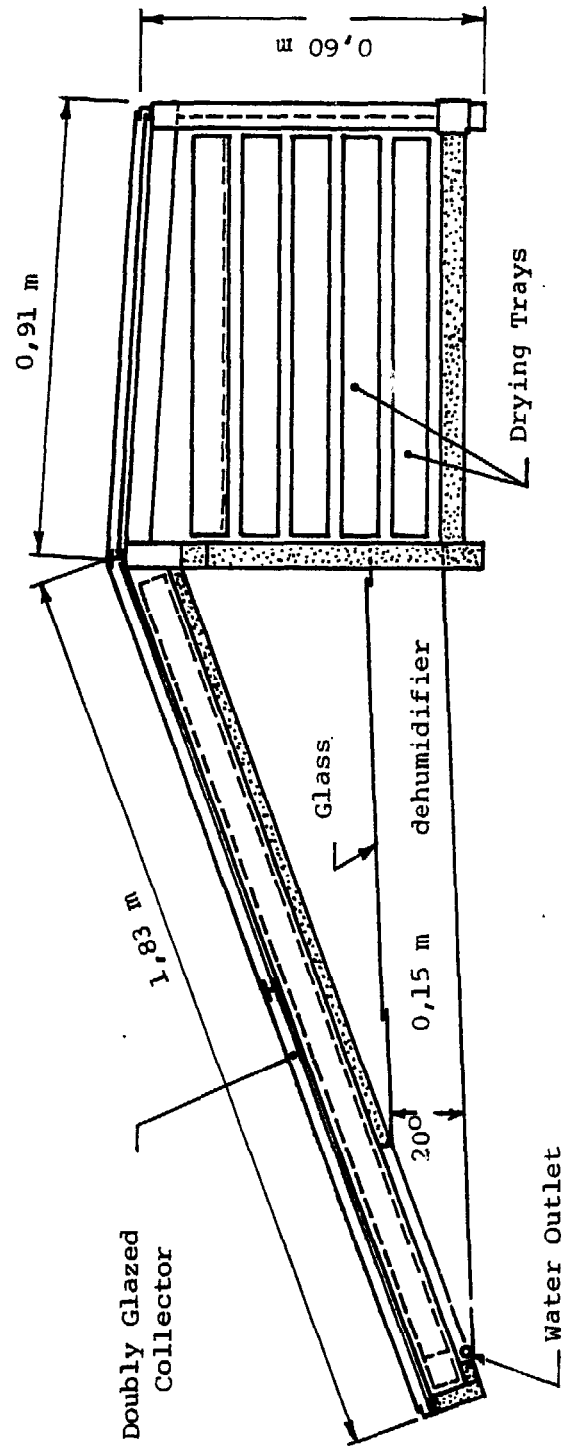


Figure 2. Section View Through Solar Dryer

SOLAR WIND VENTILATED DRYER (Syria)

Overview:

Status: experimental

Heating mode: mixed

Type: chamber dryer

Air circulation: wind powered  
rotary vane  
suction

The main feature of this dryer is its air circulation system. Air is drawn through the dryer by a wind powered rotary vane located on the top of a chimney. Temperature and air flow rate are controlled by a damper.

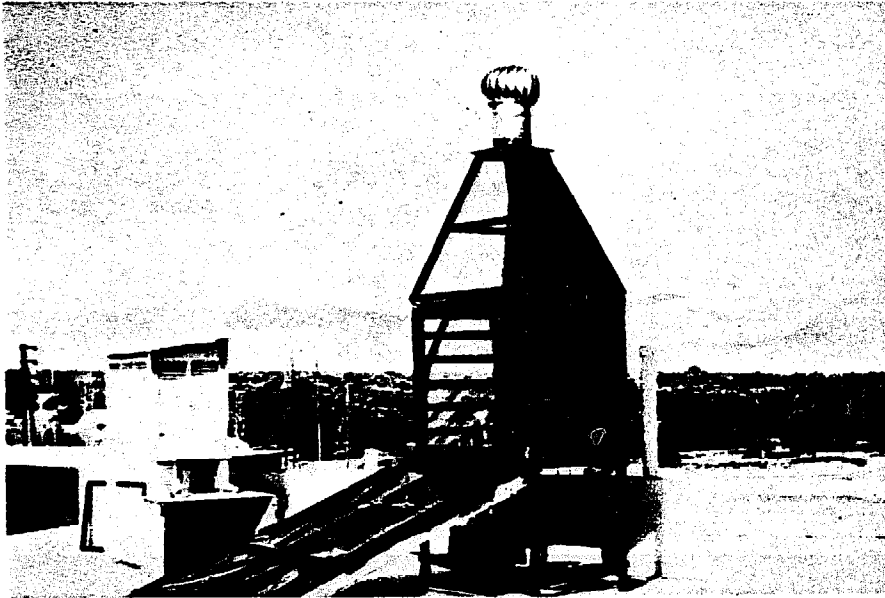


Figure 1. Solar Wind Ventiladed Dryer

### Characteristics:

The dryer can be described as a drying chamber through which warm air, heated in a solar air heater collector, is drawn by means of a rotary wind ventilator.

The solar air heater collector used consists of a blackened hardboard sheet, insulated at the bottom and covered by a plastic (or glass) sheet. The collector is mounted facing due south, and tilted at an optimum angle for the area and particular season.

Air enters through the open bottom end of the collector. It passes up between the hardboard blackened bottom (absorber) and the cover. The effectiveness of the collector is increased by placing a perforated black mesh screen midway between the cover and the absorber: solar radiation which passes through the transparent cover is absorbed by both the mesh and hardboard. The mesh provides additional heat transfer surface area, and increased heat is supplied to the passing air. Collector efficiencies of over 75% have been achieved using this system.

The warm air outlet of the collector is connected to the base of the drying chamber, which holds twelve trays placed in two adjacent six-tier stacks. Hot air circulates up through the drying produce, additional heating is obtained from solar radiation transmitted through transparent sheets which cover the east, south and west sides of the drying cabinet. The rear vertical and bottom horizontal panels of the dryer are of blackened hardboard, which is insulated to reduce heat losses. A rotary wind ventilator is placed on top of a stack above the drying chamber. An adequate length of this stack is required both to achieve a chimney effect and to catch more wind.

The rotary wind ventilator is a moving corrugated vane rotor. As it spins in the wind, it expels air from the ventilator stack. The rotor is mounted on a ball bearing suspension. The friction is low and momentum keeps the head spinning even in sporadic winds. Quantitative tests carried out using the ventilators indicate that the rotary ventilator keeps spinning between gusts yielding a high, constant exhaust in spite of intermittent winds.

A stationary eductor placed on top of a chimney could be also used; however it must be understood that it would rely solely on natural convection during periods of no wind. This dryer was never optimized.

Dimensions: refer to figure 2

## Materials of Construction:

### Drying Chamber:

Transparent cover: Mylar (transparent plastic film)  
Frames: blackened hardboard for the back wall and the bottom panels  
Insulation: straw  
Trays: wire mesh

### Solar Air Heater:

Transparent cover: Mylar  
Absorber: blackened hardboard bottom sheet with a black plastic mesh 2 cm above it  
Insulation: straw  
Frames: blackened hardboard sheets on bottom and side walls

Location: Douma, Syria

Latitude: 33°33'N

Longitude: 36°24'E

## Climatological Data:

The climate of Syria is generally characterized by dry, cloudless summers, and cool, partly rainy winters. There is a substantial variation in monthly mean temperature, falling quite clearly into a four season year. Nevertheless, the spring and fall periods seem to blend partly into the traditional desert summer climate - high daytime temperatures, low relative humidities, clear cloudless days with an absence of precipitation for nearly 6 months. In most of the country the percentage of sunshine during the period of May through October is over 85%. During the period of June through September, the percentage is generally above 95%.

## Practical Operation:

Number of units used in the past: 3 to 4

Number of units currently in use: unknown, experimental work never terminated

### Periods of Operation:

(a) On experimental basis: 1964-1968

Units have also been tested  
in the West Indies

(b) In field operations: nil

## Drying Data:

The unit successfully dried okra, cousa (Baladi variety), squash, jew's mellow, eggplant, tomato paste and yam. As an example of the drying yields attained by the unit, drying times for okra and for cousa were reported to be respectively 20 and 58% shorter than with a sun drying treatment. In addition, the final product quality obtained using this solar dryer was reported to be superior.

The efficiency of the solar air heater was reported to vary between 64% to 88% (ratio of useful heat absorbed into air stream over Energy transmitted through glazing).

Operating Conditions:

- Fairly sunny
- Ambient air temperature from 30°C to 34°C
- Temperature of the heated air entering the drying chamber on day of experiment: from 36,2 to 58,4°C

Economic Details:

Cost of materials:

No detailed itemized costs are available but on a small scale, the dryer cost is approximately \$17.00 U.S. (1963) per square meter of drying surfaces.

Estimated Life of the Dryer:

Frame: 7 to 8 years  
Plastic: should be replaced annually

Comments on the Dryer:

For solar drying purposes, generally the greater the air flow within the drying chamber, the greater the yield will be. If the average wind speed is high, the use of a stationary eductor instead of a rotary ventilator will be just as practicable. In the case where higher temperatures are desired for drying particular crops, dampers installed in the ventilator stack will permit control over the air flow rate and thus the dryer temperature. If the ventilator diameter is small, it seems better to use a stack of a larger cross section which reduces smoothly to the ventilator section. This will reduce air friction and insure an adequate air flow.

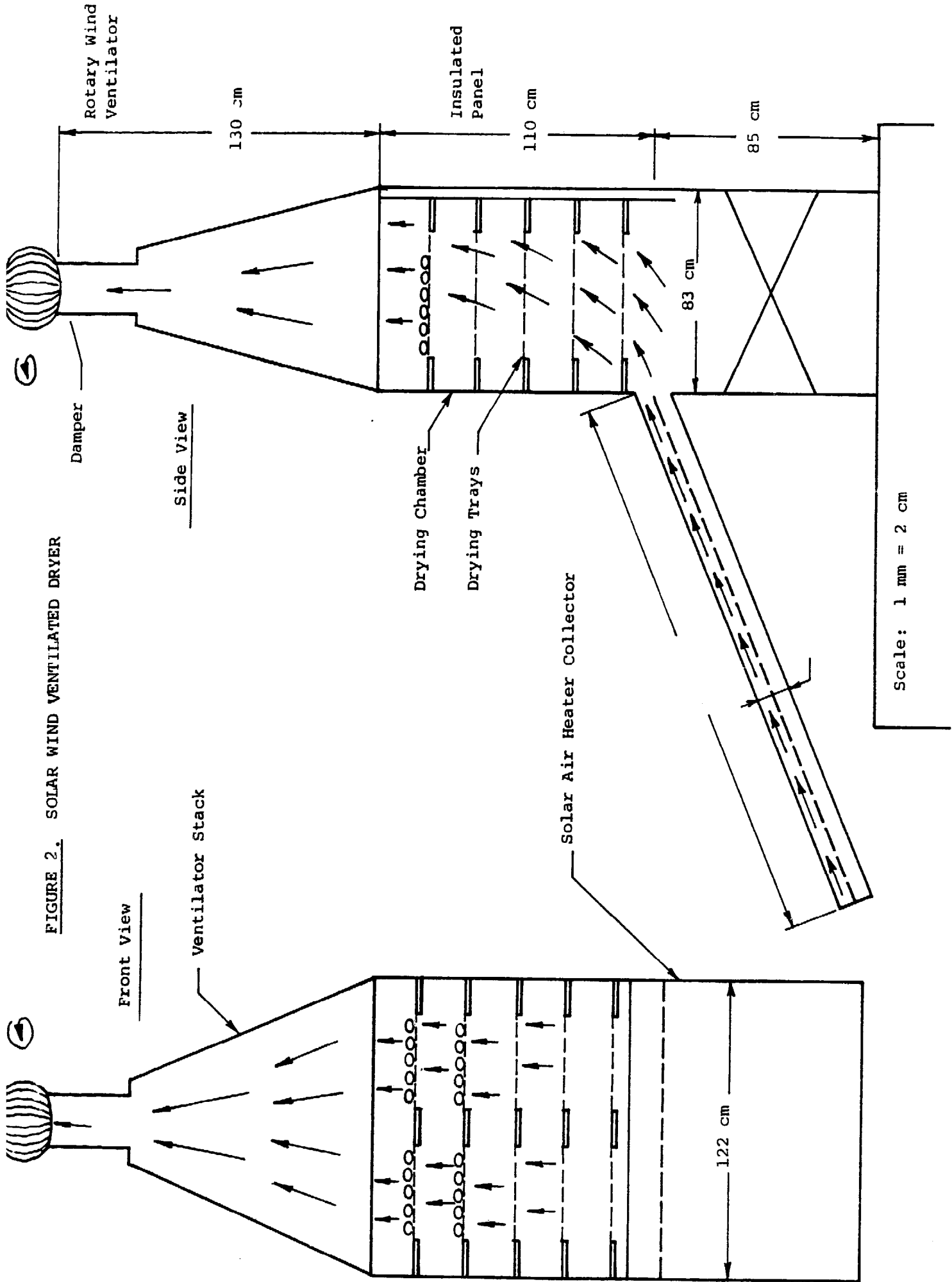
Principal Investigator(s):

Lawand, T.A.  
Brace Research Institute  
Macdonald College of McGill University  
Ste. Anne de Bellevue  
Quebec, Canada

References:

- (1) Nahlawi, M., The Drying of Yams with Solar Energy, Brace Experimental Station, Technical Report No. T-27
- (2) Lawand, T.A., A Description of Two Solar Agricultural Dryers, Coopération Méditerranéenne pour l'énergie solaire, (COMPLES), December 1965, Bulletin No. 9, pp. 51-56

FIGURE 2. SOLAR WIND VENTILATED DRYER





SOLAR HERB AND FLOWER DRYER (UNITED STATES OF AMERICA)

Overview:

Status: operational

Heating mode: indirect

Type: chamber dryer

Air circulation: electric fan forced convection

This solar dryer, shaped as a triangular box, was specifically designed for the drying of herbs and spices which should be dried at a temperature not exceeding 43°C. The dryer is suitable for the requirements of a small community.

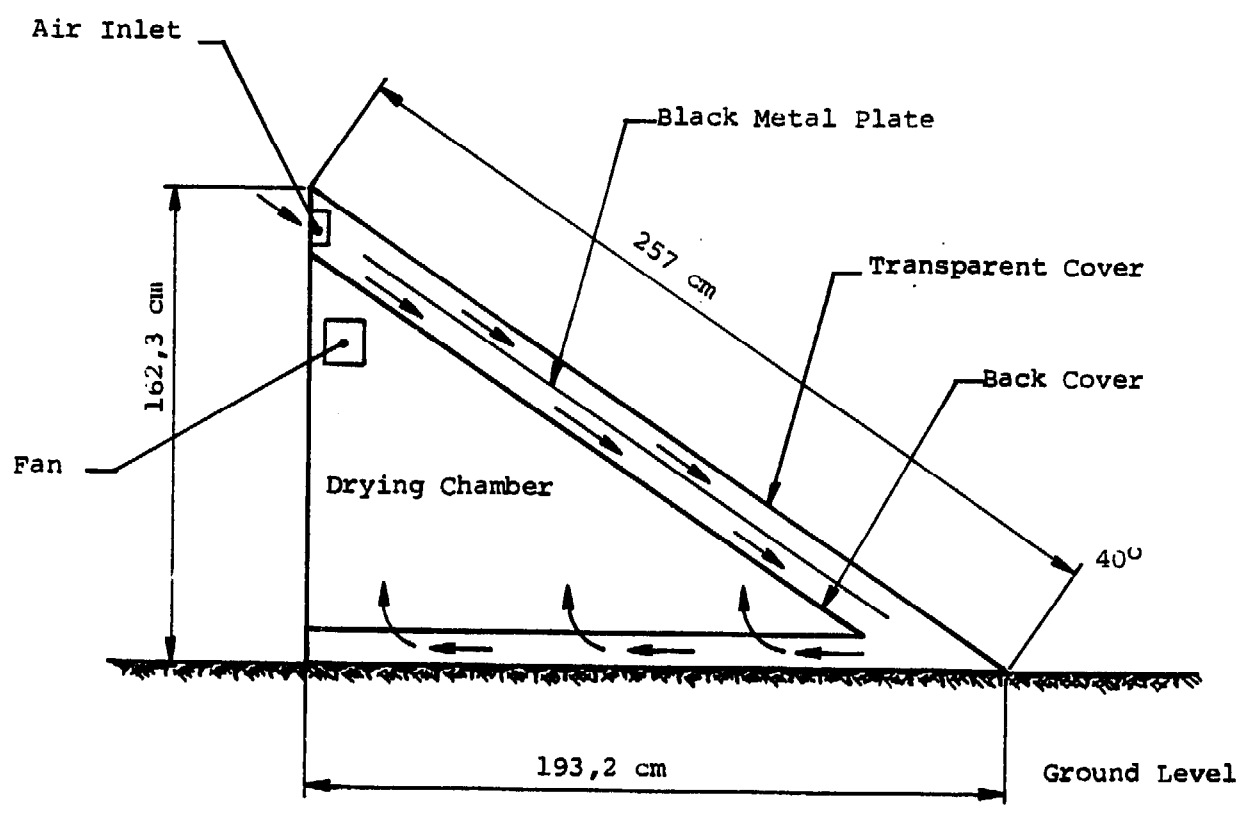


Figure 1. Section View of Dryer

### Characteristics:

The dryer is triangularly shaped and its collector has a 40° slope. Inside the dryer is a set of drying drawers. The total surface area of the drying drawers is 9,29 square meters and there is also 1,5 m<sup>2</sup> (16 sq.ft.) available for the drying of flowers. The drying chamber is not exposed to direct solar radiation, as the solar air heater covers it. The air heater itself consists of a clear plastic cover, a black metal plate absorber and a back cover. A 15 watt fan blows air through the air heater and dryer at a rate of 2,83 cu.m/min. (100 cu.ft/min.).

The air is admitted into the dryer through the upper back part of the collector by means of a fan. The fan blows the air on both sides of the black absorber plate of the solar collector, where it is heated and forced through the perforated bottom floor of the drying chamber. The air then rises through the drying racks on which the herbs are spread and is exhausted at the upper rear section of the drying chamber through openings provided for this purpose.

### Dimensions:

The overall dimensions of the box are: 163 cm high (5'4"), 193 cm long (6'4"), and 122 cm wide (4'0")

Collector: 257 cm long (8'5"), and 122 cm wide (4'0")

Vertical spacing of drying drawers: 4 cm

### Materials of Construction:

#### Drying Chamber:

Frames: wood  
Insulation: none, as the temperature would get too high, destroying the herbs rather than drying them  
Drying drawers: wood frame, 6,35 mm (¼") mesh hardware cloth and vinyl window screen

#### Solar Air Heater:

Transparent cover: polyethylene sheet, 305 x 158 cm (5' x 10') and 0,15 mm (6 mil) thick  
Absorber: corrugated metal plate, 61 x 244 cm (10½" x 3')  
Frames: wood

Location: Santa Barbara, California, U.S.A.

Latitude: 34°25'N  
Longitude: 119°41'W.

### Climatological Data:

Mediterranean type climate; the average incident solar energy on a surface tilted 40° towards the equator is:

March: 5,99 Kwhr/(m<sup>2</sup>-day)

June: 5,52 Kwhr/(m<sup>2</sup>-day)

Sept: 6,30 Kwhr/(m<sup>2</sup>-day)

Dec: 5,36 Kwhr/(m<sup>2</sup>-day)

Practical Operation:

Number of units used in the past: none

Number of units currently in use: one

Periods of Operation:

(a) On experimental basis: October 1973 to present

(b) In field operations: --

Drying Data:

<u>Material</u>	<u>Drying Time (days)</u>
Basil	12
Rosemary	10
Orange bergamot mint	7
Lemon balm	8
Purple basil	6
Parsley	14
Green onion tops	2
Lavender	21

The tests reported in this study were undertaken during the winter season in California which is fairly mild, but has occasional rains lasting for a few days. The drying time is reduced by 50 to 75% in summer.

Operating Conditions:

This dryer has a thermostat fitted at the back of the solar absorber that automatically turns the fan on when the sun heats the plate.

The maximum interior operating air temperature should not exceed 43°C.

Economic Details:

Cost of Materials:	Lumber	\$70,39 U.S.
	Hardware	66,10
	Electrical	32,00
	Sealing	<u>27,30</u>
	TOTAL COST	\$195,79 U.S. (1974)

Annual Operating Expenditure:

Electrical operating cost (8 hr/day)	\$0,88 U.S.
Transparent cover replacement	1,00
Exterior painting cost	<u>6,00</u>
TOTAL	\$7,88 U.S./year

Estimated Life of the Dryer:

If the dryer is given an occasional exterior treatment of wood preservative and the polyethylene cover is changed once or twice a year, the dryer should last for more than 10 years.

Comments on the Dryer:

The dryer needs a source of electricity.

The dryer was designed to provide an adequate supply of herbs for a few families.

Principal Investigator(s): Thomas, Irving  
Zilles, Marsha

Community Environmental Council  
El Mirasol Educational Urban Farm  
15 W. Anapamu Street  
Santa Barbara, California 93101  
U.S.A.

References:

- (1) How to Build a Solar Herb Dryer, Thomas, I.E., Zilles, M., Available at the above address at \$1.50 - 10 pp.

BATCH SHALLOW BED COFFEE DRYING BINS (Puerto Rico)

Overview:

Status: operational

Heating mode: Indirect

Type: chamber dryer

Air circulation: electric fan forced convection

This drying system has been used regularly since 1962 during the coffee harvesting season. The pre-dried product is placed in a shallow drying bin located inside a building. The roof of the building is designed to collect heat for use in the drying process. Some recommendations are made about this type of drying system.

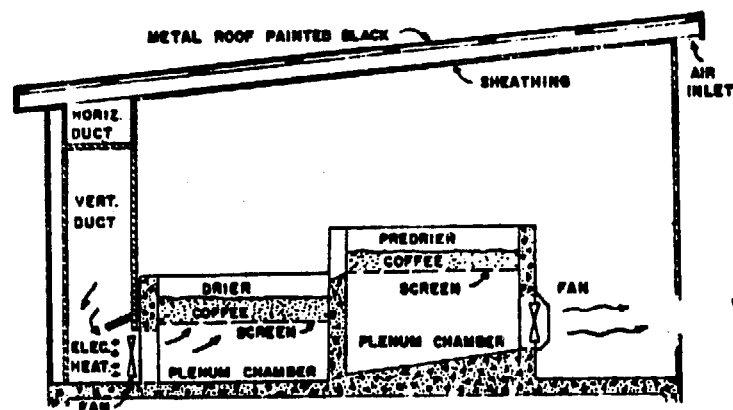
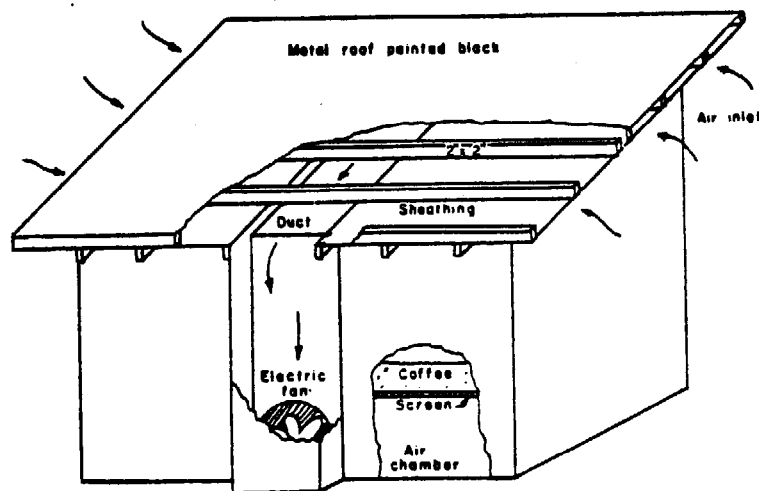


Figure 1. A Diagram Showing How the Roof of a Coffee-Processing Building can be Used as a Solar Heat Collector as well as a Section View Through the Drying Bins Located in the Building.

### Characteristics:

The roof of the coffee processing building is tilted 6,3° towards the south and acts as a solar collector. The building houses all the equipment needed for processing the coffee from the coffee cherry pulping to the storage of the processed coffee. The drying of the coffee beans is carried out in two bins: the pre-drying bin and the drying bin. Each bin can hold a layer of coffee beans 30 cm thick. Their walls are made of concrete blocks. The bottom of the bins are made of wire mesh supported by expanded metal on steel rods. The pre-drying bin is equipped with an 18 inch axial flow fan operated by a 1½ HP electric motor. The fan is located beneath the floor of the bin and pulls the air downwards through the coffee bed. The drying bin is provided with four electric heating elements, each rated 1 300 watts for supplemental heating and an 46 cm axial fan operated by a .40 Kw electrical motor.

The solar collector utilizes the whole area of the roof. Plywood ceiling sheeting is fastened on top of 5 cm x 15 cm rafters. Horizontal 5 cm x 5 cm purlins are placed on top of the plywood and galvanized iron sheets roofing nailed onto them. The outside surface of the roof is coated with black asphalt roof paint to enhance absorption of solar radiation. Openings at opposite ends of the roof provide inlets for the ambient air. The heated air is used in the drying bin only. The air is circulated by a fan in the drying bin. This fan draws the air heated by the collector through a duct running down in the center of both the sloping roof and vertical south wall, and pushes it from beneath the drying bin, upwards through the parchment coffee bed. The optimal drying temperature for the coffee beans is 120°F (49°C) and heating elements are used for reaching this temperature in case of unfavourable weather.

Dimension: The overall dimensions of the coffee processing building are: 6,1 m x 9,1 m of floor area, the south facing wall is 4 m high and the north 4,9 m.

The pre-drying bin and the drying bin each measure 1,7 m x 1,7 m of surface area.

### Materials of Construction:

#### Drying Chamber

- Transparent cover: none used
- Frames: the side walls of the bins were made of concrete blocks
- Insulation: the bins are located inside the processing building
- Racks: wire mesh supported by expanded metal on steel rods

#### Solar Air Heater:

- Transparent cover: none used, but a nylon plastic film was tested separately as a surface for a solar heat collector
- Absorber: galvanized iron sheet painted with black asphalt roof paint
- Insulation: none used except the plywood ceiling sheeting
- Frames: lumber

Forced convection (by means of two fans) provides the driving force during drying.

through the layer of parchment coffee and pushes it out of the building. This downward movement of the air supplements the force of gravity and helps to remove the superficial water from the parchment coffee which becomes skin dry within 2 to 3 hours. The parchment coffee is then transferred to the drying bin where the air - heated by the roof collector - is blown by the dryer/fan upwards through the layer of parchment coffee. The drying is continued in the dryer bin until the product is at the required moisture content.

#### Economic Details:

##### Cost of Materials:

Equipment	\$1 356
Materials	965
Labour	<u>500</u>

Total Cost \$2 821 (based on 1962 local prices)

The additional cost for incorporating the solar heat collector to the coffee drying facilities is estimated to be about \$100.00.

##### Annual Operating Expenditure:

Additional cost for operating the roof solar heat collector is practically negligible.

##### Cost of Drying Related to a Unit of Material Dried:

Electric energy consumption for all processing operations was approximately 12,5 Kw hour per 45 Kgs of dried coffee produced during the 1963 season when the test data was recorded. Compared to the energy requirements of other installations, the use of solar energy provides a reduction of as much as 66 percent in electricity costs.

Estimated Life of the Dryer: 15 years

##### Comments on the Dryer:

No particular problems were encountered during the construction and operation of the dryer.

After having tested the coffee drying facilities, one can draw some conclusions about coffee drying using this type of dryer.

- . A general guide for small and medium farms is to have approximately one square meter of drying area for each 5 000 Kgs of coffee produced yearly.
- . The fans should be able to deliver at least 15 cubic meters per minute per square meter of dryer area against a water gage pressure of 2,5 cm.
- . The drying bin should contain a layer of coffee beans 30 cm thick when operating full capacity.
- . The drying air temperature should not exceed 49°C.
- . With careful management, much of the coffee can be dried without using supplemental heat.

The additional cost of installing the solar collector was recovered by reductions in operating cost of installing the solar collector was recovered by reductions in operating cost in one season of operation.

- . The results of this project indicate, nonetheless, that it is not practicable to depend entirely on solar energy for heating the drying air.
- . Electric heating elements which provide up to 1 100 watts for each 1 000 Kgs processed yearly are recommended during periods with little sunshine as well as during the night time when necessary.

Location: Barrio Anones  
Las Marias, Puerto Rico  
Latitude: 18°16'N  
Longitude: 67°W (Mayaguez)  
Altitude: 244 m above sea level

Climatological Data:

The data presented here was collected during the testing period of September to November 1962 at the location of the dryer. This location has high rainfall and much cloud cover during this time of the year. A daily pattern of temperature and solar energy, typical for the periods of observation, shows clear sky from sunrise until about 11:00 where clouds begin to form. Rain usually occurs between 12:00 and 14:00, followed by gradual clearing and afternoons with partly cloudy skies.

The average solar energy received daily per square foot of horizontal surface was calculated for three observation periods during the tests:

September 13 to September 30, 1962: 6,12 Kwhr/(m<sup>2</sup>.day)  
October 1962: 5,87 Kwhr/m<sup>2</sup>.day  
November 1962: 5,41 Kwhr/m<sup>2</sup>.day

Practical Operation:

Number of units used in the past: only one  
Number of units currently in use: only one

Periods of Operation:

- (a) On experimental basis: September 1962 to November 1962
- (b) In field operations: September 1962 to date

The dryer has been field tested throughout the 1962 and 1963 harvest seasons and has been in operation every harvest season since that time.

Drying Data:

Parchment coffee beans were dried. Before being dried, the coffee cherries are first pulped and the pulp discarded to the compost pit. The coffee beans are then put in the fermentation tank for 10 to 12 hours, washed and transferred to the pre-dryer where the superficial water of the product is removed. When the skin is dry (2-3 hours in the pre-drying bin), the beans are transferred into the drying bin where it will reach its final dry state in 24 hours or more depending on the weather conditions. It has been shown that a layer of coffee 30 cm deep can be effectively dried from 55 to 12 percent moisture content (wet basis) within 24 hours, using air temperatures not exceeding 120°F and air flow rates of at least 50 cubic feet per minute per square feet of bin area. The yield was approximately 245 to 360 Kgs of processed coffee per batch. During the 1962 operation, the electric energy consumption amounted to approximately 1,45 Kw-hour for each Kg of dried coffee. This figure compares advantageously with the electric energy consumption of 0,82 Kw-hr/Kg of dried coffee that was spent when solar energy was not used.

Operating Conditions:

The washed parchment coffee is pumped into the pre-dryer and the wash water is drained down through the layer of parchment coffee and collected in a pipe which runs it back to the washing tank. The pre-dryer fan draws unheated air



- . However, another way to obtain higher temperatures is to construct the solar heat collector by placing a glass sheet or transparent cover film about two inches above the absorber plate, using the space between for an air passage. A collector of this type would provide a temperature increase of 50%, over the collector described previously.

Principal Investigator(s):

Phillips, A.L.  
Rodriguez-Arias, J.H.  
Justiniano, Domingo

Agricultural Engineering Department  
College Station  
University of Puerto Rico  
Mayaguez, Puerto Rico 00708

References:

- (1) Phillips, A.L., A Solar Energy Method for Reducing Coffee Drying Costs, The Journal of Agriculture of the University of Puerto Rico, Volume XIVII, No. 4, October 1963, pp. 226-235
- (2) Phillips, A.L., Drying Coffee with Solar Heated Air, Solar Energy Volume IX, No. 4, October, December 1965, pp. 213-216
- (3) Phillips, A.L., Further Observations on the Use of Solar Energy for Reducing Coffee Drying Costs, Journal of Agriculture of the University of Puerto Rico, Volume XLIX, April 1965, No. 2, p. 272
- (4) Phillips, A.L., Research Note: Evaluation of a "Mylar" Plastic Film as a Surface for a Solar Heat Collector: Journal of Agriculture of the University of Puerto Rico, Volume XLIX, October 1965, No. 4, pp. 484-486

SOLAR SUPPLEMENTAL HEAT DRYING BIN (UNITED STATES OF AMERICA)

Overview:

Status: experimental

Heating mode: indirect

Type: chamber-bin dryer

Air circulation: fan-forced

The two designs presented here show the possible transformation of a conventional bin dryer to an indirect solar bin dryer using the original structure of the drying bin. Considerable savings in fuel consumption can be made if this low cost heating portion is added to the bin.

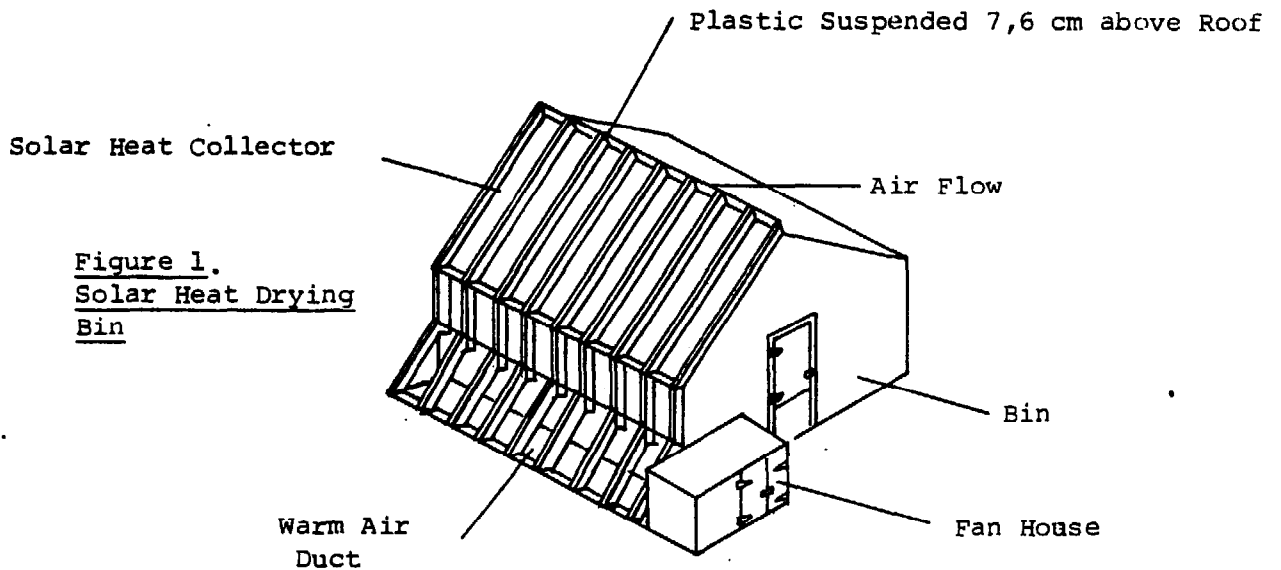


Figure 1.  
Solar Heat Drying Bin

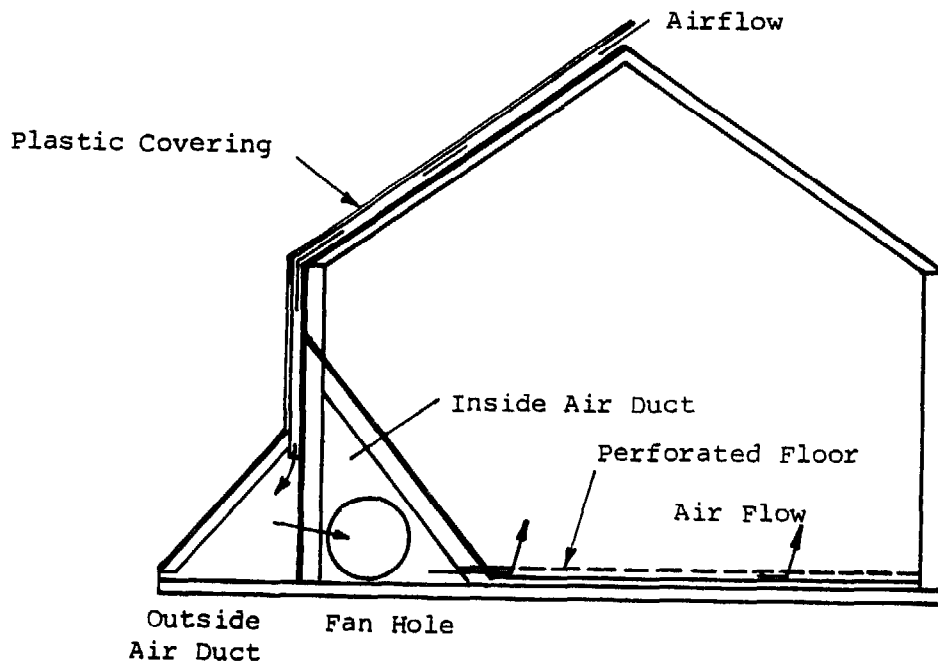


Figure 2. Cross Section of Dryer

### Characteristics:

This drying bin is aligned longitudinally on an east-west axis, the south facing side on the roof being used as the solar heat collector. This roof collector is sloped about 30° from the horizontal and is designed to produce an optimal temperature rise of 5 to 12°C over the outside air. The bin structure provides about one square meter of collector area for each two cubic meters of grain. The author has found that this ratio provides an acceptable drying rate for shelled maize. The roof surface is painted black to absorb the solar energy. A transparent plastic film is supported about 8 cm above the roof by stretching it over the framing members set edgewise. The air, drawn by a fan, enters the opening along the roof peak and moves through the collector roof down the south wall into the outside air duct. From there, the fan pushes the warmed air into the inside air duct and through the grain by way of a perforated floor. The bin is designed to dry half its depth of shelled maize at one time (1,22 meters). The fan should be able to deliver about 2 cubic meters of air per minute for each cubic meter of corn to be dried, assuming the bin is full.

Dimensions: The overall dimensions of the dryer are 4,88 meters wide (16 feet), 2,45 meters high (8 feet) at the top of the walls and can be as long as 18,3 meters (60 feet). See figure 1 & 2.

### Materials of Construction:

#### Drying Chamber:

Transparent cover: none  
Frames: wood  
Insulation: wood roof sheathing is considered sufficient  
Trays: perforated bottom (metal plate or wire mesh)

#### Solar Air Heater:

Transparent cover: one sheet of plastic film 0.15mm thick  
Absorber: plywood painted dull black  
Insulation: none  
Frames: 5 cm x 10 cm wood

Location: Campus of South Dakota University  
Brookings, South Dakota, U.S.A.

Latitude: 44°19'N  
Longitude: 96°47'W

### Climatological Data:

The climatological data presented hereafter is for Sioux Falls, South Dakota.\*

Latitude: 44°34'N  
Longitude: 96°42'W

\* This data was extracted from Climatological Data, National Summary, Annual, 1970, Volume 21, No. 13, Asheville, North Carolina 1971, p. 48

	<u>January</u>	<u>July</u>	<u>Annual</u>
% of possible sunshine	--	--	60%
Rainfall	--	--	6,39 m
Relative humidity (at 13:00)	67%	54%	--
Wind speed (Km/hr)	8	7	--
Daily max. temperature (°C)	-3,8°C	30,0	--
Daily min. temperature (°C)	-14,9°C	16,9	--

Practical Operation:

Number of units used in the past: two prototypes with different modes of control

Number of units currently in use: none known

Periods of Operation:

(a) On experimental basis: October to November 1963 (prototype)

(b) In field operations: no experience

Drying Data:

The product to be dried was shelled corn at 25% moisture content wet basis. The bin described here can hold 12 cubic meters of grain per meter of length. However, the experiments reported in this case study were made using a scale prototype design and only 1,4 cubic meters of grain were dried. The product was dried in two layers after 44 days to 14% M.C.

Operating Conditions:

Average temperature: 4°C (6° below normal)

Percent of possible sunshine: 63% normal

In drying maize, the author advises that the fan run continuously day and night until the top grain is down to 20% moisture or less. This will ensure that the top level does not spoil before the lower layers can be dried. After that, the fan can be shut off during rainy periods, and opened the rest of the time. Operating the fan only when the sun is shining would result in slower drying of the top layers and over drying of the bottom layer.

Economic Details:

The author states that the addition of the solar portion to a drying bin of that type should not cost over \$200.00

Annual Operating Expenditure:

The main expense is the replacement of the plastic sheet if plastic is used. The scale prototype used 46 Kwh of electricity per cubic meter of dried corn.

Cost of Drying Related to a Unit of Material Dried:

Energy costs in the U.S. Midwest are approximately \$0.70 per cubic meter of grain.

Estimated Life of the Dryer:

20 to 30 years for the bin and the fan. One season for polyethylene if it is used. Some Tedlar-coated fiberglass reinforced plastics are guaranteed for 25 years.

### Comments on the Dryer:

- . This plywood bin costs more than a round steel silo.
  - . Being a new type of larger dryer, it requires demonstration to prove workability.
  - . With the new low temperature drying technique\*, the bin could probably be loaded entirely in one day with 25% moisture content shelled corn.
- \* The low temperature drying process is based on the use of natural air during October and November in the northern climates. Only a small amount of heat (30C air temperature rise) is added to the air to allow control of the humidity, and to lower slowly the moisture content of the grain to a moisture content where it can be safely stored. The process is slow because of the limited capacity of low temperature air to absorb moisture. The key to successful low temperature grain drying is to provide sufficient air to advance the drying front through the grain before any damaging deterioration takes place. If corn was dried during the warmer temperatures of early harvest, it would be necessary to dry it in one week to prevent deterioration. This would require an air flow 6 to 8 times greater than if this corn was dried during the colder temperatures of late fall.

### Principal Investigator(s):

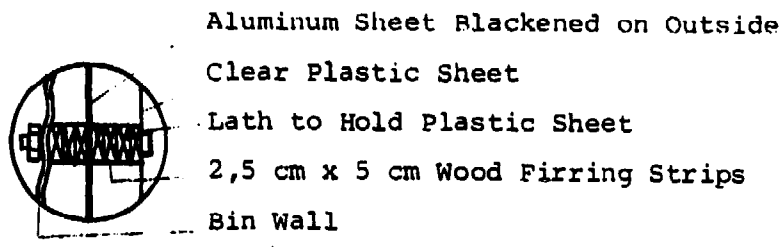
Peterson, W.H.

South Dakota State University  
Dept. of Agricultural Engineering  
Brookings, South Dakota 57006  
U.S.A.

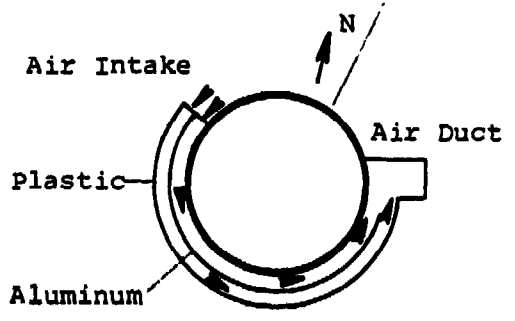
Note: The author also sent information about a "solar-electric" crop dryer (Arlington, South Dakota). The unit is a 5,5 m diameter (18 feet) round steel bin of 110 m<sup>3</sup> capacity. The solar collector is about 4,25 meters (14 feet) high and about 10 meters (32 feet) long, occupying two thirds of the bin's circumference. To construct the solar collector, furring strips of 2,5 x 5 cm lumber were attached horizontally to the bin with 61 cm spacings from top to bottom. The first furring strip was bolted to the bin; the others were nailed one onto the preceding one. The absorber was made of used aluminum press plates, stapled to the strips and painted flat black. Then, another three layers of furring strips were nailed over the plates and a 6 mil. clear polyethylene sheet was stretched over this collector surface. See Figure 3.  
TOTAL collector cost: \$250.00

The air pulled by a 5,6 Kw, 61 cm axial flow fan is routed between the bin wall and clear plastic, on both sides of the aluminum sheet at an air flow velocity of 28,3 cubic meters per minute. This air was collected in an air funnel from where the same fan pushed it through the plenum chamber under the bin and up through a perforated floor and the shelled corn.

This bin was supplemented with electric heaters for the night time. When the moisture content of the corn reached 20%, the drying proceeded for 30 more days with the use of solar heat only (with the fan), down to 14% moisture content for 110 m<sup>3</sup> of corn. This method makes use of the low temperature drying process. The electrical energy consumed in the test, which occurred in 1973 (October 23 to November 17), was approximately 48 Kwh per cubic meter of shelled corn. During the tests the heat collected by the solar air heater on a sunny day was estimated to be equivalent to 175 Kwh of electricity (i.e. 50% saving on the overall process) During the drying period, outdoor temperatures averaged 50C and relative humidity 71%.



Solar Heater Cross Section



Top Cross Section Showing Airflow

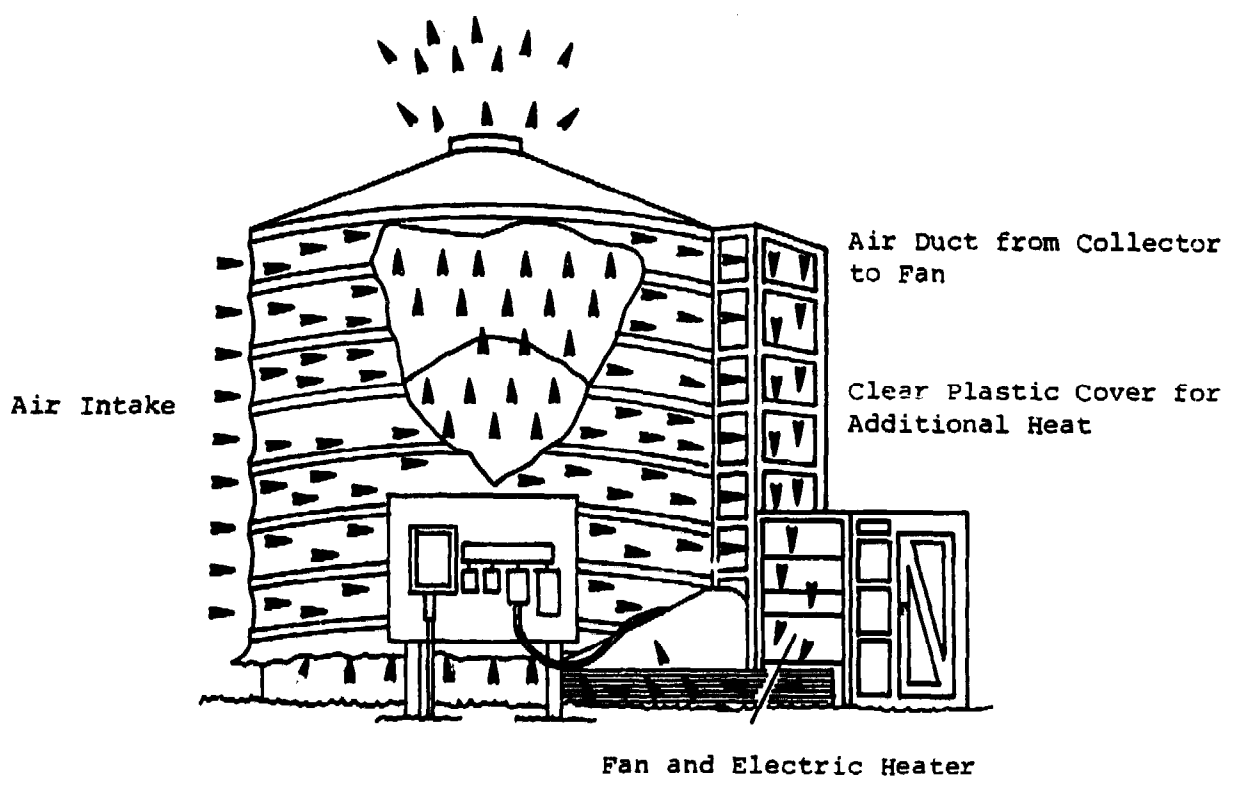


Figure 3. Solar Crop Drying Showing Basic Construction

References:

- (1) Peterson, W.H., Harness the Sun to Dry Grain, World Farming, June 1968, pp. 36-37
- (2) Peterson, W.H., Solar Heat for Drying Shelled Corn, American Society of Agricultural Engineers (ASAE) Paper No. 73-302, 1973
- (3) Heyom, Gene, Solar Electric Crop Drying, East River Guardian, November 1973, pp. 8-9
- (4) Green, Larry, Solar Heat for Drying Shelled Corn, Electricity on the Farm, Volume 47, No. 4, April 1974, pp. 14-15
- (5) Shove, Gene, Low Temperature Drying of Shelled Corn, Electricity on the Farm, Volume 47, No. 4, April 1974, pp. 16-17

LARGE SCALE SOLAR AGRICULTURAL DRYER (Barbados)Overview:

Status: experimental  
(partly dismantled since 1969)

Heating mode: Indirect

Type: chamber dryer

Air Circulation: electric  
fan-forced  
ventilation

This large scale agricultural dryer was designed to provide livestock with locally produced feed. It was intended to be used primarily for the production of dried corn. The operation was done in two steps: initially, the product was partly dried in a mobile drying cart and then transferred to a room where drying was completed to the required moisture content.

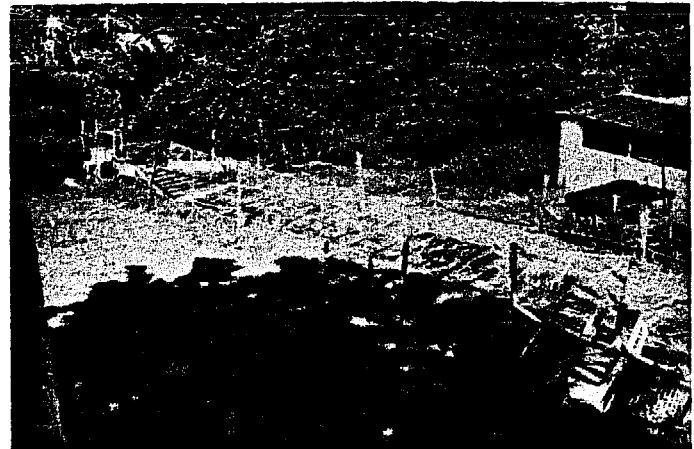


Figure 1. Storage Bin Roof Solar Air Heater  
and Field Air Collector.

Characteristics:

Essentially the dryer was designed to operate in two stages - handling 0,9 m<sup>3</sup> (770Kg) of freshly shelled corn per day. The first part consists of a mobile solar air heated drying cart which should reduce the moisture content of the freshly harvested corn from 30% to 18% in the first day of operation. The corn is then transferred to an 18 cubic meter capacity solar air heated storage bin, where the moisture content is gradually reduced to the equilibrium moisture content of 13%. Particular attention was paid to the air flow design so as to cause minimum pressure drop through all parts of the air heaters and drying chambers.



A centrifugal fan blows air through a diffuser duct into the 29 meters long solar field air heated collector. The collector is fabricated from three plastic sheets, the top transparent, the centre a black mesh with 50% openings, and the bottom a layer of insulation, sandwiched between two films, the upperside coloured black and the lower side aluminum. The sheets are sealed along the long edges, and supported by tension straps every meter. The centre mesh rests on a rigid screen which is stretched between posts in the field. The collector is inflated on both sides of the tensioned layer and heats the air blown longitudinally through it. The end of the collector is connected to the mobile drying cart. The latter is insulated to reduce heat losses, and fitted with air flow dividers supporting a perforated drying floor. The fresh corn is loaded into the cart, which is covered by a sloping double-layered plastic roof.

When the moisture content has been reduced to the required level, the corn is fed into a blower and transferred to the storage bin dryer, where its moisture is gradually reduced to 13%. This dryer was part of a farm building, one of the rooms being converted into a drying chamber, with a plenum chamber and perforated drying floor. The roof has been used as the solar air heater collector.

Dimensions: See figures Nos. 2 and 3.

Materials of Construction:

The plastic sheets, the fans and the insulation were imported.

Location: Bullens Agricultural Station  
St. James, Barbados, West Indies  
Latitude: 13,2<sup>0</sup>N  
Longitude: 59,3<sup>0</sup>W

Climatological Data:

335 days per year with more than 4 sunshine hours per day

312 days per year with more than 6 sunshine hours per day

This data was obtained from a nearby meteorological station and summarizes analyses of records for the years of 1961 to 1965.

Practical Operation:

Number of units used in the past: one

Number of units currently in use: only the roof collector of the storage bin is used occasionally.

Periods of Operation:

(a) On experimental basis: October 1966 to November 1969

(b) In field operations: idem

Drying Data:

Ear corn was the main product dried. For the field drying cart, one test reported that the moisture content of 72 Kg of freshly harvested corn was reduced from 24,5% to 14% in 17 hours of drying. Other tests were carried out drying sweet potatoes, copra and grasses. The products were dried in their natural state.

Operating Conditions of the Drying System:

First step:

Solar Field Air Heater Collector	50,4 m <sup>2</sup>
Air Flow Rate in Collector	$0,434 \frac{\text{m}^3}{\text{min.}}$ m <sup>2</sup> of collector
Effective Air Flow Rate in Mobile Cart Dryer (at full load)	$23,4 \frac{\text{m}^3}{\text{min.}}$ m <sup>3</sup> of product
Average Velocity through Mobile Dryer	6,7 m/min.
Maximum Solar Air Heater Exit Temperature During Fair Days at this Flow Rate	65°C - 71°C
Average Solar Field Air Heater Efficiency	35 to 40%

Second step:

Storage Bin Roof Solar Air Heater	23,2 m <sup>2</sup>
Air Flow Rate in Collector	$3,10 \frac{\text{m}^3}{\text{min.}}$ m <sup>2</sup> of collector
Effective Air Flow Rate in Storage Bin Drying Chamber (at full load)	$3,9 \frac{\text{m}^3}{\text{min.}}$ m <sup>3</sup> of product
Average Velocity through Bin Dryer	7,6 m/min.
Maximum Solar Air Heater Exit Temperature During Fair Days at this Flow Rate	40°C - 43°C
Average Roof Solar Air Heater Efficiency	70%

Economic Details:

Cost of materials:

<u>ITEM</u>	<u>Fixed charges</u>	<u>COST U.S. \$</u>
Mobile cart fan discharge diffuser duct		46,60
Mobile drying cart		215,00
Storage bin diffuser duct		40,80
Storage bin dryer		90,80
Storage bin air exhauster		20,30
Storage bin fan		295,00
Field Collector Fan		146,00
Electrical Installation		<u>116,00</u>
	TOTAL Material Costs:	970,50
Fabrication Labour Costs:		<u>590,00</u>
	TOTAL Fixed Charges	<u>\$1560,50</u> U.S.

Variable Charges  
(for the production of heat)

Field solar air heater	414,00	(\$1,24/ft <sup>2</sup> )
Storage bin solar air heater	145,00	(\$0,89/ft <sup>2</sup> )
Connection ducts to fan	<u>31,20</u>	
	TOTAL Material Costs:	590,20
Fabrication labour costs:	<u>294,00</u>	
	TOTAL Variable Charges	<u>\$884,20</u>
TOTAL System Installed Cost:		\$2343,70
\$1.00 U.S. = 1,70 SE.C. (Eastern Caribbean)		2444,70

**Annual Operating Expenditure:**

It is estimated to be approximately \$2,300 U.S. per year including depreciation on fixed and variable charges, electricity costs, maintenance and labour charges (50%).

**Cost of Drying Related to a Unit of Material Dried:**

The maximum dehydration cost is of \$2.60 U.S. per 100 Kgs.

Estimated Life of the Dryer: 10 years

Comments on the Dryer:

- . The dryer was partly used by the local coconut products factory for the dehydration of copra.
- . The dryer should be run on an annual basis to lower operating costs.
- . The drying rate in the mobile cart could be improved by some form of air recirculation. The velocity of the drying air over the product could then be increased, contributing to faster drying.

Principal Investigator(s): Lawand, T.A.

Brace Research Institute  
Macdonald College of McGill University  
Ste. Anne de Bellevue  
Québec, Canada HOA 1C0

Note: The solar field collector was dismantled (1970) but the bin storage heat collector was still in operation several years later. The materials used for the flexible solar air heater collector in the field did not withstand the intense solar radiation levels of the tropics. This was later replaced by a glass covered collector which lasted several years.

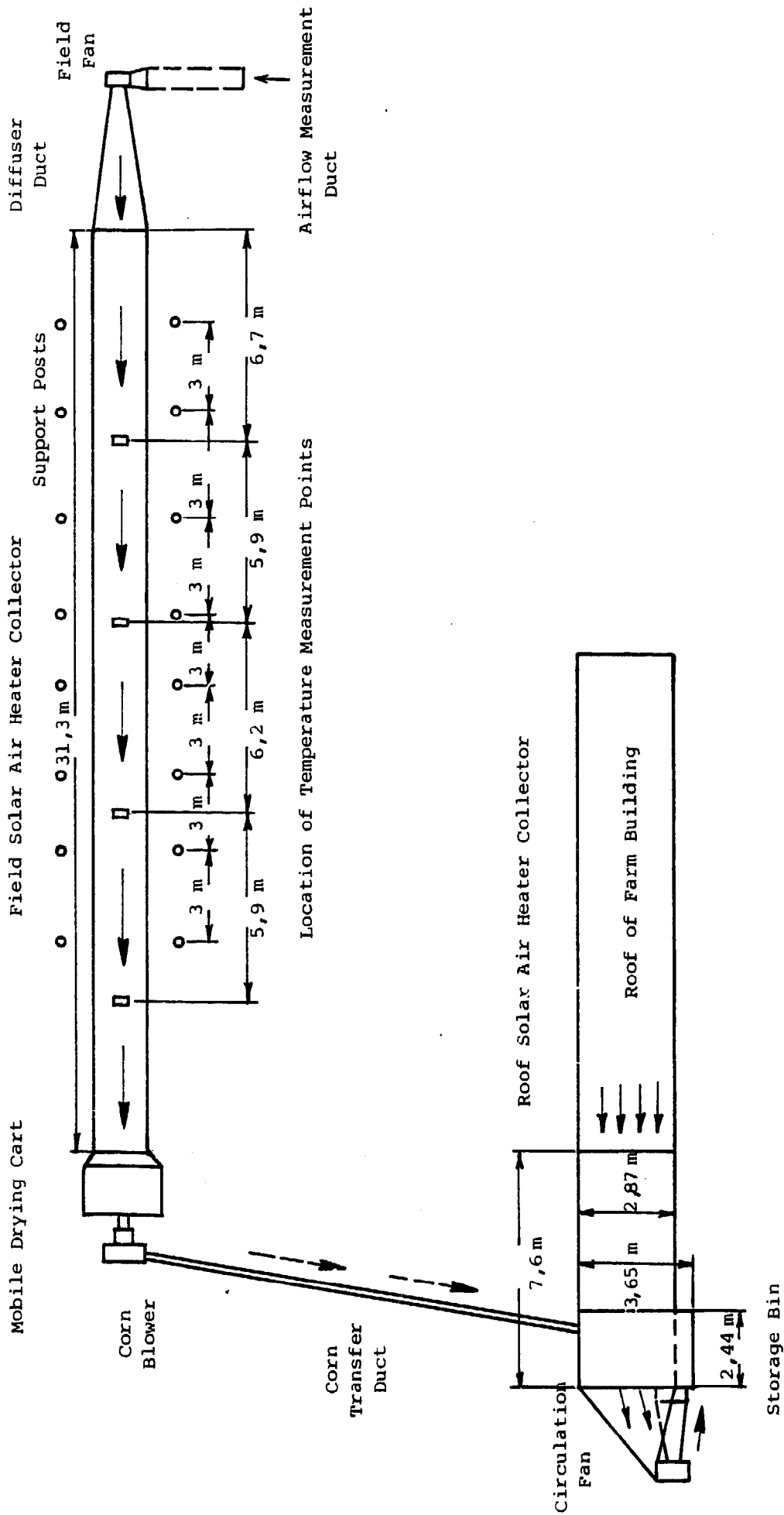


Figure 2. Overall Plan View of Drying System

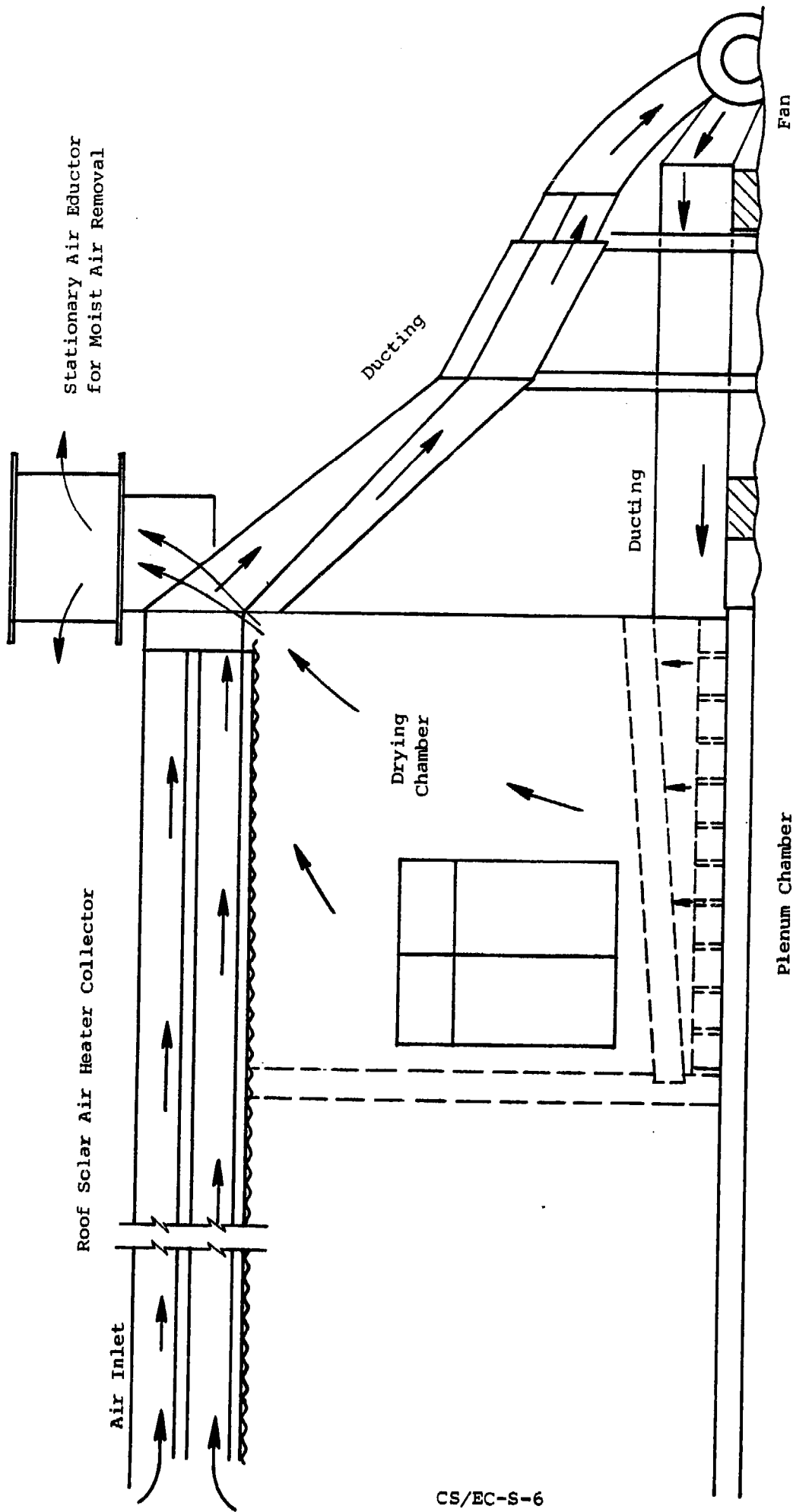


Figure 3. Section View of Storage Bin Dryer and Air Heater Collector

SOLAR TIMBER SEASONING KILN (India)Overview:

Status: operational

Heating mode: hybrid

Type: chamber dryer

Air circulation: electric fan  
forced convection

This solar lumber dryer was designed to increase the drying rate of timber as compared to the traditional air drying method. This particular design makes use of large quantities of low temperature heat (up to 60°C) and permits a rapid drying rate without undue degradation of the timber (cracks, warps).

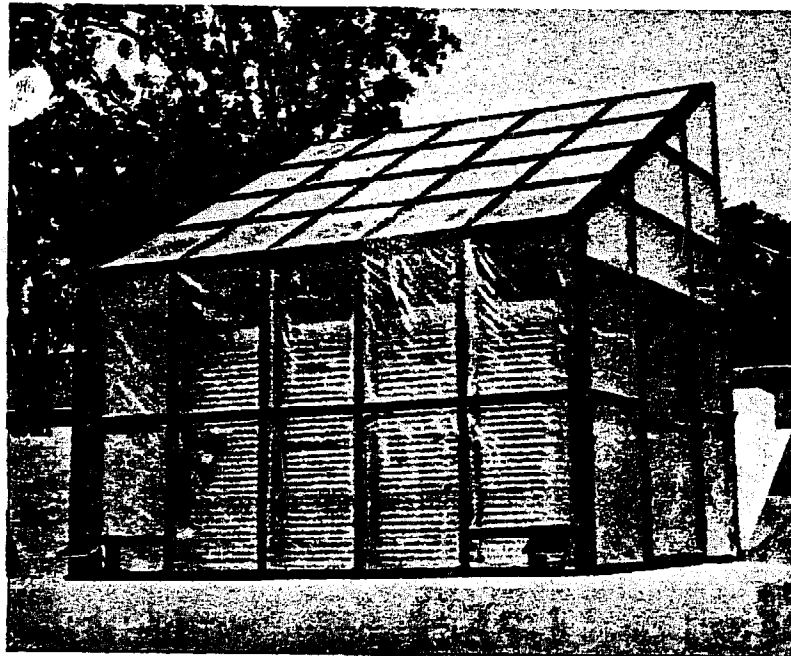


Figure 1. Solar Kiln, Recirculating System with Partial Air Venting. Sheet Reflectors Partially Visible on the East and West Sides.

Characteristics:

The wood frame structure of the kiln is oriented lengthwise on an east-west axis, the higher wall facing north. Except for the north wall, the whole structure is covered with a double layer of transparent polyethylene sheeting separated by an air gap. The north wall is made of plywood sheeting. The roof is tilted towards south at an angle of 0,9 times the latitude above horizontal (27°). The drying space in the kiln can take about 3,5 cubic meters of 25 mm thick planking (each time). Inside the kiln, a horizontal false ceiling covering the entire length of the kiln is installed above the wood stacks. Another false north wall, covering the entire length of the kiln extends from the floor to the false ceiling and is provided with a hole in its center for housing the fan. The built-in interior surfaces within the kiln (the surfaces of wooden roof studs and pillars, the false ceiling and north wall partition, the north wall, the baffles and the concrete floor)

are painted black for a maximum collection of heat. The fan is driven by a 0,75 Kw reversible electric motor and is used for forced air circulation. The use of plywood baffles and movable partitions allows the dryer to be used either as a single-pass flow-through dryer or as a recirculating dryer with partial venting (see figure 3).

Dimensions: See drawings on figure 2 . The south face of the dryer is 3,66 m wide. The 4 vents are 25 cm x 25 cm.

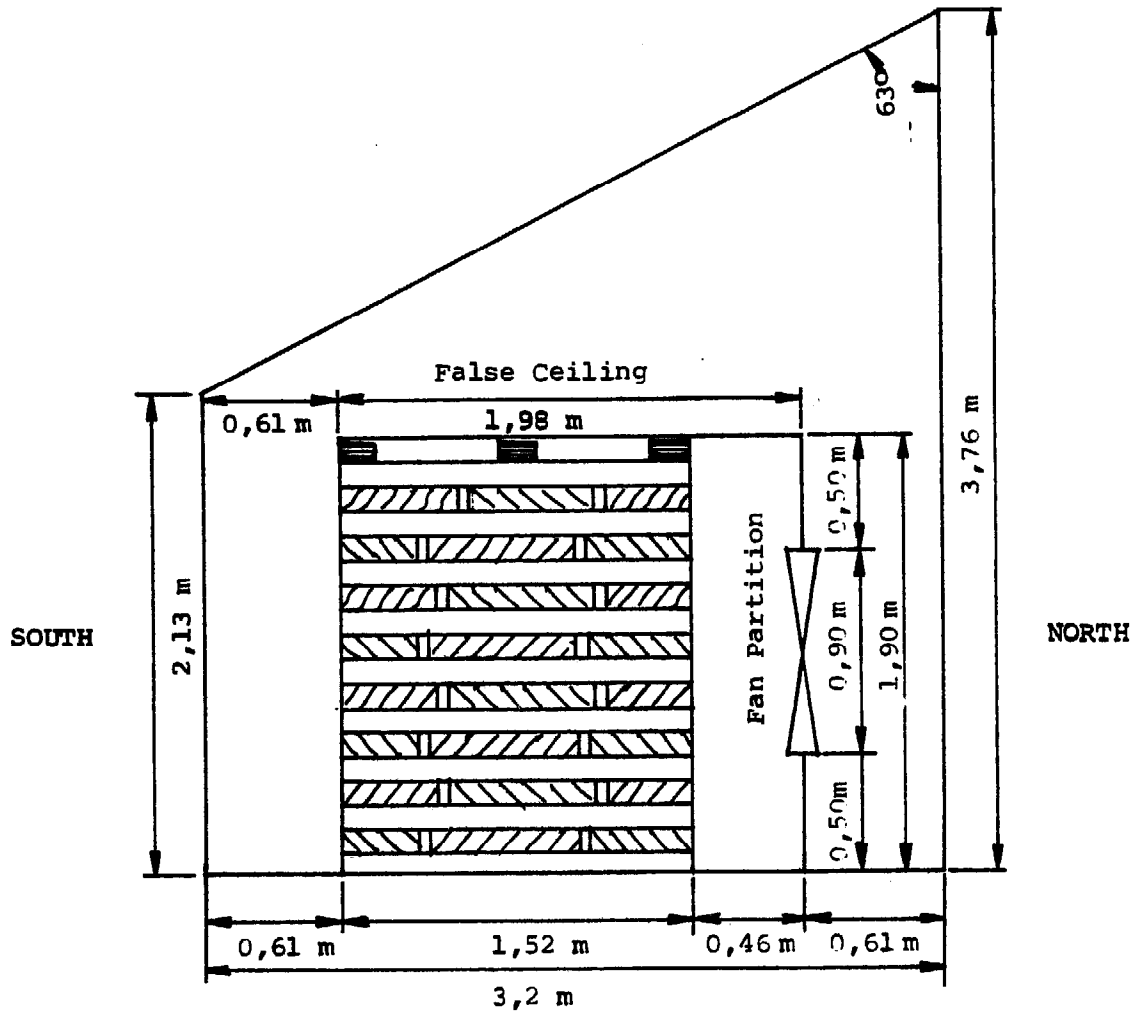


Figure 2. Plan of the Solar Timber Seasoning Kiln - Side View

Materials of Construction:

Drying Chamber:

Transparent cover: Outer sheeting: 0,25 mm polyethylene sheet  
Interior sheeting: 0,05 mm polyethylene sheet

Frames: Wood frame superstructure consisting of 12,5 cm x 5 cm wall and roof studs placed at 0,90 m intervals.

Insulation: 50 mm air gap between the double polyethylene sheeting; 9,5 mm plywood without air gap has been used for the North wall.

Location: Forest Research Institute

Latitude: 30°19'N

Longitude: 78°02'E

Climatological Data: Average value for 10 years (1960-1969)

Months	Rainfall mm	Relative Humidity	Temperature °C		
			Max	Min	Mean
March	47,3	65	26,6	9,1	17,7
June	200,0	61	35,4	21,5	27,7
September	263,2	84	29,6	19,9	24,1
December	29,9	89	20,9	3,8	11,8
Average annual	1968,0	74	27,9	13,1	24,0

Months	Hours of Bright Sunshine per day	Average Wind Velocity km/hr
March	8,2	3,2
June	5,9	3,2
September	6,9	2,9
December	7,7	2,4
Average annual	7,6	3,0

Practical Operations:

Number of units used in the past: none

Number of units currently in use: one at Dehra Dun and one at Banswara, Rajasthan, Latitude: 25°N

Periods of Operation:

(a) On experimental basis: January 1971 to May 1972

(b) In field operations: June 1972 to date



Drying Data:

TABLE A - Individual tests with 3,54 cu.m. charges of 25 mm planks of furniture and joinery woods.

<u>Material</u>	<u>Drying Time (Days) Green to 12% moisture content</u>
Mundani ( <i>Acrocarpus fraxinifolius</i> )	28 to 32
Toon ( <i>Cedrela Toone</i> )	days for
Hollong ( <i>Dipterocarpus macrocarpus</i> )	all the
Haldu ( <i>Adina cordifolia</i> )	species
Chir ( <i>Pinus roxburghii</i> )	cut as
Kanju ( <i>Holoptelea integrifolia</i> )	stated
Sissoo ( <i>Dalbergia sissoo</i> )	in (a)

TABLE B - Mixed 3,54 cu.m. charge of 75 x 100 mm framing of structural woods.

<u>Material</u>	<u>Drying Time (Days) Green to 12% moisture content</u>
Laurel	42
Hollong ( <i>Dipterocarpus marcocarpus</i> )	26
Hollock ( <i>Terminalia myriocarpa</i> )	30
Sissoo ( <i>Dalbergia sissoo</i> )	25
Safed siris ( <i>Albizzia procera</i> )	34
Eucalyptus hybrid	55

Furniture timbers were dried within 40% of the time required for normal air drying.

Operating Conditions:

Kiln Temperature Excess: Over ambient on clear days (°C)

	<u>May - June</u>	<u>November</u>
With green charge	10	15
With charge nearing completion of seasoning	20	28

Fans worked during daylight hours only, with baffles adjusted to produce:

- (a) a recirculating system with partial air venting, or
- (b) a single-pass flow-through drying system for use in early stages of drying wet timber or quick drying planking.

See Figure 3.

Economic Details:

	\$ U.S.
1. Concrete platform - 6,1 x 5,5 x 0,3 m	100,00
2. Timber for wall and roof stands, framing and foundations - 1,05 cu.m.	62,50
3. Plywood - 9,5 mm - 15,81 sq.m.	63,00
4,8 mm - 13,38 sq.m.	13,50
4. Polyethylene sheet - 0,25 mm - 122 cm wide - 50 m	28,13
0,25 mm - 150 cm wide - 60 m	23,00
5. Screws, nails, angle iron, etc.	18,75
6. Fan 91 cm - with auxiliary equipment	141,25
7. 1 HP electric motor	84,37
8. Black paint - 9 litres	9,00
9. Labour charges, 30 days	<u>75,00</u>
	TOTAL 618,50

\$1.00 U.S. worth approximately 8 Rupees

Annual Operating Expenditure:

Considering that a solar kiln will be effective only for about 8 months in the year in most part of the country, the annual operating costs will be as follows:

	\$ U.S.
Electric power for running fan (2 cents per Kwh)	79,63
Labour charges for stacking and unstacking of timber (32 man days)	12,50
Cost of replacing sheeting every 2 years	<u>25,00</u>
	TOTAL 117,13

Output of seasoned timber in 8 months: 28,32 cu.m.

The operating and construction costs are respectively 60% and 75% lower than those required in a standard steam heated kiln.

Cost of Drying Related to a Unit of Material Dried:

\$4.00 U.S. per cu.m. for planking

\$6.25 U.S. per cu.m. for framing

Estimated Life of the Dryer:

Polyethylene sheeting needs to be replaced every two years. Wood frame if made of durable hardwood or preservative treated timber is likely to give a life of at least 15 years.

Comments:

The kiln does not require skilled or full time operators indispensable in a steam or electric heated kiln and its initial cost is relatively low.

It is ideal for small saw millers and manufacturers of furniture who are operating on a small-scale. These people often use partially air seasoned or unseasoned timber for two reasons:

- 1) because of the widespread use of low shrinkage species such as teak and
- 2) because of a lack of awareness, on the part of the wood industry, of the need for properly seasoned wood for domestic uses.

The performance on cloudy days is rather poor.

A suitable device for storage of solar energy for night time use would result in further drying time savings and make the process more attractive. In India, the large scale timber industry has so far been seasoning properly only special wood products. If proper seasoning was to be extended to all the wood products, drying units would demand a fast turnover for economical operation.

An efficient arrangement for additional humidification of the kiln air remains to be developed to prevent cracking of the more refractory or thick section timber during the solar kiln drying process.

Principal Investigator(s): Sharma, S.N.  
Nath, Prem  
  
Wood Seasoning Branch  
Forest Research Institute  
Dehra Dun  
U.P. India

References:

- (1) Sharma, S.N., Nath, Prem, Bali, B.I., Journal of Timber Development Association of India, Volume XVIII, No. 2, April 1972.
- (2) Gupta, C.L., Draft for Action Plan for Solar Drying, ACES Occasional Paper No. 5, Auroville Centre for Environmental Studies, Pondicherry 605002, India, 1973

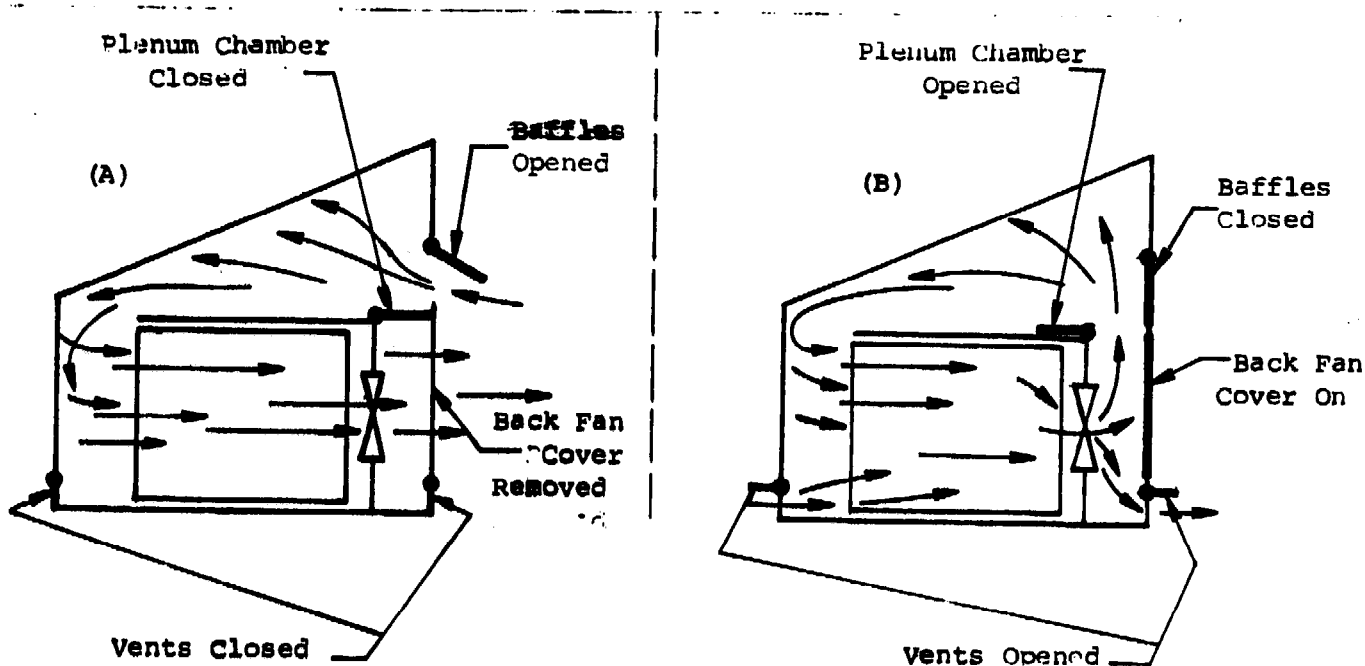


Figure 3. Drawing Showing the Kiln Working as (A)  
(A) A Single Pass Forced Air Dryer;  
(B) A Recirculating Air Dryer with Partial Ventilating

LUMBER SOLAR DRYER (Puerto Rico)Overview:

Status: experimental

Heating mode: hybrid

Type: chamber dryer

Air circulation: electric  
fan forced  
convection

This dryer has been tested and operated in Puerto Rico. It is one of a series of similar solar lumber kilns tested throughout the world, (United States, Philippines, India, Madagascar, Uganda, Japan and South Africa). The results of the many different tests have shown that the solar lumber drying is particularly effective and attractive in the tropical regions. The solar kiln dried lumber was found to have moisture contents lower than than can be expected with air drying.

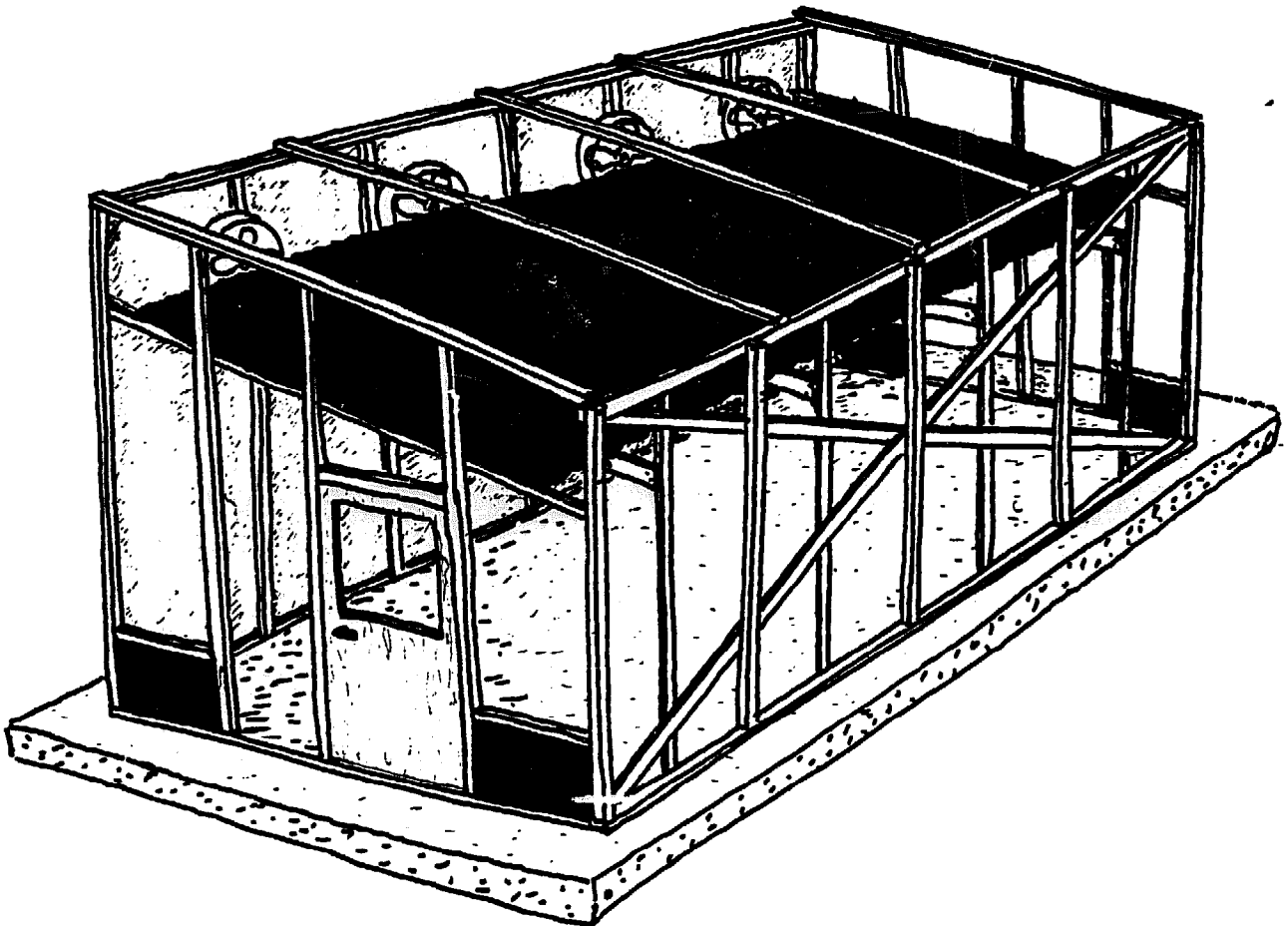


Figure 1. This Drawing Illustrates the Main Components of the Lumber Dryer: the Four Fans, the Blackened Metal Sheet Absorber and the Louvered Vents

### Characteristics:

The lumber dryer is aligned lengthwise on an east-west axis with its lower side wall facing south. The roof is sloped southward at an angle of about 16°. The structure rests on a reinforced concrete slab, to which it is anchored by bolts through sill plates. The north wall is covered with plywood sheets. All other walls and the roof are covered outside and inside with transparent plastic films which provide an insulating dead air space. Small louvered vents are set in the lower corners of the east and west walls.

This dryer has a blackened metal heat absorber, which is about 60 cm below the roof and parallel to it. Four fans, powered by a 1,1 kw motor mounted outside the north wall, are located in the upper back part of the dryer. These fans blow the air over and under the black absorber sheet, for taking as much heat as possible from it. Baffles are set around the fans and between the heat absorber and the top of the lumber pile (located centrally within the dryer). These force the air flow to circulate in the following path: from the heat absorbing surface, downward on the south side, through the lumber pile, and back upward on the north side into the fans. The slight pressure differential created on the two sides of the wood pile produces slow air movement through the vents.

Dimensions: The overall dimensions of the dryer are:

3,05 m wide and 6,10 m long, the south wall is 3,0 meters high  
and the north wall 4,1 m high  
diameter of fans: 40 cm  
air space between plastic sheets: 4 cm

### Materials of Construction:

#### Drying Chamber:

Transparent cover: roof and walls - transparent plastic film  
Frames: conventional 5 x 10 cm lumber  
Insulation: none

All imported materials.

Location: San Juan  
Puerto Rico

Latitude: 18°28'N  
Longitude: 66°06'W

### Practical Operation:

Number of units used in the past: one  
Number of units currently in use: none

#### Periods of Operation:

- (a) On experimental basis: the unit was tested only from December 1961 to April 1965  
(b) In field operations: --

### Drying Data:

Mahogany (*Swietenia macrophylla*) and Guaraguao (*Guarea*) were dried.

Quantities dried: 7 charges with 2 000 Bd. ft. each; and 1 charge with 5 000 Bd. ft. (For Drying Times, Operating Conditions, and Climatological Data, see tables 1, 2, 3, and 4).

TABLE 1 - Mean Monthly Climatological Data for the Rio Piedras - San Juan area (1900-1964)

	Jan.	Feb.	Mar.	Apr.	May	June	July	Aug.	Sept.	Oct.	Nov.	Dec.	Mean Annual
Temperature (°C)	23,9	23,9	24,4	25,0	26,0	26,6	26,7	27,1	27,0	26,8	25,9	24,8	25,7
Relative humidity (Percent)	75	74	72	75	76	78	78	77	78	78	77	75	76
Equilibrium Moisture Content (Percent)	14	14	13	14	14	15	15	15	15	15	15	15	14,5
Rainfall (mm)	10,5	68,5	52,6	98,8	184,0	148,0	153,0	161,0	151,0	133,0	153,5	124,0	1 530,0
Solar Radiation (Langley's) <u>1/</u>	385	440	495	480	460	470	480	460	410	410	375	350	435

1/ Mean daily for years 1957-1960. Data supplied by M. del C. Fernandez, University of Puerto Rico, Agricultural Experiment Station, Rio Piedras.

TABLE 2 - Temperature, relative humidity, and EMC (equilibrium moisture content) for selected periods inside and outside the solar dryer

	December 1963		July 1965		April 1965	
	Inside	Outside <u>1/</u>	Inside	Outside <u>1/</u>	with mist sprayers on <u>2/</u>	
Temperature (°C)						
Mean Maximum	43,5	29,5	42,6	29,5	38,9	
Mean Minimum	22,7	20,0	25,5	23,9	22,2	
Average	32,7	24,5	34,4	26,2	30,5	
Relative Humidity (Percent)						
Mean Maximum	69	86	69	81	90	
Mean Minimum	48	43	41	55	66	
Average	58	64	55	68	78	
Equilibrium Moisture Content (Percent)						
Mean Maximum	13,0	18,8	12,7	16,6	21,0	
Mean Minimum	8,0	8,0	6,9	9,8	11,5	
Average	10,5	13,4	9,8	13,2	16,3	

1/ Measured in the shade outside the solar dryer  
2/ Vents closed and mist sprayers on during daylight hours

TABLE 3 - Drying Time and Final Moisture Content of Various charges of Solar Dried and Air-Dried Lumber

Lumber Thickness	Starting Date	Initial Moisture Content	Drying Days	Solar Drying		Air Drying	
				Final Moisture Content	Range	Final Moisture Content	Range
Inches	%	No.	%	%	%	%	%
<u>MAHOGANY (SWIETENIA MACROPHYLLA)</u>							
1 (2,54 cm)	Dec. 15, 1961 (charge 2)	35	25	11	8-12	--	--
	Aug. 5, 1963 (charge 5)	28	12	11	10-12	17	16-18
	Dec. 17, 1963 (charge 7)	48	16	13	11-14	20	19-23
1- $\frac{1}{4}$ (3,17 cm)	Oct. 26, 1961 (charge 1)	50	30	11	10-12	25	23-27
2 (5,1 cm)	Jan. 16, 1962 (charge 3)	40	35	12	11-13	23	20-28
	Feb. 7, 1963 (charge 4)	60	39	14	11-18	27	20-35
	Sept. 9, 1963 (charge 6)	47	44	11	8-13	20	17-25
<u>MIXED PUERTO RICAN HARDWOODS (11 species)</u>							
1- $\frac{1}{4}$ (3,17 cm)	Apr. 19, 1965 (charge 8)	38-80	43	12	11-14	20	18-26

Table 4 - Solar and air drying times for various thickness  
of mahogany and mixed Puerto Rican Hardwoods

Days Required to Dry Between Various Moisture Content Levels 1/  
50 to 40% 40 to 30% 30 to 20% 20 to 15% 15 to 12% 50 to 15%

Drying Trials

<u>MAHOGANY (SWIETENIA MACROPHYLLA)</u>						
<u>1-inch (2,54 cm)</u>						
Solar-dried						
Dec.1961 (charge 2)	-	(4)	6	6	5	
Aug.1963 (charge 5)	-	-	(3)	4	3	
Dec.1963 (charge 7)	2	3	3	3	6	
Average (solar-dried)	2	3	4	4	5	<u>13</u>
Air-dried						
Dec.1961 (charge 2)	-	-	-	-		
Aug.1963 (charge 5)	-	-	(6)	(14)		
Dec.1963 (charge 7)	(2)	3	11	(26)		
Average (air-dried)	2	3	8	20		<u>33</u>
<u>1-1/4 inch (3,17 cm)</u>						
Solar-dried						
Oct.1961 (charge 1)	3	3	7	6	6	19
Air-dried						
Oct.1961 (charge 1)	7	13	(20)	(30)	-	70
<u>2-inch (5,1 cm)</u>						
Solar-dried						
Jan.1962 (charge 3)	-	7	10	10	8	
Feb.1963 (charge 4)	5	7	11	10	(8)	
Sept.1963 (charge 6)	4	8	11	9	8	
Average (solar-dried)	5	7	11	10	8	<u>33</u>
Air-dried						
Jan.1962 (charge 3)	-	13	(30)	(40)		
Feb.1963 (charge 4)	8	15	(33)	(45)		
Sept.1963 (charge 6)	5	13	(27)	(40)		
Average (air-dried)	7	14	30	42		<u>93</u>
<u>MIXED PUERTO RICAN HARDWOODS</u>						
<u>1-1/4 inch (3,17 cm)</u>						
Solar-dried						
Apr.1965 (charge 8)	5	7	12	11	4	35
Air-dried						
Apr.1965 (charge 8)	4	7	29	50	-	90

1/ Values in parenthesis are estimates based on extrapolation.



Economic Details:

Cost of materials: 2 000 U.S. dollars  
Labour cost: 2 000 U.S. dollars  
4 000 U.S. dollars

Annual Operating Expenditure:

No determination was made, only experimental work.

Estimated Life of the Dryer: 15 years minimum

Comments on the Dryer:

No technical problems. More economic than conventional kilns.

Principal Investigator(s):

Maldonado, Eldwin D.  
Chudnoff, Martin  
  
Institute of Tropical Forestry  
P.O. Box AQ  
Rio Piedras, Puerto Rico 00928  
U.S.A.

References:

- (1) Maldonado, E.D., Peck, E.C., Drying Lumber by Solar Radiation in Puerto Rico, Forest Products Journal, October 1962, pp. 487-488
- (2) Peck, E.C., Drying Lumber by Solar Energy, Sun at Work, Third Quarter 1962, 2 pages

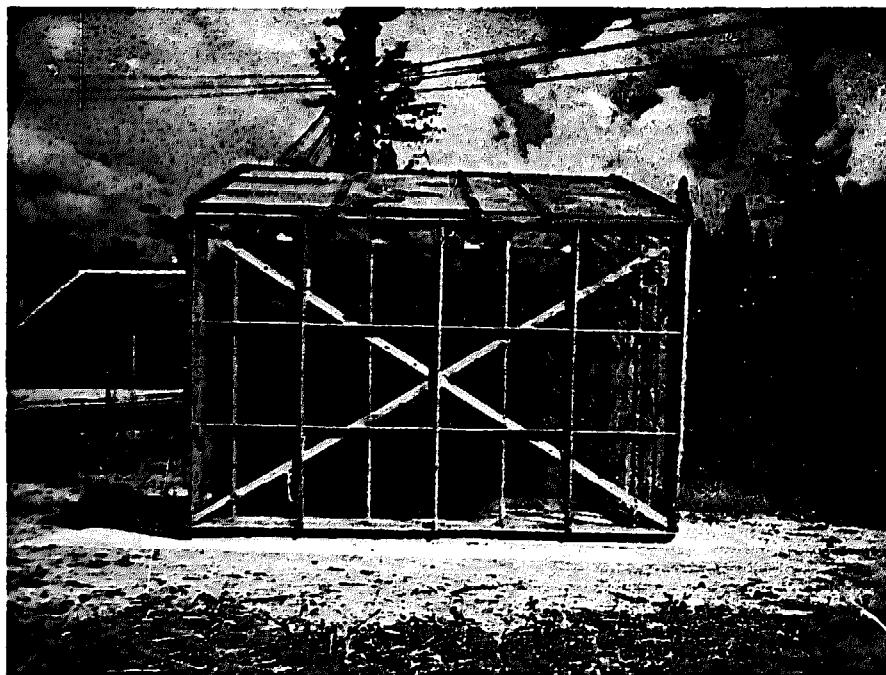


Figure 2. View of Dryer

WOOD PRE-DRYING UNIT (Japan)Overview:

Status: experimental

Operating mode: hybrid

Type: chamber dryer

Air circulation: electric  
fan-forced  
ventilation

This solar lumber dryer is supplemented with an automatic steam heating system for allowing reasonable drying times of the lumber in the particular climatic conditions of Japan.

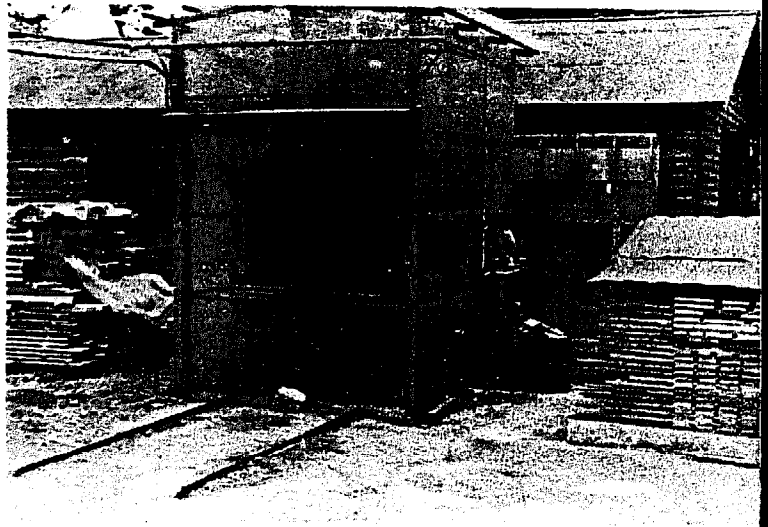
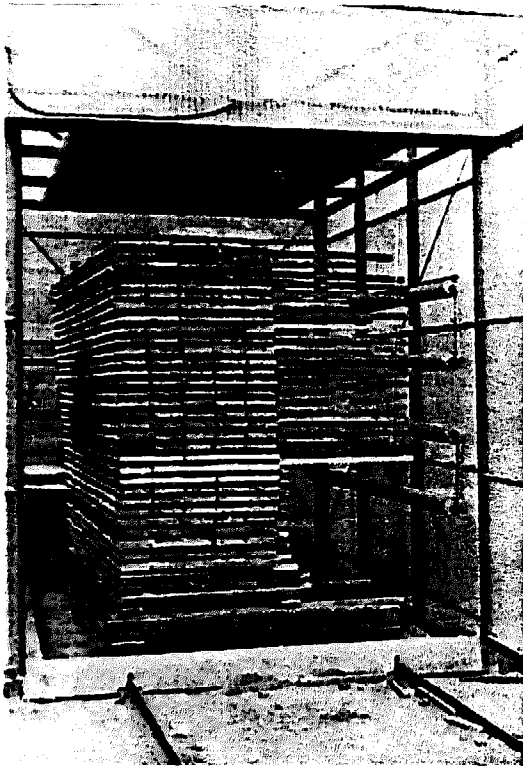


Figure 1. Two Photos of Wood Pre-Drying Unit. Photo at Left Shows Supplementary Steam Heater.

Characteristics:

The drying chamber consists of an angle iron frame covered with vinyl sheets. A carrier was used to load and unload the timber. The drying was supplemented with a steam heating system to be used during the night and rainy days. A 4-propeller fan, powered by a 0,75 Kw electric motor, was used for the air circulation system.

Dimensions: The dryer is 3 m high, 2 m long and 2 m wide.  
Fan diameter: 61 cm. See Figure 2 and 3.

Materials of Construction:

Drying Chamber:

Transparent cover: corrugated waved PVC panels  
Frames: iron, angle and channels  
Insulation: none

Location: Government Forest Experiment Station  
Tokyo, Japan

Latitude: 35°37'N  
Longitude: 139°42'E

Climatological Data:

	August	November	Year	Period
Average Monthly Temperature	26,7°C	11,7°C	15,0°C	1941-1970
Average Monthly Relative Humidity	77%	68%	69%	ditto
Monthly Sunshine	194 hr. (6,3)*	147 hr. (4,9)*	1640 hr.	ditto
Monthly Rainfall	153 mm (4,9)*	96 mm (3,2)*	125 mm	ditto
Weather (14:00 hr)	fair 15 days cloudy 13 others 3	14 days 12 5		1945-1952

\* Value in brackets represent daily averages

Practical Operation:

Number of units used in the past: one  
Number of units currently in use: none

Periods of Operation:

- (a) On experimental basis: August 1962 - December 1962 for two tests
- (b) In field operations: --

Drying Data:

Red Lauan (Dipterocarpaceae), thickness: 37 mm.

Test No.	Month	Quantities Dried m <sup>3</sup>	Moisture Content (ds)		Drying Time (days)
			Initial %	Final %	
1	August	5	90	20	15
2	November	5	90	20	20

Operating Conditions:

During fair days, only solar heat was used. During rainy or cloudy hours of the day and during night, automatically ON-OFF controlled steam heating system was used.

Economic Details:

Cost of materials: (including labour)	iron frame and vinyl sheet	770	\$U.S.*
	carrier and rail	580	
	motor and fan	300	
	heating fin pipe	200	
	automatic control apparatus	580	
	electric cable and steam supplying pipe	400	
	TOTAL	2 830	\$ U.S.

\* \$1,00 U.S. = 260 yen

Annual Operating Expenditure:

No detailed data. Electric power needed: 1 Kw; steam used: 10-20 Kg/hr. at night.

Estimated Life of the Dryer:

Vinyl panels 3 years, iron frame more than 10 years and motor and heater 7 to 8 years.

Comments on the Dryer:

The author reported that this dryer is not economically feasible in Japan because of short sunshine hours and frequent rainy days.

Principal Investigator(s):

Terazawa, Shin  
Government Forest Experiment Station  
Shimomeguro 5-37-21  
Meguro-ku, Tokyo  
Japan

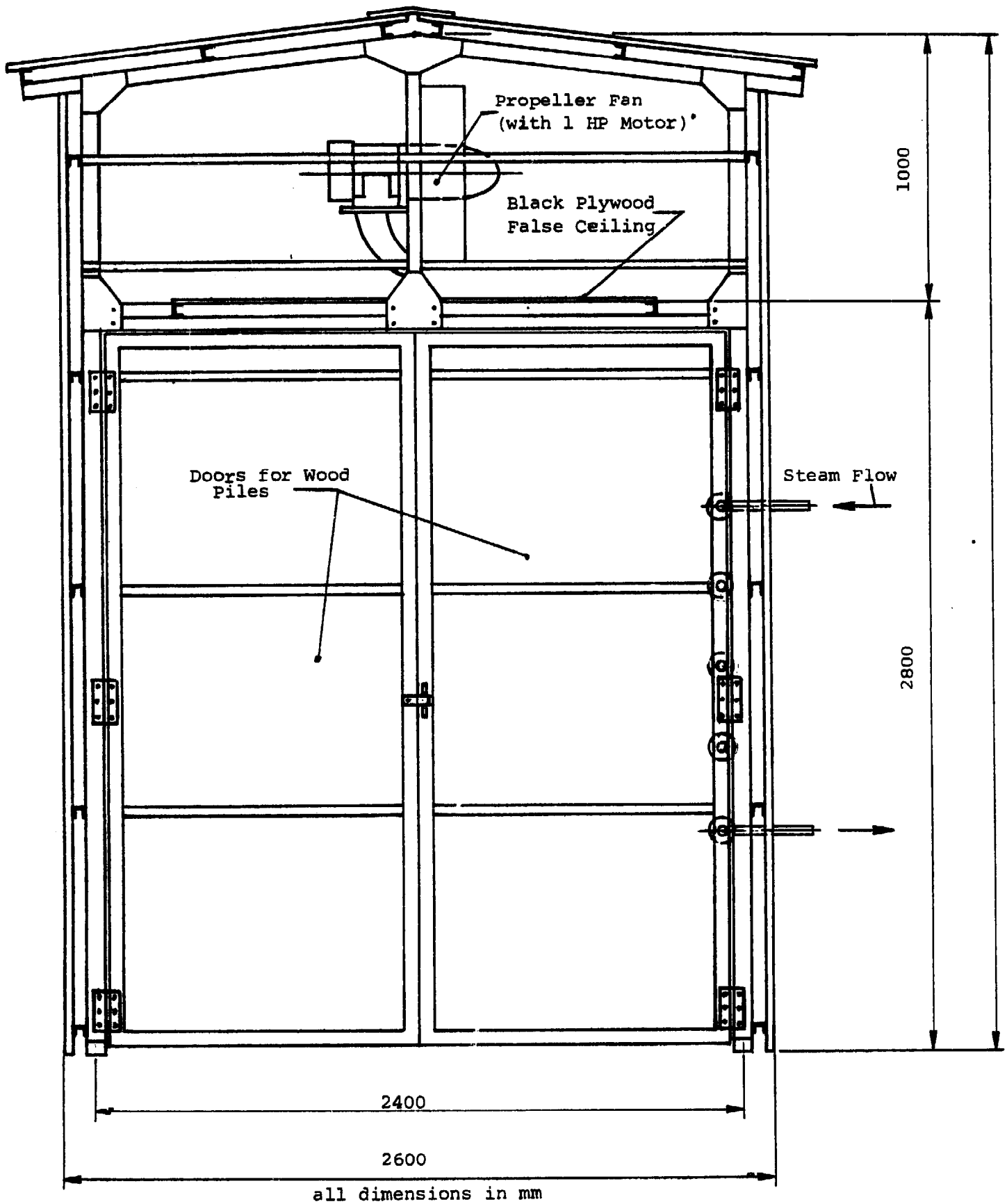


Figure 2. Schematic Plan of the Dryer, Front View

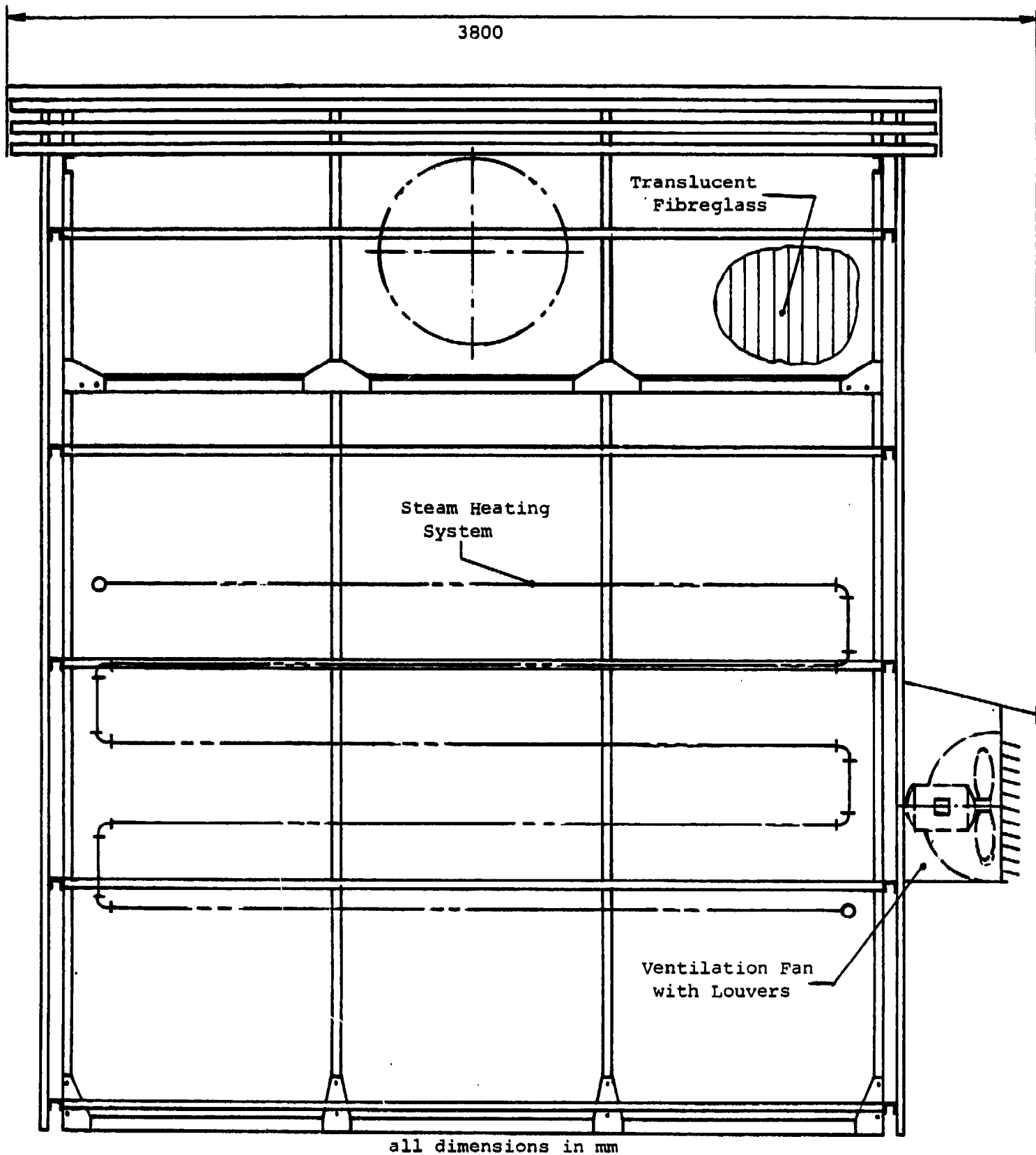


Figure 3. Schematic Plan of the Dryer, Side View

SOLAR HEATED LUMBER DRYER (UNITED STATES OF AMERICA)

Review:

us: experimental  
: chamber dryer

Heating mode: hybrid  
Air circulation: electric fan-forced ventilation

Hybrid-type dryer uses the sun as a heat source, and uses electricity for a fan for generating air flow inside the dryer. The economics of this method are similar to those of air drying, but its main advantage is that the drying time is reduced by 50%.

Figure 1. Experimental solar dryer with double glazed plastic walls and roof.

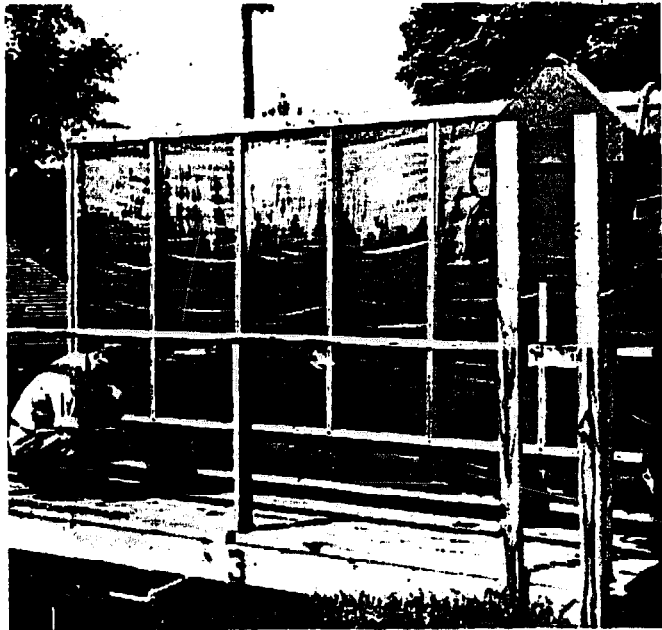


Figure 2. Interior of experimental solar predryer showing location of test load

Characteristics:

The structure is aligned lengthwise on an north-south axis. Sheets of transparent plastic are fastened to the outer edges of the studs and rafters. The end wall facing north is sheathed with plywood and includes a door into the pre-dryer. A second film of transparent plastic is mounted on frames to provide a space of about 10 cm between the two plastic films. Four vents, two being located on the entering air side (east wall) and two on the exhaust air side (west wall) allow for the proper control of air recirculation and humidity in the dryer. Sheets of corrugated aluminum, painted dull black in both sides to absorb solar radiation are nailed to the underside of the studs and rafters. Rectangular openings are cut in the aluminum surfaces of the east and west walls and in the roof, and the metal is bent to form air deflectors. This causes some of the circulated air to pass over the outer as well as the inner face of the heat absorbing metal, and allows a more effective utilization of the sun's heat. An electric fan powered by a 0,5 Kw motor is mounted in a central baffle that extends the entire length of the dryer. The fan actuates the air flow movement inside the dryer. It is controlled by a photo cell and is operated only during daylight hours.

Dimensions: The overall dimensions of the dryer are:  
3,86 m long, 2,29 m wide and 2,43 high  
fan diameter is 60 cm  
vents diameter 20 cm.

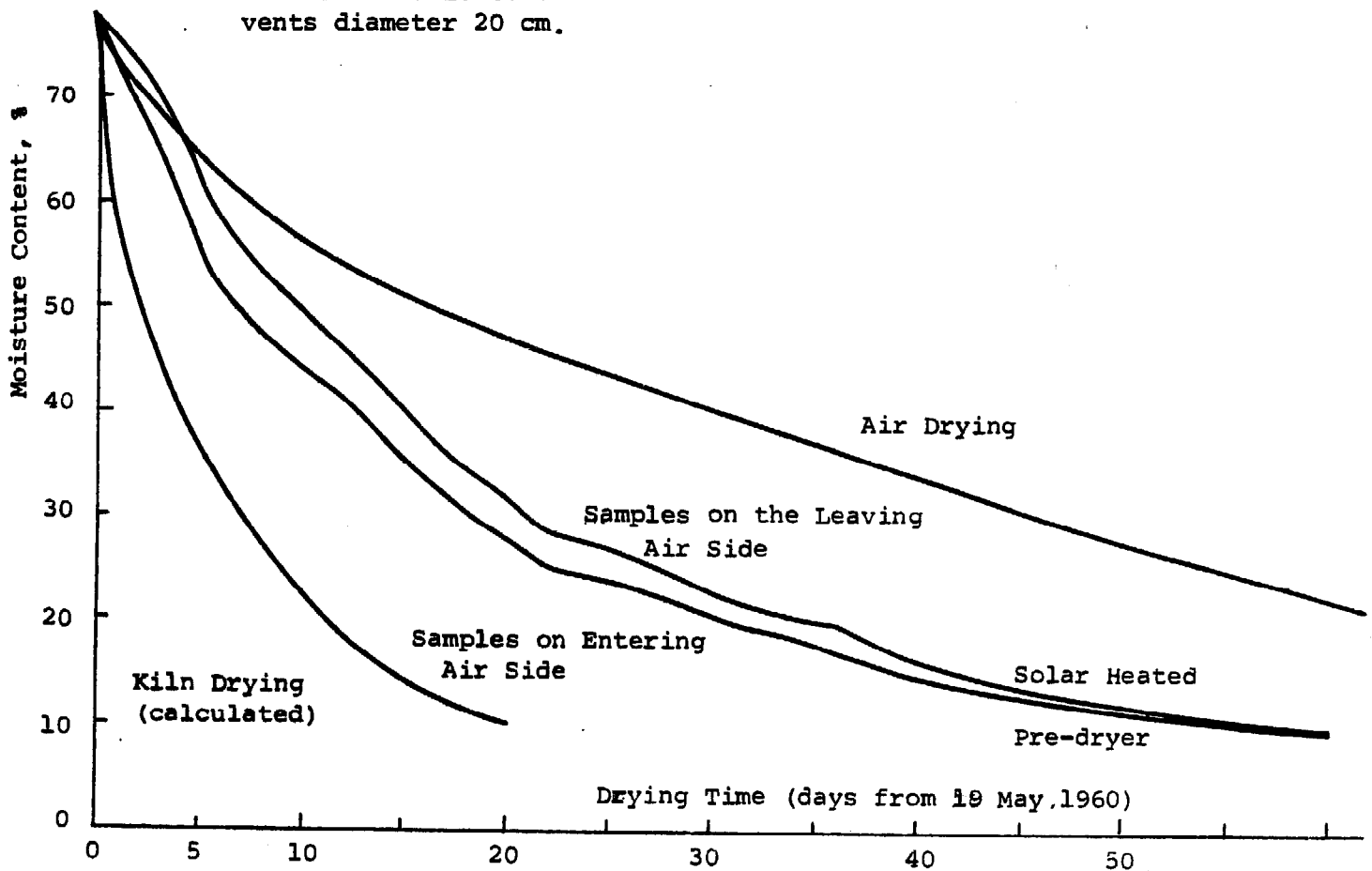


Figure 3. Comparison of Drying Curves for Air-Dried and Kiln Dried (calculated) Lumber with Those Obtained for Lumber in Charge 1 Dried in the Solar Heated Pre-Dryer.



Materials of Construction:

Drying Chamber:

Transparent cover: 2 layers of mylar plastic film  
Frames: 5 x 10 cm lumber for walls, and 5 x 15 cm rafters for roof  
Insulation: the air gap between the two transparent plastic sheets acts as insulation

Location: Madison, Wisconsin, U.S.A.

Latitude: 43°08'N  
Longitude: 89°20'W  
Altitude: 261,5 m.

Climatological Data:

	<u>January</u>	<u>July</u>	<u>Annual</u>
. Mean monthly temperature, °C	-8,1	21,5	7,2
Daily maximum °C	-3,4	27,9	
Daily minimum °C	-12,7	15,6	
. Precipitation, mm	31,2	100	765
. Relative Humidity (percent)			
at 12:00 hr.	67	58	62
at 06:00 hr.	76	89	83
. Sunshine, percentage of possible (percent)	49	70	58
. Daily means of solar radiation intensity, Kwhr/(m <sup>2</sup> .day)	1,80	6,43	3,94
. Mean hourly wind speed (km/hr) (prevailing direction)	10,5 (WNW)	8,3 (S)	10,2 (S)

Practical Operation:

Number of units used in the past: one  
Number of units currently in use: none

Periods of Operation:

The dryer was used only on an experimental basis from 1960 to 1964.

Drying Data:

Quantities dried: 1 cubic meter of red oak planking per charge  
Drying time: approximately 40 days to dry to 15 percent moisture content (oven dry basis)

Operating Conditions:

The fan was operating during daylight hours only. The mean daily temperatures within the dryer were 5° to 12°C above outdoor temperatures (see table 1). During mid-afternoons, the temperature differences were considerably higher, sometimes as much as 27,5°C.

**TABLE 1 - TEMPERATURES WITHIN THE SOLAR-HEATED PREDRYER AND OUTDOORS  
AND SOLAR RADIATION DURING THE DRYING OF 4/4 RED OAK**

Drying Periods	Average Temperatures				Solar Radiation on the horizontal Kwhr/m <sup>2</sup>
	Weather Bureau	Recorded Outside Predryer	Recorded Inside Predryer	Difference	
	°C	°C	°C	°C	
<b>CHARGE 1</b>					
May 19-31, 1960	16,4	18,2	25,0	7,6	66,3
June 1-20, 1960	16,8	22,9	31,2	8,3	123,1
Average				8,0 (1)	
June 21-30, 1960	19,8	24,6	32,9	8,3	65,7
July 1-15, 1960	18,6	23,1	32,6	9,5	109,1
				8,4 (1)	
<b>CHARGE 2</b>					
Aug. 18-31, 1960	21,8	22,0	31,7	9,7	65,7
Sept. 1-9, 1960	25,3	27,5	36,1	8,6	48,5
Average				9,2 (1)	
Sept. 10-30, 1960	15,0	15,0	25,8	10,8	81,2
Oct. 1-21, 1960	11,0	11,3	23,4	12,1 (2)	82,6
Average				10,7 (1)	
<b>CHARGE 3</b>					
Nov. 17-30, 1960	2,4	2,8	8,1	5,3	27,8
Dec. 1960	-6,2	-6,0	0,7	6,7	64,9
Jan. 6-17, 1961 (3)	-1,7	-1,5	5,4	6,9	71,9 (4)
Feb. 6-28, 1961 (5)	0,0	0,2	9,0	8,8	82,2 (4)
March 1, 1961	2,8	6,1	10,8	4,7	2,8
Average				7,1 (1)	

- (1) Weighted average
- (2) Data available for 12 days only
- (3) No data for the remainder of January
- (4) Solar Radiation for the entire month
- (5) No data for the remainder of February

**NOTE:** It should be noted that, for each charge, the increase in the temperature difference between inside and outside the dryer as drying progresses means that moisture has been taken out of the drying wood.

Estimated Life of the Dryer: 5 years

Comments on the Dryer:

The drying of three charges of 4/4 red oak lumber by solar heat demonstrated that the drying time to a moisture content of 20% can be reduced to about one-half of that required to dry the same amount of lumber in the open air.

The cost of the drying process using solar heat is approximately equal to the cost of air drying.

The results of these experiments, which were conducted at a geographical location where only a moderate amount of solar energy is received, indicated that there are places where drying lumber by solar heat should be economically feasible in competition with air drying.

Principal Investigator(s): Peck, E.C.  
Forest Product Laboratory  
USDA Forest Service  
P.O. Box 5130  
Madison, Wisconsin 53705  
United States of America

References:

- (1) Peck, E.C., Drying 4/4 Red Oak by Solar Heat, Forest Products Journal, Volume XIII, No. 3, March 1962, pp. 103-107.

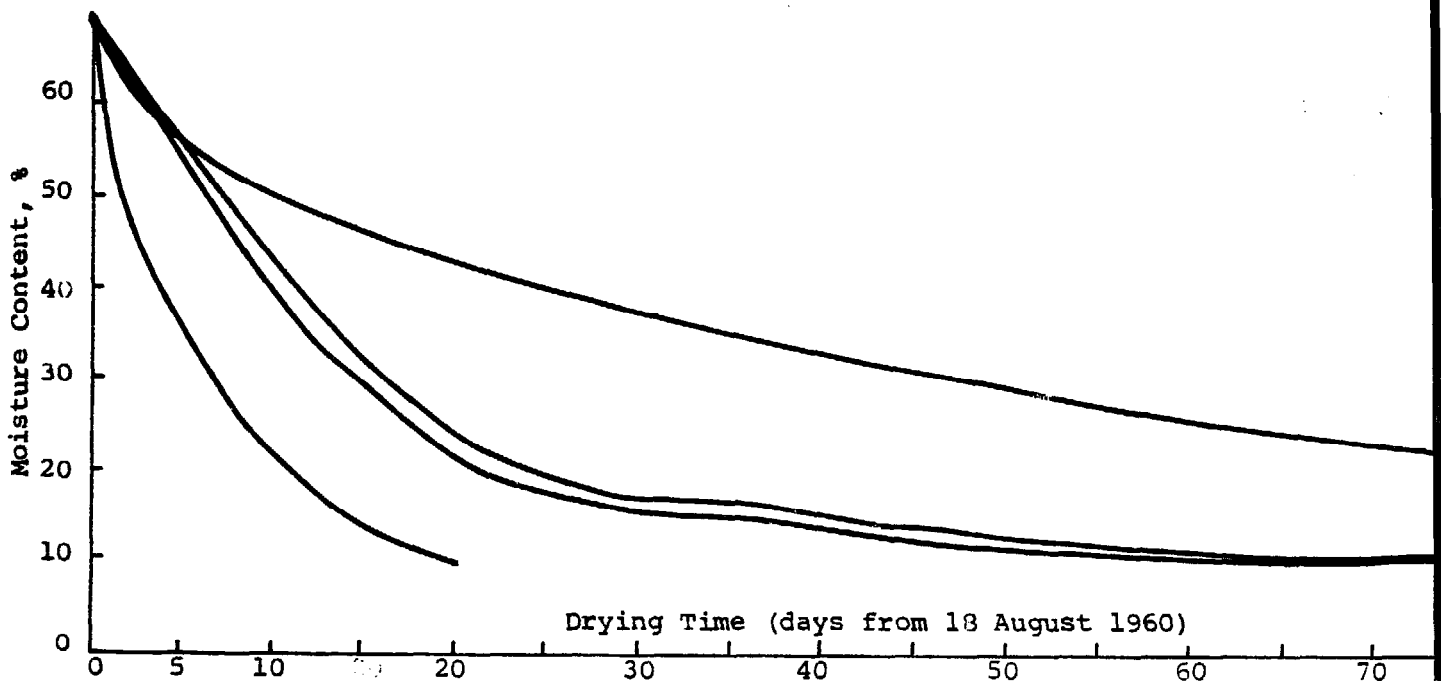


Figure 4. Comparison of Drying Curves for Air Dried and Kiln Dried (calculated) Dried Lumber with Those Obtained for Lumber in Charge 2 Dried in the Solar Heated Pre-Dryer

LUMBER DRYER (Madagascar)Overview:

Status: operational

Heating mode: hybrid

Type: chamber dryer

Air circulation: electric  
fan-forced  
ventilation

The construction of this dryer is based on an experiment conducted at the Colorado State University in Fort Collins, Colorado. The dryer is now used permanently for the seasoning of local wood species in the tropical climate of Madagascar. The solar drying of wood is reported to yield lower moisture content and a higher quality of wood than is obtainable by air drying.

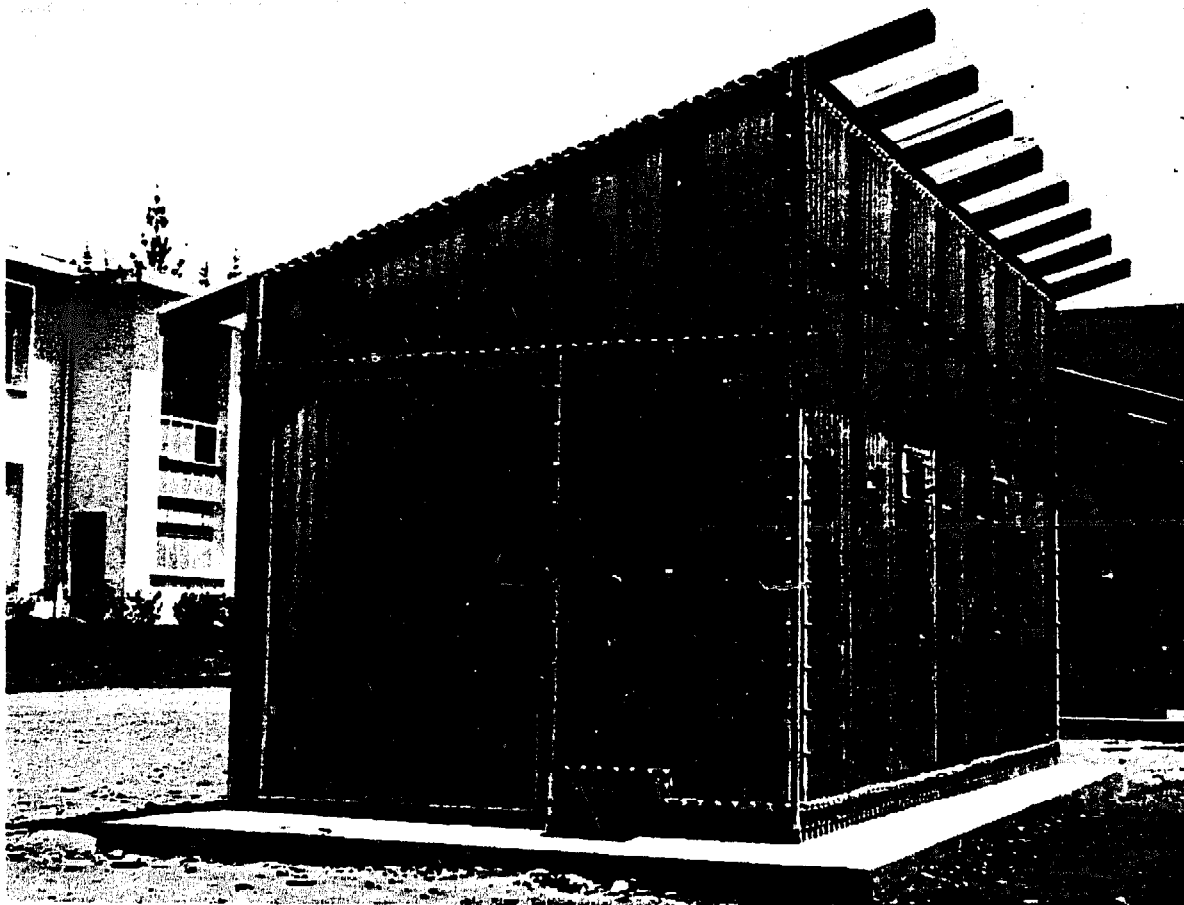


Figure 1. General View of the Lumber Dryer. The Inlet Vents can be seen on the Right, and Outlet Vents on the Left.

Characteristics:

The frame is erected on a concrete slab whose surface is smoothened with black concrete for better absorption of heat. The frame has a single slope roof and is built of pine wood. The wood structure was treated with a preservative which has a dark brown pigment for improving the absorption of

heat inside the structure. The whole structure is covered with clear corrugated fiber glass sheets. All gaps are sealed. The dryer is oriented lengthwise on a North-South axis and the high front is facing east. Two ventilators located near the roof are oriented at 45° towards the bottom of the dryer. They direct the hot air which has accumulated under the roof, through the wood pile after it has hit the back wall (Figure 2). Each three-propeller ventilator generates an airflow of 90 m<sup>3</sup> of air per minute. The air enters through two openings, located on the east wall at 1,75 m from the soil, and leaves through two vents placed in the North and South walls near the soil. The wood pile is placed near the East wall. The preliminary tests were conducted with two identical piles of wood, one in the dryer here is described, and the other under a shed located near it. This shed only protects the wood from rain and direct sun.

Dimensions: The dryer has a floor area of 3 m x 5m6 m and is 3,7 m high in front and 2,5 m in the back. Air openings and vents: 0,4 m x 0,2 m. The diameter of the fans is 60 cm.

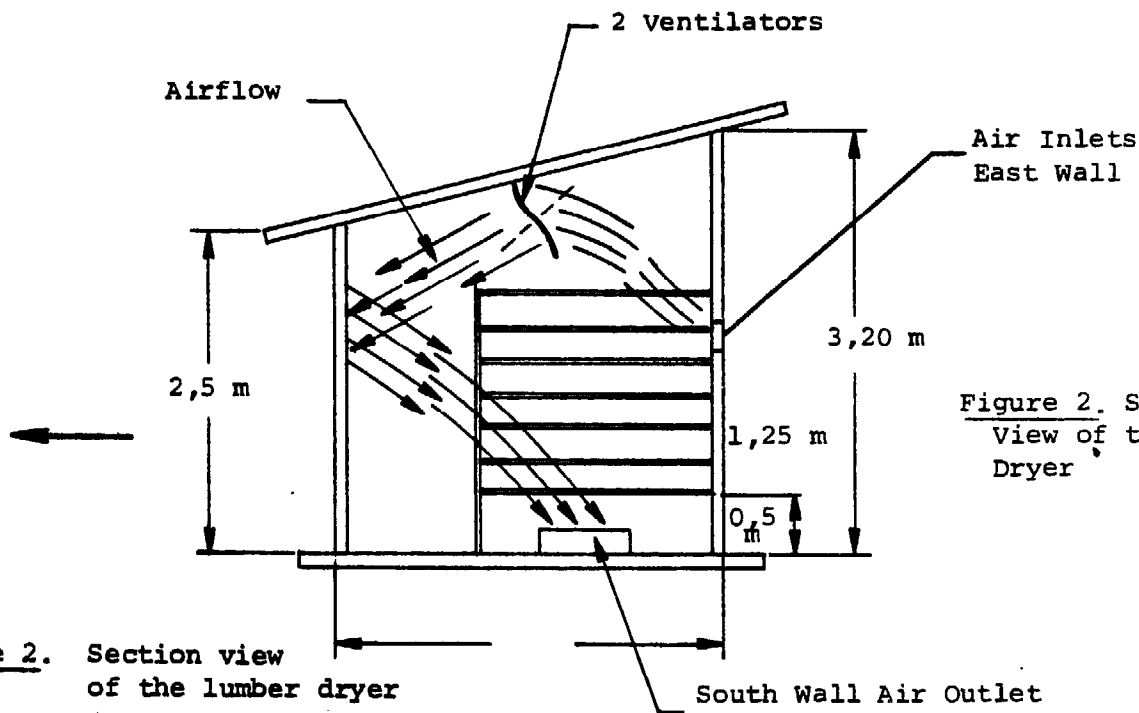


Figure 2. Section view of the lumber dryer

Materials of Construction:

Drying Chamber:

- Transparent cover: polyester reinforced clear corrugated fiber glass sheets, 0,9 m thick
- Frames: pine boards
- Insulation: none
- Trays: 2 cm thick wood lath shelving

Location: Tannanarive, Madagascar

- Latitude: 10°55'S
- Longitude: 47°32'E
- Altitude: 1433 meters

Climatological Data:

	<u>March</u>	<u>June</u>	<u>Sept.</u>	<u>Dec.</u>
Insolation hours (mean monthly on 13 years)	194	212,4	248,9	210,5
Maximum temperature (daily mean on 10 years)-(°C)	23,6	19,3	20,5	24,7
Minimum temperature (daily mean on 10 years)-(°C)	15,1	9,5	9,6	14,8
Maximum relative humidity (daily mean 1956)-(%)	97	97	95	98
Minimum relative humidity (daily mean 1956)-(%)	56	52	46	54
Total energy falling on horizontal surface (daily total's mean for the month)-(cal/cm <sup>2</sup> -day)	481	346	532	539

Practical Operation:

Number of units used in the past: one

Number of units currently in use: one

Periods of Operation:

(a) On experimental basis: 1969-1970

(b) In field operations: 1970-1973

Drying Data:

Materials Dried* (Quantity)	Time needed to reach 20% dry basis in days		Supplementary time needed to reach 15% dry basis in days		Final Humidity after 138 days of drying percent	
	shed	dryer	shed	dryer	shed	dryer
Pineboards (120) (Pinus Khasya) 4 m x 20 cm x 27 cm	76	55 to 75	38	12 to 25	13,0	7,5
Thick pine boards (10) 4 m x 23 cm x 8 cm	118	94	not reached	23	16,5	12,0
Rosewood beams (35) (dalbergia baroni) 1,20 m x 12 cm x 12 cm	over 150	107	not reached	22	21,0	13,0
	from extra- polation					
Rosewood rafters (35) 1,20 m x 12 cm x 5 cm	76	70	46	24	13,0	8,0

\* The materials were placed in the shelving in the following order; starting 50 cm from the soil level and going upwards: pine boards, thick pine boards, rosewood beams, rosewood rafters.

Operating Conditions:

The ventilators were working only during the day, from 08:00 to 18:00 on week days, from 08:00 to 12:00 on Saturday and not at all on Sunday.

The maximum and minimum temperature, relative humidity and moisture content of the different pieces of wood and timber were measured during the 138 days that the experiment was carried out.

Economic Details:

Cost of materials:

Wood frame	U.S. \$	44.00
preservative products		18.00
masonry		109.00
cover materials and sealing		564.00
miscellaneous		55.00
labour		330.00
electrical installations		<u>400.00</u>
TOTAL	U.S. \$	1520.00 *

\* \$1.00 U.S. worth approximately 275 Malagacy Francs (FMG)

It should be noted that the unit was built as an experiment, and that special materials not locally available had to be imported at fairly high costs.

Annual Operating Expenditure:

Not available

Cost of Drying Related to a Unit of Material Dried:

Not available

Estimated Life of the Dryer: 10 years

Comments on the Dryer:

This type of dryer is most advantageous in the drying period where the lumber is being reduced from 20 to 15% moisture content. It is also able to dry wood to moisture content as low as 7 to 8% (dry basis) which is impossible to reach in a natural drying process in the conditions prevailing in this tropical climate.

For large pieces of wood, it would be advantageous to use natural air drying to lower the moisture content to the 20% region.

The main drawback is economic because of the high cost of the transparent cover imported from Europe. Some other transparent covering material must be tried.

Improvements in the drying rate could be attempted by increasing the time of operation of the fans. The water that condenses on the walls at night could be eliminated by sweeping it out in the morning.

Principal Investigator (s): M. Bedel, P. Gueneau  
Centre Technique Forestier Tropical  
45 Bis Avenue de la Belle Gabrielle  
94000 Nogent sur Marne, France

References:

- (1) Gueneau, P. Une expérience de séchage solaire du bois, Bois et Forêts des Tropiques, No. 131, mai-juin 1970, pp. 69-78.