

# **AT** MICROFICHE REFERENCE LIBRARY

A project of Volunteers in Asia

## Small Farm Grain Storage

by: Carl Lindblad and Laurel Druben

Published by:

VITA/Peace Corps  
1815 North Lynn Street  
P.O. Box 12438  
Arlington, VA 22209 USA

Paper copies are \$18.95.

Available from:

Volunteers in Technical Assistance  
1815 North Lynn Street  
P.O. Box 12438  
Arlington, VA 22209 USA

Reproduced by permission of Volunteers in  
Technical Assistance and the Peace Corps.

Reproduction of this microfiche document in any  
form is subject to the same restrictions as those  
of the original document.

# SMALL FARM

# GRAIN STORAGE

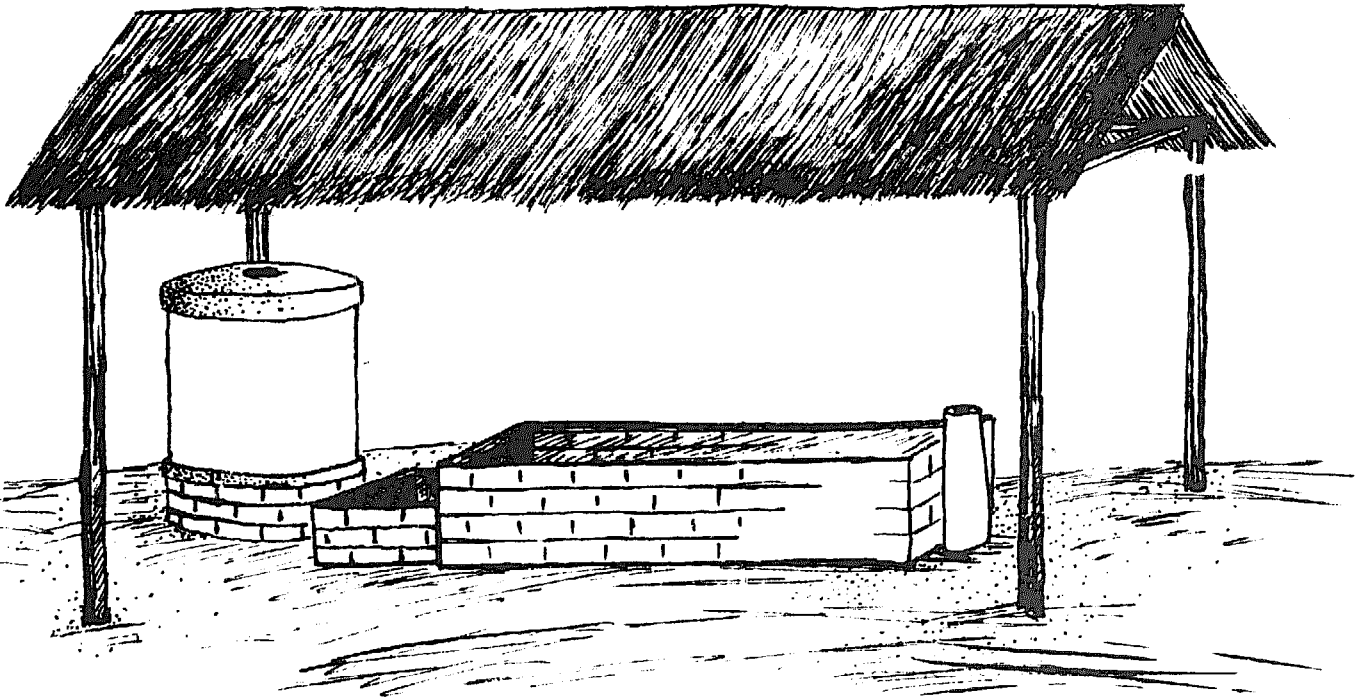

**SMALL FARM GRAIN STORAGE**

**BY**

**CARL LINDBLAD, PEACE CORPS**

**AND**

**LAUREL DRUBEN, VITA**

**ACTION/PEACE CORPS  
PROGRAM & TRAINING JOURNAL  
MANUAL SERIES NUMBER 2**

**VOLUNTEERS IN TECHNICAL  
ASSISTANCE  
VITA PUBLICATIONS  
MANUAL SERIES NUMBER 35E**

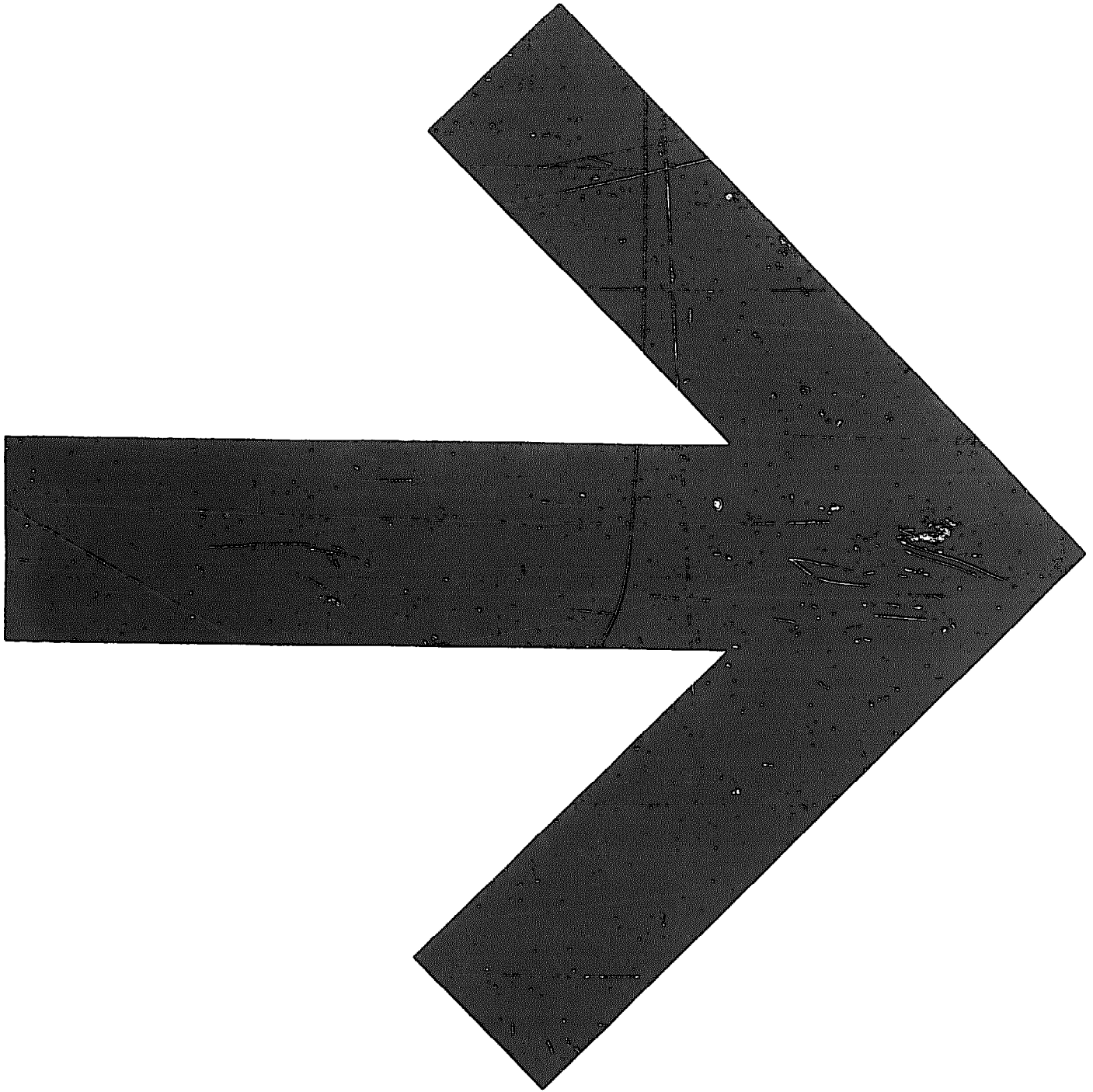

# TABLE OF CONTENTS

## INTRODUCTORY

SECTION 1: WHAT THIS MANUAL WILL TALK ABOUT: THE GRAIN STORAGE PROBLEM

SECTION 2: GRAIN IS A LIVING THING

SECTION 3: GRAIN, MOISTURE, AND AIR

SECTION 4: PREPARING GRAIN FOR STORAGE

SECTION 5: GRAIN DRYER MODELS

SECTION 6: ENEMIES OF STORED GRAIN

PART 1: INSECTS

PART 2: RODENTS

SECTION 7: STORAGE METHODS

APPENDICES A - Presentation of Information

B - Moisture Meters

C - Insecticide Use

D - Waterproofing

E - The Volunteer Role

F - Bibliography

CONVERSION TABLES

# What the Sections Contain

## INTRODUCTORY

The Purpose of the Manual; The People Who Prepared This Manual; How To Use This Manual; Reply Form

## SECTION 1: WHAT THIS MANUAL WILL TALK ABOUT: THE GRAIN STORAGE PROBLEM

Introduction; Good Grain Storage Is Important to Farmers; Grain Is a Living Thing; What Happens to Grain in Storage; Good Grain Storage Depends Upon Better Drying and Better Storing; "Good Grain Storage Helps Farmers"; Illustrations

## SECTION 2: GRAIN IS A LIVING THING

Characteristics of Grain and How They Affect Storage; "Grain Is a Living Thing"

## SECTION 3: GRAIN, MOISTURE, AND AIR

What Moisture Is; Moisture in Grain; Moisture in the Air; How Air, Moisture, and Grain Interact; Safe Moisture Levels in Grain; Movement of Moisture in Stored Grain; Where You Are Now

## SECTION 4: PREPARING GRAIN FOR STORAGE

Introduction; Harvesting and Threshing; Cleaning; The Need for Drying; How Drying Happens; Safe Drying Temperatures; Testing Grain for Moisture Content; "Preparing Grain for Storage"

## SECTION 5: GRAIN DRYER MODELS

Sun Drying Using Plastic Sheets; The Improved Maize Drying and Storage Crib; Newer Drying Methods; A Simple Oil Barrel Dryer; Instructions for Using the Oil Barrel Dryers; The Pit Oil Barrel Dryer; Philippines Rice Dryer; Solar Dryers: Part 1: Construction; and Part 2: Operating Instructions

## SECTION 6: ENEMIES OF STORED GRAIN

**PART 1: INSECTS.** What is an Insect?; Insect Life Cycle; How Insects Get Into Grain; Why Insects Infest Grain; Common Grain Pests; Information Sheets on Some Major Stored Grain Insect Pests; Control of Insects in Stored Grain; Controlling Insects Without Insecticides; Checklist; Insect Control with Insecticides; Types of Insecticides; Some Closing Notes; Insecticide Information Sheets; Recommended Insecticides and Dosages; Applying Insecticides; Note to Development Workers; Checklist; Helping Someone Who Has Been Poisoned by Insecticide

**PART 2: RODENTS.** Stored Grain Rodents; Habits and Characteristics of Stored Grain Rodents; Finding Rodents on the Farm; Controlling Rodents Without Using Poison; Controlling Rats With Poison; Rodent Poison Information Sheets; Rat Baffles; "Rodents Are Everywhere"; "Know About Rats"; "Fighting Rats Without Poison"; "Fighting Rats With Poison"; "Fighting Rats With Traps"; Rodent Control Illustrations

## SECTION 7: STORAGE METHODS

Introduction; Feedback; Storage Principles; "Finding a Good Storage Place" & Illustrations; "Cleaning and Repairing Your Storage Place" & Illustrations; Storing Grain in Basket Granaries; Instruction Sheet for Storing Grain in Baskets; Storing Grain in Sacks; Mixing Grain and Insecticides for Sack and Small-Container Storage; Treating Stacks of Bagged Grain -- Recommended Insecticides and Dosages; Storing Grain in Sacks: Summary; Airtight Storage; Storing in Gourds and Baskets; Storing Grain in Underground Pits; Storing Grain in Plastic Sacks, and Illustrations; Storing Grain in Metal Drums; Storing Grain in Metal Bins; Sheet Metal Silo; Fumigation of Small Quantities of Stored Grain: in Plastic Bags; under Plastic Sheets; and in Small Metal Containers or Silos; Storing in Earthen Structures; The Indian Pusa Bin; Improved Mudblock Silo; How to Use Your Mudblock Silo; Ferrocement for Grain Storage; An Overview of Grain Storage Uses for Ferrocement: Thai Ferrocement Silo (Thailo); Ferrocement-lined Underground Pits; and Other Ferrocement Grain Structures; Storing Grain in Cement/Concrete Structures; Brick Grain Storage Silo; The 4.5 Ton Cement Stave Silo; Instructions for Use of the Cement Stave Silo; Concrete Block Square Silos for Cooperative Storage

## APPENDICES

APPENDIX A: Different Ways To Present Grain Storage Information

APPENDIX B: Information on Moisture Meters

APPENDIX C: Material from Guidelines for the Use of Insecticides

APPENDIX D: Waterproofing Methods -- Material from Waterproofing Soil Construction

APPENDIX E: Working Paper on the Volunteer Role in Grain Storage:  
"Problems Related to Popularizing New Farm-level  
Grain Storage Technology"

APPENDIX F: Bibliography: Reprint of Listings Prepared by the  
Tropical Products Institute, London

## CONVERSION TABLES



## THE PURPOSE OF THE MANUAL

This manual brings together knowledge from two different kind of development organizations involved in finding low-cost, appropriate solutions to problems in the Third World--the United States Peace Corps and VITA, Volunteers in Technical Assistance.

The Peace Corps has information to share about grain storage based on the practical field experience of Volunteers living and working at the grass roots level in numerous countries. VITA contributes the technical expertise of its specialists. Too often, it seems, innovative techniques for small farms do not reach the field, and field approaches too often are applied only in the area where they were developed. True, it is good to design a silo which is not too expensive for a farmer to build. It is even better to plan a silo which is cheap and keeps out insects. But of what value is the plan if only a few farmers know about it?...or if other farmers cannot adapt it to suit their needs? It was to bring such plans and new ideas to farmers worldwide that Peace Corps and VITA prepared this manual.

Small Farm Grain Storage is a how-to manual. It is designed as a working and teaching tool for development workers in their field activities. Grain storage information is basic and straightforward; it is presented in a form easily adapted to on-the-job needs. The manual brings together in one volume the basic principles of grain storage and the practical solutions currently being used and tested around the world to combat grain storage problems. Of course, it is impossible in a single publication to cover all the possible storage situations in the world. But farmers who understand the basic, unchanging principles of drying and storing grain can adapt ideas, suggestions, and technologies from another part of the world to their own situations.

This manual is the first of a planned PC/VITA series. Future manuals will focus on such areas of concern as reforestation, fish culture, and wells construction.

## THE PEOPLE WHO PREPARED THIS MANUAL

Small Farm Grain Storage is the first in a planned series of publications combining Peace Corps practical field experience with VITA technical expertise in areas in which development workers have special difficulties finding useful resource materials.

Since 1961 Peace Corps Volunteers have worked at the grass roots level in countries around the world in program areas such as agriculture, public health, and education. Before beginning their two-year assignments, Volunteers are given training in cross-cultural, technical, and language skills. This training helps them to live and work closely with the people of their host countries. It helps them, too, to approach development problems with new ideas that make use of locally available resources and are appropriate to the local cultures.

Recently Peace Corps established an Information Collection & Exchange, so that these ideas developed during service in the field could be made available to the wide range of development workers who might find them useful. Materials from the field are now being collected, reviewed, and classified in the Information Collection & Exchange system. The most useful materials will be shared with the development world. The Information Collection & Exchange provides an important source of field-based research materials for the production of how-to manuals such as Small Farm Grain Storage.

VITA people are specialists who volunteer their free time to answer requests for technical assistance. Many VITA Volunteers have lived and worked in other countries, often as Peace Corps Volunteers. Most VITA people now work in the United States and other developed countries where they are engineers, doctors, scientists, farmers, architects, writers, artists, and so on. But they continue to work with people in other countries through VITA. VITA Volunteers have been providing technical assistance to the Third World for more than 15 years.

Requests for technical assistance come to VITA from many nations. Each request is handled by a Volunteer with the right skills. For example, a question about grain storage in Latin America might be handled by a professor of agriculture, and a request for an improved planting implement would go to an agricultural engineer. These VITA Volunteers, most of whom have lived and worked in Third World countries, are familiar with the special problems of these areas and are able to give useful, and appropriate, answers.

A number of VITA people worked on the Small Farm Grain Storage manual, providing technical review and artwork. Many thanks are due to the skilled and concerned Peace Corps and VITA people, as well as to numerous others, who worked to make this manual possible.

staff assistance -- John Goodell

materials on section 4 -- Frederick Bueche

technical review -- Douglas Barnes, Merle Esmay, Henry Highland,  
Larry Van Fossen, Harold Willson, Kenton Harris

artwork -- George Clark, John Goodell, Kenneth Lloyd, Nicholas Reinhardt,  
Guy Welch

Thanks are also extended to the following individuals and institutions that provided invaluable assistance in the early stages of work on the manual.

Mary Ernsberger and Margot Aronson, Peace Corps Program and Training Journal, USA

Brenda Gates, Peace Corps Information Collection and Exchange, USA

Tropical Stored Products Center, TPI, Great Britain

Henry Barre and Floyd Herum, Agricultural Engineering Department, Ohio State University, USA

Department of Grain Science and Industry, Kansas State University, USA

Agricultural Research Service, Department of Agriculture, USA

Extension Project Implementation Department, Ministry of Agriculture, Ethiopia

F.W. Bennett, Midwest Research Institute, USA

Supervised Agricultural Credit Programs, SACP, Belize

Peter Giles, Nicaragua

Donald Pfalser, Agricultural Cooperatives Development International, ACDI, USA

Technical Assistance Bureau, US Agency for International Development, AID

International Development Research Center, University of Alberta, Canada

League for International Food Education, LIFE, USA

Institut de Recherches Agronomiques Tropicales et des Cultures Vivrieres, IRAT, France

Post-Harvest Crop Protection Project, University of Hawaii, USA

Agricultural Engineering Service, FAO

African Rural Storage Center, IITA, Nigeria

Institute for Agricultural Research, Ahmadu Bello University, Nigeria

Swaziland Rural Grain Storage Project

Jim McDowell, Food Technology and Nutrition Section, UNICEF, Kenya

Gordon Yadcuik, Centre Nationale de Recherches Agronomiques, CNRA, Senegal

R.A. Boxall, Indian Grain Storage Institute, A.P., India

Siribonse Boon-Long, Ministry of Agriculture and Cooperation, Thailand

Asian Institute of Technology, Chulalongkorn University, Thailand

Merrick Lockwood, Bangladesh Agricultural Research Council

International Rice Research Institute, IRRI, Philippines

Dante de Padua, University of Los Banos, Philippines

## HOW TO USE THIS MANUAL

Development workers can use material from this manual in a number of ways:

- . Discussions. The manual provides clear presentations of grain storage principles from which you can take material to lead discussions with farmers and village leaders.
- . Demonstrations. There are suggestions for demonstrations and experiments which you might find helpful to illustrate grain storage principles to farmers.
- . Leaflets. Some of the material has been prepared in the form of illustrated leaflets which can be used directly by you with a farmer. They may require little or no adaptation by you. But, if you prefer, you can use the structure of the leaflet and substitute photographs specific to your area. The material on rodent control is a good example of this kind of leaflet.
- . Construction Plans. Many of the construction plans have been simplified so that you will be able to work more closely with the farmer. Some of the plans are fully illustrated. You could add photographs of the work steps showing conditions in your area. It is likely that after you introduce the material, farmers can follow the instructions themselves. The plans are written so that they would be easy to translate into local languages. The Improved Maize Drying Crib is a good example of a step-by-step, illustrated presentation.
- . Checklists. Some of the material most likely to be useful for small-scale farmers has been simplified and prepared in checklist or hand-out form. This material would lend itself to illustrations or photographs, so it can better fit into the local situation. The checklists on controlling grain storage insect pests are in this category.
- . Examples. The appendices contain examples of leaflets that have been prepared by development workers in several countries. These examples have been included to give you some idea of how the materials in this manual might be organized, illustrated, translated, and presented to reach farmers.
- . Sources. Wherever possible, addresses are given so that you can write for more information on a subject.

- . Further Information. Other appendices contain information on areas which, although important, cannot be covered fully within the scope of this manual, for example, storage program planning.

These are some of the aims of Small Farm Grain Storage. You will probably find added uses. While it is not possible to make this manual specific to the situations or culture of your particular area, the information is presented so that you can do this very easily by making additions or substitutions to the material.

For your convenience, the pages in each part of the manual are numbered independently from those in the other parts. Key information is often included in more than one section so that all the facts needed to discuss a subject can be found easily without searching through the manual. Plans can be removed for copying and reworking to fit your needs.

Dimensions are given in metric units in the text and illustrations. Conversion tables follow Appendix F.

This manual will grow and change as its readers and users send in additional material, comments, and ideas for new approaches to grain storage problems and better ways to communicate with farmers. Your own ideas and conclusions are welcome, and forms have been provided for your comments at several locations in the manual. So, please send in the results of your silo or dryer building. Let us know how you used the manual and how the information could be made even more useful to you. Tell us how you changed a plan to fit local needs.

Your experience will help us to produce manuals of growing usefulness to the world-wide development community.

## REPLY FORM

For your convenience, a reply form has been provided here. Please send it in and let us know how the manual has helped or can be made more helpful. If the reply form is missing from your copy of the manual, just put your comments, suggestions, descriptions of problems, etc., on a piece of paper and send them to:

GRAIN STORAGE  
3706 RHODE ISLAND AVENUE  
MT. RAINIER, MD 20822  
U.S.A.

PLEASE RETURN THIS FORM

NOTE TO THE USER: This manual was published because Peace Corps and VITA people wish to help in a problem area of worldwide concern. In order to provide the most effective help, the authors need to know how the manual is being used and how you feel it can be made even more responsive to your needs. Please fill in the following form and return it to:

GRAIN STORAGE  
3706 RHODE ISLAND AVENUE  
MT. RAINIER, MD 20822  
U.S.A.

WHEN WE RECEIVE THIS FORM, WE WILL AUTOMATICALLY PLACE YOUR NAME ON A MAILING LIST SO THAT YOU WILL RECEIVE:

1. Updates and/or additions and corrections to the manual as they become available.
2. Notice of other publications which may be of interest to you.

If you have questions on the material presented in the manual, or if you run into problems implementing the suggestions offered here, please note them in the space provided. Use additional paper if you have to in order to be as specific as you can about the problem. Wherever possible, the authors will try to provide or direct you to an answer.

-----

Date \_\_\_\_\_

Your Name \_\_\_\_\_ Your Company or  
Agency, if any \_\_\_\_\_

Your Address \_\_\_\_\_  
\_\_\_\_\_

1. How did you find out about the PC/VITA Grain Storage Manual? How did you get your copy?
2. Which parts of the Grain Storage Manual have you found most useful? Least useful? Why?

3. Did you find the Manual easy to read, too simple or complex, complete or incomplete?
  
4. How has this manual helped your work? What have you done to apply the information?
  
5. Which plans have you used? Did you make changes in any of the plans? (For example, when you were building a dryer or a silo, did you substitute any building materials for the ones mentioned in the plans?) If you made changes, please describe what you did that was different. Include photos, sketches, etc., if possible or important.
  
6. Can you recommend additional methods or equipment which you feel should be included in a new edition of the Manual? If you do know of such methods, etc., please include the information here.
  
7. What were your successes using the Manual or implementing any of the plans? Problems? Please describe any successes or problems completely.
  
8. Do you have other recommendations for following editions of this Manual?

## WHAT THIS MANUAL WILL TALK ABOUT: THE GRAIN STORAGE PROBLEM

### INTRODUCTION

Farmers all over the world lose much of their grain after it is harvested. Farmers work hard to plant and grow crops. And often they do not receive good returns for their time and effort. The grain is attacked in the field and in storage by insects, rodents, birds, and other pests. The grain that pests do not eat, they make dirty with their droppings and their bodies.

Farmers have lived with these problems for hundreds of years. So they have developed ways to deal with them. Many old ways are wasteful, but a number of the old methods are good and must be kept until they can be replaced or improved.

In recent years, however, the grain storage problem has changed (and, in some cases, temporarily worsened) as steps toward full development have been taken. For example, now there are new seed varieties which grow faster and yield more grain. Farmers plant these new seeds, and this grain is ready for harvesting earlier than it used to be. This grain is ready to be harvested during the rainy season. The farmer has always dried his crops in the sun, but there may be little sun during this season. Also, it is likely this new variety of grain must not be left to dry in the field: if this grain dries too long in the field, it will shatter (break). But if the farmer brings the grain from the field and stores it before bringing the moisture content of the grain down to 13% or lower, the grain will rot and mold.

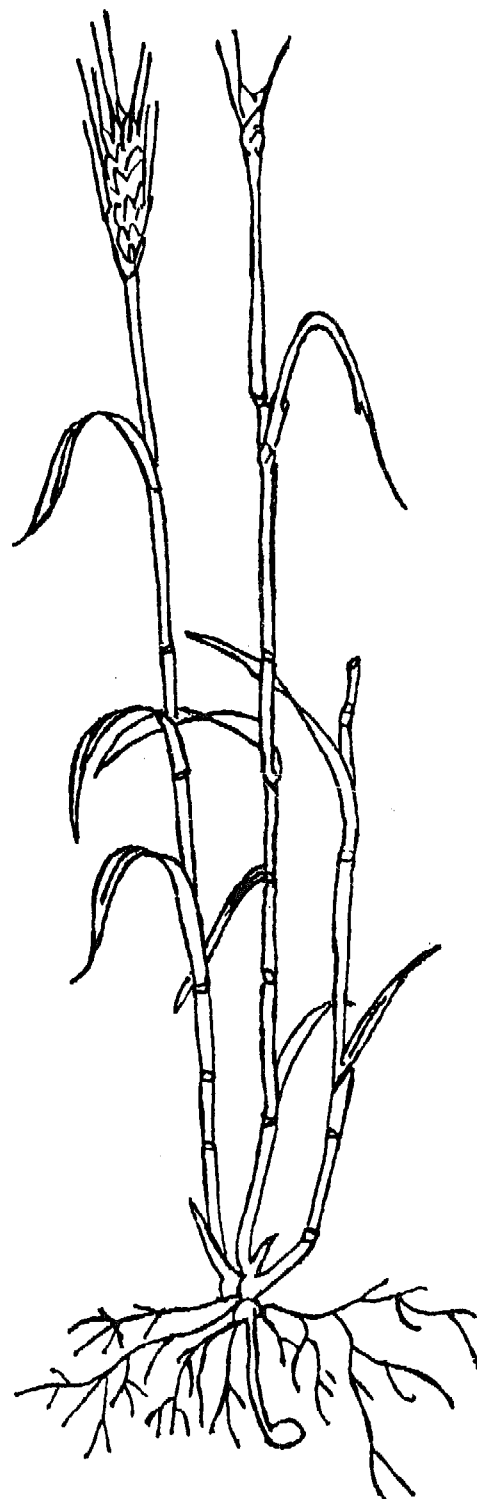



## The Problem

The basic question then is how to help farmers protect their grain from attack. The answer must be to give the farmer enough information about harvesting, drying, storing, insects, rodents, and molds so that he can fight the problems successfully. No one can find answers to problems without having enough information about the subject.

Farmers need to know that there are steps they can take to protect their own grain. Perhaps a farmer can save significant quantities of grain by making a simple change in the way he is doing things now. Perhaps there is another way of drying or of storing which fits into his situation well. A farmer needs to be presented with ideas that can be demonstrated, that make sense to him, and that fit into his life easily. This is done by supplying technology and help which is appropriate. With this kind of help, change for the better is more likely to take place.

The following chapters offer many ideas about the grain storage problem. The materials have been prepared to make them easier for you to use in your work. The manual should help you get information to those farmers who most need it.

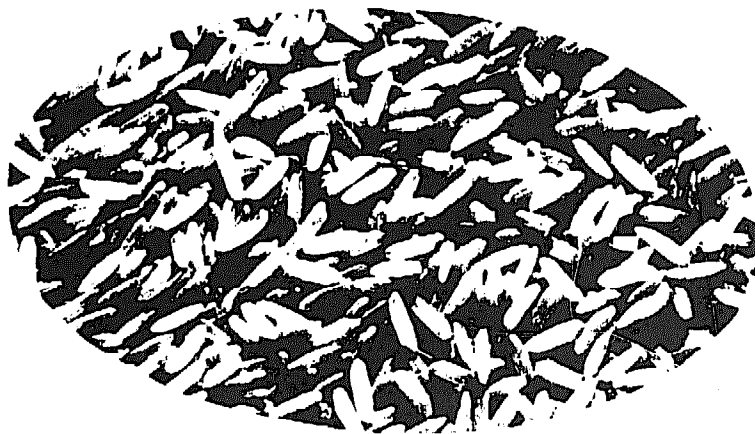

## GOOD GRAIN STORAGE IS IMPORTANT TO FARMERS

When people in universities and government agencies talk about storage, they are discussing a serious subject. They talk about such facts as these:

- . Approximately 30% of grain in storage all over the world is being lost because of insects, rodents, and molds.
- . improving grain storage would mean a higher standard of living, less hunger, improved nutrition for the individual, and a sounder economy for the nation.
- . quality grain for international trade is of increasing importance.
- . improper storage of grain leads to weight loss, monetary loss, seed loss, quality loss, food loss.

These concerns are real. And there is a definite need for people to deal with grain storage questions at this level. Many new ideas and plans result from the testing, thinking, and planning being done all over the world by scientists, teachers, and researchers.

But when small farmers talk about grain storage problems, they are talking about their livelihood. And there are some very important reasons why grain storage questions are of concern to them.

### Food for the Family

Grain is very likely the single most important thing eaten by the farmer and his family. Whether it is maize, wheat, rice, millet, or sorghum, it is important for his family. The farmer may not think about grain losses and use words like quality and quantity. But he can see that insects, rodents, and molds ruin a lot of his grain, and that there is not as much for his family to eat. He can taste the difference between clean grain and grain which has been damaged by mold. Farmers feel the loss of grain and the need for better storage when they run out of grain for food before the next harvest. Then they must use what little money they have to buy food. Or they must borrow against the next crop and start out in debt.



## Storage Problem -4-

Another food loss is harder to measure. But it is real. Some insects eat out the best parts of the grain. These are the parts which contain the vitamins and minerals which make grain the healthy food it is. The farmer may not see this loss. But he should be told about it. Lack of nutritious food can lead to sickness and more problems.

### Seed for Planting

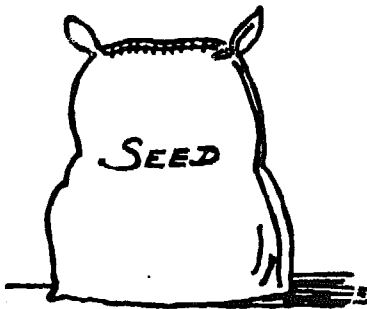

Part of the harvested grain is the seed for the next crop. The farmer must let the seeds rest in a cool, dry place before he plants them. Poor storage of seed grain means that some of the seeds, or many of them, will not germinate (grow) when they are planted. If the seeds are not stored well, the farmer will have to plant many extra seeds to get enough plants. Often seed grains that have not been stored well do not grow well: they may grow at different speeds. This causes problems with cultivating and harvesting the grain.

### Money to Fill Needs

A farmer usually must buy some of the tools and equipment he needs for home and farm use. He may need to purchase corrugated metal sheets for building, metal pots for cooking, metal tools for farming, or cloth for making clothes. To get items which he cannot make himself, the farmer has to offer money, or he has to barter. Most farmers sell the grain they do not use for food or seed to get money. Or they trade the grain for the things they need.

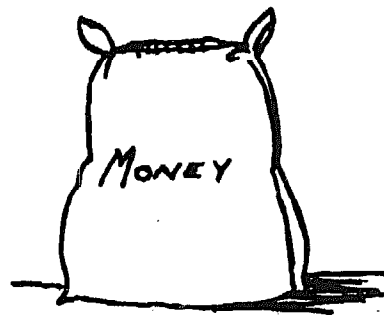

Because of poor drying and storage facilities, farmers cannot keep their grain safely for any period of time. They are forced to sell the grain soon after harvest. The prices are low at this time because no one needs grain. Everyone is harvesting, and there is plenty of grain available. Until the farmer can dry and store his grain safely, he is not going to grow much more than he needs for his family. This lack of safe storage means that total production of grain remains low.

Most farmers will not think in terms of country-wide production. But they will have in mind some things they would like to do if they had more money. Good grain storage can lead to more food, more money, better seed, and a better future.

## GRAIN IS A LIVING THING

Grain has certain characteristics which farmers must understand if they are to be able to dry and store their grain well. Here are some of the characteristics of grain which will be discussed:

- . Growth of seed grain.
- . Protection of the kernel by the seed coat.
- . Respiration (breathing) of grain kernels.
- . Moisture (water) in grain kernels.
- . Moisture movement between grain and air.

Farmers know a lot about planting and growing grain. But most farmers will not think about grain in all the ways listed above. If they do become aware of these characteristics of grain, the reasons for good grain storage are going to make a lot more sense to them. And farmers are going to be able to do more toward solving their own problems.

## WHAT HAPPENS TO GRAIN IN STORAGE

Keeping grain safe in storage depends upon a number of things. Moisture, temperature, insects, and molds, for example, all can cause changes in grain put into storage. All factors which are most important to good grain storage are presented in the following paragraphs; some are discussed in greater detail in other places in the manual. REMEMBER: all of the following points are related to one another.



## Insects

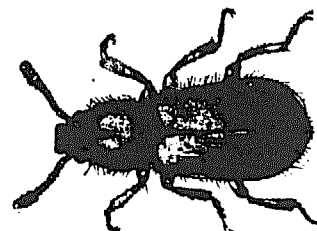
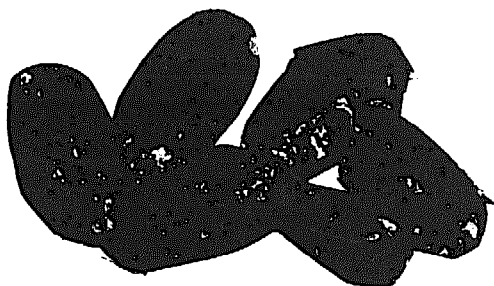

Insects and their part in grain storage are the subject of another section. It is an important section. Insects eat and ruin a lot of grain. Because they grow inside the grain kernels, some insects are not found in grain until after they have done a lot of damage. The section on insects will give information on the major grain storage insects, on where to look for them, and on how to control them.

Insect activity, and the damage which results from this activity, is closely related to temperature and moisture in stored grain. It only takes a few insects in the right conditions -- for example, in warm, moist grain -- to make enough moisture and heat so that large numbers of insects can grow. More insects will make more heat and water, and so on. They create the right conditions for the growth of molds.

## Molds

Molds are very small plants. They are so small they cannot be seen on grain, but they are always there on the grain kernels. In warm, moist grain, they will germinate (grow) and produce threads called hyphae. These hyphae push through the seed coats of grain kernels and attack the embryos of the grains. Molds cause damage in a number of ways:

- . They produce chemicals called enzymes which can stop seeds from germinating and growing into new plants.
- . They decrease the quality of the grain for food and for market.
- . Some molds produce chemicals which can poison people.

Farmers certainly are familiar with the sight and smell of grain damaged by mold. But they are probably not aware of the conditions that lead to molding, and they may not know what they can do to protect their grain from mold. Helpful information and suggestions are presented later.

### Moisture Content (Wetness)

Drying grain, and keeping it dry in storage, is the most important part of good storage. Many problems of grain storage are caused by moisture. Both grain and air have moisture, and they act together in ways that are important to understand. Therefore, a following section discusses moisture content in grain and in the air; it also explains how moisture in grain and moisture in the air are important to each other.



### Temperature

There are two temperatures which are important. One is the outside temperature of the air; the other is the temperature of the air and grain in the storage place.

It is easier to store grain in areas where the air temperature is low or never gets too hot. In very cold weather, insects and molds do not grow very quickly, or at all. Seeds do not breathe as much.

In warm places, the grain is warm when it is put into storage. Then, as the outside temperatures go up, the temperature in stored grain is likely to get even higher. When the temperature in the grain goes up, certain things start happening:

- . Insects start growing and breeding.
- . Mold spores start multiplying.
- . Molds, insects, and grains all live and breathe faster, causing heat, water, and carbon dioxide to increase in the stored grain.

Even in this brief look at temperature, it is easy to see the need for keeping grain cool and dry. Keeping storage containers protected from the hot sun is important. Farmers who understand this fact have discovered an important grain storage principle.

### Rodents

Rats and mice eat a lot of grain. They can eat the whole kernels of grain sorghum, wheat, and millet. They chew on ears of maize. Rodent damage is the easiest kind of damage to see. Yet farmers may not realize how much damage rodents can do; they may not be aware that rodents spread diseases. Or they may not know what they can do to stop rodents from eating their stored grain. The section on rodents gives information on the habits of rodents, the signs of rodents that a farmer should look for, and some ideas for keeping rodents out of stored grain.

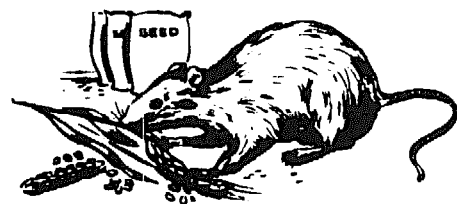

### Clean Grain and Clean Storage Places

Farmers often do not realize how important it is to clean the place for storing grain. Even grain that is healthy and whole when put into storage can be damaged by insects or ruined by molds if stored incorrectly. Farmers need to know that good grain storage requires planning for a good storage container or place, and careful handling and cleaning of the grain.

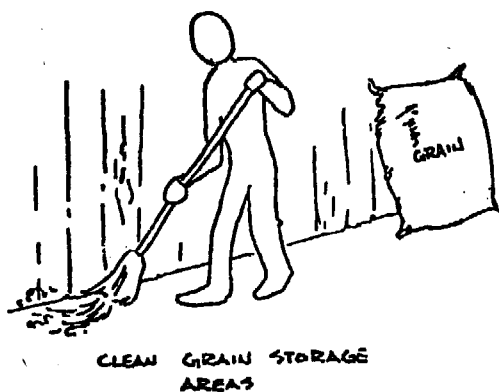

Many farmers can improve the condition of their stored grain simply by cleaning and repairing their present grain storage containers and buildings, and by putting only healthy grain into storage. This manual helps spell out the necessary steps for farmers who wish to improve, (1) the quality of the grain they store, and (2) the container into which they put the grain.

GOOD GRAIN STORAGE DEPENDS UPON BETTER DRYING AND BETTER STORING

### Improved Drying

As mentioned before, drying is the key to storing grain safely. The section on "Preparing Grain for Storage" covers the importance of careful harvesting, threshing, and moisture measurement before putting the grain into storage. "Grain Dryer Models" presents plans for a number of grain drying methods.

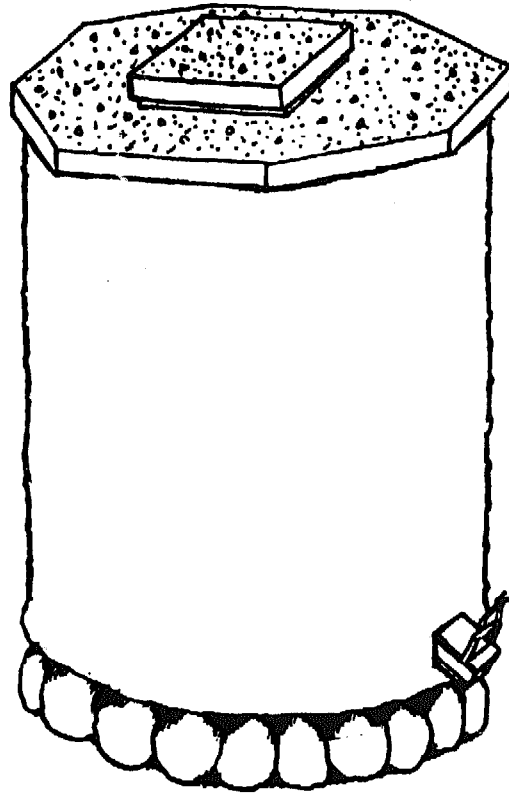

*The improved  
mudblock silo*

### Improved Storing

The manual section on storage discusses methods already being used by farmers, and gives ideas for improving these methods. Also, the section provides plans and construction procedures for a number of grain bins. Each of the storage methods is presented in terms of its possible advantages and disadvantages for use by farmers.

### Your Role

You will have to decide how to use the materials in this manual. Some farmers may be ready to make a mud silo; others require information on good storage practices for storing grain in sacks. One village may be ready to make an oil barrel dryer. Another village might like to try solar dryers. These are decisions which you and the farmers in your area must make together. The purpose here simply is to provide information upon which good decisions can be made, and to provide some basic guidelines in important grain storage areas.

The following leaflet provides an illustrated look at what good grain storage can do for farmers.



## GOOD GRAIN STORAGE HELPS FARMERS

**Suggested Uses:** This is a script which could be used to alert farmers to the need for improved storage. Choose the points you feel are most important and have them translated and illustrated as necessary.

- . A good crop of grain means plenty of food.
- . Farmers work hard to grow their grain. Grain is important.
- . A good crop means seed for planting the next crop.
- . A good crop means you can buy things for your family and farm.
- . But you must have a good place to keep your grain after the harvest. You cannot use all the grain right away.
- . It is not good to sell grain right after harvest. The price for grain is lower at harvest time because more grain is available than at other times of the year.
- . You cannot eat all the grain. You will want some later.
- . Seed grain must be stored safely until planting time.
- . A good grain storage place is a place to keep grain safe until you want to sell it, to eat it, or to plant it.
- . There are many ways to store grain. Some farmers store grain in sacks. Some farmers store grain in clay jars and in the rafters of their homes. Some farmers store grain in special buildings.
- . All grain storage places must protect the grain from insects, mice, rats, and other pests.
- . Rats and mice enter open grain storage places easily. They can eat and spoil a lot of grain every day.
- . Birds and chickens like to eat grain too.
- . Many insects attack stored grain.
- . Insects get into grain very easily. Some of them can fly, and some begin eating the grain in the field before harvest.

## *Storage Problem -12-*

- . Insects lay many eggs. These insects eat and spoil a lot of your grain.
- . Insects, rats, and mice eat so much grain that soon there is less for you to sell and eat.
- . Insects and rats put the droppings from their bodies on the grain while they are eating. This makes the grain dirty. You cannot make as much money when you sell this grain.
- . People get sick from eating grain which rats and insects have put droppings on.
- . Molds also attack stored grain.
- . Molds are tiny plants. You cannot see these plants. Mold plants float in the air and need warmth and moisture to grow. Mold plants usually are on stored grain even though you cannot see them.
- . Molds give grain a bad smell and change the color of the grain.
- . Molds like to grow in warm, wet storage places, so you must keep grain cool and dry.
- . People can get sick if they eat grain with mold on it.
- . It is important to keep insects, rats, molds, and other dangers away from your stored grain. Good grain storage means more money and more food.
- . Your extension worker can help you with grain storage problems. He knows how you can fight insects, rats dangers. He will have ideas on ways you can improve your grain storage.

Storage Problem 13-

The following pictures show how one artist has chosen to present the subject, "Good Grain Storage Helps Farmers." As you can see, he has chosen a certain number of important ideas from the scripts and highlighted them using pictures. Perhaps these pictures will provide you with ideas for illustrating your own leaflets.

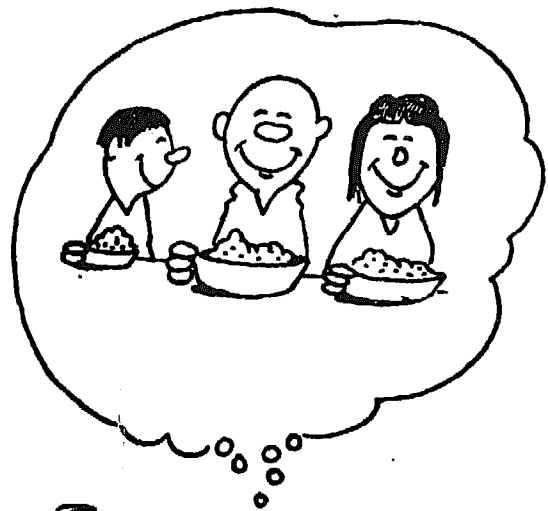

Storage Problem-14-

WHAT AM I GOING TO DO TO PROTECT MY GRAIN SO WE WILL HAVE ENOUGH TO EAT FOR THE REST OF THE YEAR?

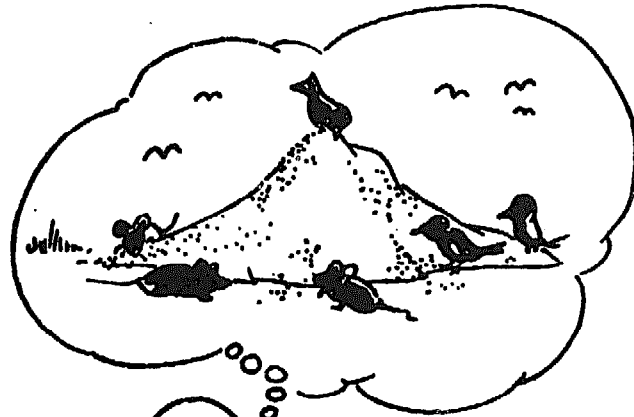
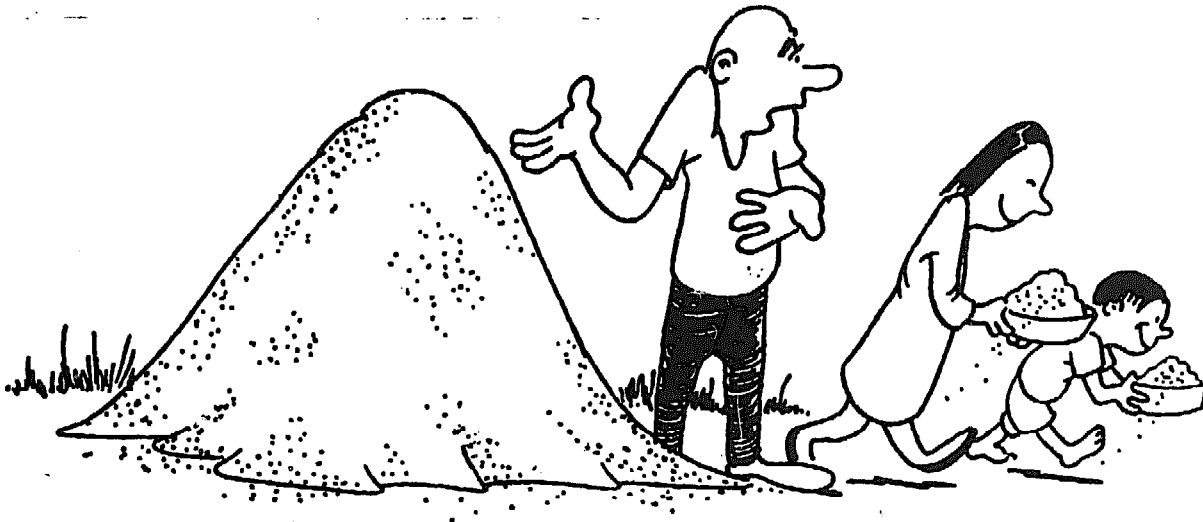

I AM AFRAID THAT RODENTS AND BIRDS WILL ATTACK MY GRAIN.

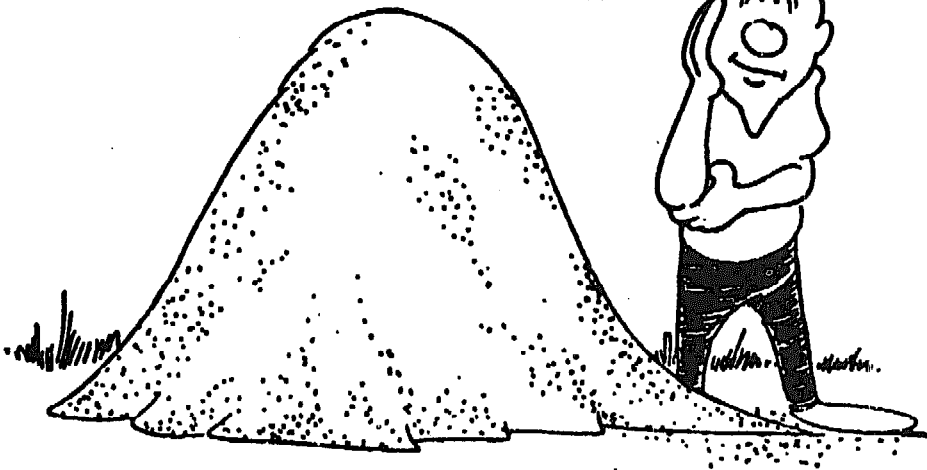

THE RODENTS, BIRDS, AND INSECTS LIKE THE FARMER'S GRAIN VERY MUCH.



NOW WE NEED MORE GRAIN FOR FOOD,  
AND IT HAS BEEN EATEN BY RATS AND BIRDS.



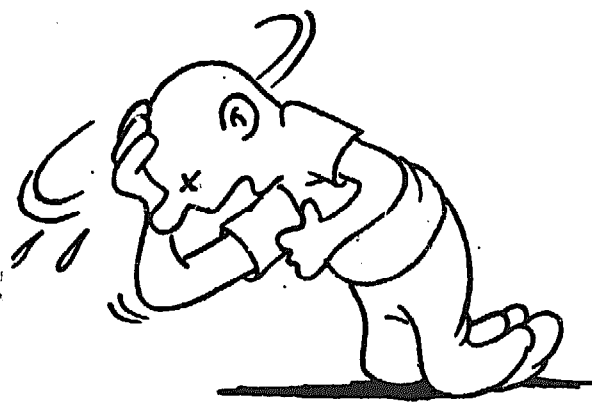
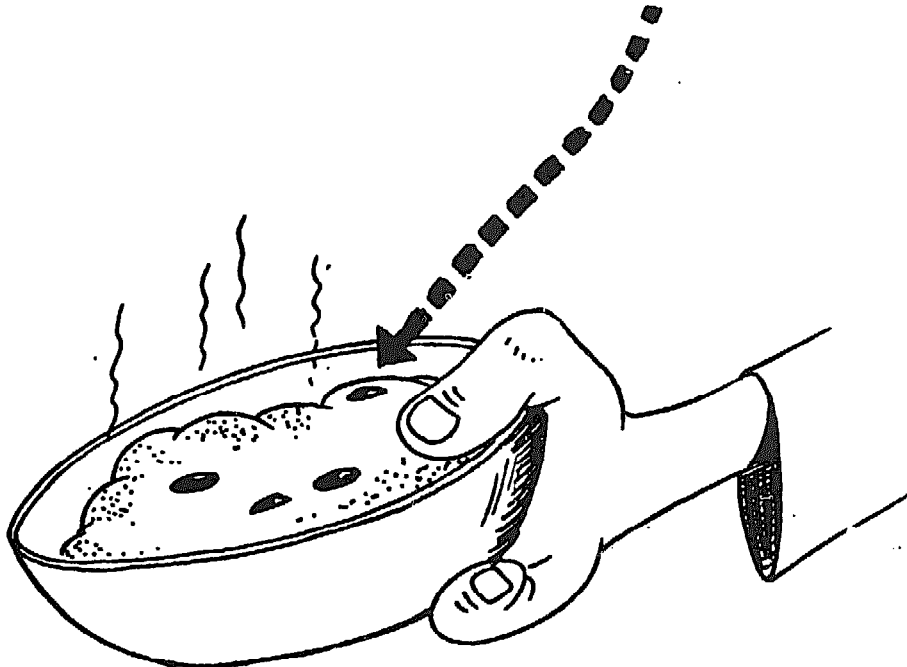

THE GRAIN LEFT BY THE RODENTS AND OTHER PESTS IS DIRTY FROM THE PESTS' BODIES. YOU CAN GET SICK FROM EATING THIS DIRTY GRAIN.

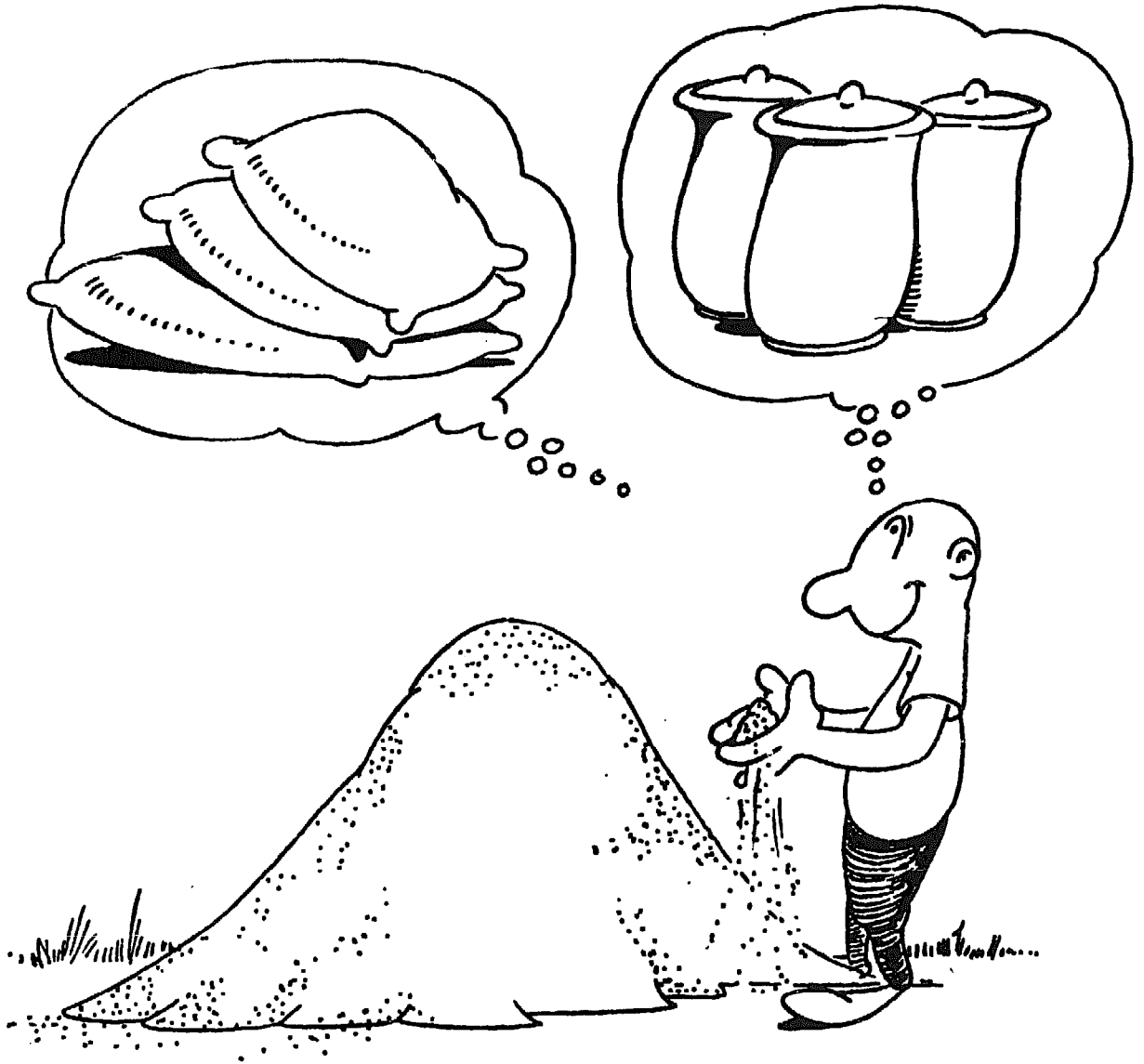

MAYBE I SHOULD PUT THIS GRAIN INTO A GOOD STORAGE PLACE. I COULD STORE THE GRAIN IN SACKS. OR MAYBE I SHOULD STORE IT IN JARS.

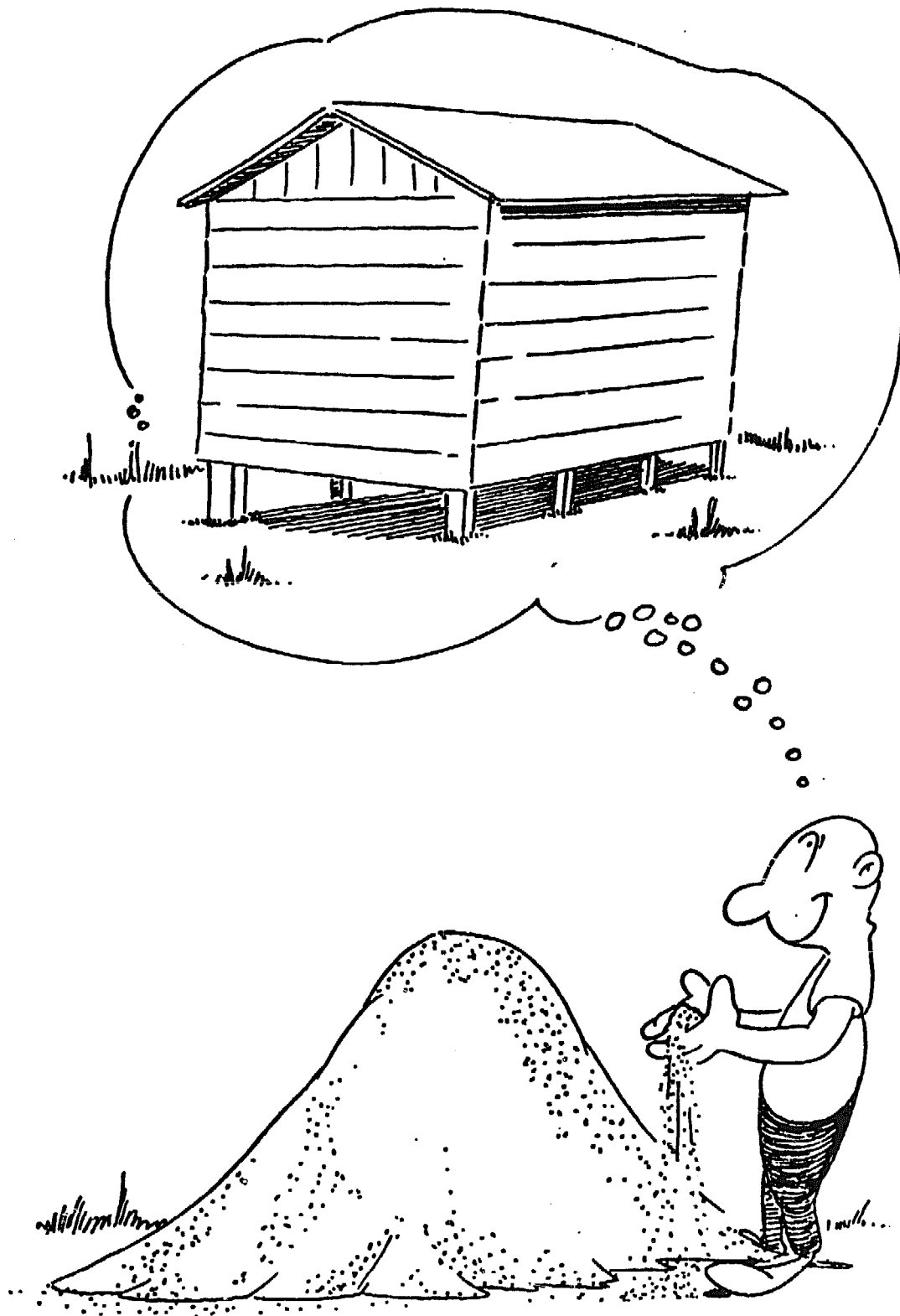

MAYBE I WILL BUILD A SPECIAL BUILDING FOR STORING MY GRAIN. THIS TIME I WILL PROTECT MY GRAIN FROM INSECTS, RODENTS, BIRDS, AND OTHER PESTS.



## GRAIN IS A LIVING THING

### The Structure of Grain

Grain kernels are living things. Grain which will be used for seed must be kept alive. Living seeds also store better.

Maize, rice, sorghum, wheat, millet, and so on, are all cereal grains which belong to the same grain family. As you know, these grains do not look alike. Maize is a large kernel with a triangular shape; it has a hard coat and a large, oily germ which is easy to see on one end of the kernel. Sorghum, on the other hand, is a round seed in a brittle or leathery seed coat. The germ is very hard to see.

Although they look different, the grains all share three basic parts: the seed coat; the endosperm; the embryo (germ).

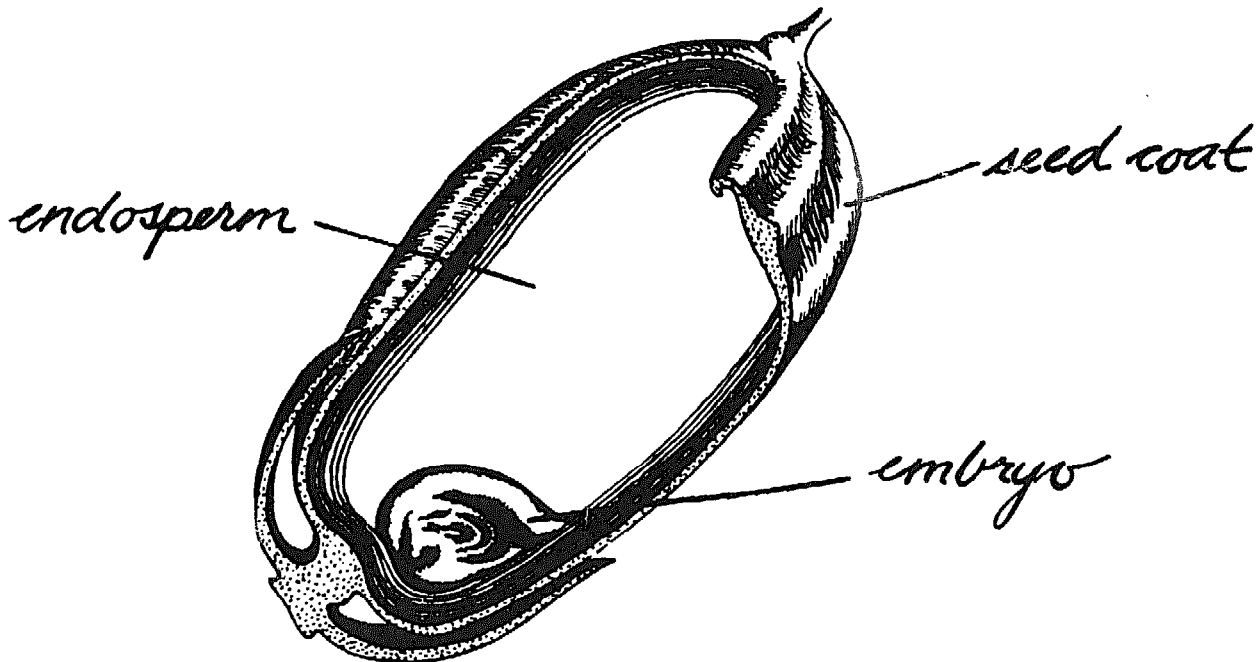

A RICE KERNEL

### The Seed Coat

- . Surrounds the embryo and the endosperm.
- . Protects the grain from attack by certain insects if it is dry and un-cracked.
- . Cannot keep out molds and some insects. Those insects which attack the embryo are most dangerous because the seed coat at the embryo is weak.

### The Endosperm

- . Takes up the largest part of the seed. It is 80% of the kernel volume in most grains.
- . Is the seed's food storage place. It is mostly starch and protein.
- . Provides food for the developing seed when planted and food for the seed in storage.
- . Provides food for farmers and others if the seed is not planted.

### The Embryo

- . Is the part of the seed which can develop into a new plant.
- . Contains most of the protein, fat, and vitamins of the grain.
- . Is attacked easily by some insects and by molds. Seed grain which is attacked will not grow into strong plants or will not grow at all. Food grains without embryos do not provide as much nutrition as grains with embryos.

## CHARACTERISTICS OF GRAIN AND HOW THEY AFFECT STORAGE

Healthy grain can be kept in storage longer than grain which is broken. The threshing methods used by farmers often damage many of the grains. If the grain is to be threshed before it is stored, the threshing must be done very carefully. Careful handling of the grains helps the grain protect itself from danger. Here are examples of ways in which healthy grains are protected by their structures:

Paddy grain  
with husk



- . The husks on maize cobs protect the grain from damage during harvesting and drying.
- . The hulls on rice kernels protect that grain from attack by most insects.
- . A hard, dry seed coat with no cracks or splits in it prevents molds and insects from getting into the kernel easily.
- . The endosperm of dry grain is hard and is not as easily attacked by insects.

Stored rice or wheat or maize, etc., act in one way or another because each has certain characteristics which are affected by the ways it is stored. A farmer should know the characteristics of the particular grain he is storing.

Because there are many kinds of grain, this manual can not talk a lot about each. Here it is most important to point out that the structure of the grain (the way it is made) plays an important part in what does or does not happen to that grain in storage. The structure of the grain affects the length of time the grain can be stored and what kind of storage container it should be put into. You may want to prepare materials for the farmers in your area which talk directly about the structures of the grains they grow and which storage containers are best for their grain.

## Respiration

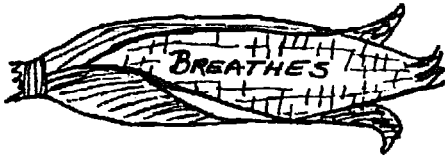

Grain breathes. Each kernel gets oxygen from the air and burns food from its endosperm. This process gives off heat and carbon dioxide. This process in grain is called respiration. Respiration is faster

or slower depending upon the temperature and moisture in the grain. Respiration is slow when grain is cool and dry. There is only enough respiration to keep the embryo of the grain alive. This process can continue in storage for a long time if the embryo is not attacked by mold, insects, or high temperatures. Slow respiration is important for storage. Growth does not happen at this low respiration level, but seed life continues.

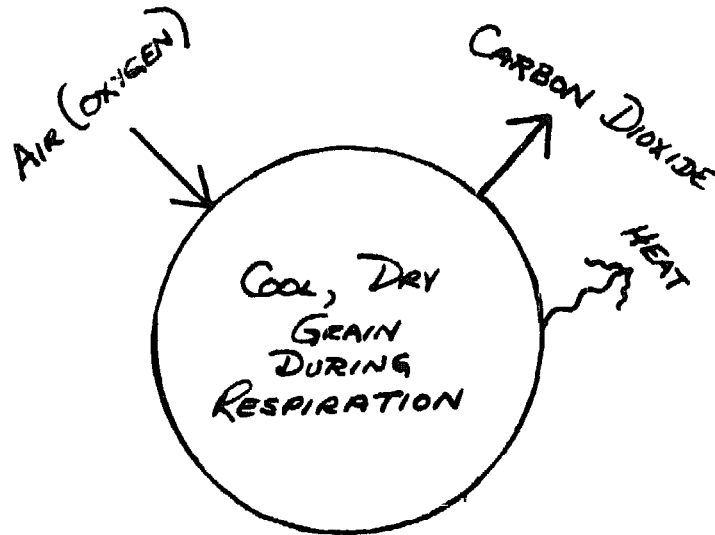

If the stored grain has too much moisture or heat in it, the grain begins to respire faster. When seed grain is planted, for example, it germinates (grows) because respiration has been speeded by water in the ground and the warmth of the soil.

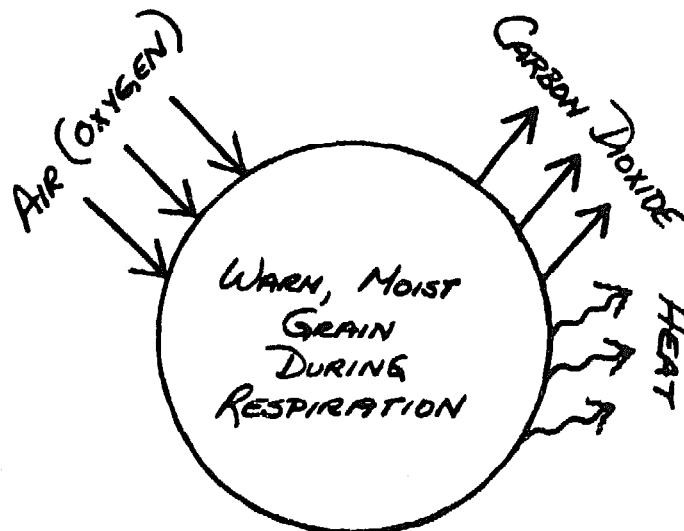

The way that grain, moisture, and temperature work together is important for farmers to understand. Grain put into storage with a lot of moisture in it breathes much faster than dry grain does. This moist grain makes more heat and creates conditions leading to mold growth and insect attack. The farmer who understands this will see the need for storing cool, dry grain.

### Heat Producing and Heat Holding



Grain produces heat during respiration. If the grain is cool and dry, it respirees very slowly and the amount of heat it makes is very small. But if respiration gets faster for some reason, grain makes more and more heat. Spots of hot air form inside the storage container because the stored grains hold the heat.

The temperature outside the storage container does not have an immediate effect on the grain in large silos, but it can be a problem for the farmer who has a small metal storage bin which stands by his front door and faces the sun for some hours each day. The heat from the sun warms the bin, and this warming spreads to the grain inside. Any insects and molds present in the grain will grow much more quickly.

### Moisture

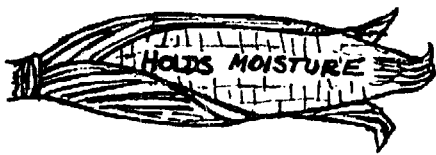

All harvested grain holds a certain amount of moisture. Most of the moisture is inside the kernel; if the grain is very wet, some of the moisture is around the outside of the kernel. Farmers must dry the grain down until it only holds about 12-13% moisture if they are to store grain safely. Since moisture and drying are so important, they are discussed more fully in another section.

Grain has other characteristics, such as flow and pressure. These are subjects not particularly important to a small-scale farmer. Mainly he needs to know what the grain looks like inside and what there is about grain that makes it act in certain ways in storage.

## GRAIN IS A LIVING THING

Suggested Uses: Select points as needed. Translate and illustrate them for distribution to farmers in your area.

- . Each kernel of grain is a living thing. Each grain is a seed.
- . A seed can grow into a new plant just like the one it came from.
- . Most of the seed is food around a tiny part of the seed called the embryo. Some people call the embryo the germ of the seed.
- . This embryo is the part of the seed that will grow into a new plant.
- . One part of the embryo will be the part of the plant that grows above the ground. This top is called the shoot.
- . The other part of the embryo will grow and become the bottom of the plant. This is the part of the plant that grows under the ground. It is called the root.
- . There is a seed coat around the food and embryo. This coat protects the grain from being hurt. Careful harvesting, threshing, and storing will protect the seed coat.
- . While they rest, seeds breathe and use the food that is inside them.
- . Seeds stay alive and are good for planting and selling if they rest in places which are cool and dry.
- . A good grain storage place must be cool and dry. It must protect the grain from insects and other dangers.
- . Do not use high heat to dry the grain you are saving to plant with. High heat will kill the embryo.
- . Store your seed grain separately from the grain you plan to sell or to use for food.

*A Living Thing -8-*

- . Check the grain often. Make sure it is dry. Do not let it get too warm. Make sure there are no insects in it. Smell it to see if molds are present.
- . Good storage of your seed crop means the next crop will be a good crop. The living grain will grow into a new plant when you put it into the earth.

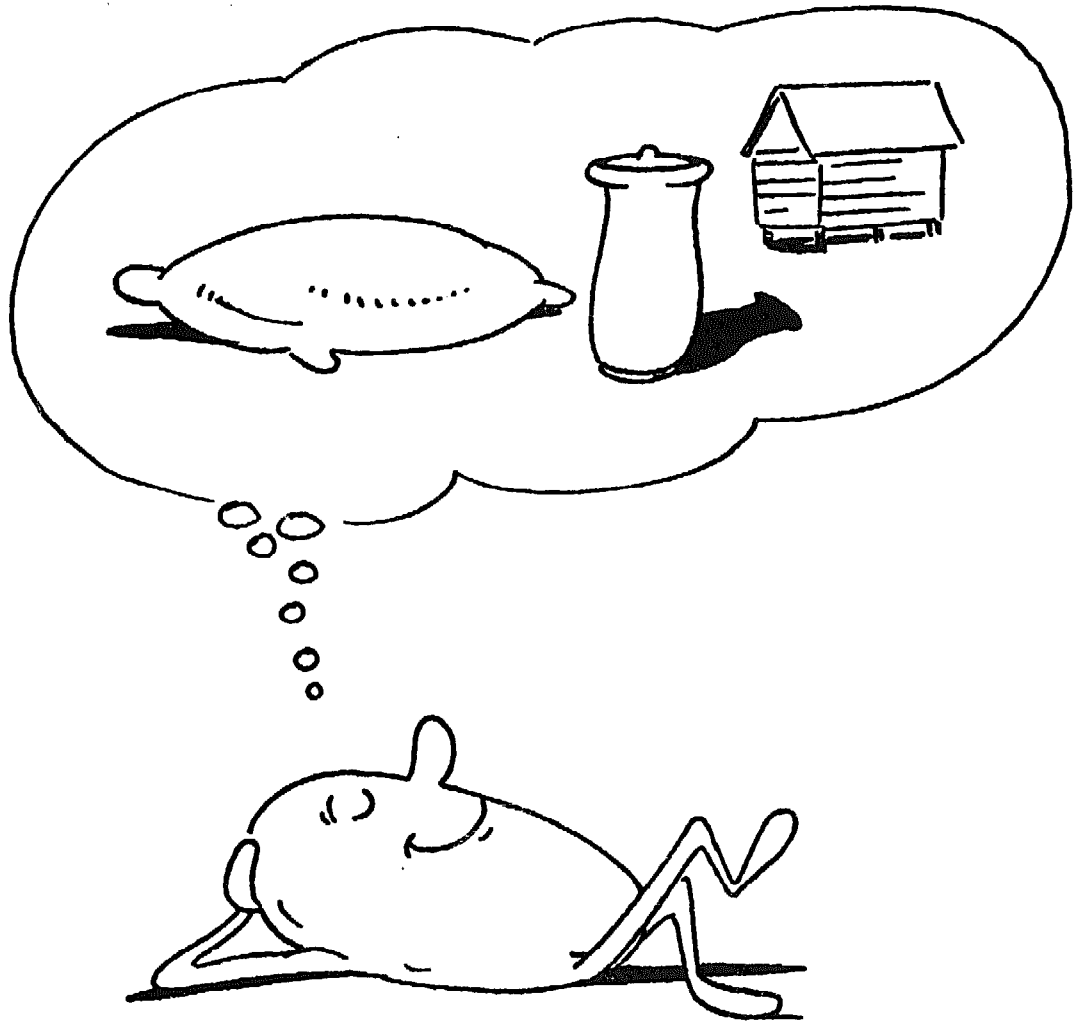

## GRAIN, MOISTURE, AND AIR

### WHAT MOISTURE IS

Moisture is water or wetness. But moisture is a better word to use when talking about grain storage. When farmers use the word water, they are likely to think of lakes, rivers, wells, or containers of water. They think of water as a liquid which is very easy to see and to measure.

A farmer is not as familiar with the word moisture. Moisture is a good word because it can describe something which is wet or contains water without looking wet. For example, the earth can have moisture and not look wet. A plant does not look wet, but when you crush it, you will feel moisture (wetness) on your hand.

### MOISTURE IN GRAIN

Each kernel of grain has moisture inside. But the grain kernel does not look wet when you look at it. The farmer can tell if it is wet by cracking it between his teeth. Wet grain is not hard because the water inside is wetting the seed and keeping it soft, just like pouring water on hard earth makes the dirt soft. When the moisture leaves the grain during drying, the grain becomes harder. The dryer the grain, the harder it becomes.

*Moisture  
in grain is water but it's  
hard to see*

Grains hold different amounts of water at different times: the amount of moisture in harvested grain depends mostly on the time of the harvest. For example, grain harvested in the rainy season may have more moisture than grain harvested in dry, sunny weather.



It is important to note that some grains must contain more moisture than others when harvested, if they are to be harvested safely. This is true, for instance, of new varieties of rice. This rice must be harvested before it gets too dry, or much of the rice will shatter or fall off the stalks. Both maize and rice can be harvested when the moisture content in the kernels is in the 20% range. However, maize can be left in the field to dry further before harvesting. Rice must be harvested right away and not be allowed to dry in the field.

### MOISTURE IN THE AIR

Air contains moisture also. Of course, the farmer cannot see this kind of wetness when he looks at the air, because the moisture in the air is in the form of vapor.

*Moisture in the air is vapor and it's hard to see*

Just as grains hold different amounts of water, air holds different amounts of water. Warm air can hold more moisture than cool air.

On a very hot day, there can be a lot of moisture in the air. When evening comes and the temperature goes down (decreases), the air, now cooler, cannot hold all the moisture it held when it was warmer. So the extra moisture falls out of the air and lands on the earth. This moisture from the air is the dew seen in the cool early morning.

As the sun gets higher during the day, the air temperature goes up (increases). The air, now warmer, can hold more moisture. So the dew on the land is taken up by the air.

*Water vapor is drawn off the land by heat energy of the sun*

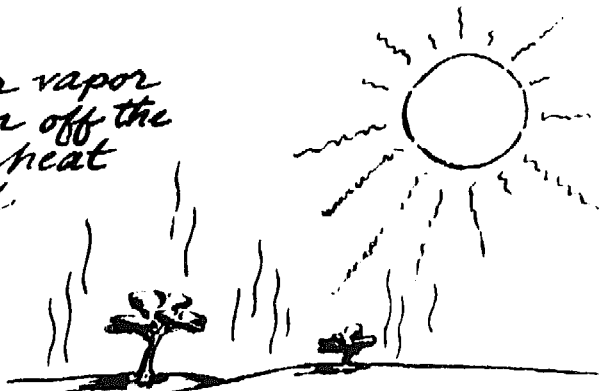

## Relative Humidity

Most farmers will not be familiar with words such as relative humidity. Nor do they really have to be. It is not important to most farmers to understand that relative humidity is a percentage measurement of the amount of moisture actually in the air as compared to the maximum amount of moisture that air at that temperature could hold. Nor do most farmers need to understand that if the moisture content in the air remains the same and the air temperature goes up, the relative humidity goes down. Relative humidity is a meaningful phrase only to those who can measure it and apply the knowledge to drying times, etc.

Most farmers do not have instruments which measure relative humidity. But they have good information if they understand two facts about air and moisture:

1. Warm air can hold more moisture than cold air can.
2. Air at any temperature does not always hold as much moisture as it possibly can. The amount it actually holds changes. When air holds as much water as it possibly can (100% relative humidity), rain is likely.

## HOW AIR, MOISTURE, AND GRAIN INTERACT

Scientists say that grain is hygroscopic because it loses or gains (adds) moisture from the air around it. At this point, it would be easy to get involved in a long discussion of moisture and vapor pressure. For example:

Since all things containing moisture have pressure, grain and air have pressure. Grain dries in the sun because moisture vapor is moving from higher pressure in the wet grain to lower pressure in the air, until the grain and the air reach equilibrium vapor pressure.

This can be explained somewhat more simply by saying that two things containing water will push that water back and forth until a balance is reached. The more moisture there is, the harder the moisture can push. That is, if there is comparatively more moisture in the grain than there is in the air around the grain, the moisture in the grain will push out into the air.

The key to the drying process, then, is placing grain in the sun or in a drying machine so that the kernels of grain can be touched by warm moving air which has less moisture in it

than the grain has. The heat in the moving air will make the moisture in the grain evaporate. The moisture will become water vapor and be absorbed and carried away by the moving air.

It is useful for a farmer to know that drying continues only as long as the air around the grain is able to absorb more moisture from the grain. If the air contains a lot of moisture, the grain is likely to take in that moisture from the air. The farmer should understand this fact because it explains the need to keep dry grain away from moisture and/or air as much as possible. Grain that is not sealed in a closed container will continue to exchange moisture with the air. During the rainy season, for example, grain will take on moisture if left in an open container. In the hot, dry season, grain will lose the moisture again.

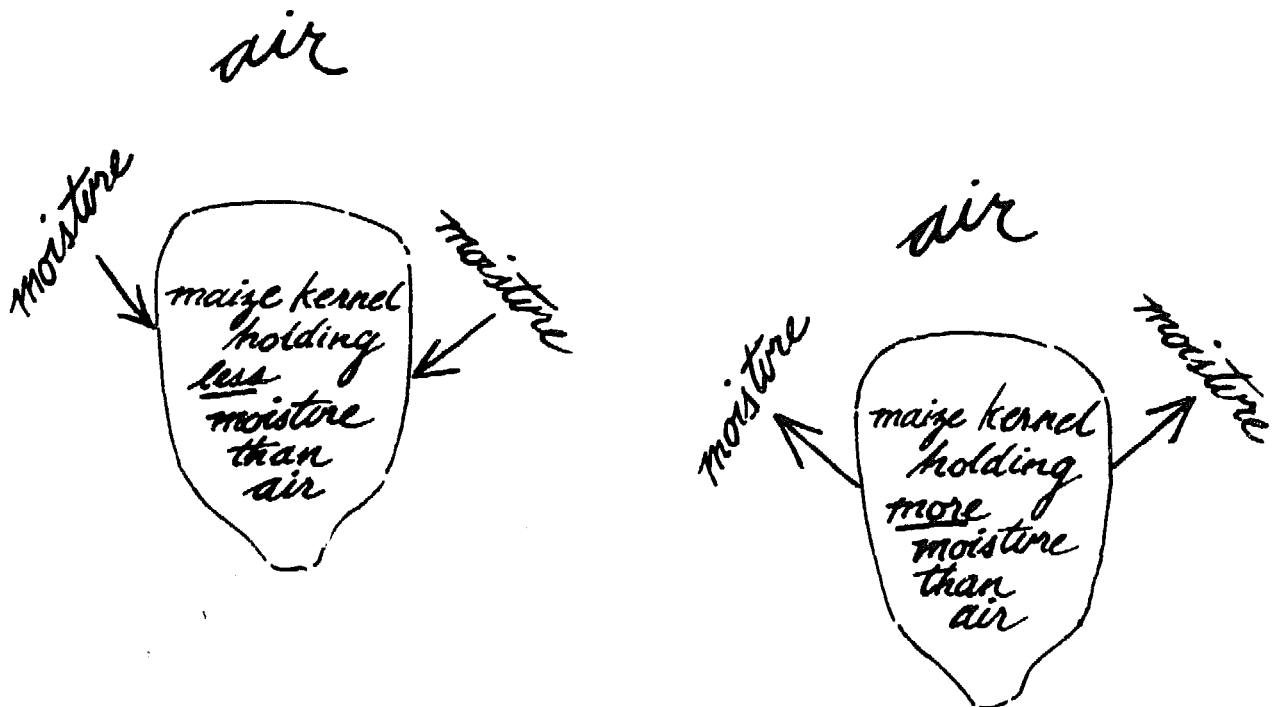

#### SAFE MOISTURE LEVELS IN GRAIN

Grain put into storage should not have more than a certain amount of moisture inside its kernels. Although the amount of moisture grain can hold in storage safely can change, depending upon storage conditions, some general moisture-safety percentages have been established.

The chart which follows shows that maize can be stored safely at 13.5% moisture (that is, 13.5% of the total weight of the kernel can be moisture), in air which is 25-30°C and has 70% relative humidity (that is, the air at this temperature can hold 30% more water than it is holding). At this point the kernel of maize and the air are not going

to exchange moisture back and forth. This is an equilibrium point. This equilibrium is the condition good grain storage tries to set up, but it is very hard to keep grain stored at conditions which keep equilibrium.

<u>GRAIN TYPE</u>	<u>MAXIMUM MOISTURE CONTENT FOR ONE YEAR (OR LESS) STORAGE AT 70% RELATIVE HUMIDITY AND 27° C</u>
Wheat	13.5%
Maize	13.5%
Paddy Rice	15.0%
Milled Rice	13.0%
Sorghum	13.5%
Millet	16.0%
Beans	15.0%
Cow Peas	15.0%

From "Handling and Storage of Food Grains in Tropical and Subtropical Areas," by D.W. Hall, published by Food and Agriculture Organization of the United Nations, 1970.

Remember, the figures above are maximum recommended moisture levels. Generally, farmers should dry their grain as thoroughly as possible.

#### MOVEMENT OF MOISTURE IN STORED GRAIN

Grain which is dry and cool will keep for a long time if it is stored correctly. However, there are a number of bad things which can happen to grain while it is in storage. And moisture is a key part of most of the process of deterioration (spoilage) that can occur in stored grain.

To discuss the role of moisture in the storage container, it is necessary to talk about:

- . grain condition
- . temperature
- . insects, molds, and grain heating.

#### Grain Condition

The farmer must store only clean, healthy grain which has been dried to safe storage levels.

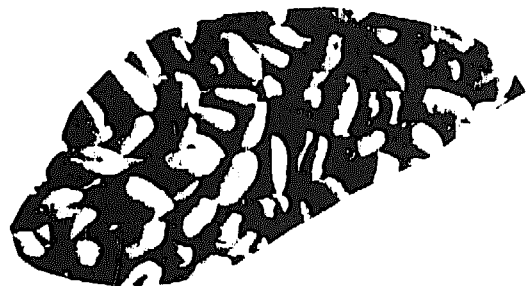

Broken grains and pieces of straw or dirt increase the chances of storage trouble. And, if the storage container does not keep out moisture or insects, even healthy, clean, dry grain can deteriorate. Trouble is less likely to happen if the grain starts in good condition.

### Temperature

There are two kinds of temperature: temperature in the air outside the storage container and temperature of the grain inside the storage container.

Some things to remember about temperature:

- . Low temperature is better than high temperature for grain storage. Insects and molds do not grow at low temperatures.
- . Grain breathes very slowly at low temperatures.
- . At low temperatures, little heat builds up inside the grain from the living and breathing of insects and molds -- and the grain.
- . Rising temperatures outside the containers can increase the temperature inside the container -- particularly if the container is not shaded or is made of metal.
- . Rising temperatures can lead to insect and mold growth. Even in grain that looks clean, insects are almost always there to some degree; mold spores are present everywhere. As the temperature of the grain goes up, these insects and molds will start to grow.

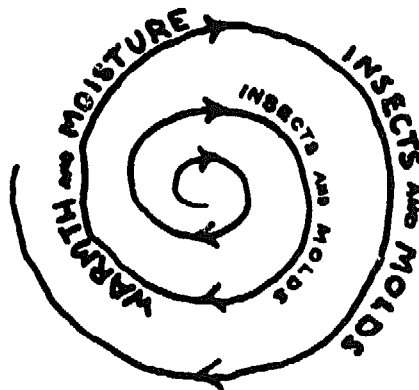

- . As the temperature goes up, molds and insects grow faster. The grain respires more quickly. If the grain contains a lot of moisture, this process goes even faster.
- . Hot spots can form in areas of the grain where the most mold and insect activity is occurring. These hot spots spread and cause great damage and loss of the stored grain.

The above points show how temperature and moisture work together. Therefore, grain placed into storage should be as dry and cool as possible. Even then there can be a moisture problem during storage. This problem often is the result of a difference in temperature between the inside and outside of the storage container. When cool air and warm air mix in the stored grain, the warm air cools and may be forced to lose moisture. This lost moisture becomes water which can be seen at the top and bottom of the storage container. The following drawings show what may happen when there are differences in temperature between the inside and outside of the storage container:

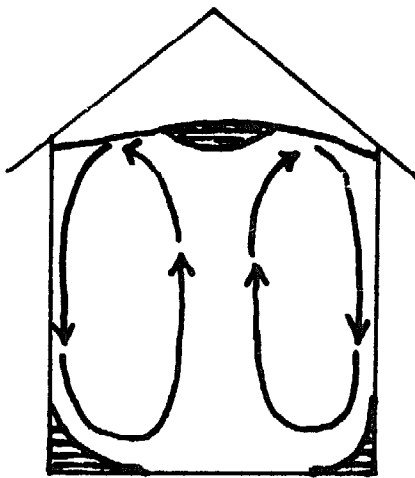

*cold air outside  
warm air inside*

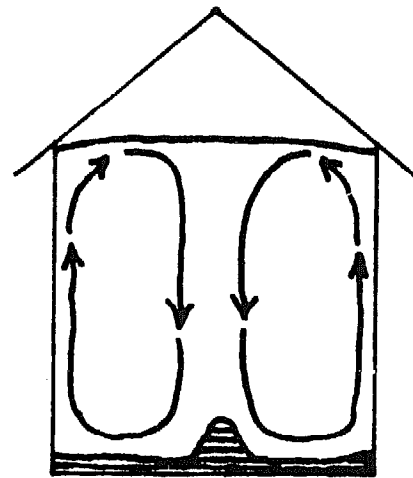

*warm air outside  
cold air inside*

 = moisture

These changes caused by temperature can be seasonal, or they may be daily. This depends upon where the farmer lives. Obviously, it is best to keep stored grain at a relatively constant temperature. The storage section will show various ways of dealing with this problem.

### Insects, Molds, and Grain Heating

Remember the dew and how it forms because cold air and warm air cannot hold the same amount of moisture? This same thing is what happens in stored grain when cold air and warm air meet each other because of changing temperatures. The farmer who understands dew will be able to understand how his grain got caked and moldy even if it was dry when he put it inside the storage tin or container.

The pools of water formed by the moisture forced out of the air make the stored grain wet. This wet grain begins to respire at a faster and faster rate. If there are insect larvae and mold spores present, they begin to grow and reproduce. Soon the insects, molds, and grain all are giving off heat. This process produces the hot spots spoken of earlier. When the temperature gets too high, insects will leave the heated spot and go out into the grain mass to find better living conditions. Other trouble spots then can develop.

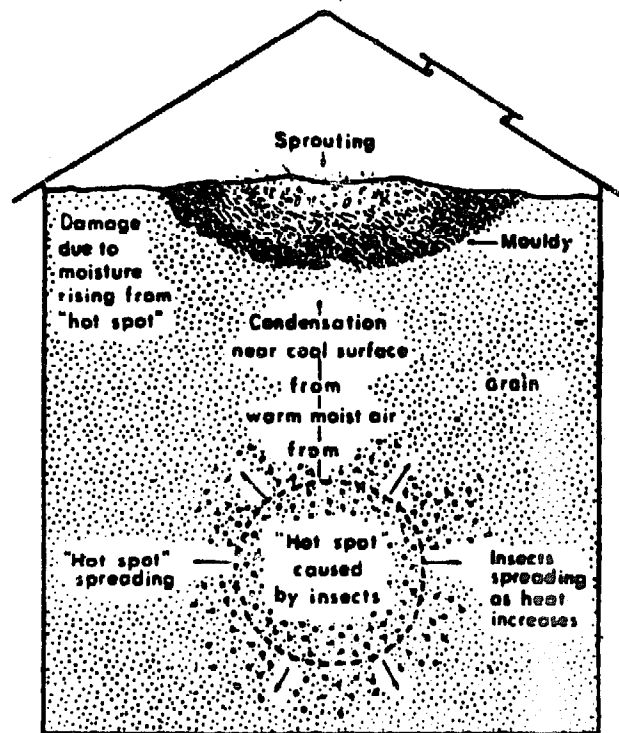

From "Handling and Storage of Food Grains in Tropical and Subtropical Areas," by D.W. Hall, published by Food and Agriculture Organization of the United Nations, 1970.

WHERE YOU ARE NOW

Now the background for the subject of grain storage is complete. If you have been using this manual with a farmer or group of farmers, they now know what grain is in a scientific way; the relationship among grain, water, air, and temperature; and some of the ways grain storage problems occur. In other words, they have some scientific ideas about good grain storage. The next section deals with the subject of preparing grain for storage. That discussion applies some of the ideas from this section.

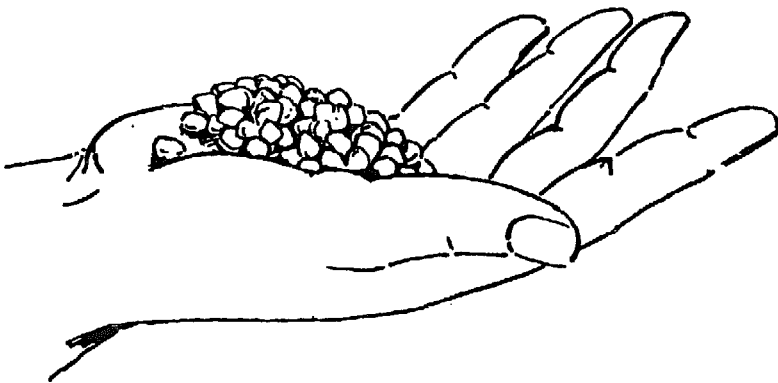



## PREPARING GRAIN FOR STORAGE

### INTRODUCTION

This section discusses the steps a farmer should take to prepare grain for storage. It gives these steps in the order he takes them. Each of these steps is looked at here as an important part of the storage process. Good harvesting, threshing, cleaning, and drying practices are important for the success of any storage method a farmer may use.

### HARVESTING AND THRESHING

Some grains, such as new varieties of rice, should be harvested when they contain quite a bit of moisture. Other types of grain, such as maize, can be much drier when harvested. But even when the grain can be allowed to dry in the field, there is often too much moisture in the air, or even rain, and the grain does not lose a lot of its moisture. Therefore, for one reason or another, the farmer has to harvest very moist grain. Then he must somehow dry the grain to about 12-13% moisture content.

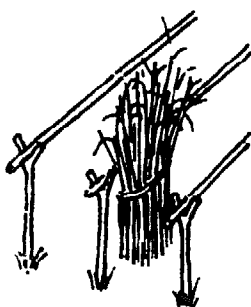

If the grain is a variety which can be allowed to dry in the field, and if the weather is good, the farmer can let his grain get as dry as possible while it is still in the field. In some dry, sunny places, it is possible to shock and windrow the grain after cutting it. Wheat, for example, is tied in small bundles that are stacked together side by side. Maize is also often stacked in shocks. This practice allows the grain to dry further. But this practice requires good weather. And rodents, birds, and insects can attack the grain while it is drying.

Threshing is the separating of grain kernels from stalks and husks. A small-scale farmer usually cuts and threshes grain by hand. When this

## Preparing Grain -2-

method is used, farmers must be careful to make sure all weeds and straw are separated from the harvested grain.

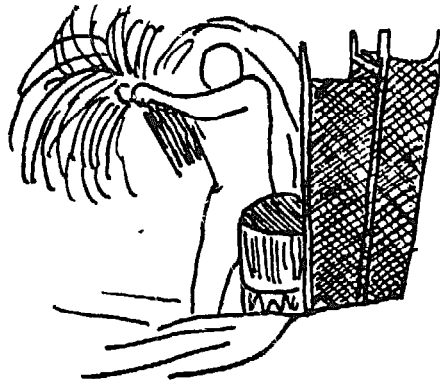

There are serious problems in most hand-threshing methods, especially for small grains. A common method uses trampling or beating of the grain to free the kernels. This method often causes cracking of the grain. In addition, unless threshing is carefully done, much of the grain is thrown away with the husks.

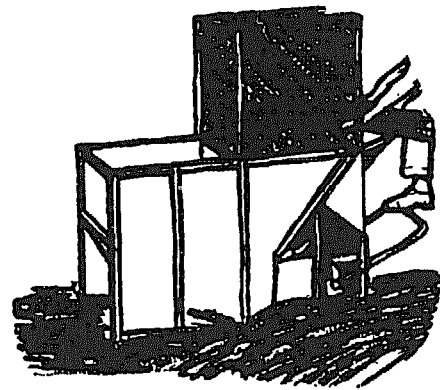
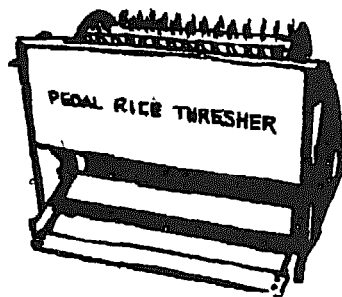

No matter what method the farmer uses for harvesting and threshing, he should aim for clean, whole grain. There are machines available which can harvest and thresh grain at the same time. Most small farmers cannot afford these machines. And for the small farmer, hand harvesting has advantages: it is easier to separate weeds from the grain, and less grain is lost during the harvest.

## CLEANING

Clean grain keeps in storage much better than dirty grain. After harvest, grain often contains small amounts of straw, weed seeds, and dirt. These unwanted materials decrease the value of the crop if they remain in the grain. They also cause the grain to deteriorate during storage. Dirt holds moisture, insects, and molds. Dirt also keeps air from moving well

through the grain. Dirty grain heats more and deteriorates more quickly than clean grain does.

Insects also must be removed from the grain. Those which eat the grain cause damage in several ways. They destroy much of the grain by eating it. As they grow and multiply, insects produce heat which can cause grain to spoil more rapidly. Grain with a lot of insects in it brings a much lower price than clean grain does.

Most modern harvesting machines get grain pretty clean. They usually blow air through the grain: this removes very light materials such as chaff, husks, and dust. The grain then is sieved. The pieces smaller than the grain kernels are removed by passing them over a fine mesh screen. The larger pieces of waste are passed over a screen that has a mesh size larger than the kernels.

This screening technique can be used even when a machine is not available. However, it requires screens of proper mesh size. When screens are not available, or when a substitute cannot be found for them, there are other, less effective cleaning methods.

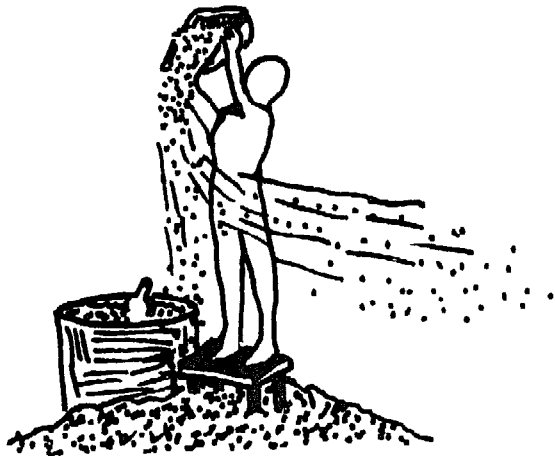

One of the simplest methods of grain cleaning uses the wind: this method is called winnowing. The grain is thrown upward in the wind. As it falls, the lighter pieces -- dust, powder, broken grain -- are blown aside by the wind. But the heavier stones and pieces of earth fall with the grain. For good cleaning, winnowing must be done over and over. Some grain is always lost, and so the method wastes grain. Some farmers place this waste material where chickens can take the lost grain from it.

Farmers also should clean their grain each time they move it to a new storage place. If this cleaning is not done, dirty grain from one place may be mixed with clean grain from another. Even grain that has been cleaned quite well before may need cleaning again. Insects do not need a long time to get into grain. Both the insects and their dirt should be removed before the grain is added to grain already in the storage areas.

The farmer should remember that cleaning is important because:

- . dirty grain deteriorates more rapidly in storage.
- . clean grain does not heat as quickly.

## Preparing Grain -4-

- . insects breed faster in dirty grain.

### THE NEED FOR DRYING

If moist grain is stored without air moving through it, the grain becomes hot. The grain respire more quickly and gives off more heat and moisture. The grain can be damaged if the heat is too great.

- . Heat builds up more quickly in wet grain.
- . Molds form rapidly.
- . Insects multiply faster.
- . Grain can germinate (sprout) while still in storage.

It has long been known that meat, fish, and fruit can be preserved by drying. Dried fish and fruit are widely used for food. These materials do not deteriorate much even when stored for long times. This is because life processes usually occur very slowly when there is little moisture. This is true for grain. Well-dried grain deteriorates only slowly even at fairly high temperatures.

### HOW DRYING HAPPENS

#### In the Field

In order to dry grain, moisture in and on its kernels must be carried away. As the grain stands in the field, the dry air moving past it takes up moisture from the grain. This air, now moist, is then blown away from the grain by the winds.

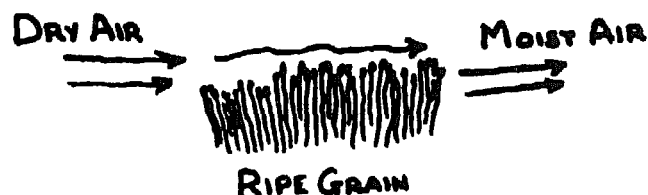

The drying process is most rapid if the air does not contain much moisture and if there is a wind. Little drying of the grain occurs if the air

contains a lot of moisture, or if there is not much wind.

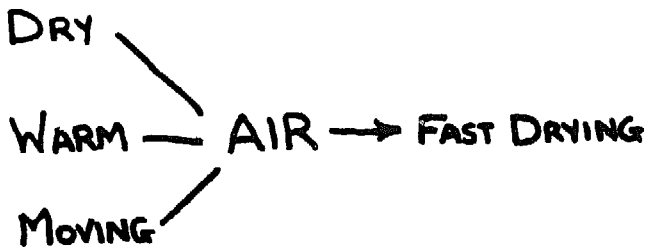

Hot air passing through the grain usually dries the grain more quickly than cold air does. From the previous section, it is easy to see that there are three major reasons for this:

1. Hot air can hold more water than an equal amount of cold air can. When dry air blows through the grain, the hotter the air, the more water it can carry away from the grain.
2. Water evaporates more quickly when it is warm. Hot air blowing past grain warms the moisture on the surface of the grain. This moisture leaves the grain more quickly.
3. Hot air heats the grain itself. Moisture deep inside the kernel moves through the kernel faster at high temperatures. It moves to the surface of the kernel more quickly. When this moisture reaches the surface, it leaves the grain and is taken up as vapor by the air.

### After Harvest

The above facts also apply to drying grain after it is harvested. Air must pass through the grain to dry it. Moisture between the kernels and on their surfaces is carried away first. The moisture deep within the kernels must first come to the outside of the kernel. Only then can it be removed by the flow of air. Air must be moving for drying to continue. Only if new, dry air enters the grain can the moist air between the kernels be replaced by air which can take up more water from them. This is the principle behind some drying methods which force cool dry air or warm dry air through the grain to speed drying.

STIRRING DURING SUN DRYING  
SO ALL THE GRAIN GETS  
EXPOSED TO THE SUN.

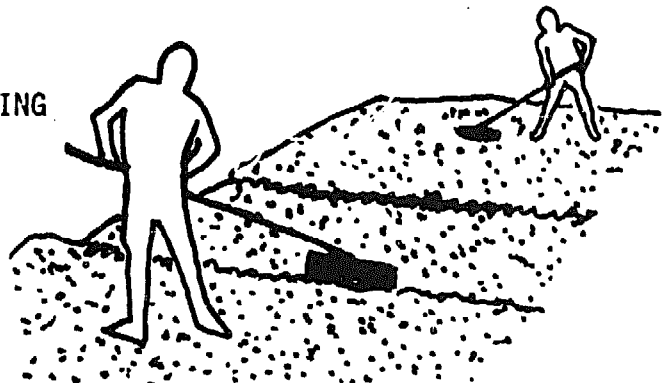

*Preparing Grain -6-*

Grain drying methods and models are presented in another section.

It is nearly impossible to dry any grain completely. The last ten percent or so of moisture in the kernel is tightly held by the kernel. It can be removed only with great difficulty. Luckily, grain stores well with this amount of water in it. In some cases, removal of this last water harms the grain.

SAFE DRYING TEMPERATURES

Whatever method a farmer uses to dry his grain, he must be careful not to let the temperature in the drying grain get too high. Too high a temperature causes the kernels of some grains to burst. Temperatures which are too high (when drying maize and rice) cause breaking, cracking, and discoloration of the kernels. This leads to a decrease in milling yield and protein quality. Maize which is used for oil will produce less oil.

Grain used for baking and milling can be dried at temperatures higher than grain to be used for seed. Grain used for seed should not be heated above 40-45°C. High temperatures can kill the seed embryo, and the seed will not germinate when planted.

The following are the highest safe temperatures for drying grain.

<u>USE</u>	<u>MAXIMUM TEMPERATURE, °C</u>
Livestock Feed	75
Food for Humans, except rice and beans	60
Milling for Flour	60
Brewery Uses	45
Seed Grains	45
Rice for Food	45
Beans for Food	35

Note Well: The drying temperature depends upon the use of the grain. Drying at lower, rather than highest, temperatures usually gives a better quality dry grain. Also, as a rough rule, lower temperatures should be used for very moist grain than for dryer grain. It is better to take a longer time, and use a lower heat, to dry moist grain than it is to run the risk of parching or burning the grain.

## TESTING GRAIN FOR MOISTURE CONTENT

Grain that is too moist will heat in storage. All stored grain should be examined frequently to see if it is heating. Heat build-up deep within the grain is a serious danger signal. Unfortunately, waiting until you can feel the heat in the grain is waiting too long.

Various electrical moisture testing devices are sold. They are seldom available when and where they are needed. Most of them are too complicated or expensive for farmers to use. An appendix to this manual contains a discussion of moisture meters. This will show you the kinds of commercial meters which are available.

Extension workers should know that grain moisture percentages are calculated in the following way:

$$\text{PERCENT MOISTURE} = \frac{\text{weight of completely dry grain}}{100 \times \text{total weight of wet grain}}$$

There are several ways to mechanically measure the amount of moisture in grain in order to make this mathematical calculation. Unfortunately none of these methods are very simple or inexpensive.

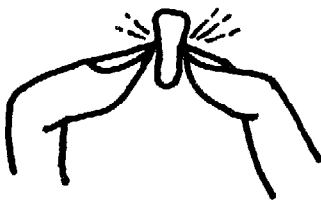

Fortunately, an experienced farmer can usually tell if grain is dry enough for storage. The method used by the farmer varies from region to region and depends upon the type of grain. However, two methods used by experienced farmers in many places are: (1) pressing the kernel of grain with the thumb nail to see how

*Preparing Grain -8-*

hard it is (dry grain is hard to press), and (2) crushing the grain kernel between the teeth to make sure it is hard enough (dry enough) for storage. Some people talk of testing to see if grain is dry enough by smelling it for an "off" smell or by rattling grain kernels in a tin can to hear if the dull sound of wet grain has given way to a sharper sound of dry grain.

The scope of this first manual edition can not be broad enough to allow us to add specific drying instructions and suggestions for each type of grain. Future editions may be able to do this. So, if your area is more involved with wheat, and you feel there are additional facts farmers should know, or there are drying methods you have found particularly helpful and would like to share with others around the world, send them in!

If there are plans for threshers and winnowers which could be made and used effectively by farmers, these also could be included in future editions of this manual.



## PREPARING GRAIN FOR STORAGE

Suggested Use: A shortened version of the text. This could easily be illustrated and translated for use by farmers.

- . Check the grain in the field before you harvest. Make sure the grain is free of insects and disease.
- . Clean old dirt and grain from harvesting tools.
- . Remove old grain and dirt from carts or anything used to carry the grain from the field to the storage place.
- . Use insecticide on all bins, sacks, and equipment. Remember to ask your extension worker for directions. Always use insecticide carefully.
- . Harvest the grain carefully. Do not break the grains. Broken grain will not store well.
- . Keep the grain cool and dry between the time you harvest and the time you store it.
- . Clean the grain carefully. Insects and molds like to live in harvested grain.
- . Sift, screen, winnow, or pick out by hand all dirt, straw, chaff, broken pieces of grain, rocks, and insects.
- . These materials hold water. The grain dries better and faster after all the dirt is removed.
- . Good drying is very important. Insects and molds like moist grain. Dry grain is harder for them to attack.
- . Some farmers dry grain in the field. Insects, rodents, and birds can attack this grain easily. Also, this grain can get wet if it rains. Maize can be dried better in the field if the stalk is broken, and the ear hangs upside down.

*Preparing Grain -10-*

- . It is better to take the grain out of the field. You can bring the grain to a special drying place and dry it in the sun.
- . Keep the grain off the ground while it is drying. Grain picks up water from the ground. Some people call this water, moisture.
- . Spread the grain on mats or flat boards to dry in the sun.
- . Some farmers spread the grain on large trays. The trays are put out when the sun is shining. The trays are placed under a roof when it rains.
- . Insects will leave grain that is in the sun. Insects do not like hot sunlight.
- . You must watch the drying grain to protect it from rodents and birds.
- . Some farmers like to use open storage places called cribs. These cribs have roofs on them, and they are built on legs.
- . These cribs work well for unshelled maize on the cob or for unthreshed millet, sorghum, or rice. Maize cobs can dry in the crib until they are dry enough for shelling.
- . Some farmers build large drying machines to dry their grains.
- . The grain is put in the dryer. A fire is lit under the grain to warm and dry the grain.
- . Artificial or mechanical dryers can be used by groups of farmers to dry their grain. Your extension worker can tell you about these dryers.
- . Test the grain when you think it is dry. The grain must be very dry before you put it in storage.
- . Dry grain is hard to break. It is hard to break it with your teeth.
- . Extension workers sometimes use special tools to see if the grain is dry. These tools are called moisture meters.

*Preparing Grain -11-*

- . When the grain is dry, look for insects again. Turn the grain over with your hand. You can see insects crawling around.
- . Sift out the insects. Or spread the grain in the sun.
- . Destroy the insects you take out of grain. Burn them. They will go right back into the grain if you do not burn them.
- . Put the grain into storage containers before insects can get into it again.
- . Put each kind of grain into a separate container.
- . Do not put new grain with old grain. Store new grain separately.
- . Use old grain first.
- . Store rice with the outer coat on. This coat helps protect the grain from insects and mold. The grain will be good for a longer time.

## GRAIN DRYER MODELS

This manual already has talked about the need for drying of the grain.

Unshelled maize, rice, millet, or sorghum often is stored in cribs for further drying. The cobs, or heads, do not pack tightly. Because the cribs are open to the wind, air moves through the stored grain and dries it. Even so, storage in cribs is more effective in the dry season. The more humid air of the wet season may actually add moisture to the grain. In addition, insects and rodents can cause serious damage to unprotected grain stored in cribs for long periods.

Threshed grains, particularly those with small kernels like millet, dry very slowly during storage. The kernels pack tightly together. As a result, air cannot move easily through the grain. Such grains can be spread in thin layers in the sun for drying. If possible, the grain should be on a screen to let air enter the bottom. The grain should be tumbled (stirred) often and carefully. The grain kernels can crack if they are stirred too hard.

The newer drying methods described here use heated air to dry the grain. Hot, dry air is blown through the grain. These methods dry the grain quickly and well. Most of them require the burning of fuel to heat the air. This fact, together with the cost of building the machine, often limits the usefulness of drying machines for use by small farmers.

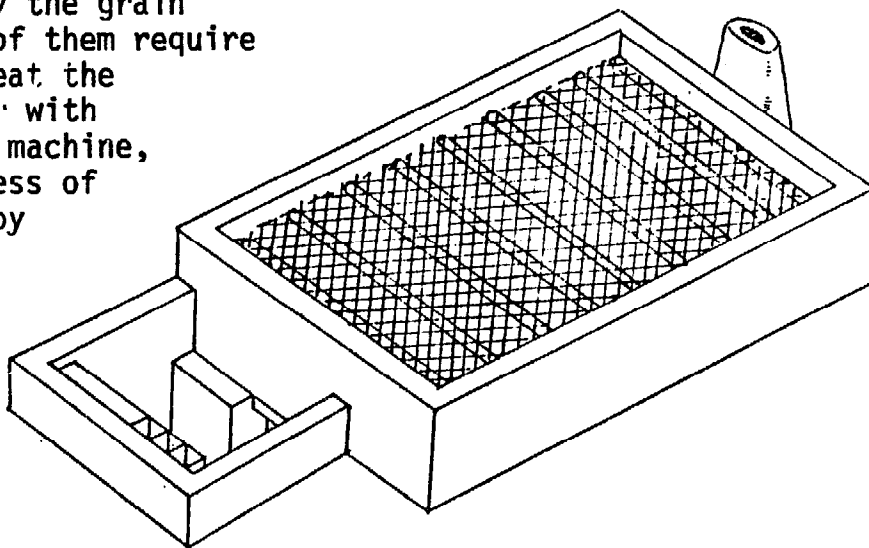

THE PIT OIL BARREL DRYER

### Improved Traditional Methods

A farmer has to think about a lot of things before he can decide which type of drying method to use for his crop. Here are some of the considerations he must keep in mind:

- . Does his present method work? If it does, why change it? If it does not work, why not?
- . How much money will he have to spend for a new drying method?
- . Would he be able to maintain a new drying machine? Could he fix it? Does he have enough time to operate it?
- . Would the cost of the dryer be easy for him to get back because of better storage leading to more grain to sell?
- . Would it be better to join a group of farmers and pay for the cost of a dryer with a group? Or does the farmer dry enough grain to make use of a dryer by himself?

You will probably be able to help by offering alternatives. For many farmers, an improved method of crib drying for maize or sun drying for smaller, threshed grains, would be a step easily taken. Such a step would insure a much better crop.

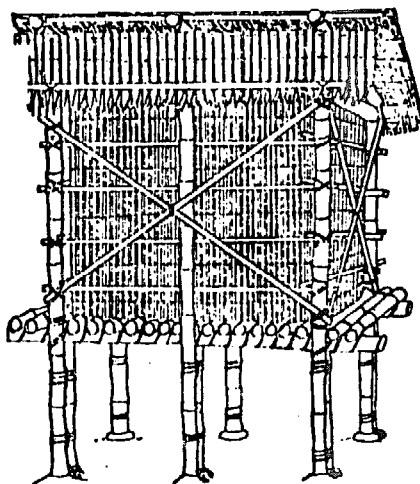

Here are some ideas for sun-drying grain:

- . Spread the grain in thin layers on trays which can be carried. Stack the trays under sheds or roofs at night to protect the grain from dew or from rain.

- . Make trays with fine-mesh screening for the bottom. Support the trays so they do not rest on the ground. The screening lets dust and straw fall out of the grain. Put the trays on top of each other under roofs or sheds at night and when it is raining.

#### SUN DRYING USING PLASTIC SHEETS

- . Find a plastic sheet. Or use several plastic sheets joined together. You need a sheet about 10m x 3m. The plastic should be at least .004 gauge thick.
- . Build a mound of hard-packed earth to place the plastic on. If you use level ground, build a dike of earth around the area on which the plastic will be placed to protect the drying grain from water.
- . Make sure there are no rocks, wood and sharp things on the ground where the plastic will go. The plastic tears easily.
- . Place the plastic in the prepared place.
- . Attach the narrow end of the plastic to straight poles made from bamboo or other smooth material.
- . Put clean grain on the plastic. Do not make the grain more than 5cm deep.
- . Stir often so the grain will dry faster. Turning and stirring makes sure all parts of the grain are touched by air and sun.
- . The rake or other tool used to stir the grain must have smooth, rounded edges. This tool then will not damage the plastic or the grain.
- . As the grain dries, moisture from the grain collects on the plastic. After the grain has been drying for two hours, push all the grain to one half of the plastic as shown.
- . Let this plastic dry for 5 minutes or so.
- . Push all the grain to the other half of the plastic that is now dry and let this half dry for 5 minutes.
- . The plastic sheet should be aired in this way every two hours while drying is going on.
- . Cover the grain at night. Push all the grain to one end and fold the plastic over as a cover.

*Dryer Models -4-*

- . Or place an extra piece of plastic over the grain.
- . Remember to put soil, boards, rocks, and heavy things on the corners and edges of the plastic cover to keep it from blowing off.

## THE IMPROVED MAIZE DRYING AND STORAGE CRIB

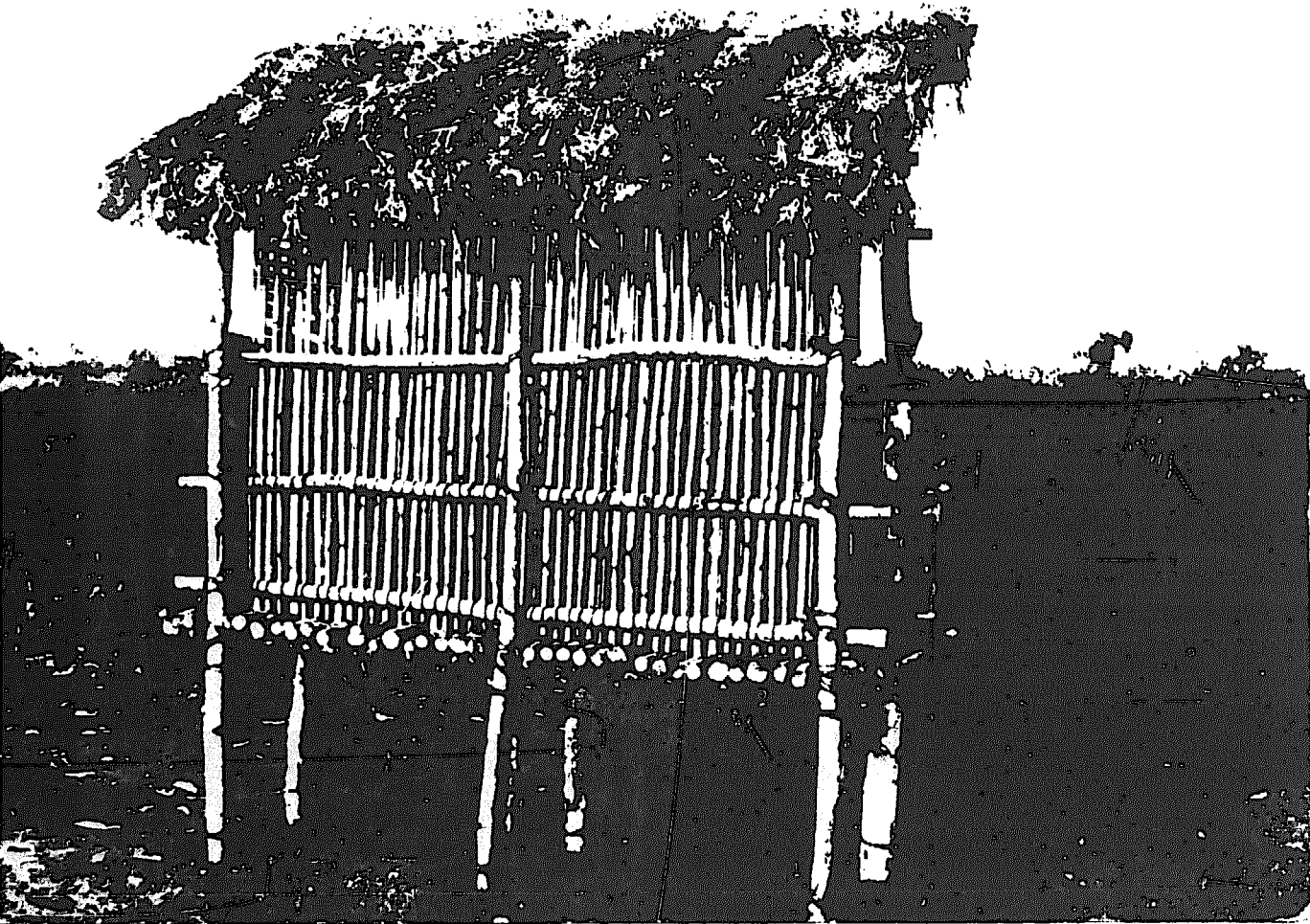

Maize holds a great deal of moisture inside its kernels and husk. When maize is harvested, the moisture content is high. It must be much drier before it can be put into closed storage containers. If maize is put into a closed container right after harvest, molds cause heavy losses of grain.

### Drying Maize

Harvested maize must have air passing around it to dry the kernels. When the kernels are dryer, they can be shelled (taken off the cob) and stored in airtight containers. To dry maize before shelling, some farmers keep the husks on the cob. Then they tie the husks into bunches and hang these



### The Maize Crib

bunches in trees. Some farmers hang these bunches on poles set into the ground or put them in the roofs of cooking or living shelters.

Sometimes farmers remove the husks and pile the cobs loosely in open-weave basket granaries or in covered crib granaries. These containers partly protect the grain from rain. Storing maize this way allows air to pass over the grain and dry it better. This way of storing the maize while it is drying helps protect the maize from mold.

But insects remain a big problem. They can attack maize drying in cribs easily. Many farmers choose to leave the husk on the maize cob. This does provide some protection from insect attack -- particularly in traditional varieties of maize where the husk is tight and fits closely over the cob. In newer, hybrid varieties of maize, the husk is smaller and the cob is larger. These varieties are more easily attacked by insects. Maize with the husks left on will take longer to dry because the air cannot pass freely over the cob. Also, the husks are full of moisture -- increasing drying time and the risk of molding.

So, a good way to dry and store maize would:

- 1) allow the maize to dry without the husks.
- 2) control insect attack at the same time.

Crib storage, already done in many countries, seemed a good method needing only slight improvement. Therefore, much work and study were done to design improvements into crib storage to allow for both faster drying and effective use of insecticides. Much of the improvement in the crib storage method is based on proper use of insecticides.

#### Insect Control in Cribs

To reduce losses due to insects, a number of insecticides have been tested for open crib storage. The maize put into the crib must have the husks removed so that the insecticide can cover the whole surface of the kernels on the cob.

Apply the insecticide to the maize cobs in layers. Put down a layer of cobs 20-25cm deep. Dust the layer with insecticide. Put down another layer of cobs, and then more insecticide. Continue until the crib is full.

When the crib is full, put insecticide on the outside walls of the crib to prevent insects from entering.

The wind, rain, and sun all can affect how long the insecticide lasts. You can put more insecticide on the outside of the crib every three to four weeks. Look at the maize in the crib every few weeks to see if the insecticide is still working. The insecticide put inside the crib will last only four or five months. But while it is working it can reduce the amount of maize damaged by insect attack.

### The Maize Crib

After four months, check the grain moisture level. The maize may be dry enough to shell and store in sacks or bins. The maize is dry when the kernels crack sharply between your teeth and are not soft. If the grain is not dry enough, remove all the maize and put it back into the crib again, layer by layer, dusting with insecticide as you go.

#### Faster Drying

Keep the crib no wider than 1m. Between 60 and 100cm are good widths for dryer/storage cribs. The narrow width helps maize to dry more quickly. Air cannot move through wider cribs to cool the grain in the middle. The grain in a wider crib will heat, and be attacked by mold and insects.

Rain which wets the grain through open crib walls is not generally a problem. Only the surface of the maize on the sides gets wet, and this dries quickly after the rain stops. This rain causes no increase in moisture content of the grain if there is sunny weather afterwards.

The following plan is a modification of a crib designed and tested by the Nigerian Stored Products Research Institute and the FAO Rural Storage Center at IITA, Ibadan, Nigeria. The plan is for a 2m long crib. It stores 800kg of cob maize (this will give 540 kg of shelled maize). A crib which is 1,50m high, 0,60m wide and 1m long will store 400kg of cob maize (yields 270kg of shelled maize).

#### Some General Remarks About The Improved Maize Drying and Storage Crib

- . Use materials that are easy to find in your local area.
- . The crib will work best if it is no wider than 60-70cm.
- . A good height for the crib is 2,00-2,25m from the ground to the roof. There is at least 50-75cm between the bottom of the crib and the ground. Most rats cannot jump this high.
- . If bamboo in your area is attacked by insect borers, use another local wood for the legs. Make sure the wood is termite proof. These legs must have rat guards put on them.
- . The long sides of the crib must face the sun. That is, they should face the east and west. The short sides will then face north and south.
- . Make the crib larger by adding more sections. Make it longer. Do not make it wider.

The Maize Crib

Tools and Materials

This is a guide. You can use what you have available. The frame is bamboo. If bamboo is not available in your area, or if the bamboo in your area is attacked by insect pests, use wood that is resistant to termites or any other pests. Lash it together the same way you would lash bamboo.

For the building frame (all bamboo or substitute):

- (a) 3 vertical supports, 3 1/2m long, with V-notches and lashing slots in one end of each one
- (b) 3 vertical supports, 3m long, with V-notches and lashing slots in one end of each one
- (c) 2 horizontal roof supports, 2 1/2m long
- (d) 2 horizontal platform (floor) supports, 2 1/2m long
- (e) 6 vertical platform supports (with V-notches in one end of each), 1 1/2m long
- (f) 6 notched horizontal width spacers, 70cm long
- (g) 25 poles, 95cm long, for the platform surface

For the wall bracing and covering (raffia, small bamboo or other wood):

- (h) 8 cross braces (optional if frame is very strong):
  - . 4 must be about 2 1/2m long
  - . 4 must be about 1,70m long
- (i) 8 wall supports, 2 1/4m long
- (j) 8 wall supports, 1m long
- (k) raffia or other strong slats for the wall covering. Tie these together into a mat. The finished mat should be about 6m long and 1 1/2m high.

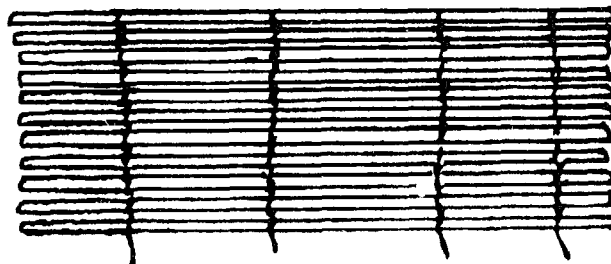

The Maize Crib

For the roof (all bamboo or substitute, except for purlins, and roof covering and loading cover):

- (l) 2 horizontal pieces, 3 1/4m long
- (m) 3 cross pieces, 1m long
- (n) 2 angle braces, 1m long
- (o) 7 purlins, 3 1/4m long. Six of these will be lashed across the cross pieces to support the roof covering; one may be attached to the front loading cover.
- (p) raffia mat or grass for thatch to cover the roof, and also for the front loading cover. You will need a horizontal piece at least 2 1/4m long to weave the loading cover material onto -- it need not be bamboo or of a large diameter.

For rat guards (if you need them):

See Section 6, Part 2 of this manual for directions on making rat guards (baffles).

For the lashing material:

- (q) You will need plenty of rattan, rope or tie vine for lashing all the wood pieces together.



1. Select a site.

- . Find a good site for your storage crib. Keep the crib away from the fields. This stops insects from flying to the drying grain from the fields.

2. Prepare your materials.

- . Collect all the materials you will need.
- . Make V-shaped notches in one end of each of the three 3 1/2m vertical supports (a), and cut some grooves on each side just beneath the notches to provide a hold for the lashing there. Do the same on one end of each of the three 3m vertical supports (b).

(a) & (b)



The Maize Crib

- Make V-shaped notches in one end of each of the six 1 1/2m vertical support posts (e).

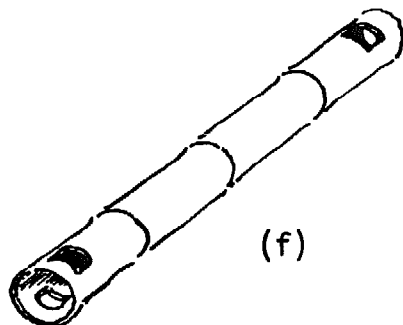
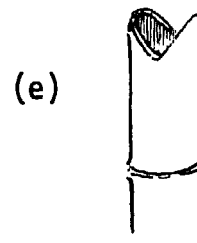

- Make holes all the way through each end of all six 70cm horizontal spacers (f).

- Organize all the pieces, or mark them with the appropriate letters, so you can find them quickly during construction.

3. Make holes in the ground for the legs.

- Mark spots for holes for the vertical supports (legs)(a) and (b) on the ground. Make a mark for the first hole; measure 1m and make another mark. Measure 1m from that mark in the same direction and make a third mark. You should now have 3 marks in a straight line. Each mark will be the center of a hole.
- Make three more marks, each 1m apart, in a line parallel to the first line and 75cm away. Each of the three new marks should be directly opposite one of the first marks and 75cm away.
- Dig six holes, each centered on one of the marks. Make the holes 50cm deep and wide enough so that two vertical supports will fit down into each one.

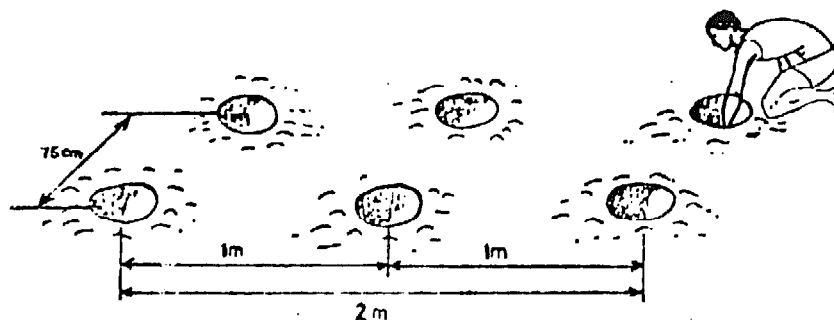

*The Maize Crib*

4. Erect the vertical supports.

- . Lay the three 3 1/2m vertical supports (a) on the ground 1m apart, with their ends lined up. Lash one of the 2 1/2m horizontal roof supports (c) to the notched ends.
- . Lay the three 3m vertical supports (b) on the ground in the same way and lash the other horizontal roof support (c) to the notched ends.
- . Place the two assemblies into the holes.

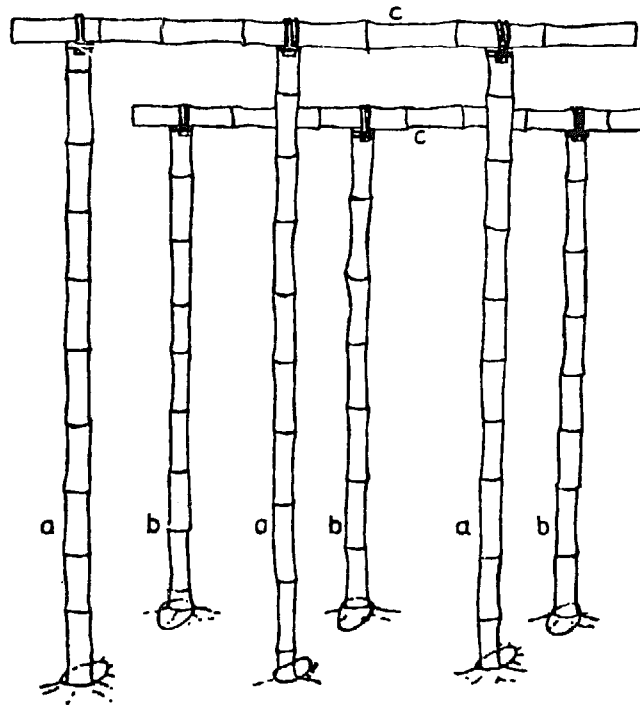

5. Erect the vertical platform supports.

- . Place the vertical platform supports (e) into the holes on the insides of the vertical supports you have placed in the holes. Make sure the V-notches are facing upwards.
- . Tie the platform supports to the longer supports temporarily until the next step is completed.

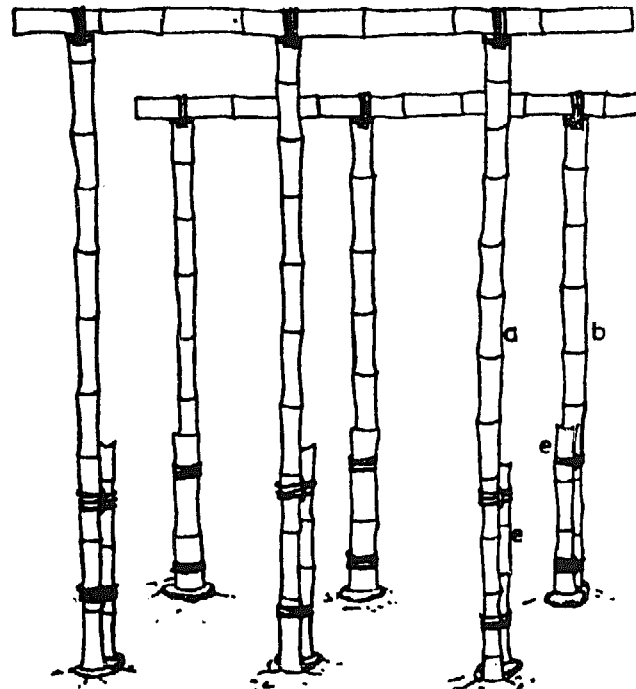

The Maize Crib

6. Install the platform support framework and make the structure rigid.

- . Place the two horizontal platform supports (d) in the V-notches of the platform supports.
- . Lash three of the notched horizontal spacers (f) to the vertical supports (a) and (b), across the width of the crib.
- . Level and square the framework.
- . Fill the holes around the vertical supports with small stones and soil. Tamp down firmly.
- . Lash all joints tightly.

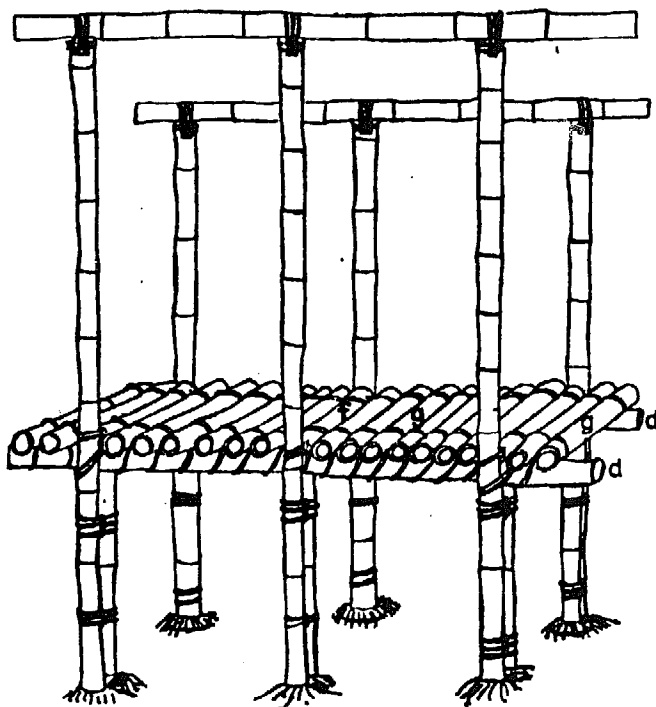
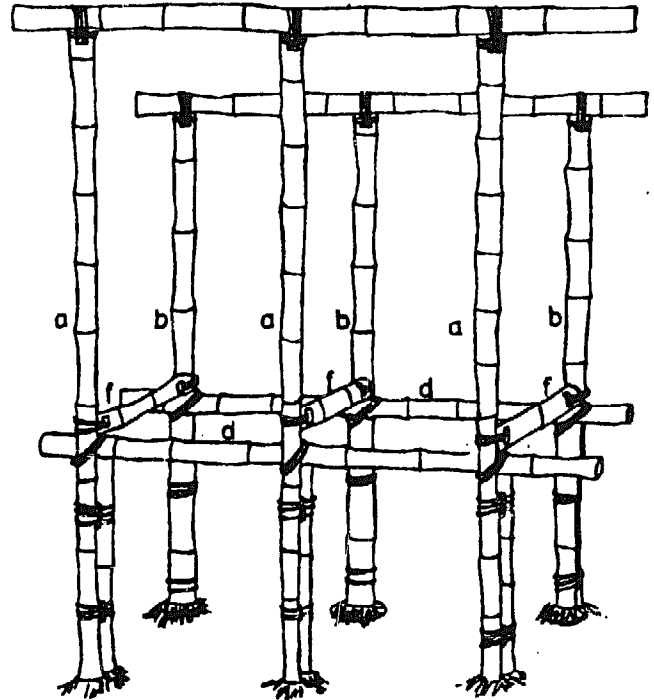

7. Finish the platform.

- . Lash the twenty-five 95cm poles (g) next to each other on the horizontal platform supports. This forms the platform.

The Maize Crib

8. Install the cross braces.

- . If you think the frame is not sturdy enough by itself, lash the cross braces (h) loosely to the vertical supports on the outside of the crib.
- . The 2 1/2m cross braces are paired on the long sides of the crib, and the 1,70m cross braces are paired on the ends of the crib.
- . Each brace should extend from somewhere near a top corner to somewhere near the opposite bottom corner. Leave room for a loading cover on the higher side of the crib.
- . Make sure the frame is straight and even. Lash the braces securely.

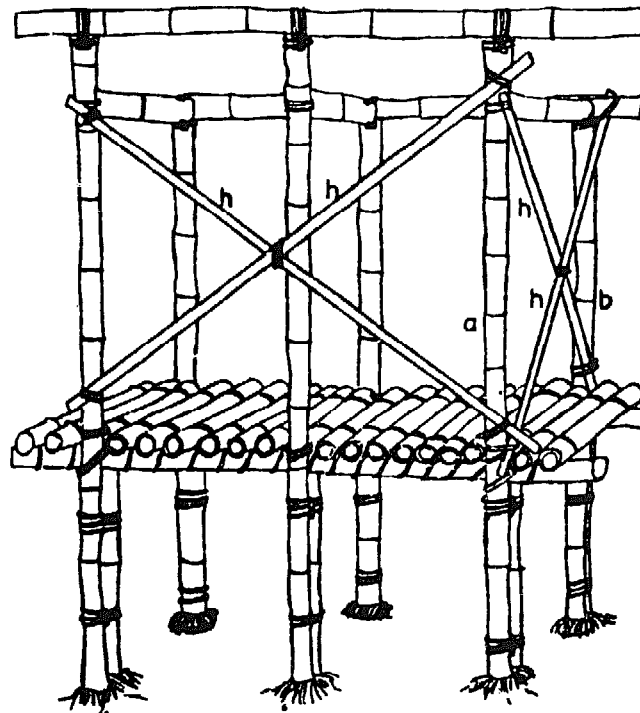

9. Install the wall supports and wall covering.

- . Lash four of the 2 1/4m wall supports (i) to the vertical supports along the inside of one of the long sides of the crib. Lash the remaining four supports to the inside of the other long side of the crib.
- . Lash four of the 1m wall supports (j) to the vertical supports along the inside of one end of the crib, and four of them along the inside of the other end.
- . Lash the already-prepared wall covering, 6m x 1 1/2m (k), to all the wall supports on the inside of the frame.

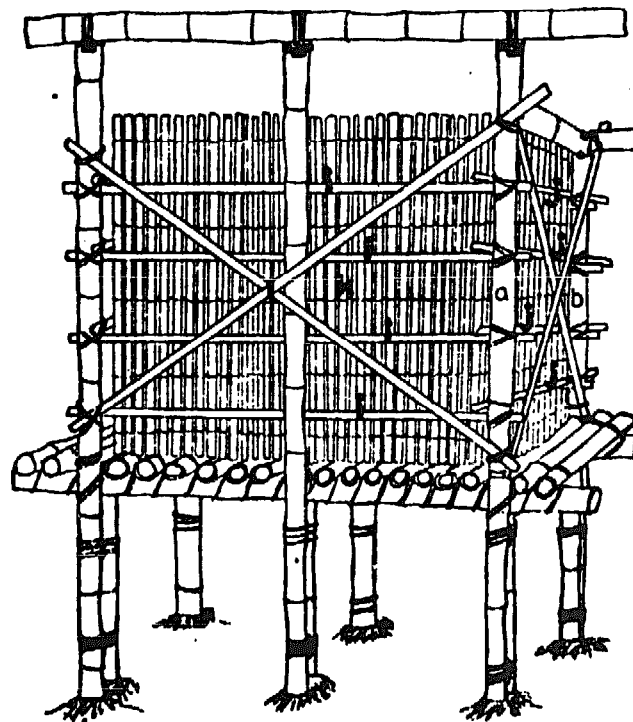



The Maize Crib

10. Build the roof.

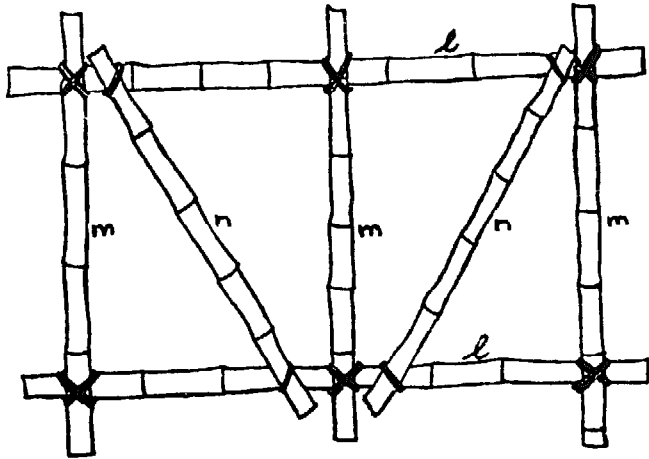

- . Call the high side of the crib the front and the lower side the back.
- . Measure the distance between the centerlines of the front and the back horizontal roof supports (c) which are lashed to the tops of the vertical supports (a) and (b).
- . Lay out the two  $3 \frac{1}{4}m$  horizontal roof pieces (l) on the ground so their centerlines are the same distance apart as the measurement you have just made.
- . Lash the three  $1m$  cross pieces (m) on top of the horizontal roof pieces,  $1m$  apart. When the

roof is placed on top of the frame, the cross pieces should cross over the ends of the vertical supports of the frame.

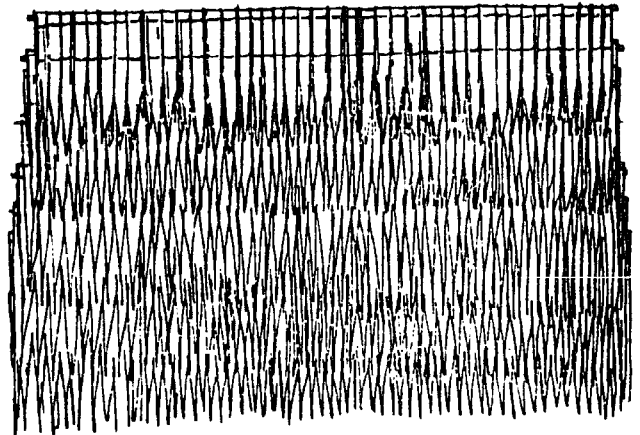
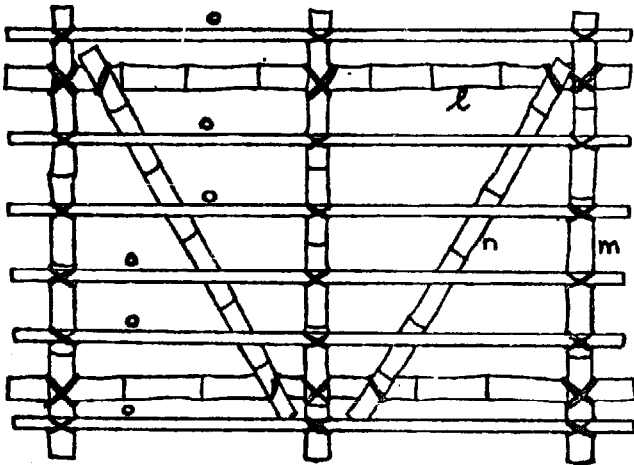

- . Lash the two  $1m$  angle braces (n) to the horizontal roof members so that they extend diagonally across the two spaces in the roof frame.
- . Lash six  $3 \frac{1}{4}m$  purlins (o) on top of the three cross braces so that they extend longways along the roof frame. Lash the first and last purlins near the ends of the roof cross braces.
- . Lash raffia mat in overlapping layers to the roof frame.

The Maize Crib

11. Install the roof.

- Place the roof on top of the frame as shown (looking at the end).
- Lash the roof in place.

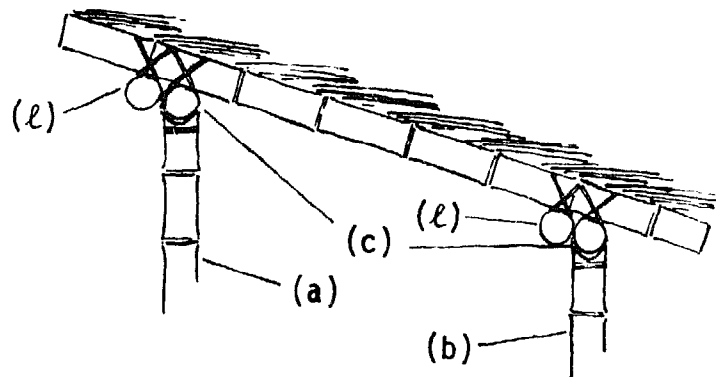

12. Make and install a front loading cover.

- Lash raffia mat to a 2 1/4m long bar to form the front loading cover. The mat should be made large enough to hang down beyond the top edge of the wall covering when the bar is lashed in place up under the front edge of the roof.

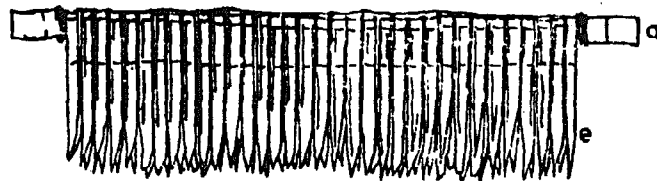

- Lash the bar holding the raffia mat up under the front horizontal roof piece.

13. The crib is ready for use.

- Load the crib. Lash down the bottom corners of the loading cover to the frame during drying and storage.

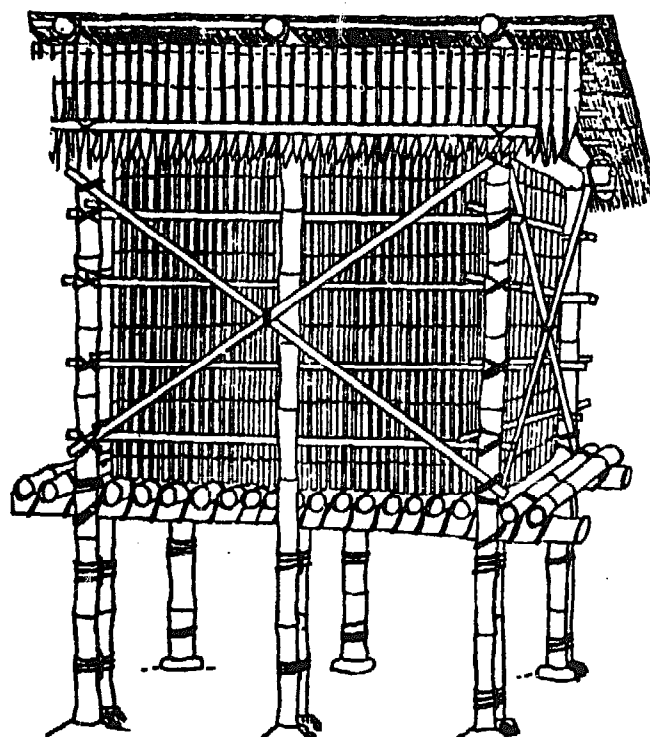

## NEWER DRYING METHODS

Some farmers have more money and are more in need of a faster, more reliable way of drying their crops. Controlled drying, or drying with a device which creates heated air for drying, can be very helpful to farmers who are ready and able to make use of newer methods. Used appropriately, these drying methods can help a farmer to:

- . harvest earlier and get his land ready for a new crop sooner.
- . avoid grain losses to insects, birds, and rodents during long natural drying times.
- . store better-prepared grain, keep it in storage longer, and take it out in better condition.
- . make more money from the sale of his grain.

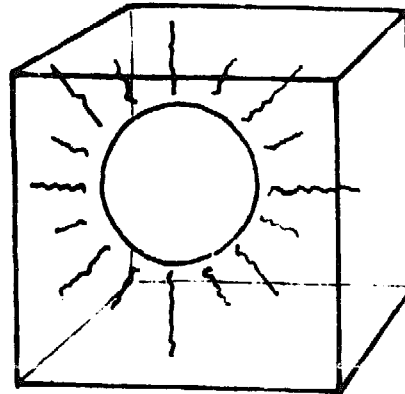

Four different dryer plans are presented here. Two are made using oil barrels and are heated with a fire. The Philippines Rice Dryer uses a fan and also uses heated air. The solar dryers are three variations of the same idea.

### Be Sure a Dryer Will Suit Farmers' Needs

There are several factors which may determine the usefulness of faster drying to farmers in your area. It is not possible to give guidelines for what a farmer could do in every case, but these are some of the basic ones.

The Storage Method. It will not be as useful to build a dryer that dries grain to a low moisture level, and then store the grain in something which will not keep it this dry -- such as cribs, unsealed gourds or baskets, sacks, most kinds of earthen pits, or mud-walled structures which do not have extra protection against moisture. Airtight storage will make the use of these dryers worthwhile.

Type and Condition of Grain. Rice will crack easily in high-temperature drying. Newer varieties of rice must be harvested when they still contain around 25% moisture; since the husks (containing moisture themselves) must be left on while drying, and the rice grains will be tightly packed, a very long time in the dryer would be needed. In the two oil barrel dryer designs, heat is not likely to flow evenly through the tightly packed

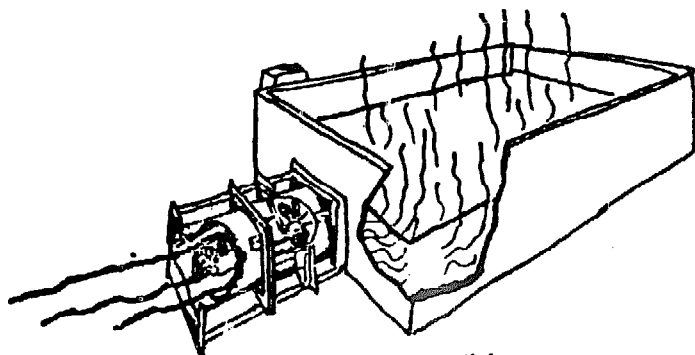

Rice Dryer

kernels: and much rice would be damaged by cracking. If fans are added to the oil barrel dryers to force a more even flow of warm air up through the grain, farmers should be able to dry rice successfully. The Philippines Rice Dryer uses this method. It may be difficult or impossible to dry rice in solar dryers. Other grains which also pack tightly, but give up their moisture more easily, and are not so likely to crack and shatter, may be safely dried as long as not too thick a layer is put into the dryer at one time.

Moisture in Grain. Drying very moist grain will take longer. The safest way to dry moist grain is for a longer time at a lower temperature. It would be difficult to avoid overheating portions of the drying grain during a long period of time if the temperature were not kept down. It is difficult to control the drying temperatures accurately in oil barrel dryers without fans and in solar dryers.

Moisture in Air. The weather in your area will affect how long the grain takes to dry. In a wet, cold climate or season, grain will take longer to dry than in a dry, warm place. Heated-air dryers might be very useful where drying must be done in wet or cold conditions which cause farmers to lose grain to insects and molds during long natural drying times. But, at least in the cases of the oil barrel and solar dryers, this must be weighed against problems caused by relatively long drying times in the dryer.

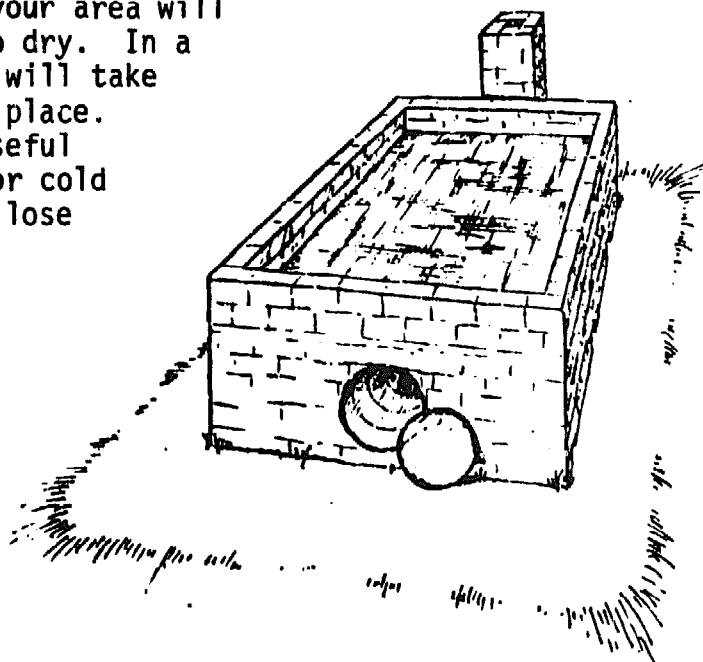

Simple Oil Barrel Dryer

Fuel. What kinds of fuel are available, and how much is the cost? You must know this to determine the value of heated drying, especially if you expect longer drying times in a dryer. Firewood is not always plentiful -- or even available -- in an area. Even if available, it may be costly. Maize cobs or some other natural fuel may be available. Farmers may have to pay the labor costs for gathering these fuels. Try to be sure farmers will not be spending more on fuel than they will be saving by marketing more and better quality grain.

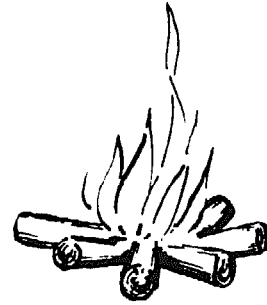

Other Important Factors. If the grain is to be used to seed, it should not be heated beyond 45°C. It will be difficult or impossible to control the drying of seed grain in these dryers.

Other possible costs, the availability of some materials, and cultural values or local preferences must also be taken into account.

### Some Notes on the Dryers

There are many dryers being developed all over the world. But much of this research is being carried out for use in large-scale drying operations. This manual is concerned with the small-scale farmer and his problems. The drying method he chooses must be appropriate for his situation.

The two dryers made out of oil barrels and hand-rammed earth or mudblocks have only one part which may be expensive -- the oil barrels themselves --, but the materials are available almost everywhere. In the Pit Oil Barrel Dryer the barrels are sunk into a pit. The Simple Oil Barrel Dryer is built entirely above ground. They each require mostly simple labor and would be good projects for a group of farmers.

*Cutaway of the Pit  
Oil Barrel Dryer*

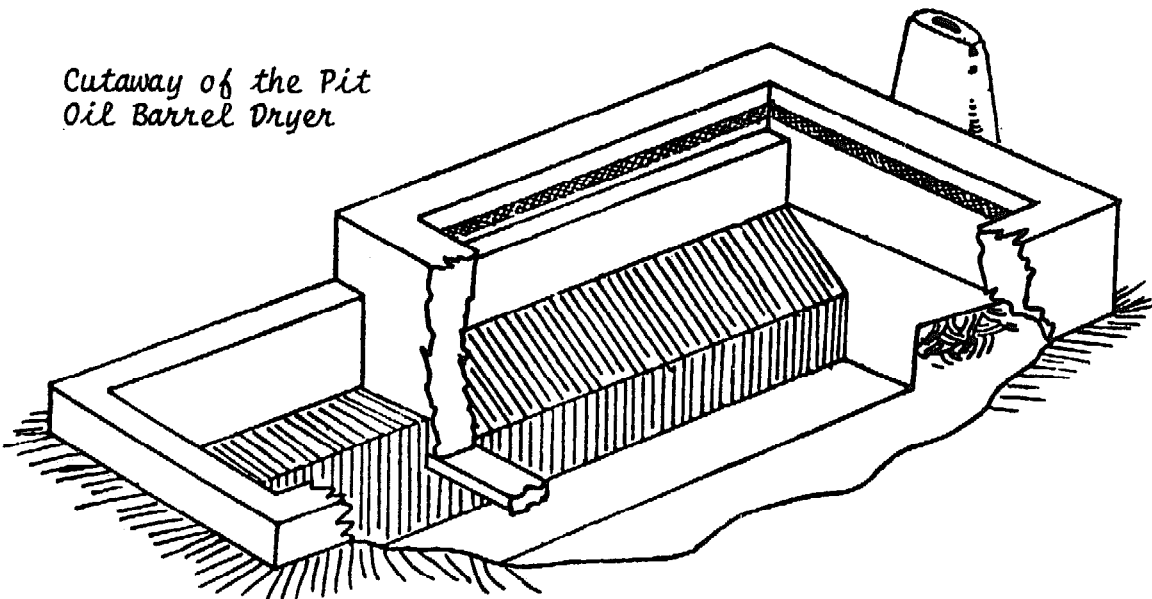

*Dryer Models -20-*

The Philippines Rice Dryer is made from wood and spare auto parts. A fan provides reliable air flow and more even heating. Oil, kerosene or rice hulls may be used for heating fuel, and a small gasoline or diesel engine, or an electric motor may be used to power the fan. It requires more in the way of materials. Thus it may not be usable by many farmers because of unavailability or high cost of materials. But the plan is included because there are farmers who are interested in this kind of machine, and it does represent a relatively small-scale, appropriate method of drying.

The solar dryers provide faster drying and require no fuel. By enclosing the drying grain, they retain the heat of the sun better than just spreading the grain out in the sun to dry. They require little or no maintenance. Except possibly for plastic sheet or corrugated roofing, all the materials should be available almost everywhere. One of the models' heating capacity can be augmented by adding a fire and a flue under the grain bed.

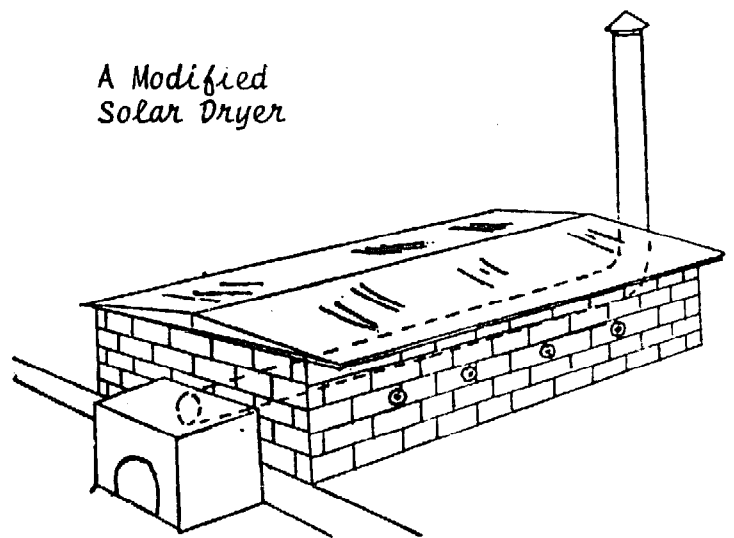

Again it is important to say that these dryers and drying methods are included here to provide good examples of drying choices farmers might be interested in. If a method is not quite right for the farmers in your area, perhaps only a slight change will be necessary. You may discover you can use ideas from one plan in another plan. Let us know if VITA can help make one of these plans more useful. If you know of a plan for a small-scale dryer useful to farmers which is not included here, send it to VITA for inclusion in the manual.

A SIMPLE OIL BARREL DRYER

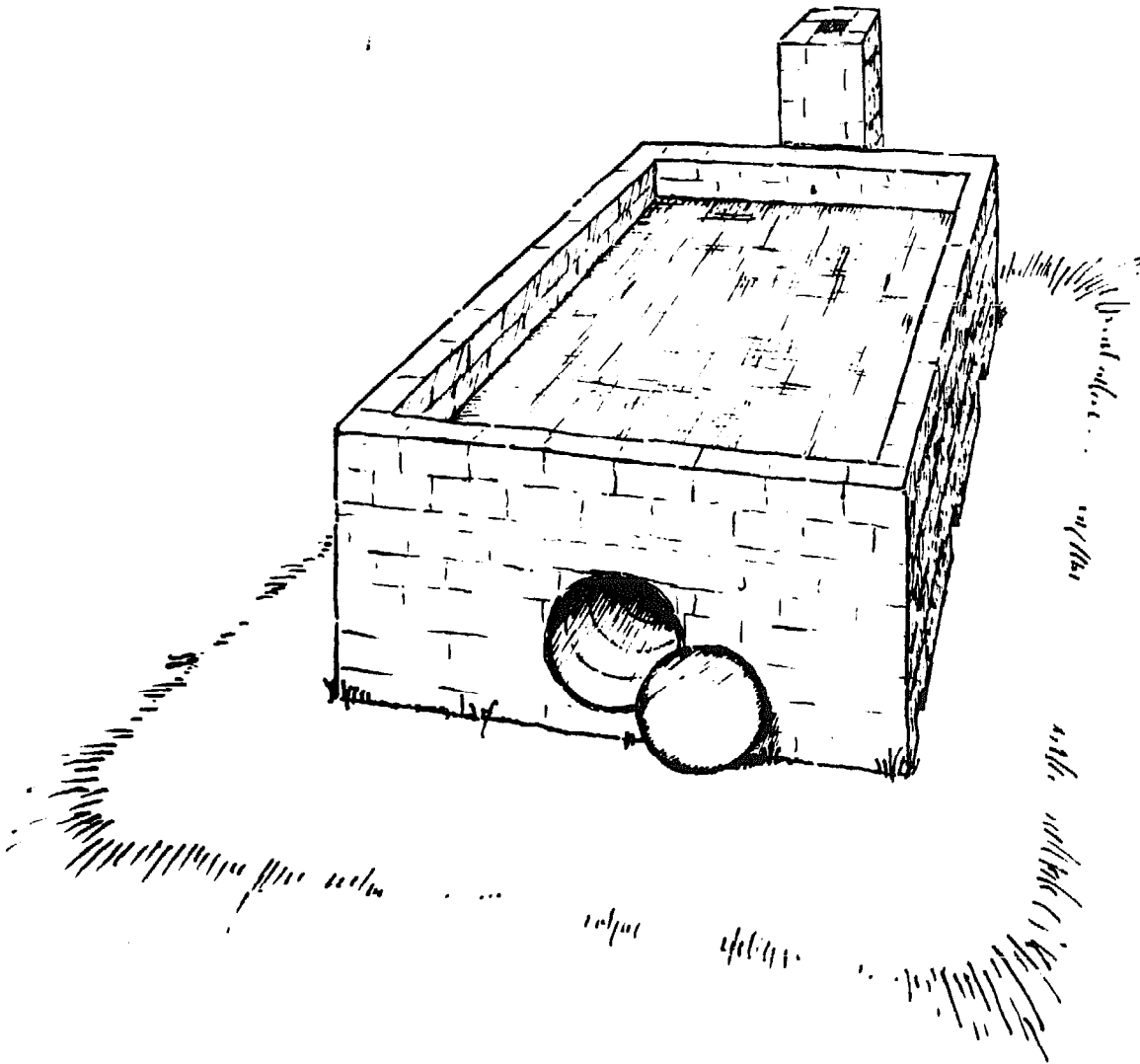

This design is based on material prepared in 1973 by the Institute for Agricultural Research at the Ahmadu Bello University in Zaria, Nigeria. It is similar to the Pit Oil Barrel Dryer, but it is easier to build. It rests on the ground so you do not need to dig any pits or trenches.

The drying grain is placed on a screen floor above four oil barrels fastened together. Warm air from the fire -- which is built in the front half of the barrel chamber -- passes through the barrels and out the chimney. This warms the air around the barrels, which rises through the screen floor and dries the grain.

Grain can be harvested without waiting for any drying in the field and during any weather (if you build a shelter over the dryer). Problems of insect and rodent damage during drying in fields or cribs are avoided. Construction materials are easy to find in most places.

### A Simple Oil Barrel Dryer

It is better for a group of farmers to share in the building and use of this dryer. Make sure there is enough fuel in your area to operate the dryer. Firewood or maize cobs will work well. Placing a fan to force air through the barrels will reduce the amount of fuel needed.

Do not use this dryer to dry grain kernels you will use later for planting. It gets too hot.

In this plan mudblocks are used to make the walls. Hand-rammed earth may also be used without putting it into blocks first. You may substitute an available local material that will be as strong and resistant to wear and heat, such as burned brick. Sandcrete (cement and sand) or concrete blocks will crack with the heat. If banco (earth and water) is already used for construction in your area, the same high-clay-content soil will work well for the dryer. You may mix in cement with low-clay soil to build earthen walls.

This dryer is made with four barrels. You can build one with more or less barrels. If you make it too much longer you may have trouble getting a good draft from the fire going through them. You should also narrow the width of the dryer somewhat if it is longer, so as not to overload its heating capacity. You can make a shorter dryer wider. A smaller dryer might also be very useful to dry smaller fruit or vegetable crops.

#### READ THE INSTRUCTIONS THROUGH BEFORE YOU BEGIN

#### Tools and Materials

- . 4 220-litre oil barrels
- . about 375 mudblocks, each measuring 15 x 20 x 25cm
- . wood to make a form for the mudblocks
- . about 2m of heavy wire, to join the barrels
- . 3 strips of small-mesh screen, each about 180cm long and a few centimeters wide, to cover joints between barrels
- . a little cement and some sand to make mortar for sealing the joints between the barrels
- . 13 6-10cm wide logs for drying floor supports. Cut them about 2m long, equal to the outside width of the dryer.
- . 6 1/2 or 7 square meters wire mesh, for the drying floor  
OR  
about the same area of heavy woven mats, plus a total of 10m of wire mesh strips about 20cm wide



*A Simple Oil Barrel Dryer*

- . OPTIONAL: materials for making concrete, plus reinforcing rods; or heavy metal bars. These will make reinforcing crosspieces across the barrels in the front and back walls of the dryer.

1. Select and prepare a site.

- . Select a site that is well drained and can easily be made level.
- . Plan to place the dryer so the chimney will be on the downwind side of the prevailing wind during the season when the dryer will be used most.
- . Build up the ground on the site a little so rainwater will not collect around the dryer. Make it level. Make the raised and level area about 6,50m x 4m.
- . Tamp the earth down firmly so it will not shift or crumble under the finished dryer.

2. Assemble the oil drums.

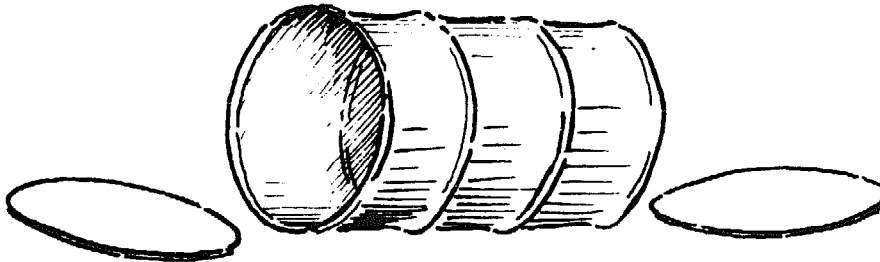

- . Cut both ends from three 220 litre barrels.

- . Cut one end from a fourth barrel. Cut a hole about 20 x 20cm across near the edge in the other end of this barrel. This will make an opening into the chimney.

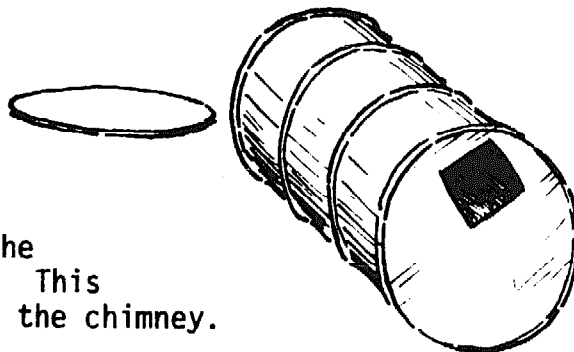

A Simple Oil Barrel Dryer

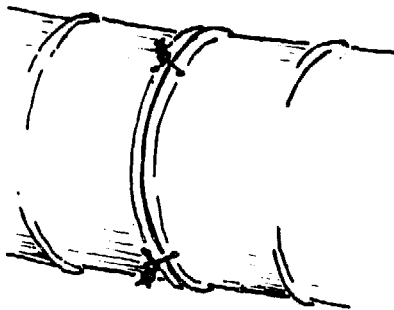
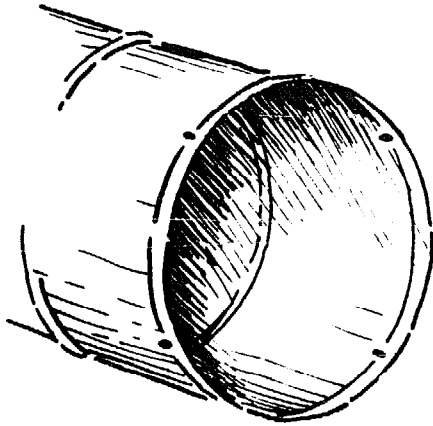

- . Punch four evenly spaced holes around the rim of each barrel where it will join another barrel.
- . Join the four barrels together by tying pieces of heavy wire through the punched holes. Twist the ends and press them down flat against the barrel.
- . Save two of the cut-off barrel ends to use later as dampers, one at the front entrance to the barrels and part of the other over top of the chimney hole.

3. Make mudblocks.

- . Make a form out of wood to mold mudblocks with. One that will make three at a time might be a good size. Make it so that each finished block will measure 15 x 20 x 25cm.
- . You will need about 375 mudblocks. Let them dry hard before using.

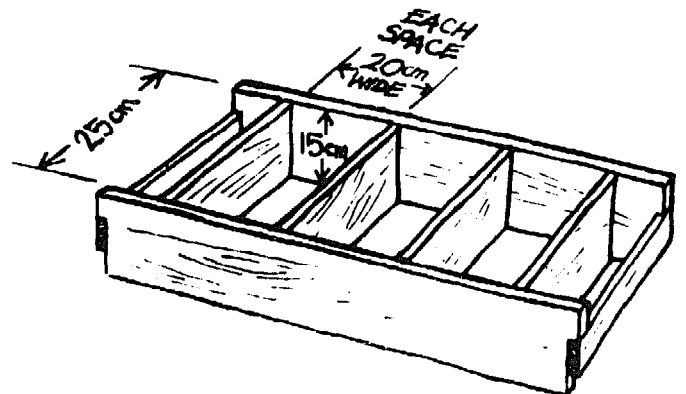

A Simple Oil Barrel Dryer

4. Begin the dryer walls.

- Mark the outside dimensions of the dryer on the dirt foundation you have made. It will be a rectangle measuring about 3,50 x 2m.
- Call 3,50m the length of the sides and 2m the width across the front and the back. Make your marks so that the front of the dryer will sit back about 2m from the edge of the raised and levelled earth foundation. This will leave about 1m at the back. Leave about 1m on each side.

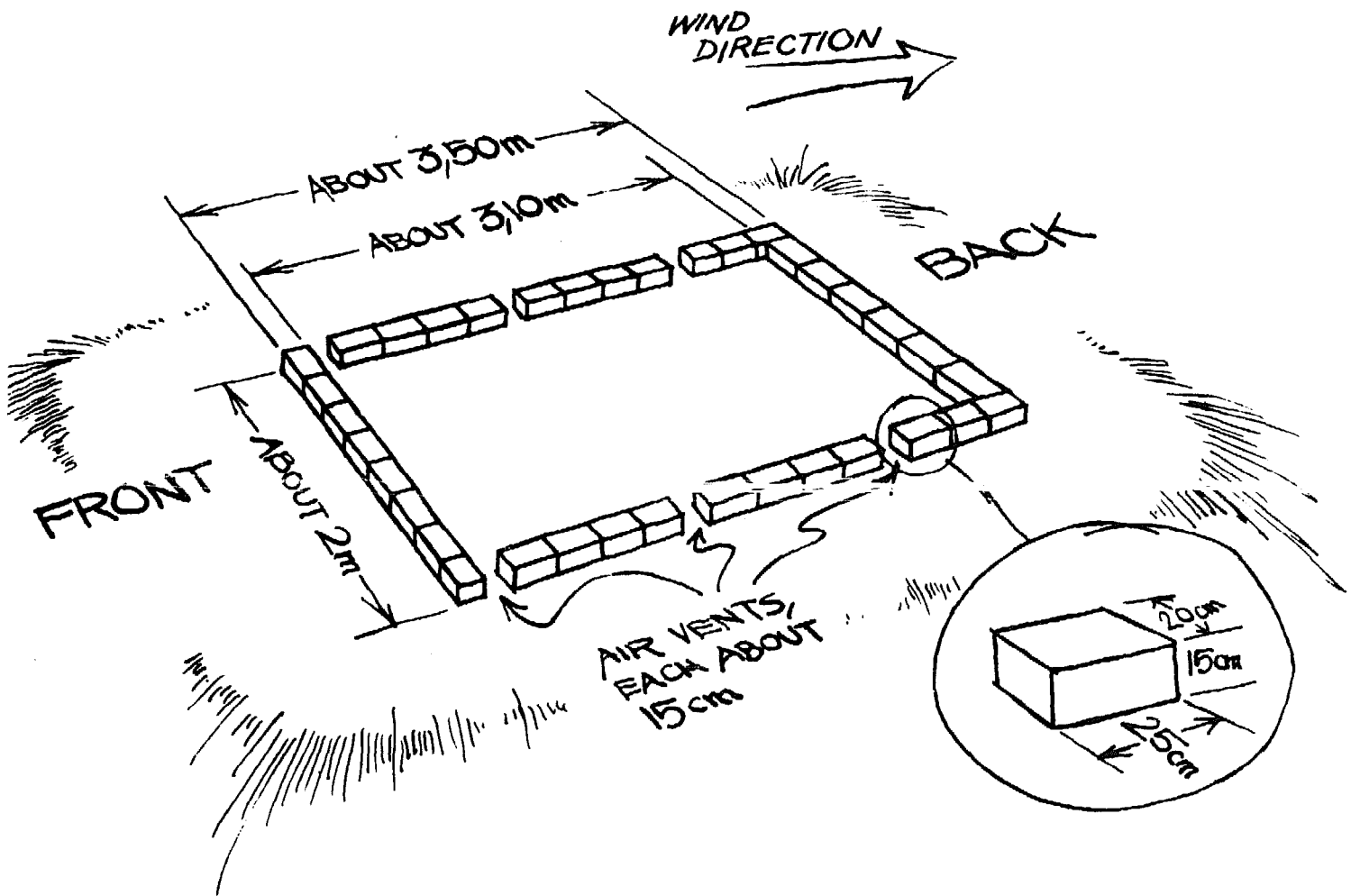

- Allow for variations in the actual size because of differences in the mudblocks and spaces between them for mortar.
- Make a mixture of mortar out of the same material you used for the blocks. Add just enough water so it is not too watery.

A Simple Oil Barrel Dryer

- . Lay down the first layer of mudblocks. Place blocks so that 20cm is the thickness of the walls and 15cm is the vertical dimension.
- . Mortar between the blocks. Allow about 1cm between blocks for a good mortar joint.
- . It is important to make the right distance between the front and the back walls. Since the assembled oil barrels will be about 3,45m long, make the distance between the inside edges of the front and back walls about 3,10m. This will allow the ends of the barrel to rest firmly on the first layer of blocks at each end. Later they will be enclosed around the sides by the finished end walls, making a good seal against smoke from the fire leaking around the barrels and passing up through the drying grain.
- . The three spaces along each side wall will be air vents. When the dryer is in operation cool air will be drawn in through them, warmed, and then rise through the grain to dry it.
- . Make the air vents each about 15cm across. If you have trouble getting a 3,10m distance between the inside edges of the front and back walls, you may change the size of the vents a little.

5. Place the barrels.

- . Place six free-standing blocks down the middle of the dryer. These will support the barrels. Getting the barrels up off the ground helps air to move around them and also reduces the chance of their rusting.
- . Put a layer of mortar on each of the blocks down the middle of the dryer and on the center part of the front and back walls where the barrel ends will touch.

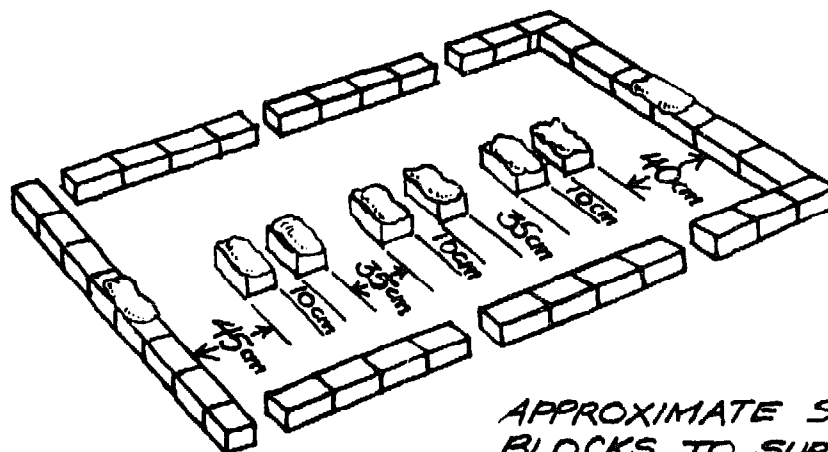

APPROXIMATE SPACING OF  
BLOCKS TO SUPPORT BARRELS

*A Simple Oil Barrel Dryer*

- . Lay the barrels in place on the mortar and brace them temporarily with sticks if they want to roll. Make the chimney end of the barrel assembly flush with the outside edge of the back wall. This should cause the front end of the barrel assembly to lie most of the way across the front wall. Make sure the hole that will let smoke into the chimney is on the top of the end.
- . Seal the joints between the barrels. Place a strip of screen around each one and plaster with a mixture of mortar, one part cement to eight parts sand, and water.
- . Test the seals at the joints. Light a smoky fire in the first or second barrel from the front and see if smoke escapes anywhere except the hole for the chimney. Don't let it burn long enough to dry the mortar on the joints. Keep the mortar damp until it is hard.

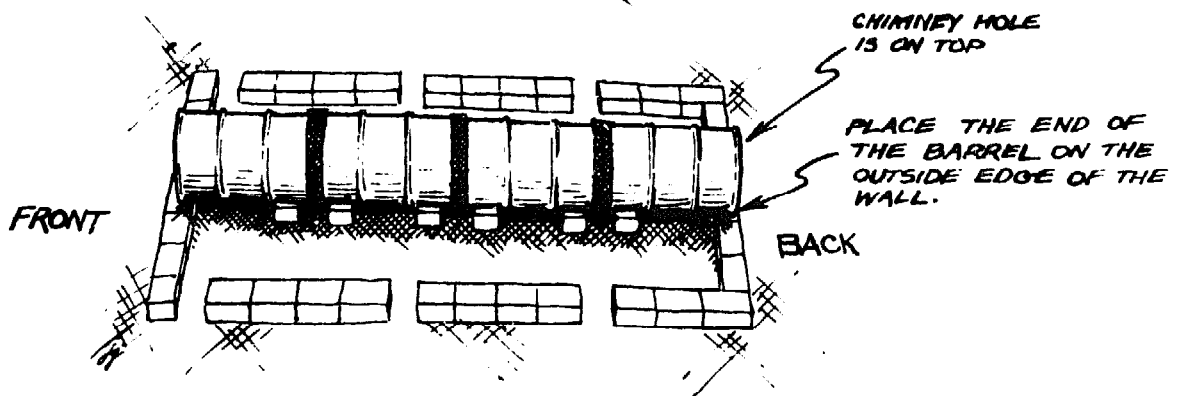

6. Continue the walls.

- . Lay down five more layers of mudblocks.
- . Lay the blocks so that, as much as possible, each block crosses over a joint between blocks in the layer below. This will make the walls stronger.
- . The air vents are only as high as the very first layer of blocks (15cm). Span over top of each vent with one full-size block.

A Simple Oil Barrel Dryer

- To make good continuous layers of blocks you will have to cut some blocks into smaller sizes.
- Bring the blocks in the front and back walls as close as you can to the sides of the barrels. Fill in the spaces completely with mortar so there will be no air leaks. For added strength you can mix some cement with this mortar.
- If you think the ends of the barrels are not strong enough to support three or four layers of blocks above them, then make crosspieces out of reinforced concrete or use iron bars to put across the top of the barrel ends. Make them longer than the width of the barrels. Mortar them into place in the wall, and make the tops even with the top surfaces of the walls.

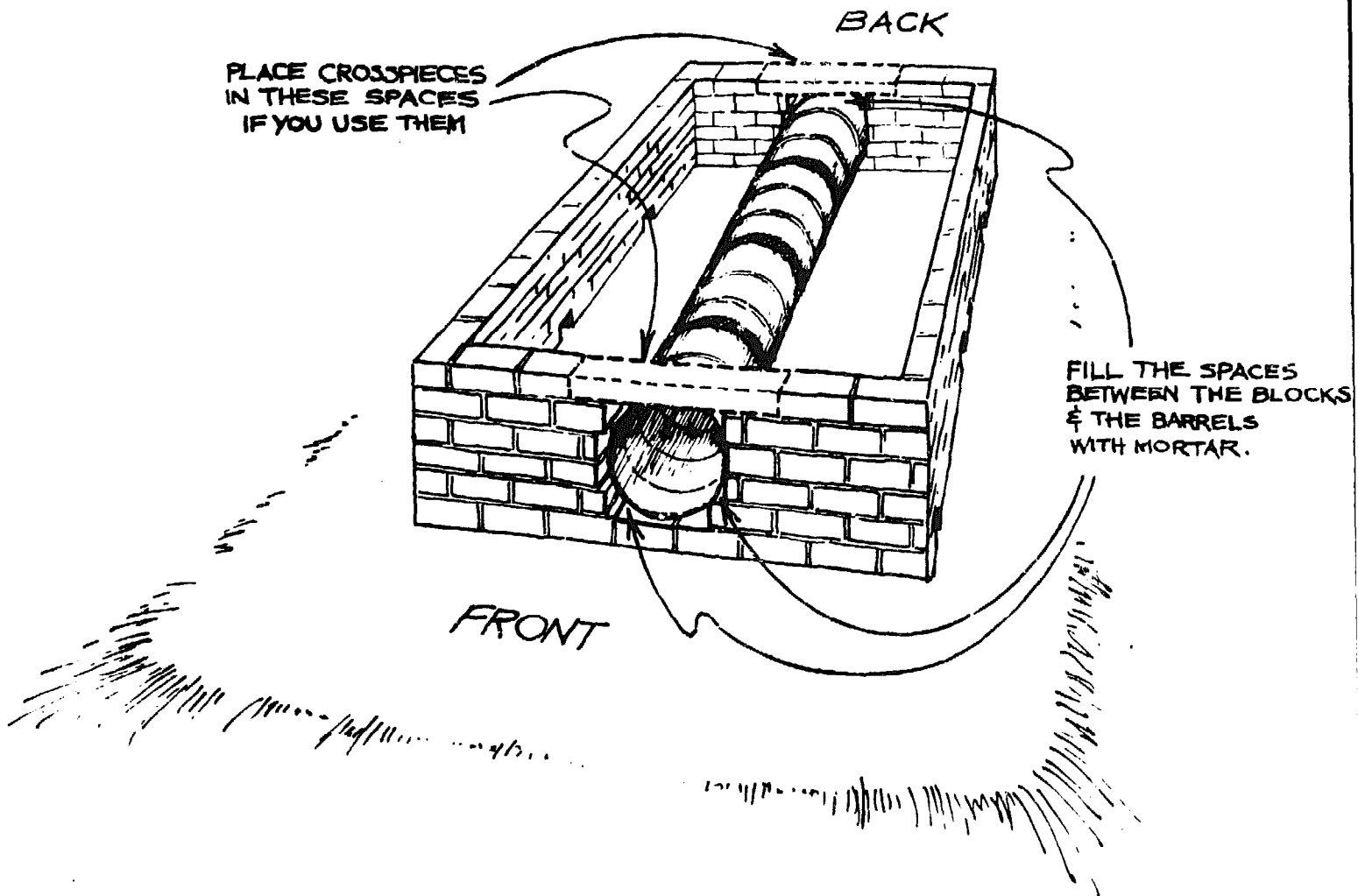

*A Simple Oil Barrel Dryer*

7. Make a drying floor screen.

- . Prepare screen to the right size for the drying floor. Assemble whatever size sections you have by overlapping about 5-10cm and fastening together with thin wire.
- . The overall size should be about 3,30 x 1,80m. This will allow about 10cm on each side to be embedded into the walls.
- . Check the size of the screen by stretching it lightly across the top of the dryer. If it overhangs beyond the outside edge of any wall when it is centered, trim it back. If it is too small, add some screen where it is needed. When you are satisfied, set the screen aside.

NOTE: Small-mesh screen is best. But chicken wire can be used. Place straw mats over chicken wire, or other large-hole screen, so grain will not fall through the holes.

Some kinds of woven mats are very strong. These can be used in place of screen. In some places, screen may be costly. If you use mats in place of screen, it would be best to prepare some strips of metal screen to embed around the insides of the walls and fasten mats to. Then, if the mats later rot or weaken around the edges (or anywhere), there will be something to fasten new mats to.

8. Place the drying floor supports and screen; finish the walls.

- . Put a layer of mortar down on the top of each side wall.
- . Lay the thirteen logs down on the mortar, from one side wall to the other. Space them evenly. You should leave about 15cm between each one and between the log on each end and the end wall next to it. The 15cm may be a little different; it will depend on the size of the logs. The log ends should come to the outside edge of each side wall.

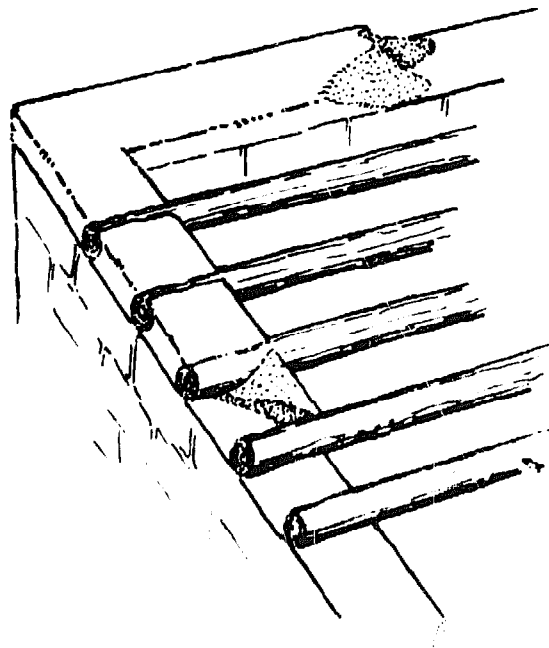

A Simple Oil Barrel Dryer

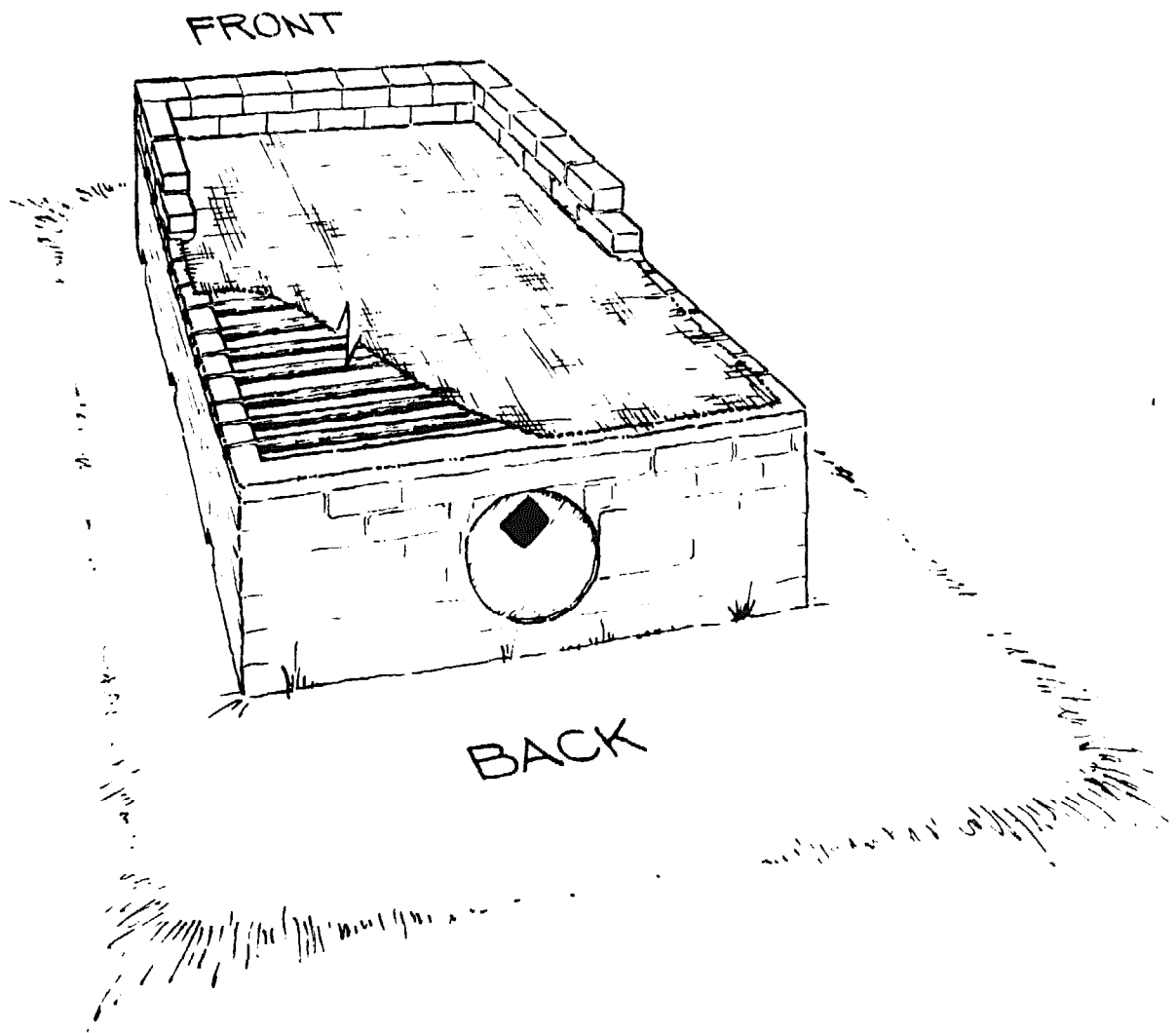

- Fill the spaces between the logs with mortar up to the tops of the logs.
- Build up the front and back walls and the corners of the dryer to the same height as the tops of the logs.
- While the mortar is still wet on the tops of the four walls, lay the screen you have made in place on top of the logs. Center it so about the same width extends over each wall. Stretch any wrinkles or kinks out of it.
- Place a thick layer of mortar over the screen the width of the wall so that it fills the holes in the screen and gives a good base to lay mudblocks on. Lay mudblocks in the usual way.



### A Simple Oil Barrel Dryer

- . Lay down two layers of mudblocks above the screen. This will make a drying chamber a little more than 30cm deep, which should be plenty for the most bulky grains, such as maize on the cobs.
- . Smooth any rough spots on the tops of the walls, so no bumps or loose pieces will be knocked into the dryer when it is in use.

9. Build a chimney.

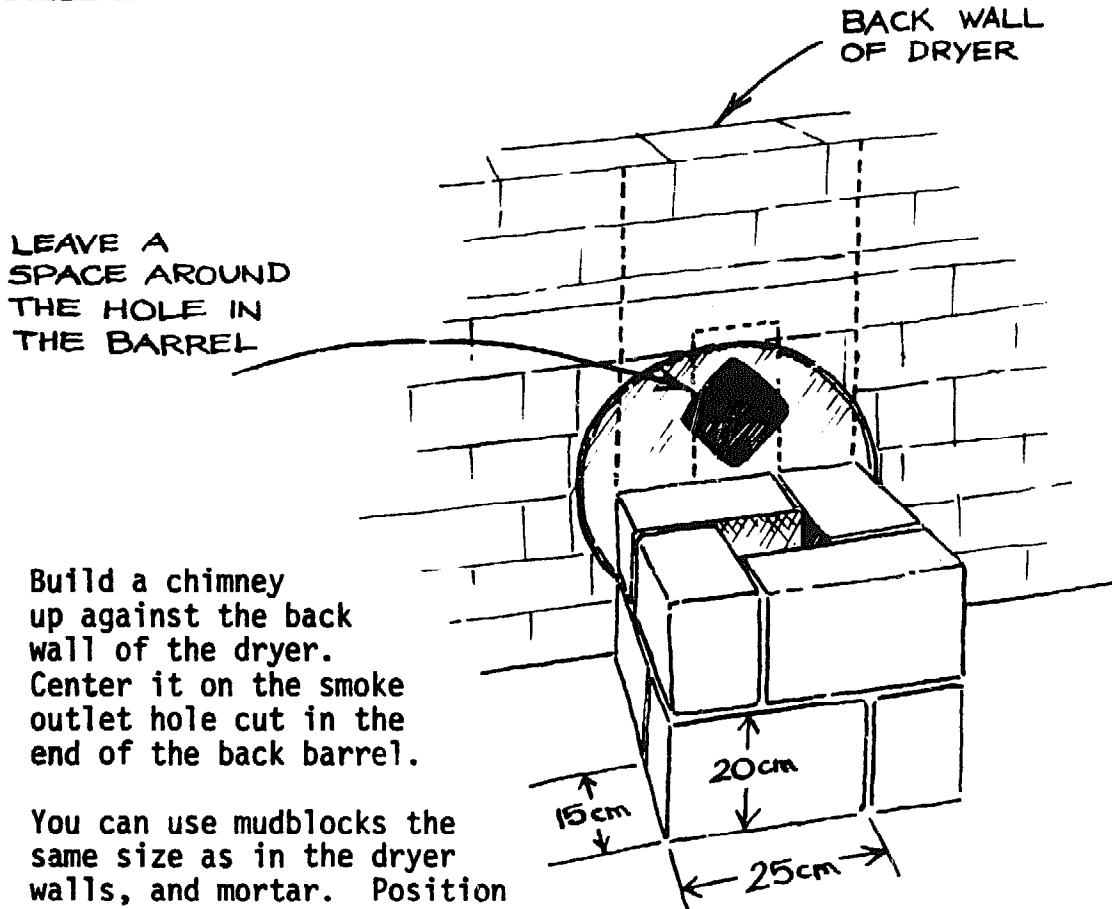

- . Build a chimney up against the back wall of the dryer. Center it on the smoke outlet hole cut in the end of the back barrel.
- . You can use mudblocks the same size as in the dryer walls, and mortar. Position the 20cm edges vertically. This will give about a 12 x 12cm smokehole in the center, which is large enough to allow easy smoke escape, but small enough to keep down heat loss from the barrels.
- . Leave a space in the chimney wall against the hole in the barrel end. It will start after two layers of blocks and be about two layers high. Fill in irregular-size spaces in the brickwork with cut blocks or mortar. Center a full-size block over top of the space you have made. Continue laying blocks until the chimney rises at least 1/2 meter above the tops of the dryer walls. This will keep smoke out of the drying grain.
- . Make sure the chimney is sealed and free of cracks, so there is only one way for smoke to go: through the hole in the barrel end and out the top of the chimney hole.

INSTRUCTIONS FOR USING THE OIL BARREL DRYERS

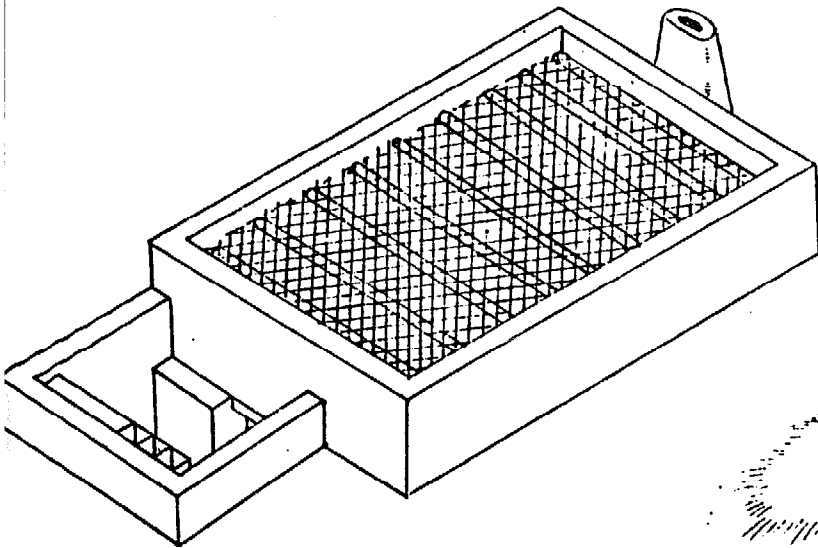

*Pit Barrel Dryer*

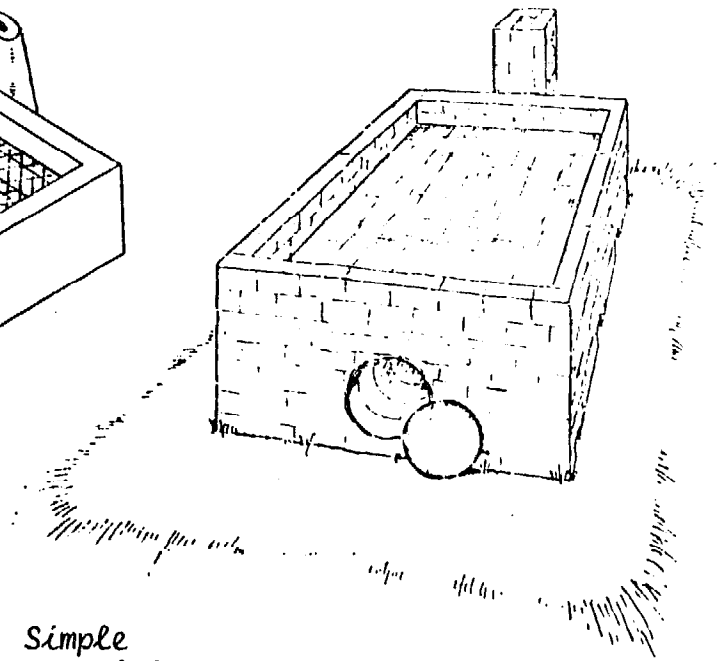

*Simple  
Barrel Dryer*

1. A shelter over the dryer will protect it and drying grain from rains. Build an open-sided one to overhang the dryer at least 1/2m on each side, and more on one side if you wish to have room for storing fuel, a work area, etc.
2. Gather dry wood, maize cobs or other fuel before drying begins.
3. Build the fire in the first barrel or mid-way into the second barrel.
4. Prop one of the cut-off barrel tops against the front opening into the barrels on a block or a rock to adjust a good draft for the fire. A piece of a barrel top can also be placed part-way over the top of the chimney to give you more control of the draft.
5. Watch and control the fire at all times during drying. Do not dry with too large a fire: you may kill or scorch the grain. A medium size fire will give the best distribution of heat.
6. If you have trouble getting enough heat, in the Simple Dryer you may try partly covering the side vents to get a better draft up around the barrels.

*Using the Oil Barrel Dryers*

7. You can modify the dryers by installing a fan or fans to push a steady flow of air up around the barrels and through the drying grain. The resulting larger volume of less-hot air will dry the grain faster and with little danger of overheating.
8. The dryers will take some time to reach operating temperature while the walls are heating. Continue drying operations day and night to make best use of the heat built up in the dryer. Load it with a fresh batch as soon as the one before is dry.
9. Limit the drying temperature for food grains to 50-55°C. The bottom layer of grain should not be too hot to hold in your bare hands. Grains for livestock feed may be dried at higher temperatures. Do not dry rice, beans or any grain to be used for seed in these dryers -- unless you install fans, and even then proceed cautiously. These grains must not be heated to more than 45°C.
10. Do not stir the drying grain. Grain in the top layers receives moisture passed up from the warmer grain at the bottom, and gradually releases it as drying is completed. If you stir these wetter kernels down again, they will re-wet the drier kernels that got stirred up to the top -- and drying will take longer. Stir only to release the heat if overheating occurs.
11. Dry grain until the moisture content is about 12%. Grain is dry when a kernel is hard and breaks between your teeth with a sharp crack.
12. Load small grain such as millet and sorghum in a layer 5-8cm deep. Shelled maize and other grains may be loaded up to 10cm, groundnuts up to 20cm, and maize on the cobs up to 30cm.
13. Maize may take one to two days to dry.
14. Do not let dirt build up in the dryer. Do not let the air vents that let air up around the barrels get clogged. Keep the area clean.
15. Check for rust holes in the barrels and for cracks in the joints. Replace badly rusted barrels and re-seal cracked joints. Smoke leaking into the drying grain will discolor it and change its taste and smell.
16. If you need to get up on the dryer floor while loading or unloading grain, avoid tearing the screen or mats -- do not stand in the spaces between the log supports.
16. If one of the logs supporting the screen in the Simple Barrel Dryer becomes weak or rotted, you will be able to replace it by chipping some of the mortar away from each end, and pulling or knocking it out. Slide in a new log and mortar the spaces around the ends.

## THE PIT OIL BARREL DRYER

This dryer is based on a plan prepared in 1974 by American Peace Corps Volunteers in Benin, West Africa. It is called the Oil Barrel Dryer simply because it is made from oil barrels. It actually has received different names depending upon the country where it was used. The first oil barrel dryer was built in Samoa to dry coconut meat. Since then, this dryer has been built and tested in a number of countries, including Nigeria and Benin. The dryer also is known as the Low Cost Bush Dryer and the Brooks Dryer.

### Proven advantages of the Oil Barrel Dryer:

- . It is useful in areas where grain must be harvested in rainy weather.
- . Maize on the cob can be dried without long drying in cribs and use of contact insecticides.
- . Construction materials are easy to find in most places.
- . Farmers can build the dryer with little assistance or supervision.
- . It dries a lot of grain in a short time.
- . Grain can be harvested earlier. Because there is less drying time in the field, there is less danger of insect and rodent damage.

### Possible disadvantages (depending upon area or situation):

- . It is a better dryer for a group of farmers than it is for one farmer. One farmer would not need it very much during a year. Sharing by a group of farmers means more use and less expense to each farmer in building.
- . The fuel used in this dryer is often firewood; sometimes maize cobs also are burned. Firewood is becoming harder to get and more expensive in many places.
- . There is no fan included in this plan to force air through the heating chamber and the grain bed. Small gas motors needed to drive fans often are very expensive.
- . It should not be used for grain which will be used for planting.

### The Pit Oil Barrel Dryer

- . It would be worthwhile to find other economical natural fuels (like maize cobs).
- . Banco construction (hand-rammed earth) works only where there is a high clay content in the soil.

Fans placed to drive the warmed air around the outside of the barrels up through the drying grain would increase the efficiency of the dryer. It will be necessary to find a suitable power source for the fans. In areas where there are many small motor bikes, it must be possible to construct a power drive made from a motor bike which permits temporary hook-up and easy detachment of the bike as a power source.

The dryer is made of hand-rammed earth, known in different areas as banco, terre de barre, adobe, etc. The maize or other grain is placed on a screened drying floor. This floor is placed above a firebox made of three 220 litre metal oil drums joined together end to end.

You may substitute an available local material that will be as strong and resistant to wear and heat as the banco, such as burned brick. Sand-crete (cement and sand) or concrete blocks will crack with the heat. If banco is already used for construction in your area, the same high-clay content soil will work well for the dryer. You may mix in cement with low-clay soil to allow you to build the earthen walls.

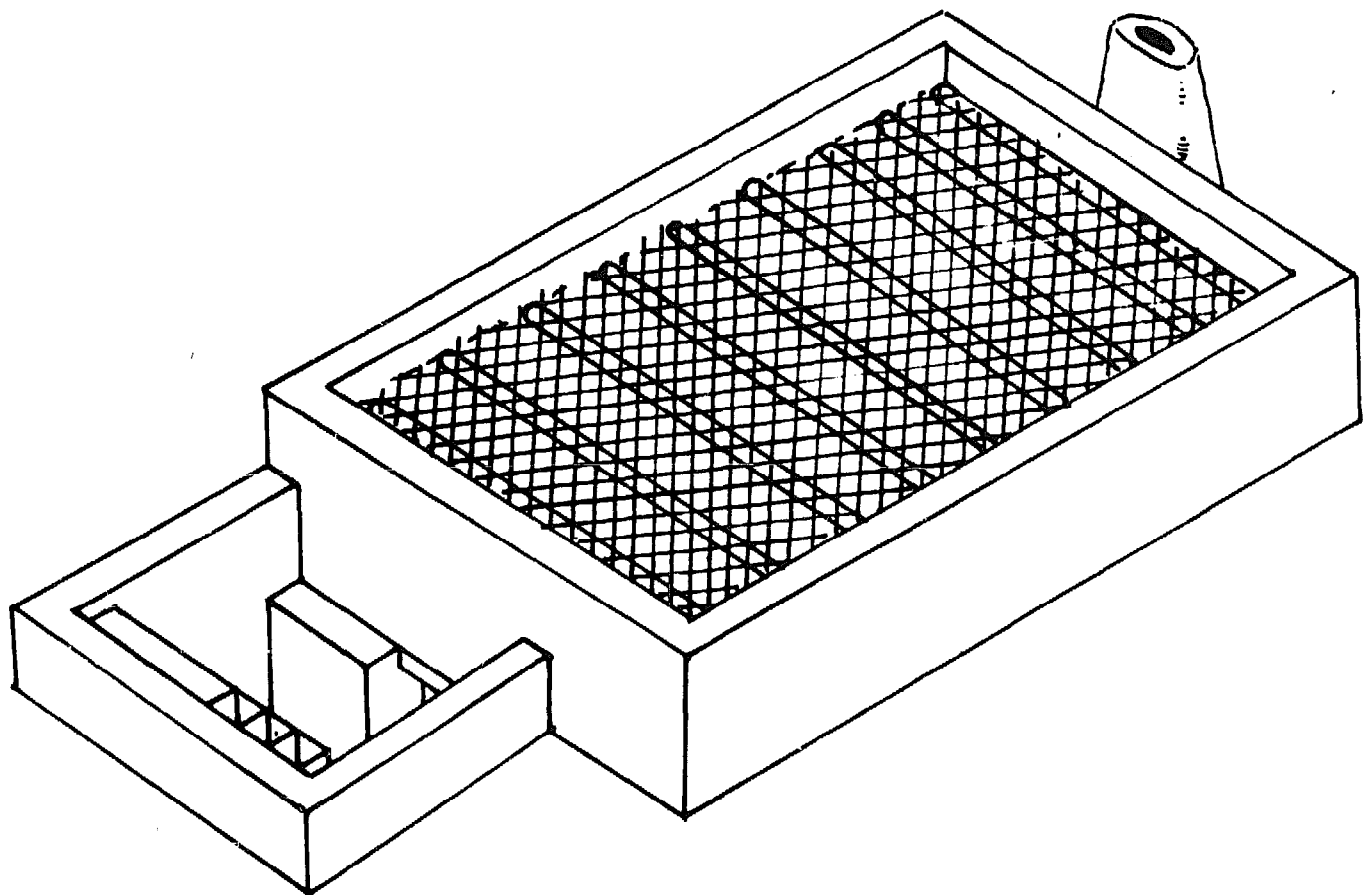

*The Pit Oil Barrel Dryer*

READ THE INSTRUCTIONS THROUGH BEFORE YOU BEGIN.

Tools and Materials

- . 3 oil barrels, 220 litres each
- . 9m<sup>2</sup> chicken wire or other screen, or a combination of screen and woven mats
- . Iron or steel "re-rod" (reinforcing armature) for lintels. 6mm diameter, 6m long
- . Materials for concrete: 25kg cement  
1/2 barrel sand  
1/4 barrel gravel
- . Heavy wire, about 2m
- . Thin wire, about 15m
- . 10 logs, 8-10cm diameter, 2, 15m long
- . 2 strips of small mesh screen, each about 180cm long, and a few cm wide.
- . Digging tools

1. Select a site.

- . Find a place for the dryer which is high and well-drained. If you dig too near a tree, roots will get in your way. If you are in a swampy or drainage area, water will get into the dryer and wear away the walls.

2. Make 2 lintels.

- . The lintels are concrete horizontal slabs which will support the weight of the walls over the barrels.
- . Make two forms out of boards or bricks. Line them with paper. The forms should each make a finished lintel which measures 120cm x 30cm x 8cm.
- . Cut the re-rod into 6 equal pieces each measuring 1m long.
- . Mix concrete in this proportion: 1 part cement  
2 parts sand  
3 parts gravel.  
Mix sand and cement thoroughly first, then mix in gravel. Then add just enough water to make the concrete thick and smooth, but not watery.

The Pit Oil Barrel Dryer

- Pour concrete into the forms up to a level of 4cm and tamp firmly.
- Lay 3 pieces of 1m re-rod on top of the 4cm of concrete in each form. Space them evenly, with the outside pieces about 3cm from the edge.
- Finish pouring concrete into the forms. Tamp firmly and level off the top surfaces.
- Cover them and keep them out of the sun or cover with grass. Keep them damp for about 7 days by sprinkling three times a day. This slow drying cures the concrete to its greatest strength.

3. Stake out the drying chamber and stoking pit.

- Stake out the drying chamber, as shown, on the site you have chosen. It will be 2,80m x 3m.
- Make sure the dryer chimney is staken out downwind of the prevailing wind during the season when the dryer will be used most. This is important -- it keeps the smoke from blowing back into the drying grain.
- Stake out the stoking pit against the upwind 2,80m side of the drying area. Make the stoking pit 2m x 2,1m. One of the 2,1m sides should be right next to the upwind 2,8m side of the drying chamber area.

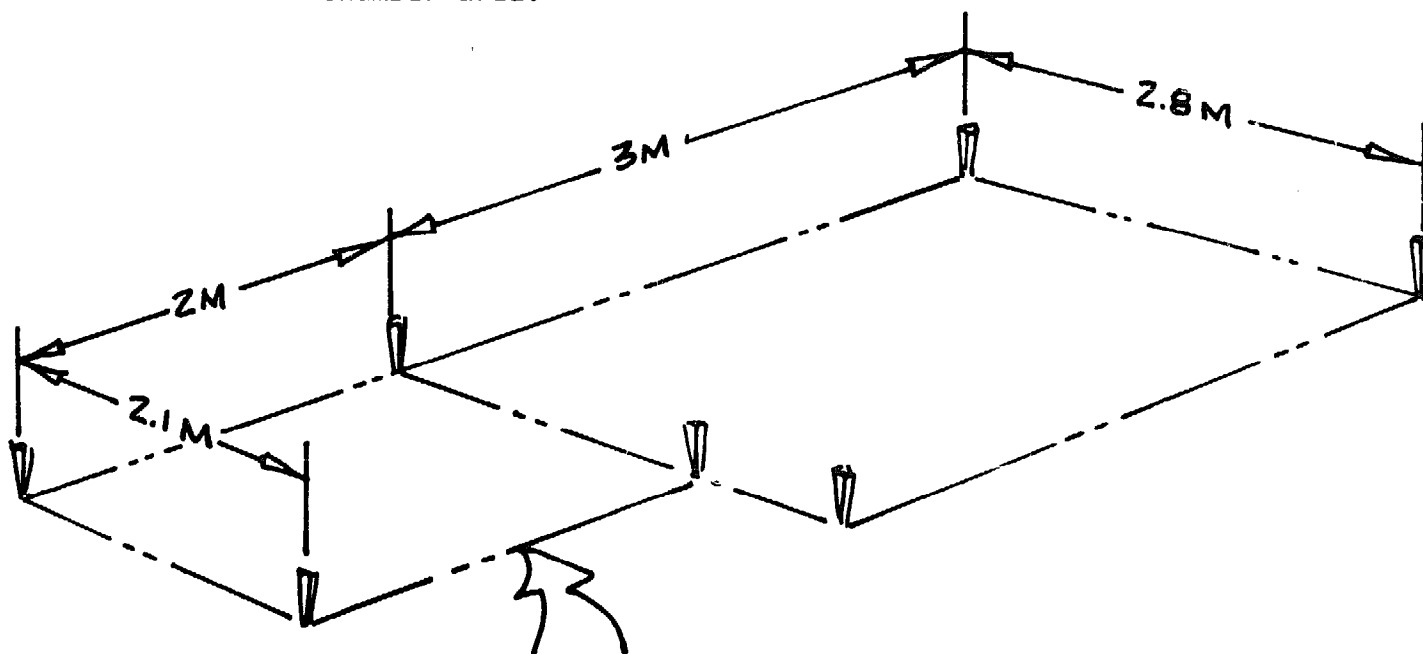

ON UPWIND SIDE OF DRYING CHAMBER-  
STAKE OUT THE STOKING PIT

The Pit Oil Barrel Dryer

4. Dig top soil out of the staked areas.

- . Dig the staked out areas to a depth where you come to hard-packed earth that will make a good foundation. We will use 30cm in this plant. Pile all top soil to one side so it will not get mixed with the banco when it is later wetted and used to construct the walls.

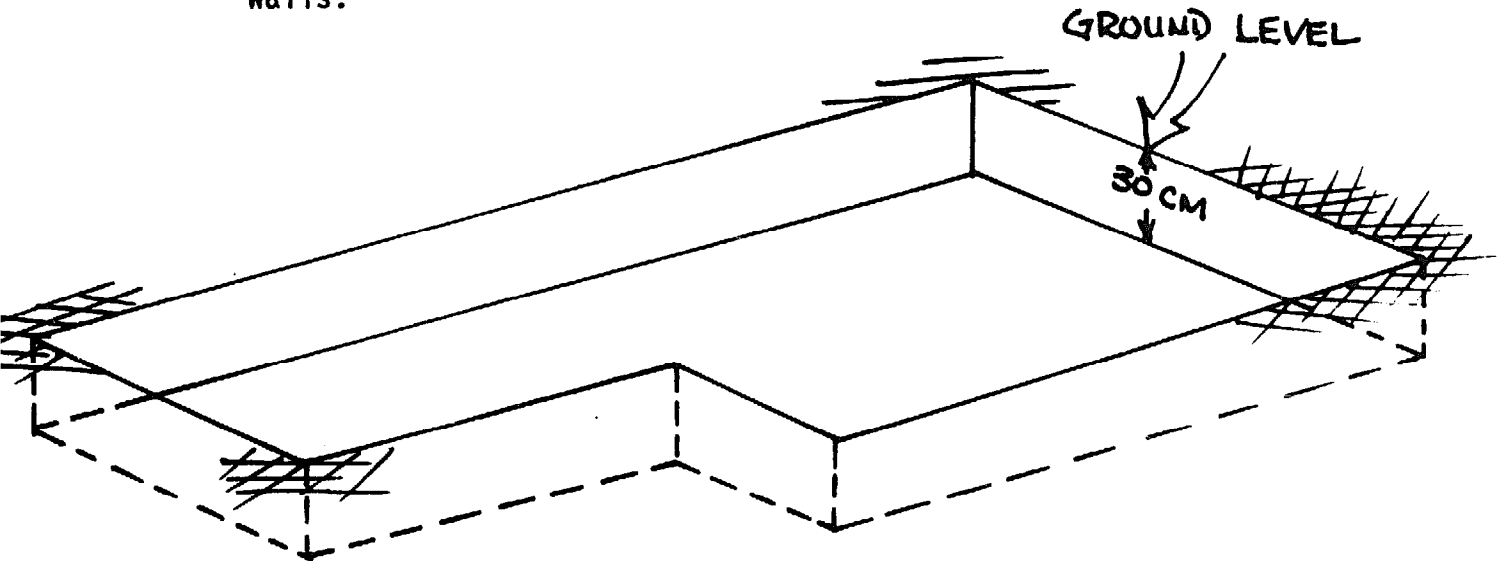

5. Dig a trench in the center of the staked out area.

- . Dig a trench centered in the middle of the drying area 70cm wide and 140cm deep -- from ground level. It should extend 4,80m from the chimney end of the drying area. This will leave 20cm un-dug at the opposite end for a retaining wall for the stoking pit.
- . Keep the dirt you remove separate from the top soil you removed before.

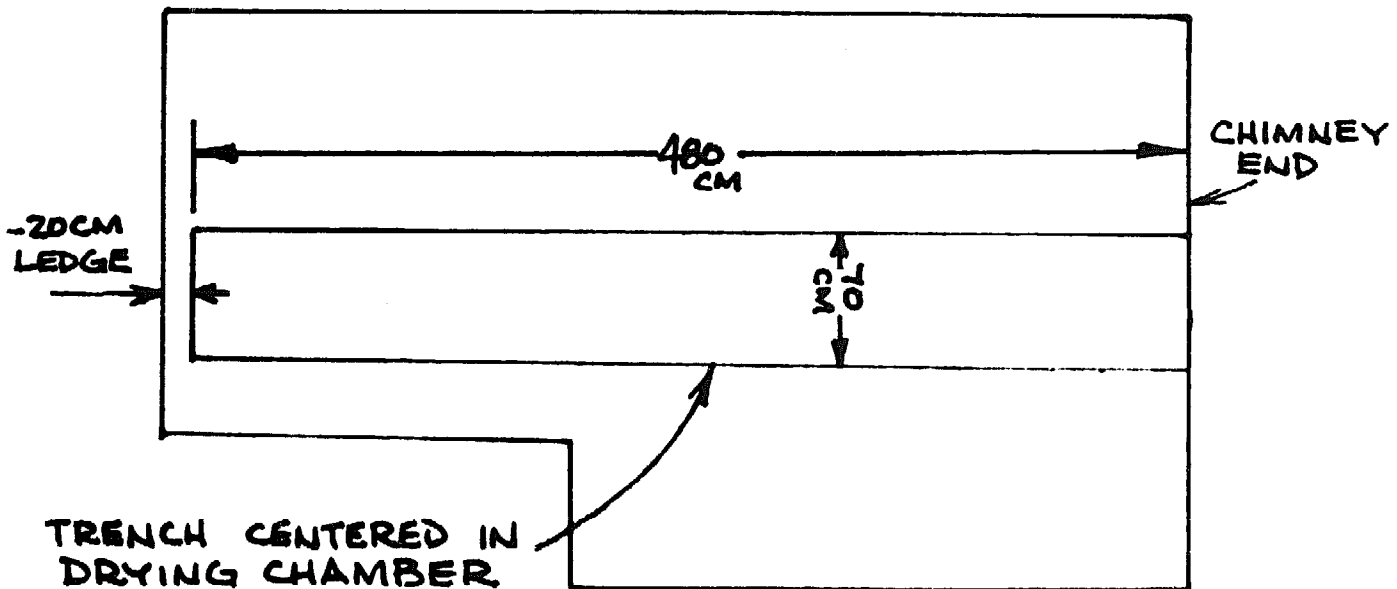



The Pit Oil Barrel Dryer

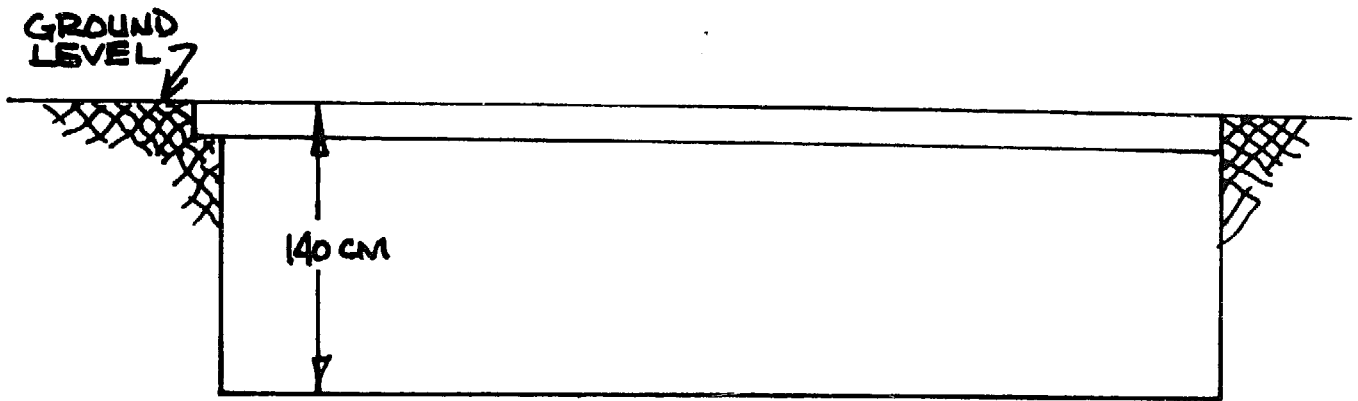

6. Make cut-outs for the lintels.

- Mark points at 2,70m and 3m from the chimney end on both sides of the trench.
- Remove the soil between these marks, and extending from the edge of the trench to a distance 30cm back. Dig it down 40cm. This will place the bottom surface 70cm up from the trench floor.
- Make two more slots up against the chimney end. They should be 30cm wide, 30cm long and dug down 35cm, or until the bottom of the slot is 75cm up from the trench floor.

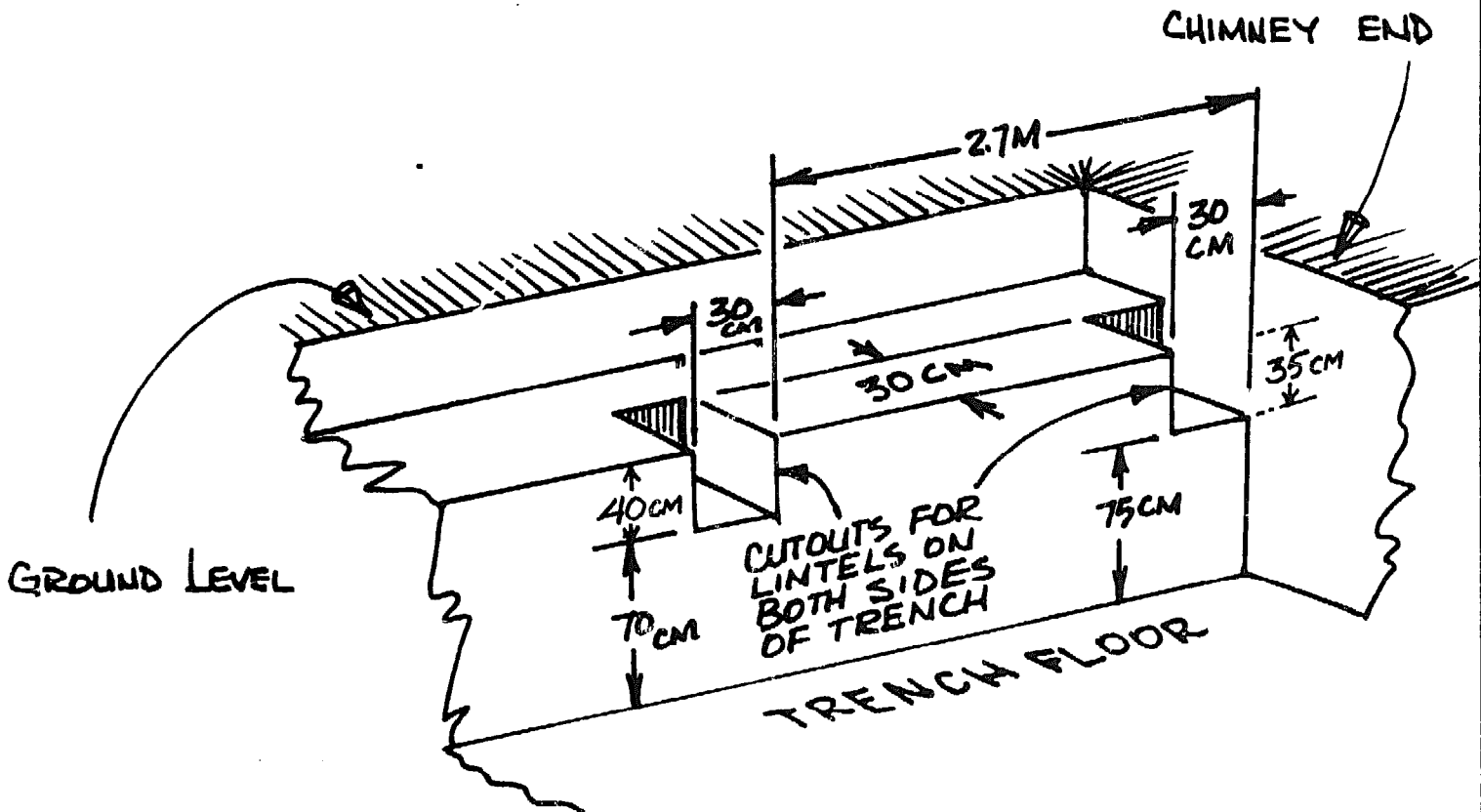

The Pit Oil Barrel Dryer

7. Make cut-outs for the chimney.

- . The chimney hole should be dug into the soil at the back wall of the drying area. Centered at the end of the drying area, dig out an area 30cm wide, which extends back 30cm beyond the drying area to a depth of 30cm below the ground level.
- . Also centered at this end of the drying area, dig another area 15cm wide, which extends 15cm back. This channel will extend below the hole just completed until it is 50cm from the trench floor.

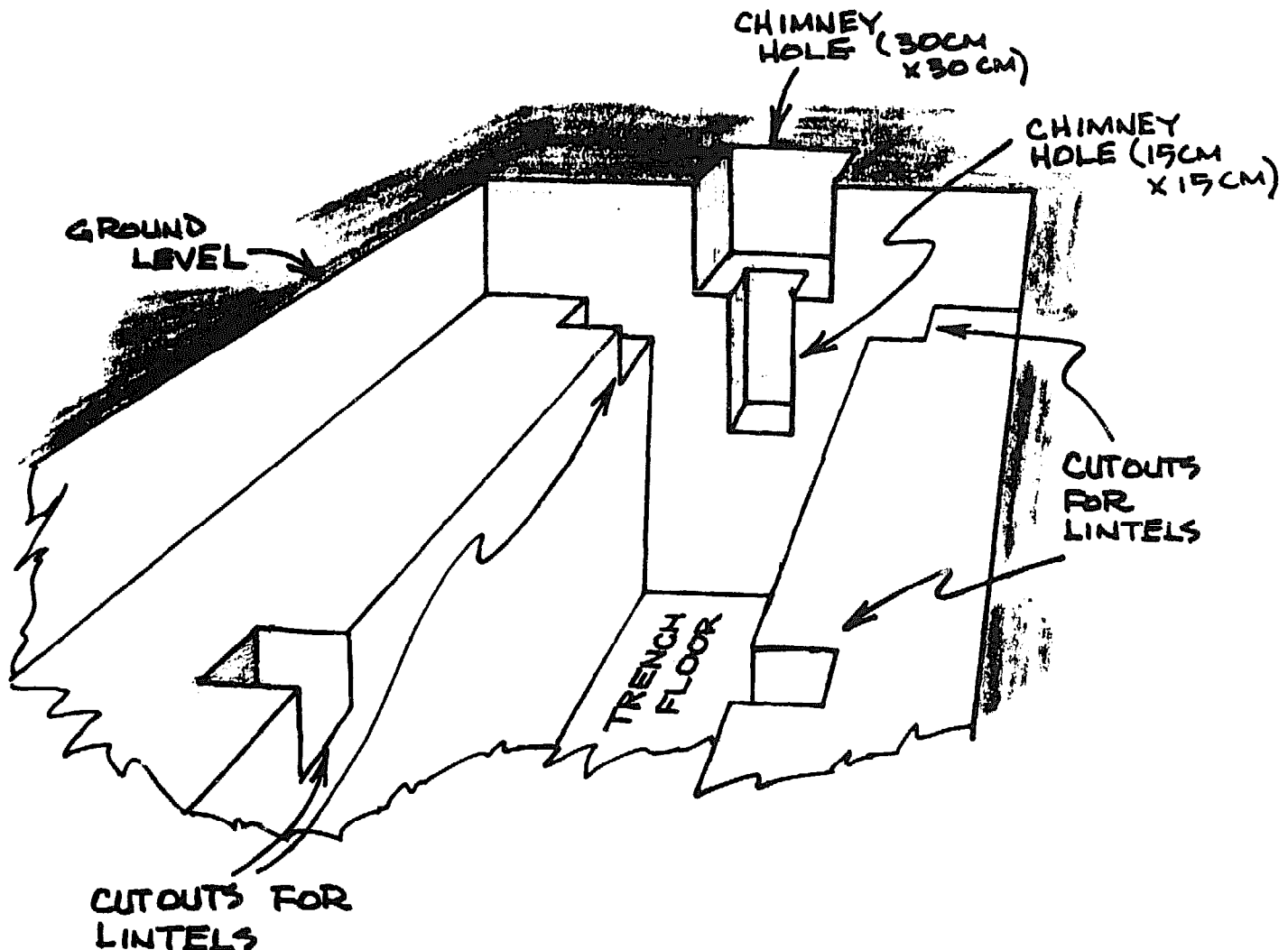

8. Place the lintels.

- . Lay a 5cm layer of banco in each of the four lintel slots. Lower the lintels into place. Make sure they are level, and square with the side walls of the dryer.

The Pit Oil Barrel Dryer

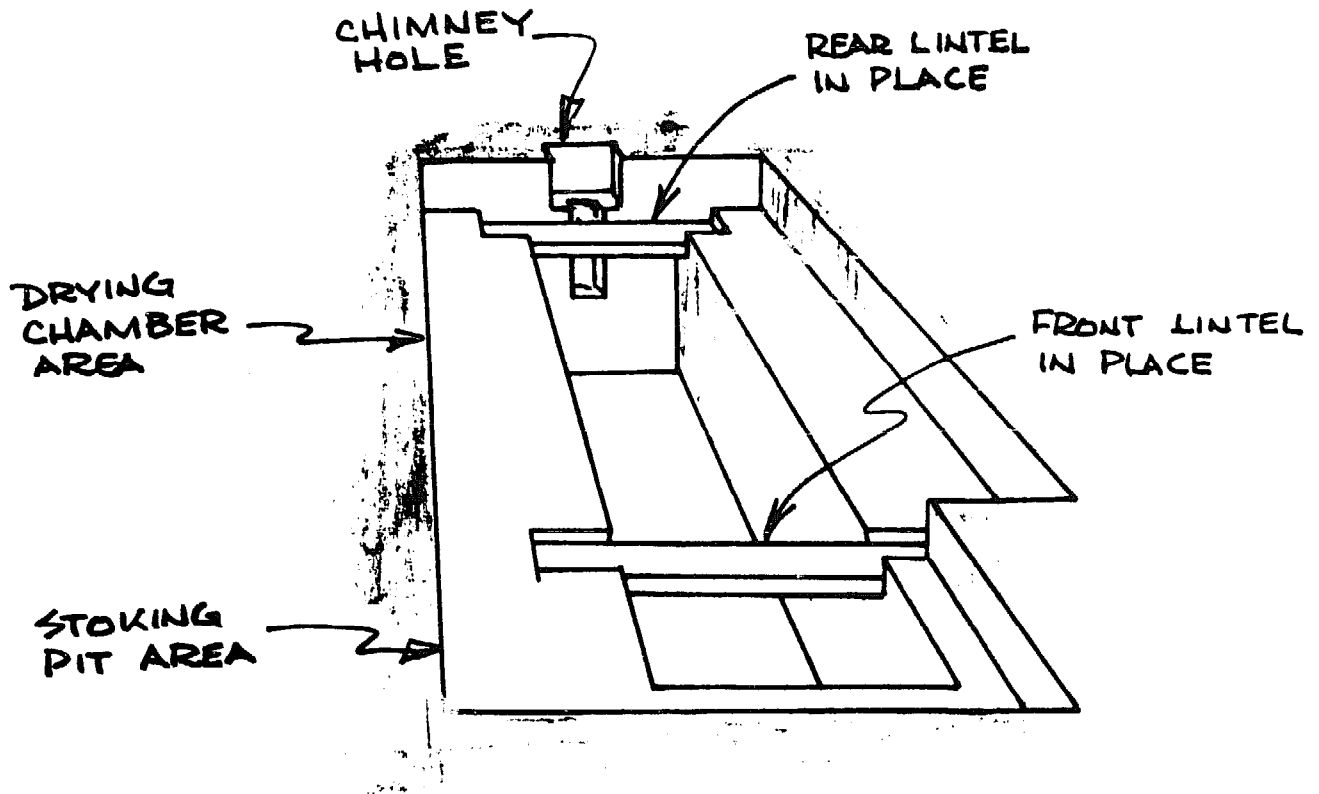

9. Build the dryer walls.

- . Make the front and back walls -- over the lintels -- 30cm thick.
- . Build the side walls up from the floor of the original 30cm deep pit that you have dug out. Make them 45cm thick until they reach a height of 90cm above the base of the front lintel. At this point reduce their thickness to 30cm, leaving a 15cm wide ledge on the inside of each side wall. This ledge will support logs for the drying floor.
- . The height you may build the walls in one day will depend on the quality and consistency of the banco.
- . Before the walls are too high, remove some of the dirt between each side of the oil barrel trench and the side walls. Make a slope on each side of about 45° starting at the inside edge of the base of each side wall and extending down to meet the sides of the barrel trench about 40cm above the floor of the trench.
- . Embed a strip of chicken wire, or other wire mesh you have chosen to use, into each of the walls, 10cm above the 15cm ledge you have made. Each of the strips is 20cm wide and is as long as the wall it is placed in. 10cm of the wire should stick out flat into the drying area. Later these strips will attach to the drying floor screen.

The Pit Oil Barrel Dryer

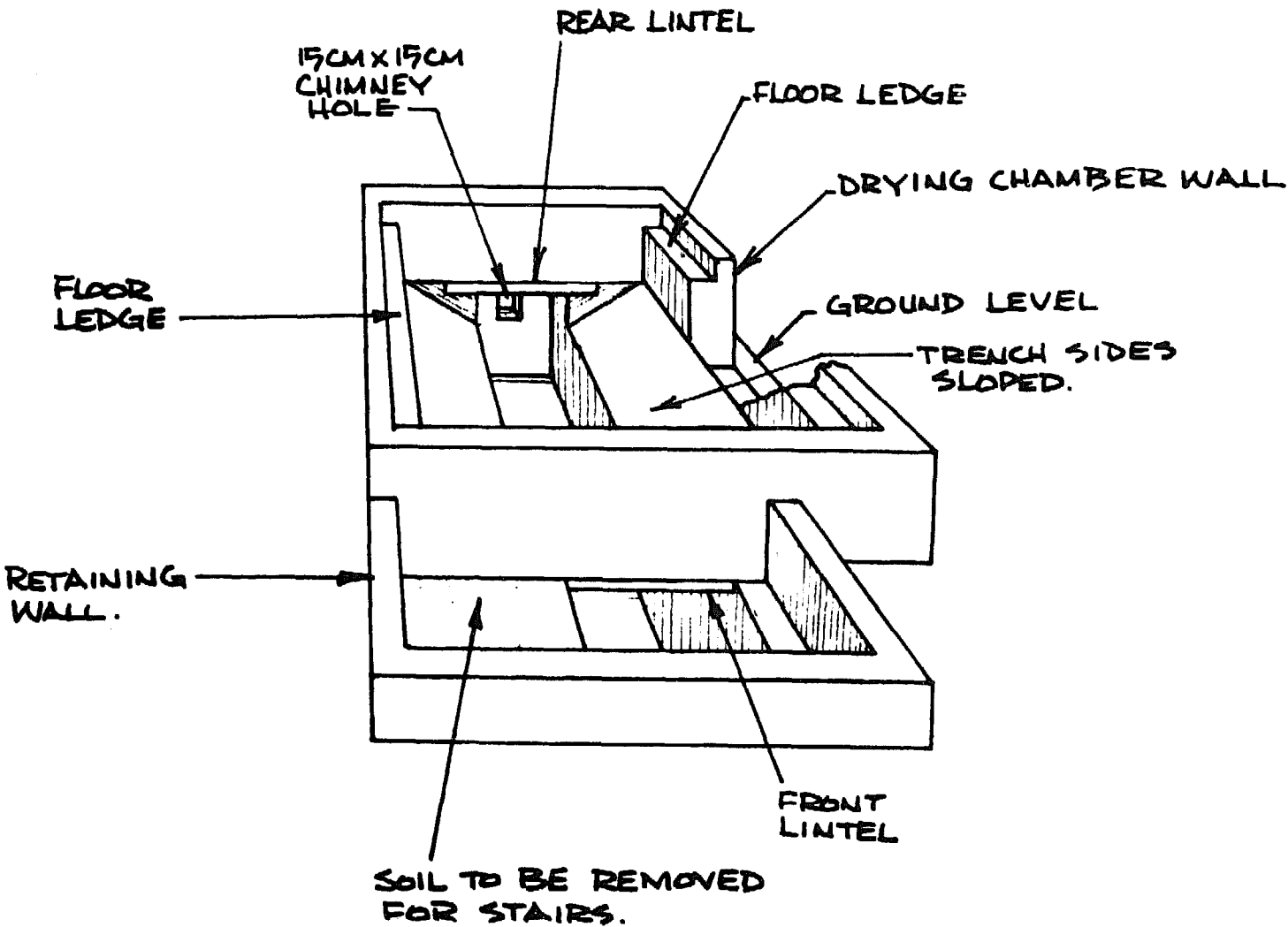

The Pit Oil Barrel Dryer

- Continue the front, back and side walls until they rise 40cm above the wire strips. The top of the finished dryer walls will be 75cm above ground level.

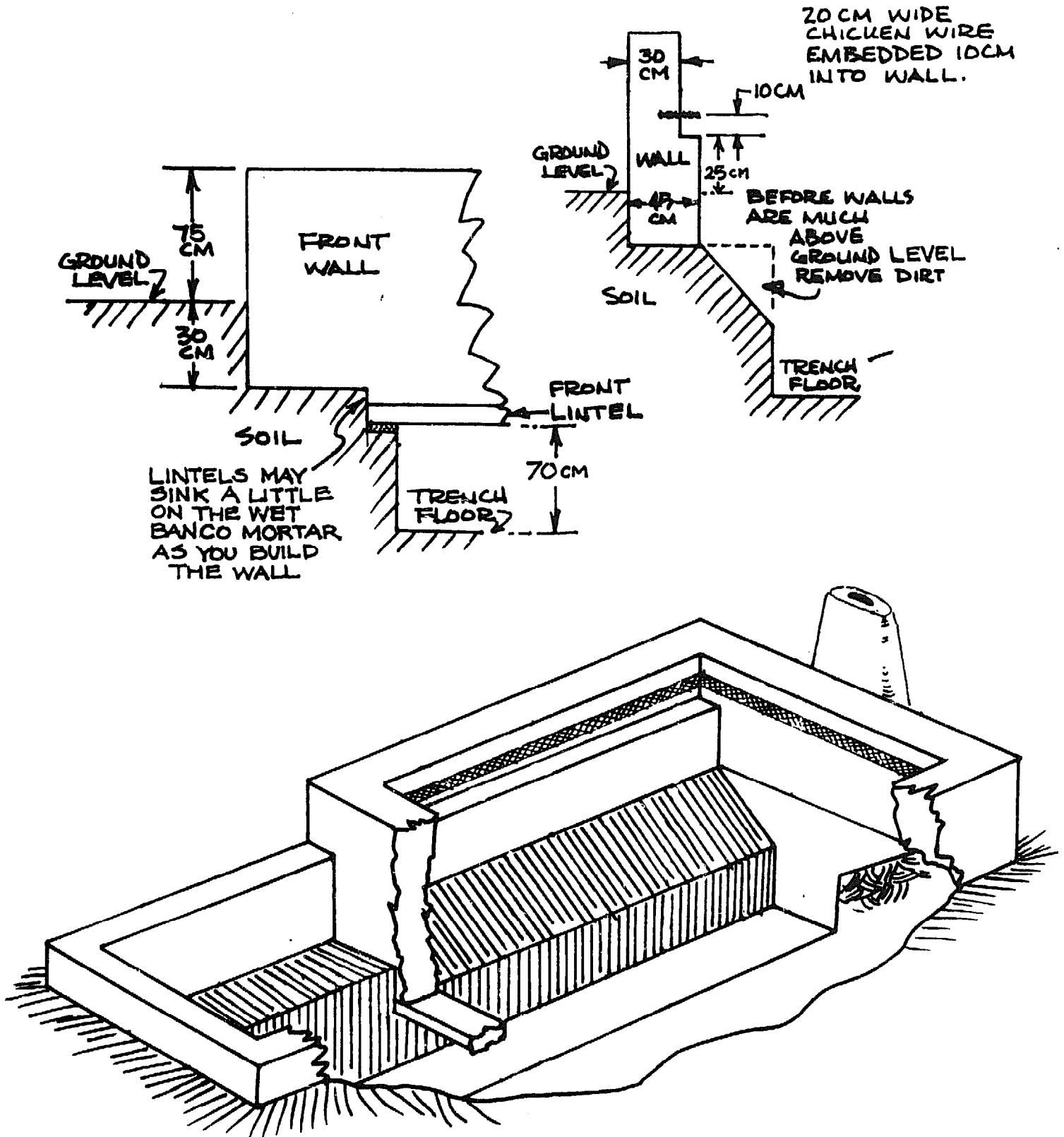

The Pit Oil Barrel Dryer

10. Build a retaining wall around the stoking pit.

- . The retaining wall protects against erosion and will keep dirt and trash from falling into the pit.
- . Build the retaining wall up from the floor of the original 30cm deep pit that you have dug out. Build it on three sides of the stoking pit area. The fourth side is spanned by the front wall of the drying area.
- . Make it 20cm thick. The front wall of the stoking pit will fit exactly on the 20cm ledge you left at the front end of the 140cm deep trench that extends down the center of the dryer and stoking pit.
- . Build all three sides 50cm up from their base. This will bring them 20cm above ground level.

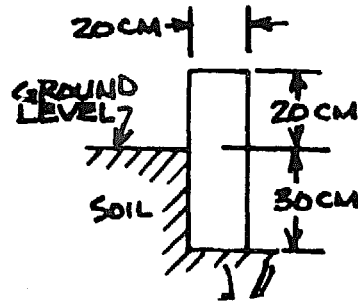

11. Build the chimney.

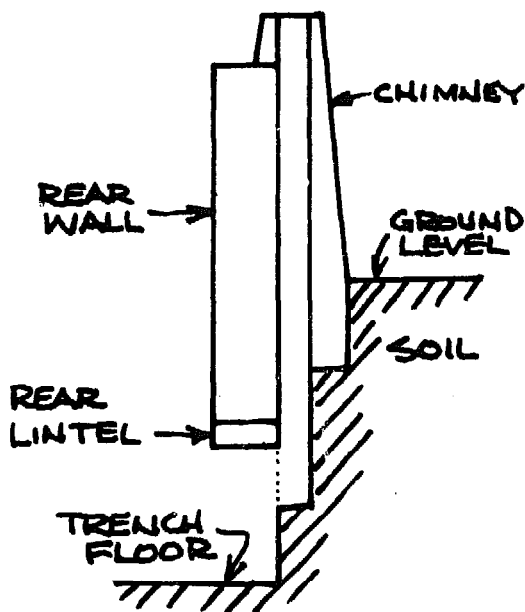

- . Build the chimney walls out of banco up from the bottom of the larger, top hole you have dug out at the end of the dryer. The inside faces of the chimney walls should be flush with the sides of the lower, smaller hole that is dug into the bottom of the top hole.
- . Extend the chimney 20cm higher than the top of the back dryer wall. As you build upwards, gradually narrow the inside passage of the chimney until it measures about 10cm x 10cm at the top. This will help reduce heat loss.

12. Finish the stoking pit.

- . Cut stairs in the dirt next to the stoking pit. Make four equal steps each 30cm high and 40cm across.
- . Leave a ledge 30cm thick between the lowest step and the front dryer wall, to help brace the dryer wall.

The Pit Oil Barrel Dryer

- You may excavate any dirt that is left in the stoking pit so that the dirt walls in the front and opposite the stairs are flush with the inside surfaces of the retaining wall which rests on them.

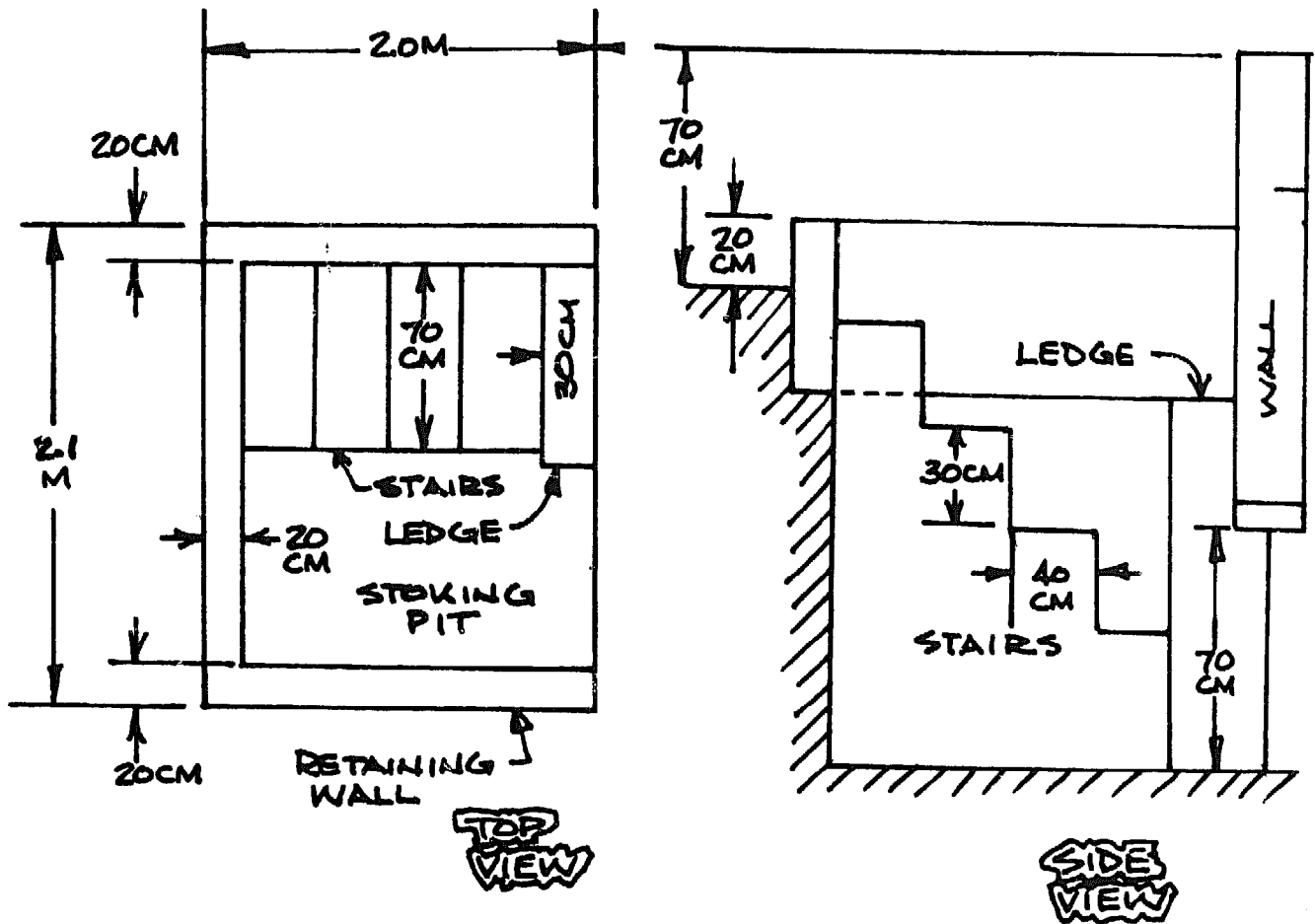

13. Assemble and place the firebox barrels.

- Cut both ends from two 220 litre barrels.
- Cut one end from a third barrel. Cut a hole 20-30cm across near the edge of the other end of this barrel. This will be placed up against the opening at the bottom of the chimney.
- Punch four evenly spaced holes around the rim of each barrel where it will join another barrel.
- Join the three barrels together by tying pieces of heavy wire through the punched holes.
- Locate the barrel assembly in the trench with the small hole in the end of the third barrel placed up against the bottom opening of the chimney.
- Support the barrels on bricks about 10cm above the bottom of the trench. Incline them slightly upwards towards the chimney for easier smoke escape. This will allow air to circulate all around the barrels and will also prevent rusting.

The Pit Oil Barrel Dryer

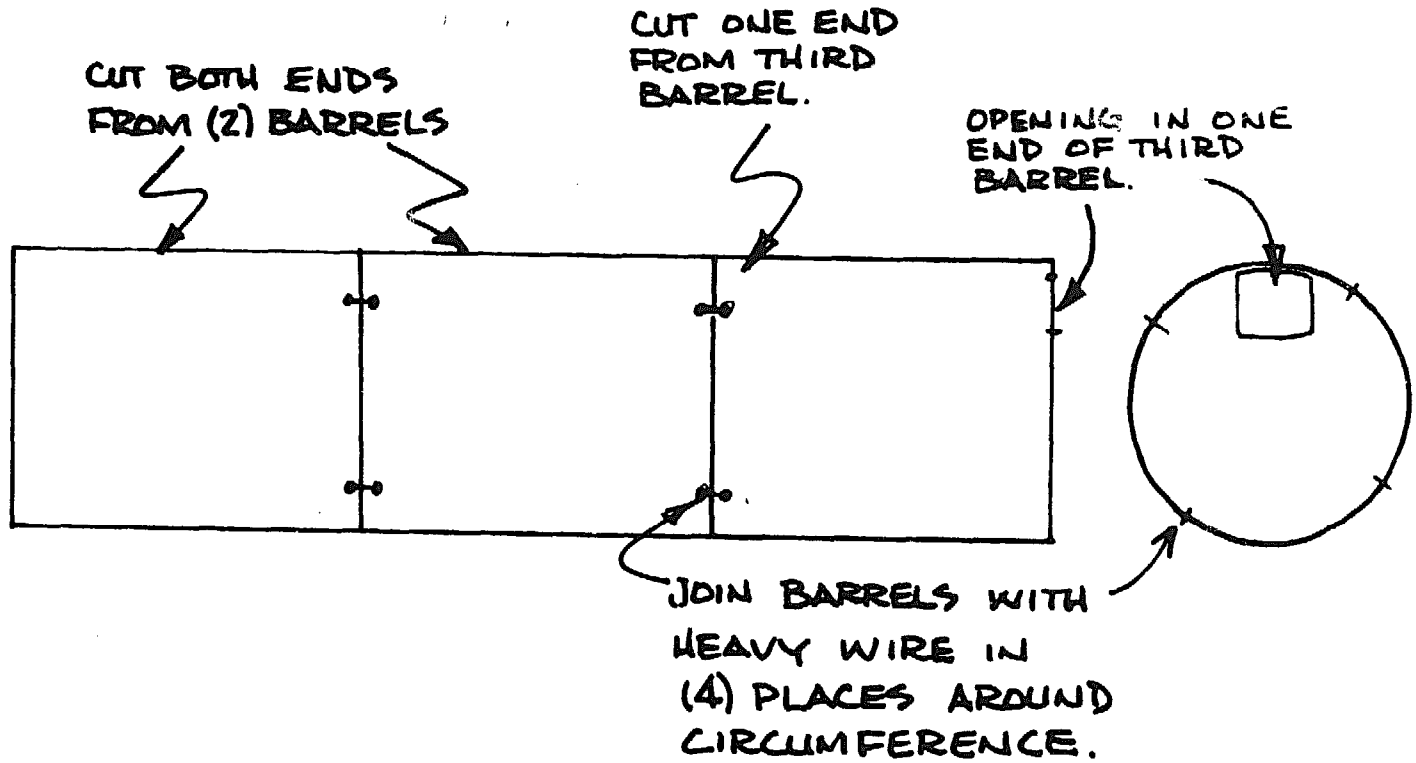

LOCATE BARRELS IN TRENCH WITH HOLE IN END AT THE TOP, NEXT TO CHIMNEY

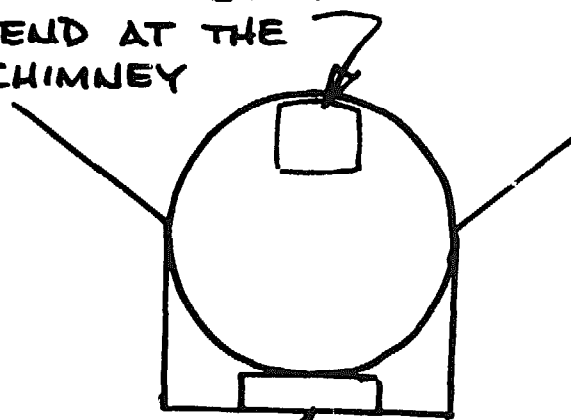

SUPPORT WITH BRICKS OR STAVES (10 CM THICK).



The Pit Oil Barrel Dryer

- . Seal the joints between the barrels by placing a strip of screening around them and plastering with a mixture of mortar (1 part cement to 8 parts sand).
- . Close the trench around the barrel assembly ends under the lintels with banco. Make sure you seal completely around the barrel at the chimney end to prevent any smoke "backflow". Close the front end of the barrel assembly only around the top of the barrel to let cool air enter the drying chamber -- this cool air is warmed and will rise up through the drying floor and grain.

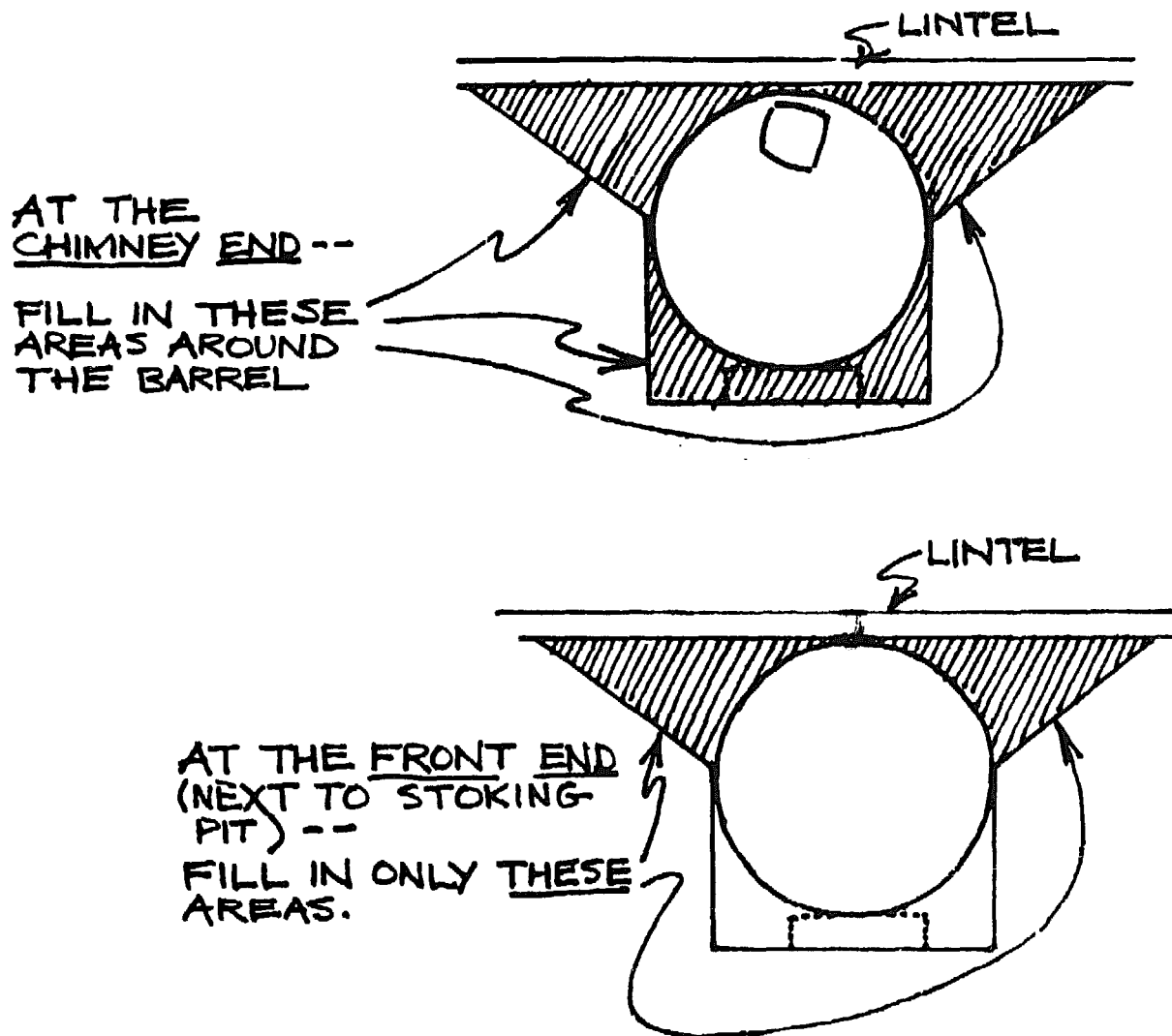

- . Test the seals at the joints. Light a smoky fire and see if smoke escapes into the drying chamber. Do not let it burn long enough to dry the mortar on the joints. Keep the mortar damp until it is hard.

*The Pit Oil Barrel Dryer*

14. Assemble the drying floor supports.

- . Use 10 logs of solid wood. The logs should be 8-10cm in diameter and 2,15m long.
- . Space the logs evenly across the drying chamber from one end to the other. The log ends will rest on the 15cm ledges in the side walls. Resting the logs on the ledges instead of fixing them in place means they can be replaced more easily if they weaken.

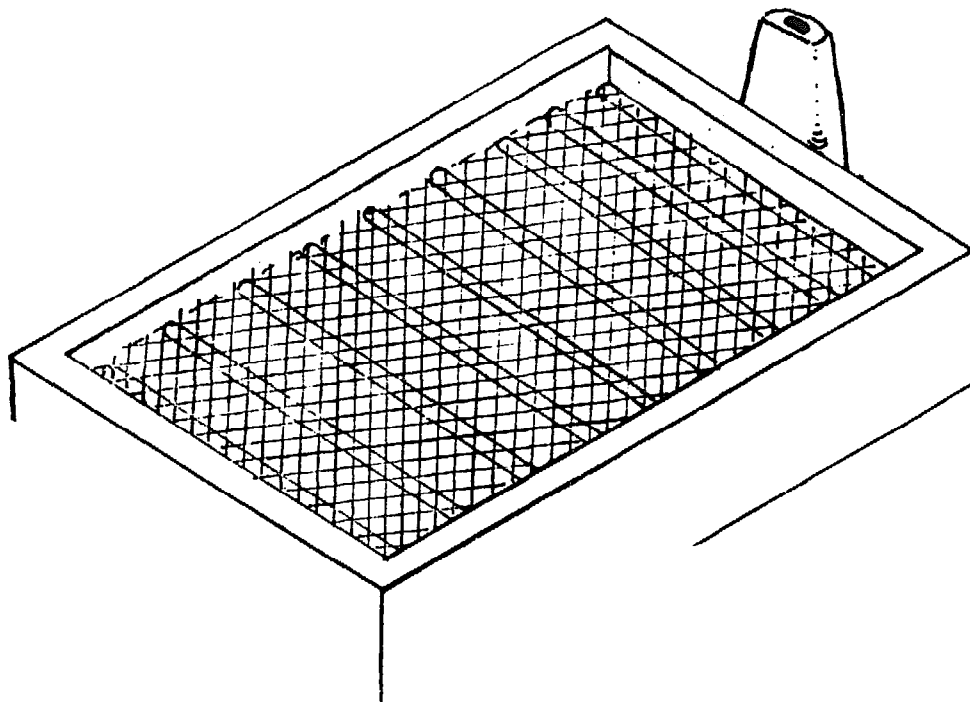

15. Place and fasten screening on top of the log supports.

- . Stretch screening across the logs and attach it to the 10cm of wire mesh sticking out from each wall. Make the screening longer than the inside length of the chamber because the weight of grain will make the screen sag between the logs. Overlap all sections 5 or 10cm and fasten together with thin wire.
- . Small mesh screen is best. But chicken wire can be used. Place straw mats over chicken wire, or other large-hole screen, to keep grain from falling through the holes. Some kinds of woven mats are very strong. These can be used in place of screening. Fasten woven mats to wire mesh strips embedded in the walls the same as you would metal screen.

The Pit Oil Barrel Dryer

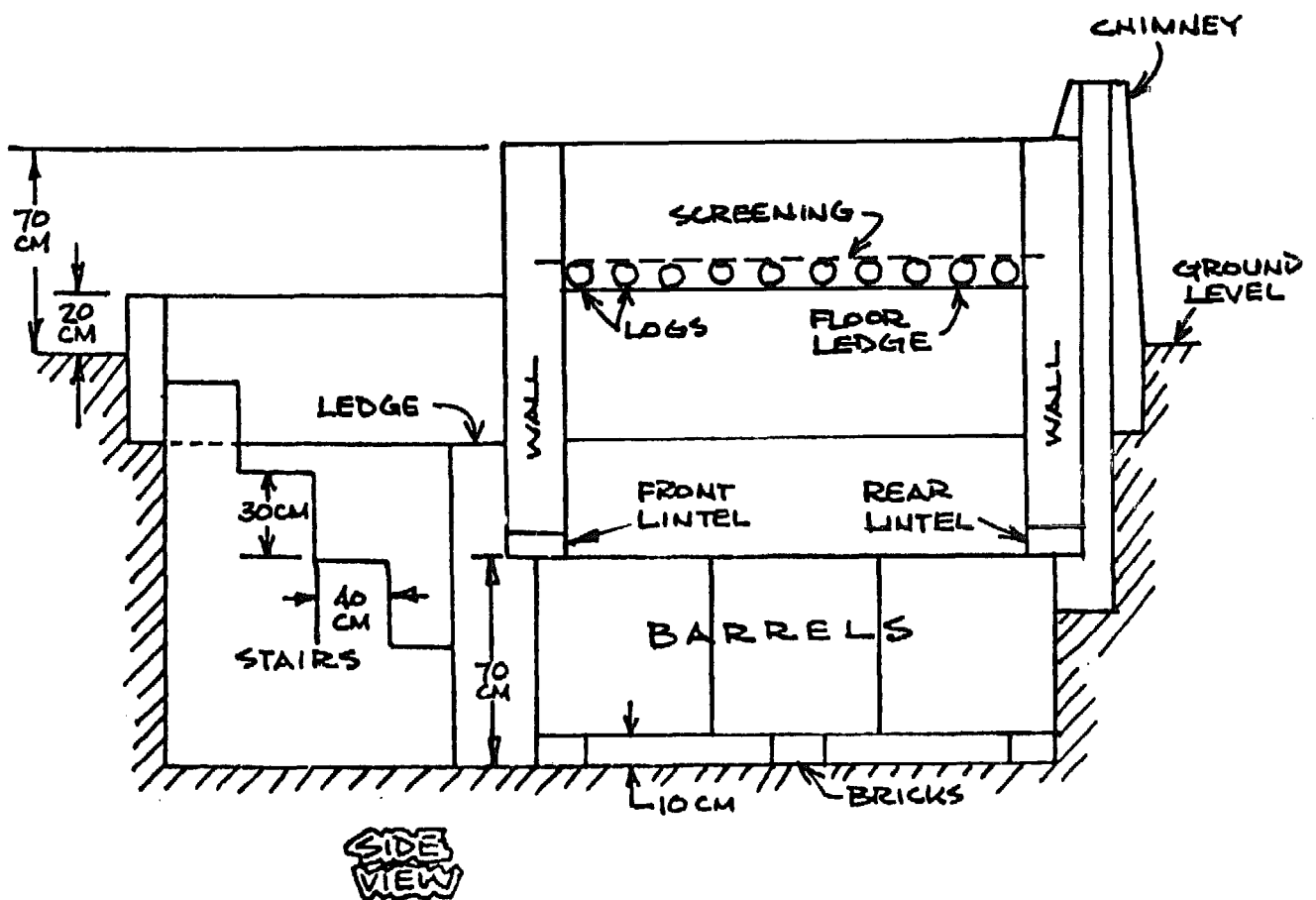
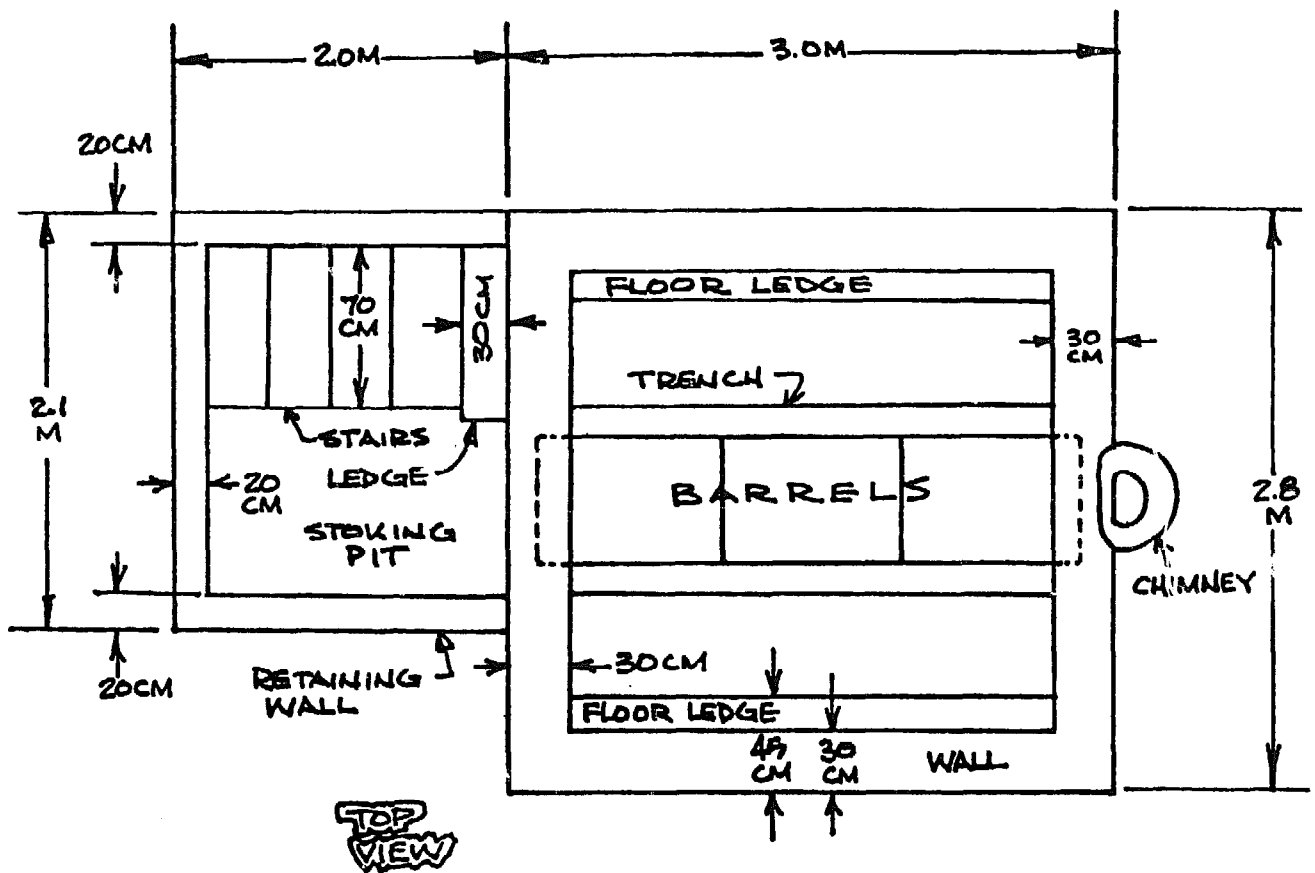

## PHILIPPINES RICE DRYER

Farmers in the Philippines grow a lot of rice. Scientists working in the Philippines and other countries have discovered new kinds of rice seed which grow more quickly. This means the crop is ready for harvest sooner; often a farmer can plant and harvest two crops in the time it used to take for one crop.

However, because the growing time is shorter, the rice is ready for harvest during the rainy season. Before, the rice would not be ready until the rains were finished. The farmer must harvest, but he cannot dry his grain outside in the sun. The problem he faces is simple, and it is a problem for farmers all over the world who must harvest during wet or humid times: how to get the grain dry before it is ruined by insects and molds.

Scientists working at the University of the Philippines and the International Rice Research Institute in Manila, Philippines, have come up with answers. They have designed two versions of a dryer model they feel is relatively inexpensive, simple to make, easy to operate and maintain. We call it here the Philippines Rice Dryer. Each version of this dryer will be discussed separately.

There are advantages and disadvantages to the use of this dryer by small farmers. Advantages are:

- . It can be used in the rainy season.
- . It uses less fuel than the oil barrel dryer because the fan forces air through the grain and decreases drying time.

Disadvantages:

- . It requires construction using relatively sophisticated materials, tools, and skilled labor.
- . It burns fuel which can be costly.
- . It requires finding and paying for special machinery.
- . It is practical only for wealthier farmers or a group of farmers.

*Philippines Rice Dryer*

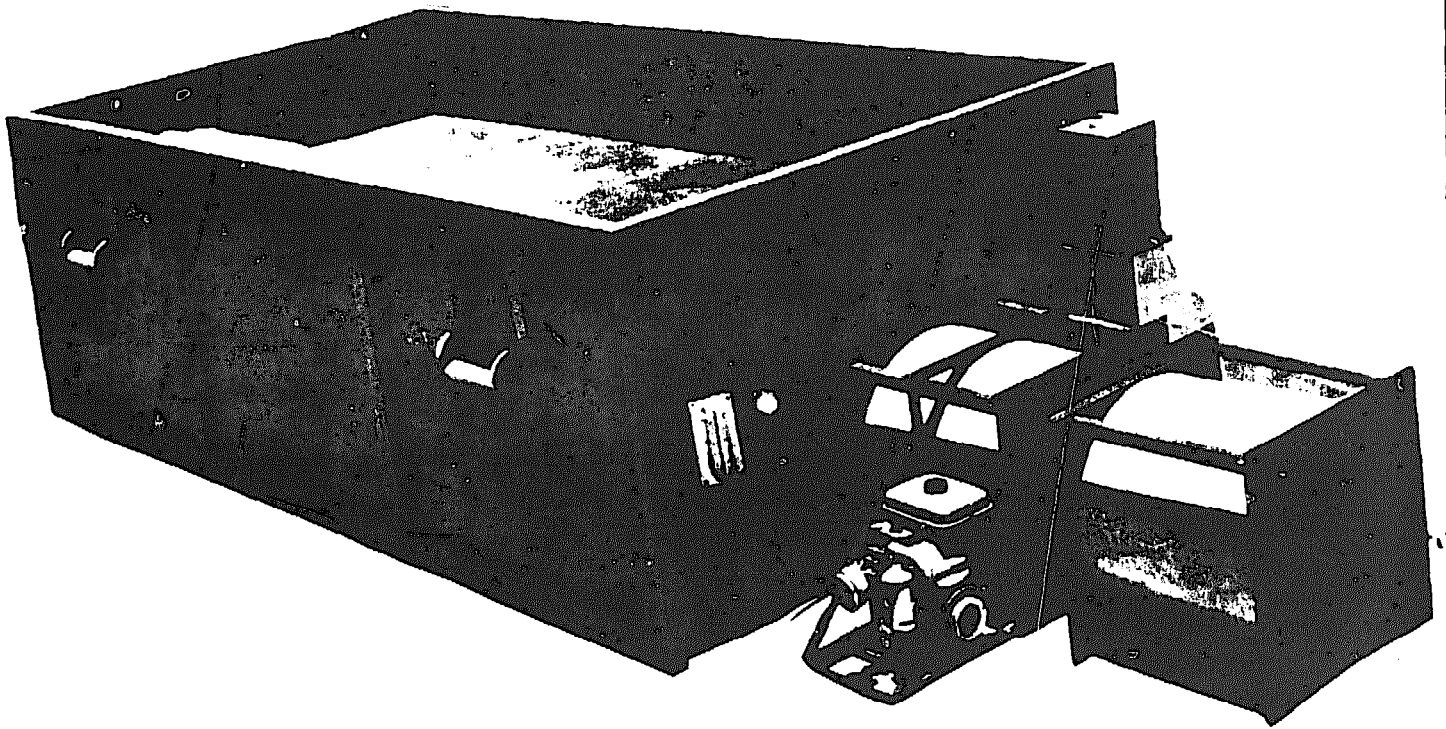

LOS BANOS RICE DRYER

The first rice dryer is from the Grain Processing Program of the Department of Agricultural Engineering at Los Banos, Philippines. It has three main parts: a bin which holds the grain (placed on sheet metal with holes) over a container of hot air (plenum); a fan to force air from the plenum through the grain; and a burner to heat the drying air.

A brief description of the major parts of the Philippines Rice Dryer:

Grain holding bin

- . Floor area is 1.8m x 3.6m.
- . 2cm plywood.
- . 5cm x 5cm lumber.
- . Perforated sheet metal (sheet metal with holes).

*Philippines Rice Dryer*

Blower

- . 18cm fan adapted from truck radiator fan.
- . Pushes 8.5 cubic meters per minute of air against a total pressure of 2.5cm water column.
- . Size of the blower is chosen to fit the size of the grain bin.
- . No stirring is necessary.
- . Mount fan with flange bearings, sheet metal housing. Reinforce with angle bars.

Engine

- . 5 hp gasoline or diesel engine.
- . V-belt and pulley.
- . A power tiller which has an 8 hp engine can be used.

Burner

- . 43°C recommended temperature so as not to damage milling quality.
- . Developed direct flame kerosene burner. Consists of 3-part iron casing, needle valve between burner and housing, and a double shell sheet metal housing. Uses 1.5 litres of fuel each hour.

Other items

- . V-tube manometer to read air pressure at plenum and to set engine throttle.
- . Dial thermometer to show drying air temperature.

*Philippines Rice Dryer*

- A. Kerosene Burner
- B. Fan and Engine
- C. Grain Bin
- D. Plenum
- E. Perforated Metal Floor

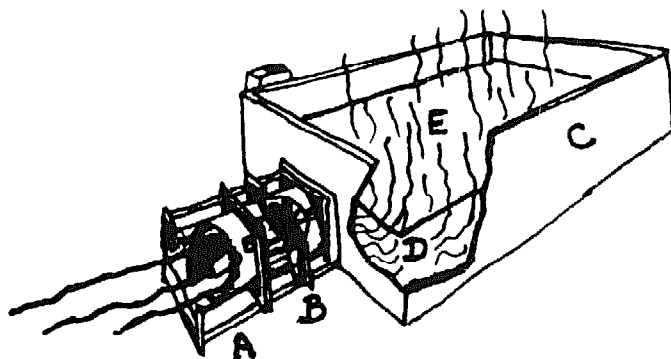

Notes on Operation of the Dryer

- . It takes 2 men an hour to assemble the dryer. This is the final putting together of the pieces. This is the time it takes if the grain bin is already made and all the parts are ready to assemble.
- . The dryer must be used under a shed to protect it and the grain from rain.
- . The bin holds about 1700kg.
- . The manometer is a guide to engine speed: a 2.5cm displacement of the water column shows the engine setting is correct.
- . The temperature of the air for drying is adjusted by controlling the flame through the needle valve and by adjusting the distance between the burner housing and the fan intake.
- . Drying continues until the top layer of grain is at 14% moisture. (It will take about 8 hours of steady drying to bring moisture down from 26% to 14 or 13%.)

For detailed technical bulletins describing construction and use of the Philippines Rice Dryer contact:

The Project Director  
Training of Technicians for Grain Industries  
Department of Agricultural Engineering  
University of the Philippines at Los Banos  
Laguna, Philippines

*Philippines Rice Dryer*

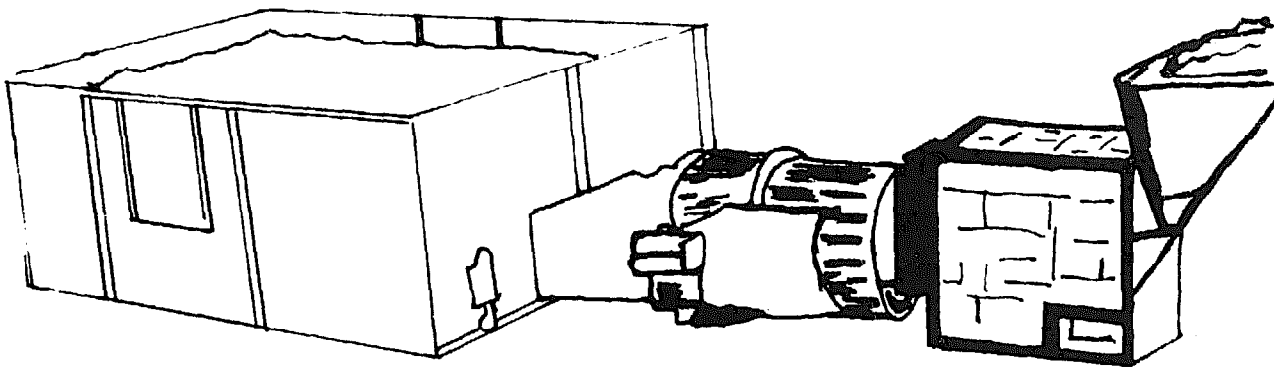

IRRI BATCH DRYER

The IRRI Batch Dryer is different from the early University of the Philippines model in 2 important ways:

1. It can use a self-feeding rice hull burner instead of gas or kerosene. This burner uses 3-4kgs of rice hulls per hour or 25kg per ton of rice dried. One ton of rice contains 200kg of rice hulls, so there are plenty of hulls to feed the burner. In other words, one ton of paddy produces enough hulls to dry that same ton of rice kernels.
2. The fan used is a 47cm diameter vane-axial type rather than varying sizes and models of truck radiator fans. The use of a standard fan allows the operator to fix standard drying times.



*Philippines Rice Dryer*

Other notes on the IRRI Batch Dryer

- . Drying capacity is 1 metric ton. It can dry this amount of paddy rice in 4-6 hours depending upon the initial moisture content of the grain.
- . The oil burner uses a 3 hp gasoline engine (a 2 hp electric motor can be added to drive the blower). A kerosene burner is installed in the air duct.
- . The rice hull furnace has a steel frame and is lined with fire bricks. It consists of a combustion chamber and an ash trap.
- . Either heating arrangement can raise the drying air temperature from 29 to 43°C at an air flow rate of 30-35 cubic meters of air/min/m<sup>3</sup> of grain.
- . Fuel consumption for the oil burner is 0.75 litres per hour for the gasoline engine and 2.0 litres per hour for the kerosene burner.
- . The rice hull furnace burns 3 to 4kg per hour of rice hulls.

This dryer, like the Los Banos Dryer, may be hard to put together: in some areas the materials may be expensive; in other places the equipment is hard to find. These facts make it hard for many small farmers to use such a dryer. A group of farmers, however, would be more likely to be able to use such a dryer cooperatively and profitably. And the dryer can be manufactured locally.

For more information and detailed engineering drawings, contact:

Agricultural Engineering Department  
The International Rice Research Institute  
P. O. Box 933  
Manila, Philippines

## SOLAR DRYERS

### PART ONE: CONSTRUCTION

#### INTRODUCTION

The following plans are based upon a construction manual written by James McDowell as a result of his experiences at the Caribbean Food and Nutrition Institute in Trinidad. VITA technical artist George C. Clark has provided added illustrations, as well as a simplification of the building procedure of the Model #1 dryer.

McDowell's plans in turn were developed from the ideas and principles of Dr. J. Lawand and associates of the Brace Research Institute, McGill University, Quebec, Canada. Now with UNICEF in Kenya, McDowell has used the dryer to dry grain from 25% to under 12% moisture in one day or less.

#### Solar Dryers have several possible advantages

- . There are no fuel costs.
- . Sun drying time is reduced because the heat of the sun is made stronger by covering the drying grain with a double layer of clear plastic film.
- . They can be used to dry other crops -- copra, cassava, fruits, vegetables.

#### There can be disadvantages also

- . Temperatures in the dryer may build up to 65-80°C. This means that grains such as rice, which crack at temperatures above 50°C, or seed grains (which can be dried at temperatures no higher than 40-45°C) can be damaged. A farmer has to watch the grain carefully, and, if no thermometer is available, will have to learn by trial and error.
- . Dryers are most useful only at certain hours of the day and would be of limited use during long periods of rainfall or very cloudy weather.

#### NOTES ON THE SOLAR DRYER MODELS

The dryer models here were designed and tested for drying cereal grains, root crops, fruits, and vegetables. The dryer holds 8 to 11kg for each square meter of drying floor. Dryers of the size presented here will dry 18-24kg each day. If a farmer wants to dry more grain, he will have to make a larger dryer or build several dryers.

Instructions and sketches for three versions of a Solar dryer are given in the following pages. These dryers can be made from whatever materials are most available locally. The dimensions given here are for general guidance. You can change the length, width or depth of these dryers without affecting their efficiency.

The sketches for Models 1 and 2 are based on a useful, practical working size of 2m in length, 1m in width, and 23-30cm overall depth. But changes in area can be made to suit local conditions, and dimensions of materials available. IMPORTANT: The only dimension which should be followed as closely as possible is the thickness of insulation on the Model 1 box-type dryer. Where wood shavings, wood wool, dried grass, leaves, or similar material are being used, a minimum thickness of 5cm should be used. Also, the internal depth of Models 1 and 2 should not be less than 15cm.

MODEL # 1 SOLAR DRYER

Description

This model consists of an outer box and an inner box. The inner box is at least 10cm less in length and width, and at least 5cm less in depth than the outer box. The space between the boxes is packed with suitable insulating material.

Lower air holes are drilled through the bottom of the boxes (and through spacer boards fitted in the insulation space for this purpose). Slots are cut in the upper edges of the sides of the box to provide upper air outlets. The dryer is supported about 15cm above the ground on four legs (which also form the main corner members for the box)

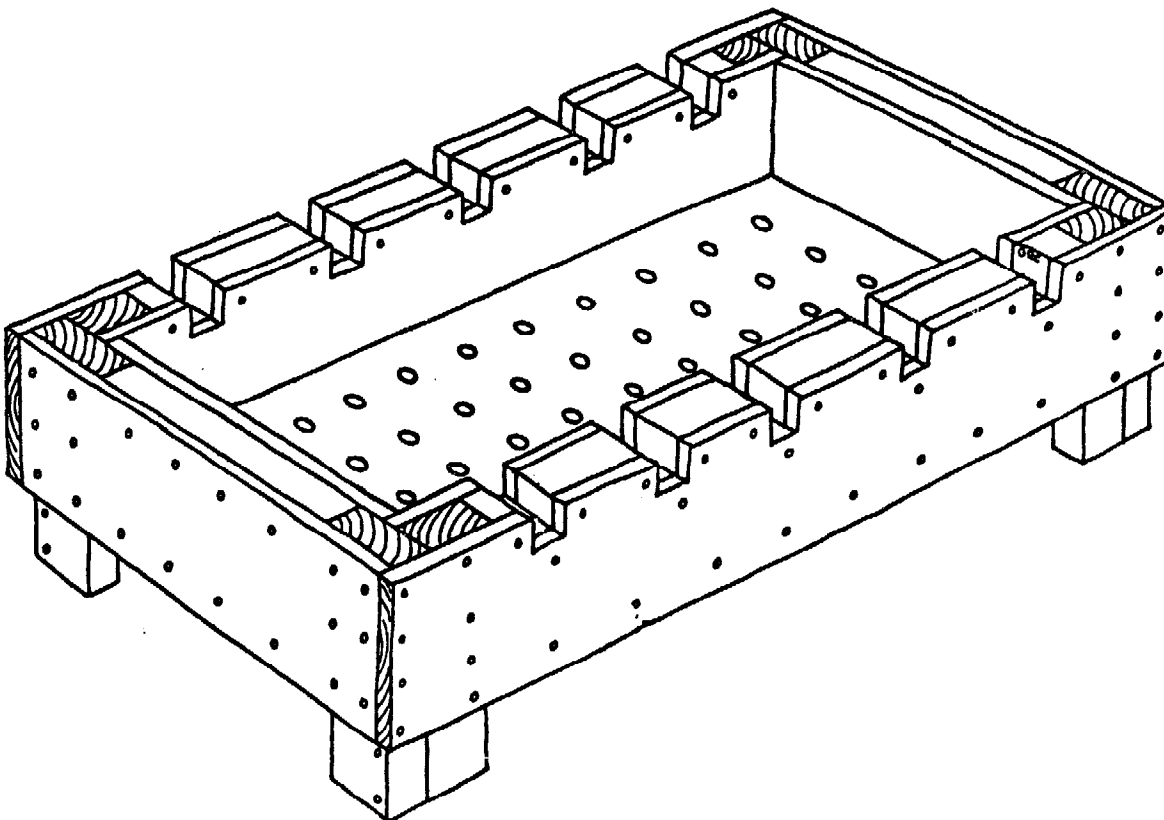

*Solar Dryers*

READ THE INSTRUCTIONS THROUGH BEFORE YOU BEGIN

Tools and Materials

- . Hammer, screwdriver, tri-square, saw, brace, and 2.5cm wood drill, 2cm wood chisel.
- . Wooden planking or plywood for sides, ends, and bottom of boxes. Use wood from old packing cases if it is available.
- . Lengths of timber:
  - 4 pieces 5 x 10cm for legs
  - 4 pieces 5 x 5 cm for legs
  - 13 pieces 5 x 5 cm for the side, end, and bottom spacer strips.
- . Insulating material: wood wool, dried grass or leaves, coir fibre, etc.
- . Nails and screwnails of appropriate size.
- . Matt-black paint or other suitable black staining material, e.g., charcoal.

Build the Inner Box

- . Check all measurements and markings on the wood before cutting.
- . Cut side and end pieces. These can be one piece of wood, or you can join narrower planks together to make a box about the right size.
- . Put the pieces together. Make sure the nails are completely hammered into the wood.

Solar Dryers

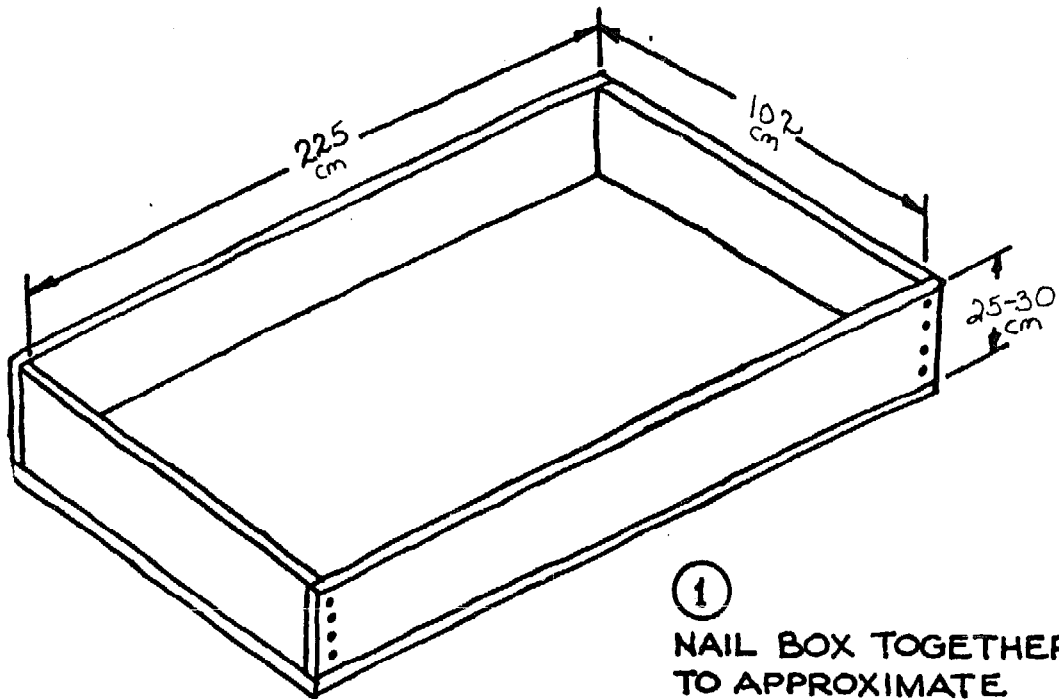

①  
NAIL BOX TOGETHER  
TO APPROXIMATE  
DIMENSIONS SHOWN

. Cut and nail the leg pieces to the corners as shown.

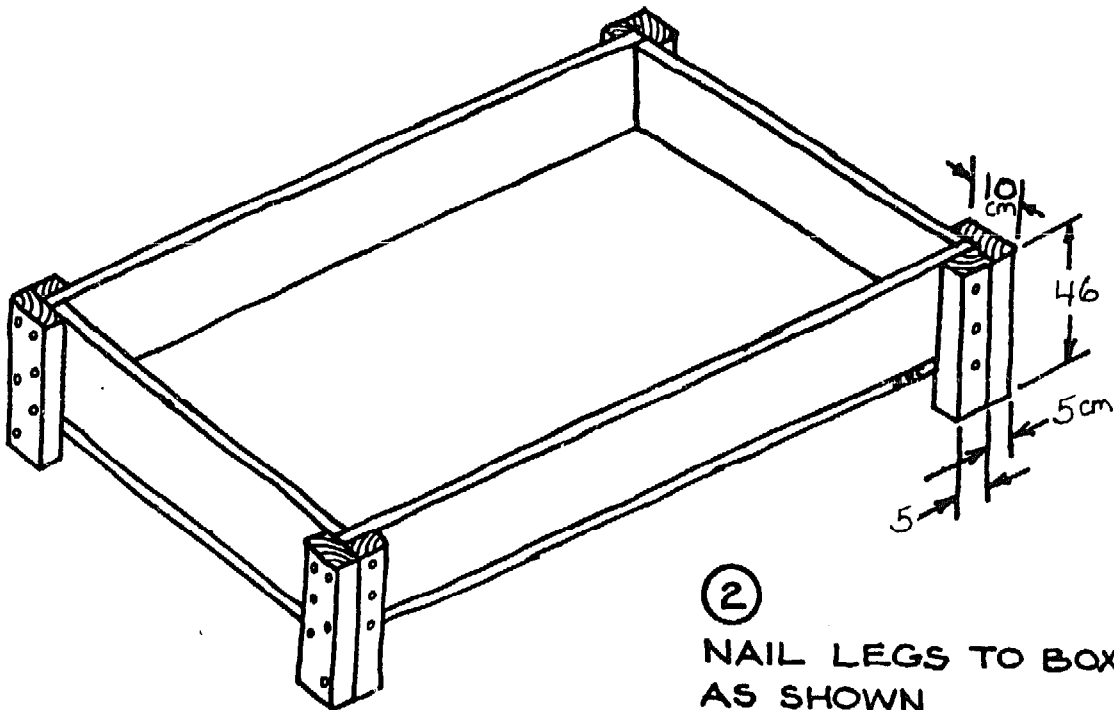

②  
NAIL LEGS TO BOX  
AS SHOWN

Solar Dryers

BLOCKS NAILED BETWEEN SPACER STRIPS

SPACER STRIPS

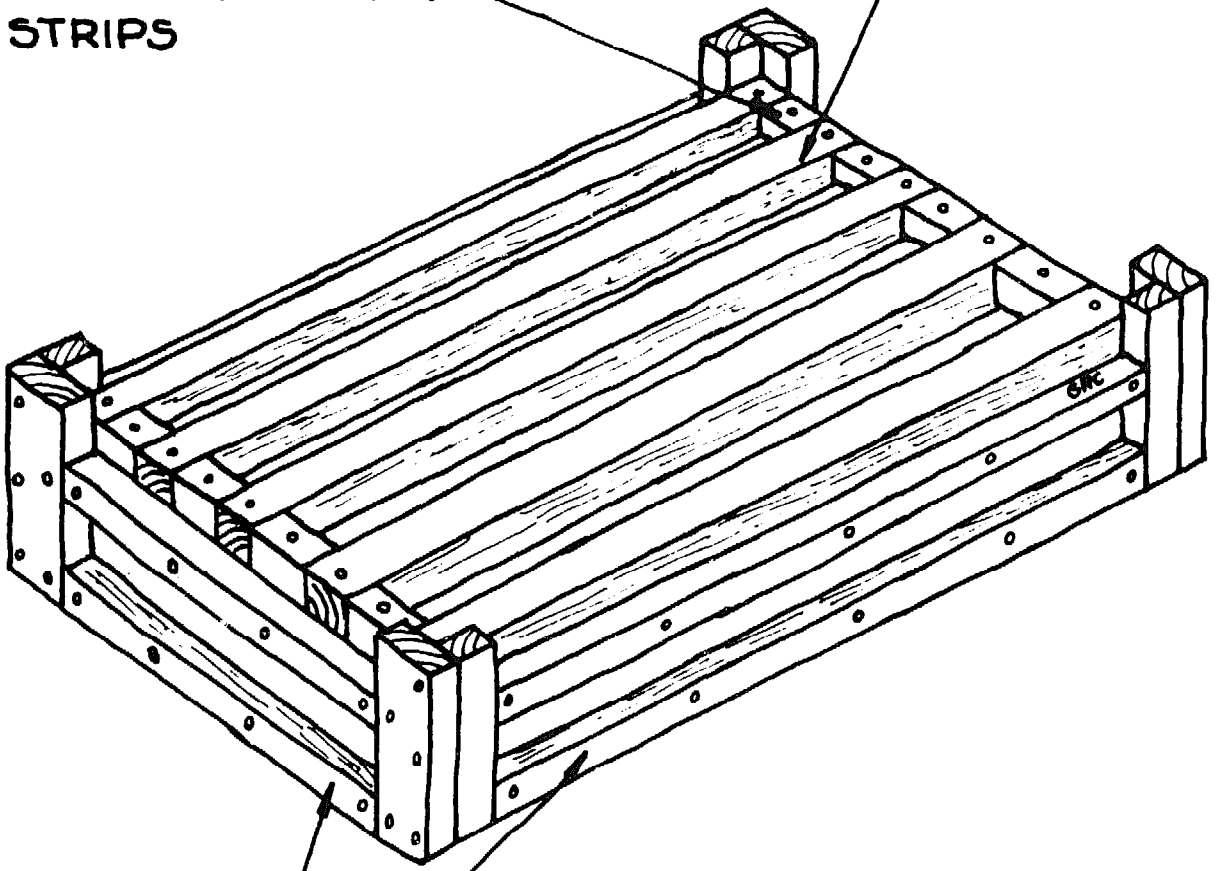

SPACER STRIPS

③

1. TURN BOX UPSIDE DOWN AND NAIL SPACER STRIPS ON BOTTOM OF BOX.

2. NAIL SPACER STRIPS ON SIDES AND ENDS AS SHOWN.

Solar Dryers

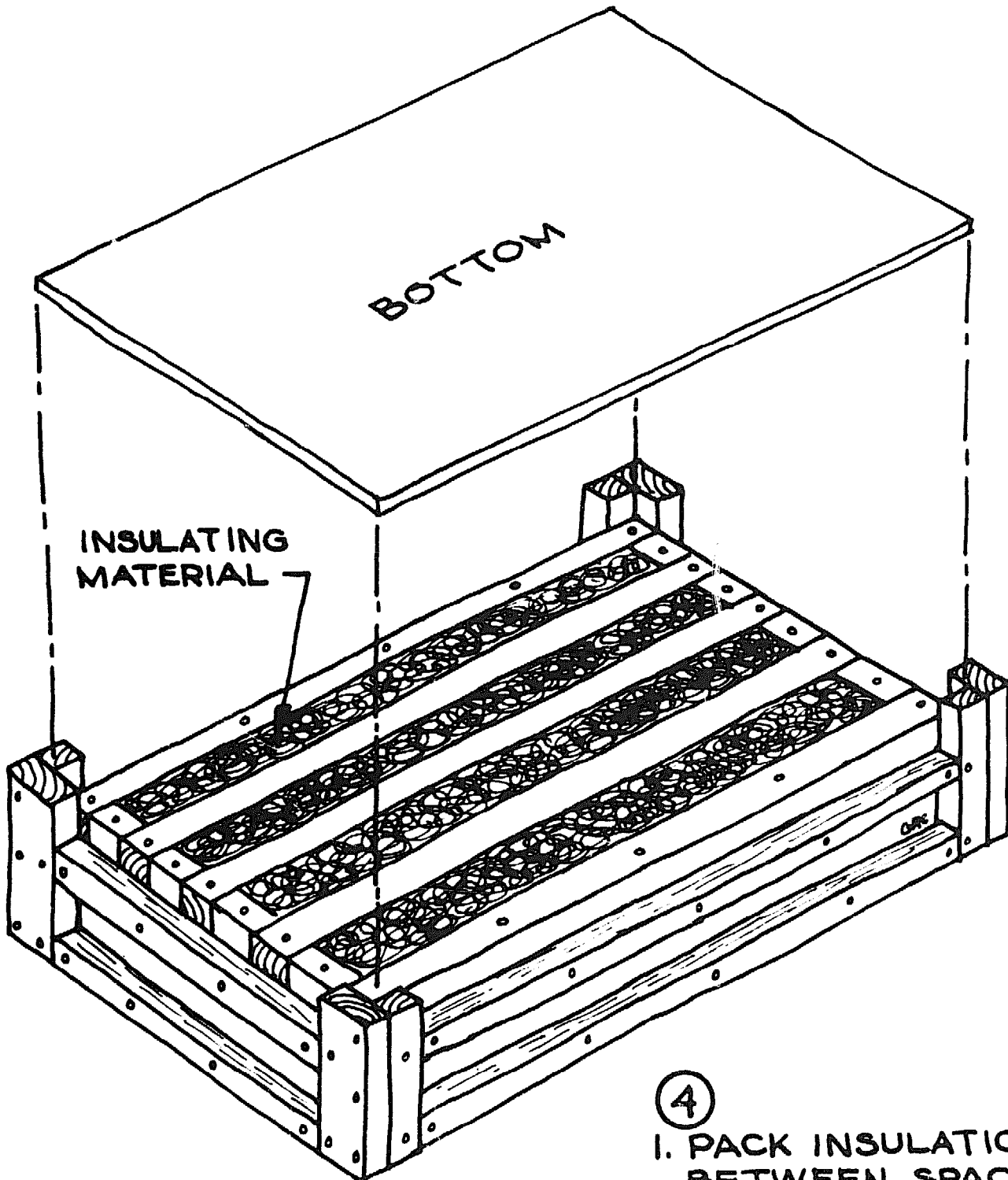

④

1. PACK INSULATION BETWEEN SPACER STRIPS.
2. PUT BOTTOM BOARD/BOARDS IN PLACE AND NAIL AROUND EDGES.



Solar Dryers

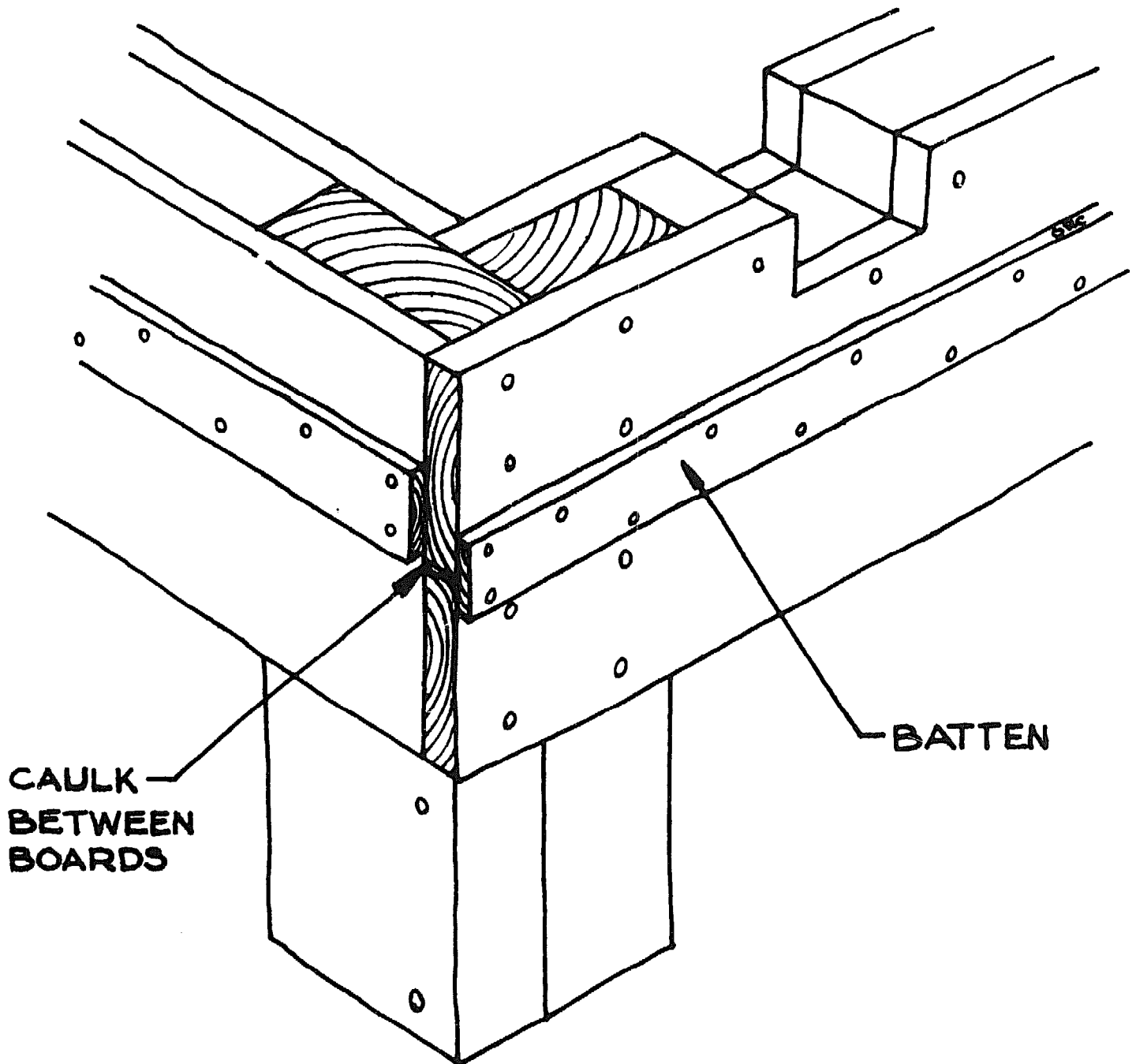

WHEN TWO OR MORE BOARDS MUST BE USED TO MAKE UP A SIDE OR BOTTOM, THE TWO JOINING EDGES SHOULD BE COATED WITH GUM, PITCH, PUTTY, ROOF CEMENT OR CAULKING COMPOUND BEFORE THEY ARE NAILED. SMEARING THE UNDER SIDE OF THE BATTEN WITH THE SAME TYPE OF MATERIAL BEFORE NAILING IT OVER THE CRACK BETWEEN THE BOARDS WILL HELP TO KEEP THE BOARDS WEATHER-TIGHT.

⑤

1. STAND BOX ON SIDE

2. PACK INSULATION ON SIDE AND NAIL BOARD ALONG BOTTOM AND ENDS. TOP EDGE TO BE NAILED AFTER IT IS NOTCHED.

3. REPEAT FOR OTHER SIDE OF BOX.

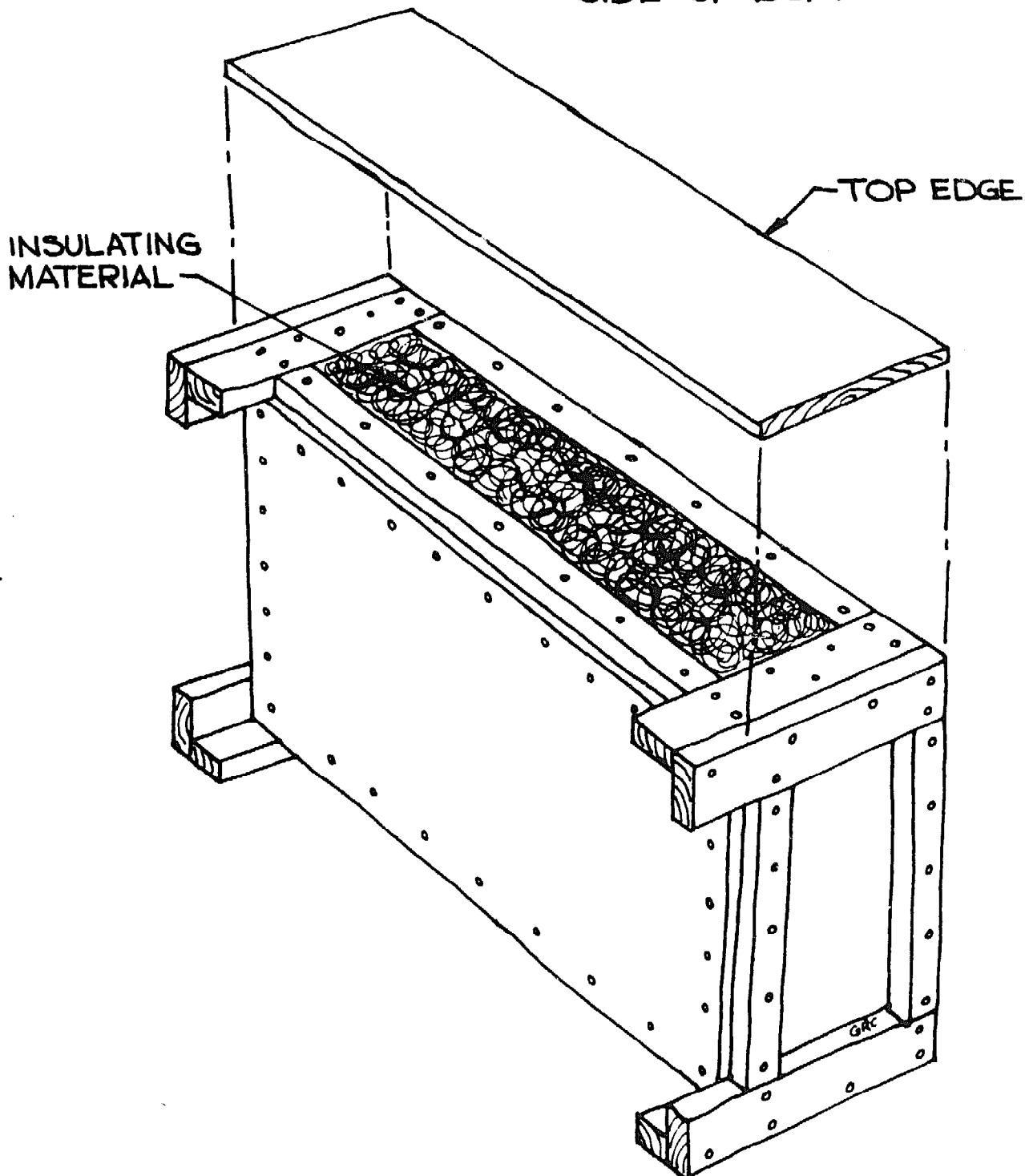

Solar Dryers

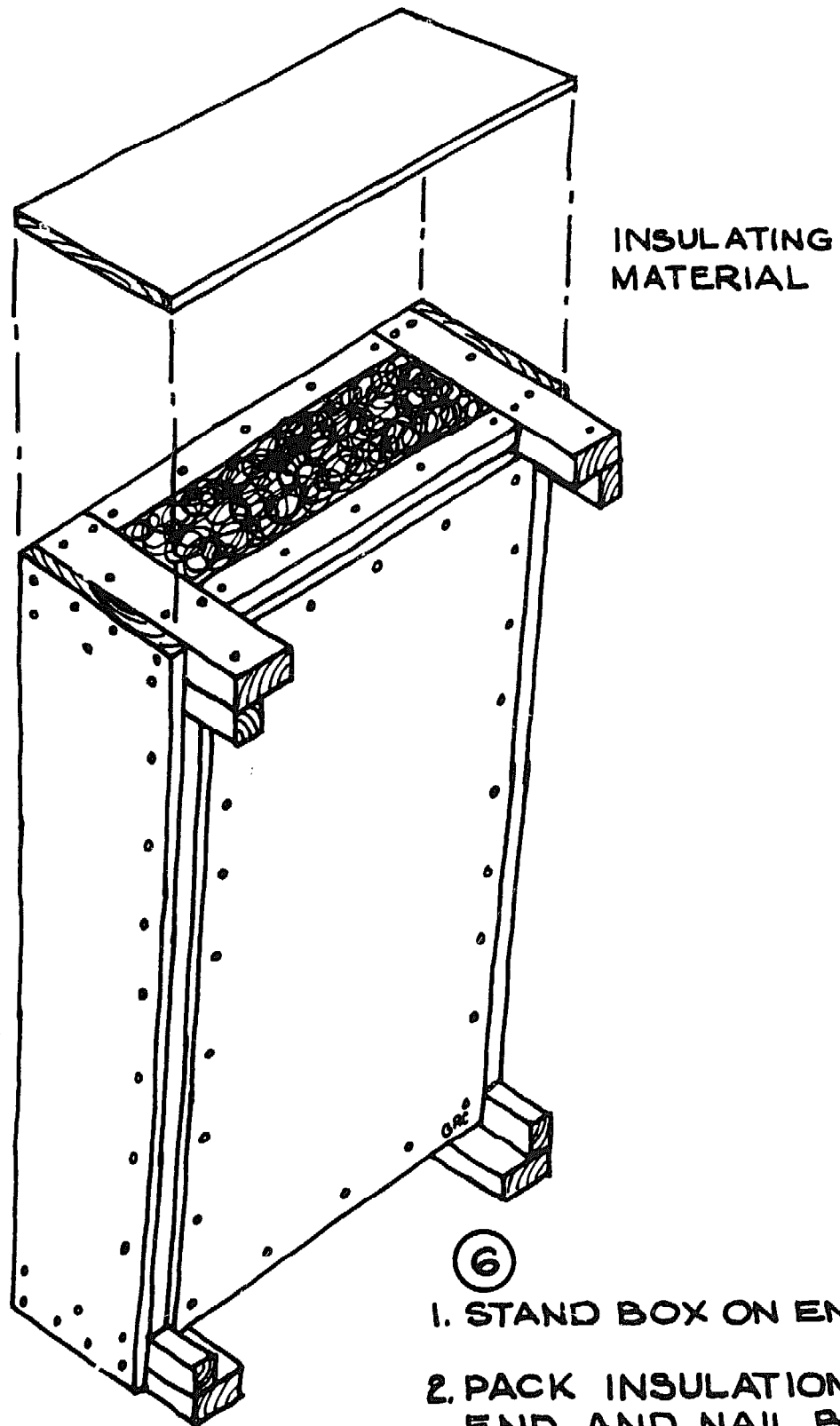

- ⑥
1. STAND BOX ON END.
  2. PACK INSULATION ON END AND NAIL BOARD IN PLACE.
  3. REPEAT FOR OTHER END.

Solar Dryers

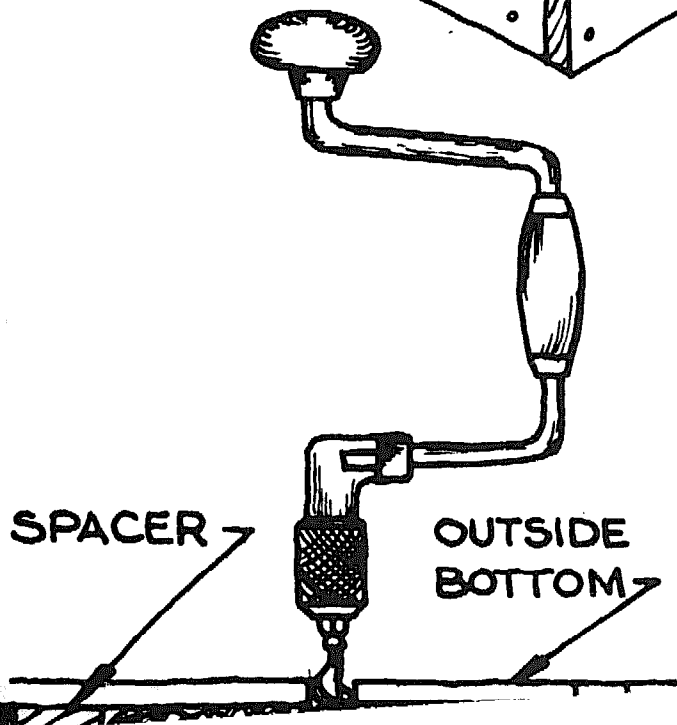
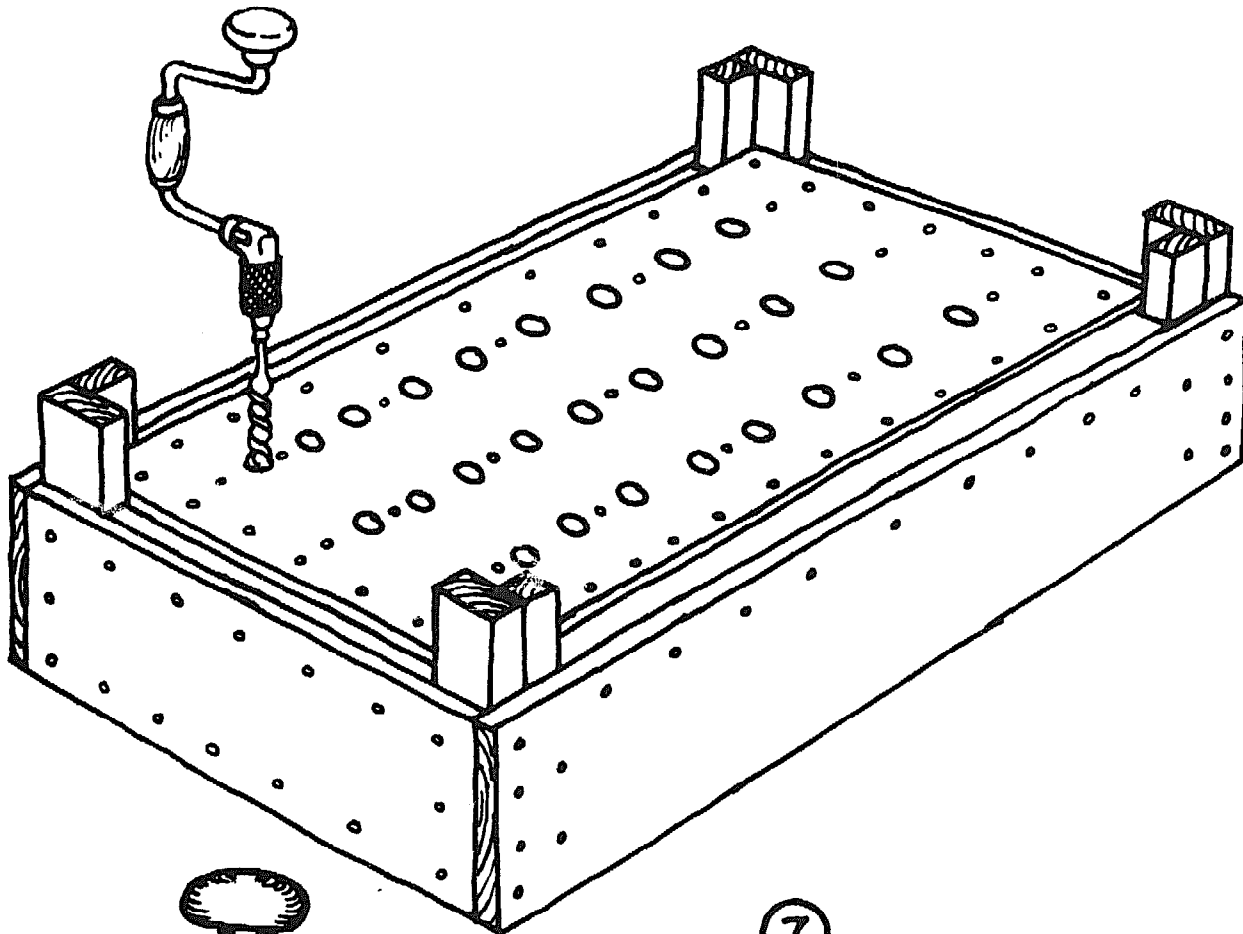

⑦

1. SET BOX UPSIDE DOWN AND DRILL HOLES THRU BOTTOM OF BOX. MAKE SURE HOLES ARE DRILLED THRU SPACER STRIPS (SEE DETAIL AT LEFT)
2. WHEN ALL HOLES ARE DRILLED, NAIL THRU BOTTOM INTO SPACER. NAIL AT LEAST BETWEEN EVERY OTHER HOLE

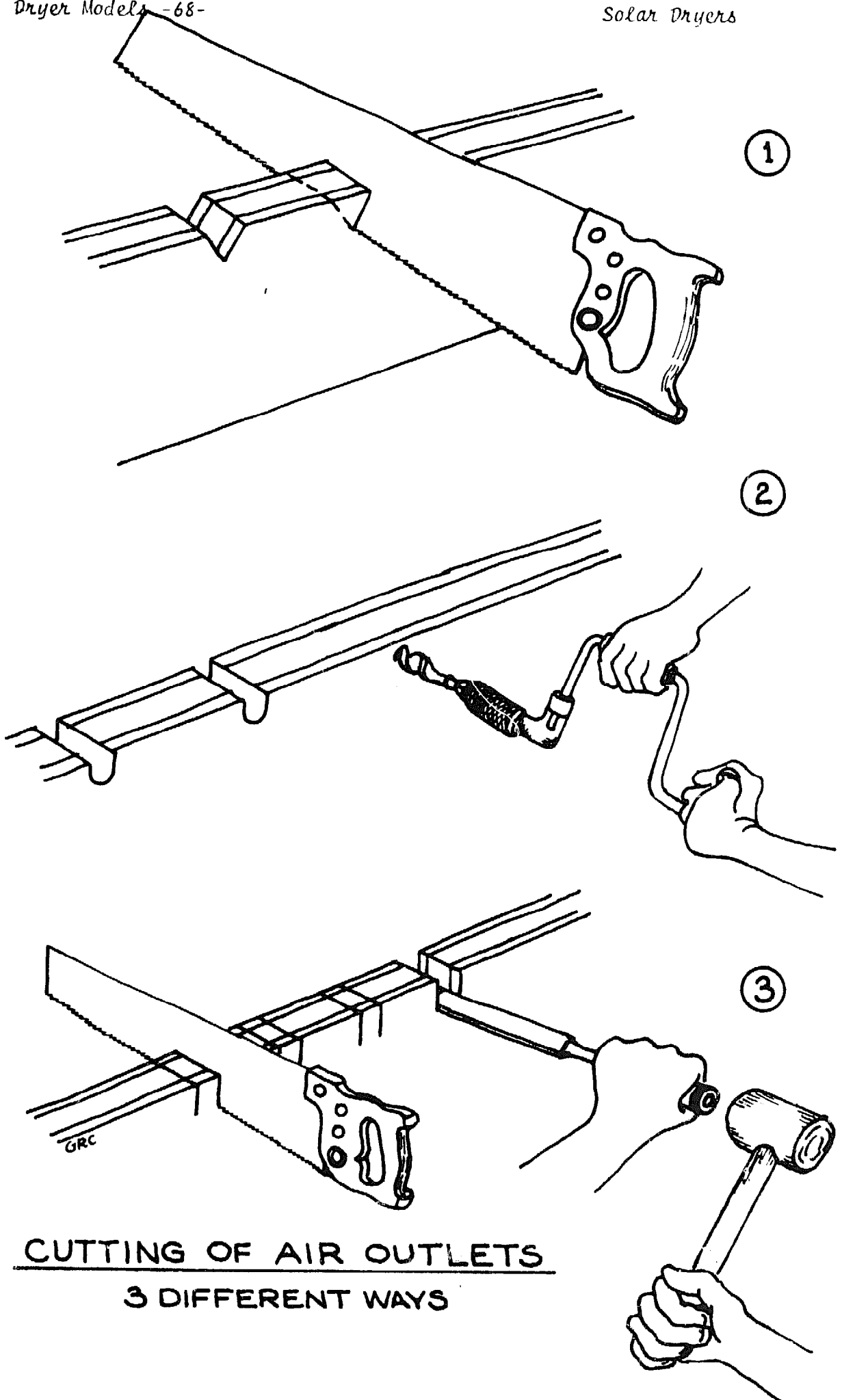

CUTTING OF AIR OUTLETS  
3 DIFFERENT WAYS

*Solar Dryers*

- . Make the air outlet slots.
  - Mark the position of the air outlet slots on the upper sides.
  - Cut out the slots in any of the three ways pictured.
  
- . Paint or stain the inside of the box with a dark color. A flat black is good. It is a good idea to put a wood preservative on the outside if you have it. Then paint the outside with gloss paint or marine varnish -- if you can find them.

### *Solar Dryers*

#### CONSTRUCT THE COVER (FOR MODEL 1 and 2 DRYERS)

The same cover is used for both dryers. It consists of a rectangular wooden frame with a central ridge piece. It is covered with a double layer of polyethylene film

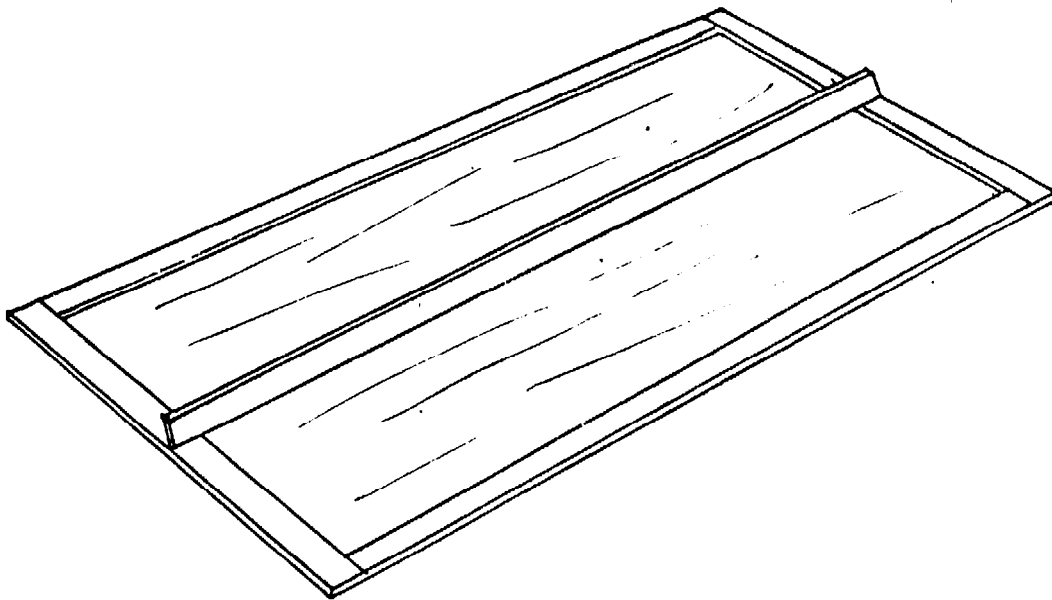

#### Tools and Materials

- . Saw (preferably tenon saw), screw-driver, sharp knife or scissors, tri square, marking gauge.
- . Lengths of timber: about 5cm x 2cm.
- . Transparent plastic (polyethylene) film (preferably .127mm or heavier).
- . Screwnails (1.6cm x 8s C.S.).
- . Blued tacks (1cm) or large office stapler.

## Solar Dryers

READ THE INSTRUCTIONS THROUGH BEFORE YOU BEGIN

Make the frame so that its length and width are each 8cm greater than the box to be covered. The cover will overlap the dryer box by about 4cm in each direction.

### 1. Make the Frame

- . Cut the pieces for the frame to the right lengths.
- . Put them together as shown.

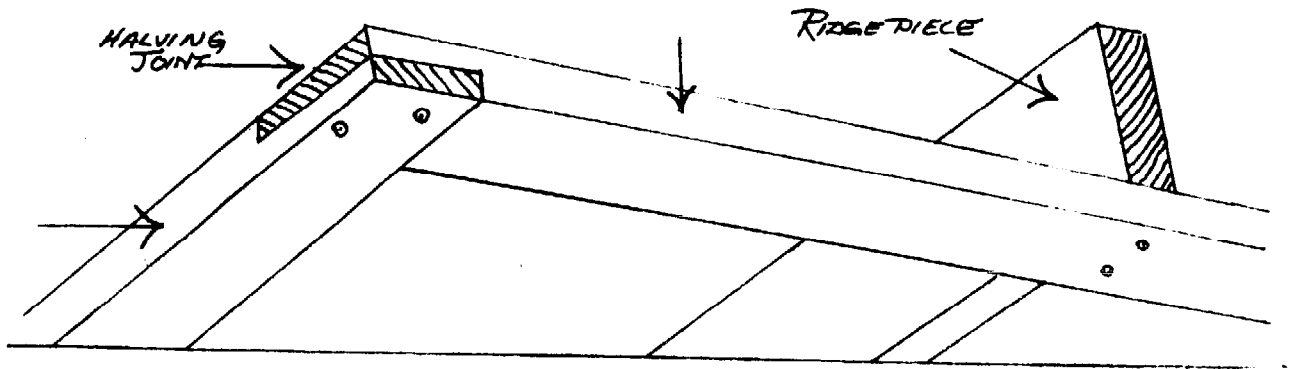

- . Dry the frame in the hot sun before putting on the plastic.

### 2. Put the Lower Plastic Sheet on the Frame

- . Put the cover on while the wood is still warm and at a time when humidity is low. These precautions are necessary to prevent condensation (fogging) between the layers of polyethylene.
- . Cut a piece of plastic sheet for covering the lower side of the frame so that it is 8cm wider and 8cm longer than the frame.
- . Turn the frame upside down and lay the plastic sheet in place. Fold one side of the polyethylene back on itself to form a triple layer seam 2cm wide.





*Solar Dryers*

- . Start at the middle of the frame and work toward both ends. Stretch the plastic lightly but firmly lengthwise. Tack or staple through the seam at 8cm intervals to fasten this edge of the polyethylene to the frame. DO NOT OVER-STRETCH THE PLASTIC. POLYETHYLENE WILL "GIVE" AND DISTORT IF FINGERTIPS ARE DUG INTO IT. SUCH DISTORTED AREAS ARE LIKELY TO BREAK THROUGH DURING USE. IT IS BETTER THAT POLYETHYLENE SHOULD BE SLIGHTLY LOOSE RATHER THAN OVER-STRETCHED.
- . Repeat this process at the other side of the frame. Stretch the polyethylene across the frame while tacking or stapling.
- . Fold similar seams at each end. Tack the ends of the sheet to the frame. Tuck the plastic neatly at each corner. Fasten firmly in place.

3. Put the Upper Plastic Sheet on the Frame

- . Cut a piece of polyethylene sheet for covering the upper side. This sheet, when placed over the frame, should be 10cm wider and 10cm longer than the frame. Turn the frame upside down and, making a triple fold seam as before, tack or staple one edge to one side of the frame so that the seam overlaps the triple seam of the lower sheet.

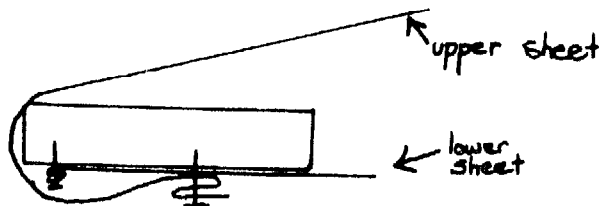

- . Stretch the polyethylene over the ridge and around to the lower edge of the other side member. Make a folded seam and tack or staple in place as before.
- . Stretch the polyethylene over one end of the frame, fold and tack as before, cutting away any extra material resulting from the slope from ridge to side member. Tuck the corners of the sheet in neatly, and tack firmly in place. Repeat for the other end of the frame.

*Solar Dryers*

4. Attach the Covers to the Dryers

- . The covers do not weigh much and are likely to blow off the dryers even in a light wind. The cover can be kept on by fastening hooks of stiff wire to each corner of the cover and swinging these hooks into place around nails or pegs fixed in the sides of the dryer.
- . Or, fasten lengths of strong twine or cord to one side of the dryer, draw them tightly across the cover, and tie them to nails or pegs on the other side.

### Solar Dryers

#### CONSTRUCT THE DRYING TRAYS

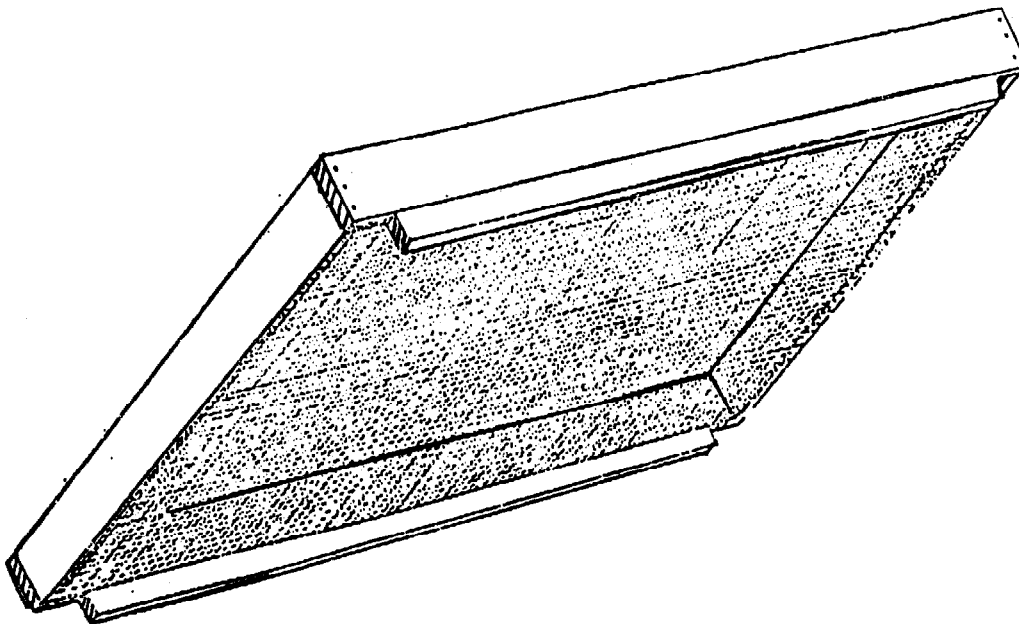

This is a simple wooden frame with fine wire mesh stapled to its underside. Two support runners are nailed to the underside (over the edge of the wire mesh). If necessary, two small pieces of wood may be tacked over the edges of the wire mesh to hold it in place at the ends. However, folding the edges of the mesh over upon itself before stapling may be all that is needed.

Make two trays, each slightly smaller than 1m x 1m so that it will fit the dryer box well. It is a good idea to make two trays because they are easier to handle than one large tray. Also, using two trays means that grains at two different moisture levels can be dried at the same time.

Simpler trays may be made from local materials. Papyrus reed matting, or a frame with slats of reed or split bamboo, for example, make an excellent support on which material can be dried. Coarse hessian sacking material, or open weave grass, or fibre matting stretched on a frame also can be used.

MODEL #2 SOLAR DRYER

Description

This dryer also is for a 2m x 1m dryer. But it is not portable like the Model #1 Solar Dryer. It is built on a permanent location and is made with clay bricks, or similar material. Bricks composed of local earth and cement and compressed by a CINVA-RAM work very well. If hollow bricks are used, the hollows should be packed with dried grass, coir fibre, or other insulating material.

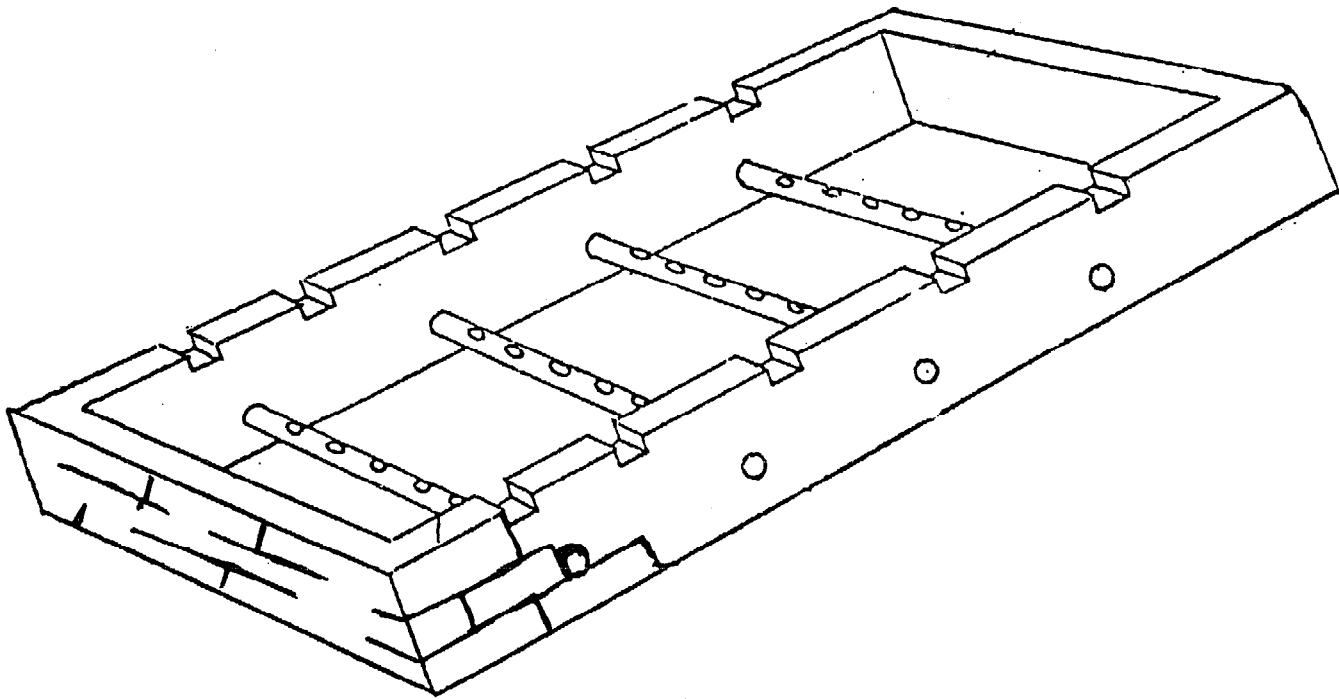

Choose a Site

A good place for the Solar Dryer will be

- . high ground which is flat and level. Make sure the location is well drained.
- . out in the open -- not shaded by trees or buildings.
- . exposed to the prevailing wind. The end of the dryer should be facing the prevailing wind.

*Solar Dryers*

Tools and Materials

- . Large knife, axe, or machete
- . Coping Saw or wood rasp
- . 2cm chisel
- . Clay bricks or bricks made from similar material
- . Mortar or clay for laying bricks
- . Thick bamboo (6 to 7.5cm diameter)

READ THE INSTRUCTIONS THROUGH BEFORE YOU BEGIN

1. Prepare Site

- . Lay out dryer size by building up the corner blocks.

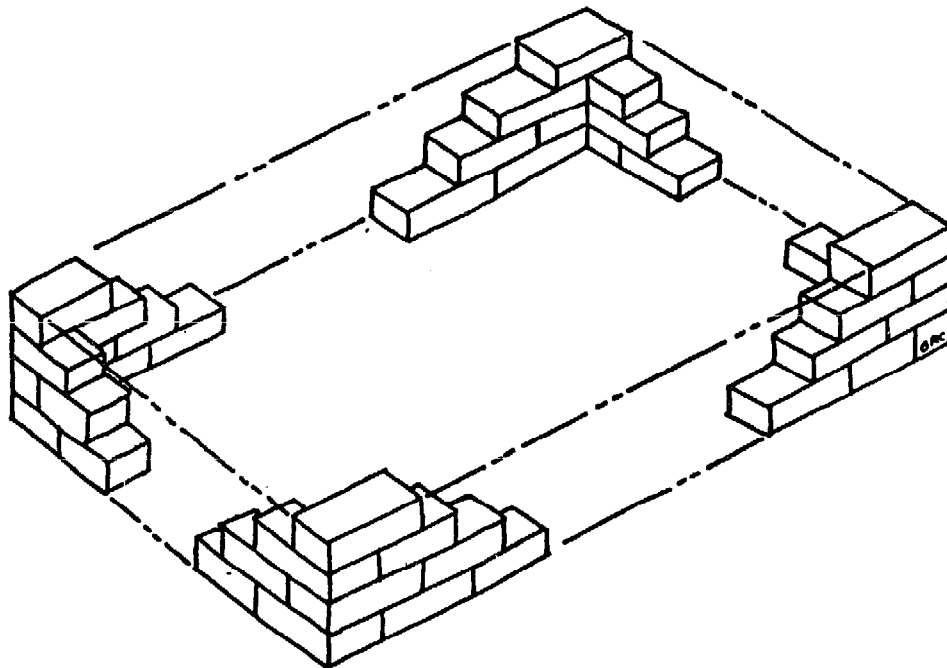

LAYOUT THE SIZE OF THE DRYER ON THE GROUND AND LAY UP THE CORNER BLOCKS AS SHOWN. FILL IN BETWEEN THE CORNERS TO COMPLETE THE WALLS.

### Solar Dryers

- . Prepare a floor of hard-packed earth or concrete mortar.
- . Dig a drainage trench around the dryer to protect it from heavy rain. The trench should be 23-30cm wide and 23-30cm deep.

#### 2. Prepare Bamboo Pipes

- . Choose bamboo of even thickness with as few joints as possible.
- . Cut bamboo to the same length as the width of the dryer.
- . Then prepare the pipes as follows:

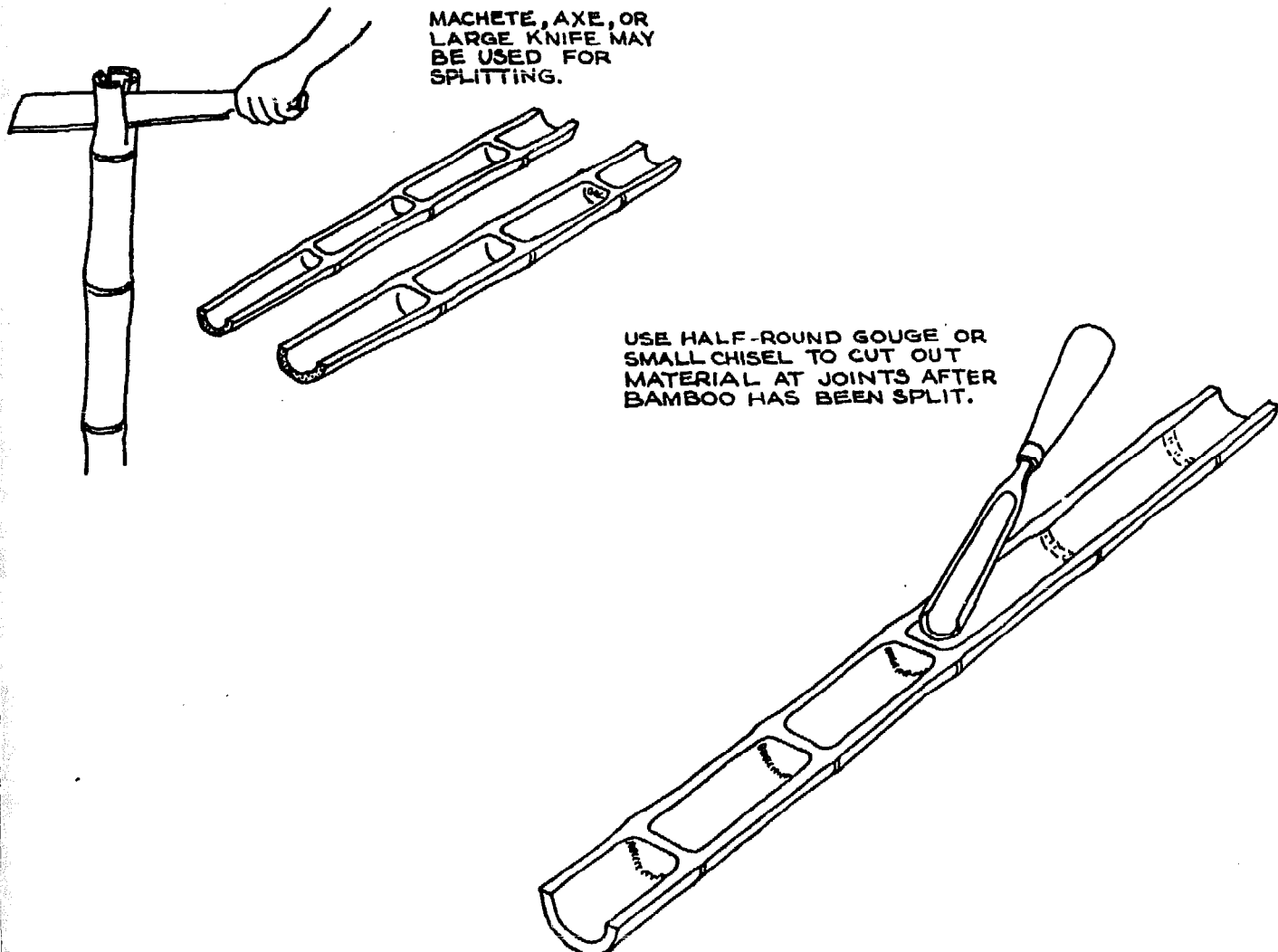

Solar Dryers

- Cut holes, about 4cm in diameter, in each pipe. Holes can be made by using one of these methods:

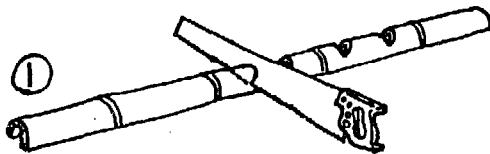

V SHAPED NOTCH  
MAY BE CUT WITH  
HANDSAW.

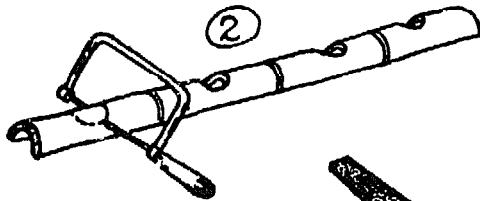

COPING SAW

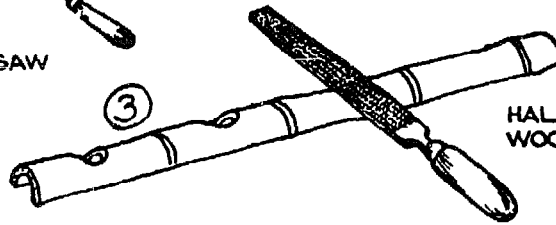

HALF-ROUND  
WOOD RASP

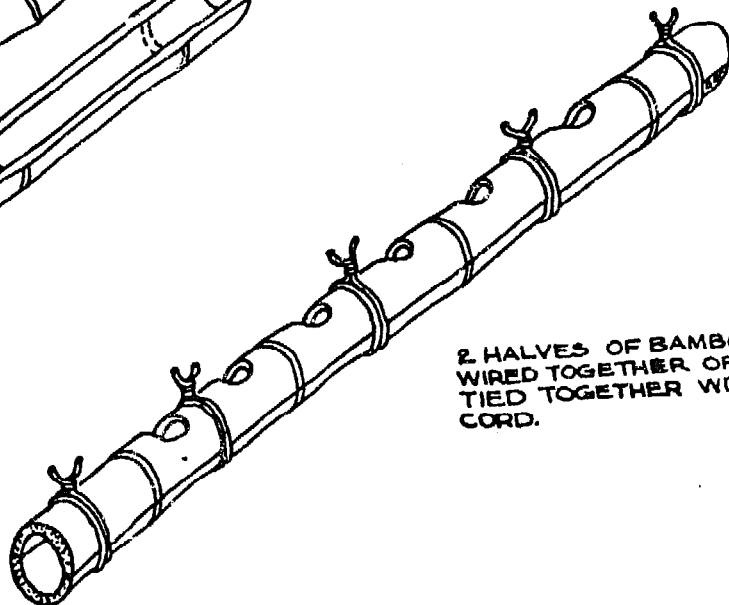
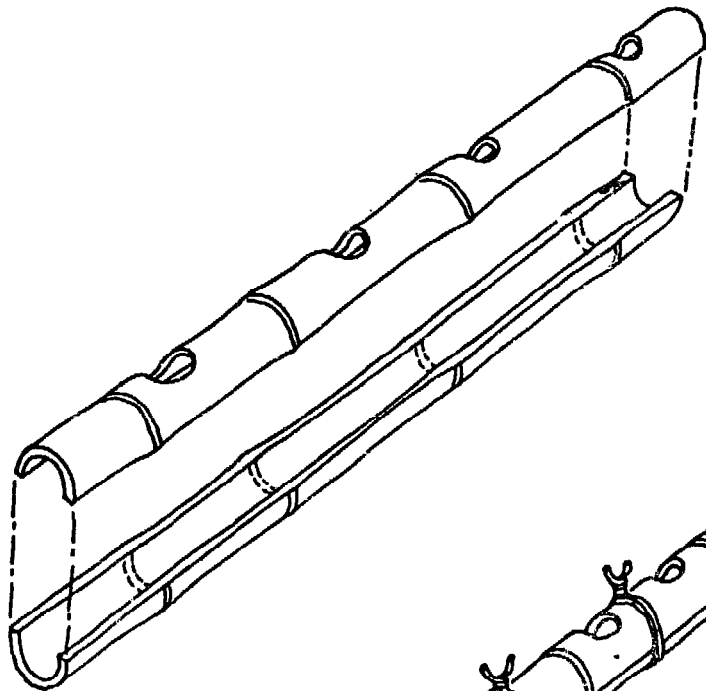

2 HALVES OF BAMBOO  
WIRED TOGETHER OR  
TIED TOGETHER WITH  
CORD.

Solar Dryers

3. Finish the Walls

- . Place the bamboo pipes in position in the second layer. Cut the blocks short as necessary to fit in the bamboo pipes.

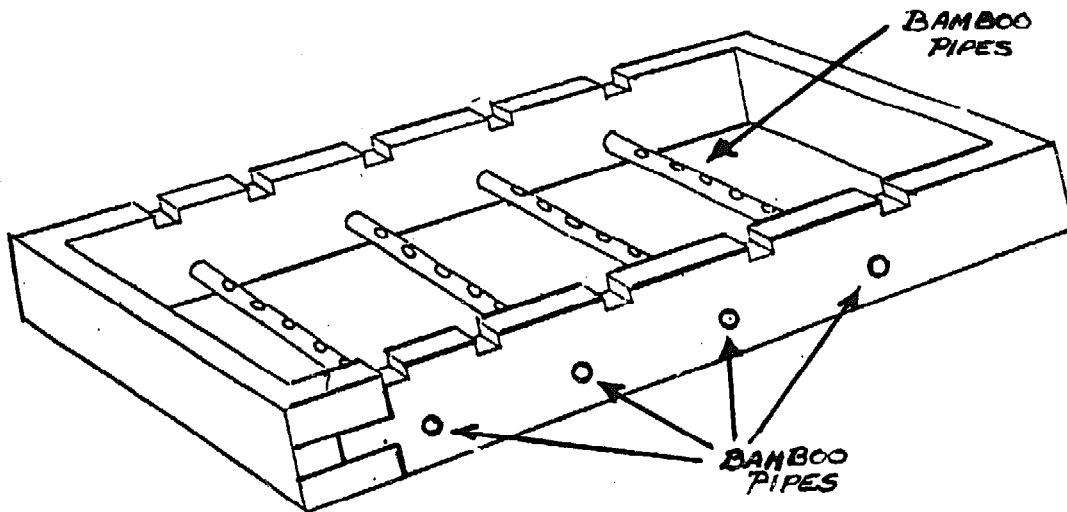

- . Put down the third layer of bricks.
- . Pack the holes around the bamboo with mortar or clay.
- . Put down the top layer of bricks and cut out the air outlet slots or lay the top layer of bricks leaving one inch gaps as air-outlet holes spaced along the two sides.

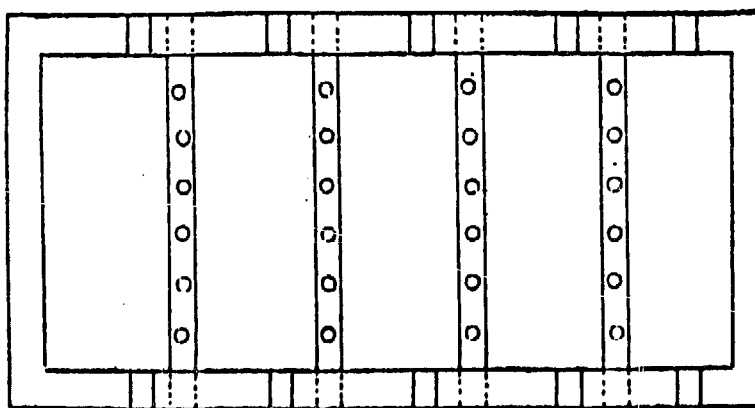

TOP VIEW



*Solar Dryers*

4. Paint the Inside

- . Paint the inside of the dryer a dark color. Charcoal, mixed with clay, may be a good way of doing this.

5. Construct Cover and Drying Trays as for Model #1

## MODIFICATION OF MODEL #2 SOLAR DRYER

### A Dual-Purpose Solar/Fuel-Heated Dryer

It is possible to build solar dryers which can work on solar heat for most of the time, but which can, if necessary, be artificially heated during periods of heavy clouding or rain.

A modification of the Model 2 dryer will allow for this dual-purpose operation. This modification consists of building-in a metal flue pipe which runs through the length of the dryer. This pipe carries the heat from a firebox built at one end of the dryer. When drying has to be done in cloudy conditions, the fire can be lit to provide heat for drying.

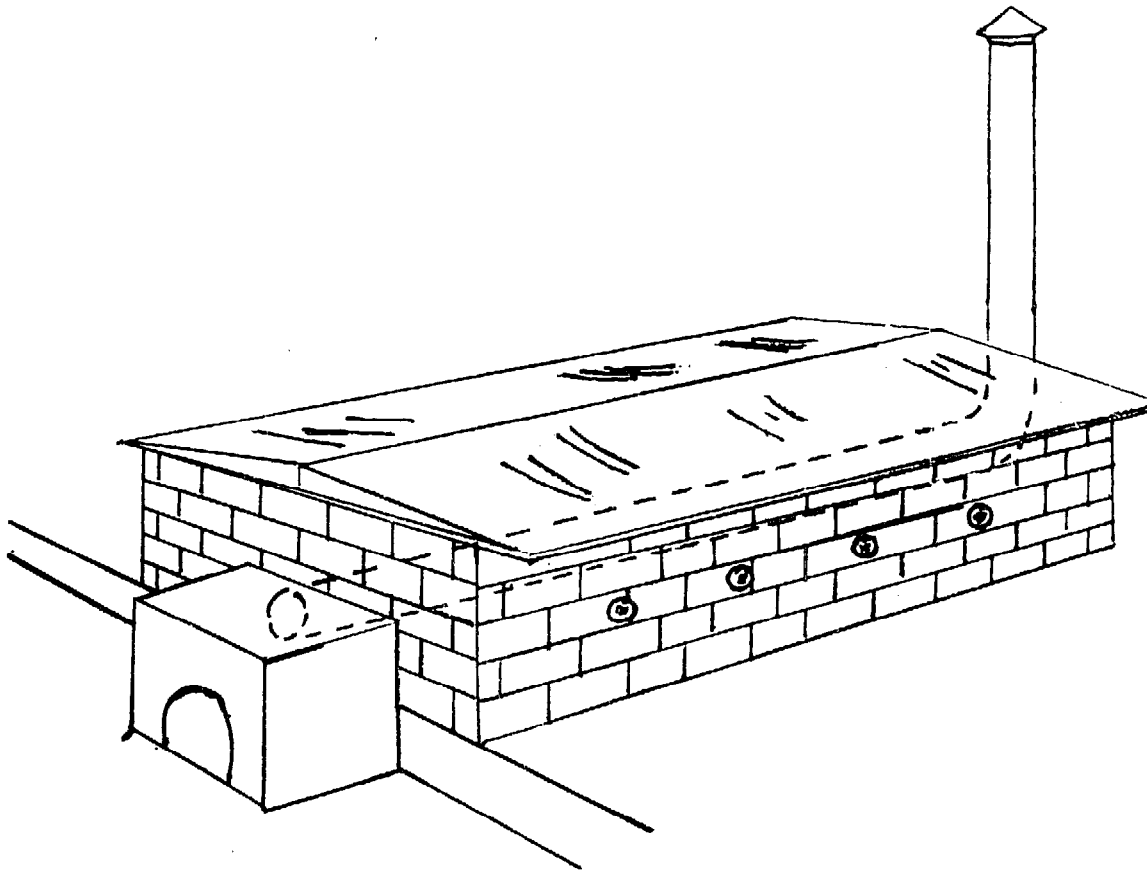

Either one large, say, 11cm diameter pipe, or a number of smaller pipes can be used. When using smaller pipes, difficulties in constructing a manifold may arise. But it may be possible to adapt an exhaust manifold from an old gasoline or diesel engine for this purpose.

THE ONLY BASIC MODIFICATION NEEDED IN CONSTRUCTING THIS DRYER IS THAT THE WALLS MUST BE BUILT HIGH ENOUGH TO ALLOW THE FLUE PIPE TO PASS UNDER THE AIR-INLET PIPES.

### Solar Dryers

An increase of 7.6cm (or one brick) in height, should be sufficient. The firebox may be built in clay or brick, or a section cut from an old oil drum may be used for the purpose.

The base of the firebox must be at a lower level than the dryer.

- Make sure that this area is protected from any flooding which may occur during heavy rains.

The flue tube running through the dryer should slope upwards towards the chimney to assist draught.

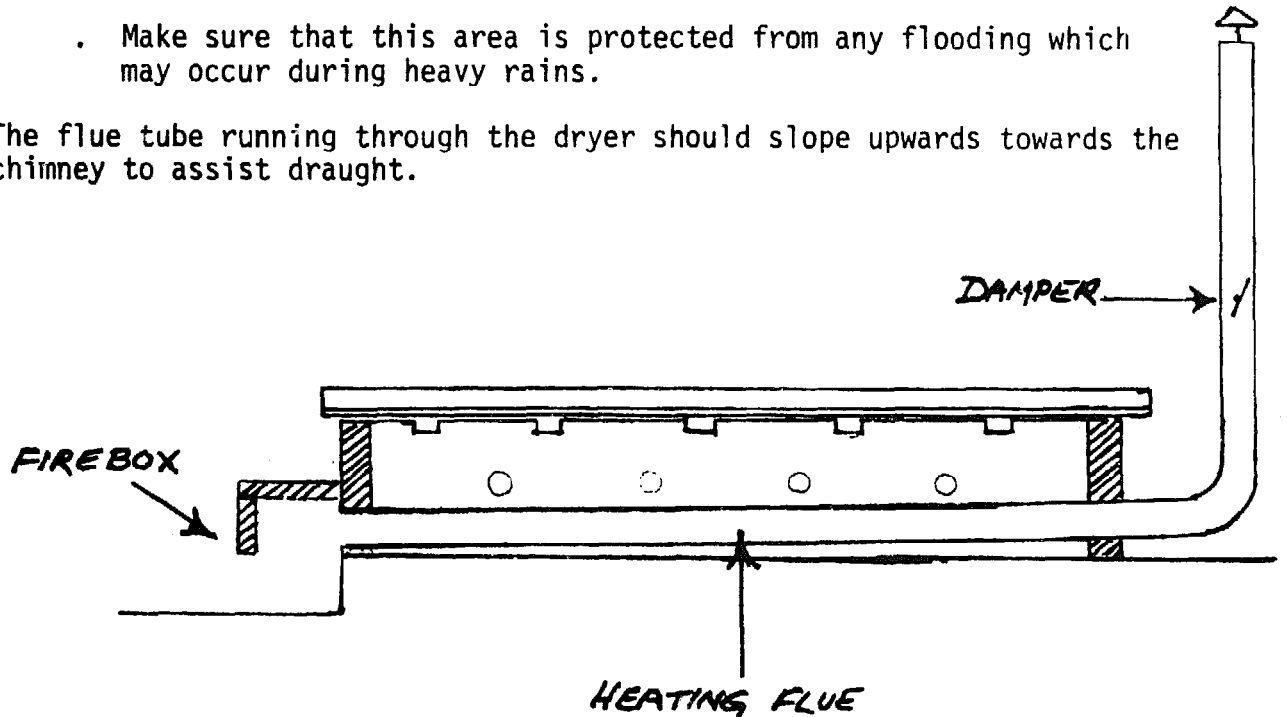

When using artificial heat, the movement of air through the dryer by convection will operate as it does when solar heat is being used. However, depending upon the heat given by the fuel being used, it may be necessary to close-off more of the upper ventilation ports.

#### CAUTION:

- Make sure that the part of the flue pipe passing through the dryer is smoke-proof. If it is not smoke-proof, smoke will flavor the foods being dried. A damper should also be placed in the chimney. This damper must be kept closed when sun-drying is being carried out, or the flue pipe may exert a cooling effect.
- Make sure to site this modification so that the firebox end faces into the prevailing wind. This will assist draught through the flue, and will also ensure that any sparks from the chimney are carried away from the polyethylene cover.

## MODEL #3 SOLAR DRYER

### Description

This is a simple dryer. It is not as efficient as the other two in conditions where it is exposed to cooling winds, but it will provide more efficient drying than direct exposure to the sun, and will also protect the drying material from rain. It is essentially a "sandwich" of two sheets of corrugated galvanized iron roofing material placed so that they form a series of tubes. The lower sheet is bedded in insulating material to reduce loss of heat. It is set in a sloping position with one end raised about 15cm higher than the other. This position allows hot air to rise and escape at the upper end, creating a draught of air over the material being dried. The material which is being dried is placed in the hollows of the lower sheet.

There are a number of possible ways of siting and constructing this dryer. It can be permanently sited or made portable. Certain refinements can be added to increase its efficiency. For this reason the construction of a simple portable model will be described first; possible modifications will be described later.

### The Portable Dryer

In this model, the corrugated sheets are fastened to a shallow wooden box which contains a bed of insulating material. The box will be about 10cm high and 80cm wide. The dimensions of the box will depend on the final size of the prepared corrugated sheets, so the sheets are prepared first.

### Tools and Materials

- . Hammer, saw, tri-square, wood chisel, pliers
- . 2 sheets corrugated galvanized iron
- . Timber for bottom and sides of box
- . Nails or coat-hanger wire
- . Black paint

#### 1. Prepare the Sheets

- . When purchased, the sheets will be packed closely together. Turn the upper sheet 180° so that the sheets are on top

### Solar Dryers

of each other. The upper sheet will tend to slip sideways and will not remain evenly positioned.

- Mark a line along the edges of each sheet about 1cm from the edge. Using pliers, and moving gradually along the sheet, bend the edges down to form flanges which are level with the plane of the sheet. Once the edges have been bent into position, lay each flange along the edge of a piece of wood and beat with a hammer until it is flat and smooth. The sheets will now lie properly together in the correct position.

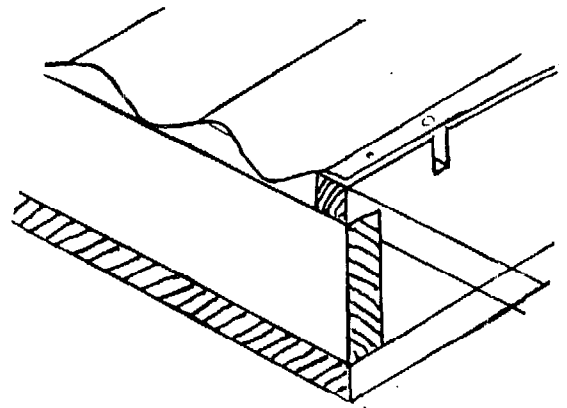

## 2. Hinge the Sheets

- The sheets must be held together so they can be easily positioned during future use. This is done using wire rings.
- Wind a piece of suitable wire spirally around a 1cm diameter former (e.g., the handle of a wooden spoon) to form 6 loops. Remove from the former and pull the ends of the wire so that it forms a loose spiral. Cut this spiral with the pliers so as to form a number of rings with overlapping ends.

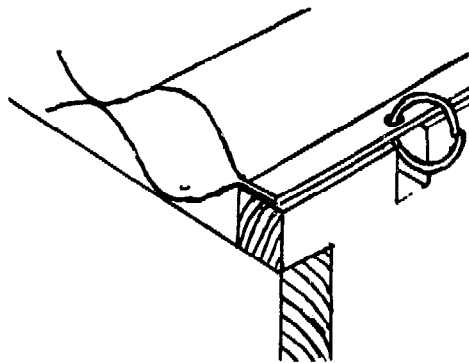

- Punch five holes through the flanges at one edge of each sheet, using a nail and a hammer. These holes should be positioned as follows: one hole about 7.5cm from each end of the flange, one hole in the centre of the flange, and two holes midway between these holes.

### Solar Dryers

Pass the wire rings through these holes and close the rings by pressing the ends together. This effectively hinges the sheets together and allows accurate positioning.

#### 3. Prepare the Dryer Box

- . The shallow support and insulating box can now be constructed to fit the dimensions of the lower sheet of corrugated iron: cut slots in the upper edges of the one side of this box to provide space for the hinge rings.

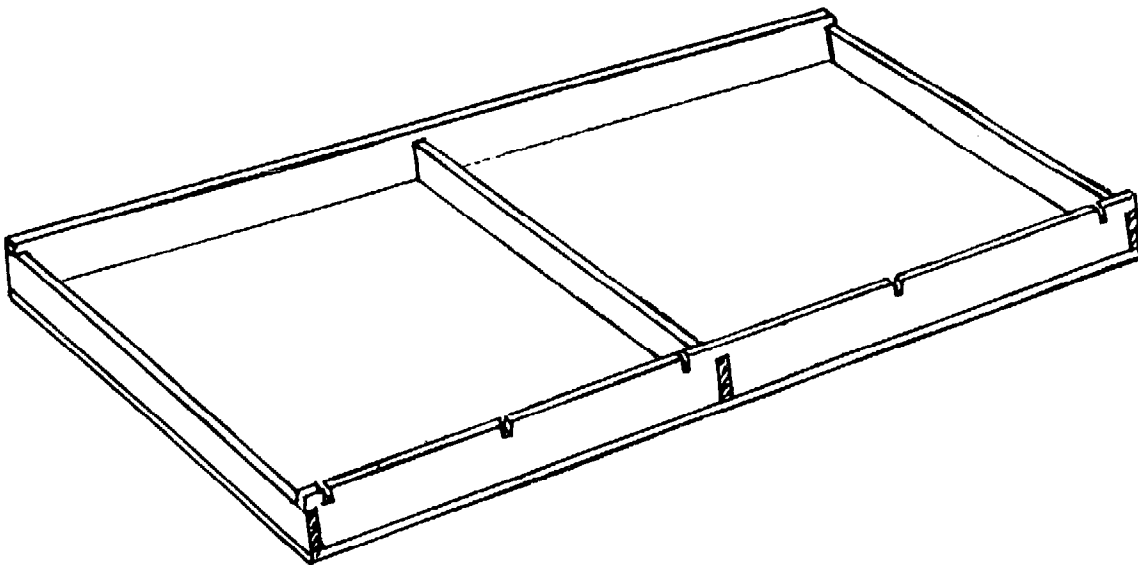

- . Pack the box with insulating material, e.g., wood wool, dried grass or leaves, or other similar material.
- . Place the corrugated sheets in position and fasten the lower sheet to the frame by nailing through the flanges along each edge and through the points where the sheet contacts the ends of the box and the central support batten.
- . Close the openings at each end between the corrugations of the sheet and the wooden frame by filling with cement, plaster or clay.

*Solar Dryers*

4. Paint the Dryer

- . Paint the upper surface of the top sheet with a flat, black paint. Using a suitable primer to be sure of sticking to the metal.
- . Treat the wood of the box with preservative, or paint with gloss paint if available.

USING THE PORTABLE DRYER

Siting

- . Site with the length of the dryer in a north-south direction, preferably in a position where it is sheltered from the wind.
- . Raise one end so that it is 15cm higher than the other.
- . Make sure the rays of the sun strike the upper sheet as directly as possible. (The end to be raised will depend on the latitude and season of the year. For example, in latitudes more than 5 degrees north of the equator, the northern end of the dryer should be raised in winter and the southern end in summer.)

Protecting from Rain

There is a risk that driving rain may enter the upper end of the dryer and wet the contents. It is thus necessary to fit a shelter plate to the upper sheet at this end of the dryer.

- . Nail a wooden batten across one end of the upper surface of the top sheet.
- . Nail to this wood a strip of metal which is the full width of the sheet, and which will jut out about 15cm beyond the end of the dryer. This metal can then be bent downwards in a gentle curve at its outer edge so as to shelter the open end of the dryer.

Solar Dryers

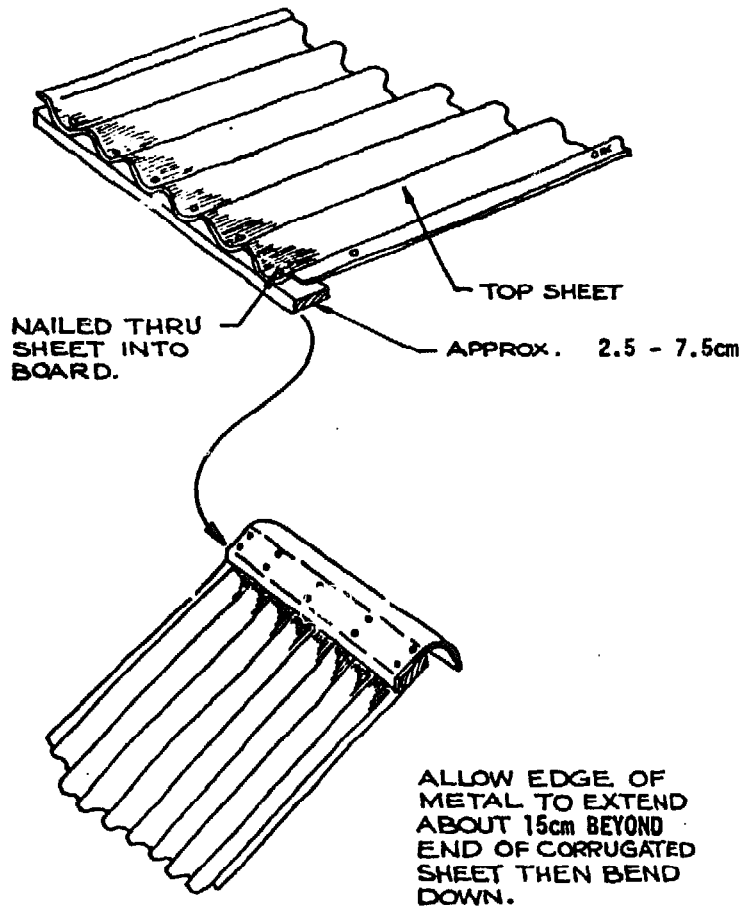

Fitting a Polyethylene Cover

The efficiency of the Model 3 dryer can be greatly increased by fitting a polyethylene cover over the top metal sheet. The plastic creates an insulating air space between the polyethylene and the corrugated sheet.

- Build a simple wooden frame over the top sheet using two vertically placed battens along each of the flanges, and two joining battens across each end of the sheet.



Solar Dryers

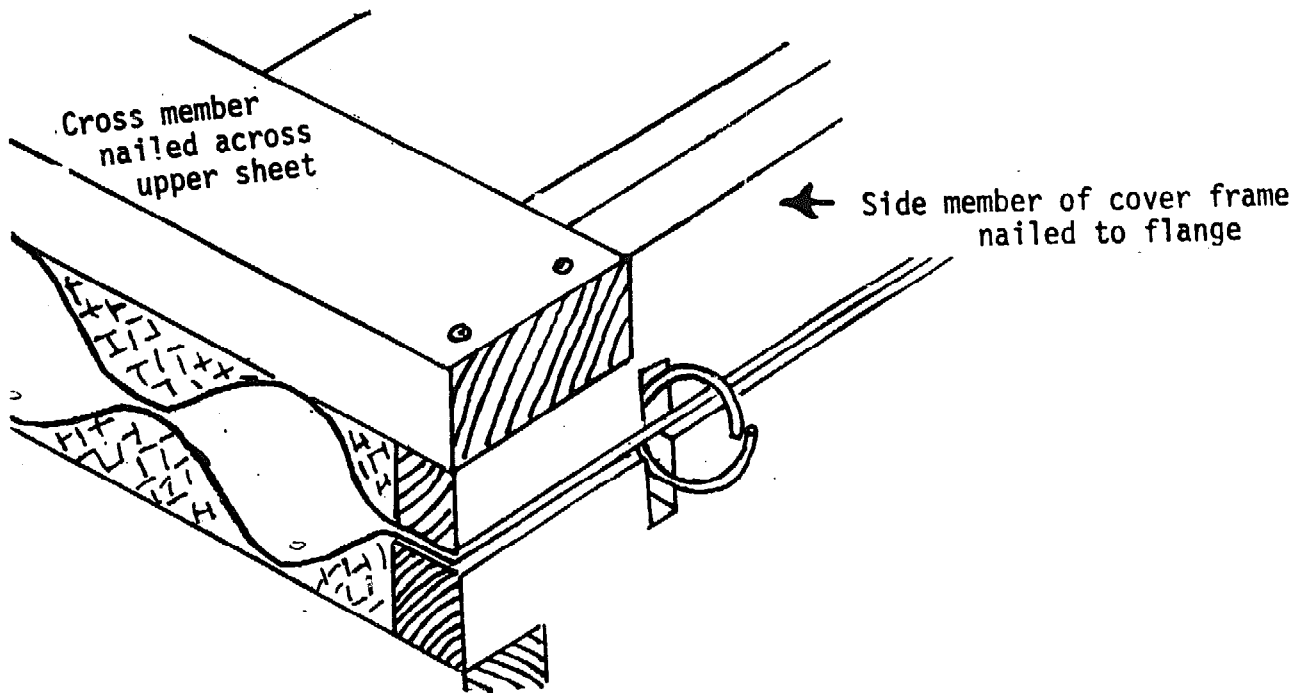

- Fill the spaces between the corrugations and the end battens with plaster, clay, or cement. Stretch a single sheet of polyethylene over the frame. Tack or staple the sheet in place.
- Keep the slots in the side piece of the frame (necessary to accommodate the hinge rings) as small as possible. They should only be cut enough to allow clearance for the rings.

The polyethylene cover will protect the upper corrugated sheet from the cooling effects of wind and rain. It also insulates the dryer so that higher drying temperatures are possible.

*Solar Dryers*

THE PERMANENTLY SITED MODEL 3 DRYER

The dryer described above can be permanently sited on a clay platform, thus avoiding the need to construct a support and the lower insulating box. The clay platform will provide insulation. This type is built as follows:

- . Flange the sheets and hinge together as described for the portable dryer.
- . Nail wooden battens about 4cm x 2cm across the lower side of the lower sheet at each end and at the middle, to provide rigidity.

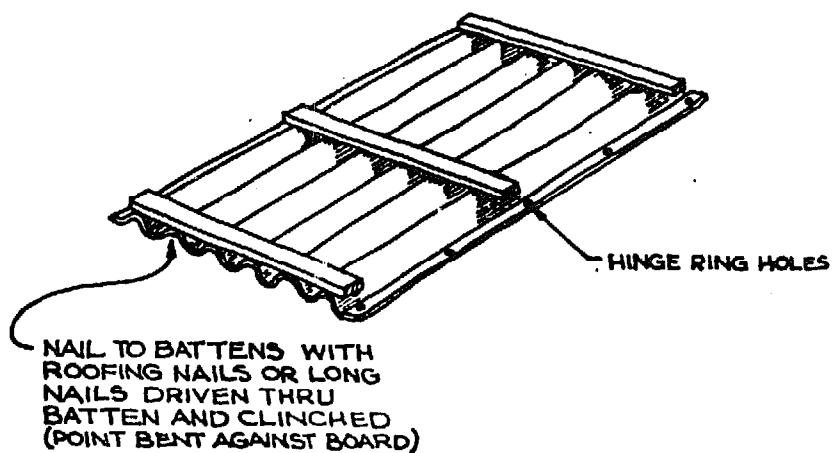

- . Construct a simple sloping clay platform the size of the lower sheet and 15cm above ground level at one end and 30cm above ground level at the other. Mix large quantities of dried grass or leaves with the clay.

*Solar Dryers*

- While the clay is still wet and soft, bed the lower sheet in position so that the clay moulds to the corrugations of the sheet. Allow the clay to harden.

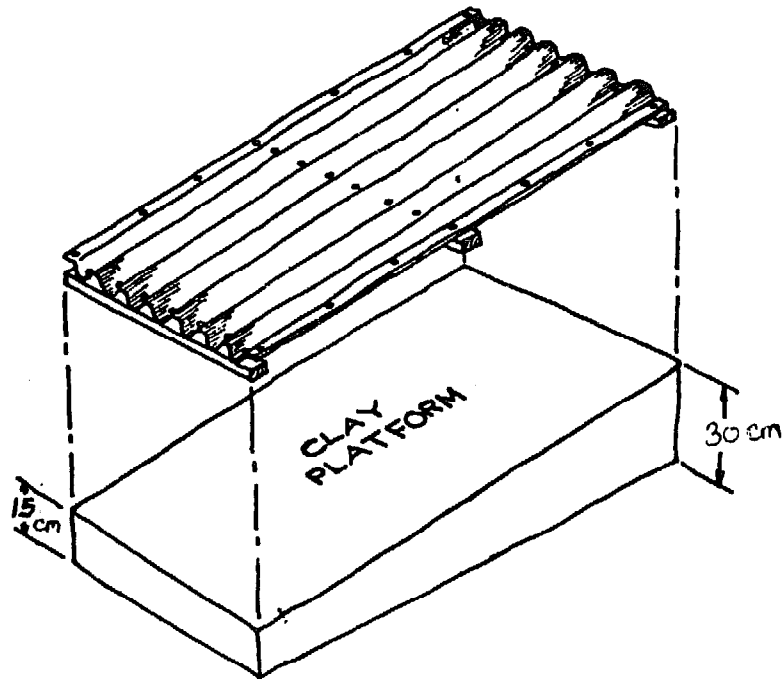

**CAUTION:** Make sure to site this dryer in a position which will give the most effective exposure to the sun at the time of year when the most drying is being done.

## SOLAR DRYERS

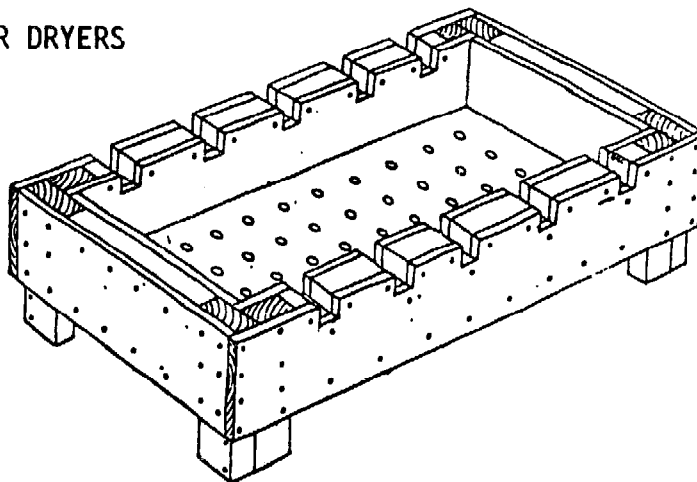

### PART TWO:

### OPERATING INSTRUCTIONS

#### General Instructions

Start drying as early as possible in the day to get maximum exposure to the sun. Once material has been placed in the dryer and the cover placed in position, do not lift the cover until drying is completed for the day: taking the cover off will allow a lot of heat to leave the dryer.

#### Cleanliness

Brush the dryer out daily to get out dust, and to remove any pieces of dried material spilled from drying trays.

Keep the drying trays clean; wash them often.

#### Temperature Control

Control the temperature inside the dryer by opening or closing the upper air outlets. Temperature may be measured by putting a thermometer in one of the upper air outlets. When doing this, shade the thermometer from direct sunlight by inserting a card beneath the cover. Temperatures measured in this way will be the maximum (not necessarily the average) internal temperature.

Or, temperatures at the level of the drying material may be measured by drilling a hole through the side of the dryer and inserting a thermometer. Again, make sure that the bulb is shaded from direct sunlight.

Closing the upper ventilation outlets will increase internal temperatures. However, if moisture begins to collect inside the dryer you must start opening the outlets.

In cases where opening all the upper outlets still results in temperatures which are too high for the material being dried, additional outlets should be cut in the upper edges of the sides.

## Solar Dryers

### Shade Drying

Some materials, particularly green vegetables, carrots, plantain and some varieties of sweet potato, may lose color and Vitamin A during direct exposure to sunlight. For these materials, shade drying is useful (but not completely necessary).

To do shade drying, fit sheets of thin metal immediately below the cover. Paint the metal (galvanized sheet or beaten-out tin containers) black on both sides. The size of the metal sheet should be just less than the internal length and width of the dryer. Support the sheet on nails driven into the inner sides and ends of the dryer. Put the nails in not more than half-an-inch below the upper edges of the sides.

Make sure the sheets do not touch the lower side of the polyethylene cover (otherwise their heat may cause it to melt). But the sheets should be high enough so that hot air from beneath the sheet can still escape through the upper air outlets.

When fitted properly, as described above, these sheets will send almost all of the heat they receive to the air inside the dryer, and the internal temperatures are similar to those made by sunlight. Use of metal shading sheets can, in fact, assist drying, since their presence encourages more effective convection air movement through the dryer.

### Fogging

If fogging occurs during use, withdraw tacks or staples from a short length at each end of the cover, open up the polyethylene to allow moisture to escape while the dryer is in operation, and then refasten the polyethylene in place.

### "Storage" Heating

A simple modification to either the Model 1 or Model 2 dryers, which will enhance efficiency of drying during periods of intermittent clouding or rain, is the placing of a layer of dark-colored (or black-painted) rough-surfaced stones in the bottom of the dryer. These stones should be egg sized or slightly larger.

During periods of sunshine, the stones will become heated. Then when the sun is covered by clouds, the stones maintain the internal temperature by giving up heat to the air.

*Sol a Dryers*

DRYING GRAIN CROPS

To make sure crops do well in storage, they should be carefully dried, either "in the head" or after threshing, before they are placed in storage. If dried "in the head," grains should be threshed before storage since closely packed grain is less subject to insect attack.

Groundnuts can be dried either in the shell or after shelling. Storage in the shell provides protection against insect attack.

Shattering sesame may be harvested before pods are quite ripe and dried in trays with very fine mesh bottoms. It will then shatter in the dryer. But since all the seeds will be retained, this method of dealing with sesame has great advantages.

Threshed grains should be spread in a 1cm to 4cm deep layer on drying trays of appropriate mesh size, so as to give a loading of about 7-10kg per square meter. For bulky material such as unthreshed finger millet or sorghum, layers up to 7.5cm deep can be used. For groundnuts in the shell, layers may be up to 5cm deep.

For very small seeds, such as finger millet or sesame, trays with a very fine mesh will be needed. Mosquito netting or tightly stretched hessian sacking would be appropriate.

## ENEMIES OF STORED GRAIN PART 1: INSECTS

This discussion of insects deals only with some of the insects that attack stored grain. It is designed to help you provide farmers with the information they need to control insect infestation in their stored grain. If you find insects in your area that are not discussed here, or if you require more information on insects in general, there are more detailed books which will help you name the pest and will give information on controlling the pest.

### WHAT IS AN INSECT?

Insects have six legs. Farmers may see other insect-like creatures in or near their grain, but they are not insects if they have more or less than six legs. Spiders, mites, and scorpions have more than six legs, so they are not insects.

Most insects have two pairs of wings; some insects can fly and some cannot. All insects have three main parts to their bodies: head (front); thorax (middle); abdomen (behind). The legs and wings are attached to the thorax.

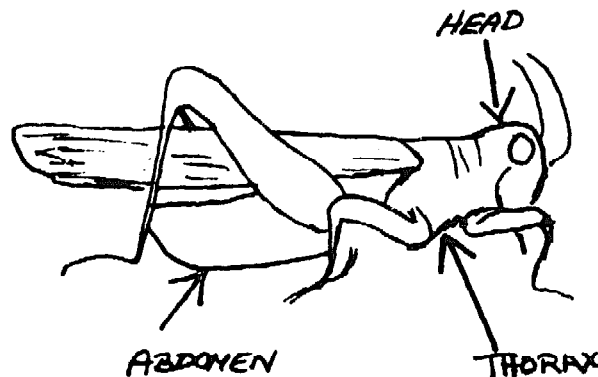

Some Other Facts About Insects:

- . Insects have no bones, and the soft inside parts are protected in a hard case called the exoskeleton.
- . Insects bite off, scrape off, or chew food using their mandibles (jaws).
- . Some insects are 25cm long. Most grain storage insects are only from 2 to 20mm long. The length of an insect is measured from the tip of the head to the end of the abdomen.

INSECT LIFE CYCLE

Humans grow from babies to children to adults. This is the human life cycle. Most grain insects grow from eggs to larvae to pupae to adults. These growth stages are the insects' life cycle.

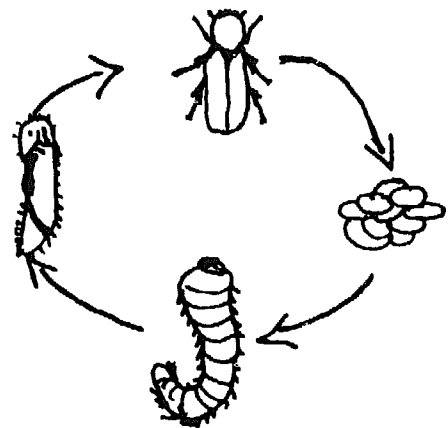

It is not important for a farmer to know the names of the insects or the names of the stages in their life cycles. But it is important for him to be able to recognize insects at all these stages. Moreover, he must know how stored grain insects develop, so he will know where to look for signs of insects in his grain. Adult insects are easy to see, but larvae and eggs of insects often are not.

Eggs

Each female insect can lay many eggs. The number of eggs depends upon the kind of insect; some females lay hundreds of eggs. And each of these eggs could grow into a new adult. Some insects lay eggs on top of the grain; some insects lay eggs inside the grain. The eggs are laid in storage or in the field, depending upon the kind of insect.

Larvae



Eggs hatch into larvae. Larvae are often the big grain eaters. A larva growing inside a grain kernel eats out the inside of the kernel. Each larva is covered with a tough skin called the cuticle. The larva grows and the cuticle



gets too small. The larva throws the cuticle away, keeps eating, and forms a new skin. This whole process might happen three or more times before the larva is full size and passes to the next stage.

### Pupae

This is the transformation stage. Sometimes the larva forms a cocoon or other protective covering around itself as it goes into this stage. As a pupa, the growing insect needs no food and moves only in very small movements. It just slowly changes into an adult insect.

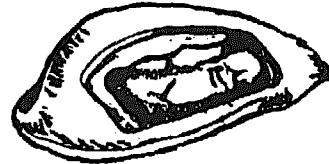

### Adult

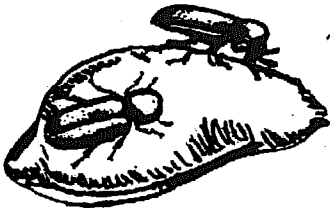

When all the adult characteristics are developed, the pupa throws off a last skin and the adult comes out. The new adult is pale and soft. It takes 2 - 72 hours for the cuticle of the adult to harden and take on adult coloring and markings.

### HOW INSECTS GET INTO GRAIN

Insects get into grain in a number of ways, depending upon the kind of insect:

- . Some insects infest the grain while it is still in the field -- before harvest and after (if the grain is being dried in the field).
- . Some insects can fly from fields to stored grain and from stored grain to the fields. This type of insect is very dangerous because it can so easily get to the grain.

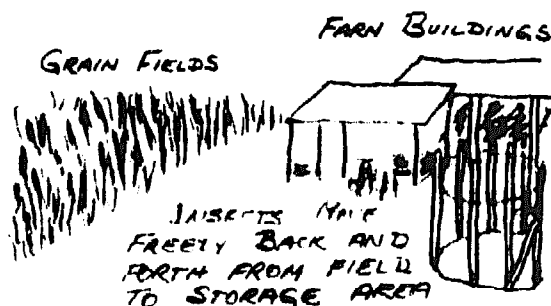

- Farmers store grain year after year in the same sacks, containers, and buildings. Bins made of wood or woven grasses have cracks and spaces which fill up with dust, dirt, and broken grains. Insects live in these dirty places and infest the new grain right after it is put into the container.
- New grain is put into a storage building containing grain left from the last harvest, grain already heavily infested.
- Grain goes from the field to the storage place in carts and wagons which were not cleaned after the last use.

#### WHY INSECTS INFEST GRAIN

Insects which infest grain also eat and live in other materials. Insects infest grain because grain provides food. Unfortunately, in too many cases, stored grain provides a perfect place for insects to live and grow because food, air, moisture, and heat are provided.



#### Food

Obviously, grain provides food. But grain provides food for insects in different ways. Some insects like certain kinds of grains better than others. Not all insects eat the same part of the grain kernel. How they eat the grain and the part of the grain they eat depends upon the type of insect.

Primary Pests. Some insects, such as the Angoumois Grain Moth, the Lesser Grain Borer, and the Rice Weevil are primary pests. They attack the grain first. They are able to break down the hard seed coat of the whole grain. Their eggs are laid inside the kernel, and the growing larvae eat the inside of the kernel.

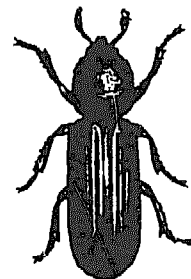

Secondary Pests. Other insects follow these first attackers. These are secondary pests. They feed on the grain that now has broken and cracked seed coats. The Rusty Grain Beetle is a good example of a secondary pest. This beetle will not attack healthy, undamaged grain, but it will attack spoiled grain. A farmer should know which beetles attack first and which do not. If a farmer sees a Rusty Grain Beetle in his stored grain, it is a sign that he should look for other, worse insect attackers.



Tertiary Pests. There is even a third group of insects found in stored grain. These are the tertiary pests. They feed on broken grains, grain dust, and powder left by the other groups. The Confused Flour Beetle is a tertiary pest of whole grains. Also, it is a primary pest of milled grains, such as flour.



It is not important for a farmer to know the names of these insects, but he should know how the given insects eat and whether they attack grains already damaged. If he can read the signs left by the insects, he will be better able to find infestations before they become a major problem.

## Air

Insects do require a certain amount of air containing oxygen to live. Storing grain in containers which keep out air is based on knowledge of this fact. Airtight storage will be discussed later. Briefly, in airtight storage, the respiration of the grain, and of insects in the grain, uses up the oxygen quickly; any insects present in the grain will die.

## Moisture

Insects need some moisture to live, and they can get it from stored grain in several ways:

- . Insects can take moisture from the air, just as grain can.
- . Grain contains moisture which insects get when they eat it. The more moisture the grain contains, the better food it is for insects.
- . Insects produce moisture and heat in the stored grain as they eat. The insect-infested grain then respire more quickly

and produces more heat and more moisture. In a hot spot, where insects are active, grain releases a lot of moisture into the grain mass. Insects can take this moisture into their bodies. When the hot spot becomes too hot, the insects will leave it and go to another part of the grain mass.

Insects can take moisture directly from the wet surfaces of the grain through special openings in their bodies.

The fact that insects require a certain amount of moisture is important because it underlines the need for careful drying of grain before it goes into storage.

### Heat

Insects live best within a certain temperature range. As the temperature in the grain gets lower, they become less active. At one point they stop reproducing. If the temperature goes below 5° C they will die, depending on length of exposure and other conditions. As the temperature increases from 10-26° C, depending upon the kind of insect, they become more and more active. They will reproduce very quickly in a grain hot spot, for example, until the grain gets too hot. Above 35° C. they have a more difficult time living and die at 60° C.

Try to keep stored grain as cool as possible.

### COMMON GRAIN PESTS

There are many kinds of insects which can attack stored grain. But it is a much smaller number of insects which cause the major insect problems in stored grain.

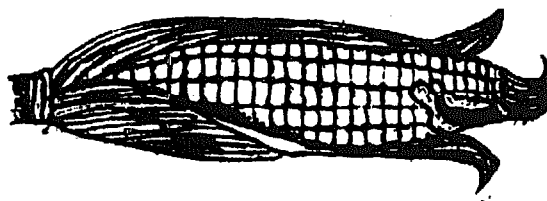

The following pages contain information on some major stored grain insect pests. Each insect is discussed on a separate page. This information should help farmers identify the insects which are in their grain. Since the right control method often depends upon the kind of insect involved, and upon the characteristics of that insect's life cycle, each page gives a picture and description of the insect and other information on that insect's habits and life cycle.

## GRANARY WEEVIL

*Sitophilus granarius* L.

### WHAT IT LOOKS LIKE

- . Brown or black
- . Long, thin nose
- . Strong jaws
- . Long stripes on the body
- . No wings
- . 3.5mm long



ENLARGED

### ACTUAL SIZE



### WHERE IT LIVES

- . In many kinds of grain
- . In all parts of the world

### LIFE CYCLE

- . Develops from egg to adult in 4 weeks, in warm weather

#### Eggs

- . Female lays 50 - 250 eggs inside the grain kernel after female makes hole with strong jaws

#### Larvae

- . Grow inside grain kernel
- . See Picture

#### Pupae

- . See Picture

#### Adults

- . Develop from egg to adult in 4 weeks, in warm weather
- . Leave the seed and eats the kernel while getting ready to lay eggs
- . Adult lives 7-8 months

LARVA INSIDE KERNEL OF WHEAT

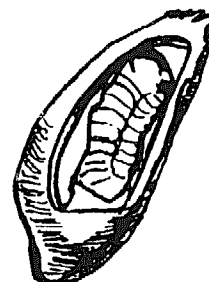

PUPA INSIDE KERNEL OF WHEAT

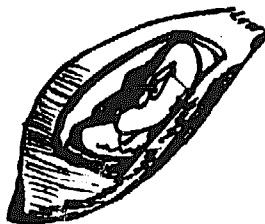

ADULT EATING KERNEL OF WHEAT



**NOTE:** A Primary Pest. It looks a lot like the Rice Weevil. The Granary Weevil and the Rice Weevil are the only grain storage insects with long snouts (noses), so they are easy to see. The Granary Weevil cannot fly; the Rice Weevil can fly.

## LESSER GRAIN BORER

*Rhyzopertha dominica* F.

### WHAT IT LOOKS LIKE

- . Shiny, dark brown or black
- . Head turned down under body
- . Strong jaws which cut wood
- . 2.5 to 3mm long



ADULT  
ENLARGED

ACTUAL SIZE



### WHERE IT LIVES

- . In warm places all over world
- . In many kinds of grain

### LIFE CYCLE

- . Life Cycle is completed in about 5 weeks
- . Each female lays from 300-500 eggs



LARVA IN KERNEL  
OF WHEAT

### Eggs

- . Laid on the surface of the grain or in spaces between grains
- . Hatch in a few days

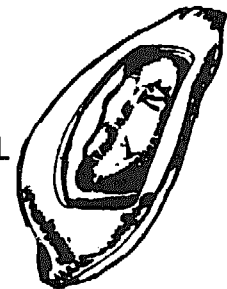

PUPA IN KERNEL  
OF WHEAT

### Larvae

- . Crawl around grain eating flour left by the boring of adult beetles
- . Bore holes in damaged grains
- . Finish growing inside grain kernel
- . Picture of larva inside kernel of wheat. See Picture



ADULTS EATING

### Pupae

- . See Picture

### Adults

- . Cut their way out of the kernel
- . Feed on grain

NOTE: A Primary Pest, both the beetles and the larvae of the Lesser Grain Borer are very dangerous insect pests. They bore holes in the grain and leave behind a powder from the chewed-up grain. Here is a picture which shows kernel of wheat full of holes made by the boring and feeding of the adult and the larvae.

**SAW-TOOTHED GRAIN BEETLE**

*Oryzaephilus surinamensis* L.

**WHAT IT LOOKS LIKE**

- . Narrow, flat, small, dark brown
- . 3.5 mm long

**WHERE IT LIVES**

- . In sorghum, maize, and other cereals and flour

**HOW IT GROWS**

- . Grows from egg to adult in 3 to 4 weeks in warm weather
- . Each female lays about 300 eggs

Eggs

- . Laid among the grains
- . Hatch in 3 to 5 days

Larvae

- . Are straw colored
- . Crawl among the grain eating broken kernels
- . Grow in this stage about 4 weeks

Pupae

- . Form in a cocoon
- . See Picture

Adults

- . Adults live from 6 months to 3 years



ADULT  
ENLARGED

ACTUAL SIZE



LARVA  
ENLARGED



PUPA  
ENLARGED

## FLAT GRAIN BEETLE

*Laemophloeus pusillus* Schönherr

### WHAT IT LOOKS LIKE

- . Long antennae (feelers)
- . Reddish-brown, flat
- . 1 - 2mm long



ADULT  
ENLARGED

### WHERE IT LIVES

- . In produce which is dusty, contains broken grain, or is already infested

### HOW IT GROWS

- . Grows from egg to adult in 5 weeks

### Eggs

- . Laid in cracks in grain or in spilled grain

### Larvae

- . Yellowish-brown
- . Like to eat the germ of cereal grains
- . May not eat any other part of grain
- . Like to eat grain having mold on it



ACTUAL SIZE

### Pupae

- . Transform in a cocoon

### Adults

- . Live from 6 - 12 months



LARVA  
ENLARGED

NOTE: The flat Grain Beetle can be a primary pest. But if you find this beetle, you know that other, more dangerous insects are in the grain. Often you find the Flat Grain Beetle in grain already damaged by the Rice Weevil.



## ANGOUMOIS GRAIN MOTH

*Sitotroga cerealella* Olivier

### WHAT IT LOOKS LIKE

- . Light, yellow-brown
- . 8-10mm long
- . 15mm from tip of wing to wingtip
- . Fringe on back wings



ENLARGED

ACTUAL SIZE



### WHERE IT LIVES

- . Attacks all grains in storage and in the field
- . In all parts of the world

### LIFE CYCLE

- . Adults do not live long and do not eat
- . Each female adult lays 50-100 eggs

LARVA ENTERS KERNEL AND BEGINS GROWING



### Eggs

- . Laid on the surface of grain in the field or in storage



FULL-GROWN LARVA IN WHEAT KERNEL

### Larvae

- . Eat into kernel after hatching
- . Grow inside kernel for 5 weeks
- . Eat inside to the seed coat and they cut out part of a circle (door) in the seed coat

PUPA IN KERNEL OF WHEAT



### Pupae

- . Form inside a cocoon near the door cut by the larvae

### Adults

- . Push out through the door prepared by larvae
- . Lay eggs on the stored grain or fly to the fields and lay eggs on grain there

ADULT MOTH LEAVES THE WHEAT KERNEL

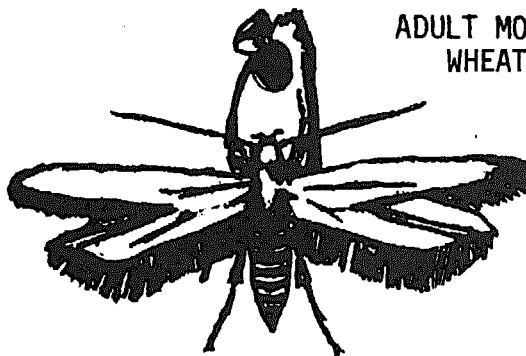

NOTE: PRIMARY PEST

## RICE WEEVIL

*Sitophilus oryzae* L.

### WHAT IT LOOKS LIKE

- . Reddish-brown or black
- . May have 4 light spots on its back
- . Long nose is easy to identify
- . 2.5mm long

### WHERE IT LIVES

- . In warm places
- . In sorghum, maize, and other stored grain

### HOW IT GROWS

- . Female lays 300-400 eggs

### Eggs

- . Laid inside the grain kernel
- . Sealed into the hole with secretion which makes them difficult to see

### Larvae

- . Have no legs and are white
- . Grow inside grain kernels and do most of the damage
- . Stay in larval stage about 5 weeks

### Adults

- . Leave the kernels. Half kernel is eaten and other half is poor quality
- . Feed on the seeds
- . Looks like the Granary Weevil, but this weevil can fly

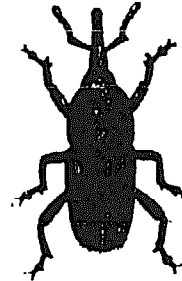

ADULT  
ENLARGED

ACTUAL SIZE

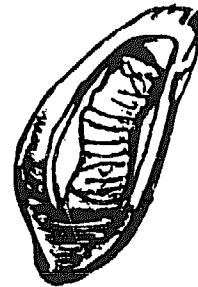

PUPA IN KERNEL  
OF WHEAT

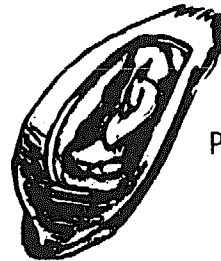

PUPA IN KERNEL  
OF WHEAT



ADULT EATING KERNEL  
OF WHEAT

NOTE: PRIMARY PEST. It can fly. It flies from grain storage places to the fields and back again. It can infest grain again and again.

## INDIAN-MEAL MOTH

*Plodia interpunctella* Hbn.

### WHAT IT LOOKS LIKE

- . Reddish-brown outer wings
- . Whitish-gray wings next to body
- . 16mm from tip of one wing to tip of the other
- . Easy to see in grain

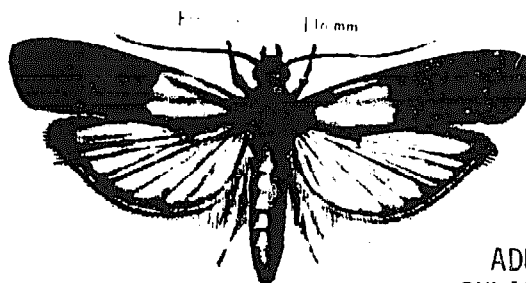

ADULT  
ENLARGED

### WHERE IT LIVES

- . In broken grains and flour.  
Also can attack whole gains
- . In all parts of world

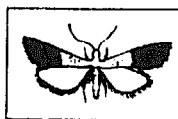

ACTUAL SIZE

### HOW IT GROWS

- . Grows from egg to adult in  
6-8 weeks
- . Each female lays 200-300 eggs

### Eggs

- . Laid on food or grain
- . Hatch into small, white larvae

### Larvae

- . Eat embryo
- . Spin thread while they eat
- . Dirty white color
- . Sometimes look pink or green
- . Spin a cocoon

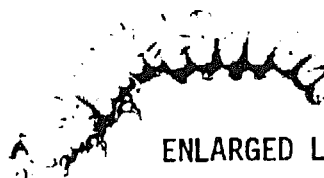

ENLARGED LARVA

### Pupae

- . Light brown
- . Develop in a cocoon

### Adults

- . Usually attack grain already  
attacked by other insects
- . Live less than 14 days

ADULT WITH  
WINGS FOLDED



NOTE: Checking and moving grain from time to time is good protection against this insect. Also, the Indian-Meal Moth is attacked by the parasite *Bracon hebetor* Say.

## **CONFUSED FLOUR BEETLE**

*Tribolium confusum* J. du Val

### **WHAT IT LOOKS LIKE**

- . Shiny, reddish-brown, flat
- . 3-4mm long

### **WHERE IT LIVES**

- . In all parts of the world
- . In storage places and flour mills

### **HOW IT GROWS**

- . Changes from egg to adult in 6 weeks in warm weather
- . Female lays 450 eggs
- . Eggs are sticky and stick to boxes, sacks, and storage containers

### Larvae

- . Larvae eat flour, grain dust, and broken surfaces of grain kernels

### Pupae

- . First white, then change to yellow and then to brown color

### Adults

- . Live about 1 year

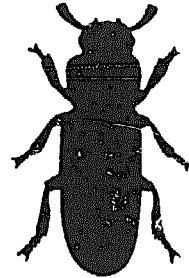

ADULT  
ENLARGED



ACTUAL SIZE



LARVA  
ENLARGED

**DRUGSTORE BEETLE**

*Stegobium paniceum* L.

**WHAT IT LOOKS LIKE**

- . Small, fat, reddish colored
- . Body covered with soft hairs



ADULT  
ENLARGED



ACTUAL SIZE

**WHERE IT LIVES**

- . In many kinds of stored grain
- . In all parts of the world

**LIFE CYCLE**

- . Develops from egg to adult in 6-8 weeks
- . Each female lays about 100 eggs

Eggs

- . Laid in any dry food substance

Larvae

- . Small and white
- . Enlarged picture

Adult

- . Looks like cigarette Beetle
- . Adults live only 2 to 4 weeks

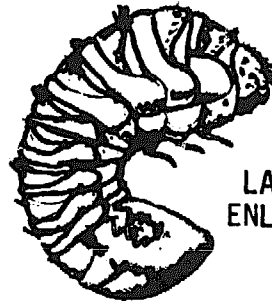

LARVA  
ENLARGED

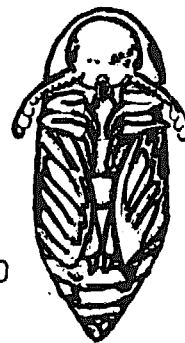

PUPA  
ENLARGED

**NOTE:** Protect grain from this beetle by checking the stored grain often. This beetle never attacks grain unless the grain has been in storage for a long time without being checked or moved.

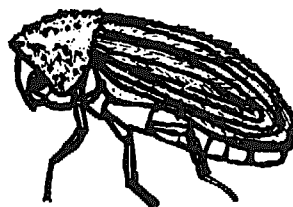

SIDE VIEW OF ADULT

**RED FLOUR BEETLE**

*Tribolium castaneum* Hbst.

**WHAT IT LOOKS LIKE**

- . 3-4mm long
- . Looks like Confused Flour Beetle

**WHERE IT LIVES**

- . In warm countries
- . In grain dust and broken grains

**HOW IT GROWS**

- . Female lays 400 - 500 eggs

Eggs

- . Laid in dust, flour

Larvae

- . Stay in larval stage 5 weeks
- . Feed on stored produce
- . Whitish-yellow color
- . Has two, dark, upturned, pointed projections at back end of body

Adults

- . Eat and breed the same way as Confused Flour Beetle
- . Give terrible smell and taste to grain in which they live

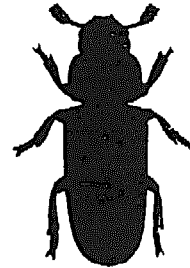

ADULT  
ENLARGED



ACTUAL SIZE



LARVA  
ENLARGED

## **KHAPRA BEETLE**

*Trogoderma granarium* Everts

### **WHAT IT LOOKS LIKE**

- . Brown or black color
- . Body has many fine, yellowish hairs all over
- . 1.5 - 3mm long

### **WHERE IT LIVES**

- . In stored grain
- . In all parts of the world, particularly warm places

### **HOW IT GROWS**

- . Grows from egg to beetle in 4 - 6 weeks in good growth conditions
- . Female lays 40 - 70 eggs each

### Larvae

- . Can take up to a year to hatch
- . Yellow-white and have many hairs
- . Leave many hairs in the grain
- . Grow to 6mm in the larval stage. Takes about 3 weeks
- . Are able to live without food or water for long periods
- . Appear on surface of stored grain
- . Crawl into cracks of buildings and bins. Hard to reach even with insecticide

### Adults

- . Life cycle can take years while under poor conditions
- . Breed quickly under good conditions
- . Live only about 14 days

**NOTE:** Primary Pest. Grain damaged by the Khapra beetle looks like grain which has been attacked by the Lesser Grain Borer.



**ADULT  
ENLARGED**



**ACTUAL SIZE**

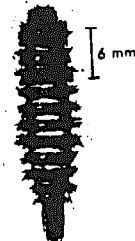

**LARVA  
ENLARGED**

**CIGARETTE BEETLE**

*Lasioderma serricorne* F.

**WHAT IT LOOKS LIKE**

- . Reddish-yellow or brown
- . Head bent down toward body
- . 3mm long



ADULT  
ENLARGED



ACTUAL SIZE

**WHERE IT LIVES**

- . In stored products all over the world
- . In grain left too long in storage in the original sacks

**LIFE CYCLE**

- . Develops from egg to adult in 6 to 8 weeks
- . Female lays about 100 eggs

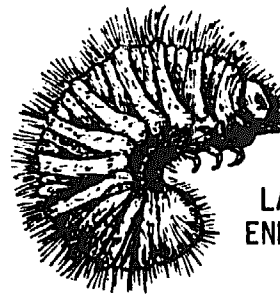

LARVA  
ENLARGED

Larvae

- . See Picture

Pupae

- . See Picture

PUPA  
ENLARGED

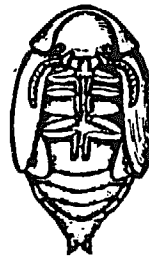

Adult

- . Looks like adult Drugstore Beetle
- . Adults live from 2 to 4 weeks.

SIDE VIEW OF ADULT

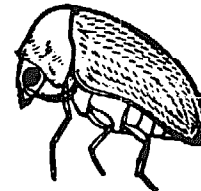



## FLOUR OR GRAIN MITE

*Acarus siro* L.

### WHAT IT LOOKS LIKE

- . Pale, gray-white color
- . Smooth bodies with lots of hairs
- . Breed quickly
- . Real size no bigger than the dot of an "i"



ADULT  
ENLARGED

### WHERE IT LIVES

- . In warm, wet places
- . In broken grain and flour

### WHAT TO LOOK FOR

- . Fluffy, light-brown masses on the floor around sacks of stored grain
- These masses are the old skins and dead bodies of mites. If you see these masses, there are many, many mites in the grain



ACTUAL SIZE

### WHAT MITES DO TO GRAIN

- . They do not eat much grain
- . When there are many mites, the grain gets warmer and wetter
- . When there are many mites, a bad smell develops in the grain
- . Flour which has had large numbers of mites in it is no good for baking

### WHAT TO DO ABOUT MITES

- . Screen and fan the grain if you find mites.
- . Dry grain very well before storing.
- . Dust sacks of flour or other milled cereal products with recommended insecticide. Place sacks so they do not rest directly on the floor.

## CONTROL OF INSECTS IN STORED GRAIN

### INTRODUCTION

Adult insects are easy to see in grain. They live outside the grain, and they are darker in color. Often a farmer waits until he sees adults before he takes any steps to control insects or applies insecticide. This approach can be a mistake. When the farmer sees adults, it usually means the grain contains many more insects than the ones he is seeing.

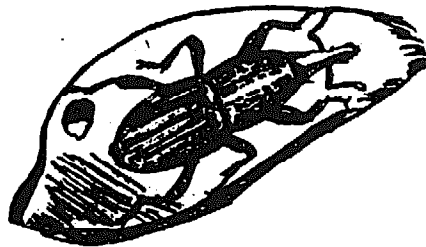

Insect control should begin before the harvest. And it must definitely begin before the grain is put into storage. There are many steps farmers can take to protect their grain from pests. Some of these steps involve insecticides, but all of them depend upon thorough cleaning of storage bins and containers.

The first step a farmer should take is to plan an insect control program. His program should include, among other things:

- . finding out which insects are damaging his grain.
- . drying and cleaning his grain very well.
- . asking an extension agent about insecticides.
- . deciding if he has enough money to buy insecticides.

The second step a farmer should take is to follow some general guidelines for cleaning and storing his grain.

Whether the storage area is old or new, it must be clean. Most farmers can save many grain losses by careful cleaning of storage containers, bins, and buildings. And cleaning does not cost large amounts of money. For just a little time and effort, the farmer can get better returns on the effort he puts into growing and harvesting his crop.

All equipment which touches the grain should be clean. This includes tools for harvesting and threshing. It also means cleaning the carts and wagons used for carrying the grain.

Cleaning and repairing should include:

- . sweeping out grain, grain dust, and dirt from storage bins, buildings, or areas in the home where grain is kept.
- . repairing cracks in floors, walls, and ceilings where insects might get in or live.
- . removing pieces of grain and dust from cracks, beams, ledges, and other parts of the building.
- . patching any holes in the building and making sure it is watertight; moisture must not get into the storage area.

Concrete and metal bins are easier to clean than wooden bins and sacks. But all containers should be cleaned as carefully as possible.

Many farmers make the mistake of storing grain from a new crop near grain from an older crop. If the grain from the old crop is full of insects (and it usually is), the insects will spread to the new grain quickly. Also, grain for eating and selling should never be put into storage with grain which will be used to feed the animals. Animal grain usually sits around for a long time and is full of insects.



RIGHT

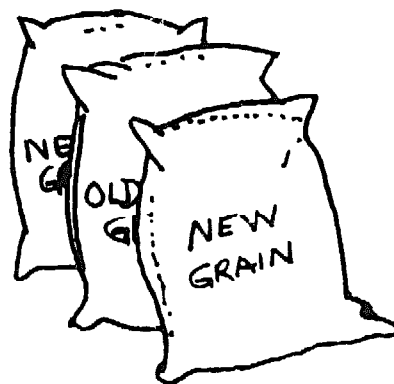

WRONG

Sometimes farmers cannot find or afford the correct insecticide. In these cases, careful cleaning will help the problem. In fact, insecticides will not work properly unless they are used under dry, clean conditions. So the following material presents information on steps the farmer can take to control insects -- both with and without the use of insecticides.

## CONTROLLING INSECTS WITHOUT INSECTICIDES

### Traditional Methods

Farmers have been fighting insects for hundreds of years. They accept the fact that insects are going to eat and destroy a certain amount of their grain. Here are some insect control methods farmers use:

Sunning. Insects leave grain which is placed in hot sunlight. They do not like heats higher than 40-44°C. The sunning process, however, does not always kill eggs and larvae which are inside the kernels of grain.

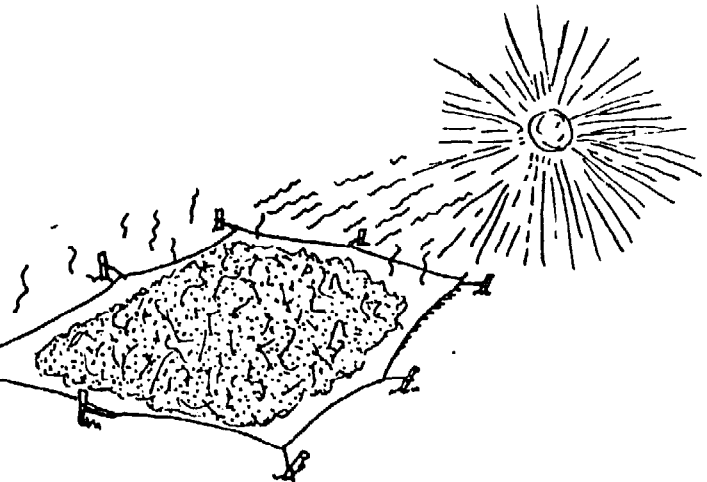

Mixing Local Plants with Grain. In many areas, farmers mix local plants with grain. Information about which plants, and which parts of the plants, should be mixed with grain is passed on within the family; the plants differ from one part of the world to another. Such natural control methods, or methods which provide active control without insecticide, need to be looked at more closely. Future editions of this manual might include a chapter on using such plants and other natural control methods.

Mixing Sand or Wood-Ash with Grain. This is another natural-control method. Some farmers mix sand or wood-ash with threshed grain to keep insects from breeding. The sand scratches the covering or cuticle of the insect's body and the insect loses moisture through the scratches. If the grain is dry, insects will not be able to get enough moisture to replace the moisture lost through the scratches, and they will die.

Smoking. Some farmers store unthreshed grain on raised wooden platforms. They build small smoky fires under the platforms. Other farmers store harvested grain in the roof of the building or shelter used for cooking. Both of these methods use the smoke and heat of fires to kill and drive insects out of the grain. The heat from the fires also helps to keep the grain dry and protects the grain from new insect attacks.

Storing in Airtight Containers. This is the process of putting grain into a closed container so that no air can enter the grain. Insects in the grain then die because there is not enough air containing oxygen. In some areas, farmers store grain in very dry underground pits which can be made quite airtight. Other types of airtight storage containers can be more difficult to build and maintain. Airtight storage is talked about more completely in the section on storage methods.

Storing Unthreshed Grain. The husk on maize and the hull of rice offer some protection from insect attack. If the rice hull is hard and dry, it is more difficult for insects to attack the grain kernels. Many farmers store their grain without threshing when they do not have insecticides.

### Improvement in Traditional Methods

It is very important to have a clean and waterproof building for storing the grain. If the farmer is choosing a site for a new building, the buildings should be placed as far away as possible from grain standing in the fields. This helps protect against insects flying from the field to the storage area. The grain storage place should not be built near places where animals are kept: certain insects found near animals and their food also attack stored grains.

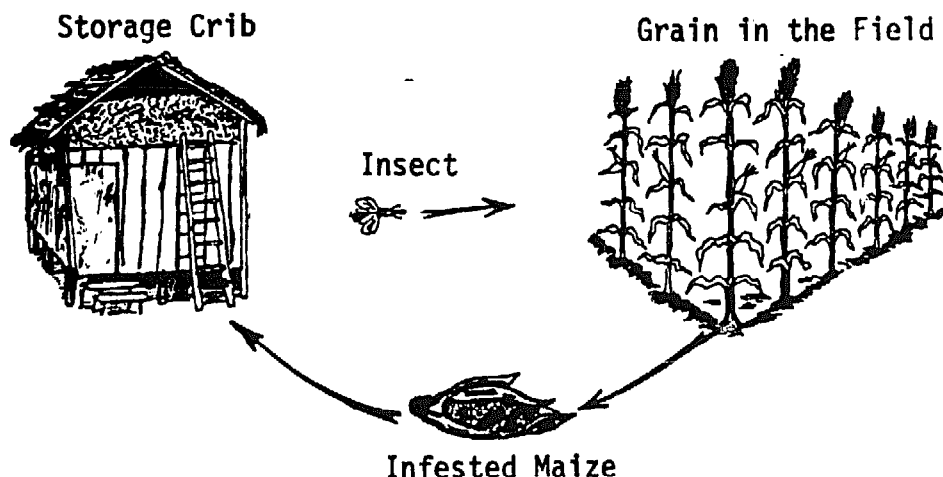

Most farmers know that insects are a problem, and will not have to be convinced. Or perhaps it is better to say that some farmers may need to be shown how insects infest grain; they must be convinced that there is really something they can do about insects. For a farmer who has looked upon insects in his grain as a part of his life for years, the biggest forward step he will take is realizing that there is something he can do about the problem.

There are some easy ways to show how insects can be kept out of grain. You probably use them in your work. Here is one way:

- . Take several small bags of grain, each of which is clean and free of insects.
  - Place one bag near the animal grain
  - Place one bag beside grain that has been in storage a long time
- . Place one bag in a clean, cool, dry corner away from other grain. Make sure this bag is not placed directly on the floor and keep it away from the walls.

Insects will, of course, attack all these bags of grain. What will be interesting is how long it takes for the infestation to develop in each bag, and how much damage occurs in a given period of time. It should take longer for the infestation to develop in the clean grain stored away from other grains.

Also, if you want to use the same demonstration to show how an improved storage method protects against insects, place insect-free grain, equal to the amount in the other bags, in a small plastic bag. Seal the bag tightly and put it next to bags of grain which have been in storage for some time. All of the other bags will have insects in them; this one will not.

Following here is a checklist of steps which can be taken to control insects without using insecticides. In fact, these rules for cleaning and storing only dry grain should be followed even if insecticide is used. Insecticides will not provide protection unless they are given the right conditions in which to work. Perhaps you will be able to adapt this checklist to fit your situation and use it as you work with farmers.

## CONTROLLING INSECTS WITHOUT INSECTICIDES

### A CHECKLIST

Suggestions for Use: Pick out the points that will be most useful to farmers in your area. Translate and illustrate them as necessary.

- . Store grain away from wet areas.
- . Protect the stored grain from falling rain.
- . Keep stored grain or grain containers out of strong sunlight. This will keep the grain cooler. Warm grain will breed more insects.
- . Place stored grain containers or buildings where winds can help cool the containers.
- . Keep the stored grain as far away from the fields as possible. This helps keep flying insect pests from flying to the stored grain from the fields.
- . MAKE SURE THE STORAGE AREA IS CLEAN. SWEEP THE WALLS, CEILINGS, AND FLOORS AND GET OUT ALL DIRT, OLD GRAIN, AND DUST BEFORE YOU PUT NEW GRAIN IN.
- . Make sure the containers for the grain are very clean.
- . Clean the grain well.
- . Dry the grain well.
- . Put only whole, healthy grains into storage. Do not store broken grains.
- . Place grain into special containers which you can seal tightly -- if possible.
- . Do not place sacks of grain near the walls. Make sure the sacks are not placed directly on the floor. Moisture from the ground will dampen the grain if the sacks are left on the floor.
- . Check your grain often.
- . Watch for flying beetles in the early morning or late afternoon.

- . Watch for moths anytime of day.
- . Shake a sack on the floor. Then let it rest out of direct sunlight for a while. Then check to see if there are any weevils on the outside of the sack.
- . Dump part of the grain out or take some out from the middle of the storage container.
- . Put the grain through a sieve.
- . If a large number of insects is present, dump all the grain out on a tray or plastic sheet under a hot sun. Do not put the grain directly on the ground.
- . Or put all the grain through a sieve and remove the insects. Burn the insects so they can not return to the grain.
- . Mix grain with sand and ash when you put it into the storage containers. Sand and ash damage the insects' bodies, and they die.
- . Store unthreshed grain on raised wooden platforms and build small smoky fires underneath. The heat and smoke from the fire help drive the insects away.
- . Plan for storing the next crop. If you continue to have trouble with insects, see if there is a storage method which might be better. Also, find someone who knows how to use insecticide and get advice on your problem.



## INSECT CONTROL WITH INSECTICIDES

Insecticides are poisons used for killing insects. But insecticides also can kill or hurt humans and animals if they are not used correctly. Use only recommended insecticides on clean, dry grain. Insecticides must always be used with care.

Most farmers know something about insecticides. But often they are not aware of exactly what insecticides should be used for or of the differences among insecticides.



Farmers may use insecticides without knowing how to apply the insecticide they are using or on what materials that insecticide can be used. Some insecticides are safer than others; some insecticides can poison grain as well as insects. The danger in insecticide use is that farmers do not have enough information about insecticides to use them correctly for their type of grain and their storage situation. For example, many farmers around the world call all insecticides, DDT. They are likely to go to market, pick up some DDT powder, and sprinkle it around.

This section of the manual presents information on insecticides in a form which should help you provide farmers in your area with the information they need to use insecticides appropriately and safely.

The use of insecticides cannot be separated from the kind of storage container and the purpose for which the grain will be used. Some insecticides can be used on grain for seed, but cannot be used on grain for food. Some insecticides can be used for treating both kinds of grain. The following is a basic discussion of types and kinds of insecticides used in grain storage work. These insecticides also are discussed in the section on storage methods.

## TYPES OF INSECTICIDES

Many different poisons kill insects. But there is a much smaller number of poisons (insecticides) which are useful in grain storage work. Some insecticides are made from parts of plants. Pyrethrum is an example of this type. Some, such as Cyanide, are inorganic chemicals; others are man-made organic chemicals such as Malathion and BHC.

The insecticides available to farmers to use for grain storage purposes are of two major types -- contact chemicals and fumigant gases. These insecticides can be bought in a number of forms (formulations); they are applied differently depending upon the type of grain and the type of storage.

Contact Chemicals. These are the contact poisons: the insect must actually get these insecticides on its body. The contact chemicals are available in the following formulations:

#### Dusts

These contain a low concentration of insecticide mixed with powder. This makes them safer to handle than some of the other formulations available. Dusts also:

- . are ready to use.
- . must be kept dry or they will not mix evenly, and the insecticide will not work as long.
- . used on floors, flat surfaces, and around the bottoms of storage containers, particularly sacks, to control crawling insects.
- . may be mixed with grain at the time of storage. Use only those dusts, for example, Malathion and Lindane, recommended for this purpose.

#### Wettable Powders (Dispersible Powders)

These contain a high concentration of insecticide. Wettable powders:

- . must be mixed with water before they can be used.
- . require careful mixing.
- . are used to spray outside surfaces of sacked grain, storage containers, or buildings.
- . are never used directly on grain.
- . can be applied with simple sprayers which can be purchased or made.

#### Emulsion Concentrates

These are liquid concentrates which:

- . must be mixed with water before they can be used.

- . contain a high amount of insecticide mixed with other ingredients.
- . need special equipment to apply.
- . are more difficult for farmers to use.

Emulsions of pyrethrum or Malathion are available, and the directions for mixing are usually given on the labels of the containers. But farmers should know of the need for special equipment to apply these, so that they do not spend their money on a formulation of insecticide which they will not be able to use.

Other Forms. These are liquid concentrates and powders which must be used with special equipment. These formulations are used with fogging machines and smoke generators; they are not appropriate for use by most farmers.

REMEMBER: It is important for the farmer to know which formulations are available in his area, which of these formulations he can use, which he should not use, and how they should be applied.

### Fumigants

The second major category of insecticides is the fumigants. Fumigants are gases. Fumigants have several advantages as an insect control method:

**DANGER!**

**FUMIGATION**

**UNDERWAY!**

- . Gas can enter all the cracks in storage buildings to kill insects hiding there.
- . Gas can get between the tightly packed grains in storage and, in most cases, can kill larval stages within the kernels.
- . Gas does not leave marks on the grain as some insecticides do.

But farmers should also know that there are problems involved in using fumigants:

- . The choice of fumigant is very important. Fumigants are extremely dangerous to man, but some are easier and safer to use than others. A fumigant must be chosen which will not leave poison in the grain and which is relatively safe for the farmer to use.

MOST FUMIGANTS ARE SAFE ONLY WHEN USED BY A SKILLED OPERATOR

- . Fumigants kill only insects which are already in the grain. They do not protect grain from new attacks.
- . Fumigants must be used in airtight containers. If the farmer is storing his grain in jute sacks, he will have to find an oil drum, or some other container which can be made airtight before he can fumigate his grain. Or he must be able to cover his grain sacks with heavy plastic and fumigate in this way.
- . Fumigation may hurt the ability of seeds to germinate.

Fumigants are available in the following forms:

*Solid Fumigants.* These fumigants are in tablet or packet or pellet form. The active chemical is Aluminum Phosphide. The tablets release Phosphine gas when moisture touches them. Fortunately, the tablets take about three hours to release enough poison gas to kill a person, so the person who follows the rules for fumigation carefully can use these tablets safely. The fumigant is sold under the trade names Phostoxin, Detia, and Celphos.



*Liquid Fumigants and Low Boiling Point Gases.* Some of these are Carbon Tetrachloride, Ethylene Dichloride, Ethylene Dibromide, and Methyl Bromide. They are all dangerous to apply and must be applied by trained people wearing full protective clothing. Do not recommend these formulations to farmers for individual use. Warn very strongly against them. They can kill people, if used incorrectly.

The number of insecticides which can be used on stored grain products is really not large. Knowledge of these insecticides is important to the farmer. And he must have enough information about the insecticide and its use so that he can use it safely.

Information on using insecticides with stored grain is included in the storage section of this manual (Section 7).

SOME CLOSING NOTES

In more and more places around the world, farmers are able to find and buy some of the newer formulations for insect control. Here are two examples of insecticides which may be useful to control flying insects in the home or farm shed, though they are of no value in stored grain.



- . Vapona Pest Strip -- This strip is hung from the ceiling. It contains the insecticide Dichlorvos, which is released slowly into the air over a period of some weeks.
- . BAYGON -- This is a trade name given to an aerosol spray formulation being seen in more and more places. This spray is handy to use and is effective for spraying storage buildings.

These formulations are not dangerous when used correctly. But they can be harmful when used without proper directions. BAYGON, for example, must not be used by a farmer to spray the flies that land on his food.

It is a good idea for you to know which formulations are available in your area and are likely to be picked up by farmers looking for insecticides. Often these formulations are brought in from other countries, and the containers are written in another language: even a farmer who can read his own language will not be able to read the instructions and warnings on the can. If you keep in touch with the insecticides that are available, you can prepare insecticide-use directions in your own language (s), or in picture language which would give uses and non-uses without words.

## Phostoxin<sup>®</sup>

FUMIGANT

The following pages contain information on some of the more important grain storage insecticides. Each insecticide is listed on a separate page so that you can remove material on those most available in your area. Perhaps you can use the information to put together a short leaflet on insecticide use to hand out to farmers. This is a good way to introduce and encourage appropriate and safe use of insecticides.

Also included here are:

- . Recommended dosages and insecticides for use with grain, on storage buildings, etc.
- . A sample of methods for applying insecticide.
- . A checklist on when to use insecticides and on how to use them safely.

- . A list of steps to take if a person is poisoned by insecticide.

## MALATHION INSECTICIDE

TRADE MARK

The appendices to this manual contain a selection of leaflets that have been used, or are being used, by development workers in various parts of the world. Perhaps they will give you ideas on how best to combine material from this manual with knowledge of your area and farmer need. Additional information about insecticides and their applications which is of interest to you, but not necessarily to the farmer, is included in Appendix C.

INSECTICIDE INFORMATION SHEET

**MALATHION**

OTHER NAMES: Malaphos, Malathon, Malphos, Cythion, Emmatos, Carbophos, Mercaptolhion

TYPE: Contact Chemical

FORMULATIONS: Emulsion Concentrate, Wettable Powder, Dust, Granules, Aerosol, Baits

WARNING: ONE OF THE SAFEST INSECTICIDES FOR MAN TO USE. DO NOT USE OR PUT IN METAL CONTAINERS SUCH AS IRON.

CONTROLS: Aphids, mites, flies, leaf hoppers, mealy bugs, Japanese beetles, corn earworms, ants, spiders and many others. Some special grain storage notes about Malathion:

- . works well against Saw-Toothed Grain Beetle, Rice and Granary Weevils.
- . does not work against the Red Flour Beetle in some areas.
- . does not control adult moths and mites as well as BHC.

USE TO: MIX WITH GRAIN. Apply as a dust to grain when it goes into storage. Use 125 grams of Premium Grade Malathion 1.0% Dust per 100kg. It should be used only with very dry grain. Malathion does not work well in wet or moldy grain.

SPRAY OR BRUSH ON BUILDINGS. It is unstable on cement or whitewashed walls.

DUST interior surfaces in contact with grain.

INSECTICIDE INFORMATION SHEET

**PYRETHRUM**

OTHER NAMES: Pyrethrum is used with piperonyl butoxide

TYPE: Contact Chemical

FORMULATIONS: Sprays and Dusts

WARNING: IT IS NOT DANGEROUS TO MAN, AND IT CAN BE USED NEAR FOOD. BUT IT CAN CAUSE ALLERGIES IN SOME PEOPLE.

CONTROLS: All grain storage insects. They are not resistant to it.

USE TO: SPRAY STORAGE AREAS. It is a good insect repellent, and controls moths.

MIX DUST DIRECTLY WITH GRAIN GOING INTO STORAGE.

NOTE: It costs a lot. Pyrethrum is a natural insecticide. It is made from the heads of a certain kind of flower. It repels insects, but its power does not last long and breaks down in oxygen, water, or light. This is why piperonyl butoxide or another stabilizer is added to the pyrethrum.



INSECTICIDE INFORMATION SHEET

**LINDANE**

OTHER NAMES: Gammexane, Isotox, Gamma, Renesan, OKO, BHC (extremely similar but not the same)

TYPE: Contact Chemical

FORMULATIONS: Dust, Wettable Powder

WARNING: NOT IMMEDIATELY DANGEROUS TO MAN, BUT, IF YOU TOUCH IT OFTEN, YOUR BODY KEEPS THE POISON INSIDE. IF YOUR BODY HOLDS TOO MUCH POISON, SICKNESS CAN RESULT. ALWAYS READ THE INSTRUCTIONS ON THE CONTAINER, AND USE LINDANE CORRECTLY.

REMEMBER:

- . DO NOT APPLY TO CROPS FOR FOOD WITHIN 30 DAYS AFTER HARVEST.
- . IT IS POISON TO FISH AND HONEY BEES.
- . DO NOT USE ON CHICKENS OR CHICKEN HOUSES.

CONTROLS: Aphids, lygus bugs, grasshoppers, roaches, mange mites, termites. It is very good against weevils which have developed resistance to BHC and against the adult stage of the Angoumois Grain Moth.

USE TO: TREAT YOUR SEED FOR PLANTING. Use 113g to 454g to treat the seed required to plant 25 acres. Store treated seed below 21°C and use within three months of treatment. Dosage should not go above 2.5 ppm on cob maize and above 5 ppm on unthreshed sorghum.

DUST on unshelled groundnuts; unthreshed sorghum, bags of maize, wheat, rice, maize in cribs.

SPRAY STORAGE AREAS.

INSECTICIDE INFORMATION SHEET

**DICHLORVOS**

OTHER NAMES: DDVP, Vapona

TYPE: Contact Chemical and Fumigant

FORMULATIONS: Spray, Pest Strip

WARNING: CAN BE DANGEROUS TO PEOPLE AND ANIMALS IF NOT  
HANDLED CORRECTLY.

HANDLE PEST STRIP WITH GLOVES.

DO NOT LET PEST STRIP TOUCH FOOD.

CONTROLS: Moths, beetles. It is very poisonous to flying moths  
in a tight building, but kills beetles more slowly.

USE TO: SPRAY STORAGE PLACES to kill flying insects. It  
does not last long.

Provide control of flying insects by hanging the  
VAPONA PEST STRIP. The strips give off poison for  
about 3 months (depending upon climate).

INSECTICIDE INFORMATION SHEET

**DDT**

OTHER NAMES: Chlorophenothene, Accotox, Anofex, Neocid, Neocidol, Pentachlorin, Sillortox.

TYPE: Contact Chemical, long-lasting.

FORMULATIONS: Emulsion Concentrate, an aerosol, granules, dusts. It is also sold mixed with other pesticides.

WARNING:

- . DDT IS NOT IMMEDIATELY DANGEROUS TO MAN. BUT SINCE THIS POISON DOES STAY ON THINGS FOR A LONG TIME, THERE IS SOME CONCERN ABOUT WHETHER DDT CAN HURT PEOPLE WHO USE IT VERY OFTEN AND FOR A LONG TIME. USE IT CAREFULLY.
- . DO NOT USE NEAR FOOD.
- . DO NOT USE TO DUST SACKS OF STORED GRAIN.
- . DO NOT USE WHEN THE TEMPERATURE IS OVER 90°F.
- . DO NOT USE ON DAIRY ANIMALS OR IN DAIRY BUILDINGS.
- . DO NOT STORE IN IRON CONTAINERS.
- . DO NOT USE TO DUST INSIDE OF GRAIN STORAGE CONTAINERS.

CONTROLS: Codling moths, flea beetles, leaf hoppers, corn earworms, corn borers, thrips, flies, mosquitoes, leaf miners, Japanese beetles, spittle bugs, and others. It works well against beetles, in some areas, but in other places beetles have developed resistance.

USE TO: PROTECT YOUR STORAGE BUILDING against insect attack. Apply the DDT either by spraying or painting it on with a brush. Repeat the treatment every six to eight weeks.

NOTE: DDT no longer works against some insects.

INSECTICIDE INFORMATION SHEET

**BHC**

OTHER NAMES: Benzene Hexachloride, hch, hoch

TYPE: Contact Chemical, lasts a long time.

FORMULATIONS: Emulsion Concentrate, Wettable Powder, Dust and Smoke. Sometimes it is sold mixed with other pesticides.

WARNING: SAFE TO USE IN THE CORRECT DOSAGES. READ DIRECTIONS CAREFULLY. NEVER USE MORE THAN THE DIRECTIONS SAY TO USE.

- . DO NOT USE ON OR NEAR CATTLE OR PLACES WHERE CATTLE LIVE.
- . DO NOT FEED TREATED FORAGE OR CROPS TO LIVESTOCK.
- . DO NOT USE ON ROOT CROPS. IN MANY FRUITS AND VEGETABLES, BHC CAUSES A FUNNY TASTE TO DEVELOP. ROOT CROPS ABSORB AND HOLD THE FLAVOR. TOO MUCH BHC CAN HURT GERMINATION, AND SEED GROWTH.
- . DO NOT STORE NEAR ANY PRODUCE THAT WILL ABSORB THE SMELL OF THE INSECTICIDE.
- . IT IS POISON TO FISH AND HONEY BEES.

CONTROLS: Grasshoppers, ticks, chiggers, aphids, lygusbugs, spittle bugs, thrips, fleabeetles, leafhoppers, armyworms, wire worms, flies, mosquitos, ants, termites, and others.

USE TO: SPRAY OR DUST THE INSIDE AND OUTSIDE OF GRAIN STORAGE BUILDINGS. Keep animals away while you are working with BHC.

MIX WITH SEED that is going to be used for planting.

INSECTICIDE INFORMATION SHEET

**DIELDRIN**

OTHER NAMES: HEOD

TYPE: Contact Insecticide.

FORMULATIONS: Emulsion Concentrate (EC), Wettable Powder (WP),  
Dust, and Granules.

WARNING: DO NOT TOUCH. IT CAN BE ABSORBED THROUGH THE SKIN.  
IT IS EXTREMELY DANGEROUS TO MAN IF NOT USED CORRECTLY.

- . DO NOT APPLY DIRECTLY TO ANIMALS OR LET ANIMALS  
EAT TREATED CROPS.
- . DO NOT DUMP EXTRA SOLUTION INTO LAKES, STREAMS,  
OR PONDS. IT WILL KILL FISH. PEOPLE WHO EAT  
THESE FISH WILL GET VERY SICK.
- . IT IS POISON TO BEES.
- . DO NOT USE TO TREAT GRAIN OR ANY PRODUCT TO  
BE USED FOR FOOD, ANIMAL FEED, OR OIL PURPOSES.

USE TO: Protect storage buildings against insect attack.

INSECTICIDE INFORMATION SHEET

**PHOSTOXIN**

OTHER NAMES: Celphos, Detia, Delicia, Phosphine

TYPE: Fumigant

FORMULATIONS: Pellets, tablets, or packets

WARNING: VERY DANGEROUS.

- . THESE TABLETS GIVE OFF A GAS WHICH CAN KILL A MAN IN A FEW MINUTES.
- . THIS INSECTICIDE MUST ONLY BE USED IN AIRTIGHT SITUATION OR CONTAINERS.
- . TALK TO SOMEONE WHO KNOWS HOW TO USE PHOSTOXIN IF YOU HAVE NOT USED THIS FUMIGANT BEFORE.

CONTROLS: Weevils, grain beetles, grain borers, flour beetles, cadelle, flour moths, grain moths and others.

USE TO: Fumigate grain in airtight conditions.  
Fumigation must continue for at least 72 hours. This poison kills the insects present in the grain, but does not protect the grain from attack again.

RECOMMENDED INSECTICIDES AND DOSAGES

FOR MIXING DIRECTLY WITH FOOD-GRAINS:

Malathion -- 120 grams of 1.0% Dust for each 200kgs of grain.

Lindane -- 120 grams of 0.1% Dust for each 200kgs of grain.

Pyrethrum -- 120 grams of 0.2% pyrethrins plus 1.0% piperonyl butoxide. Dust for each 200kg of grain.

FOR MIXING DIRECTLY WITH SEED-GRAINS:

It is possible to use more insecticide on grain to be used only for seed than can be used on grain for food. If there is any chance the grain will be used for food, use only the Malathion, Lindane, or Pyrethrum at the dosage recommended for food grain.

If the farmer is certain the grain will be used for seed, he can use:

Malathion, Lindane, or Pyrethrum -- 2 to 5 times more Dust than can be used for food grain.

DDT -- 100 grams of 3 or 5% DDT Dust for each 100kg of grain.

**IMPORTANT:** There may be other insecticides available in your area which can be used for grain-storage work. Make sure you know what these insecticides are and how to use them.

RECOMMENDED INSECTICIDES AND DOSAGES (Continued)

FOR SPRAYING STORAGE BUILDINGS:

Note before spraying:

- . Always clean the building before spraying.
- . Dispersible Powders (DP) are better than Emulsion Concentrates (EC) for spraying on cement, brick, stone, or whitewashed surfaces.

Malathion -- Mix 400 grams of 25% DP or 200 milliliters of 50% EC in 5 liters of water.

Lindane ---- Mix 200 grams of 50% DP or 500 milliliters of 20% EC in 5 liters of water.

DDT ----- Is sometimes used to spray buildings. It must never be used directly on food.

Lindane/DDT- Mix 100 grams of Lindane 50% DP and 200 grams of DDT 50% DP in 5 liters of water.

OR

Mix 250cc of Lindane 20% EC and 400cc of DDT 25% EC in 5 liters of water.

All of these dosages will spray 100 sq.m. If a larger area must be sprayed, mix more insecticide. Reapply the spray as needed.

**IMPORTANT:** There may be other insecticides available in your area which can be used for grain-storage work. Make sure you know what these insecticides are and how to use them.



### APPLYING INSECTICIDES

This type of applicator can be made from any kind of container with a lid which comes off and on. If using it for liquids, punch tiny holes in the lid. If using to apply insecticide dusts, make the holes somewhat larger.

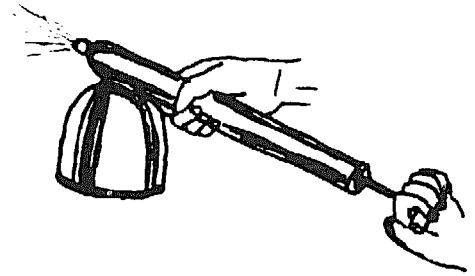
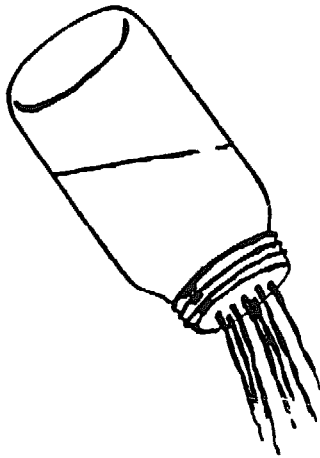

TWO TYPES OF HAND-HELD SPRAYERS

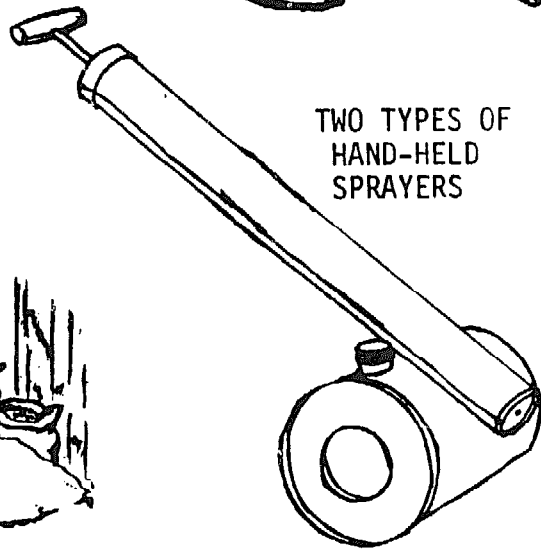

Using a Sack To Dust Insecticide

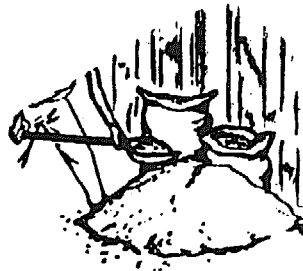

MIXING GRAIN AND INSECTICIDE WITH A SHOVEL

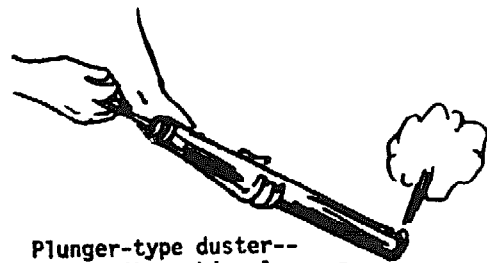

Plunger-type duster-- looks like a bicycle pump

A compressed air sprayer with plunger handpump

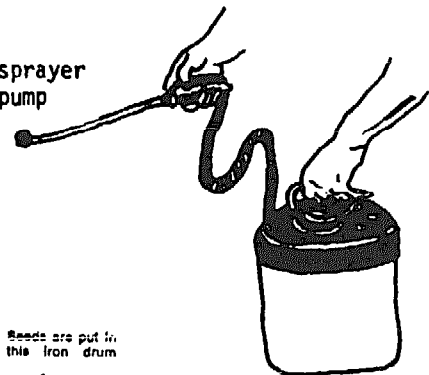

Door for filling and emptying the drum

Seeds are put in this iron drum

A DRUM FOR MIXING GRAIN AND INSECTICIDE

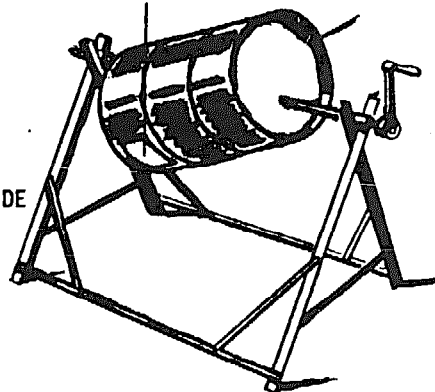

NOTE TO DEVELOPMENT WORKERS ON APPLYING INSECTICIDES

Many farmers in your area will have trouble following directions for measuring correct dosages of insecticides. This is true because the directions often require exact weight measures.

Therefore, it is a good idea for you to figure out a simple measure which farmers can use for their storage containers. For example:

- . 1-1/2 matchboxes of insecticide for each standard-size area basket granary
- . 1 empty sardine can of insecticide for each metal bin.

These are only examples, of course. You should figure out the dosage depending upon the kind of insecticide, the types of measures (matchboxes, tin cans, etc.) farmers are likely to have, and on the kinds of storage container most used in your area.

## CONTROLLING INSECTS BY USING INSECTICIDE

### A CHECKLIST

**Suggestions for Use:** Pick out the points that will be most useful to farmers in your area. Translate and illustrate them as necessary. Add the names and dosages of those insecticides most likely to be used by farmers in the area.

Insecticides are poisons used for killing insects. There are many types of insecticides. Some insecticides can be added directly to grain; others may be sprayed around grain storage areas or on the outside of the containers, but should never be placed directly on the grain. Some insecticides are liquids; some insecticides are powders. Some insecticides are gases which you use by adding them to the grain, sealing the container up tight, and letting the fumes of the poison gas kill the insects in the grain.

Never use an insecticide until you are sure you know how it should be used and all the rules for applying it.

Insecticides are not magic. They should be used with clean, dry grain in good storage conditions if they are to work well.

To use insecticides effectively for storage, you should:

- . Find out which insecticide to use for each purpose.
- . Know how to use and handle insecticides properly.
- . Have good storage buildings and containers.
- . Spray the walls of the storage building to kill insects hiding in cracks in the ceiling and floor.
- . Dust the storage containers in and out with the appropriate insecticide.
- . Mix insecticide into the grain before putting the grain into storage. To do this, you can put the grain in a pile in a place protected from wind. Add the right insect poison from a tin can with holes punched in the top. Turn the grain over and over with a shovel to mix the poison with the grain. **IMPORTANT: BE CAREFUL TO USE THE CORRECT INSECTICIDE. IF YOU ARE NOT CERTAIN IT IS CORRECT, ASK YOUR EXTENSION AGENT.**
- . Check the grain after it has been in storage for some time. You may have to add more insecticide. Poisons only remain dangerous to insects for a period of time.

To use insecticides safely you must:

- . Read the directions on insecticide containers carefully. It will give you correct ways to use the insecticide and tell you what to do in case of an accident.
- . Make sure the mixture is correct for its purpose. Using a wrong insecticide can poison the grain.
- . Do not use more than the recommended dose.
- . Wear rubber gloves when using insecticide.
- . Wash your hands with a lot of running water after you use insecticide. Do this right away if your hands touch the poison.
- . Take off any clothing that has touched the poison.
- . Do not eat, drink, or smoke while you are using poison.
- . Label poison containers so that you know what is inside.
- . Keep containers away from children and animals.
- . Bury or burn all empty insecticide containers.

HELPING SOMEONE WHO HAS BEEN POISONED BY  
INSECTICIDE

- |    |           |          |
|----|-----------|----------|
| 1. | HEADACHE  | WEAKNESS |
|    | NAUSEA    | SWEATING |
|    | DIZZINESS | VOMITING |

These are signs of poisoning.

2. IF: The person feels sick while using an insecticide or soon afterward
- THEN: Get the poisoned person to the doctor as soon as possible.
- Find the insecticide container or label so the doctor will know which insecticide poisoned the person.
3. IF: The person swallowed a poison
- and if
- he is awake
- and
- he can't see a doctor right away
- THEN: Mix a tablespoonful of salt in a glass of warm water and make the victim vomit. Or stick your finger down the person's throat. Make him vomit!
- Make the victim lie down. Keep him warm, and do not let him move until you can get him to the doctor.
4. IF: The person spilled a insecticide concentrate or oil solution on his skin or clothing, get the clothing off and wash the skin with soap and plenty of water.
- THEN: Get him to the doctor as soon as possible.

Insects -70-

5. IF: The person is overcome by breathing the gases of a fumigant.

THEN: ACT QUICKLY!

- . Get the victim outdoors or to a room free of gas.
- . Lay victim on the ground.
- . Give artificial respiration if needed.

Call a doctor as soon as you can. People using fumigants should have kits which contain treatment for poisoning by the fumigant which is being used.

IMPORTANT: ALWAYS TRY TO GET THE VICTIM TO A DOCTOR QUICKLY.

ALWAYS HAVE THE INSECTICIDE CONTAINER READY TO SHOW THE DOCTOR. TREATMENT OFTEN DEPENDS UPON THE TYPE OF INSECTICIDE THAT POISONED THE PERSON.

## ENEMIES OF STORED GRAIN PART 2: RODENTS

Rodents in many countries are healthy enough to provide a meat source for humans. In many cases, this is because they feed so well on the farmers' grain.

Rodents damage crops in the fields and in storage. They can eat a lot of grain. They make the stored grain dirty while they are eating it. They damage buildings, storage containers, and many other things on the farm.

Rodents also carry diseases which people can catch from eating and handling grains the rodents have contaminated (made dirty).

There are many kinds of rodents, but rats and mice do the most damage to stored grain.

### STORED GRAIN RODENTS

The type of rat and mouse may differ depending upon the country or the area. But, in many parts of the world, there are three important rodents which can be found moving from house to fields to storage looking for food, water, and good living conditions. These three are:

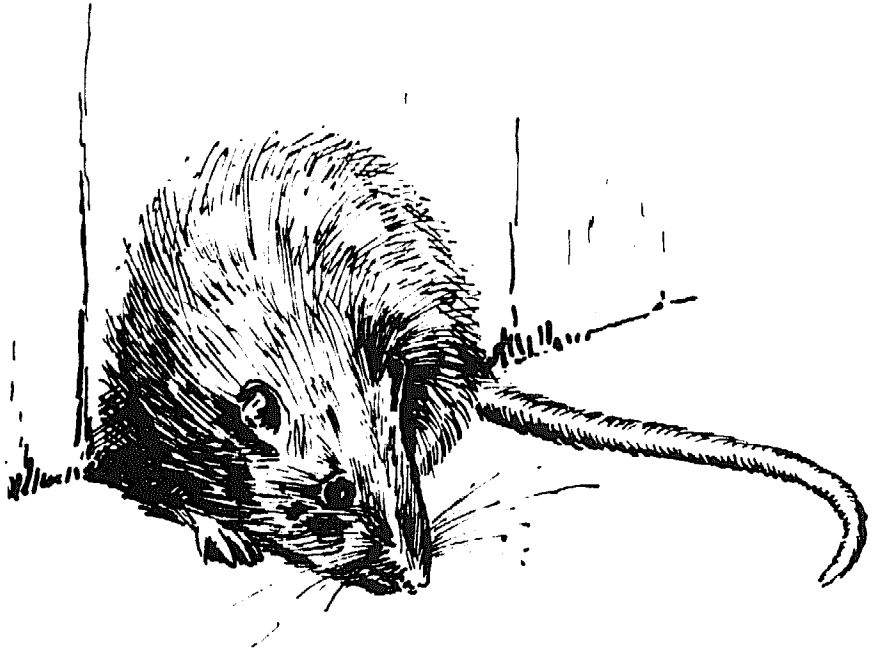

#### Rattus Norvegicus

Also called Sewer Rat, Norway Rat, Common Rat, or Brown Rat. This is the largest of the three. The adult rat weighs about 330 grams and is very strong. It actively looks for grain in the field and in storage. It also burrows into and near farm buildings. Called a brown rat, it may also be black. It has a blunt nose.

Rattus Rattus

Also called Roof Rat, Ship Rat, Black Rat, or Alexandrine Rat. This rat weighs about 250 grams when fully grown. It has a long tail and a pointed nose. These rats can be brown, grey, black, or light brown. These rats like to climb more than they like to dig. They can climb outer walls of concrete, perpendicular pipes, wires, and trees. In many areas, Rattus Rattus is the most dangerous stored grain rodent.

Mus Musculus

This is the well-known house mouse. It weighs only 16 grams. It has a long tail and pointed nose. Mice are usually brown-grey in color. Most farmers are so used to seeing mice around that they may not be aware of the damage mice can cause until the mice have multiplied into great numbers. Mice eat a lot of grain. Also, because they usually eat only part of the whole grain, mice ruin even more grain than they eat.

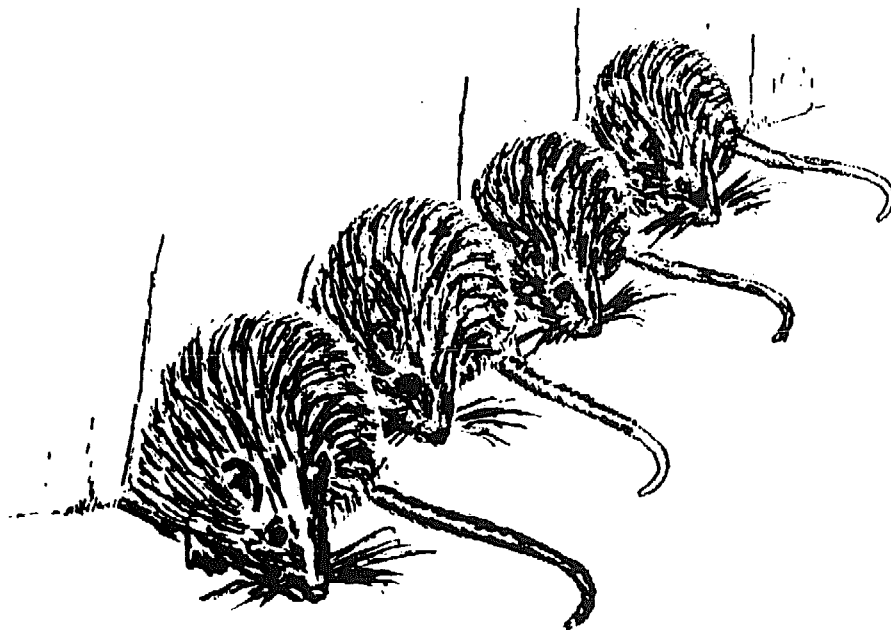

Rats and mice have big families. Most of the young rodents die before they are grown. But the adults reproduce so quickly that it does not take long for rats and mice to become a big problem for a farmer.



HABITS AND CHARACTERISTICS OF STORED GRAIN RODENTS

Fortunately, if the farmer understands how rats and mice live, and if he knows what rodents will and will not do, there are many things he can do to fight rodents. Here are some important things to know about rodents:

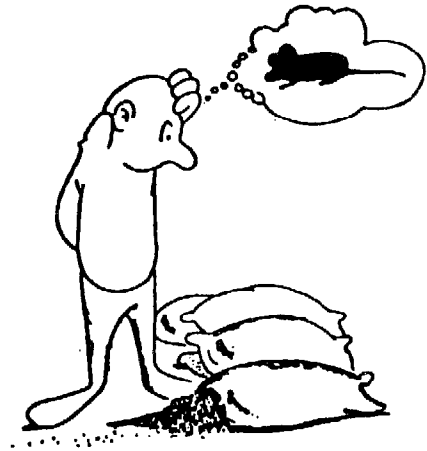

- . Rats and mice usually do the same things every day at the same time. They are most active from sunset until about midnight. They also move around at certain other hours during the day and night. If grain is stored in a dark, cool place, they will go in at any time of day.
- . Rodents always go the same way. When a rodent is going from his nest to eat grain from storage, he always goes by the same path. He chooses his paths so that he will be running beside walls or stacks. He remains behind things (out of sight) as much as possible. If the food is out in an open space, the rodent runs out, grabs it, and runs back to his path.
- . Rodents stay away from new things. If a farmer places food on a rodent path, some rodents will not eat it because it was not there before. After it has been there for some time, and the rodent is used to seeing it, he will eat it.
- . Rodents can climb. Rats and mice can climb any straight up-and-down surface on which they can find places for their toenails. Vines, drainpipes, and wires are good runways for rats and mice. Rats can reach about 32cm up a wall and can do a standing jump of almost 60cm. They can do a running jump as high as 90cm. Even a mouse can do a running jump of 60cm.
- . Rodents can swim. They are not afraid of water. They look for drains under water. Piping systems underground are often travelled by rats.
- . Some rats can dig. Rats and mice live close to food and water. The roof rat likes to nest in ceilings, but the Norway rat digs

under the ground. Rats dig down along a wall. If something blocks the digging, they stop. They do not go around the thing which is in the way.

- . Rodents must use their teeth. The front teeth grow until the rodent dies. The teeth will grow 10-12cm a year. Rats must gnaw things all the time to keep wearing their teeth down.
- . Rodents like some foods more than others. Some of the foods they like are meat, grain, eggs, and potatoes.
- . Rodents use their body hairs and whiskers to touch with. They do not see as well as humans do, and they cannot see colors. They hear very well. They can smell other rats; they can recognize certain rats by smelling the pathways and burrows.
- . Rats and mice always can be found near man. There have been large programs to kill rats and get them out of certain areas. But the rats always return. It is not likely that a farmer will be able to free his farm of rats completely. But he can and should control the numbers of rats and mice that live on his farm and eat his grain.

#### FINDING RODENTS ON THE FARM

A farmer must know where rats are before he can fight them. And there are things a farmer can look for which will tell him where rodents are living and show him their pathways and homes.

#### Holes, Nests, and Burrows

Rodent holes are usually found outside houses and buildings. These holes also appear inside in soft foundations or earth floors. To see if a hole is being used all the time, the farmer can block it lightly with a piece of earth. If the earth has been moved, the farmer will know the hole is being used. Holes in use are free of dust and spider webs. They look used.

Mouse holes (2.5cm in diameter) are smaller than rat holes (7.5cm) and also are found inside and outside.

Rodent nests also can be found outside and inside. Outside, nests are often made of grass or leaves and are located near garbage and rubbish piles. Inside, nests are made of paper, dry hay, straw, shredded cloth, and so on.

Norway rats like to live in the ground. Their burrows (underground nests) can be found along the outside walls of buildings and in dirt basements. Some of the burrows are away from buildings in brush, bushes, and piles of dirt. Often these burrows are joined under the ground.

### Runways and Smears

Rodents use the same paths. So, after a number of days of using the same path outside, rats make trails in the grass. Search for these paths in areas where the running rat would feel most protected. On dirt, the runway may appear as a clean-swept path 5.7.5cm wide.

Sometimes a runway which is used often is marked by a greasy smear from the oil and the dirt that rats and mice have on their bodies. Check for these smears around gnawed holes, along pipes, on edges of stairs, along walls or other places a rodent might run.

Mouse runways are harder to find because they are smaller.

### Footprints and Tail Marks

These are found when rodents have been running over dusty or wet places. Some farmers will find tracks on the surface of grain sacks. Rat tracks are large: the back foot of the Norway rat can leave a print 37mm long. Mouse footprints are much smaller and harder to find.

### Droppings



NORWAY RAT



ROOF RAT



HOUSE  
MOUSE

Each kind of rodent drops a different shape of feces from his body. The farmer should check for droppings near runways, holes, corners, food, and other places he feels rodents would go.

New droppings often are shiny and wet-looking. The color is usually black, but changes depending upon what the animal eats. The number of the droppings can give some idea of how many rodents are eating the grain. It is wise for the farmer to think in terms of more rodents than droppings. Some droppings may be eaten by insects, and some rodents will run by without leaving droppings.

Damage and Gnaw Marks

Rats and mice must use their teeth all the time. The farmer should check for gnaw marks on his buildings and produce. Also, if he stores in sacks, he must check the center of his sacked storage.



Smell

Rats and mice leave a smell in the room and in the grain. It is a very obvious sign that rodents are present.

CONTROLLING RODENTS WITHOUT USING POISON

Rats and mice need food, water, and places to hide. Rodents usually choose to live where these things are available close together. They do not like to travel far from home to find food and water. They like to live beneath wooden floors near chicken houses, barns, granaries, corn-cribs. They live in piles of wood, lumber, and trash, and in straw hay. Rodents need room to grow undisturbed.

Farmers who use their knowledge of rodents' habits and characteristics can fight rodents by not giving them food, water, and places to live. Keeping cats and dogs to chase and kill rodents will help, but not enough.

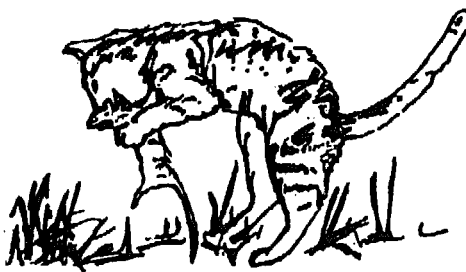

KEEP A CAT OR DOG.

The three most important things farmers can do to control rats and mice without using poison are to keep the stored grain area clean; to rodent-proof houses, storage bins, and sheds so that rodents cannot get into them; and to set out traps.

Keep the Farm and Storage Area as Clean as Possible

- . Do not pile food or trash around the outside or inside of farm buildings.
- . Bury or burn all garbage and old food away from the house or storage place.
- . Place all food items in covered containers.
- . Store grain sacks off the floor.
- . Sweep out all dirt, dust, straw, old cloth that rodents might nest and hide in.
- . Cover dirt floors with a thin layer of mortar, if possible. This keeps rats from digging up through the floors.
- . Keep the grass cut short around all farm buildings. Rodents like to hide in tall grasses.
- . Cut any tree limbs which touch windows to keep rats from climbing the trees and jumping in through the windows.



CLEAN GRAIN STORAGE AREAS

Rodent-Proofing

This simply means the farmer must store his grain so that the rats and mice either cannot get in or have to work very hard to do so.

- . Construct granaries of mud. Farmers in some areas have found these are not attacked by rodents too much, especially when they are built off the ground. In other words, storing grain above the ground helps keep rodents away.
- . Place cribs for grain storage, such as the one described in this manual, at least 75cm above the ground -- because rats can jump. Put barriers on the legs of the cribs so that the rodents can not climb the legs. These barriers are called rat baffles or rat guards. Baffles can be made from tin cans. The instructions for making these baffles are on a separate page at the end of this section.

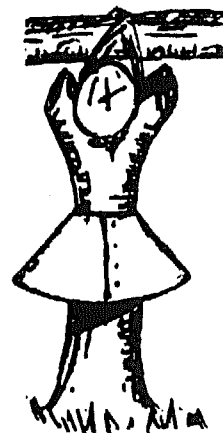

RAT  
BAFFLES

- . Never place a bicycle or other piece of equipment against storage places. Rodents use such items as ladders to climb into the stored grain.
- . Build storage buildings or containers on a concrete base at least 50cm high. The floor should be concrete. If the bin is made of tin sheet, the sheet should be fixed in concrete. Farmers should place sheet metal bands around mud or cement silos to prevent rodents from climbing. Some mudblock constructions use fired bricks at the bottom levels because rodents cannot gnaw through them.

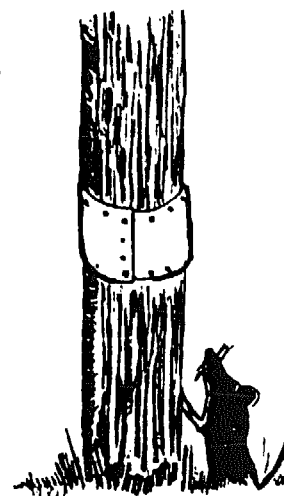

- . Make sure doors and grain chutes fit tightly. A wooden door should have a thick metal sheet along the bottom to stop rodents from eating through. Grain chutes sometimes are packed with mud.
- . Cover all windows and large openings with heavy wire netting. Wire netting with an 8mm mesh is a good size. Holes in a roof made of corrugated tin should be filled with cement mortar.
- . Cover the ends of any pipes which enter the building where grain is stored with wire netting.

### Setting Traps for Rats and Mice

Traps can be very effective if correctly placed and used. They need to be regularly maintained. They may be used where poison is hard to get. Also, traps are much safer to use very near stored grains in houses and storage buildings. Rodents run out, get food, and carry it back to where they are going to eat it. They walk over the poison and pick it up on their feet and bodies. Then they walk over grain or food and so put poison on it. So, for a small farmer whose grain is not well-covered, traps may be a better way to fight rodents.

Farmers in many parts of the world already use traps of different kinds. One method is to hang a maize cob over a five-gallon tin of water. The maize cob swings freely. When the rat reaches for it, he loses his balance, falls into the water and drowns.

This trap works if the number of rodents is not too great. A small-scale farmer can easily put several water traps around his storage area.

The best traps consist of a base, a spring, and trigger and heavy wire. The heavy wire is bent back and held by a spring. The spring is released when a rodent steps on the trigger. The wire snaps down on the rodent. These traps can be made, but it usually requires too much time to make enough traps.

On the other hand, traps can be expensive if a farmer needs many of them. The number of traps he needs depends upon whether he is seeking to control rodents in his grain fields, in his storage area, in his home, or in all these places. He can protect his grain best by controlling rodents at all these points. So a farmer has to figure the number and kind of traps he needs. There are a number of kinds available:

Snap Traps (Also Called Wood Traps or Breakback Traps). These have a flat wooden base. They kill with a heavy wire which is pulled back by a spring. When a rat or mouse touches the trigger, the wire comes down over the rat, breaking its back.

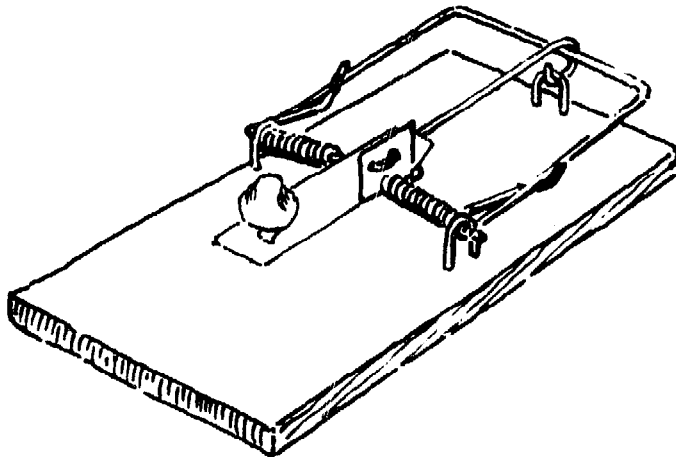

Snap traps come in a number of sizes. The trap for a rat should be about 9 x 22cm. The traps for mice need to be only 5 x 10cm. Some farmers place pieces of food (bait) in these traps to attract mice and rats.

Putting food in the traps is not necessary if the farmer places the trap in a rat runway.

Steel Traps. These traps have a base with a trigger and two steel jaws. When a rat steps on the platform and releases the trigger, the jaws snap together. A steel trap with 9cm jaws is good for rats. The problem with steel traps is that rats usually do not die, but are caught. This means the farmer must kill the rat himself.



Tunnel, Box, and Cage Traps. These do not use bait. They are placed in runways and other places where the rats and mice go. Only rats and mice can enter these traps. And they cannot get out.

After the farmer has an idea of how many of which traps he needs, he must figure the cost of traps. Points he should consider:

- . Buying the traps requires money. How much would it cost to buy all the traps?
- . Traps can be used over again.
- . Traps can be repaired and do not have to be replaced often.
- . It takes time to bait, set, empty, and re-set traps. And this must be done often, especially if the trap has food in it. Rodents do not like old or moldy food. Doing all this takes a lot of time.
- . How much would it cost to put poison out instead of traps? Are the right poisons available? Putting out poison requires making special boxes to hold the poison, buying the poison, setting it out, etc. Would it be cheaper to use poison? Would it be easier?
- . If there are a lot of rodents to control, would it be cheaper for the farmer to use a combination of traps and poison? Traps could be placed in areas, such as the house, where poisons are not a good idea. Poison could be used in the fields and other areas where rodents are appearing in great numbers. After many rats are poisoned, traps can be set to provide continuing control.

If traps are to be part of the farmer's rodent control program, there are certain things he must know about traps:



### Size and Condition of the Trap

- . Mice can take the food from a rat trap without getting caught. It is important to place mouse-size traps where there are signs of mice and rat-size traps where rats are running.
- . Snap traps can be used without bait if the platform or base is made larger so that the rat releases the trigger by simply stepping on the platform.

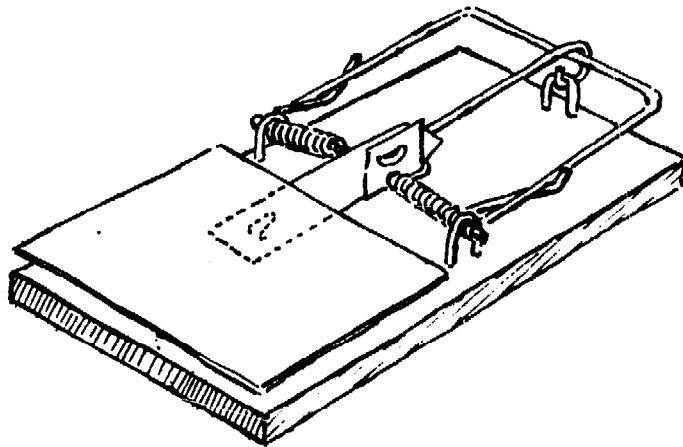

Make the trap bigger by fastening a 4cm-square piece of thin metal, screen, or cardboard to the trigger of the bait holder.

- . Traps should be kept clean, so they will work well.
- . If a lot of bait is being taken, and rats and mice are not being caught, the trap probably needs fixing. Check for bent or rusted triggers, weak springs, or loose wires.

### Baiting the Traps

Snap traps often are used with bait to encourage the rat to come to the trap.

- . Bait may be any food rats like to eat.
- . Use a piece of food about the size of the end of a man's finger.
- . Make sure the bait is fastened down very well. If the bait is not held down well, the rat will steal the bait and run away.

- . Food baits should be changed every three days. Rats do not like old food. Change from one kind of bait to another.

### Placing the Traps



Here is where the knowledge of rodent habits becomes very useful. Farmers will usually catch most rodents the first night. Therefore, put out enough traps. Not every trap will catch a rat; the farmer should expect this. The farmer should:

- . Place baited traps very near the rodent runways he has found.
- . Place traps near the walls at right angles to the wall. The trigger end should be nearest the wall so that the trap will attract a rodent running from either direction.
- . Cover the traps with straw, dust, or other material which hides all of the trap except for the bait. This is done only when there is no danger that people and animals will step on the trap.
- . Set the base of the trap right into the floor if the floor is dirt.
- . Place baited traps near holes, nests, and burrows. If the area is one where people or animals are likely to go, the farmer should put a cover over the trap so that it will be available to nothing but rats and mice.
- . Place unbaited traps or expanded-trigger traps right in the rodent runways. Boards or boxes can be placed beside and behind the traps to guide rodents into them. Traps are also placed in burrows, hole openings, and corners. For roof rats and mice, also place traps on shelves, beams, pipes, and other high places

Many farmers will decide that the best control program for them will use all of the methods discussed above, plus poison, to kill the rodents.

## CONTROLLING RATS WITH POISON

Using poisons to control rodents is cheap, in most places, and effective.

BUT RODENTICIDES (POISONS WHICH KILL RATS AND MICE) CAN POISON HUMANS AND OTHER ANIMALS AS WELL. IT IS VERY IMPORTANT, THEREFORE, THAT FARMERS KNOW WHICH POISONS TO USE AND HOW TO USE THEM.

There are two kinds of poison used for killing rodents: acute poisons and anticoagulant poisons.

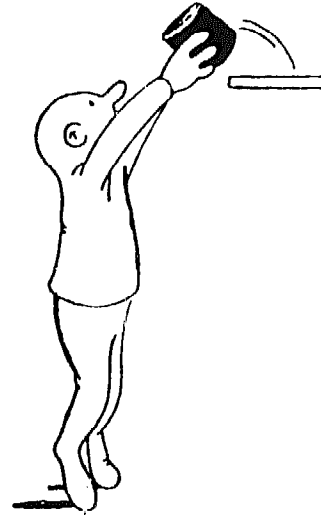

### Acute Poisons

These are also called single-dose poisons. Rodents need to eat only a few mouthfuls of this poison. Death occurs quickly -- usually within a half hour.

The most common of the acute poisons are zinc phosphide, arsenious oxide, and sodium fluoroacetate (also called 1080). Some tropical countries are also using thallium sulphate, yellow phosphorous, aluminum phosphide, calcium cyanide, strychnine, Norbomide, Eastrix, and Antu. Some of these are only good for mice, some for rats. This manual discusses only some of the most common poisons effective against grain storage rodents. If one of the other poisons mentioned is being made available to farmers in your area, you might prepare information sheets on the proper use of that poison -- such as the ones attached to the end of this section.

### Anticoagulant Poisons

These poisons must be eaten by rodents for a number of days before death occurs. They are used at a low dosage. In other words, there is only a little mixed in with the food each day. These poisons cause rodents to bleed inside their bodies and die.



The best known anticoagulant poison is Warfarin. Others are Coumatetralyl (Racumin), Chlorophacinone, Pival, Fumarin, PMP, Diphacinone, Rodafarin (India).

### Choosing a Poison

The kind of rodent is important when choosing a poison. What kills one kind of rat may not kill another kind. The farmer should be able to recognize which types of rodent are attacking his stored grain. There are some poisons which can kill a number of types. Each of the major ones mentioned in this manual will control Norway rats, roof rats, and mice.

The farmer has to decide whether to use an acute poison or an anti-coagulant. Acute poisons kill more rodents and kill them quickly. But many of the rodents will not feed. And these rodents will not eat the poison bait that killed the other rodents if the bait is left in the same places. Acute poisons are also more dangerous for farmers to use.



Anticoagulants are added to food and the rat must eat the food for about 5 days at a time. These poisons have no taste and no smell. The rodents do not know they are being poisoned, and this is an advantage. They continue to eat the poisoned food. It takes a lot of poison, a lot of bait, and a lot of time to use anticoagulants well. This may be a disadvantage for some farmers. But anticoagulants are much safer for farmers to use. And safety is an important factor to weigh when using poison.

### Preparing Bait

Poison is mixed with foods rodents like (bait). The bait and poison mixture must look good to rodents so that they will eat the poisoned bait instead of the stored grain.



A cereal bait often is used. Cereals for bait must be kept free of insects. The cereal should be in fine- or medium-size pieces. Warfarin is usually used at 0.005% to 0.05% (the amount of Warfarin contained in the bait mixture). Above 0.05% the rats can taste the poison and will not eat the bait.

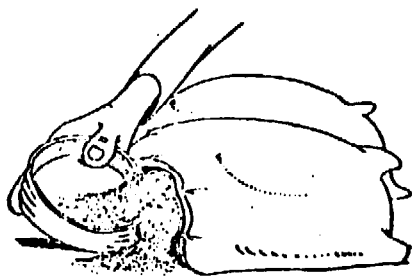

Anticoagulant poisons are often sold in master mix form. This master mix includes an ingredient which helps the poison mix in better with the bait.

Here are directions for mixing baits:

Dry Anticoagulant Baits. To make 10kgs of Warfarin or Coumatetralyl ready-to-use bait:

- . Mix 9.5kg of dry ground meal (19 parts by weight) of oats, wheat, or any cereal grain with 0.5kg of master mix (1 part by weight).

Oily Anticoagulant Baits. These baits are used instead of dry baits in wet places, and in places where the bait will stay for some time. The cereal does not have to be as fine as for dry bait. Rats like the bait when it has sugar, molasses, or some sweet food in it.

- . Mix (by weight):
  - 17 parts cereal
  - 1 part sugar
  - 1 part Warfarin Master Mix
- . Stir well, so all dry ingredients are mixed.
- . Add one part (by weight) oil -- liquid paraffin or white oil.
- . Stir until the bait is evenly mixed.
- . This makes a total mixture of 19 parts of bait (cereal, sugar, and oil) to 1 part of poison. If rodents still prefer to eat the stored grain, change from oily bait to damp bait.

Damp Bait. Rodents like damp baits, but these baits dry out quickly. Damp baits are usually used with acute poisons. There are several ways of making damp bait:

1. *Wet Cereal.* Soak cereal grains overnight (wheat, sorghum, etc.) in water. Drain the water off just before use. Add correct amount of poison. The directions for the amount of poison are given on the containers. IF THERE ARE NO DIRECTIONS FOR USE, DO NOT USE THE POISON.
2. *Damp, Coarse Cereal.* Soak (by weight) 2 parts cereal in 1 part water for 1 hour. Stir several times. Add poison and use.
3. *Bread Mash.* Soak old bread in water. Drain off extra water. Pound wet bread to a paste. Mix in poison and use.

Liquid Bait. These are useful in dry situations. Rats living in stored grain areas have to go looking for water. Other sources of water should be removed as much as possible. Liquid baits then are placed as drinking water.



Liquid baits are simply poisons dissolved in water. They may be acute or anticoagulant types of poison. Sodium fluoroacetate, Warfarin, and Pival all are used in making liquid baits.

Liquid baits, however, lose their power in two or three days in warm weather.

### Placing Baits

There must be plenty of bait stations. Bait must be placed in runways, near holes, burrows, and nests. Farmers should remember when placing bait that rodents stay close to home. Rats usually travel in an area of about 45m<sup>2</sup> and mice stay within a 9m<sup>2</sup> area.

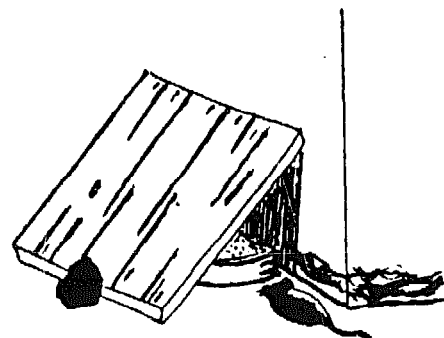

Placing Acute Poisons. Here is one method:

- . Prepare 10cm x 10cm square papers, banana leaves, or like material.
- . Place poisoned food in the middle at one end.

- . Roll up the paper and twist the ends.
- . One pound of bait makes 80 or 90 doses.
- . Throw the paper packets into places where it is impossible to place traps -- into holes and burrows, between walls, etc.

NEVER PLACE THESE PACKETS WHERE CHILDREN AND PETS CAN GET THEM.

Another method of placing bait:

- . Cover the floor with small pieces or teaspoonsful of bait containing an acute poison.
- . Collect and destroy the bait after 24 hours. Do not recommend this method to farmers who do not have separate grain storage buildings: it is far too dangerous to leave poison bait sitting around on the floors and grounds belonging to a small farmer.

Placing Anticoagulant Poisons. These poisons are probably the best ones for you to recommend to farmers. They must be used carefully. But they are relatively easy to use.

It is important to keep enough bait out for a long enough period of time. Keep bait out at least two weeks. Each pile of bait should be 200-250cm, and each should be laid in the places where signs of rodents have been found.

- . Place the bait in empty shallow tins, on ends cut off from tin cans, in pipes and pieces of bamboo. The bait can be placed directly on the ground, but it may get wet and moldy.

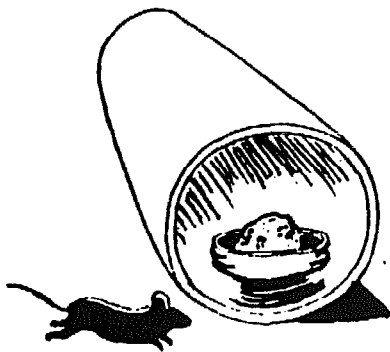

JAR LIDS



- . Construct bait boxes and use them and boards, pipes, or cans in certain places to hide the bait from other animals to keep baits from getting wet.
- . Put the bait in places where signs of rodents have been found.
- . Check the bait stations every day to make sure there is enough bait.
- . Smooth the bait so that next time he checks he will be able to see signs of feeding.
- . Change moldy or insect-infested baits for new ones.
- . Move the bait station to another place if the bait is not being eaten.

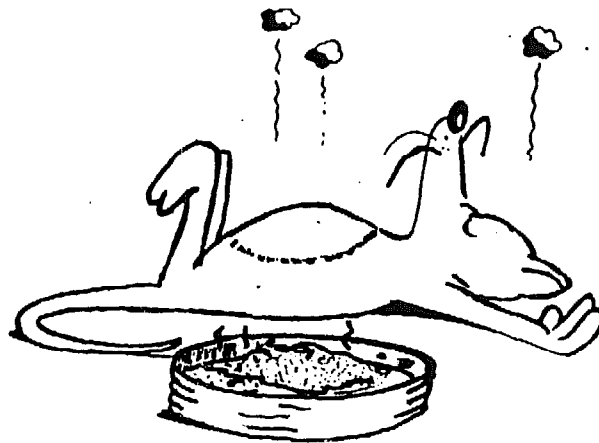
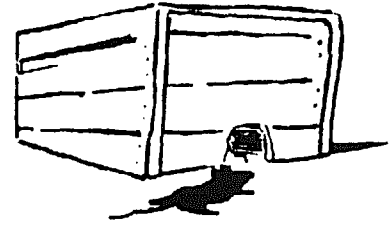

Other materials on rodent control follow:

- . Information sheets on major rodent poisons. Use these as guides to preparing materials for use with rodenticides available in your area.
- . Instruction sheet for making rat baffles.
- . Scripts for a series of illustrated leaflets on rat control, including an example of how an artist can turn these scripts into very effective information through use of illustrations.

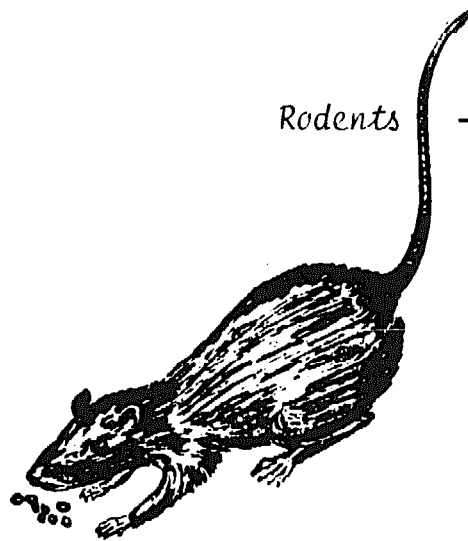

**WARFARIN**

TYPE: Anticoagulant rat poison.

- FORMULATIONS:
- . Ready-to-use bait.
  - . Powder concentrate. The total of Warfarin in the concentrate is only 0.5% of the whole. Mix 1 part of the powder concentrate to 19 parts of bait. This gives a bait which contains 0.025% Warfarin.
  - . Powders to dissolve in water. This makes a liquid for use as poisoned drinking water or making making wet bait.
  - . Dusts. These contain 1% Warfarin. This can be sprinkled on surfaces where rats run.
  - . Wax rat blocks. These are blocks of wheat held together by wax. The poison is mixed in the wheat. The block is placed where rats will nibble at it.

These formulations are easy to use. But they should be used with great care.

WARNING: ALL POISONS ARE DANGEROUS!!

- . Follow directions for use given on the poison container.
- . Do not eat, drink, or smoke when using poison. Wash your hands very well after using poison.
- . Put poison containers away out of the reach of children.

NOTE: If someone swallows Warfarin, make him vomit. To make someone vomit -- stick your fingers down his throat or make him drink warm water with salt in it. Vomiting empties the stomach. Get the poisoned person to a doctor as soon as you can.

## COUMATETRALYL

- OTHER NAMES: Racumin
- TYPE: Anticoagulant rat poison.
- FORMULATION:
- . Ready-to-use bait (0.05%).
  - . Mix containing 0.75%. Dilute 1 part mix to 19 parts of bait. Final concentrate 0.37%.
  - . Dust (0.75%). Place on surfaces where rats run.
- USES: Use as you would use Warfarin.
- WARNING: ALL POISONS ARE DANGEROUS.
- . If you are not sure which poison to use, ask someone who knows how to use poisons correctly.
  - . Read all directions carefully.
  - . Do not eat, drink, or smoke when handling poison.

KEEP AWAY FROM CHILDREN



WASH YOUR HANDS



# CHLOROPHACINONE

OTHER NAMES:

TYPE: Anticoagulant poison.

FORMULATION:

- . Ready-to-use bait (0.005%).
- . Mix in oil (0.25%). Dilute 1 part to 49 parts of bait. Concentrate should be (0.005%).
- . Dusts. These contain 2% Chlorophacinone. These can be sprinkled into holes and runways used by rats. Dusts should be sprinkled for 20 days.

WARNING: ALL POISONS ARE DANGEROUS.

- . If you are not sure which poison to use, ask someone who knows how to use poisons correctly.
- . Read all directions carefully.
- . Do not eat, drink, or smoke while using poisons.
- . Never use these formulations near food.

KEEP AWAY FROM CHILDREN

WASH YOUR HANDS AFTER  
USING POISON

## SODIUM MONOFLUOROACETATE

- OTHER NAMES: Compound 1080
- TYPE: Acute Rat Poison
- FORMULATIONS: Must be used as a liquid. When using the liquid, you must obey all the safety rules for handling poison.
- WARNING: VERY DANGEROUS TO MAN. THERE IS NO ANTIDOTE TO THIS POISON.
- . Men and animals can be killed or made sick by eating rats that have eaten this poison. The powder form causes immediate death in humans who breathe it. NEVER EVEN OPEN A CONTAINER OF THE POWDER.
  - . Do not get the poison on you clothes or your body. If you do, wash with a lot of running water.
  - . Keep it away from other people and animals.
  - . Burn or bury all the tools and containers used to mix and hold the poison.
  - . USE RUBBER GLOVES AND WASH YOUR HANDS CAREFULLY AFTER MIXING THE POISON.

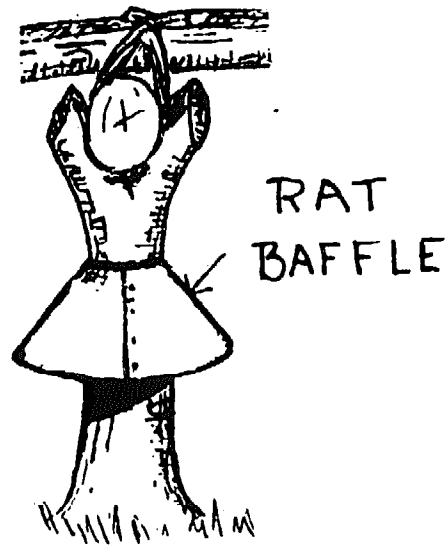
RAT BAFFLESMaterials and Equipment

- \* 1 flat tin sheet (30 gauge, 0.9 x 2m)
- 1 pair tin shears or sharp chisel
- 1 hammer

Chalk, charcoal, or large nail for drawing baffles on tin sheet.

25, 4-6cm nails (You will need 5 nails for each baffle)

Baffles should be about 50cm in diameter at the narrow end. The size will vary with the size of the leg which the baffle must fit.

- . Mark out baffles on tin sheet with chalk or charcoal before cutting them out.
- . Cut out along the outside edges. Do not cut the middle yet.
- . Start with the thinnest leg first. Cut out the hole in the middle of the baffle little by little. The baffle must fit tightly to keep even the smallest rodent from climbing between the baffle and the leg. If the hole in the baffle gets too big for this leg, use it on a fatter leg.
- . Nail the baffle tightly to a wooden leg. Use cement mortar to fasten the baffle to a concrete leg.
- . Cut out and fit all the baffles in the same way.
- . Make wooden legs round, if they are not round already. Cut the middle hole of the baffle to fit a concrete leg which is not round.

NOTE: You can use whatever thin metal is available. Old tin cans can be cut and flattened.

Below is a pattern for a rat guard to be cut from a piece of tin or a flattened tin can. This piece is cut out and bent to form a cone with a hole in the center. It is fastened around the leg of the crib or storage building and attached to the leg with nails or wire.

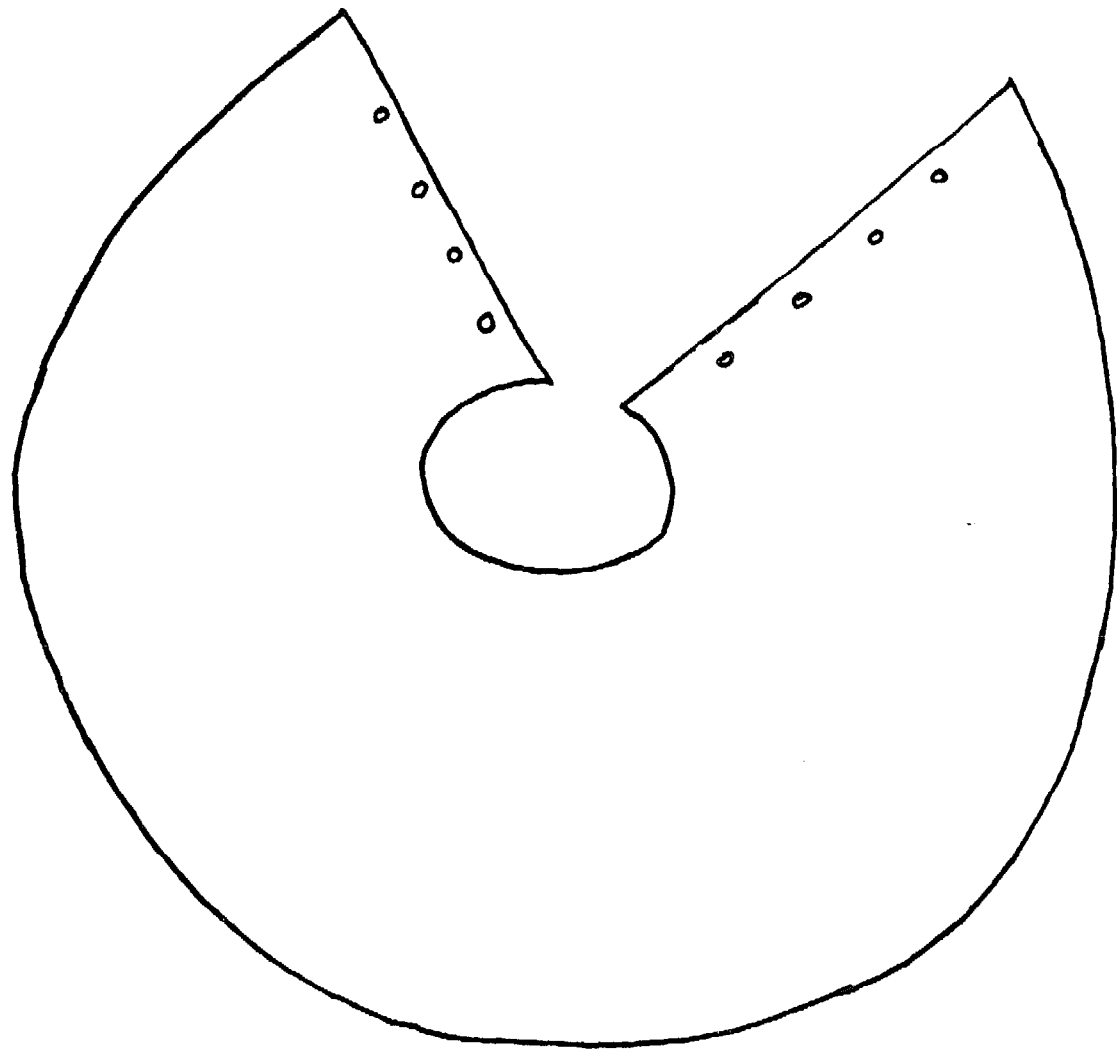

## RAT CONTROL SERIES

SUGGESTED USES: This series of scripts is a short version of the material in the rodent section. The scripts could be used as part of a campaign to alert farmers to the damage rodents do, and to the steps which can be taken to control rodents.

The scripts have been prepared in some detail; you can choose the points which best fit the situation in your area. The points can be translated and pictured quite easily. The illustrated material which follows these scripts shows how VITA artist, Kenneth Lloyd, has used pictures to explain many facts about rodents.

### SCRIPT # 1

#### RODENTS ARE EVERYWHERE

- . Rats live in your houses.
- . Rats live in your fields.
- . Rats eat holes in your buildings.
- . Rats eat food in your houses.
- . Rats eat grain in your storage places.
- . Rats make your food and grain dirty. They put droppings from their bodies on the grain while they are eating it.
- . Rats bring sickness. They can bring diseases which make people die. They can even kill sleeping babies.
- . Rats like to live in storage places.
- . Rats eat a lot of your grain everyday. There is less grain for you to sell and eat.
- . You must keep rats out of your fields. You must keep rats out of your house. You must keep rats out of your stored grain.
- . Your extension worker can tell you how to keep rats away from your farm.
- . Remember: Rats bring sickness to you and your family.  
Rats steal food and grain.  
Rats make your grain dirty.

Rat Control Series

SCRIPT # 2

KNOW ABOUT RATS

- . You must know what rats can do before you can fight them.
- . Rats move fast. They are fast and quiet.
- . Rats have sharp teeth. They can make holes in wooden walls and trees.
- . Rats can climb and jump.
- . Rats can crawl on ropes and wires.
- . Rats can swim. They are not afraid of water.
- . Rats are smart. They can stay away from traps.
- . Rats have large families. One pair of rats can make a family of more than 1,000 rats in a year.
- . Rats build nests in quiet, dark places. They make nests using straw, feathers, paper, and other pieces of trash.
- . Rats hide around homes and storage places. Rats like to live near food.
- . Some rats live under the ground. They like to live near grain growing in the field.
- . Rats like to eat at night. Rats move around at night.
- . Rats use the same road every time they make a trip.
- . Rats find many places to hide on a farm. You must look carefully to find them.
- . Look for nests.
- . Look for trails. Rats pack down the plants in places because they always use the same road.
- . Look for droppings. New droppings are shiny and black. Old droppings are gray.



*Rodents -102-*

- . Look for chewed holes in wooden walls.
- . Look for dirty, greasy marks at the bottom of walls and doors.
- . Listen at night. Sometimes you can hear rats moving in the roof, cooking place, or grain storage place.
- . Now you know where the rats are. Now you can get the rats away.
- . Your extension worker can give you information on how to get rats away from your farm.

Rat Control Series

SCRIPT # 3

FIGHTING RATS WITHOUT POISON

- . Rats must have food and water to live.
- . Rats like dirty places.
- . Keep your home and grain storage places CLEAN.
- . Make sure rats do not get food.
- . Put old food into a covered container if you want to use it later. Do not leave food on tables or shelves.
- . Feed old food to the pigs and chickens right away.
- . Bury garbage. Or burn garbage.
- . Clean around the outside of buildings. Do not leave piles of garbage, rags, paper, leaves, and cans. Rats like to hide in these things.
- . Keep grass cut short.
- . Cut tree branches that grow near your home and grain storage area. Remember rats can jump. They can jump from the tree to the building.
- . Make sure rats cannot get under the door of your home or storage area.
- . Put strips of metal along the bottom of doors. Rats cannot bite through metal.
- . Close all holes in wooden buildings with metal sheets or flattened tin cans.
- . Fill holes in plaster, brick, or mud walls.
- . Use rock or concrete floors. Rats can come up through the ground into the storage area.
- . Store grain in covered containers. Place containers off the ground.
- . Put metal bands around the bottom or legs of grain containers. This keeps rats from climbing up to the top.

*Rodents* -104-

- . Keep a cat or dog. Train the animal to chase and kill rats.
- . You may have to use rat poison also. Contact your extension worker. Do not use poison before you talk to the extension worker. POISON IS DANGEROUS.

Rat Control Series

SCRIPT # 4

FIGHTING RATS WITH POISON

- . Clean your grain storage areas.
- . Close and rat-proof all holes in buildings.
- . Protect the storage containers and building with metal.
- . This stops new rats from coming in.
- . Use poison and traps to kill any rats that are left.
- . Talk to your extension worker before you use poison. The extension agent will know which poison to use. He will know how to use the poison. He will know where you can get the poison.
- . Remember that some rat poisons can kill other animals and people.
- . One poison kills rats quickly. You can kill many rats at one time.
- . Soon rats will not eat this poison. They know this poison kills.
- . Then you can use another kind of poison. Rats must eat this poison for 3 days or so before they die. Rats do not know they are dying. So they will keep eating the poison.
- . Some poison is already mixed with food rats like to eat.
- . Food that rats like to eat is called bait. Bait can be rice, corn meal, bread.
- . You can mix this bait with poison yourself. Ask your extension worker how much poison to mix with the bait.
- . Add some corn oil, coconut oil, sugar or molasses to the bait and poison. Rats like the taste very much.
- . Try not to touch the poison. Wash your hands when you finish mixing.
- . Now make boxes and containers to put the bait in. These boxes and containers let the rats in. Other animals and children can not get into these boxes and containers.

- . There are different kinds of bait boxes and containers.
- . You can put bait in pipes made of bamboo or metal.
- . Put bait in tin cans.
- . Put bait in small dishes made out of bamboo or tin cans. Put dishes inside the bait boxes or bait containers.
- . Put bait containers close to walls and doorways in your storage area.
- . Put poison containers near places where rats run.
- . Make bait containers to put in your fields.
- . Put these containers near trails and rat holes.
- . Poison field rats before the grain is ready. Rats will not eat poison if they can eat grain.
- . Check all bait containers very often. The poison bait must not get too old. Rats will not eat old bait.
- . Remember: Check with your extension agent for help with poison.  
Read the words on the poison box or jar.  
Wash your hands after you mix the bait with poison.  
Keep all poison away from food, animals, and people.

Rat Control Series

SCRIPT # 5

FIGHTING RATS WITH TRAPS

- . Your extension worker can tell you which traps to use. He can tell you how to use them.
- . It is good to use traps in places where children might go. Poison is too dangerous.
- . Show your family where you are putting the traps.
- . Show your family how the traps work. Traps can hurt people.
- . You must put food that rats like in the trap. Try different kinds until you find a good bait. Try pieces of meat, dried fish, bread.
- . Put traps near food places. Put traps on top of stored grain. Do not use rat poison in these places.
- . Tie the traps down. Sometimes rats run away with traps. The traps just catch the rats' noses.
- . Put traps near rat trails, rat footprints, rat holes.
- . Move the traps around every few days.
- . Check the traps every day. Make sure the bait is still there.
- . Do not touch dead rats. Rats carry disease and sickness.
- . Use a stick or shovel to get the rat out of the trap.
- . Burn dead rats.
- . Wash traps before using them again. Wash your hands.
- . Remember: Ask your extension worker about traps and how to use them. Traps can hurt people and animals. Use them carefully. Do not let children play with traps. Use traps near food and grain. Never use poison in these places.

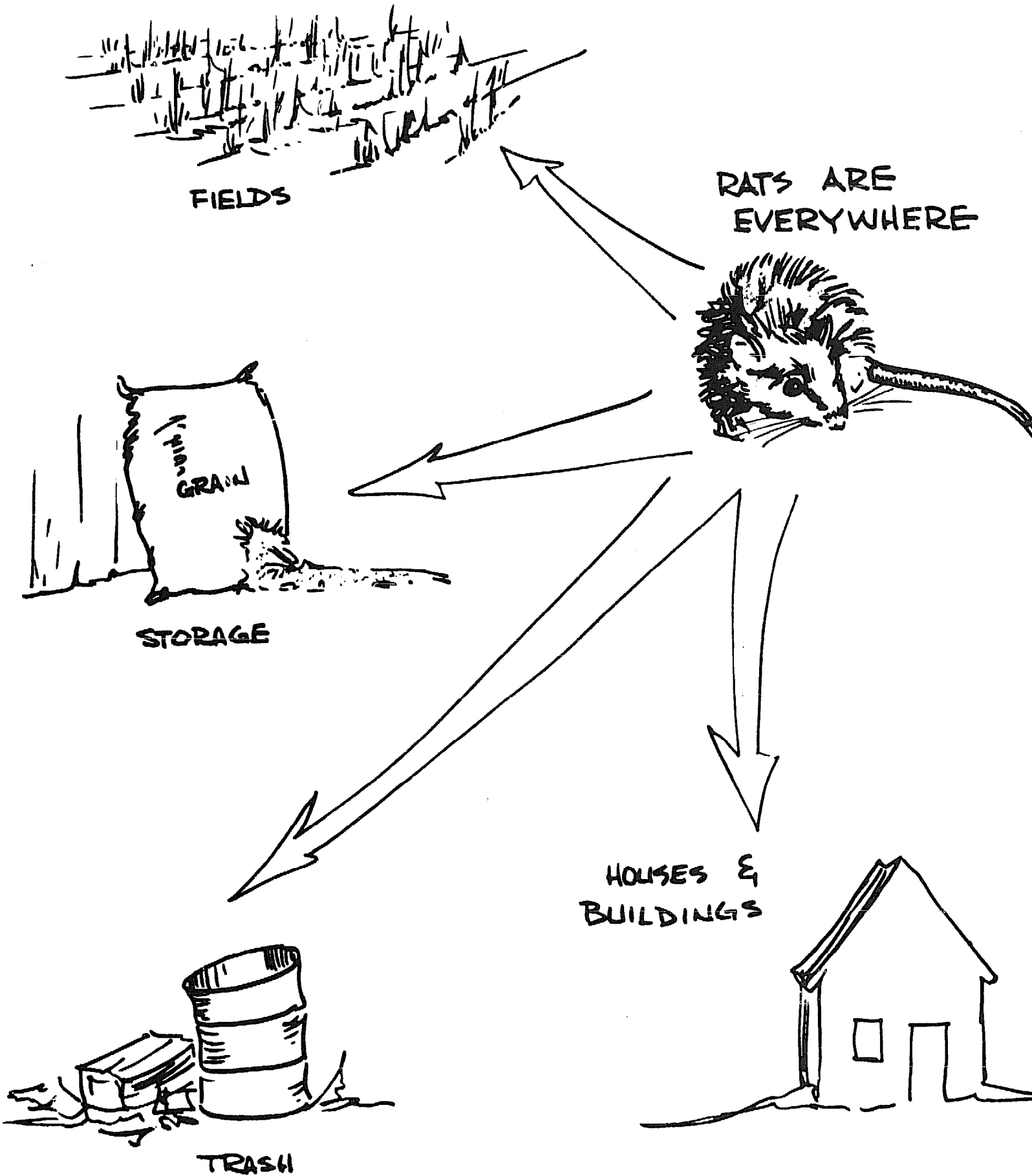

- Illustrations by VITA Volunteer Ken Lloyd

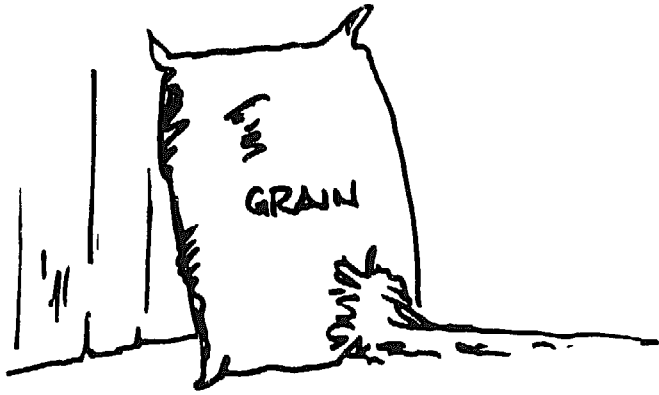

EAT GRAIN  
AND FOOD



KILL CHICKENS  
EAT EGGS

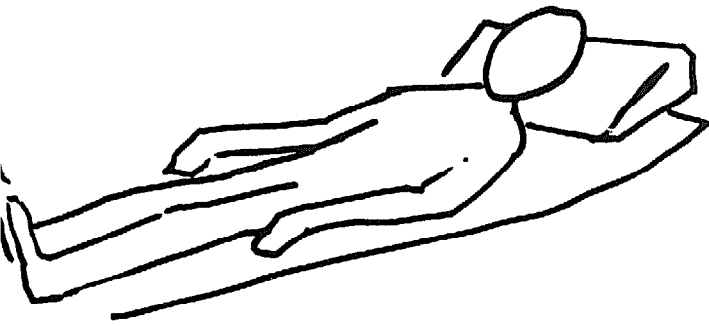

CARRY DISEASE

WHAT RATS  
DO

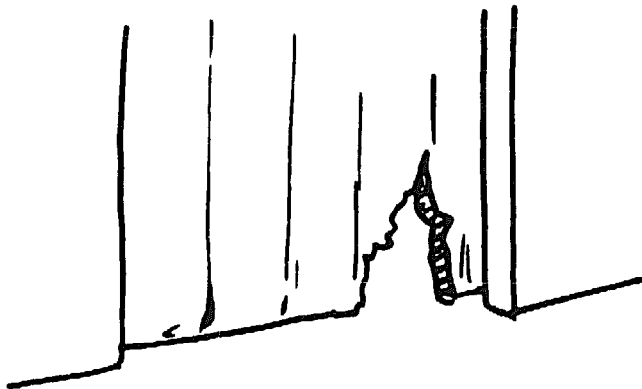

DAMAGE BUILDINGS,  
HOMES AND STORAGE  
AREAS.





CLIMB ROPE

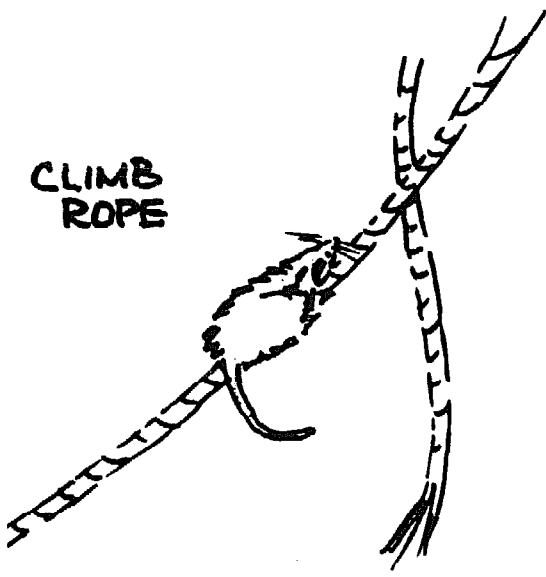

RUN FAST

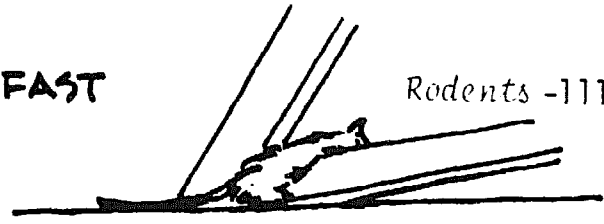

CLIMB

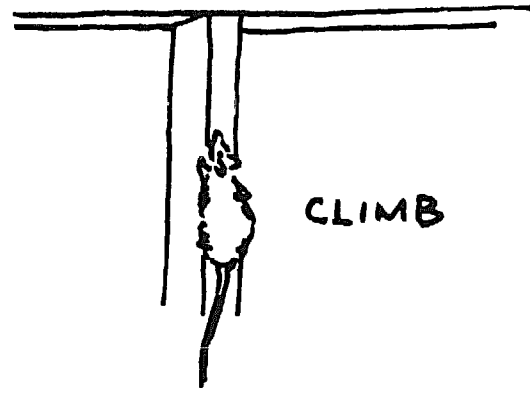

JUMP

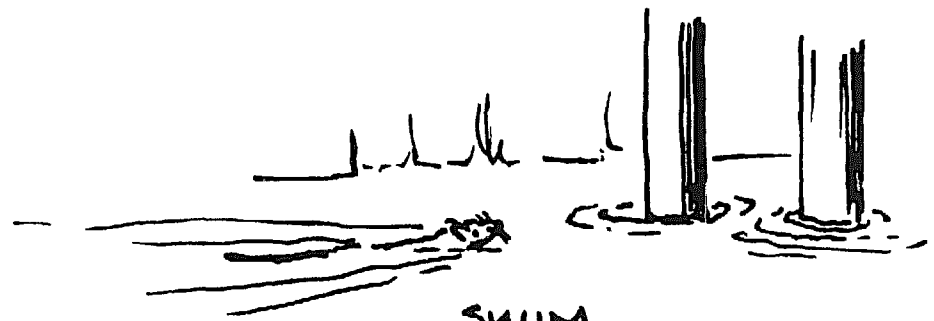

SWIM

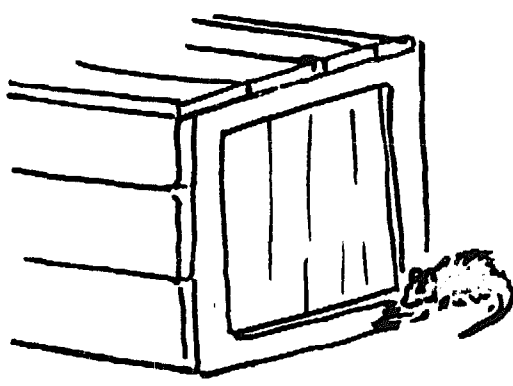

MAKE HOLES IN WOODEN BOXES, WALLS, TREES

THINGS RATS CAN DO —

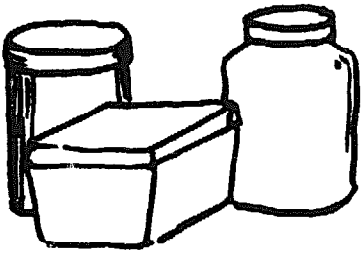

COVER FOOD TO  
BE USED LATER

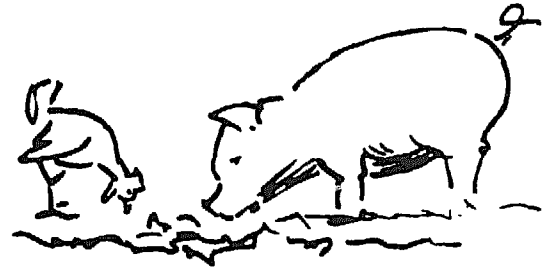

FEED OLD FOOD TO  
PIGS AND CHICKENS

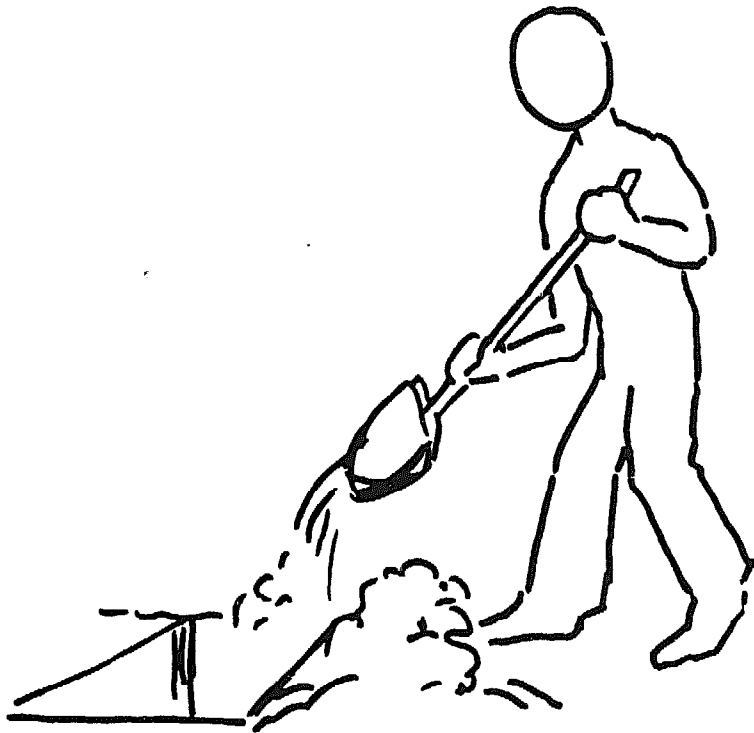

BURY OR BURN GARBAGE

BE CAREFUL WITH FOOD AND GARBAGE

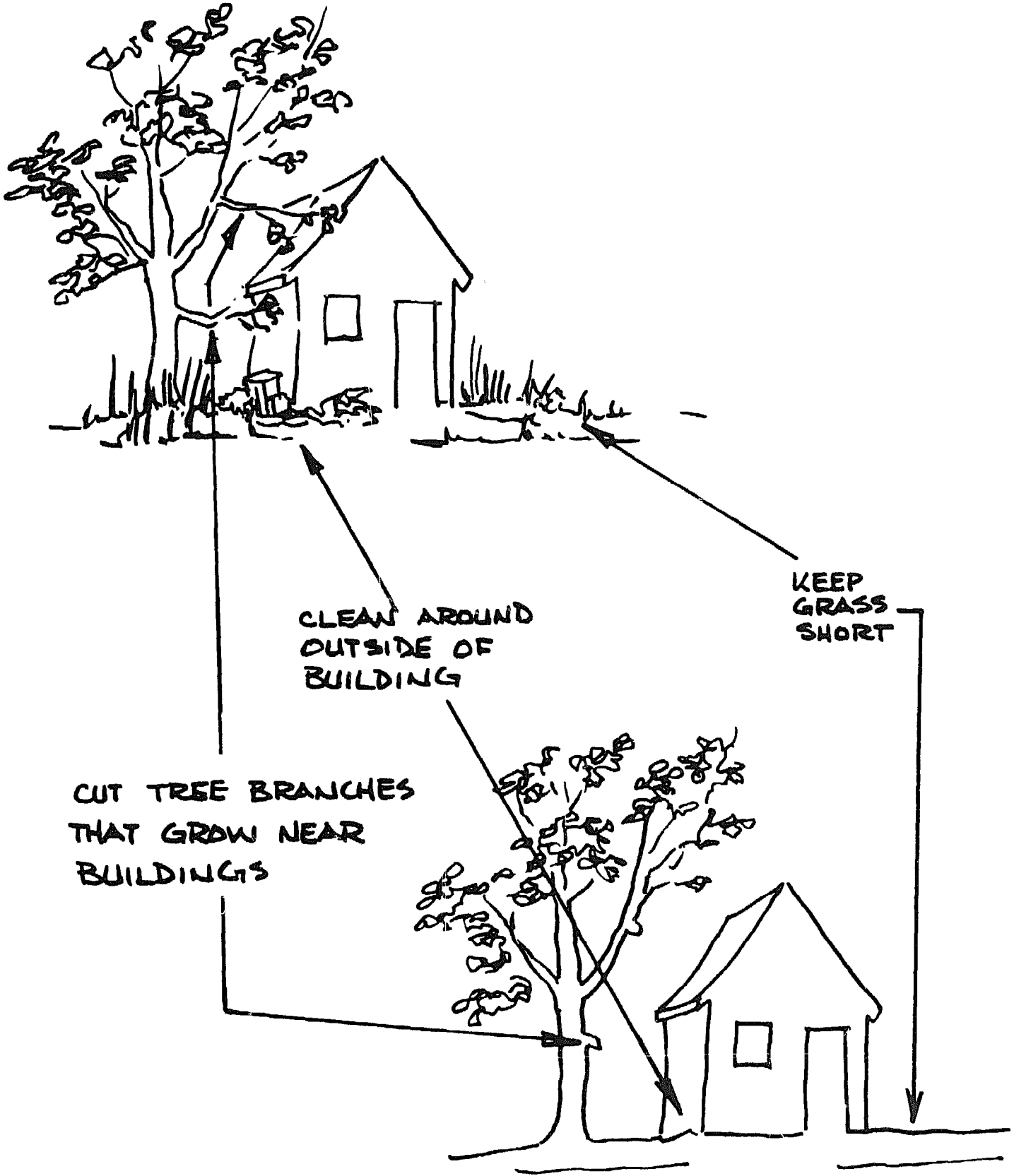

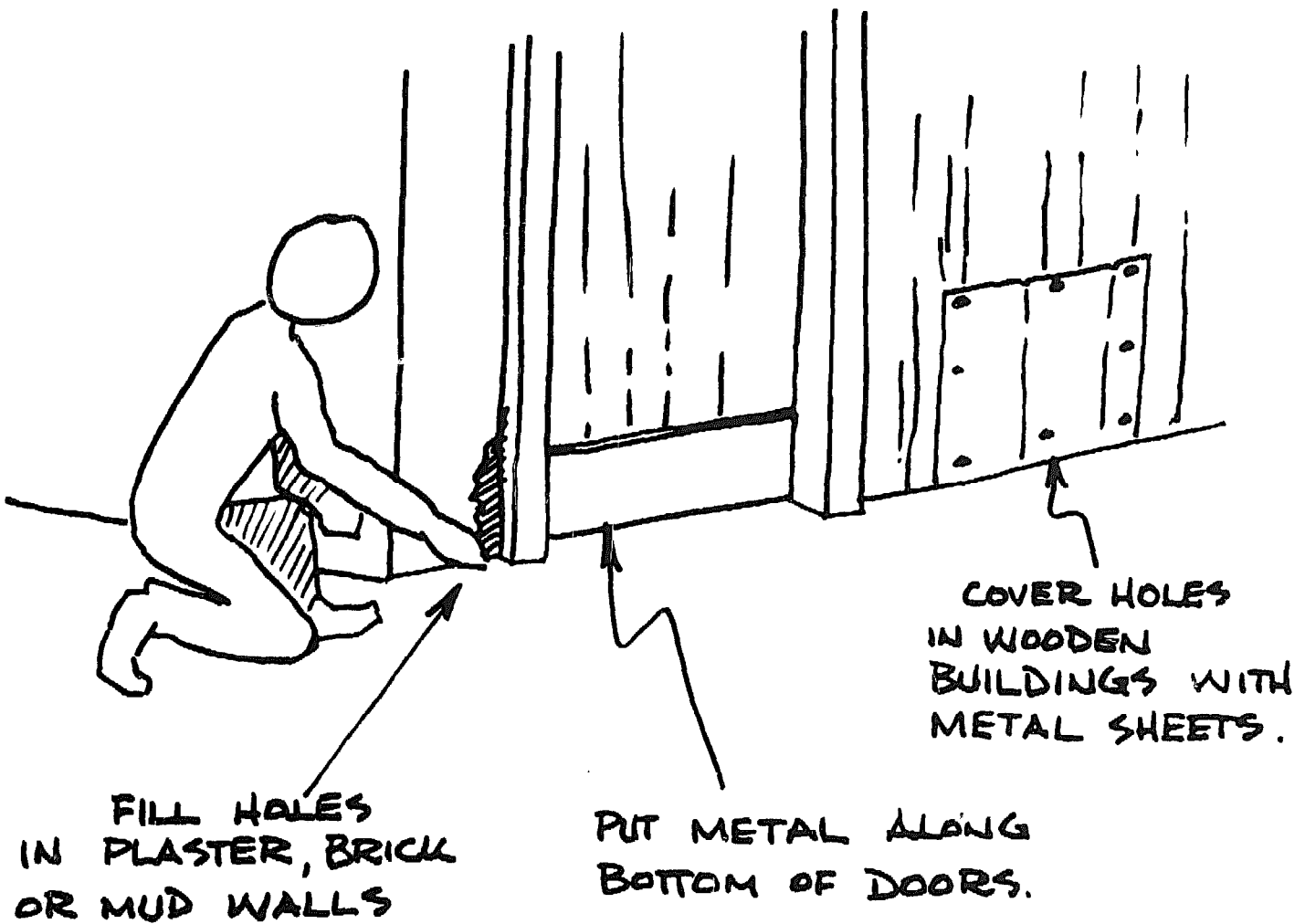

FILL HOLES  
IN PLASTER, BRICK  
OR MUD WALLS

PUT METAL ALONG  
BOTTOM OF DOORS.

COVER HOLES  
IN WOODEN  
BUILDINGS WITH  
METAL SHEETS.

# RODENT - PROOFING

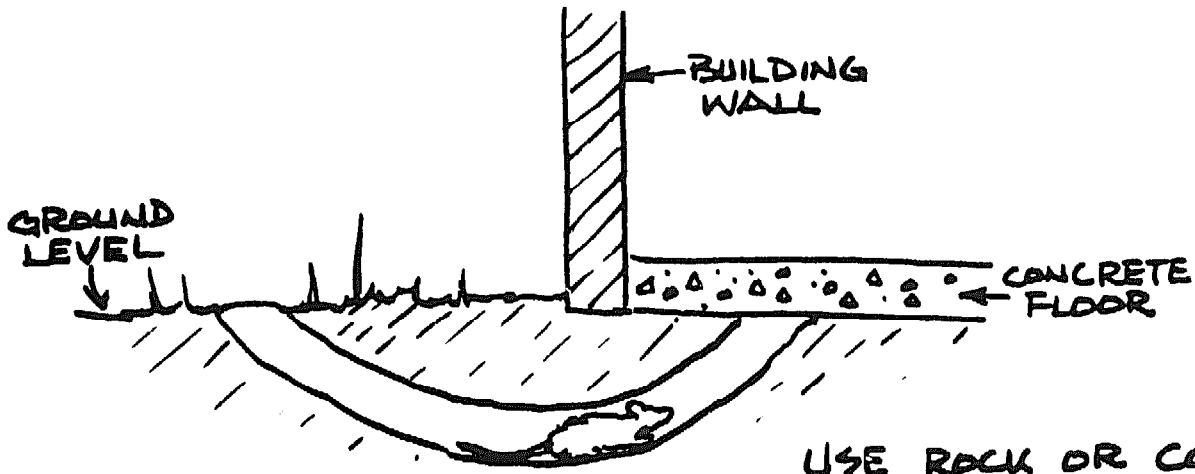

USE ROCK OR CONCRETE FLOORS

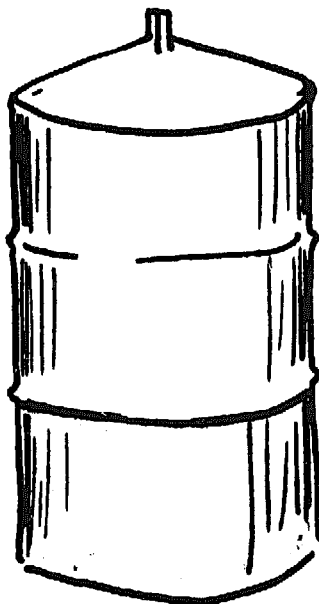

METAL BAND  
IF CONTAINER  
IS NOT METAL

30  
CM

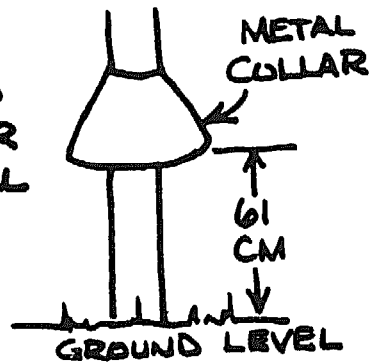

METAL  
COLLAR

61  
CM

GROUND  
LEVEL

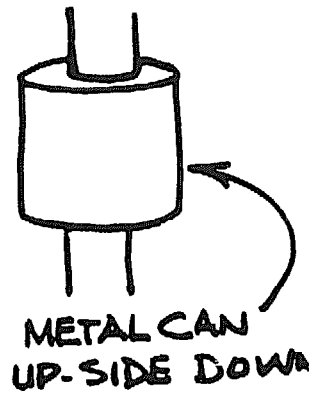

METAL CAN  
UP-SIDE DOWN

STORE GRAIN IN  
COVERED  
CONTAINERS.  
(PLACE CONTAINERS  
OFF THE GROUND)

PUT METAL BANDS  
AROUND THE BOTTOM  
OR LEGS OF GRAIN  
CONTAINERS.

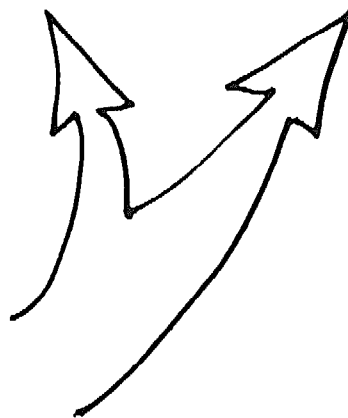

METAL  
AROUND  
POST

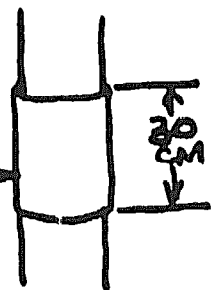

30  
CM

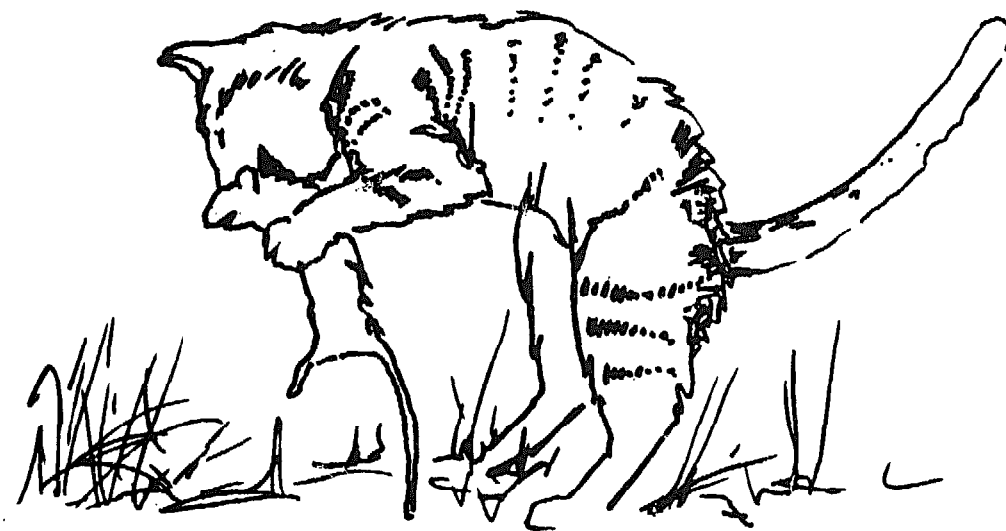

KEEP A CAT OR DOG.



CLEAN GRAIN STORAGE  
AREAS

MIXING

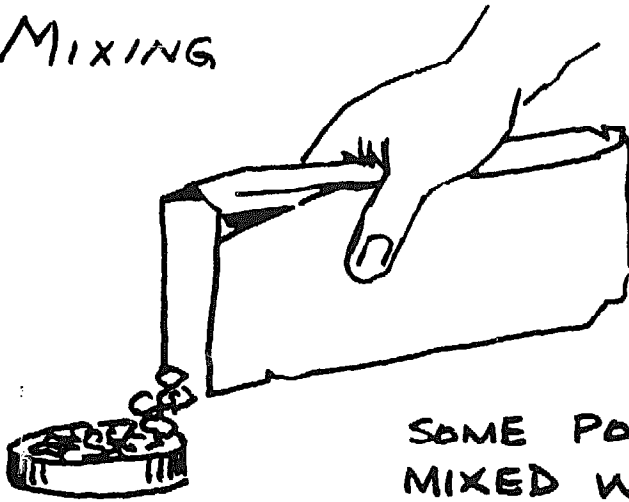

POISON

SOME POISONS COME MIXED WITH A BAIT.

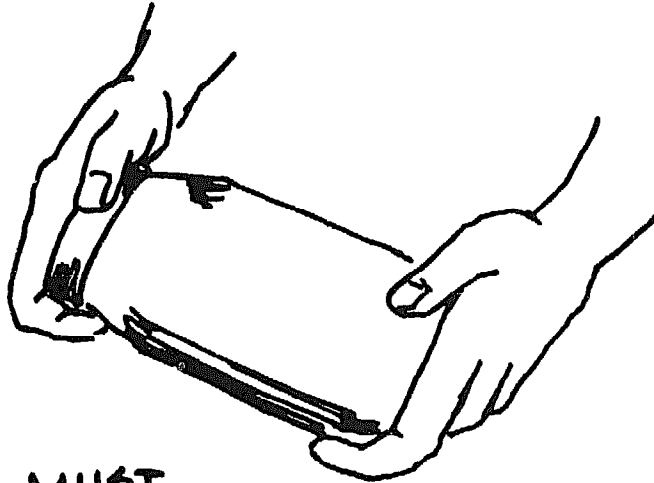

OTHERS MUST BE MIXED.

ALWAYS WASH HANDS AFTER MIXING OR USING POISONS.

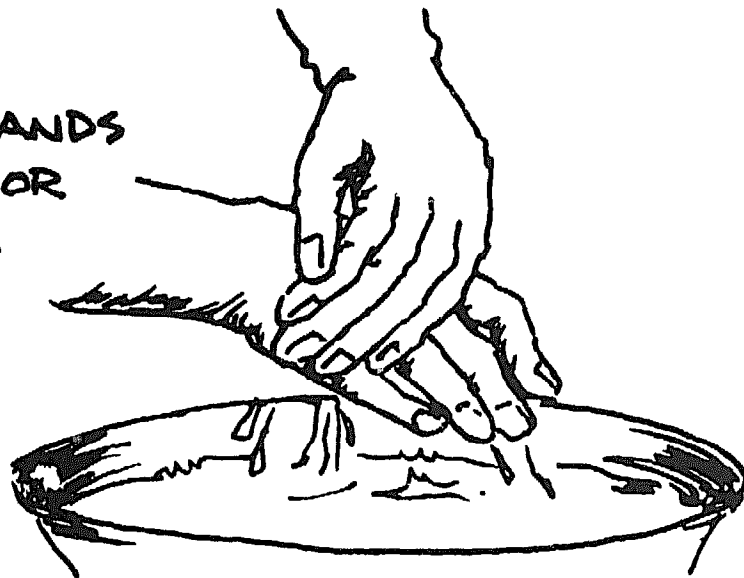



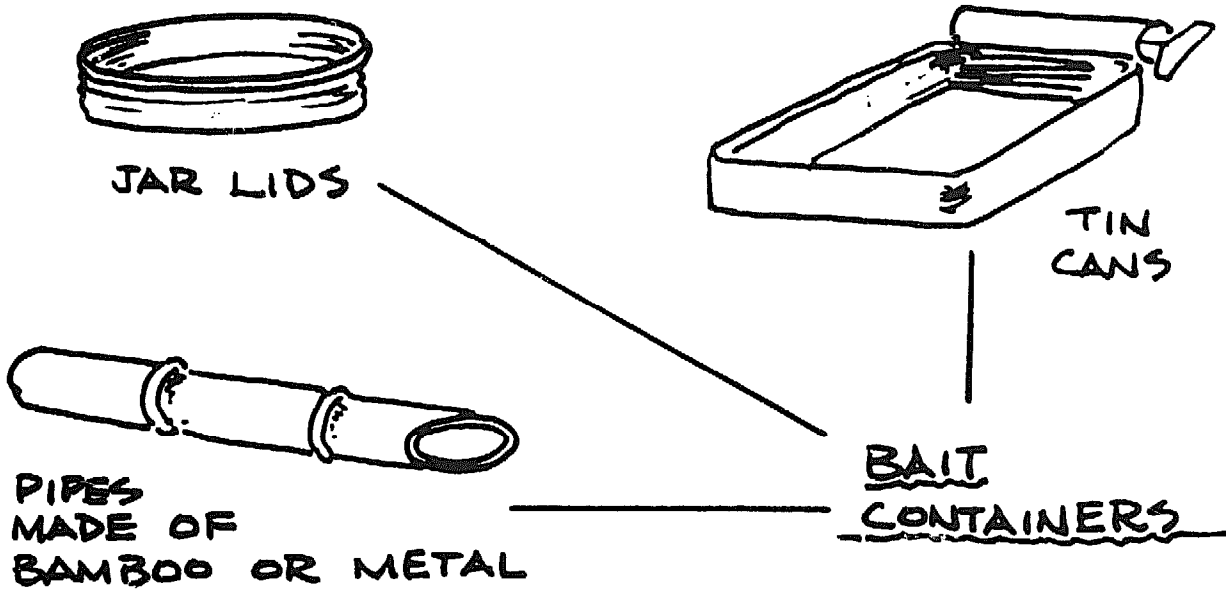

PLACING TRAPS

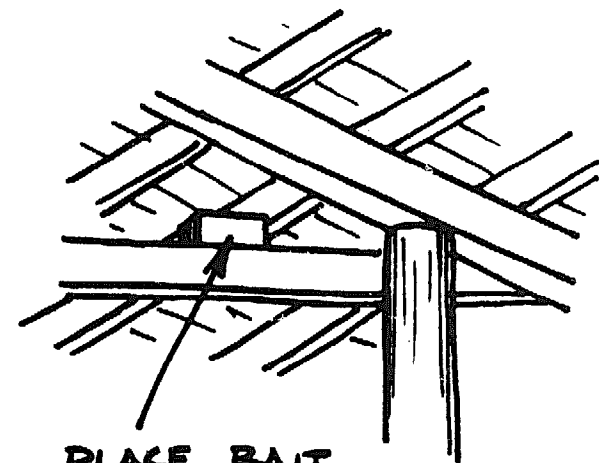

PLACE BAIT WHERE THERE ARE FRESH SIGNS OF RATS.

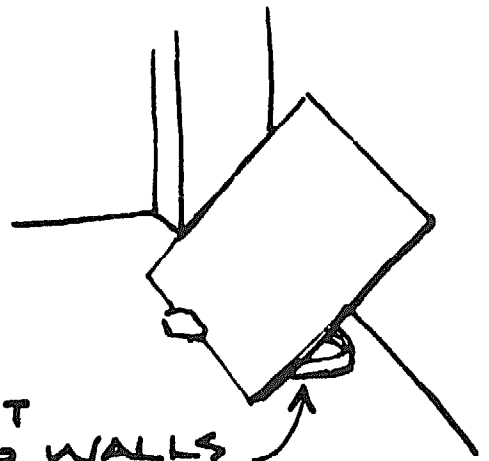

PLACE BAIT CLOSE TO WALLS WHERE RATS RUN

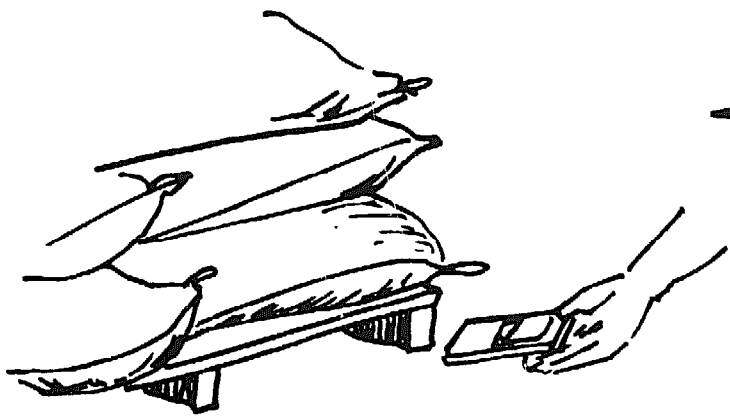

← PUT TRAPS...  
IN PLACES CHILDREN  
MIGHT GO; NEAR  
FOOD. TRAPS ARE SAFER  
THAN POISONS.

PUT TRAPS NEAR  
RAT RUNS AND  
HOLES.

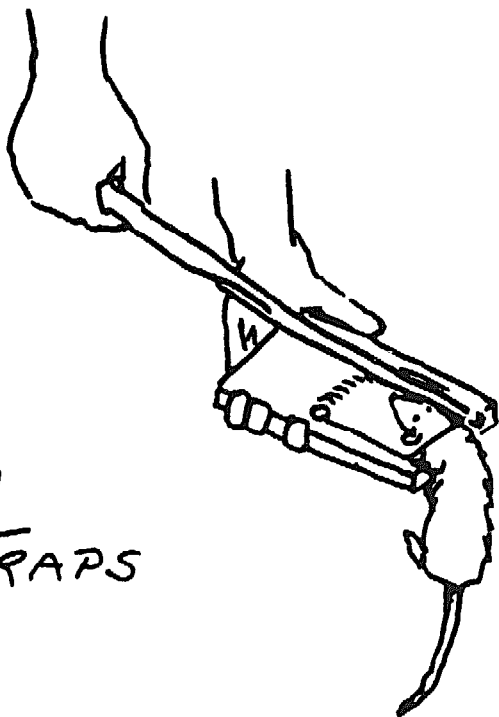
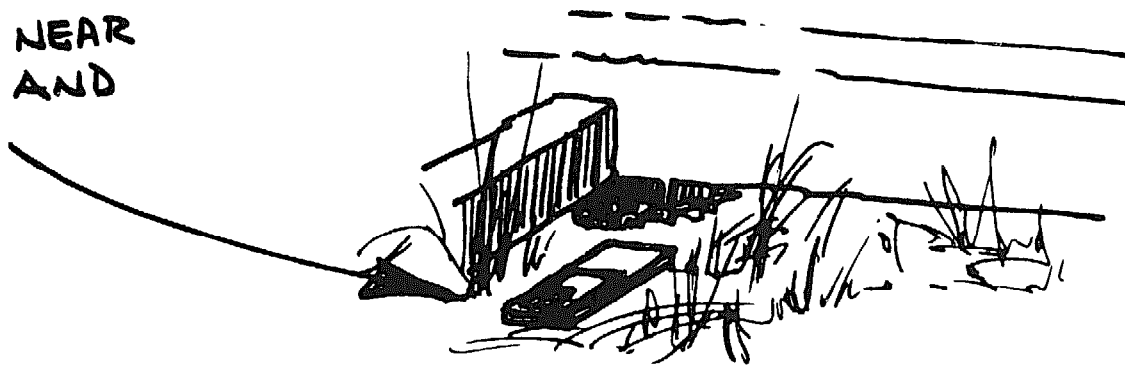

USING  
TRAPS

USE A STICK OR  
SHOVEL TO GET  
RAT OUT OF TRAP.

DO NOT TOUCH  
DEAD RATS.



BURN DEAD RATS

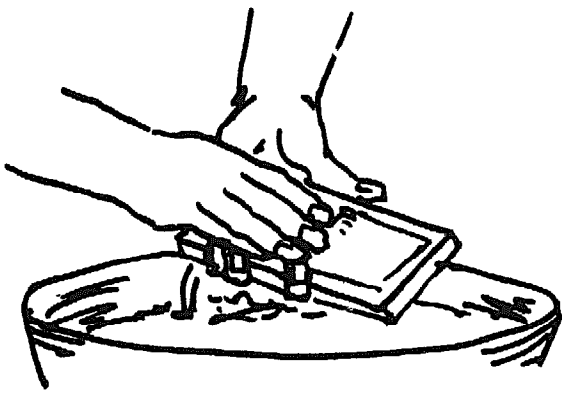

WASH TRAPS  
BEFORE USING  
AGAIN

WASH YOUR  
HANDS.

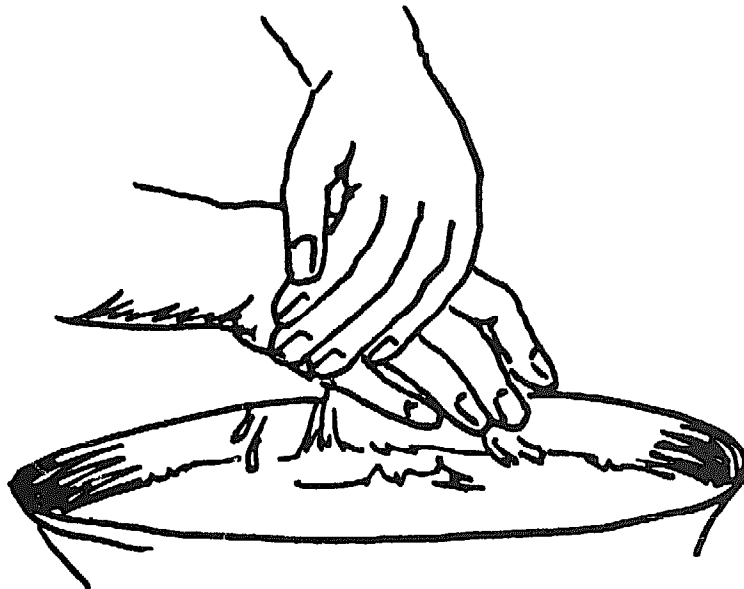

## STORAGE METHODS

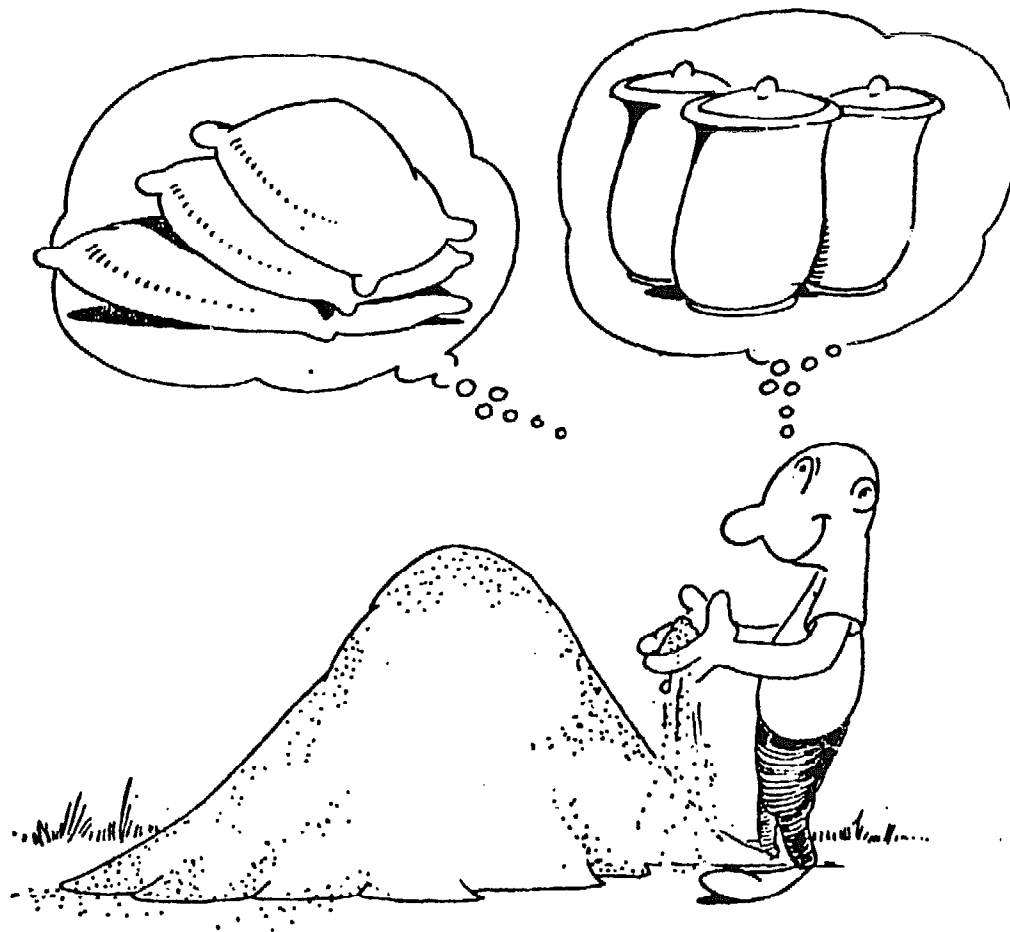

### INTRODUCTION

Each farmer has some method of storing his grain. Any improvement in this storage method must be made by steps the farmer sees as the right ones for his situation or need. A farmer who stores his grain in sacks in a corner of his house may not be ready to build a cement silo. Because this farmer is afraid that thieves will take his grain, he may not want to build any type of storage container outside his house.

For this farmer, trying a different drying method, or cleaning his storage bags, or improving a stacking arrangement, or adding insecticides to sacked grain could be a large, first step toward improved storage.

If a farmer is complaining about insects and rodents eating his stored grain, you have an opening to say, "Let's do something about that problem." But if the farmers in your area feel, "It's always been that way, and there is nothing we can do about it," your first job is to convince the farmer that there is something he can do about his problems.

Only you can introduce the material from this manual because you know the area where you work. Hopefully, the earlier parts of this manual have provided a lot of helpful information and material. If a farmer is not ready to make improvements in his storage method, perhaps you can find the material in this manual to put together leaflets which would help show what change could do for him. One convinced farmer may be all it takes to get things started.

Change only begins when farmers believe that new ideas and technologies can be helpful to them. They may start out by making only small changes in the method already being used. But the important point is that something different is being tried. Then, when the farmer sees an improvement in the quality of his stored grain, you have an opening to say, "Now perhaps you would like to try a storage method that can do even more for you." Perhaps that is the time to suggest a metal drum or a mud silo.

You know from your work that change seems to be accepted very slowly. It is good to keep in mind the fact that for a farmer who has always done things the same way, adding a small amount of insecticide to a sack of grain is a large change. It is very easy to give people more than they want or are ready to receive.

This section of the manual brings together all the grain storage information which was introduced earlier:

- . It discusses and shows some traditional storage methods and gives specific directions for improving these methods. Some of these methods are sack, basket, and pit storage.
- . It gives plans for, among others, mudblock, ferrocement, oil-drum and cement-stave silos.
- . It describes other storage possibilities to give some idea of the range of methods in use.

This section, together with the earlier parts of the manual, ought to help you to help farmers define their choices. To provide even more information, there are some valuable appendices to the manual:

- . Appendix A -- Examples of leaflets illustrating improved storage methods which are being used in certain parts of the world. These leaflets are included to provide suggestions and guides for preparing similar materials.
- . Appendix B -- A guide to selecting moisture meters.
- . Appendix C -- Guidelines and dosages for insecticide use with grain stored under a variety of conditions.
- . Appendix D -- Part of the text of a VITA publication describing ways of testing and using local plant materials to provide waterproofing for buildings made of earth.
- . Appendix E -- The text of a paper dealing with the problem of getting grain storage programs for small-scale farmers underway. This paper was authored and presented by Peace Corps Volunteers in Cotonou, Dahomey.
- . Appendix F -- A bibliography of written material, organizations, and individuals concerned with small-farm level storage problems.
- . Appendix G -- Conversion tables.

## FEEDBACK

As stated earlier, this manual will be reviewed and updated as new ideas, plans, improvements, etc., become available. For the revision process to be most valuable to you and other users of the manual, please send in your comments and the results of your use of the manual. There is one reply form located at the very beginning of the manual, and another is attached here for your convenience. If the reply form is missing from your copy of the manual, just give all your comments, a description of the problem you are dealing with, etc., on a separate sheet of paper and send it to:

PROJECT DIRECTOR  
GRAIN STORAGE  
3706 RHODE ISLAND AVENUE  
MT. RAINIER, MD 20822  
U.S.A.

PLEASE RETURN THIS FORM

NOTE TO THE USER: This manual was published because Peace Corps and VITA people wish to help in a problem area of worldwide concern. In order to provide the most effective help, the authors need to know how the manual is being used and how you feel it can be made even more responsive to your needs. Please fill in the following form and return it to:

PROJECT DIRECTOR  
GRAIN STORAGE  
3706 RHODE ISLAND AVENUE  
MT. RAINIER, MD 20822  
U.S.A.

WHEN WE RECEIVE THIS FORM, WE WILL AUTOMATICALLY PLACE YOUR NAME ON A MAILING LIST SO THAT YOU WILL RECEIVE:

1. Updates and/or additions and corrections to the manual as they become available.
2. Notice of other publications which may be of interest to you.

If you have questions on the material presented in the manual, or if you run into problems implementing the suggestions offered here, please note them in the space provided. Use additional paper if you have to in order to be as specific as you can about the problem. Wherever possible, the authors will try to provide or direct you to an answer.

-----

Date \_\_\_\_\_

Your Name \_\_\_\_\_ Your Company or Agency, if any \_\_\_\_\_

Your Address \_\_\_\_\_  
\_\_\_\_\_

1. How did you find out about the PC/VITA Grain Storage Manual? How did you get your copy?
2. Which parts of the Grain Storage Manual have you found most useful? Least useful? Why?

*Storage Methods -6-*

3. Did you find the Manual easy to read, too simple or complex, complete or incomplete?
  
4. Have you made improvements or changes in any of the plans? (For example, when you were building a dryer or a silo, did you substitute any building materials for the ones mentioned in the plans?) If you have made improvements or changes, please describe what you did that was different. Include photos, sketches, etc., if possible or important.
  
5. Do you know of other methods or equipment which are not included here but which you feel should be included in a new edition of the Manual? If you do know of such methods, etc., please include the information here.
  
6. Did you have any problems using the Manual or implementing any of the plans. If you did have a problem, please describe it completely.
  
7. Do you have other comments and suggestions for following editions of this Manual?



## STORAGE PRINCIPLES

Whichever kind of storage method a farmer uses, there are certain principles upon which every method is based. Every storage container, no matter what it looks like or what it is made of, should:

- . keep grain cool and dry.
- . protect grain from insects.
- . protect grain from rodents.

All storage methods try to do the above three things. But to do these things requires the following good storage practices:

1. Drying grain well (to 12-13% moisture content) before putting it into storage.
2. Putting only clean grain into containers which have had all old grain, dust, straw, and insects removed.
3. Keeping the grain cool and protected from large changes in outside temperatures. This can be done in a number of ways -- by using building materials which do not easily pass on changes in outside temperatures to the stored grain, by keeping or building storage containers away from direct sunlight, by painting the containers white.
4. Protecting the grain from insects by following rules for cleanliness and drying, by applying insecticide and/or by putting the grain into airtight storage.
5. Waterproofing the buildings and containers as much as possible. This is done both by the way the building is constructed and by applying materials which keep water from soaking into the building material. Storage buildings should be built on well-drained locations. They should not be placed where they will be flooded by ground water run-off during heavy rains.
6. Making sure containers are rodent-proofed in all possible ways.
7. Checking the grain regularly while it is in storage to make sure it is not infested, and following recleaning instructions to destroy insects, if they are found when the grain is checked.

## *Storage Methods - &*

A farmer who has these seven points firmly in mind will know why a particular silo or storage method has been built or changed in a certain way. And he can then do much to improve his own storage facility by applying the knowledge to his own problems.

The ideas and suggestions for storage methods which follow in this section, no matter how different they look, all require that these seven steps be taken if they are to be successful.

## FINDING A GOOD STORAGE PLACE

### SCRIPT # 1

**Suggested Use:** This script and the one which follows contain some of the important points to remember about finding, cleaning, and repairing storage places. VITA Volunteer artist Guy T. Welch has provided illustrations of some of these points to give some ideas on ways this material can be presented through pictures.

- . Rats, mice, birds, insects, and mold destroy a lot of grain. It is not easy to keep these dangers away from your grain. But you can do a lot to keep them away.
- . Fix a good place to put your grain before you bring it from the field.
- . The place for grain storage is very important. Grain storage places must be built on well-drained ground, so the building or container does not get flooded or take on too much moisture from the ground.
- . Most insects and molds like warm, wet places.
- . A good storage place is cool and dry.
- . Grain storage is easier if you live in a cool, dry land. Grains are easier to protect.
- . But insects and rodents can attack even in these places. Farmers must protect the grain from these pests wherever they live.
- . Some farmers store grain in large clay jars with thick walls.
- . Some farmers use metal drums for grain storage.
- . Some farmers in warm places put grain in buildings with thick mud, plaster, cement, or thatched walls and roofs. Thick walls help to keep the hot air out. Thick walls help to keep the grain cool.
- . Some farmers store grain under the ground. Grain stored under the ground is kept cool by the earth.

*Storage Methods -10-*

- . You can put grain storage containers or jars on rocks or wood. This keeps the containers off the ground. Air can get under the container. This air cools the grain.
- . You can build storage rooms or buildings on posts. This keeps the floor off the ground. Water from the earth can not get the floor wet. Air can pass under the storage building to cool the grain.
- . There are many ways to store grain.
- . Remember that the storage place must keep grain cool and dry.
- . Remember that the storage place must be clean and free of insects and rodents.
- . Your extension worker can help you find a way to store grain that is good for you.

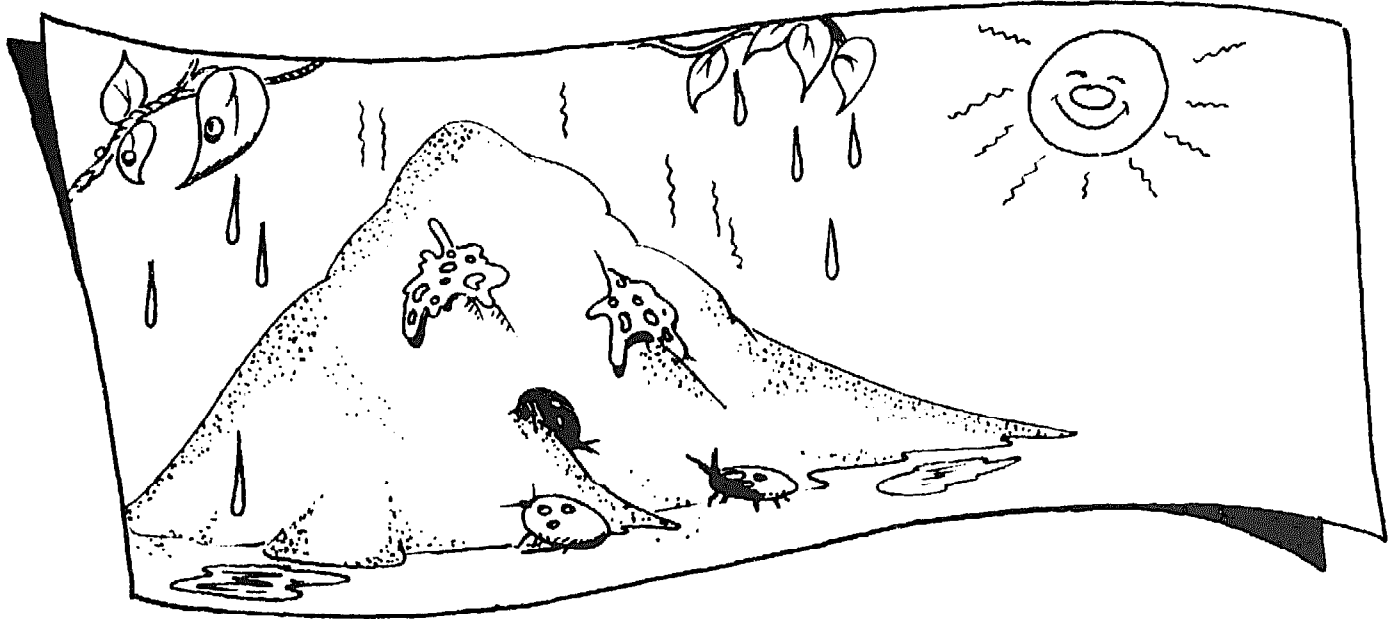
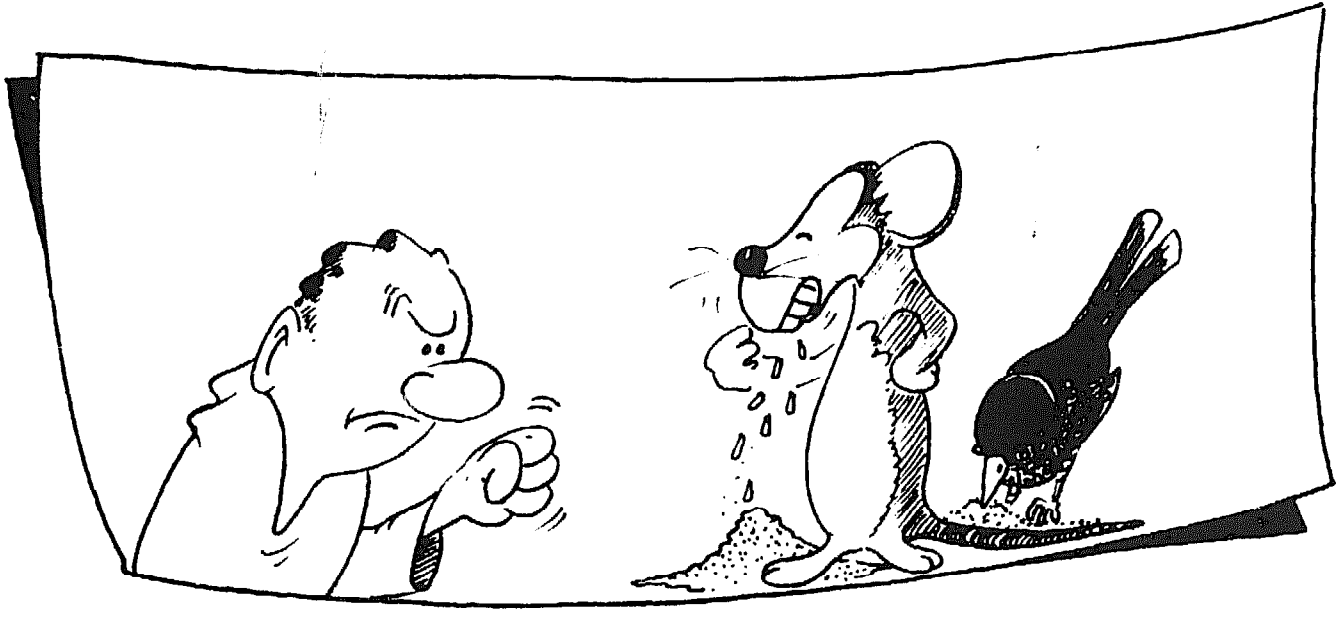
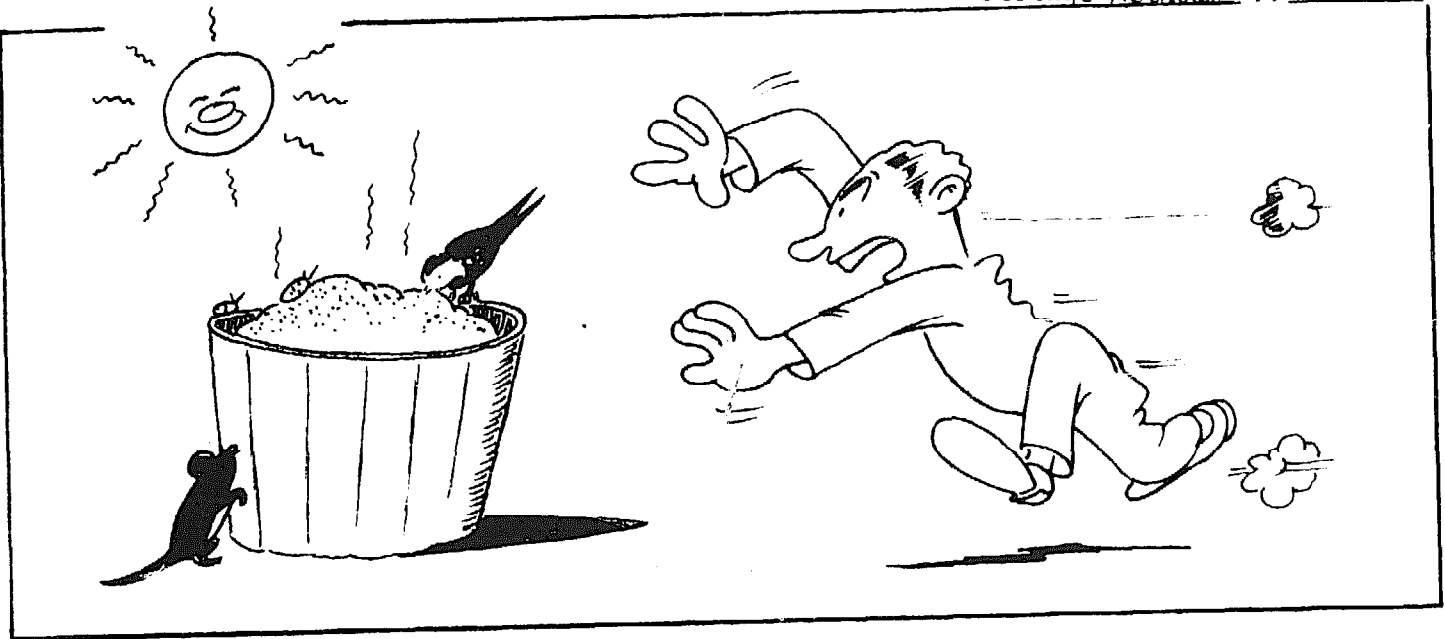

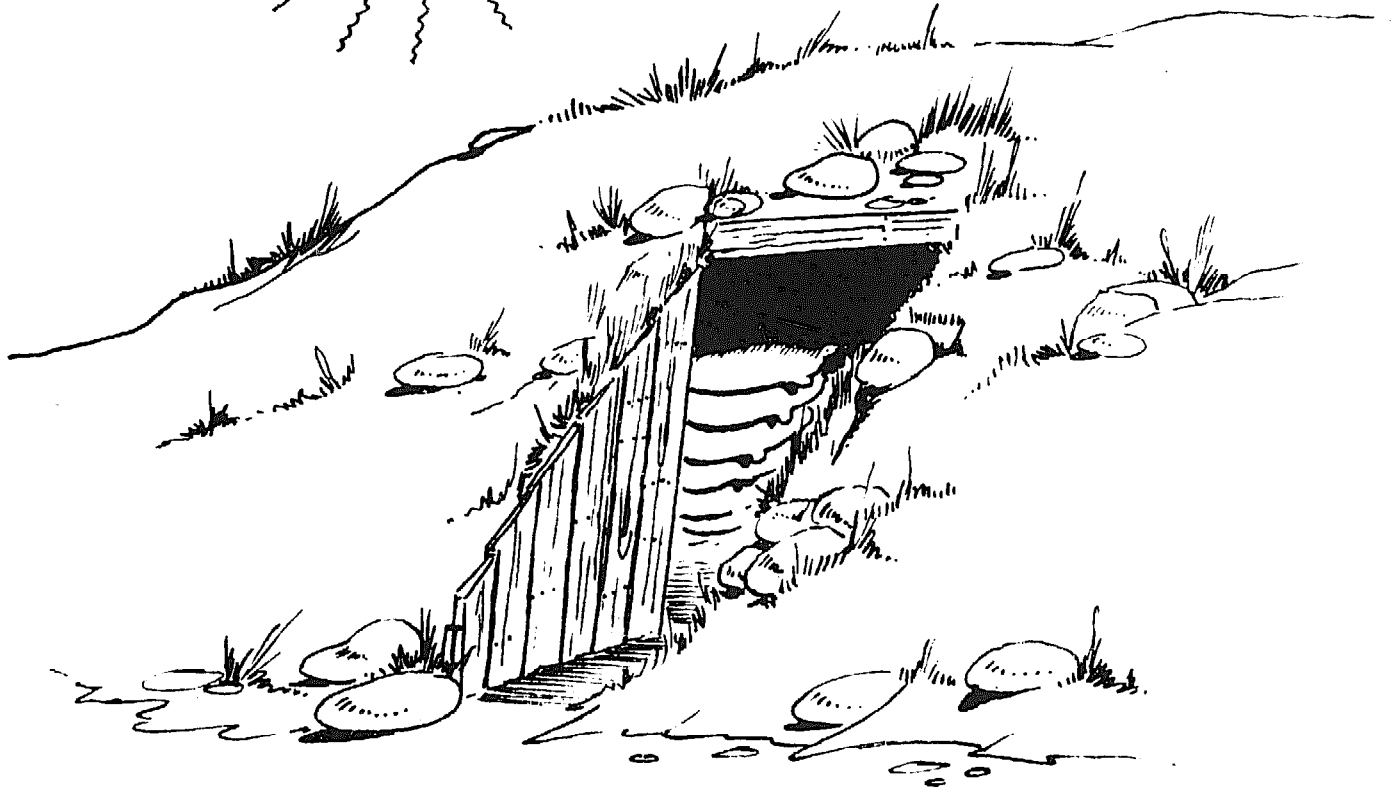
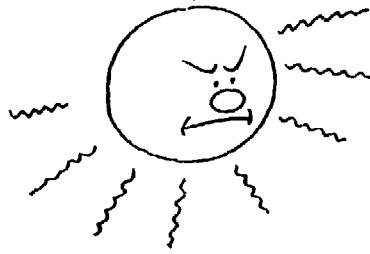

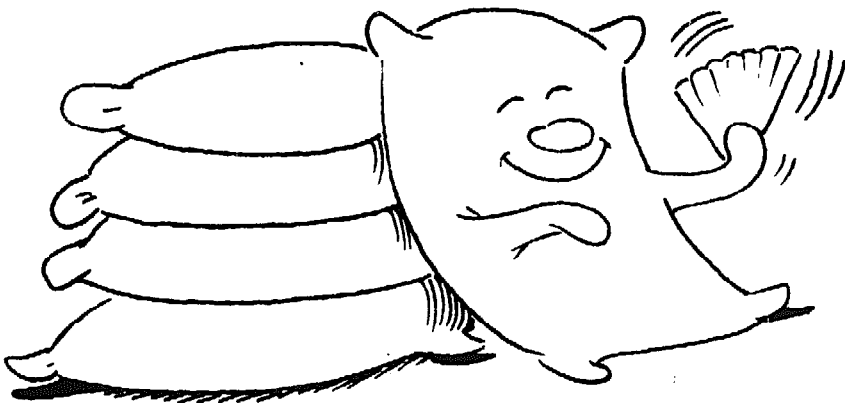
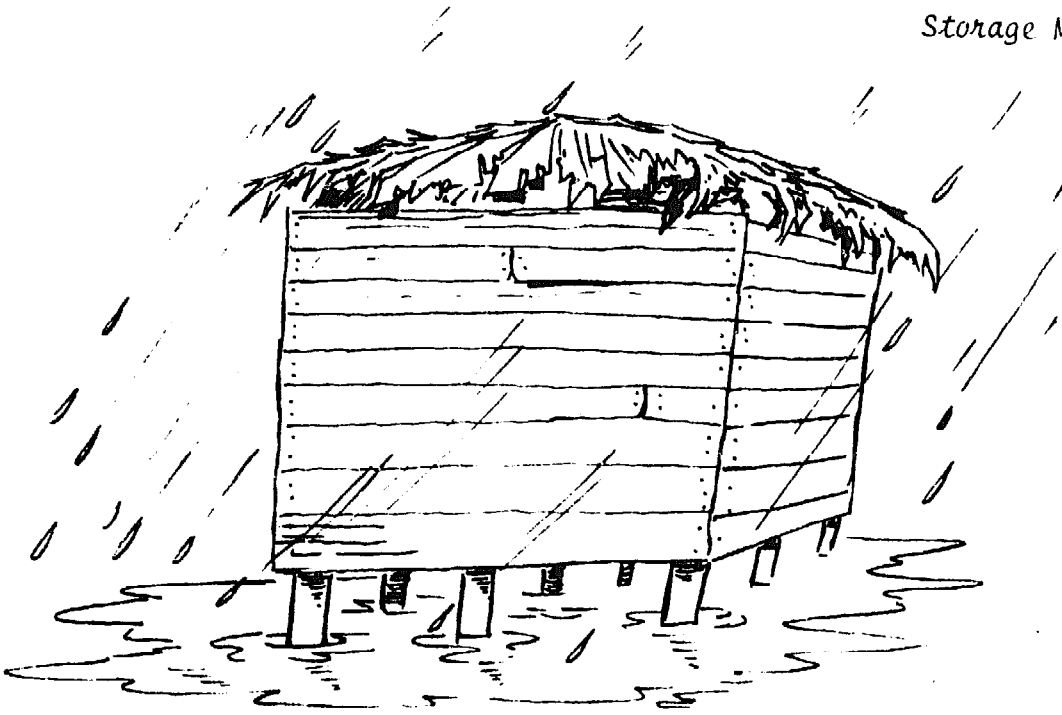

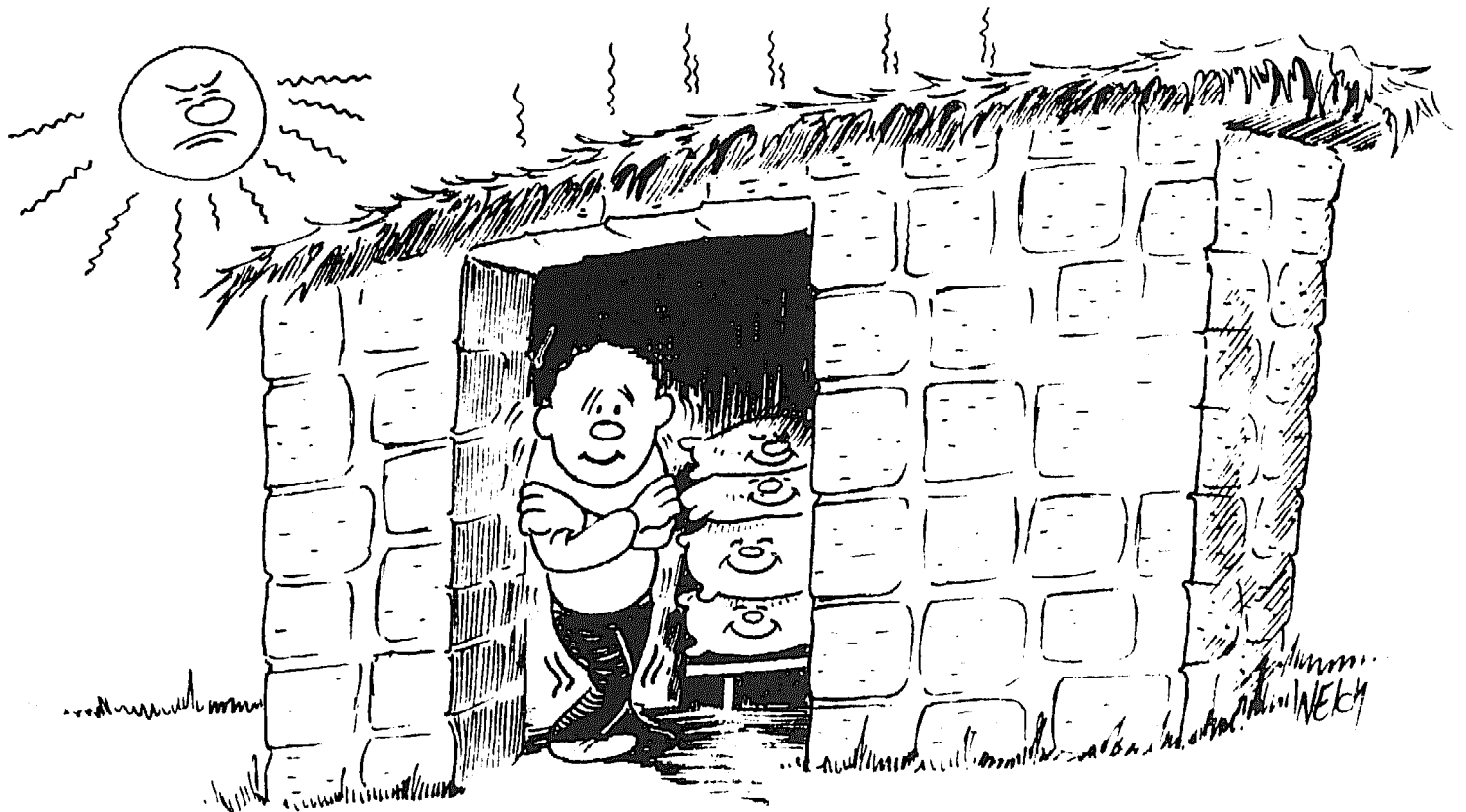



CLEANING AND REPAIRING YOUR STORAGE PLACE

SCRIPT # 2

- . Your storage room or building must be clean. Insects live and have families in dirty places. Rats, mice, and other pests like dirty places too.
- . Take away and burn all dust, old pieces of grain, dirt, straw, and chaff from the storage place.
- . There should be no cracks and holes in the floor, ceiling, or walls. Insects and rodents use these holes to get in.
- . Fill and seal all cracks and holes.
- . Seal large holes in wooden storage places with sheet metal, flattened tin cans, or pieces of wood.
- . Concrete and plaster make good sealing material for plaster, brick, and concrete buildings.
- . Put paint or whitewash on the walls and floors of the storage area. This paint helps close up very small holes. Insects like these small holes.
- . Do not use any poison until you talk to your extension worker.
- . Put mesh wire over large openings and windows. This will keep out rats, chickens, and birds.
- . The roof must keep rain from coming in. The grain must be kept dry.
- . Mend all holes and openings in the roof.
- . Clean the outside area around the storage place.
- . Clean out the containers that you put the grain in.
- . Bags or sacks for storing grain must be shaken.

*Storage Methods -16-*

- . Bags or sacks should be boiled in hot water and dried in the sun. Mend any holes you find in the bags.
- . Check with an extension worker for information on poisons to kill insects and rodents.
- . The extension worker will know what poison to use. He will know how to use the poison.
- . Always remember that many poisons can kill animals and people.
- . Use insecticide on the inside and outside of your storage area.
- . Put insecticide on all cracks and small places where insects like to live.
- . Put out traps for rodents.
- . A good storage place is free of insects and rodents. It is clean and dry.

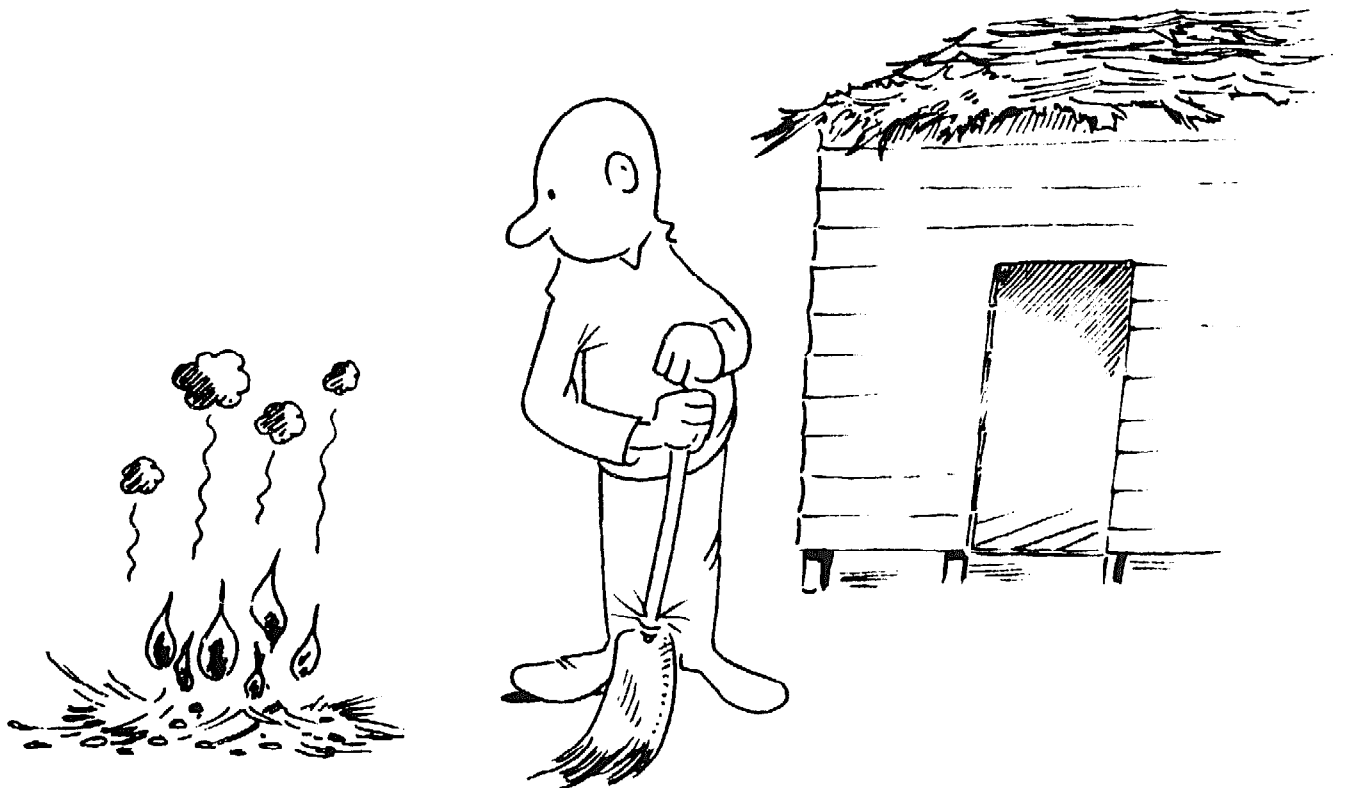

Storage Methods -18-

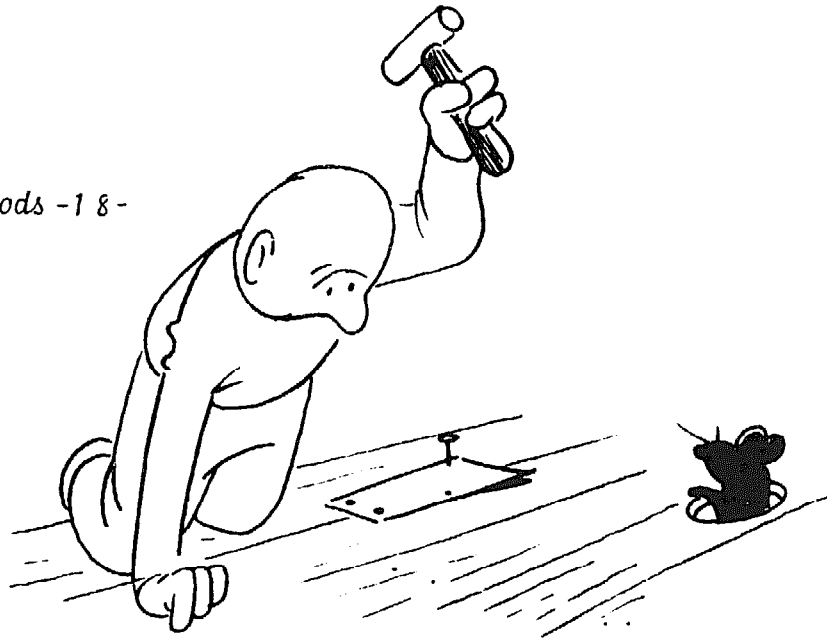

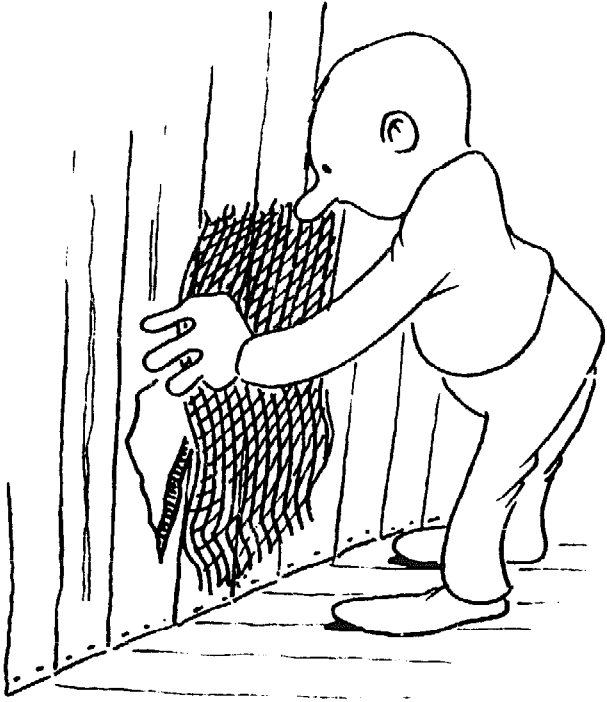



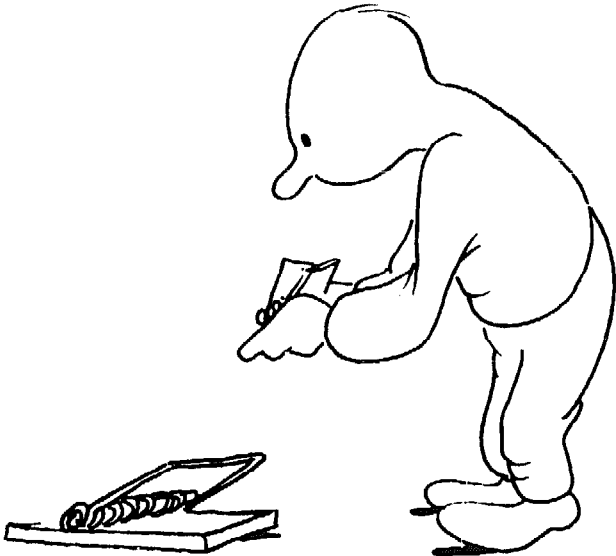
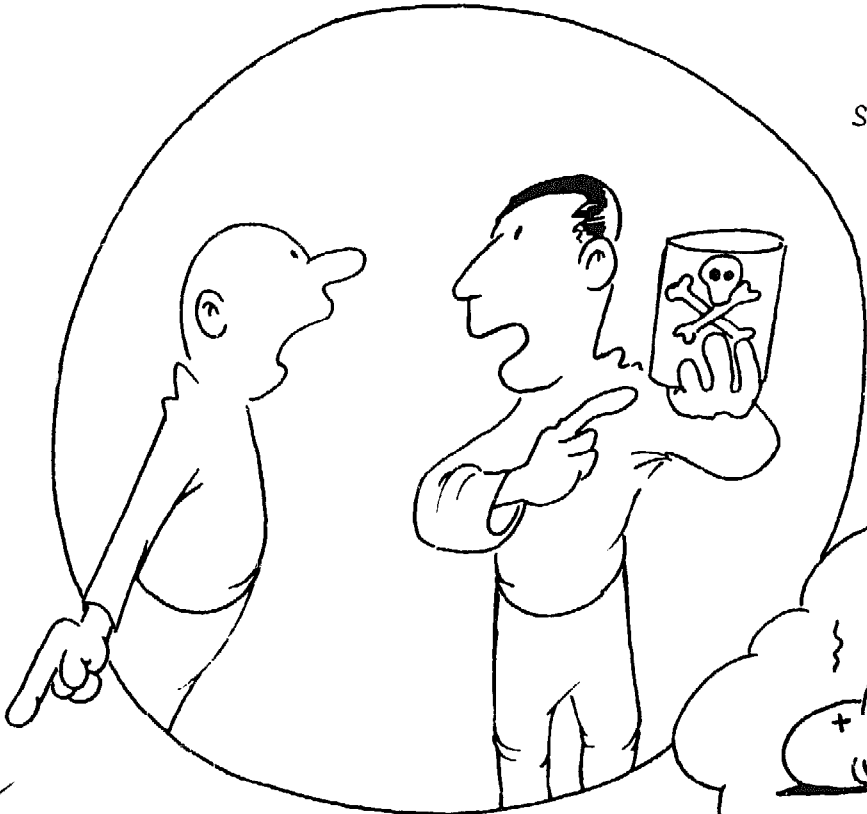

## STORING GRAIN IN BASKET GRANARIES

Grain has been stored in basket-like containers made of grass, reeds, bamboo strips, or small branches for thousands of years. The particular building material depends upon the plants available near a farmer.

These basket granaries are so traditional and widely used that it does not seem necessary to include a plan for making them. There are almost as many different kinds of baskets as there are villages making them, and the skills for this kind of work are passed on within families. What this manual will present is some suggestions for improving basket granaries so that grain stored in them is more protected from insects and molds.

To increase the protection of grain kept in baskets:

- Keep the basket off the ground. Make a strong platform upon which the basket can sit. The shape of the platform will depend upon the shape of the basket. Putting the basket on a platform prevents moisture from coming through the ground into the basket. The platform also offers more protection from rodents.

*Baskets raised off the ground*

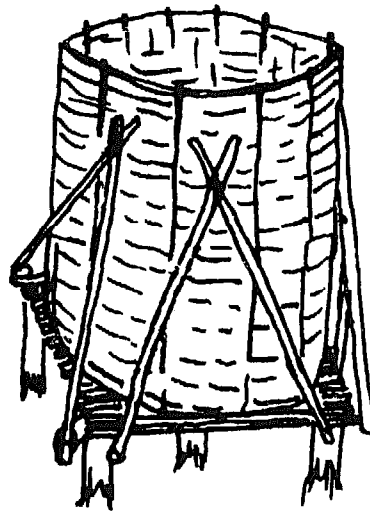
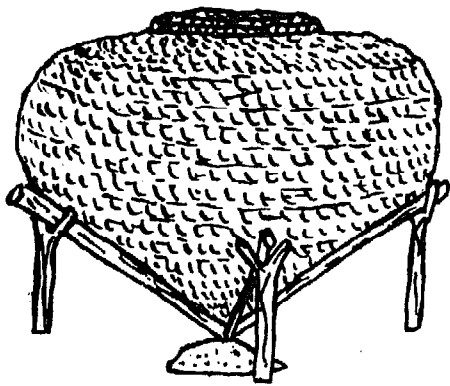

- Make sure the basket is well-protected from the rain. If it is a grass or reed basket, keep it in the house or some other dry building. If it is woven of material which can be kept outside, make sure the roof thatch does not let any rain into the grain.



- Place rodent baffles (guards) on the legs of platforms which support the baskets. These prevent rodents from climbing or jumping into the baskets. (The rodent proofing section contains information on making rat baffles.)
- A tin can, with a plastic cover that can be put on and taken off easily, makes a good emptying chute (see the picture below). Cut the bottom out of the can and fit the open end of the can into the lower part of the basket. This makes it unnecessary to take off the cover each time grain is taken out.
- Baskets can be plastered inside and outside with mud, clay, or cow dung. Covers should be tight and sealed with plaster of the same material. It is important for farmers to realize that grain holding a lot of moisture, whether threshed or freshly harvested, should not be placed in baskets which have been plastered in this way. Plastering makes the basket much more airtight. Moist grain needs to have air passing through to dry it. If moist grain is put into storage without enough air, it will mold and rot quickly.

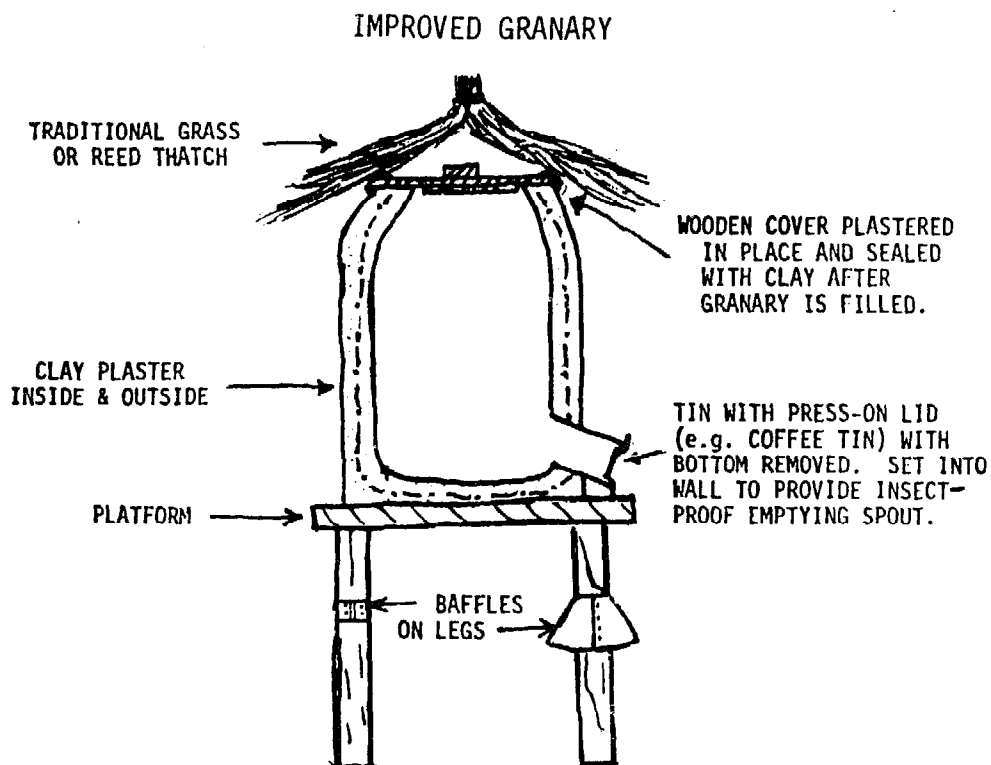

## INSTRUCTION SHEET FOR STORING GRAIN IN BASKETS

This instruction sheet includes some directions for using insecticide in basket storage. You should include the names of insecticides available in your area which are appropriate for use with grain being stored in baskets. (Malathion and Pyrethrum are mentioned.)

You may want to use the information to make two instruction sheets: one explaining good basket storage without insecticide; the other, with use of insecticide. Also, you may want to illustrate the sheets if you hand them out to farmers in your area who use basket granaries.

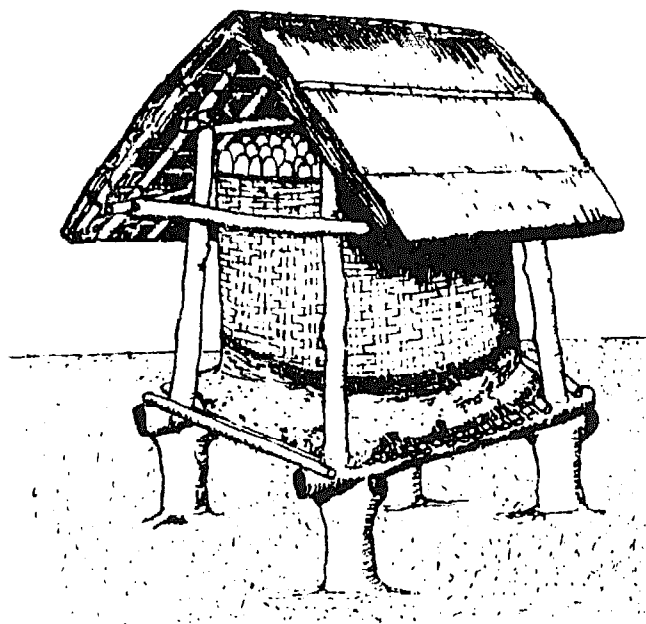

### CLEAN THE BASKET AND THE AREA:

- . Make sure the area around the basket is clean. Baskets should always be kept inside a building unless the baskets have been built for outside use.
- . Place the basket on a platform so that it will not pick up moisture from the ground.
- . Clean out all grain dust and broken grains if the basket has been used before.
- . Mend any holes in the basket.

*Storage Methods -26-*

- . Plaster with mud, clay, or cow dung if storing very dry grain.

CLEAN AND DRY THE GRAIN CAREFULLY.

IF YOU HAVE INSECTICIDE:

- . Dust the inside of the basket with insecticide. Do this carefully so any insects will be killed.
- . Mix the dry grain with insecticide before you put it into the basket. To mix the grain and insecticide, you must:

*Place the dry grain on a plastic sheet, clean floor, or hard-packed ground.*

*Sprinkle insecticide over the grain. Use 1 packet (4 oz.) of Malathion or pyrethrum dust for each 100 kg of grain.*

*Mix the grain and insecticide with a shovel until they are mixed very well.*

*If you are storing more than 100kg of grain, you must use more insecticide.*

IF YOU DO NOT HAVE INSECTICIDE:

- . Mix burned cow dung or wood ashes with the grain.

PUT THE GRAIN INTO THE BASKET. MAKE SURE THE COVER FITS TIGHTLY.

OPEN THE BASKET AND CHECK THE GRAIN EVERY TWO MONTHS. IF YOU FIND INSECTS:

- . Winnow, sieve, or place the grain in the sun.
- . Clean the basket.
- . Add more insecticide or ashes.
- . Put the grain back and replace the cover tightly.

WHEN YOU REMOVE THE GRAIN FOR FOOD, WASH IT CAREFULLY. INSECTICIDES CAN LEAVE MATERIAL ON THE GRAINS WHICH IS NOT GOOD FOR PEOPLE TO EAT.

### STORING GRAIN IN SACKS

Putting grain in sacks (bags) is a very old method of storing. Storage sacks are made of woven jute, hemp, sisal, local grasses, cotton -- whatever material is available in the area. Sacks are relatively expensive as they do not often last for more than two seasons. Sacks do not give a lot of natural protection against insects, rodents, and moisture. But sack storage has some advantages for the small farmer, and there are things farmers can do to protect their sacked grain.

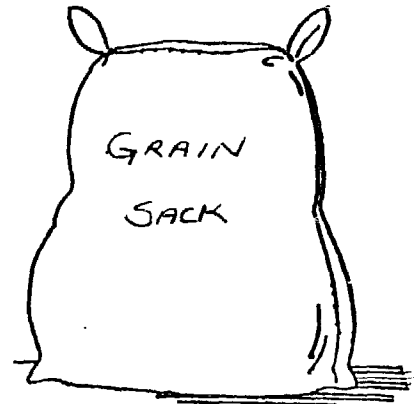

The Advantages of Sack Storage for Farmers:

- Grain stored in sacks made of fibers can have a little higher moisture content than grain put into airtight storage. If the sacks are properly stacked, air can move through the sacks to dry and cool the grain.

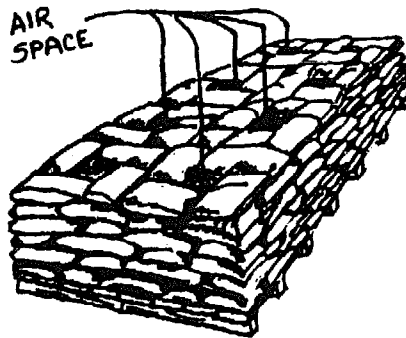

- Sacks are easy to label. Farmers can label old grain sacks and new grain sacks to keep them separate. Seed grain can be marked and kept separately from the other grains.
- Sacks are easy to move around. And sacks or parts of sacks can be used as they are needed.
- Sacks can be stored in a farmer's house - no special buildings or containers are needed.
- Farmers in one village may decide to build a shed to hold the grain belonging to all the village's farmers. It is easy to mark sacks so that each farmer's grain can be found simply.

## Storage Methods -28-

Grain stored in fiber sacks is easily attacked by insects, rodents, and molds. Often these attacks are worse because a farmer has not done all he can to protect his grain sacks.

### CONTROLLING MOISTURE AND PREVENTING MOLDING IN SACKED GRAIN

- Dry the grain well. Although grain can contain about two percent (2%) more moisture for sack storage than for airtight storage, the grain should be as dry as possible.
- Check the grain every two weeks. Suggest to the farmer that he make checking his grain part of a weekly or bi-weekly routine. Put his hand into a sack of grain to check for heating. He can smell the grain and look for dark kernels: signs of mold. If these signs are found, he should dump out the grain and dry it again.
- Waterproof the walls and roof of the building where the grain is stored.
- STACK THE SACKS ON PLATFORMS RAISED OFF THE FLOOR. This keeps sacked grain from taking moisture from the floor. Farmers can make these platforms out of whatever materials they have. If no wood or bricks are available to make a platform, the ground can be covered with plastic sheets. The raised platform is better than the plastic because it also allows air to flow under the sacked grain.

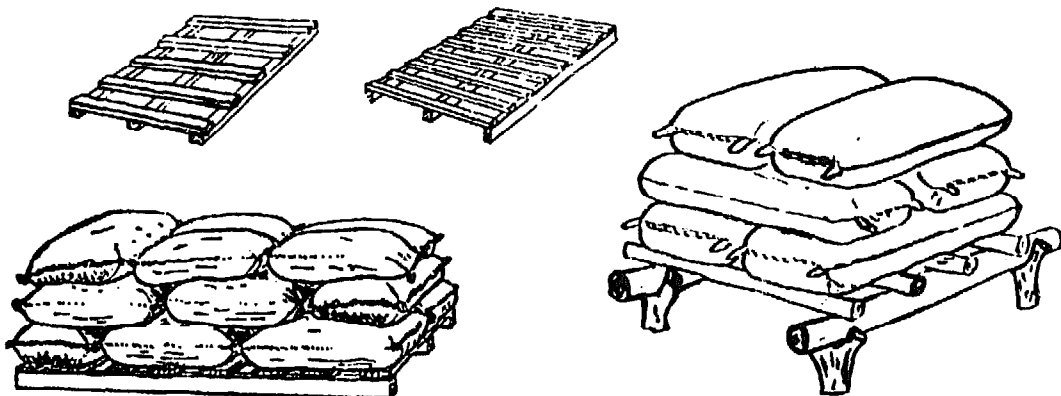

- Stack the sacks in a neat manner. Leave space between the sacks so that air can move freely between the sacks.

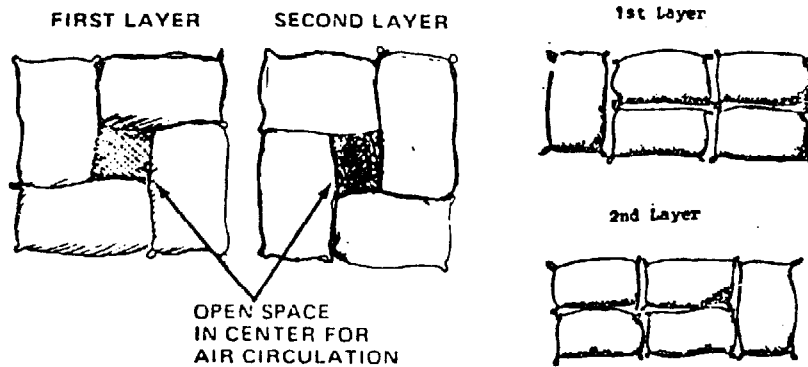

#### CONTROLLING INSECT ATTACKS ON SACKED GRAIN

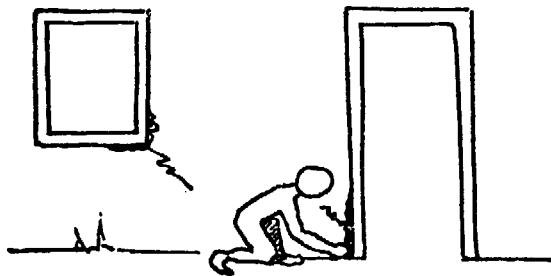

CLOSE CRACKS TIGHTLY

- Mend cracks in the walls, roof, and doors of the building where grain is kept. This mending keeps insects from getting in and out of the building through the cracks.
- Remove and check sacks of grain left from the last harvest. The farmer should take them outside before he cleans the storeroom. This grain should be winnowed, sieved, and spread out in the sun for a time before it is put back into the bags. If the grain

is sieved, light a fire and burn all the insects found, so they will not move right back into the grain.

- Clean the room well before placing the sacks inside. Make sure there is no dust, dirt, and old grain left. Sweep walls and ceilings as well as the floors. Some farmers may want to burn a small, smoky fire in the room to drive out insects, if they are not going to use insecticide to protect the inside of the building.



SWEEP STORE ROOM THOROUGHLY

## Storage Methods -30-

### If Insecticide Is Available

- . Apply insecticide to the storage building. You can recommend DDT, Malathion, and Lindane for use on buildings and instruct the farmer on use of these three poisons. There also are other insecticides that can be used on buildings.
- . Dust insecticide on the sacks before the grain is put in. (Or the insecticide can be put on the bags as they are stacked. There is a page attached to the end of this section which gives instructions on applying insecticides as you stack grain.) Malathion is a safe insecticide for a farmer to use for this purpose -- it is safe for him to use and safe for his grain. Brush the sacks with a stiff brush and then shake them well. Brush both the outside and the inside of the sack. Put Malathion on both the inside and the outside of the sack.
- . Mix the grain with insecticide before it is placed in bags. Use only clean, dry grain. See the end of this section for instructions on mixing grain and insecticide for sack storage.

### If Insecticide Is Not Used

- . Clean the sacks carefully. Shake the sacks well. If sacks are made of a material which can be placed in hot water, boil the sacks or dip them in very hot water. Dry the sacks in the hot sun. If sacks can not be placed in water, brush them well and place them in the sun. Make sure both the inside and the outside get exposed to the sun.



OLD SACKS SHOULD BE WASHED

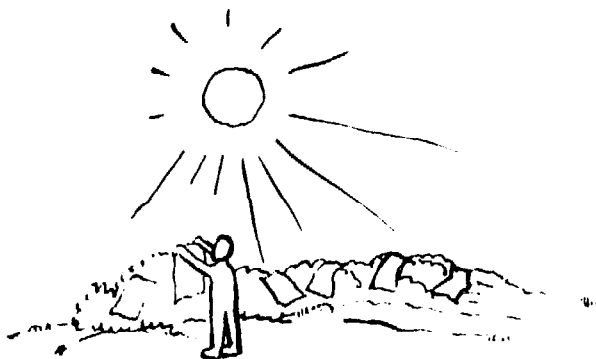

LAY SACKS OUT IN HOT SUN TO DRY

- . Use only clean, dry grain. The grain should be checked. It should be free of insects (the easily seen adults, at least).
- . Mix ash from cattle dung or wood or fine sand with the grain if insecticide is not to be used. Use one, 10-liter bucket of ash for each 100kg of grain.
- . Stack the sacks carefully (as shown earlier). The platform holding the sacks must be placed away from the walls because, for example, there are insects which live in wood and thatch which will move to the stored grain.

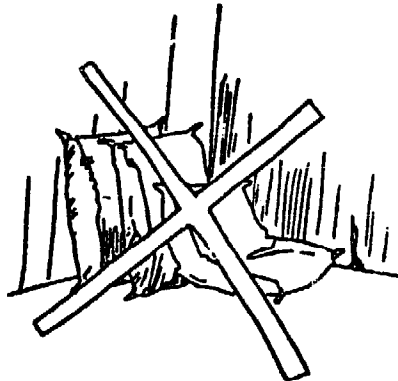

DONT STORE GRAIN ON FLOOR  
OR AGAINST THE WALL.

- . Check the grain regularly. If no insecticide has been used, a farmer may have to dump the grain out, get the insects out, and re-bag the grain every two months or so. If, for example, Malathion is used, that insecticide possibly will have to be reapplied after four months of storage.

#### CONTROLLING RODENT ATTACKS ON SACKED GRAIN



- . Keep the area around the sacks clear of dirt, broken grains, grain dust, and trash. This clearing makes it harder for rats and mice to find home and food near the stored grain.
  - Cover and repair holes that rodents might use to get into the building where the grain is stored.
  - Keep the sacks off the floor. This does not stop rats and mice from attacking the grain, but it does make cleaning, poisoning and baiting, and looking for rats and mice easier.



## Storage Methods -32-

- Move the stacks if rodents are seen. Then use traps and poisoned baits near the pathways and rodent holes. (See the section on rodent control for more information on using traps and poisons to control rodents).



### KEY POINTS FOR SUCCESSFUL SACK STORAGE

- . Sacks and buildings which are clean.
- . Dry grain which is free of insects.
- . Good shelter which keeps out rain, insects, rodents, and birds.
- . Careful checking of the grain while it is in storage.

The following pages include:

- . Instructions which can be given to farmers to aid them with mixing grain and insecticides for sack and small-container storage.
- . Instructions for adding insecticide while stacking layers of grain bags.
- . Sample material for a leaflet which could be made to illustrate proper sack storage through pictures.

MIXING GRAIN AND INSECTICIDES  
FOR SACK AND SMALL-CONTAINER STORAGE

The following insecticides and dosages are recommended for direct mixing with grain:

- Malathion. Use 120 grams of 1.0% dust for each 200kg of grain.
- Lindane. Use 120 grams of 0.1% dust for each 200kg of grain.
- pyrethrum. Use 120 grams of 0.2% pyrethrins plus 1.0% piperonyl butoxide dust for each 200kg of grain.

If you can find Malathion, for example, only in 2%, 5%, or .5% mixtures, you will have to adjust the strength of the insecticide. For example, if you are using 2.0% Dust, you need to use only 60 grams of 2.0% Dust per 200kg.

- . Apply the insecticide to one half sack of grain at a time.
- . Empty one half of the grain from a sack onto hard-packed earth, a plastic sheet, or clean floor.
- . Put 60 grams of insecticide dust on the grain.
- . Turn the grain over and over with a shovel. Make sure the grain and insecticide are well-mixed.
- . Empty the other half of the bag on top of the grain you have just mixed.
- . Put the rest (the other half -- 60 grams) of the insecticide on the grain.
- . Mix very well.
- . Put the grain back into the bag and close it tightly.

REMEMBER: THE GRAIN MUST BE DRY BEFORE THE INSECTICIDE CAN BE USED.  
INSECTICIDES DO NOT WORK AS WELL IF THE GRAIN IS TOO MOIST.

TREATING STACKS OF BAGGED GRAIN  
RECOMMENDED INSECTICIDES AND DOSAGES

There are two ways to apply insecticide to stacks of bagged grain:

1. Layer by Layer

Spray or dust each layer of bags with Malathion or Lindane as the stack is being built.

Malathion -- 25 grams of 2.0% Dust per sack  
                  or  
                  50 grams of 2.0% Dust per square meter

Lindane -- 25 grams of 0.5% Dust per sack  
                  or  
                  50 grams of 0.5% Dust per square meter

2. Stack Treatment

Build the stack first. Then spray all four sides and the top surface of the stack. Use Dispersible Powder formulations of Malathion and Lindane at the dosages recommended for spraying storage buildings.

When this treatment is finished, apply a band of insecticide around the bottoms of the stacks to control crawling insects. Malathion is best for this job, though where it is not available, Lindane or DDT may be used.

## STORING GRAIN IN SACKS

**Suggested Uses:** This is an easy-to-read summary of the important things to remember for good sack storage. Pick out the points that best fit your situation and use them with farmers in your area. They are simply worded and can easily be pictured by using drawings or photographs; they can be translated easily.

- . Grain is often stored in sacks. Sacks are also called bags.
- . Sacks are made of different things.
- . Sacks are easy to put away. You can store them in a corner of the house.
- . You can put grain sacks in a special storage building.
- . Sacks are easy to carry.
- . Each sack can be labeled to show what is inside.
- . Put your name on each sack. It is easy to show which grain belongs to you.
- . Insects, rats, and molds can attack grain kept in sacks.
- . You can protect the sacks from these dangers. You must start before the grain goes into the sack.
- . Clean your storage area well.
- . Make sure there is no dust, old grain, straw, or trash in the storage place.
- . Mend holes in the roof, floor, or walls.
- . Check for cracks. Insects hide there.
- . Make sure rain and water from the ground can not get the grain wet.
- . Put rat guards on the legs of storage containers or buildings.
- . Ask your extension agent about insecticides you can use.

## Storage Methods -38-

- . Shake out old storage sacks.
- . Put old sacks in boiling water, if possible.
- . Dry old sacks in bright sunlight.
- . Mend holes in the sacks.
- . Spray or dust the bags with insecticide.
- . Spray or dust the building with insecticide.
- . Make sure the grain you put into the sack has no insects in it.
- . Put only clean, dry grain into sacks.
- . Some insect poisons can be added into the sack with the grain. This protects the grain from insects for some time. Ask your extension agent before you do this. Some poisons can poison the grain.
- . You can add sand and ash to the grain in the sack. Insects do not like these materials.
- . Poison is better than sand and ash. But sand and ash are better than putting the grain in with no protection.
- . Close all sacks tightly.
- . Put each kind of grain in a separate sack.
- . Place grain sacks off the ground.
- . If you have many sacks, stack the sacks well. Leave room between the sacks. Air in the room will cool the grain better if there is room between the sacks.
- . Do not stack sacks against the walls. Insects and termites get into the grain from the walls.
- . Check the sacks often. Look for insects. Smell for mold. Look for wet places.
- . If you find insects or mold, dump the grain out of the sack and leave it in the sun. Sieve the grain.
- . Clean the sacks again.

- . Put the grain back into the sacks immediately after cleaning.

REMEMBER: THERE ARE POISONS WHICH YOU CAN ADD TO THE SACKS OF GRAIN AND OTHERS WHICH ARE TO BE USED ONLY ON NON-FOOD LIKE COTTON.

THESE POISONS CAN BE DANGEROUS.

DO NOT USE POISON BEFORE YOU TALK WITH YOUR EXTENSION WORKER.

## AIRTIGHT STORAGE

### INTRODUCTION

Insects can still grow and reproduce in very dry grain. Grain dried to a 12 or 13% moisture level will not mold, but can still be very good food for insects.

The moisture level in grain has to be 9% or less to slow down insect development. Very high and very low temperatures also slow down insect growth. But most farmers will have trouble getting their grain below 12% moisture and in using temperature to control insect development. They often do not have the special equipment necessary to do these things.

More and more farmers do use insecticides to control insects in grain. But some insecticides are dangerous; some are expensive; sometimes they are not available; and there is increasing concern about using chemicals of any kind on food products.

### HOW IT WORKS

Airtight storage simply means putting grain into containers which keep air from getting into the grain. Some air is let into the container at the time the grain is put into storage. But after the container is sealed, no more air enters. The respiration of the grain and any insects in it uses up all the oxygen. Insects need oxygen to live. They die without it. Any molds present which require oxygen also will die.

You can show farmers how airtight storage works by putting some insects and grains on a very smooth surface and turning a glass over on top of them. Make sure the glass is tight against the surface. Seal it with wax or some other material. Or seal some grain kernels and insects in a glass jar. Cover the jar with a screw-on lid or a plastic sheet. Just make sure no air can enter the container!

Wait for a while. The insects will begin to move more slowly. Finally, they will die. How long it takes for the insects to die will depend upon the number of insects, the amount of grain, and the size of the glass container.

## Storage Methods -42-

You can speed up the experiment by placing a lighted candle under the glass container. The flame on the candle requires oxygen to keep burning. The flame will use up the oxygen in the container quickly. When the oxygen is gone, the flame will go out. Soon, the insects will die.

The lack of oxygen, which kills insects, does not seem to hurt the grain or to keep seed grain from germinating when it is planted.

Successful airtight storage depends upon a number of things:

- . Building containers which are airtight. This means using materials which do not let air flow through them, for example, metal, plastic, concrete. These containers must be checked to make sure there are no cracks or holes. Sometimes a farmer will see light coming through cracks in a large container. If the container is a gourd, for example, he can check for cracks by filling it with water to see if there are any leaks. All cracks in storage containers should be sealed for good protection. In addition, it is usually a good idea to coat or paint the entire outside (and sometimes the inside) surface of the container with tar or oil-based paints (they are waterproof and also do not let air pass through).

For a farmer who cannot afford to buy these materials, there may be local trees and plants which produce materials useful for waterproofing. Appendix D explains how a farmer can find and use local materials to waterproof and protect the buildings he makes with mudblocks or earth.

- . Sealing tightly the holes for putting grain into the container and for taking grain out. Tar, wax, or pieces of rubber cut from old tires, and inner tubes can be used for this.
- . Filling airtight storage containers to the top is important. Full containers, which are sealed against air, can kill insects in a few days. But if the container is not full, the insects take a lot longer to die. And before they die, they may damage a lot of grain.



- . Keeping the storage container closed. Unless the airtight container is quite small, farmers probably will want to store the grain they use for food separately. The storage container holding the food grain is opened often. Every time a container is opened, more air containing oxygen enters the stored grain. This added air and frequent opening encourages insect growth.

Some of the storage methods used for thousands of years have been based loosely on the principles of airtight storage. A farmer might not call his method, airtight storage, or be able to tell you why it works. He stores his grain this way because it keeps his grain pretty safe, and he has been doing it this way for many years. Many of these methods are basically good. Improvements can make them more airtight and, therefore, increase their ability to protect grain.

#### CHOOSING A METHOD OF AIRTIGHT STORAGE

A farmer has to decide what he needs his storage method to do, and, then, he must figure the costs of each method. Some of the methods, such as metal drums and plastic sacks, cost more money. But they are definitely airtight when used correctly and are very likely to make up their costs by good storage of grain. Other methods, such as the Improved Mudblock Silo, are harder to make airtight, take longer to build, and require more upkeep. But they can hold large amounts of grain, and they can be made with local materials.

Airtight storage is something farmers who store dry grain should work toward. (REMEMBER: IF THE FARMER IS STORING GRAIN WHICH HAS A MOISTURE CONTENT OVER 12-13%, HE SHOULD NOT USE AIRTIGHT STORAGE. Grain which has a high moisture content should be stored so that air can pass over the kernels.)

The rest of the material included in this section describes storage methods which are, or can be made by making the various improvement described here, quite airtight and waterproof. Hopefully, this material will serve as a useful guide to some of the storage possibilities that are available to small-scale farmers.

### STORING IN GOURDS AND BASKETS

Gourds are the hard, dried outside cases (skins) of certain fruits. They are found in many places and are used for storing small amounts of grain. Grain for planting is often stored in gourds.

Scientists are working to discover ways of making gourds effective airtight containers for grain that has no more than 12-13% moisture in it. Here are some of the findings:

- . Linseed oil or varnish painted all over the outside of the gourd makes it almost airtight.
- . The stopper or cover for the gourd has to be sealed well.
- . Pitch and bitumen are easier for farmers to get and seem to make the gourds airtight.
- . Any thick substance which will stick to the gourd will work very well. There are probably local materials which can be found and made to seal the gourd. See Appendix D. It is likely that some of the materials found for waterproofing soil would be useful to seal the gourds. If the material stays sticky and does not dry, sprinkle sand or earth all over it.

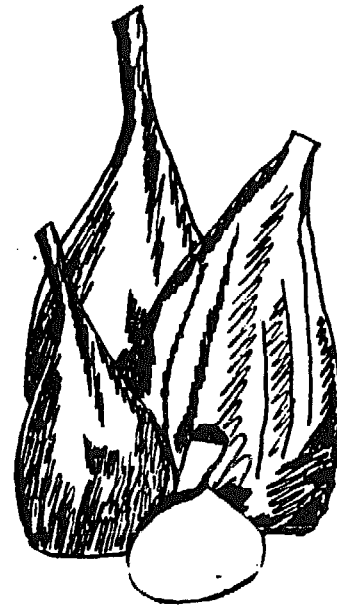

If gourd-shaped vessels made of clay or other local materials are available in your area, perhaps these can be made airtight in the same way.

Baskets made of local materials also can be made more airtight. Cover the baskets inside and out with mud plaster. Make sure the cover closes tightly. The outside of the basket can then be coated with a waterproofing or sealing material.

#### Possible advantages:

- . Useful for storing seed grain and smaller quantities for food.
- . Easy to get to the grain and to check for insects.
- . Easy to label, so the farmer knows what kind of grain is in each container.

#### Disadvantages:

Gourds do not hold large amounts of grain.

### STORING GRAIN IN UNDERGROUND PITS

Farmers store grain in underground pits (holes) in many parts of the world. Pits are used for storing threshed sorghum and maize. They also are used for wheat, peas, and beans. In areas where pit storage is used, it has served farmers well as a way of avoiding theft of the grain (because the pits are hidden). Also, because the pits are dug deep into the earth, they keep the grain cool. In addition, some pits are relatively airtight.

However, pit storage is generally not a storage method to encourage a farmer to adopt. If a farmer is looking for a storage method, he is more likely to get airtight storage by using oil drums, plastic sacks, etc.

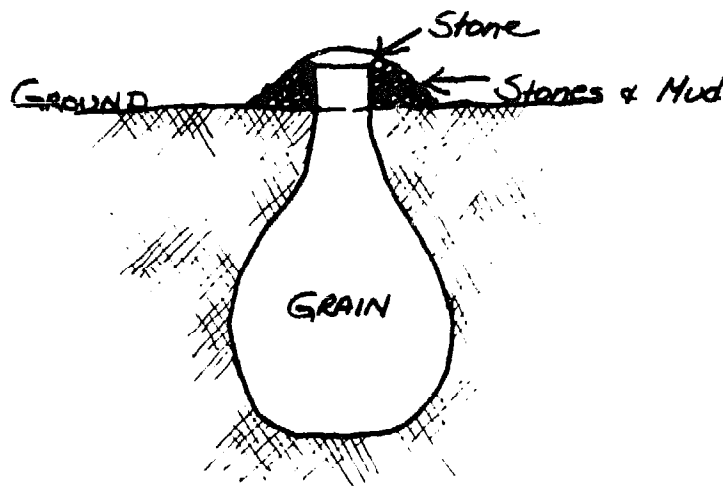

#### DRY PITS

There are many, many kinds of pits. The pits themselves are not always airtight or waterproof. Therefore, some farmers line the pits with straw to absorb moisture from the earth or from leaks in the covers. The straw gets damp and becomes moldy. These molds use up any air in the storage pit, so that any insects present in the grain die. Often in underground storage pits, the grain at the top and around the sides of the pit is moldy. The main part of the grain, however, stores well.

#### WET PITS

In some areas, farmers build wet pits. During the rainy season, the water in the ground may rise right into the pit. The grain in this case is full of water. But the grain respire more quickly when wet and uses up the oxygen. Insects and molds requiring oxygen die. Often these wet pits

## Storage Methods -48-

are built where cattle are kept because cow dung uses up oxygen as it decomposes. The grain kept in wet pits may ferment (sour) and thus is not good for seed. But often it seems to store better than grain kept in drier pits.

### IMPROVING PITS

The question to keep in mind here is whether or not an improvement in the traditional pit is wise or necessary. A farmer who does not open his pit often may have very light losses from insects and molds. In this case, making improvements may not be necessary.

However, in areas where farmers have lost a lot of grain stored in pits due to insects and molds, it may be a good idea to offer several suggestions for improving the pit storage. Pit storage can be made more safe by improving the covers, building shelters over the pits, or by using a lining in the pits.

#### Replacing Covers

Pit storage usually can be improved by replacing wood and mud covers with metal or plastic covers.

- . Use one large sheet of metal or plastic to cover the entire area.
- . Make a hole in the middle of the large sheet. This is so grain can be taken out. Cover the smaller hole with a piece of of the same material.
- . Seal the entire cover with a mixture of mud or dung or with bitumen.

#### Building Shelters

Some farmers build shelters over the pit stores. The shelters should be movable so that when the sun is shining, the pit can be exposed for drying. The shelter should be used when it rains. The problem with this type of shelter is that the farmer cannot keep the place of the pit a secret and the grain may be taken by thieves.

### Improving Pit Linings

The other area where pits can be improved is the lining used in the pit.

#### Straw and Mat Lining

- . Put down a layer of straw on the pit floor. Cover the straw with mats made from bamboo or local grasses.
- . Line the walls with straw and matting as well.
- . Pour in dry grain to the top of the lining.
- . Continue placing the lining and pouring the grain until the pit is full.
- . Seal the pit.

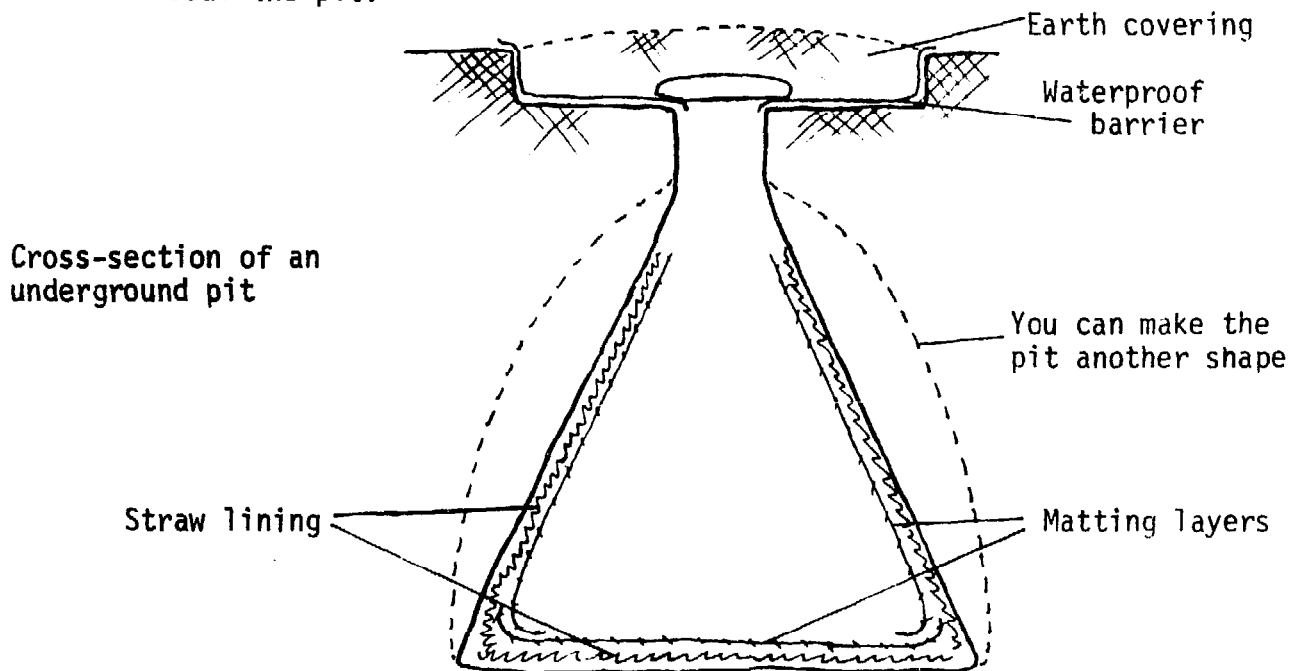

**Advantages:** Uses local material and costs nothing.

Stores grain much better than an unlined pit.

**Disadvantages:** Does not protect the grain as well as the following methods.

## Storage Methods -50-

### Plastic Bags

- . Place very dry grain in plastic sacks.
- . Seal tightly as shown.
- . Store sacks in the pit.
- . Seal the pit well.

#### Advantages:

Airtight if the bags are well sealed.

A farmer can remove part of the grain easily without letting air and moisture into the rest of the grain.

#### Disadvantages:

May be expensive or hard-to-get.

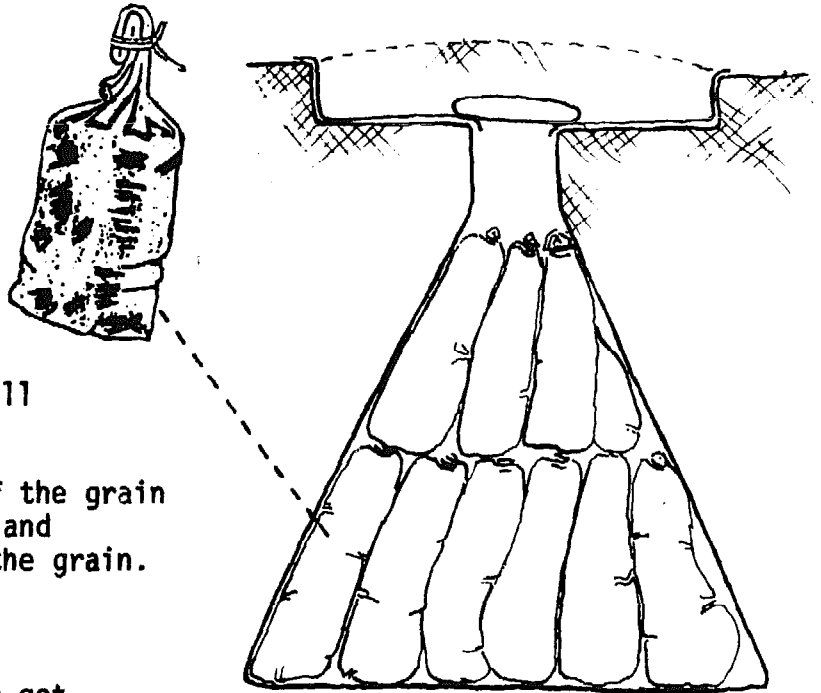

### Plastic Lining

- . Line the pit with large plastic sheets or with plastic bags cut open to make sheets.
- . Make sure the edges of the plastic sheet lie over each other.
- . Fill the pit with clean, dry grain and seal tightly.

**Advantages:** Gives good protection from moisture if the plastic is sealed.

**Disadvantages:** Can be damaged easily.

Plastic may be expensive, unavailable, and hard to replace.

## Storage Methods -51-

### Using Plastic Lining and Plastic Bags in Large Pits

- . Lay plastic sheets or cut-open plastic bags on the floor.
- . Fill a number of plastic bags with very dry grain and put these against the sides of the pit.
- . Pour dry grain into the space between the floor and the tops of the sacks.
- . Put another layer of filled plastic sacks against the walls on top of the sacks already in the pit.
- . Fill the space with grain.
- . Continue placing plastic sacks against the sides and pouring in grain until the pit is full.
- . Cover the top of the grain with plastic.
- . Seal the pit in the usual way.

Advantages: Keeps most of the grain very well.

Stores large amounts of grain.

Disadvantages: May be hard to find plastic.

May be expensive.

Loses some grain because it falls down between the bags and the walls of the pit.

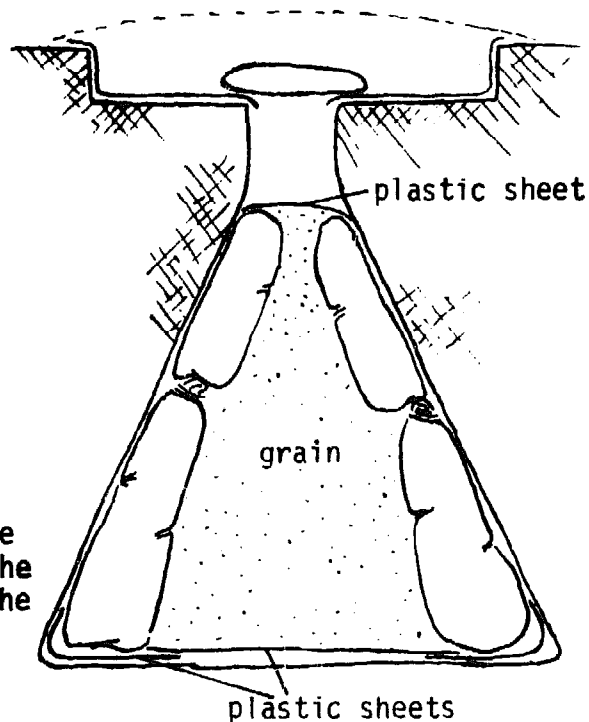

### Concrete Linings

There has been work done on various concrete linings for underground pits. Because this method requires more labor, material and money, it is not as easy for a small farmer to use. However, it will be outlined in more detail in the part of this manual which discusses ferrocement.

### STORING GRAIN IN PLASTIC SACKS

Plastic bags make good airtight storage containers.

- . Use plastic bags which are .20 to .25mm thick (500-700 gauge).
- . Make sure there are no holes in the plastic. Even the smallest hole will cause problems.
- . Some insects can puncture plastic when trying to escape from the sack. But this can be stopped by putting a cloth bag of tightly woven cotton inside the plastic bag. The cloth is added protection.
- . Use grain which is very dry.
- . Add insecticide to the grain. It can take a week or more for insects to use up the oxygen which is in the bag.
- . Fill the sacks and seal them tightly.
- . Store the filled bags off the ground on a smooth surface so that they will not be punctured by the floor or anything sharp.

**Advantages:** Plastic bags are easy to store.

Plastic bags are easy to move around.

They provide good protection against insects.

Plastic bags make good containers for fumigating small quantities of grain.

**Disadvantages:** Plastic can be torn or punctured easily.

They are generally good for only one year and must be replaced after that because small holes have been made in them.

Rodents can eat through plastic.

Plastic bags are expensive in some area.

The following leaflet, prepared by VITA artist, Ken Lloyd, is designed to show farmers a good procedure for storing dry grain in plastic sacks.



1

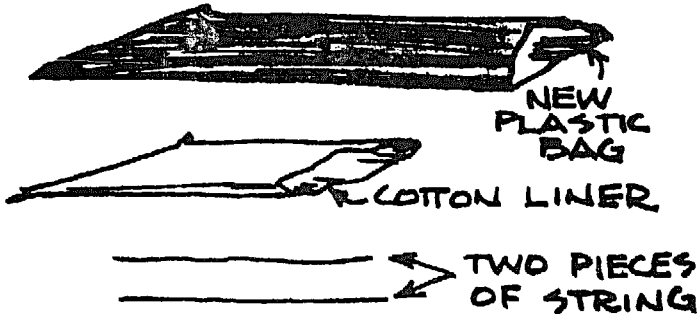

MAKE SURE THERE ARE NO HOLES IN THE BAG.

3

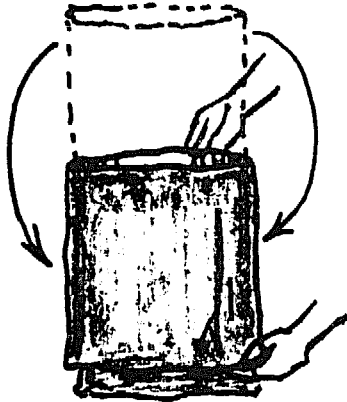

4

PUT COTTON LINER INSIDE THE PLASTIC BAG.

5

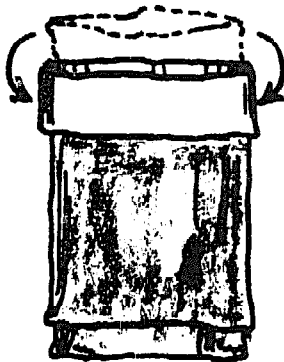

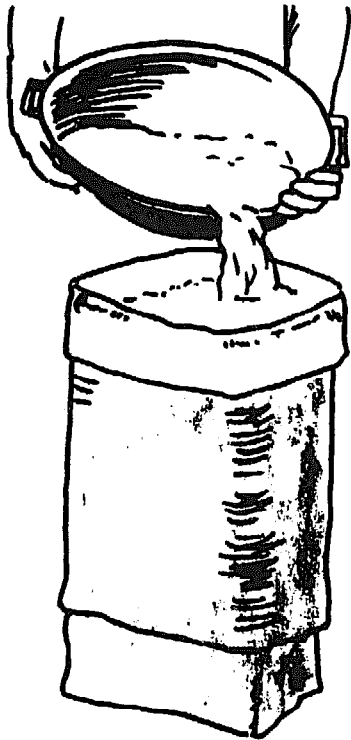

⑥ ALMOST FILL UP WITH GRAIN.

⑦ FOLD THE COTTON BAG OVER THE TOP OF THE GRAIN. TIE WITH A STRING.

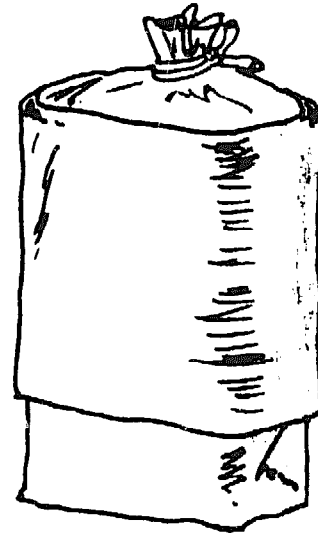

(MAKE SURE THERE ARE NO SEEDS BETWEEN LINER AND PLASTIC BAG.)

⑧ DRAW BACK THE PLASTIC CUFF

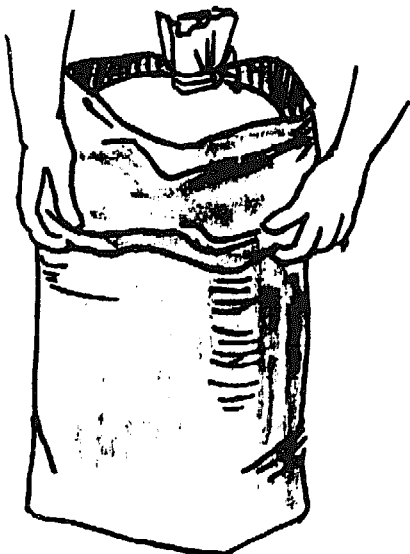

⑨ SQUEEZE PLASTIC TIGHTLY ABOVE THE TIED COTTON BAG TO PRESS AIR OUT.



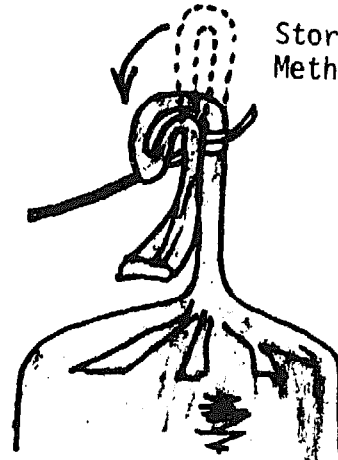
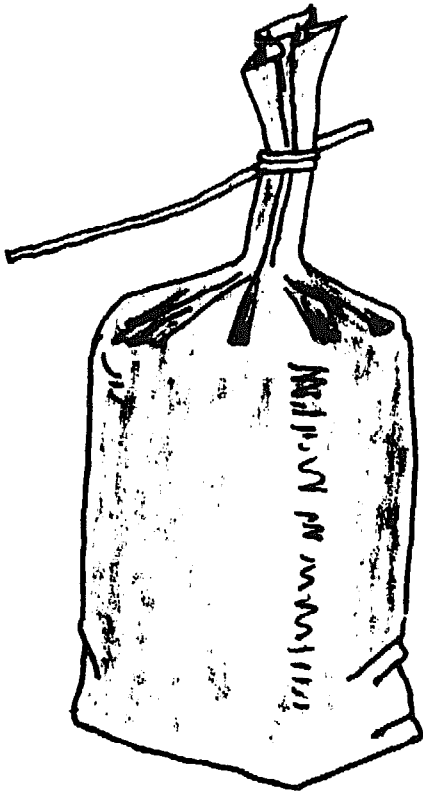

- ⑪ FOLD UP THE SURPLUS PLASTIC AND THEN BEND THE FOLD BACK ON ITSELF.

- ⑩ DOUBLE TIE IT.



- ⑫ TIE THE TWO HALVES OF THE FOLD TIGHTLY TOGETHER.

### STORING GRAIN IN METAL DRUMS

In many parts of the world, 220-litre oil drums are available and not too expensive. If farmers in your area can find oil drums, this is a storage method which may be a good improvement.

Sorghum, maize, millet, cowpeas, and groundnuts are among the materials which can be stored successfully in these drums. The grain should be dry (12% moisture or less) when it is put into the drum.

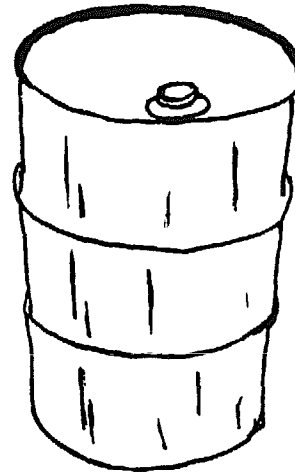

Here is the procedure for using a drum:

- . Make sure the drum is clean and dry inside.
- . Check for holes. Holes in these drums can be plugged with wax.
- . Pour clean, dry grain into the drum through the small top opening. Use a wide-mouth funnel to help with this job.
- . Shake the drum to let the grain settle; then fill it again.
- . Make sure the drum is full.
- . Screw the cap on tightly. If the rubber ring on the inside of the cap is missing, smear the cap with grease.

Each drum holds about 660kg of grain.

Advantages: Provides good airtight storage control of insects.

Protects the grain from rodents.

Works well for seed grain; does not seem to hurt the ability of the seed to germinate.

Is available in most areas and is not expensive.

Makes a good container to fumigate grain in.

## Storage Methods -60-

**Disadvantages:** Has a small opening for filling and emptying.

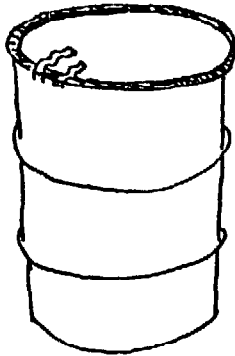

Special clamp-on lid is sometimes available. But this lid does not create airtight conditions and insecticides must be used.

Works best when grain is being stored 5 months or more.

Has to be kept out of sunlight to prevent moisture changes and heating in the stored grain.

Can rust and must be repaired carefully for airtight storage to be continued.

## STORING GRAIN IN METAL BINS

Metal bins are being tried for small-scale use in many parts of the world. In some areas, farmers can buy metal bins in different sizes. They are sometimes expensive, and they rust in moist areas. Often a farmer needs to be a member of a credit program to get the money to buy this type of metal silo or bin. Then he repays the money for the cost of the bin. Hopefully, the bin pays for itself by reducing losses to the stored grain due to attacks by insects and rodents.

Metal bins can also be built quite easily: but the farmer must know how to weld and work with metal. Or someone with these skills must be able to help.

### CHARACTERISTICS OF METAL BINS

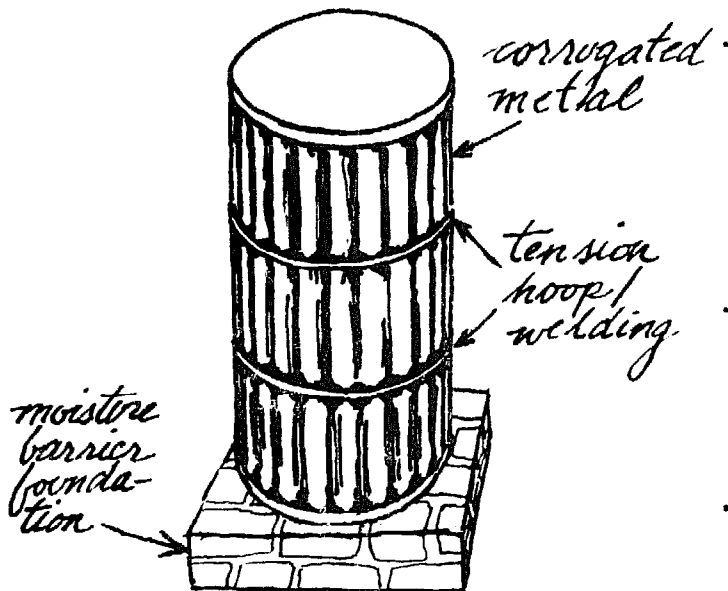

Built above the ground -- either on platforms or on cement bases when kept outside. The metal bottoms will rust because of contact with ground water if the bins are on the ground.

- . Rounded in shape to hold the pressure of the grain better: a square bin would have more seams and be more likely to break open.
- . Painted white or stored out of the sun because metal conducts (passes on) heat very well.

### Advantages of Metal Bins

- . Good control of insects, molds, and rodents if bins are well-made, well-sealed, kept off the ground, and out of the sun.
- . Small metal bins are lightweight and may be moved easily.
- . A metal bin may pay for itself out of the farmer's increased profit. This is true (for all improved storage methods) only where initial costs are not too high or a good credit program is available.

Disadvantages of Metal Bins

- . Metal sheets for building the silo are more expensive than most locally available materials, or, in some areas, cement.
- . Construction of a bin requires special equipment to cut and weld the metal and people trained in working with metal.
- . Metal rusts quickly in hot, wet places. Sheet metal for bins must be galvanized or painted regularly to protect the metal from rusting. This is another cost to the farmer.

Blacksmiths and people with metal-working experience, who might be interested in making bins to fit local needs, should be encouraged to try to do so. Experimenting with various designs will give information which can help you decide what kind of metal bin will work best in your area.

The following information on various metal bins is provided to give some idea of what types of bins are available. Wherever possible, an address is included so that you may write for further information.

CIRCULAR STEEL BIN

The bin shown here is very useful for storing small quantities of grain indoors. It can be made in four sizes, ranging from 500kg to 3 tons. The chart included here gives the dimensions for each size of circular steel bin.

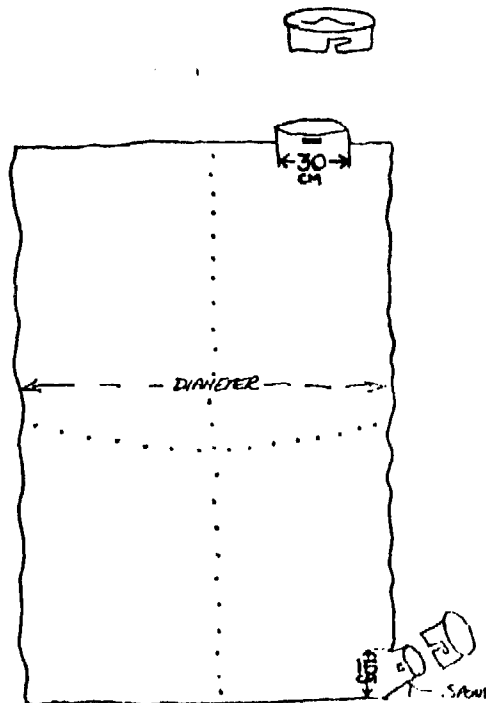

Description

- . Opens at the top for filling and has a spout at the bottom for emptying.
- . Has a flat top and bottom made of plain Mild Steel sheets.
- . Has circular sides made of corrugated Mild Steel sheets.
- . Comes in 4-6 pieces which can be put together on site. The bin can be taken apart when not in use and put back together when it is needed again.
- . Prevents uneven temperatures within the bin by building-in a special arrangement.
- . Uses neo-prene washers with bolts to make the bin airtight.
- . May be used for fumigation, as required.
- . Can be made in any small sheet-metal workshop.
- . Stores grain to be used for seed safely.

Capacity	Height (cm)	Diameter (cm)	Gauge Steel Sheet
500kg	125	80	28
1 ton	165	100	26
2 ton	210	124	24
3 ton	210	150	24

For further information on this and other bins which might be of use to small farmers in your area, please write to:

The Grain Storage Research & Training Center  
 Department of Food  
 Government of India  
 Hapur, Uttar Pradesh  
 India



## Storage Methods -64-

### METAL BINS FOR HOME USE

A "Save Grain Campaign," begun in India in 1965, resulted in a number of metal bins which were designed specially for use in the home and on a small farm.

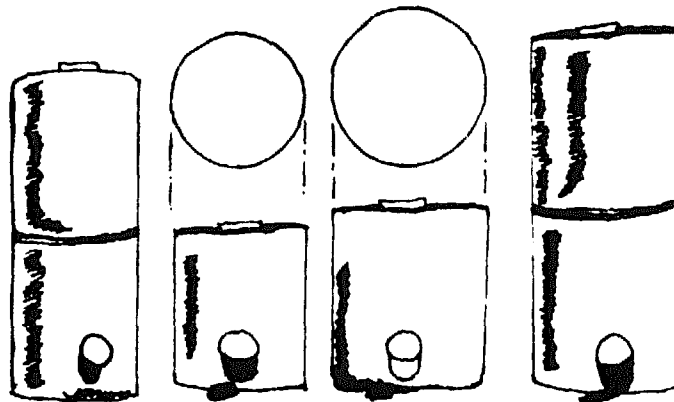

Two styles of bins are pictured here. Each bin is pictured in two sizes. The following chart shows how many kilograms of paddy, maize, or wheat each size of bin can hold.

CAPACITY Cubic Meters	PADDY* kg	MAIZE** kg	WHEAT*** kg
0.42	230	300	315
0.68	375	485	510
0.82	450	580	615
1.35	745	960	1015

\* Approximately 550kg per cubic meter

\*\* Approximately 710kg per cubic meter

\*\*\* Approximately 750kg per cubic meter

The specifications and technical drawings for these bins are available in booklet form from:

Save Grain Campaign  
Ministry of Agriculture  
Department of Food  
Krishi Bhavan  
New Delhi, India

### SHEET METAL SILO

This silo was developed by the Institute of Tropical Agriculture Research in Benin (formerly, Dahomey), Africa. It is a good example of an easily made metal storage container.

The model below is made of sheet metal, 1mm thick, welded together at the seams. It has two openings, one for filling at the top of the bin and one for emptying at the bottom. The cost of the 3 ton model shown here is about \$175 (U.S. currency) when manufactured in small numbers.

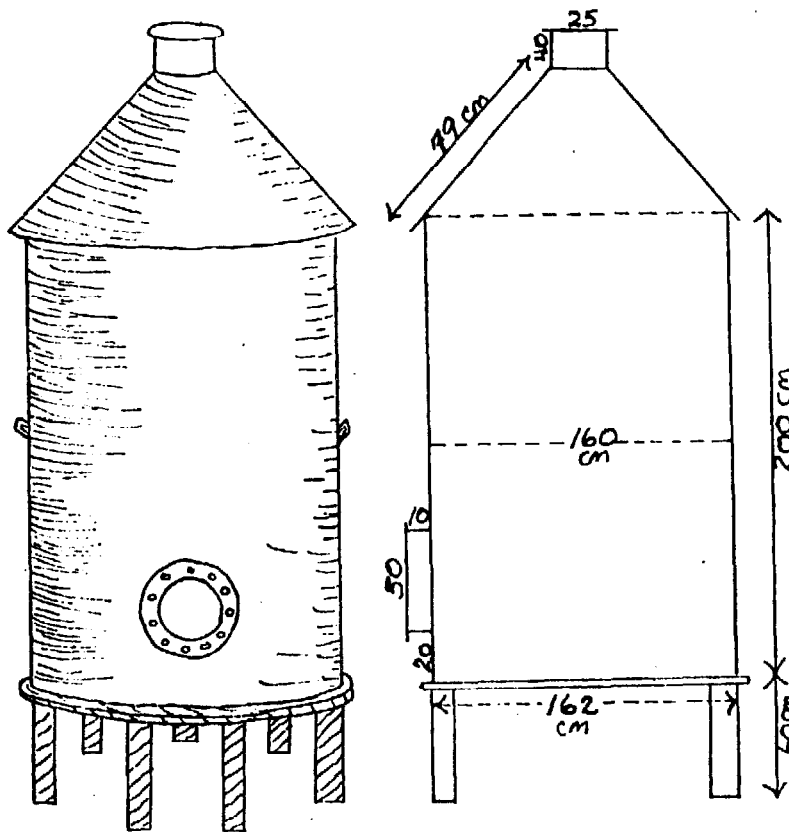

## FUMIGATION OF SMALL QUANTITIES OF STORED GRAIN

Fumigants are insecticides in the form of gas. This gas can kill adult insects living outside the grain kernels and larval stages living inside the kernels. Once the gas disappears from the grain, there is no more protection against insects.

BECAUSE FUMIGANTS ARE GASES, THEY MUST ONLY BE USED IN CONTAINERS THAT WILL NOT LET ANY OF THE GAS GET OUT. THIS GAS CAN KILL HUMANS AND ANIMALS AS WELL AS INSECTS.

# Phostoxin

The easiest and safest fumigant to use is Phostoxin. In many areas, Phostoxin is relatively expensive. You can buy it in the form of tablets or pellets. These formulations only start to turn into gas when they are taken out of their containers and placed in the air. When the moisture from the air touches the tablets, the gas begins to form. Phostoxin containers must always be tightly sealed when not being used.



*Decomposition of a Phostoxin Tablet*

It is not a good idea for a farmer to use Phostoxin himself -- unless he has used it before, and you are sure he understands the use of this fumigant. But you should know how to use Phostoxin so that you can instruct and help the farmer fumigate his grain.

So the following pages present fumigation procedures which will be most helpful to the small-scale farmer: fumigation for stacked grain sacks; fumigation in plastic bags; fumigation in small metal bins, silos, and oil drums.

**REMEMBER: WEAR GLOVES WHEN YOU USE PHOSTOXIN.**

**KNOW WHAT TO DO IN CASE OF AN ACCIDENT.**

**KEEP ALL PEOPLE AND ANIMALS AWAY FROM THE AREA WHERE FUMIGATION IS BEING DONE.**

### FUMIGATING GRAIN IN PLASTIC BAGS

- Use 1 pellet of PHOSTOXIN for each 100kg of grain.

Tablets contain more poison than pellets; 5 pellets are equal to 1 tablet. If you cannot find pellets, you can cut one tablet in 4 pieces. Therefore, one tablet will fumigate 4 bags of grain. CUTTING PHOSTOXIN TABLETS IS DANGEROUS AND MUST BE DONE VERY CAREFULLY.

You must be sure there are no little pieces of the tablets lying around after you cut. If there are pieces, drop the pieces into a large pail of water which has soap in it. Do this outside in the open air. The gas will cause bubbling in the water. When the bubbles disappear, you can throw the mixture away.

- Use heavy gauge (500 gauge) plastic bags.
- Make sure the bags have no holes or tears. Mend any holes with tape.
- Fill a bag with grain.
- Put the pellet of Phostoxin in an unsealed envelope or piece of paper and place the packet on top of the grain in the bag.
- Close the bag and tie as shown.

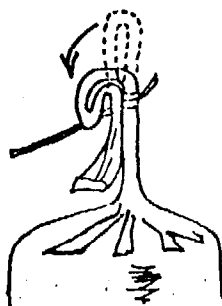
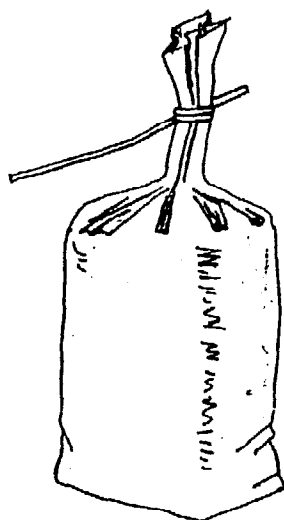

FOLD UP THE SURPLUS  
PLASTIC AND THEN  
BEND THE FOLD BACK  
ON ITSELF.

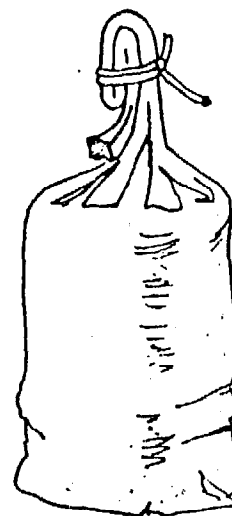

- . Place a warning on the bag so no one will touch or open the bag.
- . Leave the bag as it is for at least 5 days. It is even better to keep the grain in the bag tightly sealed until it is needed. Gas cannot protect against new attack, but once fumigation has killed any insects present, the plastic bag will maintain airtight storage conditions which will control insects.

NOTE: PHOSTOXIN may be expensive and may not be available in all areas. Check with your extension agent for information on other insecticides which might be useful for you to use on your stored grain.

Storage Methods -70-

FUMIGATING SACKED GRAIN UNDER PLASTIC SHEETS

- . Use PHOSTOXIN.

3 tablets per 25 45kg bags or 1,125kg of sacked grain

OR

15 pellets per 25 45kg bags or 1,125kg of sacked grain.

- . Use fumigation on bags made of jute or fiber. If using plastic bags, make sure the bags are open before fumigation begins.
- . Stack the sacks on the floor on a sheet of plastic, unless the floor is concrete. Do not fumigate directly on the ground because the soil will be temporarily poisoned by the fumigant. If the fumigating is being done outside, stack the sacks on a large sheet of plastic. Make sure the plastic is larger than the grain stack on all sides.
- . Take a 500 gauge plastic sheet. The sheet must be large enough to cover the stack completely and be held to the ground tightly. If necessary, you can overlap and tape smaller sheets together to make a large enough sheet.
- . Check the sheet to make sure there are no holes in it. You can do this by holding it up to the light. Mend any holes or tears with tape.
- . Spread the right number of tablets around the sacks. Spread the tablets around so that they do not touch each other.
- . IMMEDIATELY COVER THE STACK WITH THE PLASTIC SHEET.



- . Make sure the edges of the sheet are sealed tightly. Use loose sand, sand bags, poles, etc. to hold the sheet down.

- . Keep the doors and windows open if you are fumigating inside a building. (This is of course true only when you are fumigating under a plastic sheet inside a building -- not when you are fumigating an entire building. In this case, you would want to close the doors and windows tightly.)
- . Do not let anyone enter the fumigation area.
- . Leave the stack under fumigation for at least 5 days. Some PHOSTOXIN users prefer to remove the sheet while wearing a gas mask. But a gas mask is not necessary, if you follow these simple suggestions: lift the plastic sheet at one corner using a long pole. This means that if there is any gas still under the sheet, it will not hit you in the face when you lift the cover. Leave the stack as it is, with the one corner lifted up, for 1 or 2 hours.
- . Remove the plastic sheet after 1 or 2 hours if there is no strong smell.

NOTE: One characteristic of PHOSTOXIN which makes it relatively safe for farmers to use is the very strong smell associated with PHOSTOXIN. The smell, which starts being released almost immediately, is a good warning to users because the smell is noticeable before the gas reaches a poison strength which can kill or hurt people.

FUMIGATING STORED GRAIN IN SMALL METAL  
CONTAINERS OR SILOS

- . Use 3 tablets or 12 pellets of PHOSTOXIN for each 4,400kg.
- . Make sure the emptying chute and filling holes are sealed. A thick coating of grease will make a good seal.
- . Check to make sure bolt holes and seams of a water-tank bin are sealed. You can seal these with bitumen or melted wax if you are not sure they are tight.
- . If the grain level in the bin is no more than 6m, you can spread the tablets only on top of the grain.
- . Spread the tablets as you pour in the grain only if the grain can be sealed up within 4 hours. Remember to place the tablets in an open envelope. In a larger silo, you can build up the grain to a level of 5m and then start putting in tablets. Continue putting in grain and tablets until finished. Start counting 4 hours from the time the first tablets are put in.
- . Seal the manhole just as soon as all the grain and tablets are inside.
- . MAKE SURE THE MANHOLE IS TIGHTLY CLOSED. USE A THICK COATING OF GREASE, WAX, OR CEMENT MORTAR TO SEAL IT.
- . Leave the silo unopened for at least 5 days. If the grain is not needed, keep the container sealed until the grain is needed.

WARNING! YOU MUST HAVE THE MANHOLE SEALED WITHIN 3 or 4 HOURS OF ADDING THE FIRST TABLET OF PHOSTOXIN. PHOSTOXIN GAS CAN KILL.

NOTE: Metal drums are good containers in which to fumigate grain. Simply drop in the correct number of pellets for the size drum, seal it tightly, and wait for 5 days.



## STORING IN EARTHEN STRUCTURES

Farmers for thousands of years have been storing grain in bins and other containers made of clay. Earth is available and easy to use.

More recently, there has been interest in improving mud granaries to make them more airtight and waterproof. This is especially important in areas where insecticides are hard to get and where there is a lot of rain.

The Pusa Bin, which is discussed here, was developed in India. It is made of mud bricks. The walls are made by sealing a layer of plastic sheet between two layers of mud bricks. The mud bricks protect the plastic from holes. The plastic keeps air and moisture out.

### Advantages:

- . It is an airtight storage structure.
- . The materials are often available locally.

### Disadvantages:

- . Plastic sheets are sometimes hard to get or expensive.
- . It must be protected from rain by a separate roof.
- . Sealing the plastic sheets may be a problem for a farmer.

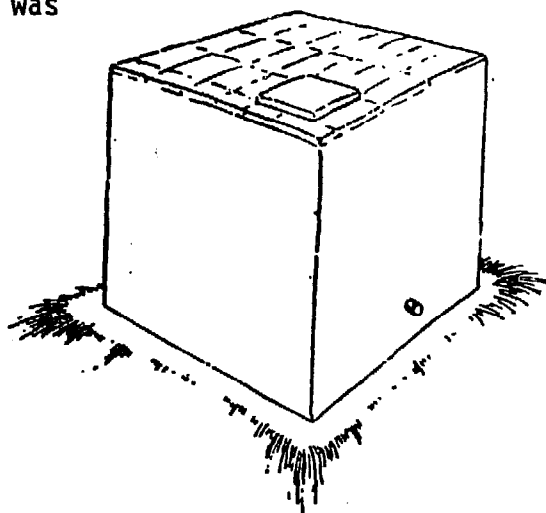

### THE IMPROVED MUD BLOCK SILO

The other plan presented here is the improved mud silo, and is based on a plan prepared in Ghana. VITA artist, George Clark, provided the illustrations.

The silo is made of mud bricks. This silo was improved by plastering and painting the walls. Plaster is usually composed of cement, lime and sand. Mud plasters also can be used. Both mud and plaster may not stick to the brick walls for long periods of time. Mud plaster sticks better for a time, but heavy rains can wash it away. Efforts have been made to mix the mud with a stabilizer such as cement, or bitumen; this seems to work. Also, to make the plaster stick better, small stones can be added to the mud used to make the bin walls.

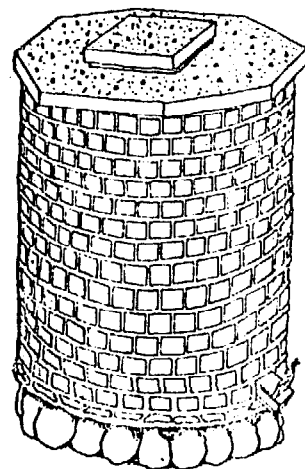

Local material also can be used to paint and coat the outer walls. Some materials which can be tried on the walls are:

asphalt	resins
organic oils	ox-blood
paints	

These coatings last only a year or so, but they are cheap, available, and easy to put on. See Appendix D for information on how to find and use local materials to waterproof soil construction. When looking for a coating for an improved mud silo, the farmer should remember he is looking for a material which:

- . is water-repellant.
- . sticks to the walls.
- . lasts long enough so he does not have to re-apply often.

The improved mud silo presented here has the following advantages and disadvantages:

#### Advantages

- . The materials are cheap.
- . Airtight storage can be achieved or nearly achieved. If the farmer is not sure the silo is airtight, he can add insecticide to the grain.

- . The emptying chute allows small amounts of grain to be taken out without unsealing the top of the bin.
- . It can be made in a number of sizes.

Disadvantages

- . It requires regular painting or whitewashing.
- . It may not be water-tight to prevent grain rewetting.

Since these earthen structures seem to be more easily made by small farmers than the metal bins, the construction plans are given in more detail. The mud silo presentation includes a set of instructions for use of the silo.

### THE INDIAN PUSA BIN

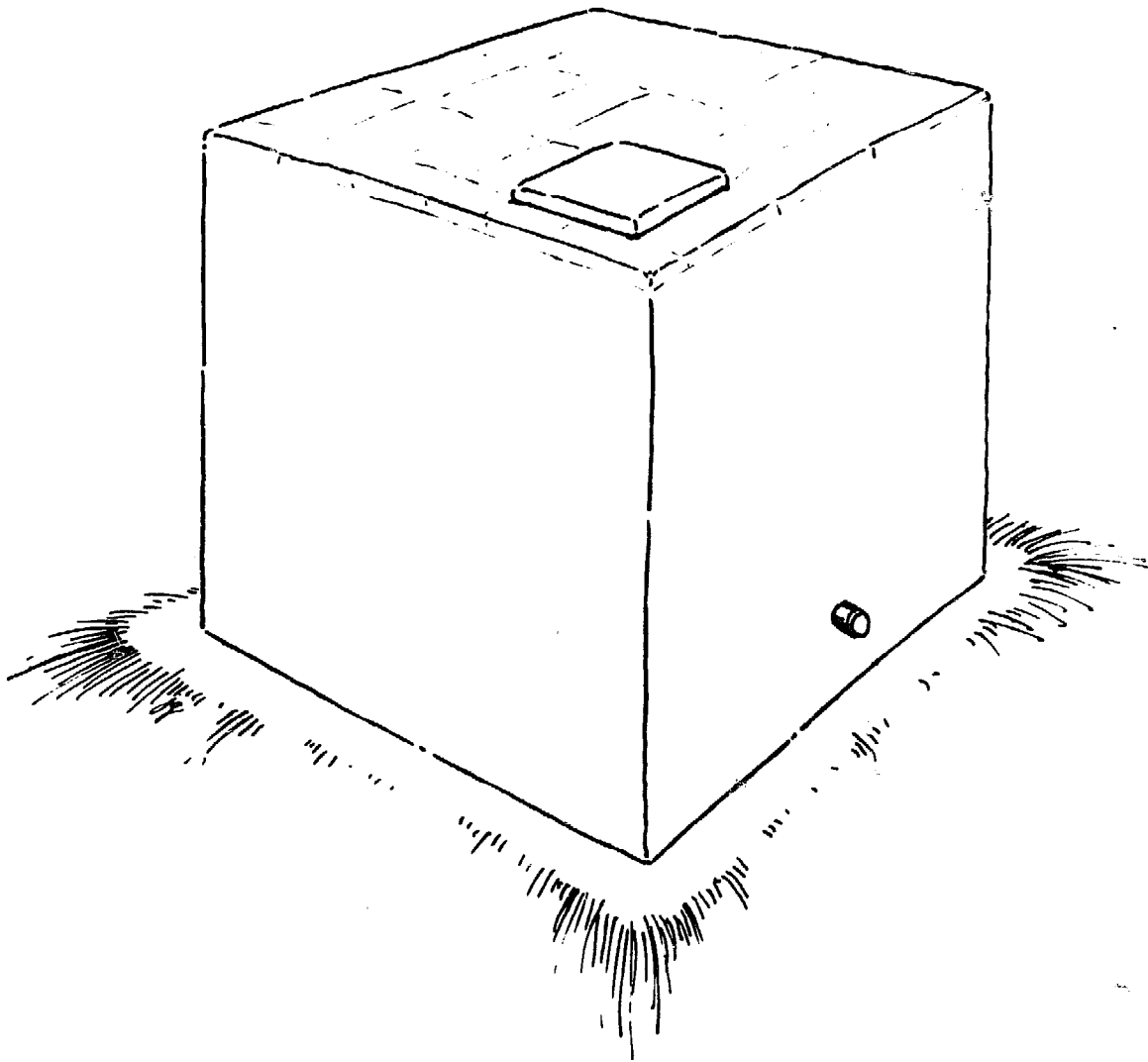

The Pusa Bin was developed in India by members of the Agricultural Research Institute in New Delhi. It is relatively simple and inexpensive to construct and maintain. This bin is double-walled all the way round -- including the floor and roof --, with a separating layer of plastic sheet. The plastic protects against moisture and keeps air from entering the stored grain.

Protect the bin from rain. If the bin is not erected under a shed and it rains often, it will require too much repair and rebuilding, and the grain may get wet and mold. However, complete shading from the sun is not necessary because mud walls do not hold heat. This is one advantage of a mudblock structure over a metal bin.

In India, rats cause great storage losses. For this reason, in this plan the bottom 50cm of the outside wall and the first layer of the floor slab are made of fired, or "burned", bricks. These bricks are harder than un-fired bricks, like mudblocks, and rats and mice cannot gnaw through the bin walls or burrow up underneath the floor to get to the grain. Another way to keep out rats and mice is to use sheet metal over whatever kind of non-hardened material you use, in the same places.

This plan uses an insulating layer of plastic sheet. The Pusa Bin is airtight and waterproof only if the plastic sheet is made and used correctly. The plastic sheet used should be at least 700-gauge thickness, to resist tears and punctures.

If plastic sheet is not available or if it is too expensive, some other form of waterproofing will be needed in warm rainy areas. Check out what is available locally. Tarfelt -- heavy paper impregnated with tar -- can be used. Experiment with bricks containing cement. Try painting the bin with asphalt, coal tar or any other local waterproofing substance. See Appendix D, "Waterproofing Soil Construction." Remember, the bottom of the bin must be waterproofed to stop migration (seeping) of moisture from the earth below.

This plan is for a 2 metric ton bin. You may vary the size of the bin to fit your needs. Make sure you build a strong enough roof support frame for larger bins.

### READ THE INSTRUCTIONS THROUGH BEFORE YOU BEGIN

#### Tools and Materials

- . mudblocks and mud mortar for the walls. If you make blocks 10 x 10 x 20cm you will need about 900-1000 of them.
- . wood to make a form for making mudblocks
- . fired, or "burned," bricks, concrete bricks or bricks of some other hard, rat-proof material for the floor and lower 50cm of the walls. You will need about 250 of them.  
OR  
some sheet metal to cover mudblocks for the same purpose. You will need 6-6 1/2 square meters, allowing for overlapping of sections. If you use sheet metal instead of hard bricks, add 250 mudblocks to the number given above.
- . cement mortar if you use fired bricks
- . about 9 square meters of 700-gauge plastic sheet for moisture-proofing the bin. Or the same area of tar-paper, or a suitable amount of waterproofing material to give a good, thick coating or several coatings.

- . a piece of iron bar to heat and seal seams in the plastic
- . wood or another strong material for making a roof support frame
- . sheet metal or plastic pipe for an emptying spout. Coated wood will also work.
- . some wax or similar material to seal some joints
- . mud for making roof slabs

1. Select a site.

- . Choose a place that is as high and dry as possible. It is better to build up the earth a little for extra protection against collecting rainwater. Level and firmly tamp down the earth.
- . Make the foundation area at least 1 1/2 x 2m.

2. Make mudblocks.

- . Use the hard earth beneath the topsoil to make mudblocks. If the soil in your area does not have a high clay content, you may be able to mix a little cement in with low-clay soil to make good mudblocks.
- . A wood form can make several mudblocks at a time.
- . If you use blocks measuring 10 x 10 x 20cm you will need about 900-1000 mudblocks. If you are going to use sheet metal instead of fired bricks to protect against rats and mice, add 250 more.

3. Make the floor of the bin.

- . Lay down a platform of fired bricks or other hardened bricks, and cement mortar, measuring about 120 x 160cm.  
OR  
Lay down a layer of sheet metal and place a layer of mudblocks and mud mortar on top of it, to the same measurements. Use flattened kerosene tins or any available sheet metal. Overlap all the pieces. Make the outside edges stick out about 15cm beyond the outside edges of the block platform that will be laid on top of it.
- . Allow about 1cm thickness of mortar between either kind of brick, for a good bond.

- . Place a layer of plastic over the bricks, or whatever water-proofing material you are using. It should extend a few centimeters beyond each edge of the layer of bricks.
- . Lay down a layer of mudblocks and mortar on top of the plastic, the same size as the first brick layer.

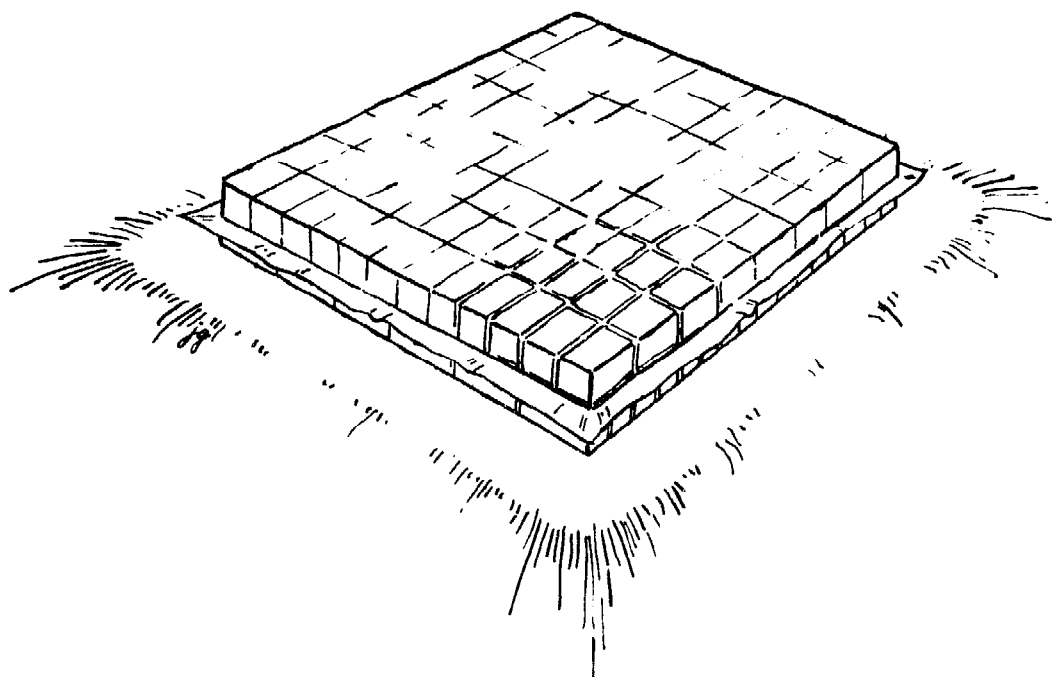

#### 4. Build the inner walls.

- . The inner walls may be made entirely of mudblocks and mortar.
- . Make the outside edges of the walls the same as the outside edges of the floor.
- . Build an emptying spout into the first layer. Form something like galvanized tin into a tube about 9 or 10cm in diameter, or use a plastic pipe the same size. Fit one end flush against the inside of the wall. Make it long enough to extend past where the outside edge of the outer wall will be. You may tilt it downwards slightly towards the outside for easier exit. Mortar it into the wall. You will need a tight-fitting cap on the end of the spout.

- . Lay the blocks so that each one crosses over a joint between blocks in the layer below it. This will make the walls stronger.
- . Build the walls to a total height of about 160cm -- but wait until installing the roof support frame (next step) before putting in the final layer.

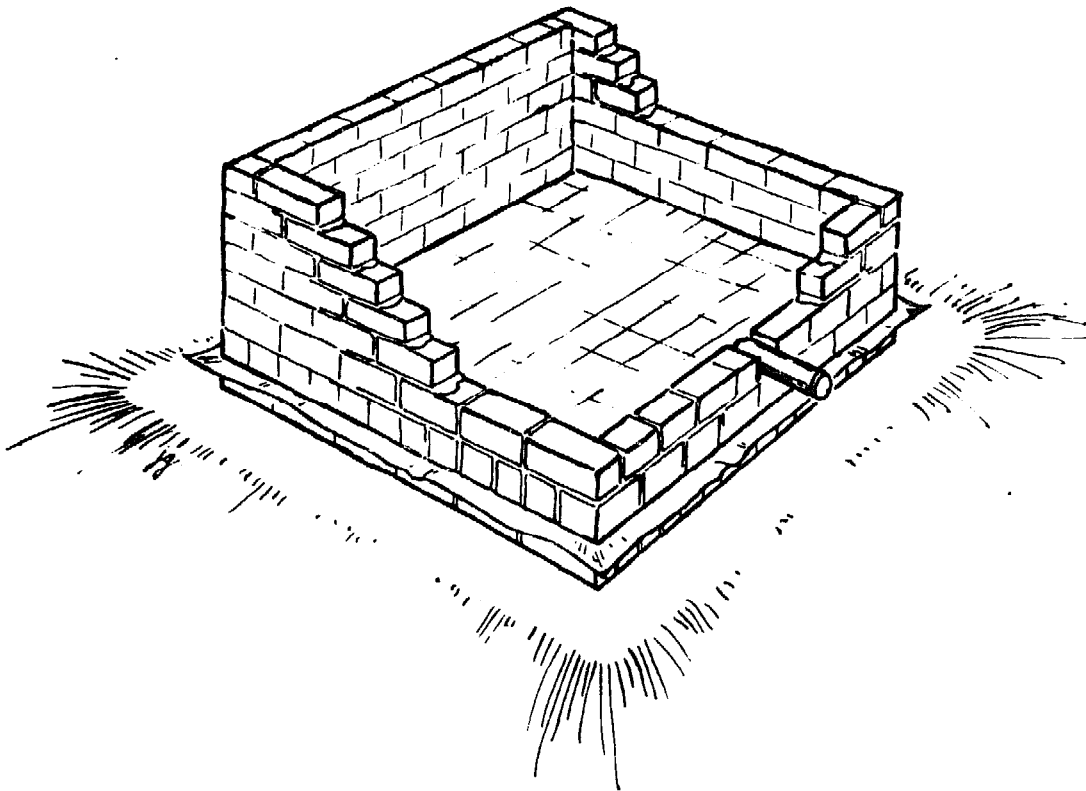

5. Install a roof support frame.

- . Use wood that is naturally termite proof, or coat it with something to protect it against these and other insects. Metal or reinforced concrete bars can be used, but they will be more expensive. The roof must have strong support: use the best available material.
- . Use four pieces as long as the distance between the outside edges of the inner wall -- two pieces about 120cm and two about 160cm. Wood should have at least a 5 x 5cm cross section.



- Form the frame in a double-cross pattern. Interlock wood joints. One of the corner spaces should measure about 50 x 50cm, for a manhole entrance.

- Position the frame on top of the next-to-last layer of blocks in inner wall. Raise the ends up on some mortar so the top surface of the frame will be at the same height as the top surfaces of the final layer of mudblocks.

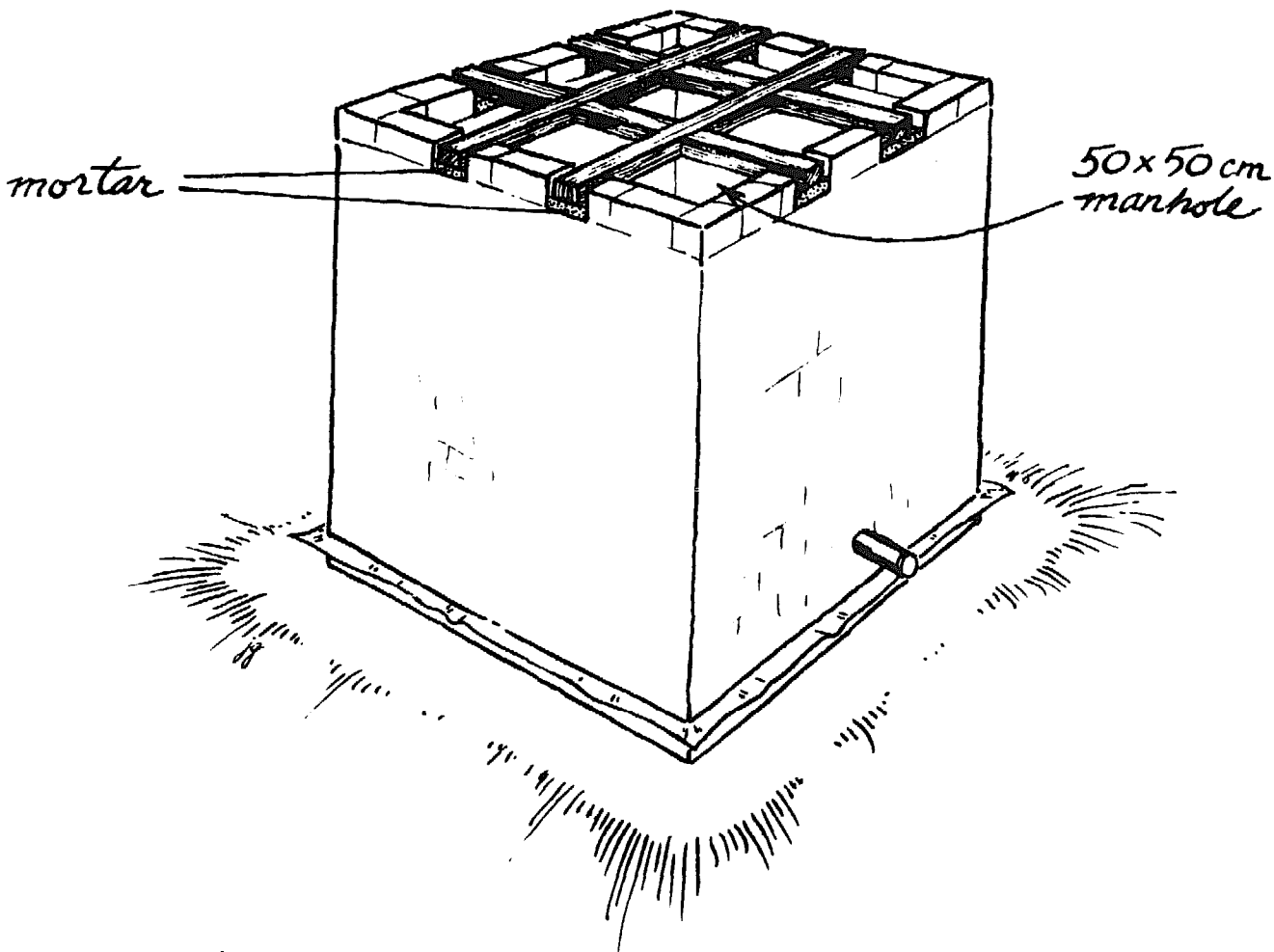
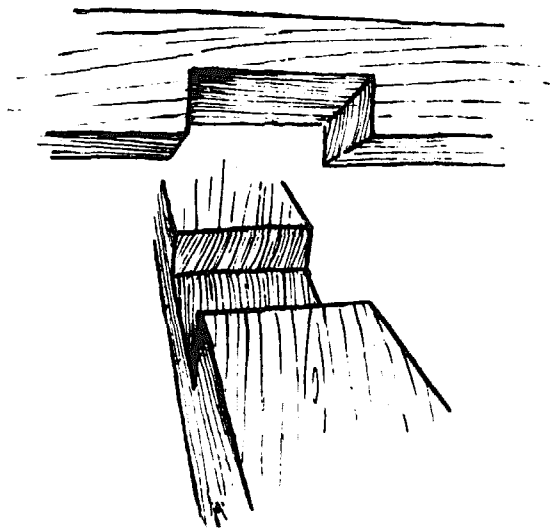

- . Mortar the frame and the blocks for the top layer of the wall into place. Make a smooth top surface on the walls.

6. Build the inner roof.

- . Make mud slabs 5cm thick for the inner roof.
- . You may make one or more to cover each space in the support frame, depending on how strong the slabs are. They will have to support another layer of mud slabs the same thickness when the bin is complete. It would be best to extend them to the outside edges of the inner wall for firm support. Sections of tightly stretched wire mesh fastened to the support frame would provide extra support for the slabs.
- . Position the slabs on mortar applied to the support frame and the tops of the walls. Leave the 50 x 50cm manhole open.
- . Fill any spaces between the slabs with mortar.

7. Plaster the inside.

- . Plaster the insides of the walls and the roof, and the surface of the floor with a smooth coating of mud or mortar. This will leave no place for insects or dirt to lodge.

8. Make and install a plastic cover.

- . Measure the outside dimensions of each of the four walls and the roof.
- . Cut pieces of plastic sheet to cover each of the five surfaces. Each piece should be cut a little larger than the surface which it will cover -- at least 5cm overhang on each edge. The bottom edges of the sides must reach a few centimeters beyond the plastic sticking out from the floor.
- . Fasten the pieces together in a box shape. Keep in mind the right arrangement of pieces so that when the cover is placed over the bin it will fit.
- . Seal the edges of the plastic together with a heated piece of iron bar. Lay one edge over another and pass the iron over them. Make sure the iron is not too hot: it should not melt the plastic, but just seal it together. Make sure you have a good seal. Practice making seams on small scraps of plastic first. Find the right temperature for the iron.

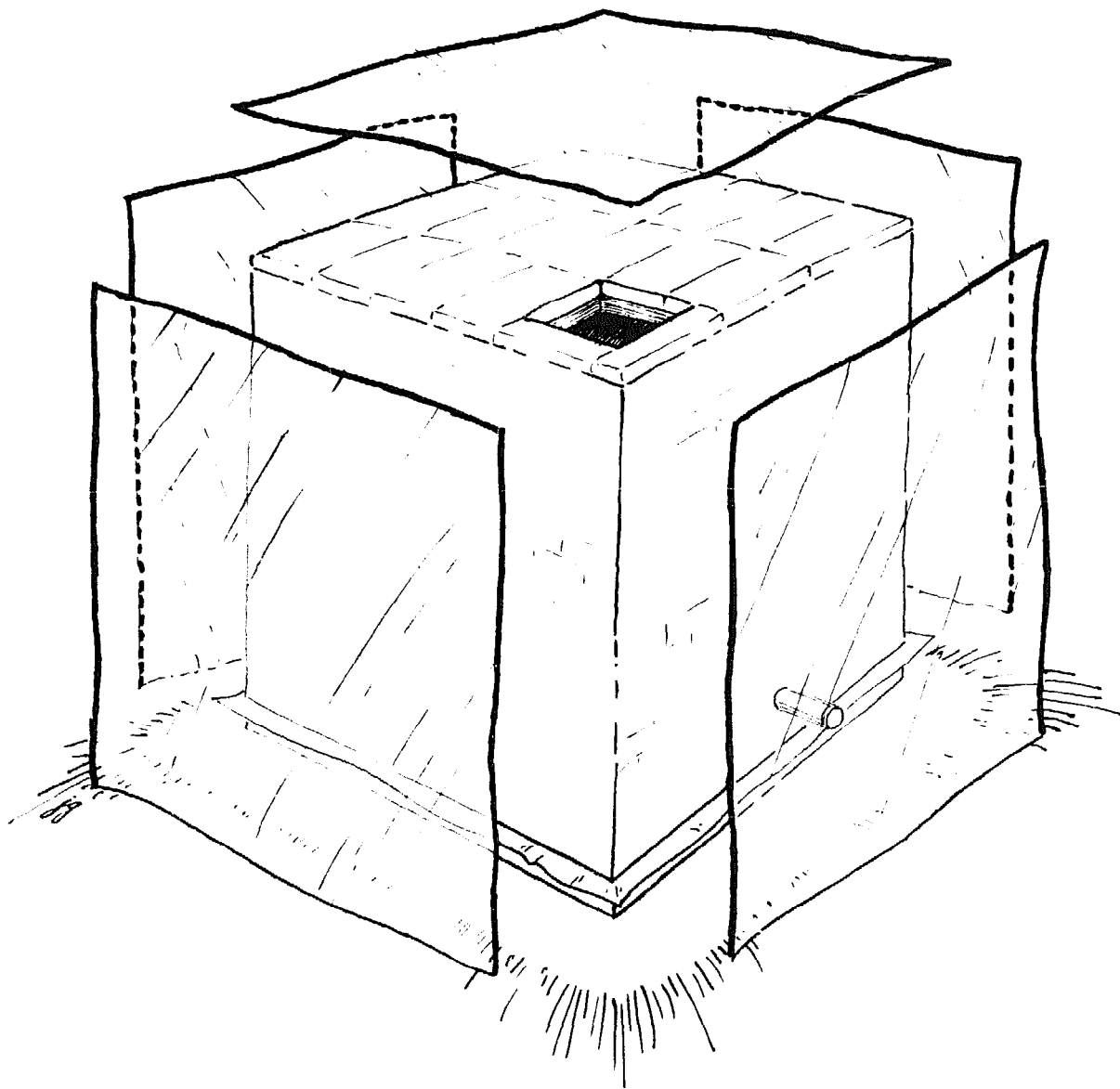

*Join the darkened edges  
of the plastic sheets*

- . Make sure there are no rough edges of blocks or mortar on the walls or roof that will damage the plastic.
- . Pull the cover all the way down over the inner structure of the bin. If it is too small you will have to re-make it; you may be able to re-work the seams. It does not matter if the cover is too large.
- . Cut a hole in the plastic around the emptying spout. Seal it to the spout with something like soft wax. This should make an air- and water-tight seal.

- . Seal the bottom edges of the wall pieces to the edges of the plastic in the floor.
- . Cut a diagonal slit through the plastic across the manhole.

9. Build the outer walls.

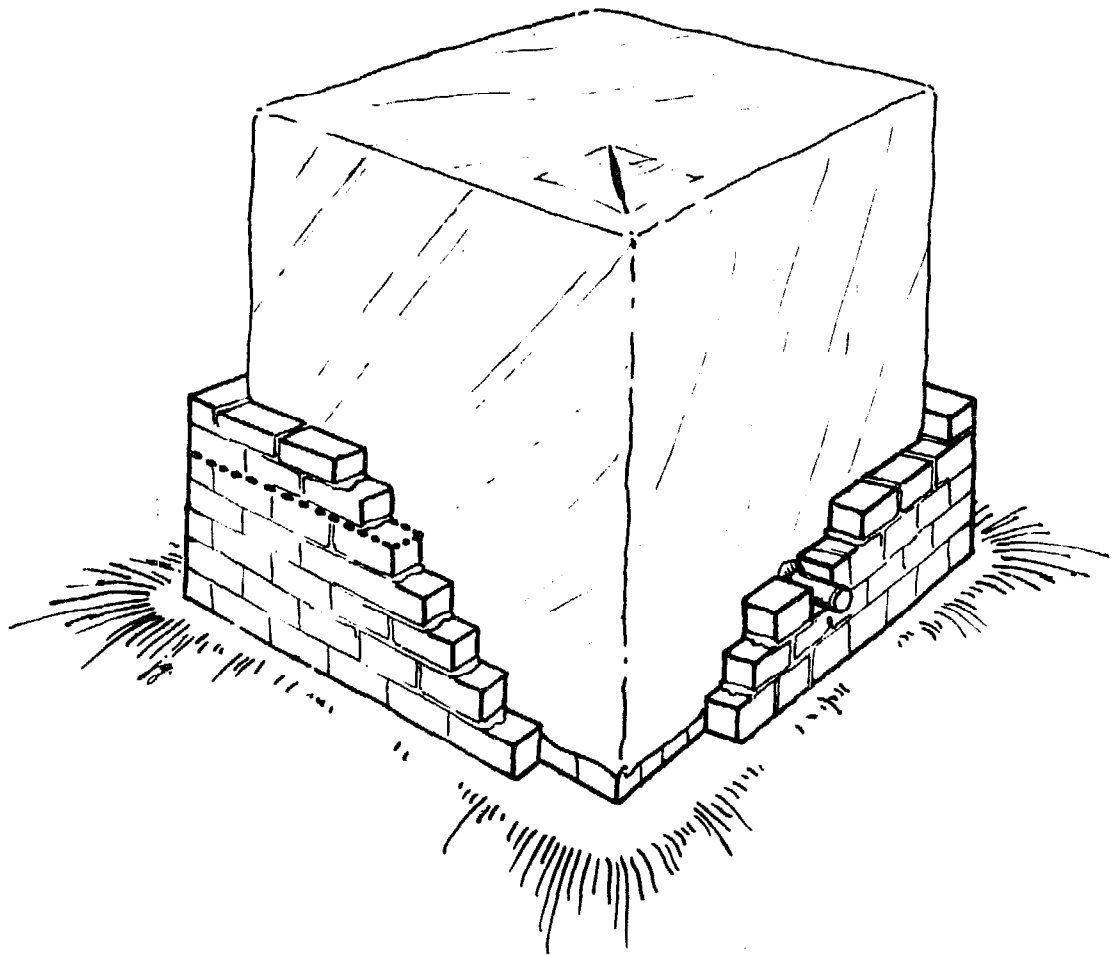

- . Begin the walls from the earth foundation. Build them right up against the plastic over the inner walls.
- . Use fired bricks or other hardened bricks and cement mortar for the lower 50cm of the outer walls  
OR  
Use mudblocks and mud mortar instead, building them up on the metal sticking out from under the floor. Cover them to a height of 50cm with overlapping pieces of sheet metal. Mortar or otherwise securely fasten the metal in place. Make a good joint with the metal sticking out from under the floor.

- . Continue the outer walls with mudblocks and mud mortar. Build them up to the top surface of the inner roof. If there is any difference in height, fill with mortar.

10. Build the outer roof.

- . Place 5cm-thick mud slabs over the plastic sheet on top of the inner roof, mortaring them in place, out to the outside edges of the outer walls. They may be any size across, as long as they are strong.
- . Do not cover the manhole. Make a separate mud slab to fit over it.
- . Fill in spaces between the slabs with mortar.

11. Finish the bin.

- . Plaster the outer roof and sides with a smooth layer of mud or mortar.
- . Let the entire structure dry thoroughly. This will take about thirty days. Leave the manhole cover off during the drying.
- . A coat of whitewash put on after drying would help reflect the sun's heat and add further waterproofing.
- . Build a shelter over the Pusa Bin to protect it from the rains. Make it at least a half meter larger than the bin on all sides, and high enough to give plenty of room to load grain and get in and out the manhole. There is no need to enclose the sides of the shelter.

12. Prepare and use the bin for storage.

- . When the bin is dry, clean the inside thoroughly. Light a small, smoky fire to drive off insects. Take both of these steps each time you get ready to load an empty bin.
- . Dusting the inside surfaces of the bin, and also the grain, will protect the grain better.
- . Cover the manhole when you have put your grain into the bin. Seal it with extra mud or mortar for more protection.
- . Always close the cover of the emptying spout tightly after using.
- . Check the grain periodically.
- . Store only grain which is dried to 12-13% moisture content in the Pusa Bin.

## IMPROVED MUDBLOCK SILO

READ THE INSTRUCTIONS THROUGH BEFORE YOU BEGIN

### Tools and Materials

- . Rocks about 20-25cm across for the foundation of the silo.
- . Flat rocks, as wide across as possible, to lay across the foundation.
- . Sand for concrete and mortar.
- . Small stones to mix in with the concrete.
- . 2 bags of cement.
- . Trowel or a similar tool to work the mortar and plaster mixes.
- . Different sizes of wood boards. The sizes are shown in each part of the instructions where you will use them.
- . Earth to make mudblocks.
- . Nails (1.8-2.4cm long).
- . Pitch, tar, or other waterproofing material.

### Select a Site

- . Find some solid ground on which to build the silo.
- . High ground is best.
- . Make sure the silo is built in a place where the ground underneath it will not wash away during a rainy season.

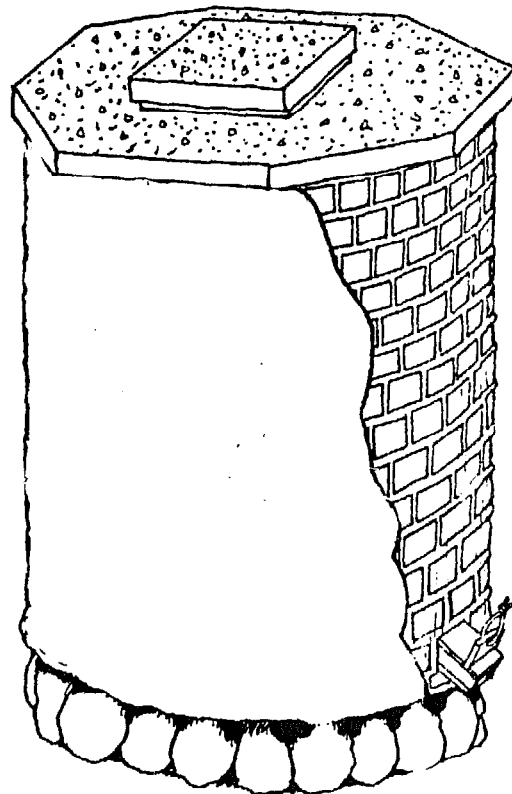

### 1. Make a Form to Mold Mudblocks

- . Use wood boards about 2.5cm thick.
- . You will need: 2 boards 46cm x 10cm  
4 boards 10cm x 15cm
- . Line the 2 long boards up side by side.
- . Nail the 4 small boards crossways between them. Place the small boards so that the distance between the 2 long boards is 15cm. Leave 10cm space between each of the small boards. Place the first small board about 2.5cm in from the ends of the long boards. This should leave about the same amount of space on the other end.
- . Make handles. Use 2 small pieces of wood 2.5cm thick that are 15cm long and about 5cm wide. Nail one across each end of the box.

### 2. Make Mudblocks

- . Mix earth and water to make the same kind of mud you use to build any building.
- . Wet the form.
- . Fill the form with mud.
- . Pack the mud tightly into the form.
- . Take any extra mud off the top.
- . Lift the form carefully off the mudblocks.
- . Dry the blocks in the sun.
- . Make about 300 blocks.

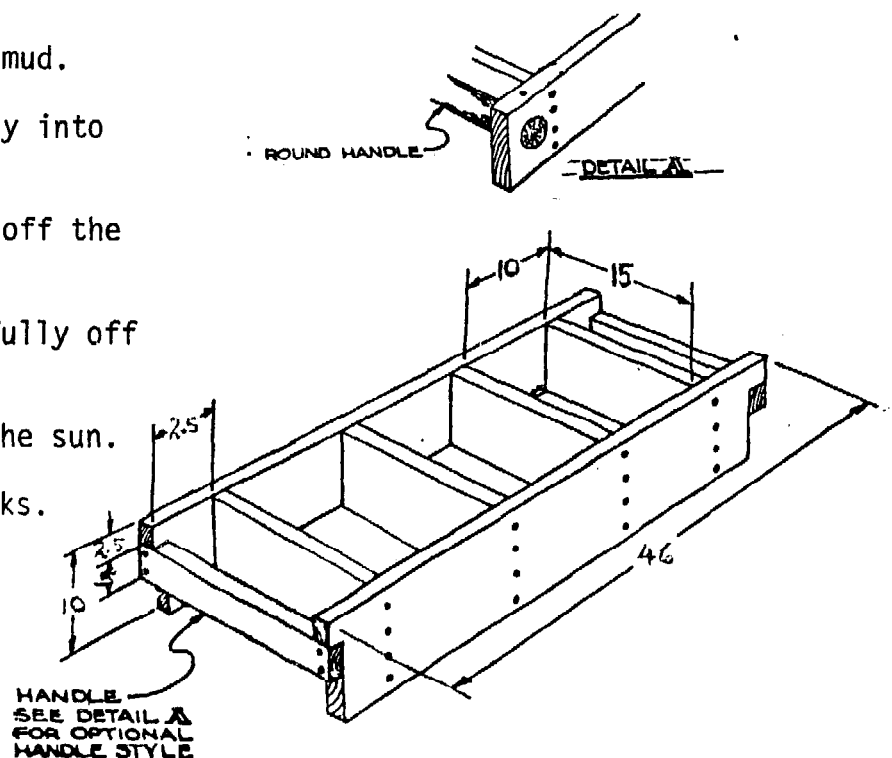

3. Make Frame "A" for the Outside of the Topslab

- To make this topslab you must make 4 wood frames. Later you will pour concrete into these frames. 
- Prepare: 2 boards, 2.5cm x 5cm x 1.2m  
2 boards, 2.5cm x 5cm x 1.1m  
4 boards, 2.5cm x 5cm x 51cm
- Nail the 4 longer boards together. Butt the ends of the 1.1m boards up against the ends of the 1.2m boards. When the frame is lying on the ground, the 2.5cm edges of the boards should be facing up.
- Nail these cross pieces in place from the inside. The 2.5cm edges of these boards should also be facing up when the frame is lying on the ground.
- Cut the ends of the 4 short boards at a 45 degree angle. Then they will fit easily across the corners of the large square frame.

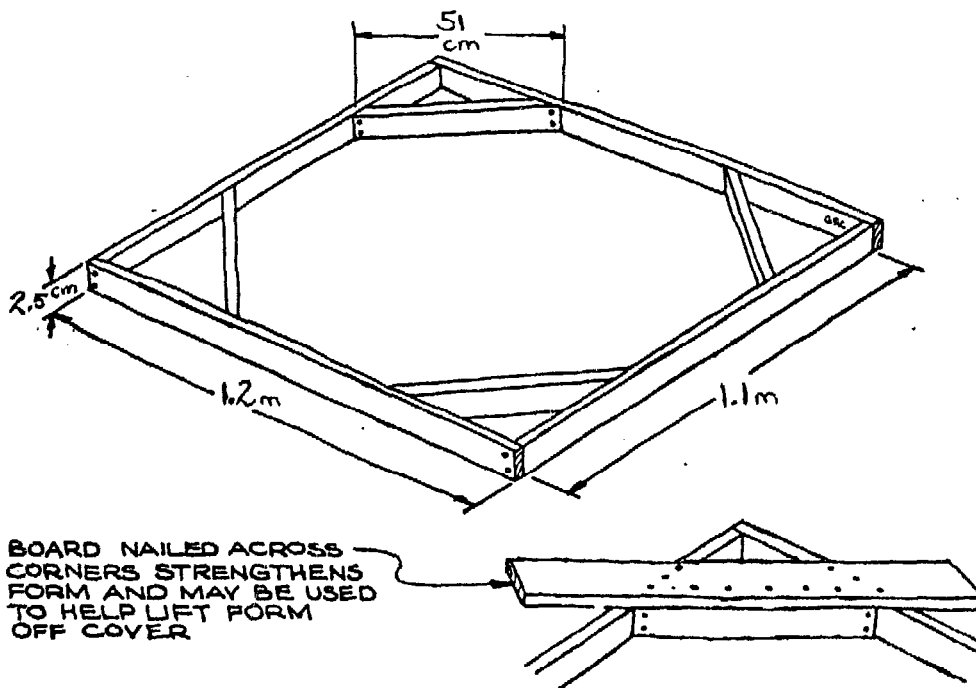
FRAME A



4. Make Frame "B" for the Manhole

- Prepare: 2 boards, 2.5 x 8cm x 45cm  
2 boards, 2.5 x 8cm x 40cm
- Cut part of the face off each end of the 4 boards.  
This will make a slanted face.
- Nail the 4 boards together. Face the slanted sides outward.  
Butt the ends of the 40cm boards up against the  
ends of the 45cm boards.

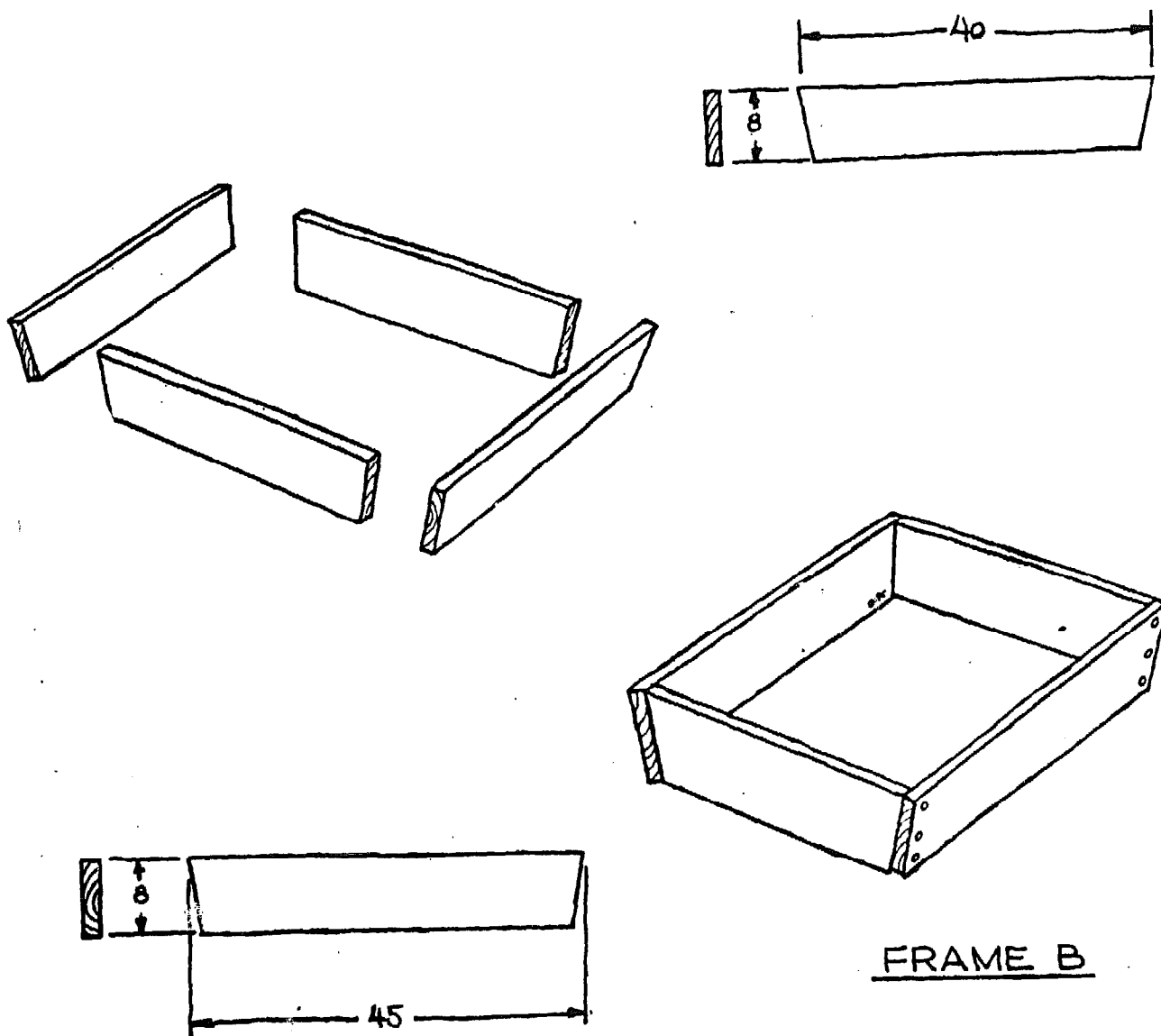

FRAME B

### 5. Make Frame "C" for the Collar

- Prepare: 2 boards 2.5cm x 2.5cm x 53cm  
1 board, 2.5cm x 2.5cm x 56cm  
1 board, 2.5cm x 2.5cm x 66 cm
- Nail the 4 boards together. Butt the ends of the 56cm board up against an end of each of the 53cm boards. Butt the other ends of the 56cm boards up against the 66cm board. Leave 5cm of the 66cm board sticking out on one end.

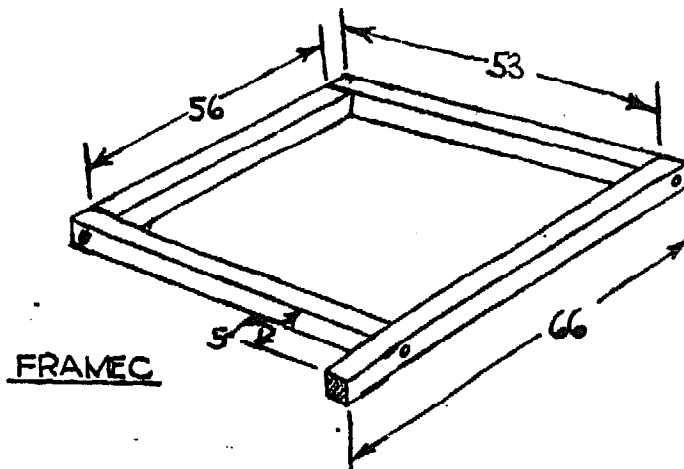

### 6. Make Frame "D" for the Manhole Cover

- You will need: 2 boards, 2.5cm x 5cm x 61cm  
2 boards, 2.5 x 5cm x 56cm
- Nail the 4 boards together. Butt the ends of the 2 shorter boards against the ends of the 2 longer boards.

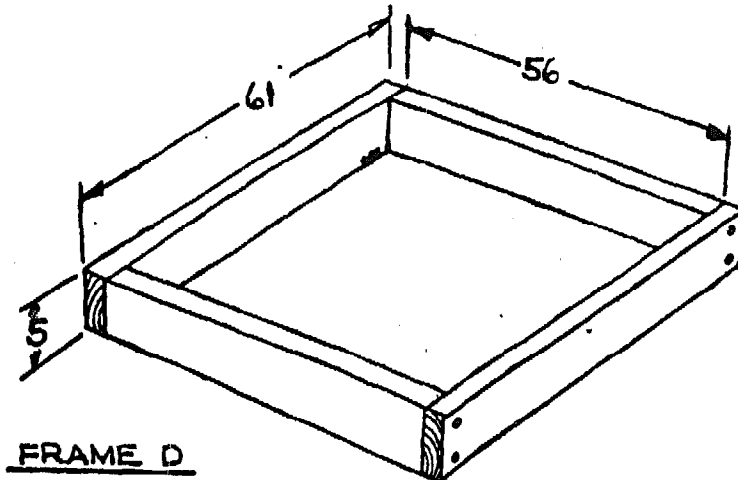

7. Mix the Concrete and Pour it into the Wood Frames

- . Mix the concrete in a proportion of: 1 part cement (out of the bag)  
2 parts sand  
3 parts small stones

Remember to mix the dry ingredients first. Then add the water, a small amount at a time until the mixture is correct.

- . Cover a flat place on the ground with empty cement bags or sheets of heavy paper or plastic. These will keep the concrete from sticking to the ground.
- . Wet the empty bags or whatever you are using. This will keep the concrete from sticking to them.
- . Put Frame A on top of these.
- . Place Frame B in the middle of Frame A. Make sure each side of Frame B is the same distance from each side of Frame A. The thin edges of Frame B should be facing down.
- . Begin pouring concrete mix into the space between Frame A and Frame B. The open space inside of Frame B will be the man-hole.
- . When you have poured in about half the thickness all the way around, lay in the metal rods.
- . Pour the rest of the concrete mix over the rods.
- . Make sure the rods are in the concrete. They should not show through the concrete. If you do this right, the rods will help make the concrete much stronger.

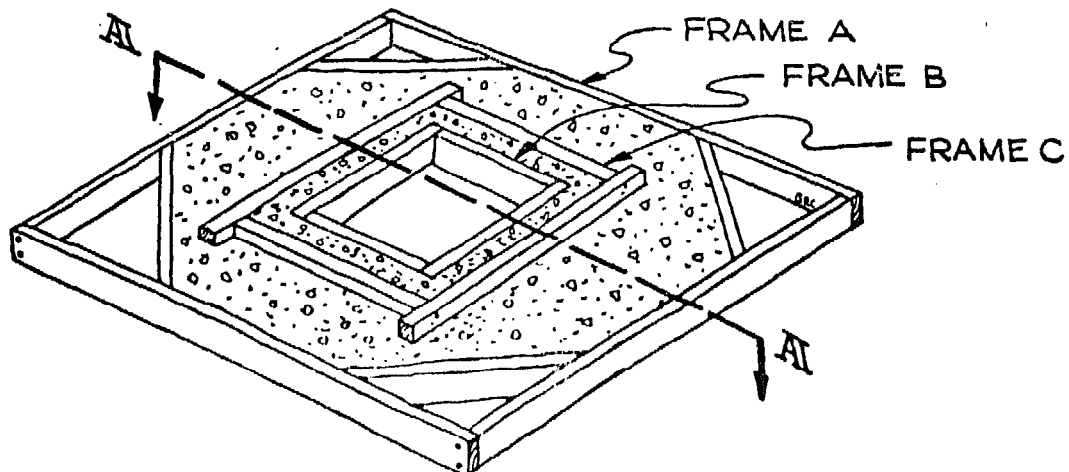

- . Level the concrete even with the top of Frame A. Frame B will stick up 2.5cm above the wet concrete.
- . Place Frame C around Frame B on top of the wet concrete. The space between the two frames must be the same on every side.
- . Pour concrete mix into the space between Frame B and Frame C. Make the top of the concrete level with the tops of the 2 frames. This will form a collar for the manhole cover to rest on.
- . You are now ready to use Frame D to make a separate piece. This will be the manhole cover.
- . Place Frame D on some empty cement bags or sheets of heavy paper or plastic.
- . Wet the empty bags or whatever you are using.
- . Pour concrete mix into Frame D. Level off the top of the concrete to the top of the frame.
- . Leave all the frames around the concrete for at least 3 days. The concrete will become even stronger if you can leave it for several more days.
- . While the concrete is drying, put water on it 3 times each day at morning, noon, and night. Putting water on the concrete like this will make it harden evenly and not crack. This is called "curing."
- . When the concrete is "cured," remove the wood frames. Remove them carefully, so you can use them again.

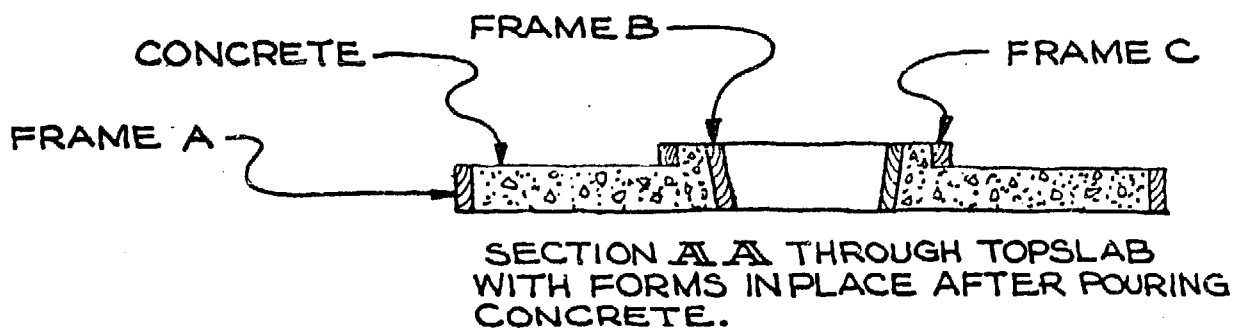

### 8. Make the foundation

- . Draw a circle on the ground where you want to build the silo. Make the circle 1.2m across.
- . Place the 20cm or 25cm rocks around the circle just inside the edge, and inside the circle. You may fill in the larger spaces with smaller rocks to give more support. The air spaces between the rocks will let air move through the foundation and will keep moisture from collecting.
- . Place flat rocks on top of the circle of rocks. This will make the top more level.
- . If you cannot find good flat rocks, you may use concrete blocks. Place them the same way as you would the flat rocks. Place them so they come right up to the edge of the circle of rocks, or overhang slightly.
- . Make some mortar by mixing 1 part cement and 5 parts sand together. Add enough water to make a workable paste.
- . Put mortar over the flat rocks or boards. Fill all open spaces. Make the surface as smooth as you can. This will cement the top of the foundation into a solid piece.
- . Find the center of the foundation.
- . Mark off a 91cm diameter circle from the center. This is the inside diameter of the silo.

### 9. Build the Grain Chute (Optional)

- . Use hard wood about 2.5cm thick.
- . Prepare:
  - 1 board, 2.5 x 15 x 30cm -- for the top of the chute.
  - 1 board, 2.5 x 15 x 25cm - for the bottom of the chute.
  - 2 boards, 2.5 x 10cm that are 25cm long on one edge and 30cm long on the opposite edge. These are for the sides of the chute.
  - 1 board, 2.5cm thick, at least 13cm wide, and 20cm or 25cm long. This is for the sliding door in the chute.
- . Place the edge of the sliding door board on one of the side boards 5cm in from the short straight end. Trace the width of this edge onto the side board. Make a groove. Remove the wood between the 2 lines you have traced to a depth of about 6mm. Make each surface of the groove as smooth and as straight as you can.

- Repeat this process on the other side board. The groove should be in the same place on each side board.

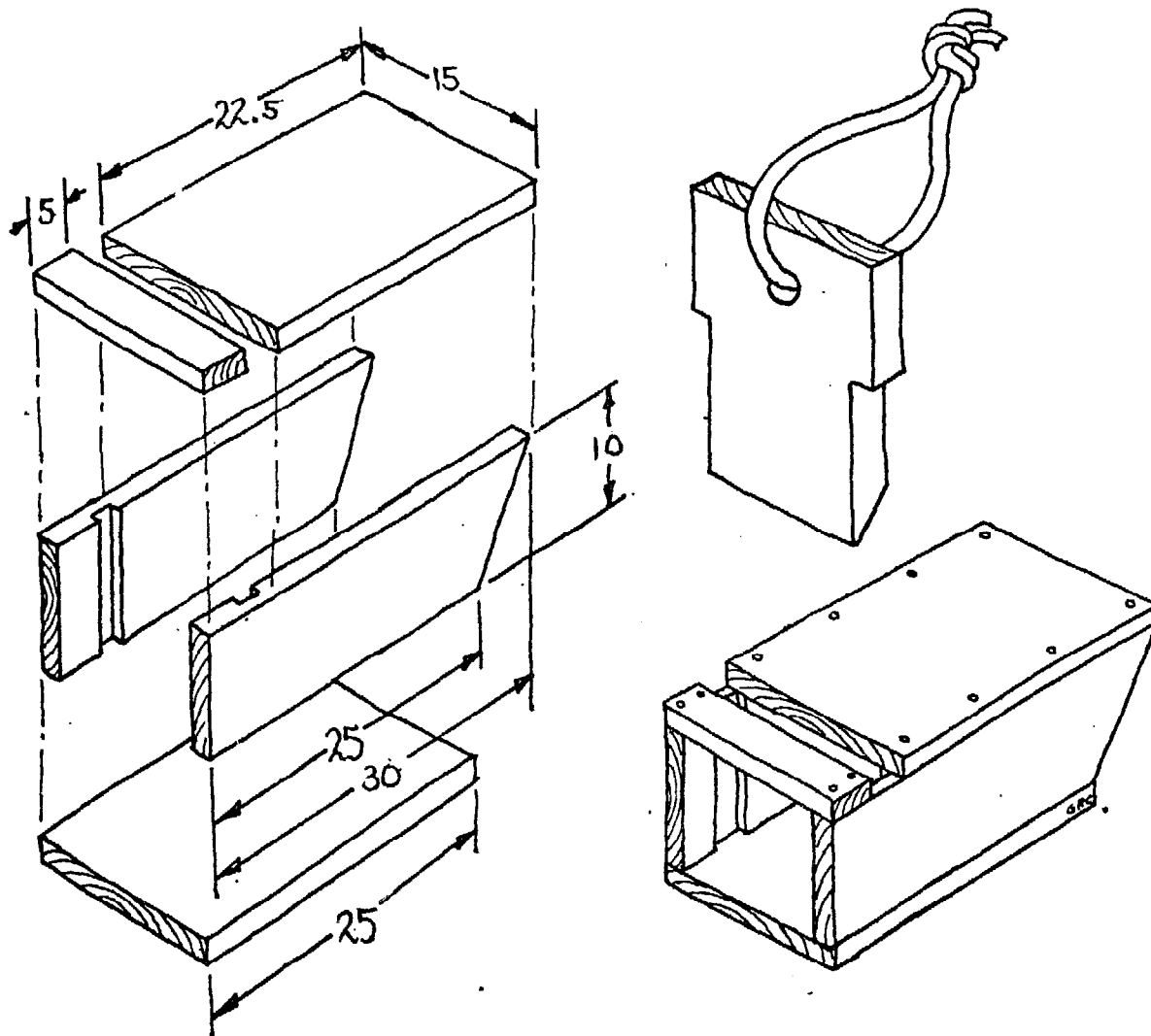

GRAIN CHUTE

- Cut the top board into two pieces. One piece should be 5cm long. This will fit the space between the front of the chute and the beginning of the groove for the sliding door. Match the edge of the remaining piece with the far end of the groove. Cut the length of the top piece as needed to match the length of the side piece.
- Nail the top and sides and bottom of the chute together.
- Trim the width of the sliding door board so that it will slide through the opening in the top of the chute down the grooves.

You may have to trim the long sides of the opening too if the sliding door is too thick. The sliding door should move freely up and down but should not be too loose.

- . Cut the bottom edge of the sliding door at an angle so that only a thin edge will touch the bottom of the chute. This edge will face the outside of the silo. This will make it easier to keep grains from lodging under the closed door which might let air and moisture and insects into the silo.
- . Paint the chute and the sliding door with pitch or tar or some like material to protect it from insects and moisture.
- . Drive a few nails into the chute near its slanted end. They should stick out a couple of centimeters. The nails will help anchor the chute into the walls of the silo.

#### 10. Begin the Walls

- . Make mortar the same way you did for the top of the foundation. It is better to mix smaller amounts until you know how fast you can use it. Do not use mortar that has gotten too dry because it will not be as strong.
- . Lay down a layer of mortar all around the inside edge of the circle you have drawn on the top of the foundation. Make it about 10cm wide.
- . Place about 18 mudblocks in a circle on top of the mortar. Leave a space for the chute, including the nails that are sticking out from it.
- . Place the chute in the space you have left. The slanted end of the chute should be even with the inside surfaces of the blocks next to it and straight up and down. This will make the chute tilt down away from the silo wall.

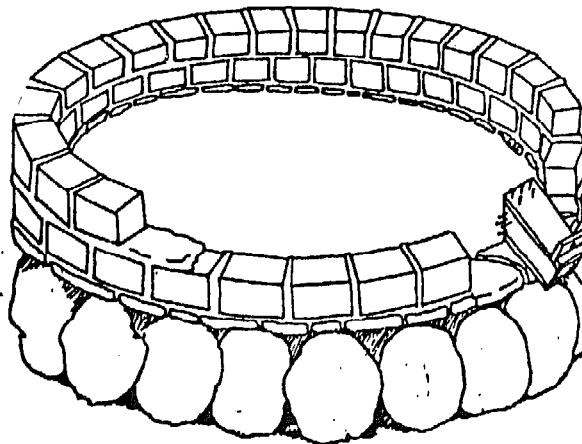

- . Fill the spaces between the mudblocks and the spaces between the mudblocks and the chute with mortar.
- . Lay down a layer of mortar on top of the circle of mudblocks.
- . Place the second layer of mudblocks on top of the first. Place each block so that it lays across the space between the blocks in the first layer. This will make the wall stronger. You may have to cut blocks to fit next to the chute. Do not leave a large space that will have to be filled with mortar next to the chute.
- . Continue putting on mortar and mudblocks in the same way until you have laid down 4 layers of mudblocks altogether.

### 11. Make a Slanted Floor

- . Use sand or soil to make a slanted floor. This will help the grain move towards and out of the chute. If the chute is not used, this slant will not be needed.

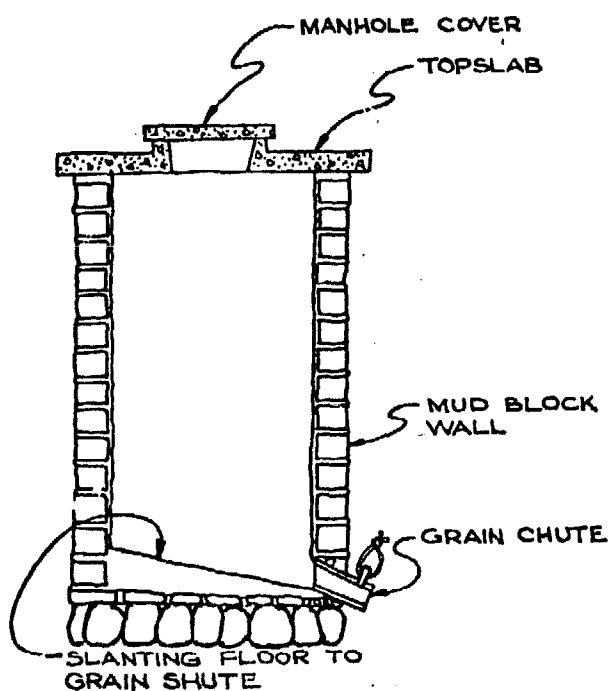

SECTION VIEW  
THROUGH  
MUD BLOCK SILO

- . Pack the sand or soil down hard.
- . The floor should be 30 cm above the bottom of the chute at the place opposite the chute. The floor near the chute should be even with the bottom of the chute.
- . Make a mix of plaster. Use 1 part cement (out of the bag) to 3 parts clean sand (mix dry). Use enough water to make a smooth mix. Do not make it too watery.
- . Plaster the slanted floor and the inside of the mudblock wall. Make sure you cover all the surfaces completely.
- . Plaster carefully around the chute.
- . Smooth the plaster well after you put it on. This will make cleaning easier and will leave fewer spots for insects to hide in.



- . Keep the plaster damp until it is hard.
- . Put loose sand on the floor after it is dry. This will keep drops of mortar and plaster from sticking to the floor as you continue working.

## 12. Finish the Walls

- . Tie a string to a small stone. You will use this to check the straightness of the walls as you build them.
- . Put down 3 or 4 layers of blocks. Use mortar and arrange the blocks the same way you did for the first 4 layers.
- . Hold the string at the top end, with the stone hanging down from it at the other end.
- . Hold the string out about 5cm from the top of the silo wall. The silo wall is straight if the distance between the string and the wall is the same from the top to the bottom.
- . Continue adding layers of blocks the same way as you did before. Check every 3 or 4 layers for straightness.
- . The finished silo wall should have about 14 layers of blocks.
- . Mix some plaster the same way you did for the slanted floor and the inside of the first 4 layers of mudblocks.
- . Plaster the inside and the outside of the silo wall. Remember to put the plaster on very smooth.

## 13. Place the Topslab

- . When the mortar and the plaster in the silo wall are dry and strong, you are ready to place the topslab on top of the silo.
- . Make sure that Frames A, B, and C are removed from the concrete topslab.
- . You will need people to help you put the topslab in place.
- . Mix some fresh mortar (1 part cement, 5 parts sand, and water).
- . Place a layer of mortar all around on top of the silo wall.
- . Put the topslab down on top of the mortar. Many people can lift the topslab together. One person can stand inside and help. He can get out through the manhole.

- . Remove the cover from Frame D and place.

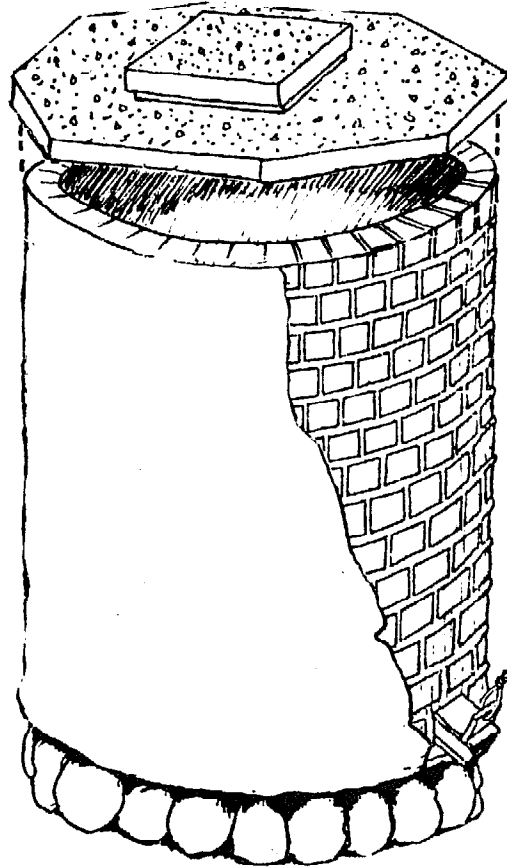

#### 14. Whitewash the Silo

- . Apply a coating of whitewash to all the outside surfaces of the silo. The manhole cover and all areas of the top slab and walls should be covered.
- . Whitewash closes small openings in the cement.
- . Whitewash helps keep the silo cooler inside. It is important to keep the grain cool and dry.
- . Whitewash will also make your silo look nice.

### HOW TO USE YOUR MUDBLOCK SILO

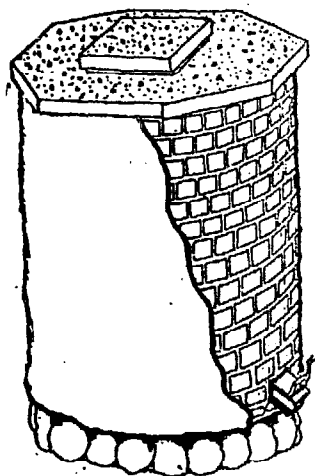

- . Put only clean, dry grain into your silo.
  - . Wet grain will rot in the closed silo. It will get moldy.
  - . Wet grain will make the silo wet. The silo walls will crack if they get wet. Your grain will be no good.
  - . Dry your grain in the sun.
  - . Keep the grain in the sun or in the dryer until it is dry.
  - . Test the grain when you think it is dry. Put one grain between your teeth. Dry grain is very hard to break with your teeth.
- 
- . Remember, if storing maize -- put kernels into the silo right after you remove them from the cobs. Do not let maize stay on the cobs after you remove the cobs from the drying place.
  - . When the grain is dry, take the cover off the manhole. Put the grain into the silo right away. Fill the silo to the top.
  - . Stir the grain in the silo with a large stick. This helps the grains settle.
  - . It is good to add an insect poison to the grain before you close the silo. Insects are always present in grain. Insect larvae live inside the kernels where they can not be seen. Talk to your extension worker about what poison to use and how to use it.
  - . Remember, poisons can kill animals and people. Do not use them before you talk to an extension worker.
  - . Put the cover on the manhole as soon as possible. Flying insects can enter the grain if the cover is not on the manhole.
  - . Put mud all around the cover so nothing can get into any cracks between the cover and the manhole.
  - . Make sure the sliding door in the wooden chute closes tightly.
  - . Make sure there are no cracks around the chute.

## Storage Methods -102- Improved Mudblock Silo

- . Put mud over the chute to protect it from rodents and insects.
- . Keep the area around the silo clean. Rats do not like to live where it is clean.
- . Check your silo often. Put new plaster on any cracks you find. It is important to find the cracks and put plaster on them right away.
- . Keep the silo white. The white color keeps the silo cool. Put on new whitewash when the silo needs it.
- . You may have to use the chute to take out small amounts of grain to sell or eat. Make sure you close the sliding door carefully. Do not leave it open. Reseal it with mud. If theft is a problem, the chute can be omitted and grain will be removed from the top of the silo.
- . Do not leave grains scattered on the ground. These grains will attract insects and rats.
- . When you empty the silo, make sure all the grain is out. Grain left in an empty silo will attract insects and rodents.
- . Clean the silo well before you fill it again. You can burn a small fire made of grass inside the silo. This kind of fire makes a lot of smoke. The smoke and heat from the fire kill insects and insect eggs.
- . Sweep out the ashes, dust, and old grain.
- . When your silo is clean and repaired, you are ready to put the next crop of grain into the silo.

## FERROCEMENT FOR GRAIN STORAGE

Materials in this section have been adapted from articles in Ferrocement: Applications in Developing Countries., National Academy of Sciences, Washington, D. C., Feb., 1973; and from "Hermetic Storage of Rice for Thai Farmers by Smith, Boon-Long, Loo, Nutalaya and Pataragetvit, Thai Journal of Agricultural Science, July, 1971.

Ferrocement is a kind of reinforced concrete. Ferrocement is made of wire mesh, sand, water, and cement. It is strong and durable. Generally, ferrocement structures are from 1cm to 5cm in thickness. The reinforcement is layers of steel mesh with thin steel reinforcing bars placed between the layers. Ferrocement has been used as a material for building boats for many years. Now ferrocement is being used with increasing success for grain storage in a number of countries.

Ferrocement is appropriate for building structures in many areas of the world:

- . The materials to make it are usually available all over the world.
- . It can be made into almost any shape. Therefore, an improved structure can be made which looks very much like the old one.
- . It is cheaper than a metal bin, in some places.
- . Building with ferrocement does not require a lot of equipment or machinery.
- . It can be built almost anywhere, even in isolated locations.
- . It does not take very long for workers to learn to use ferrocement.
- . It needs little maintenance after completion. Repairs, if necessary, are easy to make.

## MATERIALS FOR FERROCEMENT

### Reinforcing Mesh

Many kinds of mesh will work as long as the mesh can be shaped easily (is flexible). The mesh will have to be more or less flexible depending upon the shape of the final ferrocement product. If the ferrocement is to be a rounded structure, the mesh has to be more flexible than it would have to be for a straight-sided container.

For grain storage uses, chicken wire can be used as reinforcing mesh. Chicken wire is usually available, though in some areas it can be expensive.

In cases where chicken wire or wire mesh is not available, the mesh can be made by using straight wire. This allows the user to make the size mesh he wants, and it is cheaper to buy coils of straight wire than it is to buy mesh. The mesh does not need welding; either galvanized or non-galvanized wire can be used.

### Cement, Sand, and Water

Almost any ordinary cement can be used. The sand should not be too fine (have too many tiny pieces). If there are pieces of dirt, leaves, or other organic matter in the sand, wash the sand before using it. The water also must be free from silt and other dirt. These materials weaken the ferrocement if they are left in the sand and water.

## BUILDING WITH FERROCEMENT

There are three areas in ferrocement construction which are particularly important:

### Mixing the Mortar

A general mix is 1 part cement to 2 parts sand. Only enough water is added to make a pastelike mixture. Experience will be the best way to find out the best consistency for the mortar. Machines can be used for mixing, but hand mixing the mortar works very well and may cost less.

### Putting the mortar on the wire mesh

Before mixing the mortar, the mesh structure should have been formed in the shape desired. Then, using fingers and trowels, push the mortar into the mesh structure. Some kind of vibrating movement helps push the mortar into the mesh and packs it in better. For grain storage purposes, just put a handle on a piece of wood and create a vibrating movement.

When placing the mortar, there are two important points to keep in mind: you must completely cover the steel wire mesh with mortar so that the steel cannot rust and lose its strength; at the same time, the wire mesh should be as near the surface as possible. This means that the covering over the wire mesh must be thin but complete.

### Curing the Mortar

Ferrocement must not dry too quickly. It should be kept moist for at least seven days. It also must be protected from sun and wind. Both too much sun and too much wind will dry the ferrocement too quickly: ferrocement must dry slowly to be strong.

## FERROCEMENT FOR GRAIN STORAGE

There are many things about ferrocement which make it good for grain storage; it is particularly good in areas of the world where high temperatures and damp air cause grain to rot and mold easily. (However, if wire is very costly, and cement powder relatively inexpensive, the farmer may want to build a cement stave silo.) Ferrocement:

- . can provide watertight storage, if treated.
- . can be made to provide airtight storage, and, therefore, insecticides are not needed.
- . does not heat the stored grain as much as metal bins do.

### Disadvantages

One major disadvantage to ferrocement at the moment seems to be that the use of ferrocement for grain storage is still new, and knowledge of the technique is not widely available. Also, for the small farmer, ferrocement is relatively expensive.

## AN OVERVIEW OF GRAIN STORAGE USES FOR FERROCEMENT

This section on ferrocement provides an introduction to ferrocement as a building material for grain storage uses. It includes descriptions of ferrocement bins and a ferrocement lining for underground storage pits. The Thai Ferrocement Silo (Thailo), which can hold 3.5 tons of paddy rice, is presented in some detail.

Ferrocement has been used to make water tanks for a number of years. But ferrocement is still being tested for its grain storage value and much of this knowledge is still in the hands of designers and testers. Hopefully, by reading the above general material on ferrocement, and, then, by reading the following descriptions of possible grain storage uses, you will be able to form some ideas as to whether or not ferrocement is worthy of more investigation for use in your area.



## THAI FERROCEMENT SILO (THAILO)

Tools and Materials

. Cement	1,000kg
. Sand	1,725kg
. Aggregate	965kg (used in the base)
. Mortar plasticizer	2kg
. Sealant for base	5kg
. Paint	3/4kg
. Chicken wire	2 Rolls
. No. 2 rod	80m
. Water pipe (19mm dia.)	32m

These are materials available in Thailand; they may not be easy to find in other places. But other materials may be substituted. For example, the silo has been built using bamboo poles instead of water pipe. The pipe was substituted to prevent termite infestation. If it is not clear that termites will be a problem, experimenting with other available materials will be needed. Using bamboo, means the walls will be much thicker -- 5 to 7.5cm --, requiring more cement. Walls using water pipe are only 4cm thick.

The sealant is to help protect the silo in areas where flooding is a problem. Any kind of asphalt seal should provide protection.

1. Build the Base

- . The base is saucer shaped and can be built on a pile of hard earth. This should be done if the area has seasonal flooding or very heavy rains. The base can be changed easily to fit different ground conditions.
- . Put a sealing mortar on the earthen base and apron. Make the mortar using, by weight:
  - 1 part cement
  - 3 parts sand
  - 0.6 parts water
- . Lay one layer of concrete over the apron and base. Make it 5cm thick.
- . Reinforce this concrete layer with 19mm wire mesh. (Chicken wire can be used) after you have laid down half the thickness of concrete. Use this concrete mix, by weight:
  - 1 part cement
  - 1 1/2 parts sand
  - 2 parts aggregate
  - 0.33 parts water.
- . Let this layer of concrete harden and water it 3 times a day. Keep the concrete damp for 7 days. This lets the concrete harden slowly, and the concrete will, therefore, be stronger. Treat the concrete with an asphalt seal. In Thailand, a brand called Flintkote is used in 2 coats. (Flintkote is simply a bitumen emulsion). The first coat is mixed with water -- 1 part Flintkote, 3 parts water. The second layer contains no water.
- . Put down another layer of 5cm thick concrete with mesh reinforcement (about midway in its thickness). This time put the concrete over the base, but not over the apron. The mesh should stick out of the concrete to the end of the apron. It will be used later as more reinforcement for the walls.

Section showing  
shape of the base



## 2. Build the Wall Support Structure

- . The walls slope inward towards the top in a cone shape. The opening at the top of the cone is the entrance, or manhole.
- . Build a wooden "tree" to support the wall structure until it is finished. The tree should stand about 2m high with a circular platform at the top.

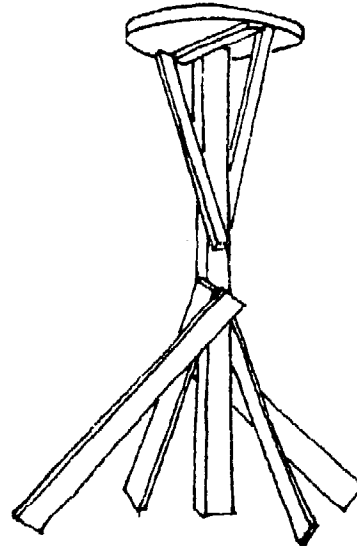

- . Extend steel water pipes or whatever reinforcing materials are used from the base to the tree platform at regular intervals. These struts form the support for the wire mesh.

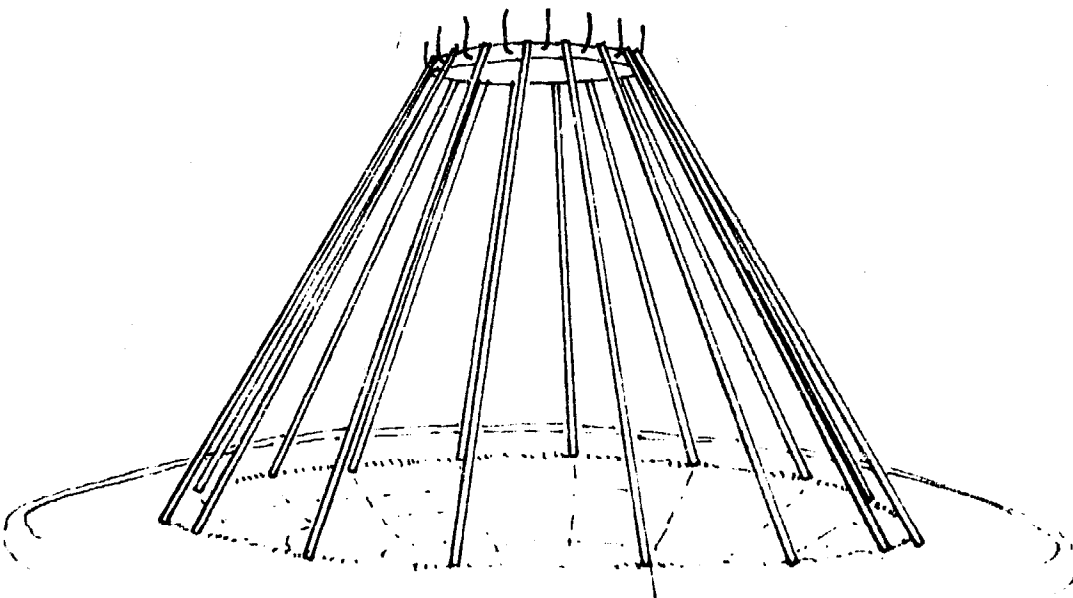

- . Bring mesh up from the base and fasten to struts with wire.
- . Wire horizontal hoops of reinforcing rod to the struts.
- . Put one layer of wire mesh on the outside surface and one layer of wire mesh on the inside.
- . Fasten mesh, reinforcing rod, and struts together with short pieces of wire threaded through the wall and back. Tie by twisting the ends with pliers.

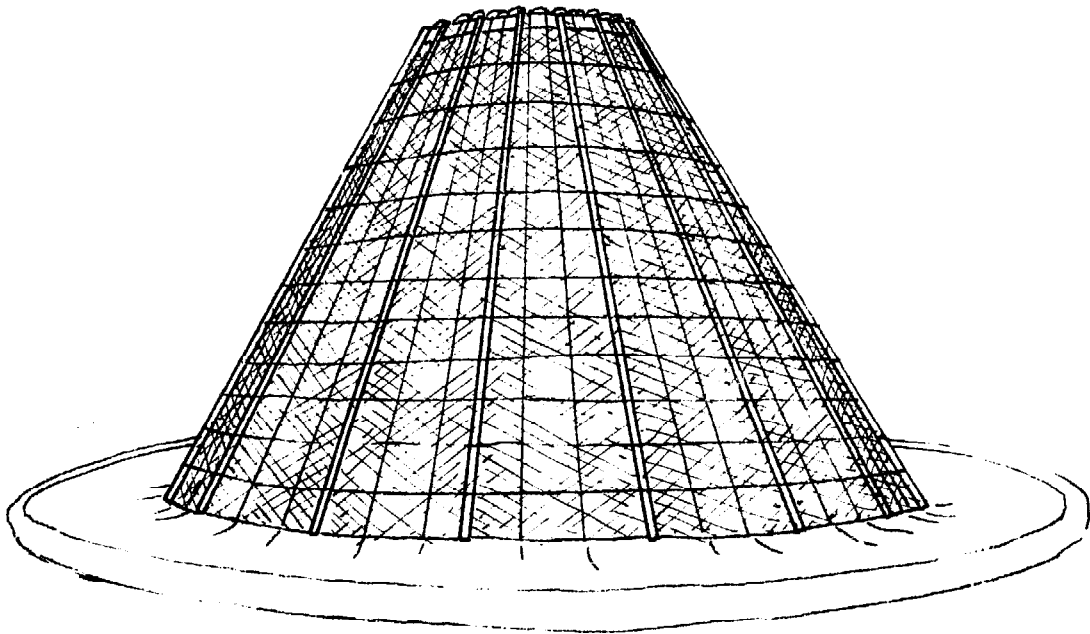

### 3. Apply Mortar

- . Hand mix the mortar in the following proportions, by weight:  
1 part cement  
1.75 parts sand  
Enough water to make a thick paste.
- . Work the mortar into the mesh structure using trowels and hands.
- . The wall thickness inside and out should be about 4cm (if using steel pipes) and 5-7.5cm (if using bamboo).

#### 4. Make the cover or Top

Here are 2 choices for the top.

1. Ferrocement outer cover with circles of rubber which act as airtight seals. This can be made on site or erected before cementing the walls.

An inner lid can be used. This lid can be an aluminum trash can lid. If this inner lid is used, place a polystyrene lining between the grain and the trash can lid to insulate against heat and prevent moisture condensation.

2. Build a small piece of formwork supported by wires attached to the tops of the steel pipes which form the struts for the wire mesh. Or long nails can be driven into the wooden platform which supports the struts. These nails are bent up to shape a form.

The topseal consists of 2 parts:

- . Aluminum lid with polystyrene insert and a tubular ring of plastic placed between the lid and the wall.
- . A piece of sheet metal screwed to the top with a sealing gasket.

#### Some General Notes on Ferrocement Silos

**IMPORTANT:** Do not mix too much water into the mortar and concrete mixtures.

**IMPORTANT:** Wet the finished ferrocement 3 times per day for 7 days. Cover the silo with moist sacks and make sure the cover is kept wet. It is very important not to let the sun and wind dry the silo too quickly. Slow drying, called curing, gives cement its durability and strength.

- . Painting the silo with chlorinated rubber-base paint, coal tar or bitumen should be done to make sure it is completely airtight and watertight.
- . Fill the finished silo with water for one week if you wish to test it. Water is heavier than the stored grain. If there are cracks or weak places they will leak. Make repairs as needed. The silo must be dried for 4-6 weeks particularly if it has been filled with water. Remember that the shape and size of the ferrocement silo can be changed to fit your own needs.

## FERROCEMENT-LINED UNDERGROUND PITS

This material is adapted from Ferrocement: Applications in Developing Countries, National Academy of Sciences, Washington, D. C., Feb., 1973. The illustration is from a report prepared by R. A. Boxall for the United Kingdom Committee of the Freedom from Hunger Campaign and Christian Aid, 1971-72.

A traditional pit can be made into an air and watertight grain storage container by using ferrocement to line the pit. Ferrocement linings work even in pits built in very wet ground. The cost of this pit was \$20.00 (U. S. currency) in 1972.

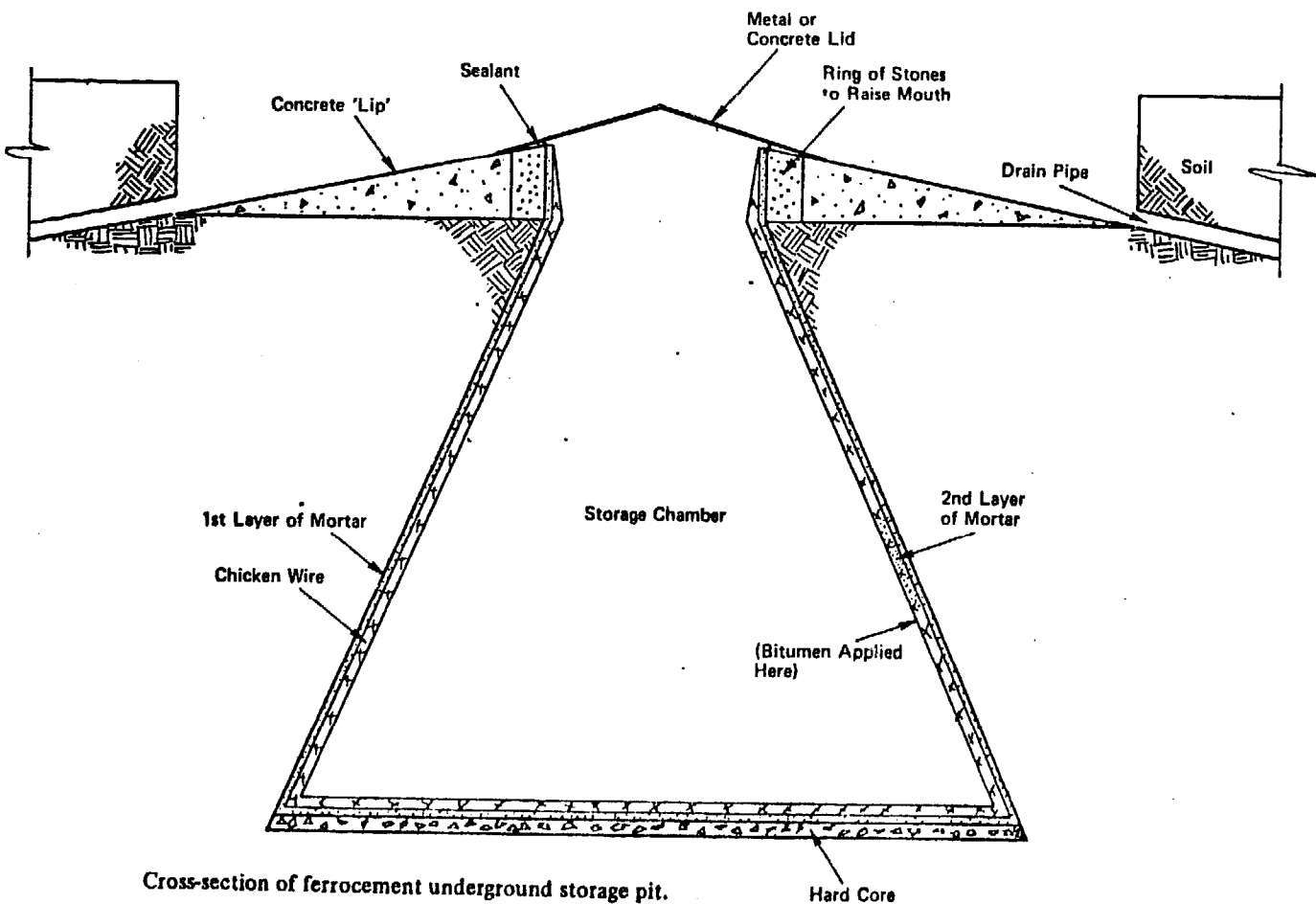

## Storage Methods -114-

Here is an outline of the construction process.

### 1. Clean the pit

- . Remove trash
- . Make sure walls are smooth and free of termites.
- . Apply poison to kill termites if necessary.

### 2. Prepare the floor of the pit

- . Lay down a 10mm layer of hardcore.
- . Lay a layer of concrete on top of the hardcore. Use a concrete mix like the one given for the base of the Thailo grain store pits.

### 3. Make the mortar

- . Mix well one part cement and 3 parts sand.
- . Add as little water as possible to make a paste.

### 4. Line the walls

- . Use hands and trowels to put a 2.5-3cm layer of mortar to the walls.
- . Place wire mesh reinforcement, or chicken wire on the surface of the mortar where it is wet.
- . See waterproofing material before placing the second layer of mortar. The other method of waterproofing is cheaper, requires less labor and may work well depending on the ground water level. This method uses a single layer of bitumen between the two cement layers. If you choose this method, Step 6 is not necessary.
- . Put another layer of mortar on top of the chicken wire.

### 5. Cure the lining

- . Keep the walls and inside of the pit damp for at least 5 days. Seven days is better.

- . Do not let the pit dry out quickly!

6. Waterproof the lining There are 2 methods. Here is the most expensive.

- . Brush off any loose concrete with a wire brush.
- . Use a stiff brush to put on a first coat of Bitumen Emulsion. This first coat is diluted -- 1 volume of emulsion to 1 volume of water.
- . Make sure the emulsion gets worked deeply into the lining.
- . Let this first, or priming coat, dry.
- . Apply a layer of undiluted Bitumen Emulsion and let dry.
- . Mix 1 volume of water to 1 volume of cement to 10 volumes Bitumen Emulsion and brush this over the entire inside of the pit.

7. Make the lip

- . Build up the mouth of the pit using stones.
- . Mix concrete of the type used at the bottom of the pit and lay a sloping lip at the mouth of the pit as shown in the drawing. Drain pipes can be used to carry water even further away.
- . Let dry well.

8. Seal the pit

- . A traditional lid can be used.
- . A metal or concrete lid which is sealed with bitumen makes a very airtight storage container.
- . If you choose to use a metal lid place old cloths or sacks between the top of the grain and the cover. This cloth will absorb any moisture which forms on the metal lid.



## OTHER FERROCEMENT GRAIN STRUCTURES

From a VITA Volunteer in India come the following ferrocement specifications and drawings. Since these grain bins are presented in sizes suitable for use by small farmers, they are included here to illustrate further the ranges of ferrocement shapes and applications. These plans were proposed by the Keetaram Agricultural Services, Pvt., Ltd., of New Delhi, India.

### Ferrocement Grain Bin #1 (CB-1)

Useful for seed storage or where smaller batches of various types or qualities of grain have to be preserved. For indoor use, although the design will permit long exposure to sunshine and rain without deterioration of the contents.

The bin has an internal diameter of 750mm and is 1 metre tall. A large manhole, 600mm in diameter, is used for loading and unloading of grain. This manhole is closed by means of a loose fitting cover which is equipped with a facility for padlocking. The bin can be easily sealed by caulking wet clay all around the cover. Since the bin will be placed directly on the floor no opening is considered necessary at the bottom, since this will make the extraction of grain at ground level a very tedious operation. The height of 1 metre makes it easy for the grain to be removed from the top manhole.

The walls of the bin are 12mm thick and have a smooth internal finish preventing lodging of any bacterial infestation. All corners and edges are rounded off for the same reason and to facilitate cleaning of the bin before loading.

This bin holds 0.4 cubic meters. It will store 350kgs of wheat. The bin weighs about 230kg when empty and 580kg when full.

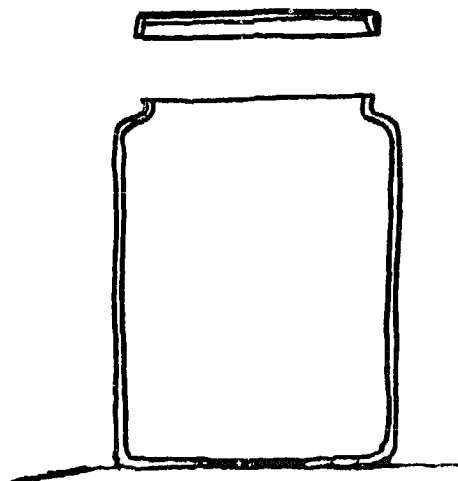

Ferrocement Grain Bin #2 (CB-2)

This has an internal diameter of 1,000mm and a height of 1,500mm. A manhole diameter is provided at the top for loading of grain. The manhole can be closed by means of a loosely fitting manhole cover with a padlocking arrangement. At the bottom of the bin a square opening is provided and this is fitted on with nuts and bolts on to the recessed enclosure of the opening. This cover will be normally opened once a year, when the bin has been emptied and is to be thoroughly cleaned before fumigation. For unloading grain, there is a 8cm diameter sheet metal screw conveyor fitted over the cover. This is manually operated and is estimated to discharge at the rate of about 15kg per minute by manually turning the conveyor at 60 RPM.

The capacity of this bin is 1.4 cubic meters. It will store 1,000kg of wheat. The bin weighs 340kg when empty and, therefore, about 1,350kg when full.

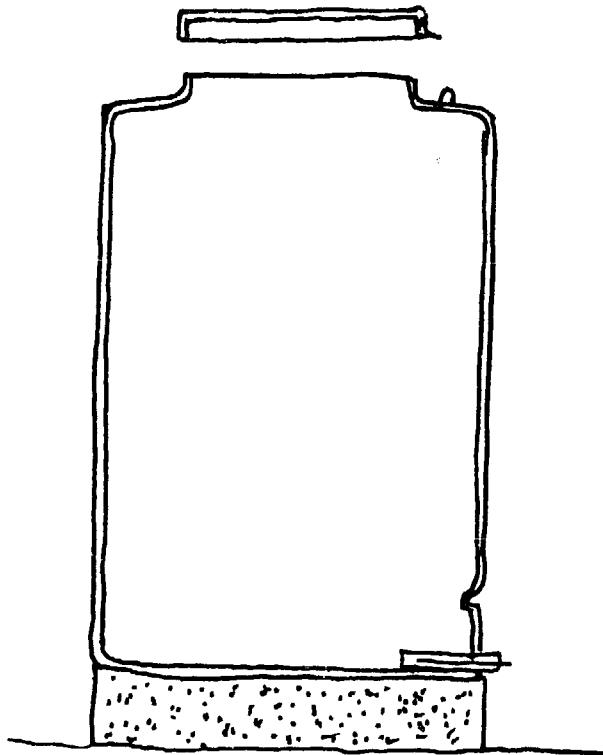

Ferrocement Grain Bin #3 (CS-1)

This is the first of the new series of medium-size bins. It is also a vertical cylinder, having an inside diameter of 1.5 meters and an overall height of 1.5 meters. Because of their large size, these bins will usually be kept outdoors or under open verandahs or corridors. The roof of this bin is dome-shaped so that rain water will run off.

Loading is done by a man standing on a stool. A manhole of 450 mm diameter with a detachable cover is provided in the roof, along with a padlocking arrangement.

Unloading is done at the base through a screw conveyor identical to that described under type CB-2.

The capacity of the bin is  $3\text{m}^3$ , and it will store 2-3 tons. The bin weighs 700kg when empty and 3,000kg when full.

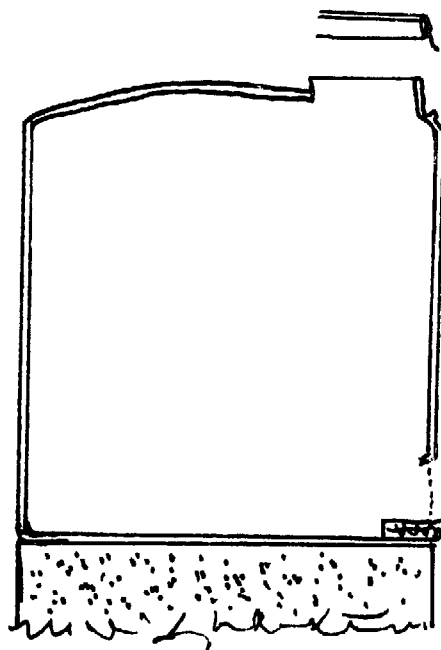

Ferrocement Grain Bin #4 (CS-2)

The second bin in this series has the same inside diameter as type CS-1 viz 1.5 meters, but the overall height is increased to 2.9 metres. The construction of this bin is generally identical with type CS-1. However, because of the height the loading arrangement is different. Provision has been made for installing a pulley at the top manhole. One man standing on the roof of the bin will lift the sack by the pulley and empty that sack into the bin. A detachable ladder is provided for climbing up to the roof.

Unloading arrangements provided at the bottom of the bin are identical with Type CB-2.

The capacity of this bin is 5.4 cubic meters. It will store 4.5 tons of wheat. The bin weighs about 1,100kg when empty and 5,600 when full.

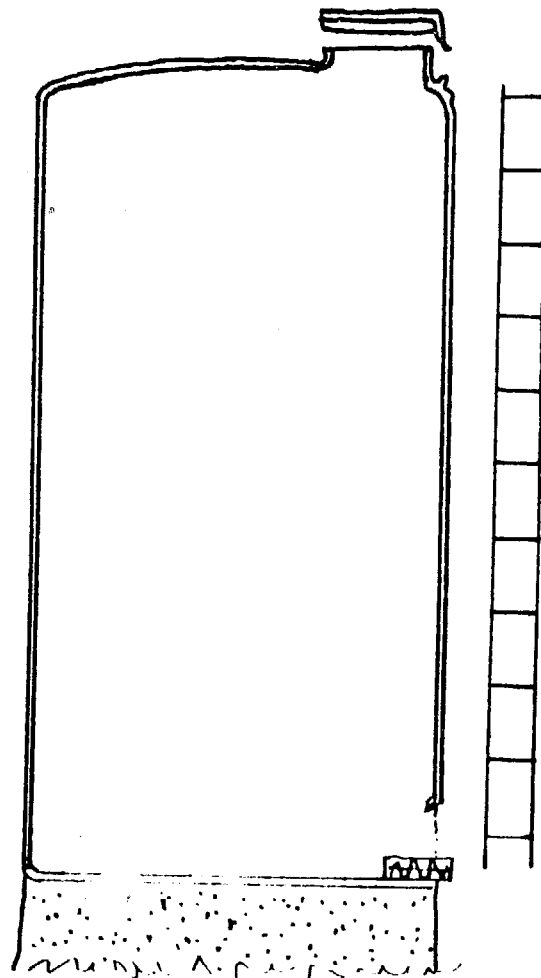

### STORING GRAIN IN CEMENT/CONCRETE STRUCTURES

This manual has already discussed a number of materials used for storage -- mudblocks, plastic, metal, ferrocement. The final construction material discussed here is cement/concrete.

Three plans for storage structures which use cement are offered here.

The first, and simplest, was designed by Peace Corps Volunteers in Senegal and built by local farmers.

BRICK  
SILO

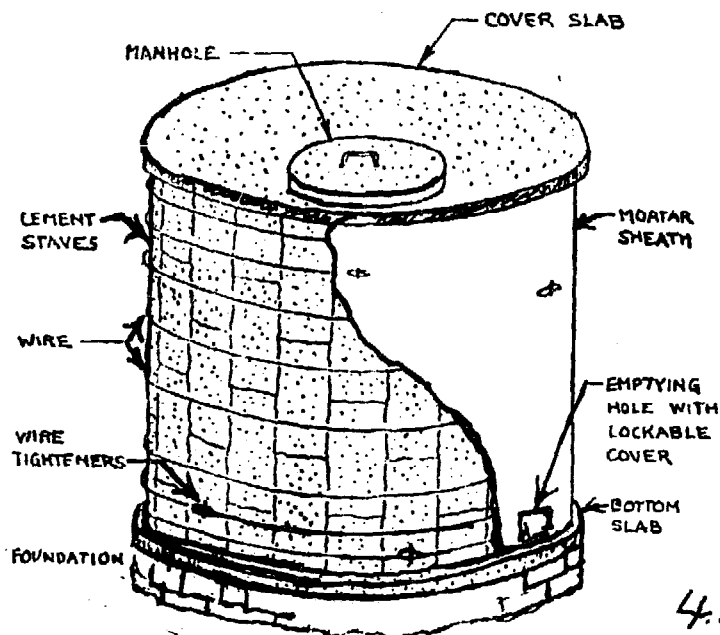
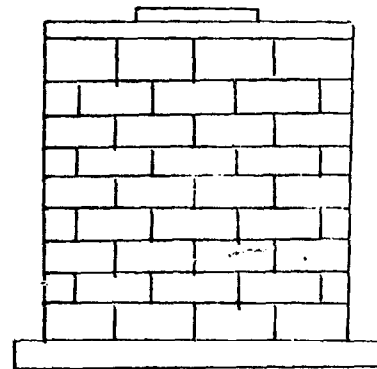

The second plan includes detailed drawings for a 4.5 ton Cement Stave Silo. This silo has been built and tested by Peace Corps Volunteers in Benin. The testing process has led to some design improvements and these have been incorporated into the plan included here.

4.5 TON CEMENT STAVE SILO

The third plan is for building and establishing Concrete Block Square Silos for cooperative storage.

Since small farmers often cannot afford to make improvements by themselves, they enter into cooperative agreements and store their grain all together in large bins. This plan offers a low-cost alternative to the traditional large round silo, and the problems of keeping strict measurements of each farmer's input to the silo, by giving information on how to construct square, multi-celled (each cell is relatively small) silos.

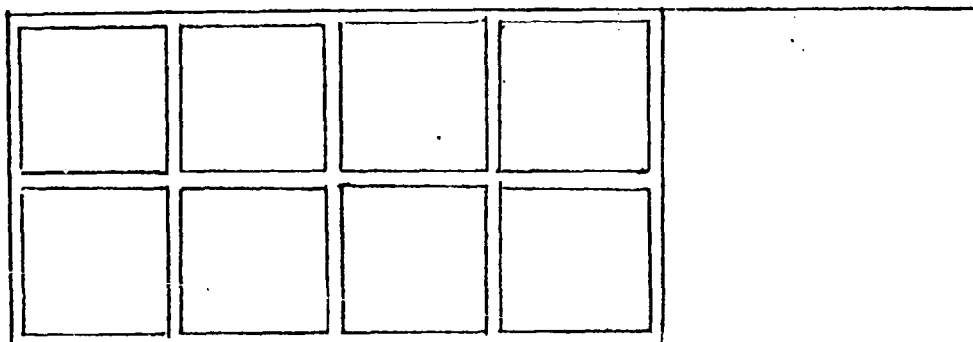

MULTI-CELLED SILO

## BRICK GRAIN STORAGE SILO

Description

Traditional family granaries in West Africa are constructed of clay, bamboo, or millet stalks with a thatch roof. They are easy prey for insects, rodents, fire, and thieves. The silo described here was designed by Peace Corps Volunteers to protect grain against these dangers and, equally as important, to be of low cost and easy to build.

The silo is made of mortared concrete bricks placed on a reinforced foundation. A reinforced cover with a manhole is cast to place over the bricks. The manhole cover can be made of sheet metal for ease in handling, but if welding is a problem, a cover can be cast in concrete.

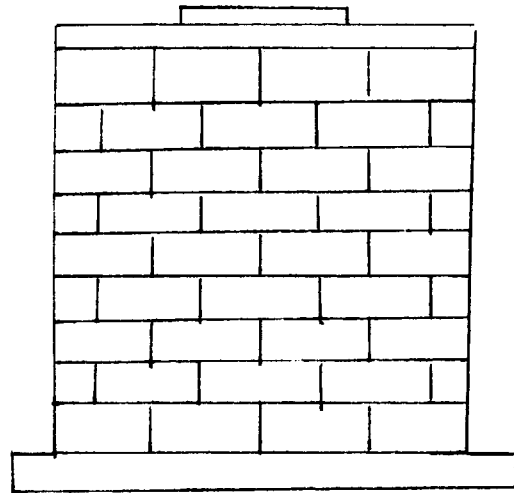

All labor was done by Senegalese villagers with the help of a Peace Corps Volunteer. With the assistance of an experienced village mason, a farmer can do the work necessary to build this silo.

Advantages:

- . Protects against insects and rodents.
- . Easy to build.
- . Does not cost a lot of money.
- . Holds 3m<sup>3</sup> of grain.
- . Easy to reach to take grain in and out.

Disadvantages:

- . Making the manhole cover may be difficult.
- . Moisture may be a problem unless the silo is water-proofed.

## Storage Methods -124-

### Materials and Tools

- . Cement (for bricks, foundation, cover, mortar, plaster) 7 bags
- . Reinforcing rod (6mm) 36 meters
- . Sheet metal for manhole cover as needed.

#### 1. Make Forms for Silo Base and Cover

- . Dig a hole 1.75m x 1.75m and 6cm deep. This is for the silo base.
- . Dig a hole 1.6m x 1.6m and 8cm deep. This hole is for casting the silo cover.
- . Make, and place in the hole, a wooden mold 60cm square by outside measurement.

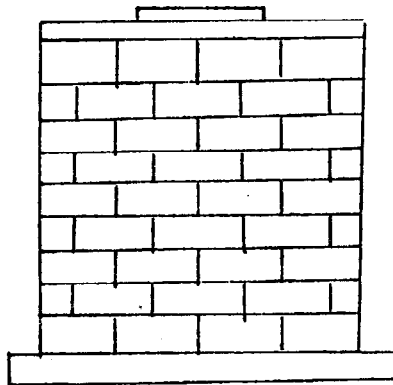

SIDE VIEW

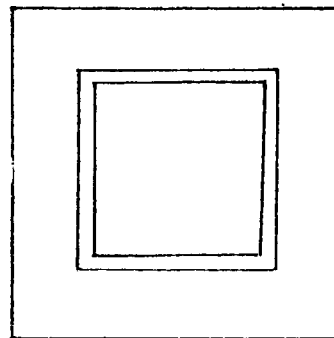

TOP VIEW

#### 2. Make the Base and Cover

- . Cut reinforcing rod for both the silo and base.
- . Mix concrete and pour each form half full.
- . Set reinforcing rods into concrete.
- . Finish pouring concrete.
- . Pour concrete for the cover up to a level of 8cm. When concrete is somewhat set, make and place a form which is 62cm square by 2cm high around the smaller form on top of the already poured concrete. Then pour concrete into



the space between the two frames. This forms the lip around the manhole cover. The manhole cover should be designed to fit around this lip. This gives increased protection from insects and rodents.

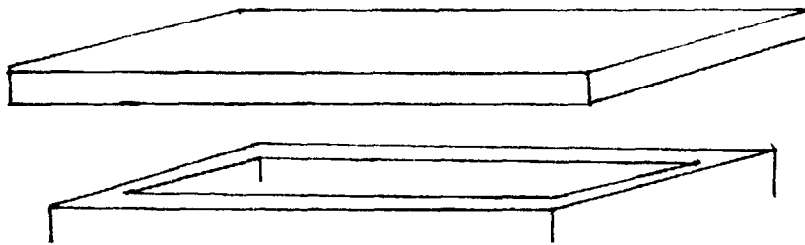

THE MANHOLE LIP

- . Remember to set the staples for the locking arrangement in the wet concrete of the silo cover.



- . Make a manhole cover now if a concrete manhole cover is to be used.
- . Keep the concrete damp. Wet it 3 times a day and keep it shaded.

### 3. Make Bricks

- . Make 100 sandcrete bricks with a mixture of 1 to 5. The exact number of bricks needed depends upon the size of the brick.
- . Dry and cure the bricks for 3 days. Keep them damp so they dry slowly.

### 4. Build the Walls

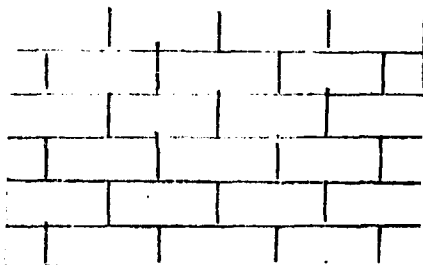

- . Mortar the bricks into place with the corners overlapping alternately for strength.
- . Let the bricks and mortar set for 5 days.
- . Plaster the inside.

5. Put on the Silo Cover

- . Put a layer of mortar on the top edge.
- . Put the cover in place.

6. Put on Manhole Cover

- . Make a steel manhole lid and set it in place. Or put in place an already prepared concrete cover.
- . Lock the cover in place.

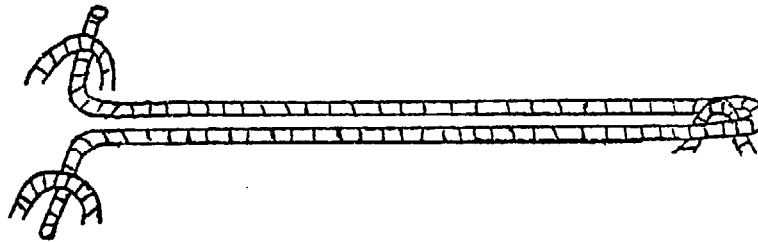

## THE 4.5 TON CEMENT STAVE SILO

This silo was developed in Benin, West Africa, by local agricultural extension agents and U.S. Peace Corps Volunteers. Over 250 of these silos have been built. The plan in the following pages is adapted from one prepared by Peace Corps Volunteers. The drawings were done for this manual by Nicolas Reinhardt, a VITA Volunteer.

The cement stave silo, if protected from rain by a shelter, will keep unwanted moisture away from the stored grain better than earthen-walled silos which have not been specially treated.

In drier areas, the higher cost of the cement stave silo means that farmers should check out other, cheaper types of silos. However, the cement stave silo will work in drier areas as well as more humid ones.

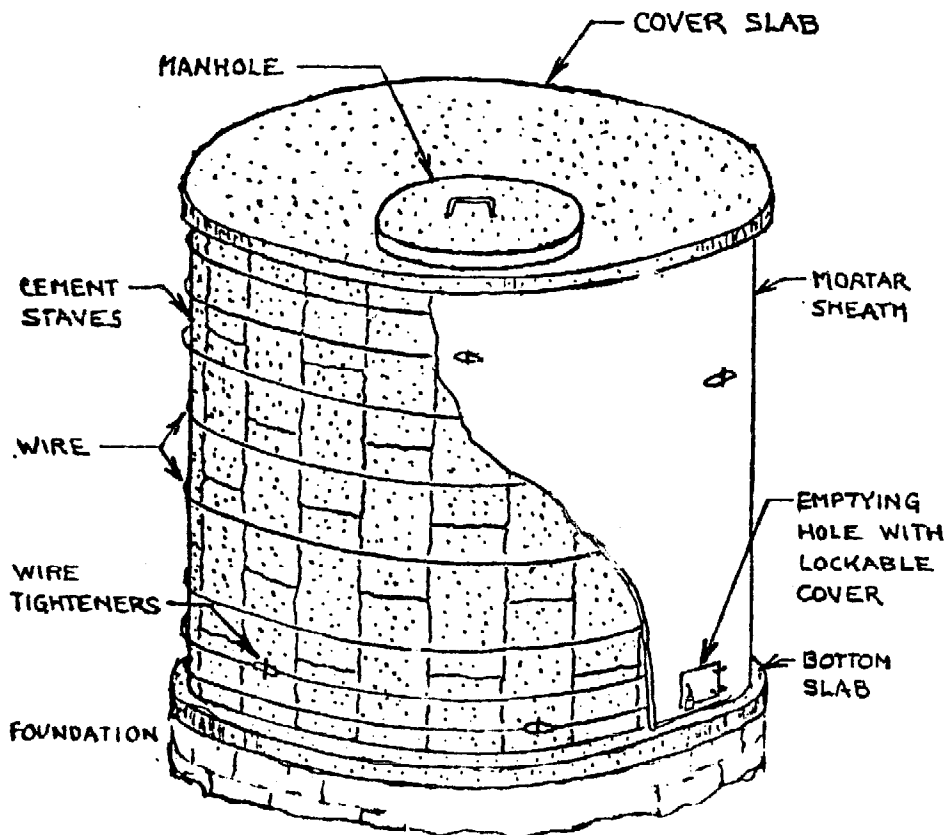

### Advantages

- . Stores large amounts of grain.
- . Gives good insect control when insecticide is added to the grain to kill insects already in the grain.
- . Offers good protection for the grain from rodents.
- . Is less expensive than a metal silo of similar capacity and is more durable.

### Disadvantages

- . Has to be protected from rain or it does not provide good moisture control.
- . Uses materials and equipment which make it more expensive to build than the mudblock silo.

### THE SITE

- . Build the silo on high, well-drained ground. Do not build the silo where it will be in the path of water from flooding or heavy rains.
- . Test the ground to see if it will support the silo. You should build this silo on hard-pan, rock, or stable soil.
- . Dig a small hole, about 65cm deep. If you do not reach hard-packed earth or rock, try another location, if possible. If there is no other location available, and you are in doubt about whether the earth is hard enough, special precautions should be taken.
- . Locate the silo so that it is level. If a dryer, for example, the Pit Oil Barrel Dryer, is being built on the same site, the location must be chosen so that the front of the dryer is facing the oncoming winds during the time of year you will be drying.

## THE SHELTER

A straw or tin-roofed shelter can be built before building the cement stave silo.

- . The shelter protects the silo from rain and sunlight. Also, it provides a good working place for the builders of the silo.
- . It is important to build the shelter so that there is at least 50cm on all sides of the silo (and dryer). This will ensure protection from rain.

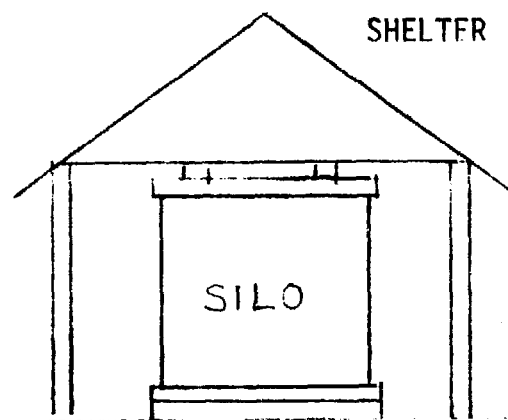

- . The type of roof will depend on what the farmer can afford. A thatch roof can always be replaced by a tin roof after the silo and shelter have had several years to pay for themselves.
- . Many farmers build a larger shelter so that both the silo and a dryer, like an oil barrel dryer, can be put underneath it.

## Tools and Materials

- . Digging tools
- . Tools for working cement and mortar
- . Cement 16 sacks (50kg each)
- . Re-rod (6mm diameter) 10 - 12 bars (each 6m long)
- . Galvanized wire (3mm diameter) 1 roll (4kg)

- . Wire tighteners 10
- . Coal Tar 15 litres
- . Plastic or other suitable moisture barrier material

### Some General Comments

- . Cement should be stored on log supports or plastic: it will harden if stored directly on the ground. If there are lumps in the cement and they cannot be broken easily, they should be removed and the amount of cement should be increased by 1/4 to 1/3.

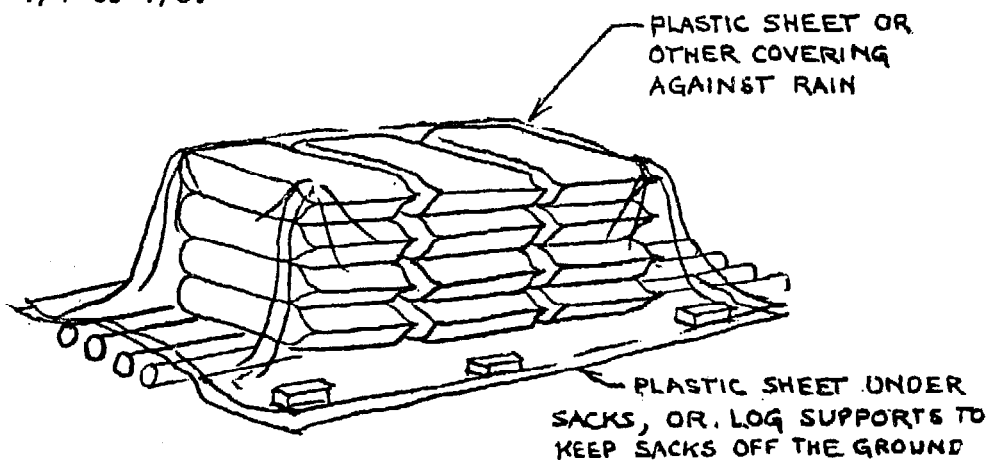

- . Road sand can be used if it is clean and does not have too much clay content.
- . Gravel should be smaller than 1/3 the thickness of the slab in which it will be used. The gravel should be washed if there is dirt or other impurities in it.
- . Water should be free of dirt, oil, and chemicals. These weaken cement. If water will be stored in barrels, these should be washed thoroughly before use.
- . Mixing should be done on cement or on swept, packed earth. Be careful not to scrape dirt into the mixture. When mixing on dirt, all mixtures should be made on the same spot since that spot will harden after the first mixing.
- . Too much water causes cement to separate from the mixture when it is tamped. Losing this cement weakens the mixture. 20-25 liters of water for each 50kg sack of cement is about right for all mixes.

READ THE INSTRUCTIONS THROUGH BEFORE YOU BEGIN1. Make the Forms for the Staves

- Make at least one wooden form (mold) for each of the two sizes of stave.
- Check the forms carefully to make sure they have very flat and regular inside surfaces.

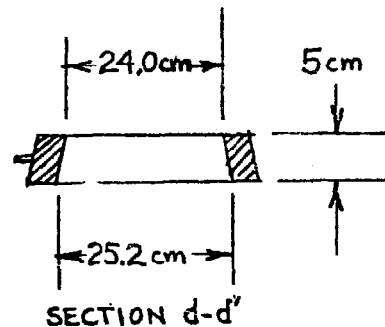
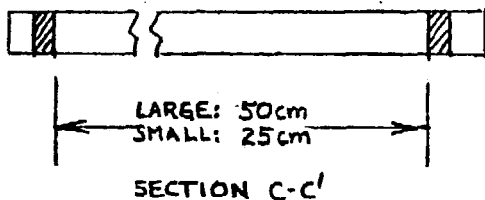
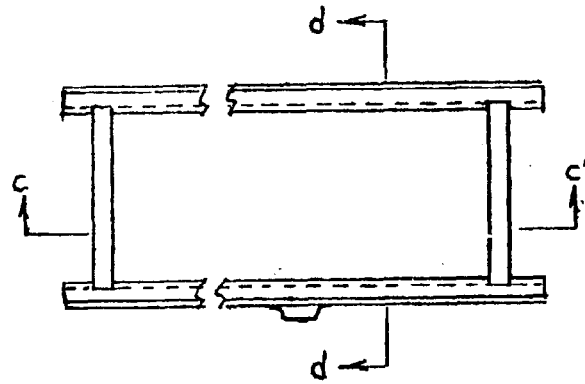

- IT IS IMPORTANT THAT THESE SURFACES BE SMOOTH AND AT THE CORRECT ANGLE. SINCE MORTAR IS NOT USED TO PUT THE STAVES TOGETHER, ITS AIR-AND WATER-TIGHTNESS WILL DEPEND ON THE TIGHTLY FITTING EDGES OF THE STAVES.

2. Make the Staves

- Mix the mortar with a mixture of 1 part cement to 4 parts sand.
- Tamp the staves down firmly, with a bottle, for example. Be careful the cement is not so wet that water runs out of the form or the staves slump.
- Make 91 large staves and 26 small ones for the walls.
- Make 5 more large staves as extras in case of breakage.

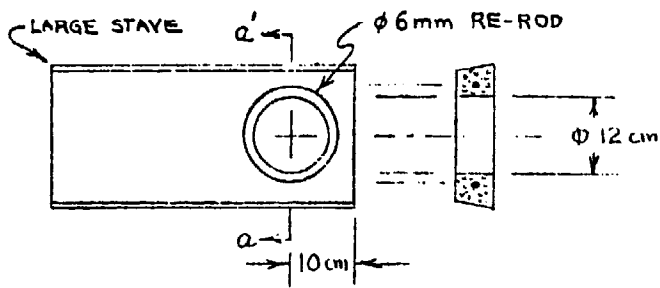

• Make one large stave with a hole in it (12cm in diameter) for inserting the emptying plug.

- Place a ring of 6mm re-rod (50cm long) around the hole for added strength.
- Cure the staves.

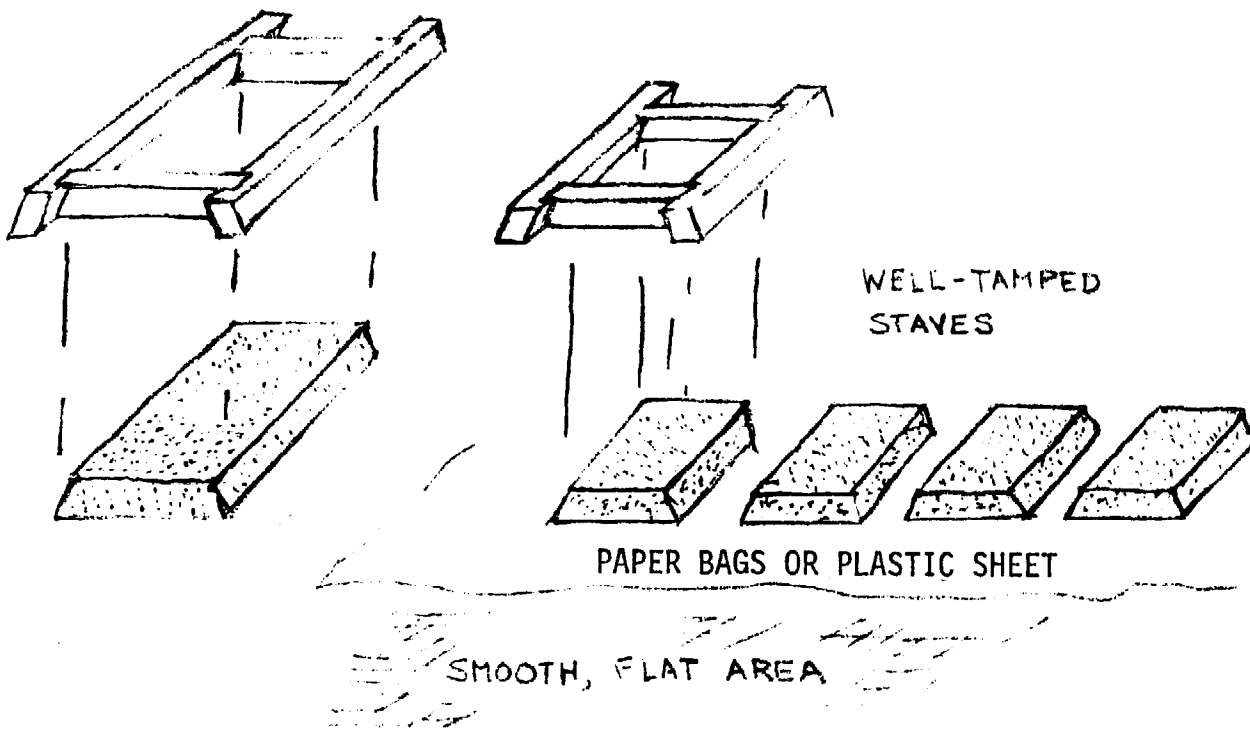

- ★ WATER CONCRETE 3 TIMES DAY DURING CURING PERIOD
- ★ KEEP STAVES IN SHADE OR COVER WITH STRAW





### 3. Make Bricks for the Foundation

- . Make a form of 14x20x30cm for making bricks. This form will give the size blocks used in this particular plan.
- . Use a mixture of 1 part cement to 4-7 parts of sand, depending upon the quality of the sand and cement.
- . Make about 80 bricks for a foundation like the four-brick layer foundation pictured below. (The actual number of layers depends upon how far down you must dig to find hard-packed earth or rock upon which to build the foundation.)
- . Make 8 more bricks, if you feel the earth is soft under the silo, or if you are not sure the floor slab is going to be made of very good quality cement. These 8 bricks will make a pillar in the center of the foundation.
- . Be sure to water and dry the bricks the same way as you did the staves.
- . Substitute regular, already made concrete blocks of the type used in houses, if they are a good size to use and if they are strong.

### 4. Build a Foundation

- . Dig a hole with an outside diameter of 2.2m. The foundation should rest on hard-packed earth or rock.

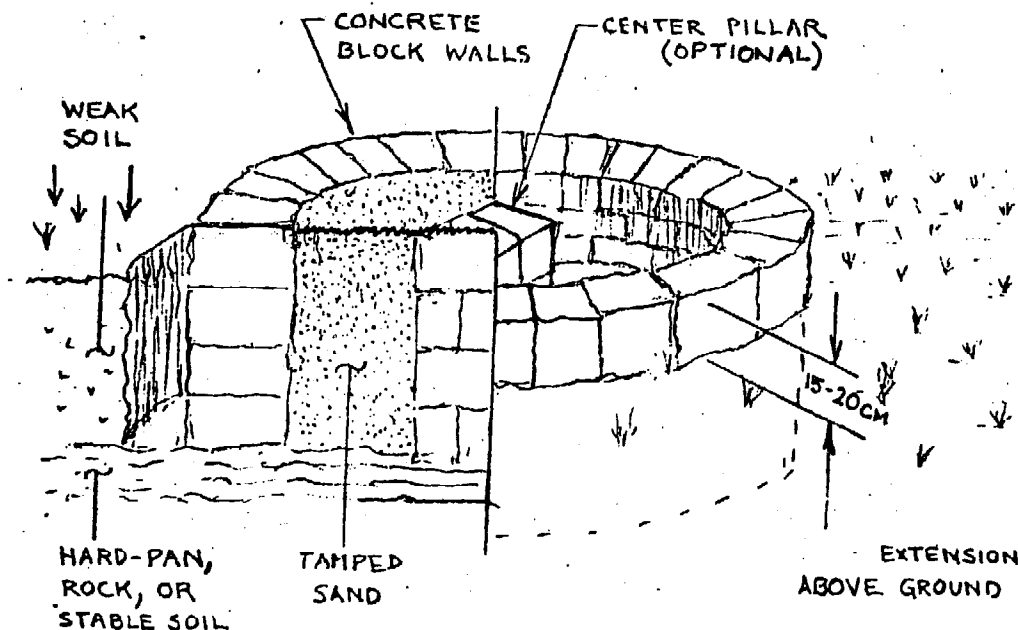

- . Lay the bricks using a mortar consisting of 1 part cement to 6-8 parts sand.
- . Lay the bricks so that each one crosses over a joint between bricks in the layer below. This will make the wall stronger.
- . Be sure the foundation extends 15-20cm above ground level.
- . Build the pillar, if required, by placing two bricks, joined with mortar, in the center of the foundation hole. Lay the second layer of bricks with mortar crosswise over the first layer. Continue laying bricks and mortar until the pillar is even with the top of the foundation.
- . Fill the foundation with sand and hard-pack (tamp) the sand to the level of the top layer of the foundation.

#### 5. Waterproof the base

- . Use plastic sheets, coal tar, or tar felt.
- . Lay a 3cm layer of mortar on top of the hard-packed sand if using coal tar or tar felt. This is not required when plastic is used.
- . Overlap joints of tar felt 20cm and spread coal tar on the seams.
- . Use 4 layers of coal tar if that material is chosen to paint over the 3 cm layer of mortar.

#### 6. Make a Form for the Floor Slab

- . Use 29 large staves (temporarily) to make the form for the floor slab.
- . Place the staves around the outside of the foundation wall in a 2.2m diameter circle. In other words, the circle of staves will be flush with the outer perimeter of the foundation wall.
- . Hold the staves in place using two wires and wire tighteners.
- . Line the inner face of the staves with paper, plastic, or masonite to prevent sticking when the staves are later removed.

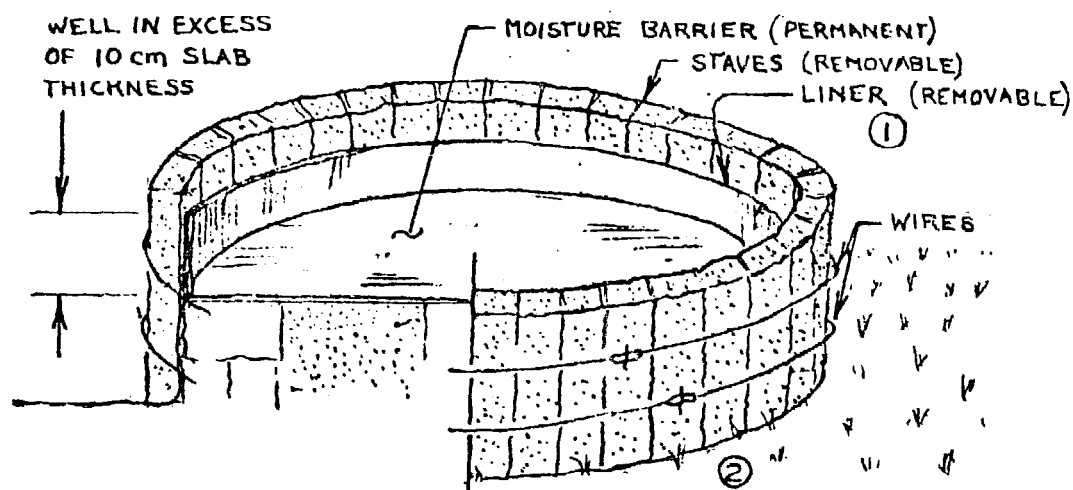

- NOTES:
1. LINER MUST EXTEND WELL ABOVE 10 CM SLAB THICKNESS
  2. WIRE TIGHTENERS MUST BE PLACED IN CENTER OF STAVE BACKS.

- . Mark the form to show a point 4cm above the base and another point 10cm above the base. These marks will guide you when you pour the concrete into the form.

#### 7. Form the Re-rod Pattern for the Base

- . Form a 6.6m re-rod perimeter for the slab.
- . Use one 6m piece of 6mm re-rod and one 1m piece.
- . Bend the ends of each re-rod piece to form 10cm hooks.
- . Join these hooks together to make a longer bar for the perimeter.
- . Leave an extra 10cm at each end when cutting re-rods. These extra lengths will be bent to form hooks for attaching the straight bars to the perimeter re-rod. The two longest straight re-rods are each 2.3m long. A total of 18 straight re-rod pieces will be needed.

- . Put the re-rods into position.
- . Attach all hooks and intersecting points with fine wire.
- . Place the finished re-rod pattern into the form to be sure it fits -- before you pour the cement.

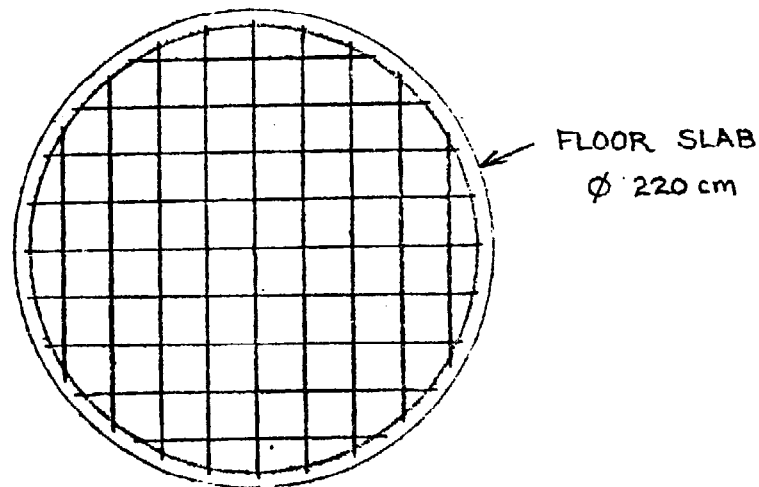

#### 8. Mix and Pour Concrete for the Floor Slab

- . Use a mixture of one part cement, two parts sand, and three parts gravel (1:2:3).
- . Mix the concrete so that it can be worked easily but does not flow.
- . Wet the inside of the form completely before pouring the concrete.
- . Pour 4cm of concrete before placing the re-rod pattern in.
- . Tamp the concrete down well.
- . Put the re-rod in and finish pouring concrete to the 10cm level marked previously.
- . Tamp very well. THIS IS IMPORTANT.
- . Smooth and level the surface carefully.
- . Water the slab 3 times per day for 7 days. Keep the slab shaded.

## 9. Mount the Wall

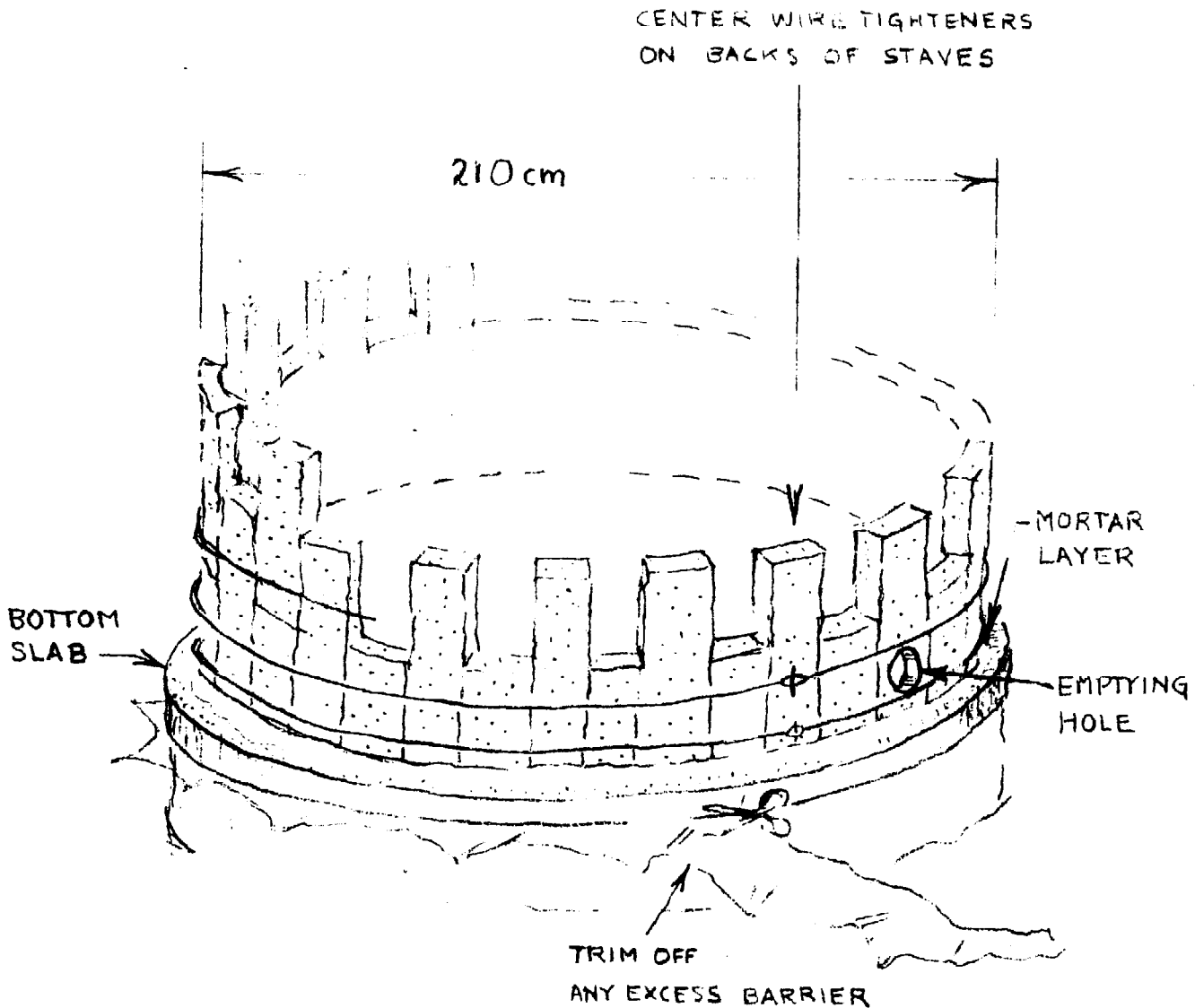

- Mark a circle of 100cm radius from the center of the slab.
- Place 13 large and 13 small staves around the circle, alternating the large and small staves, with their smaller faces inside.
- Place a thin layer of 1:6 mortar under the bottom row of staves for proper seating.
- Place the large stave with the emptying hole in the first layer, with the hole toward the bottom slab.

- . Place no mortar between the staves.
- . Place and tighten a retaining wire at each 25cm of height.
- . Place 2 wires in the bottom 25cm, 8cm from the top and the bottom of the small staves (one above and one below the emptying hole).
- . Place the tighteners for these 2 wires only on the large staves. When tightened, the tighteners should be centered on the large staves.
- . Form each following layer by placing 13 large staves in the gaps until reaching a height of 2.0m (4 large staves vertically).
- . Complete the final layer by placing 13 small staves in the remaining gaps.
- . Hold these staves in place with 2 wires, 8cm from the top and 8cm from the bottom of the small staves.

#### 10. Make a Form for the Cover Slab

The cover slab is like the floor slab except that it must have a filling hole and is only 8cm thick.

- . Cover the top of the wall completely with solid boards. These must extend beyond the edge of the wall.
- . Place an upright collar of masonite on the boards 5cm outside the edge of the wall.
- . Hold the collar in place with nails.
- . Support the boards from within the silo if they are not strong enough to support a man without sagging.
- . Cover the boards completely with paper or plastic inside the masonite circle to prevent the concrete from sticking to the boards or from leaking through any large cracks.
- . Place the manhole (for entry and filling) form 20cm inside the masonite circle. The form should be about a 50cm diameter circle made with an inverted basket, or masonite held in place with nails.

### 11. Form the Re-rod Pattern for the Cover

- Form the re-rod pattern in the same way as you did the floor slab except that space must be left for the manhole.

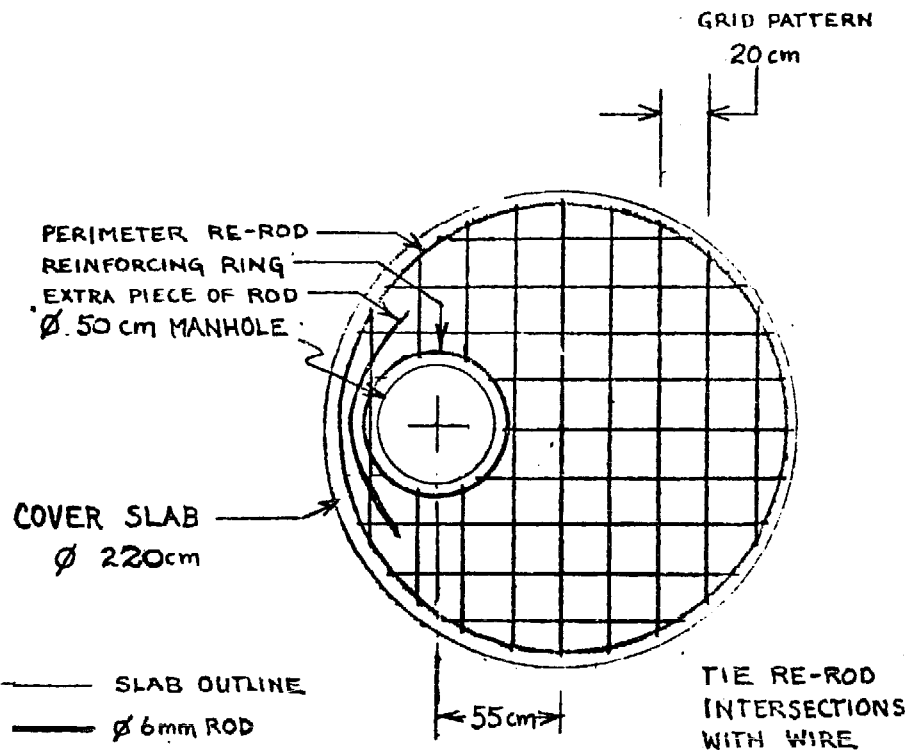

- Test the pattern in the form for fit before pouring concrete.

### 12. Make the Cover

- Mix another batch of 1:2:3 concrete for the cover.
- Pour and tamp a 4cm layer of concrete before placing the re-rod pattern.
- Place the re-rod pattern.
- Pour the remaining 4cm layer of concrete.
- Tamp and smooth out the slab with a slight slope away from the entry hole.

- . Make a manhole cover 6cm thick and 60cm in diameter with the remaining concrete.
- . Use a masonite strip or a hole dug in the ground and lined with paper as a form.
- . Place a re-rod, bent into the correct shape for a handle, into the concrete. This re-rod also gives added strength to the cover.

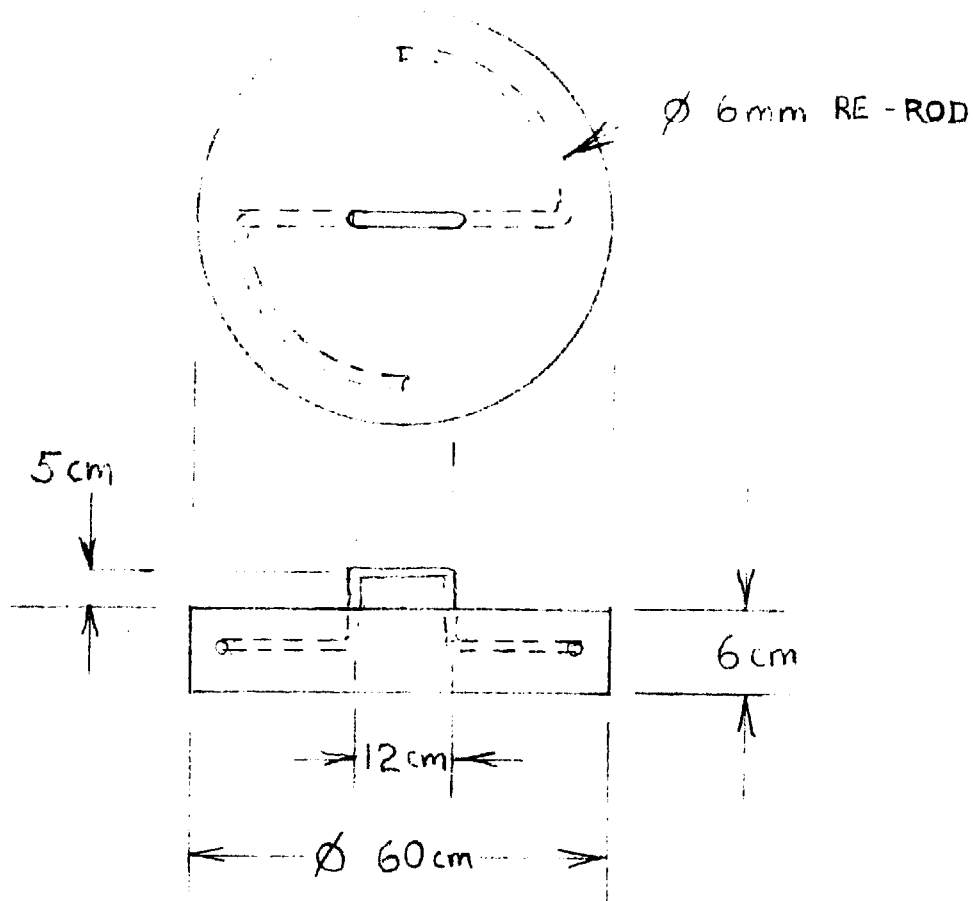

- . Cure and dry the cover slab and the manhole cover in the same way as the bottom slab. (Wet the concrete 3 times a day for 7 days and keep the concrete shaded.)
- . Be sure the slab is dry before removing the form (wait at least 10 days). It is easiest to remove the boards by gently levering the edges of the slab, sliding out boards as you go.
- . Be careful not to apply pressure to the strip between the manhole and the outer wall. This strip is the weakest part of the slab.



- Close the space between the cover slab and the upper walls with mortar after taking out the boards of the form.
- Place a sealing ring cut from a rubber inner tube, for example, around the manhole. Or make a sealing ring of mortar. If you use a piece of rubber, cover the rubber with mortar. Cover the mortar with paper, and place the manhole cover on it. This will provide a raised horizontal joint to prevent water from getting into the manhole.

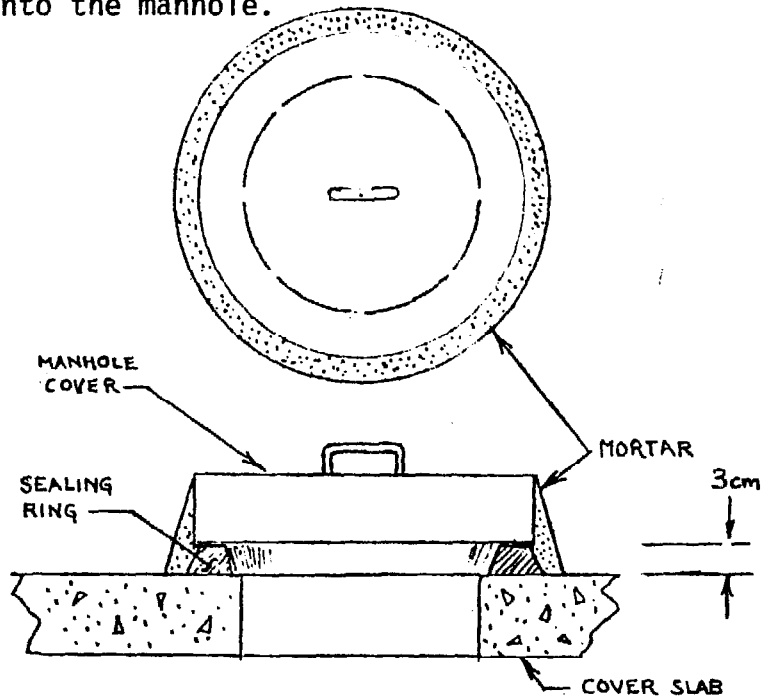

### 13. Make a Security Plate (Anti-Theft System)

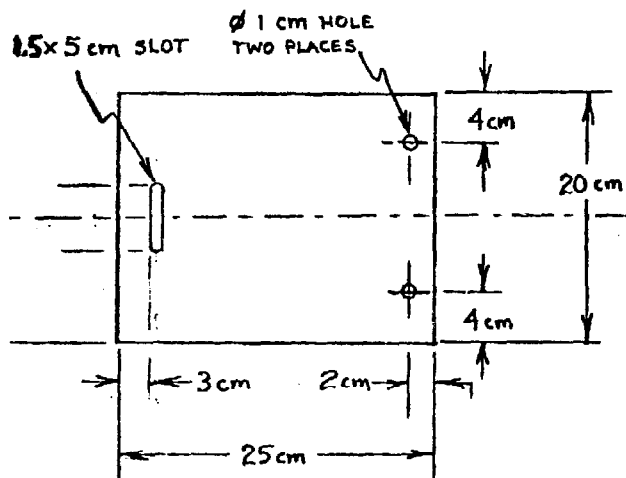

HASP PLATE (Make from barrel bottom)

- Use the bottom of an oil barrel or a piece of heavy sheet metal.
- Cut a piece 20cm x 25cm.
- Pierce two holes on one of the 20cm sides, 2cm in from the side and 4cm from each end. A hinge will pass through each of these holes.
- Cut a slot 5cm long and 1.5cm wide, centered on the other 20cm side of the metal piece, 3cm from the edge.

- Use the remaining re-rod material to make a staple and two hinges.

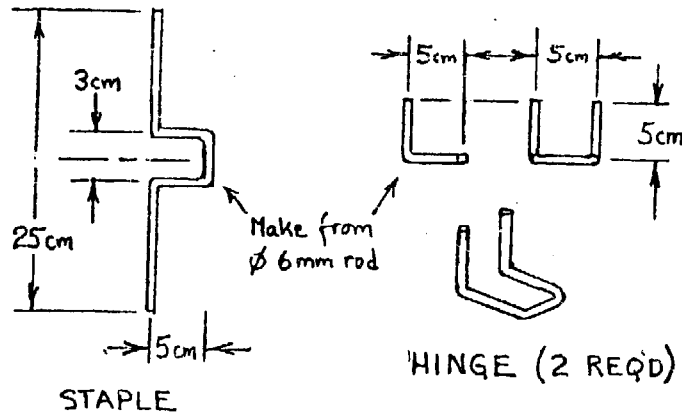

14. Plaster the Silo

- Make a 1:6-8 mortar mixture.
- Install the security plate before plastering the outside. Apply the mortar 2cm thick.

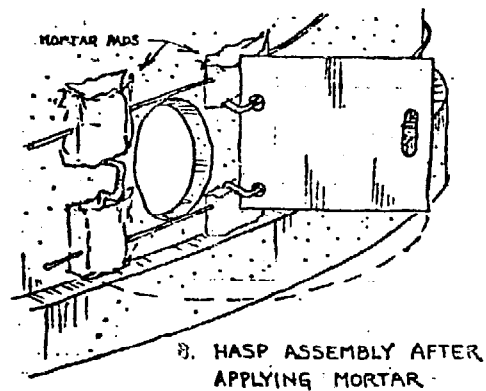
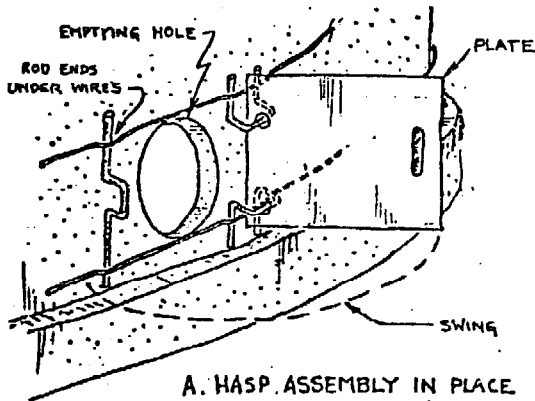

- Plaster the outside walls to a thickness of 2cm.
- Close the inside joints with a cement wash or plaster to keep grain from getting stuck in the joints and to increase moisture resistance.

- Put the plastic plug into place and use mortar to form a tight fit between the plug and emptying hole. BE CAREFUL NOT TO SEAL THE PLUG SO FAR INTO THE HOLE THAT YOU CANNOT PULL IT OUT.

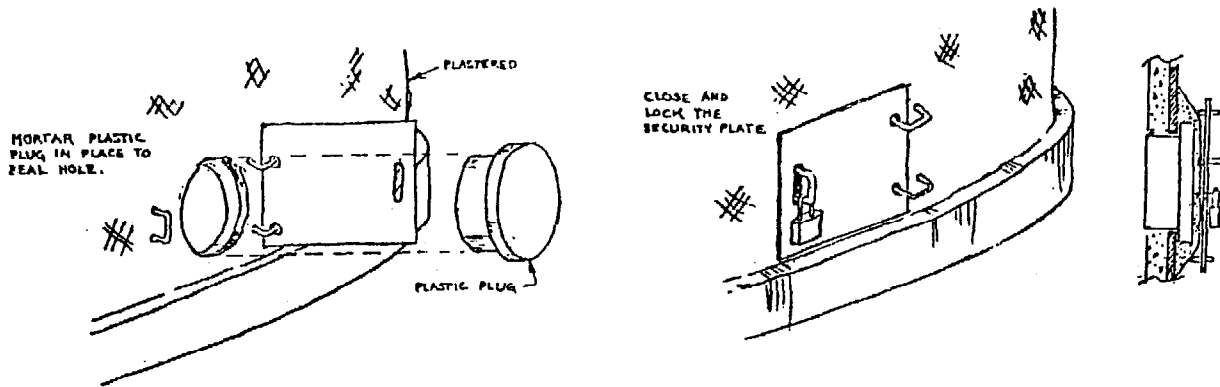

## 15. Paint the Silo

- Let the silo dry after plastering for at least one month before using it.
- Do not apply coal tar to any plastered surfaces until after the plaster has been allowed to dry for at least two weeks.
- Apply coal tar to the outside surfaces of the silo wall and to the cover slab to increase the silo's moisture resistance further.
- Paint the inside floor with coal tar. If the floor is painted, let it dry for at least two weeks before storing grain so that the grain does not stick to the tar.

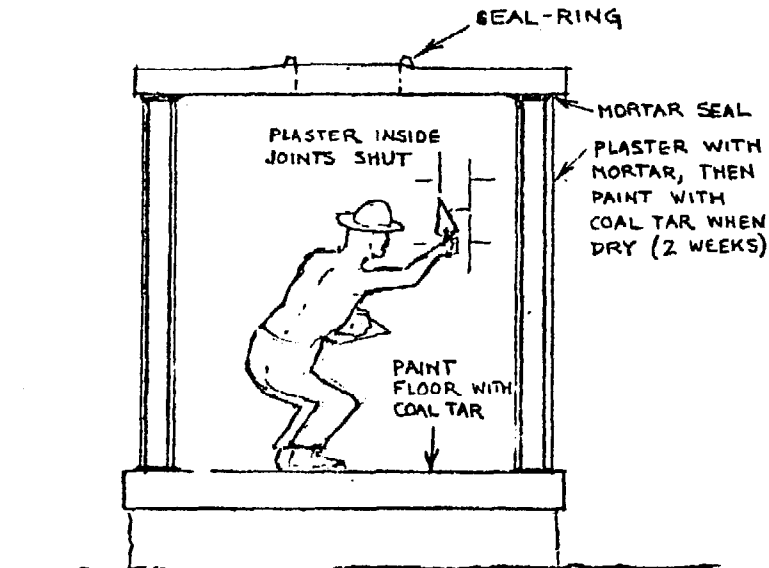

## INSTRUCTIONS FOR USE OF THE CEMENT STAVE SILO

To be sure of good quality storage for your grain, it is important to understand the proper way to use the Cement Stave Silo. This can be done easily by a few steps taken at the right times.

The Shelter

The silo must have a good roof over it for protection from rain.

- Check the roof often to be sure there are no holes in it which will let rainwater fall on the silo.
- Repair holes immediately.

The Silo

- Make sure the filling and emptying holes are well sealed during storage times. Each time you add grain to the silo, carefully re-seal the filling hole. Use cement mortar or banco (hand-packed, wetted earth). Banco is, of course, less expensive and is easier to use. If the emptying hole does not seal tightly with mortar, it can be sealed with melted candle wax or banco.

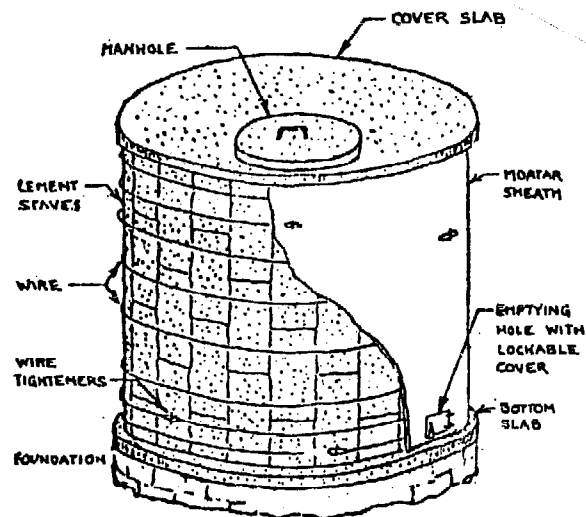

- Clean the inside of the silo and check for cracks in the walls shortly before the beginning of storage each year. Light will pass through even the smallest cracks. If cracks are found, cover them carefully with a mixture of cement and water.
- Use insecticides when storing grain in this silo. Even though the silo is completely closed and insects cannot enter to attack the stored grain, there will always be some insects in the grain at the time of filling. These insects not only destroy the grain by eating it, they can cause conditions which lead to rotting.
- Open the emptying hole each month to make sure the grain is storing well and that no insects are alive inside. When you open the silo, if it seems very warm inside, or if there is a smell of rotting grain, empty the silo immediately. Re-dry the grain.

CONCRETE BLOCK SQUARE SILOS  
FOR COOPERATIVE STORAGE

Many farmers form cooperatives and store their grain collectively in large bins. This allows the farmer to get better quality storage (and drying) than he could afford as an individual.

The formation of farmers' cooperatives is an important subject. But this manual edition will not deal with coop formation and processes. However, the following plan is presented as an illustration of how newer ideas and methods of storage can be applied to cooperative storage situations. It is presented as an alternative to the larger, round silos so often used for cooperative storage.

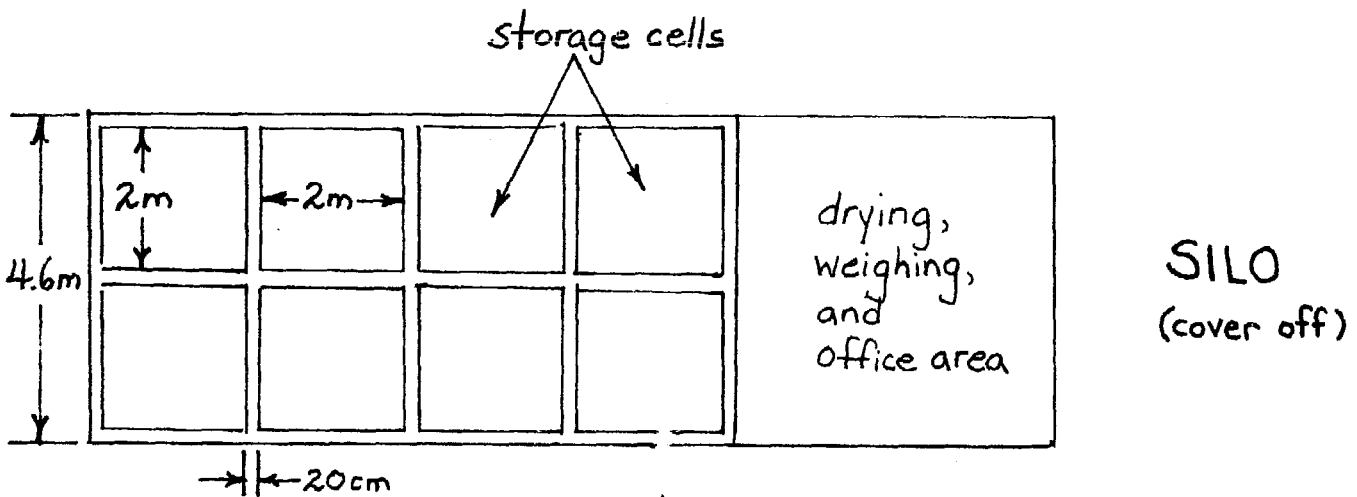

Some of the Advantages of the Square Silos

- Less expensive to build than groups of round silos because the walls are shared. Also, building a group of round silos of the same capacity would take a greater area and would mean greater roofing costs.
- Easy to expand by adding more storage cells on to the ends and/or sides.

adding  
storage  
cells

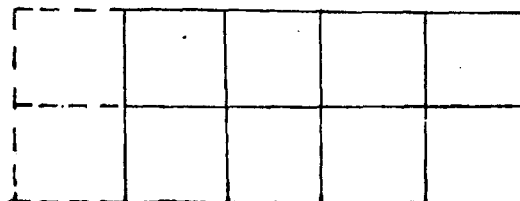

- . Stress and pressure of the grain on the walls is not as great as in the round silo because each storage cell is relatively small.
- . Only one cell has to be opened at a time to get out a farmer's grain. This means that opening the bin is not going to mean that the grain in all the other bins must be re-fumigated, as would be needed if a large round silo had to be opened.

#### DESCRIPTION

This multiple celled storage bin has a capacity of 30 tons. It is constructed of brick and re-inforced concrete with outside dimensions of 9m x 4.6m. It has 8 storage cells with inside dimensions of 2m x 2m. A 4m x 4m open space for weighing and grain drying is sheltered by the roof at one end. Each storage cell will have an opening on the top to fill the silo and a chute at the bottom to remove grain.

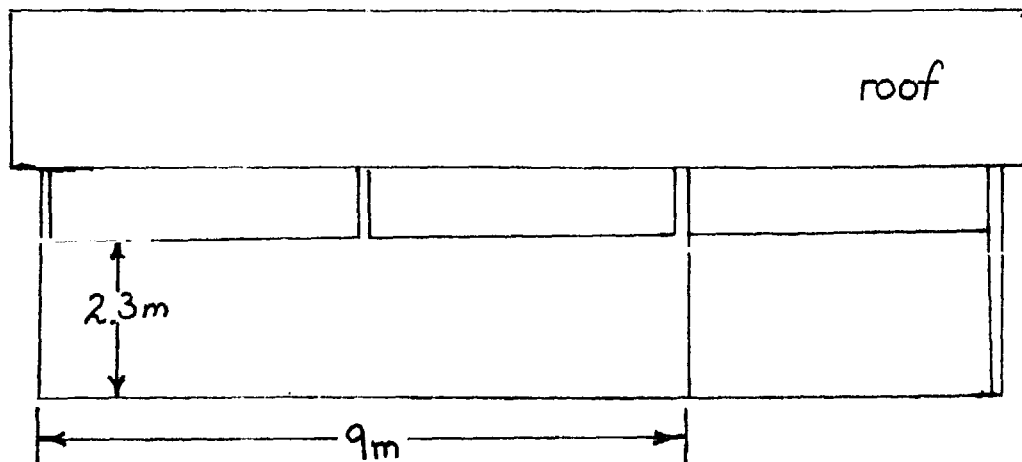

## 1. Build the Walls

- . Dig down to solid sub-soil.
- . Pour a pad of re-inforced concrete 25cm thick x 25cm wide. This will extend under the inside and outside walls of the storage cells.
- . Make wall bricks of fired clay brick or use concrete blocks.
- . Make two layers of re-inforced concrete: one, halfway up the walls and the other at the top of the walls. These layers of concrete will support the stress of the stored grain and prevent bursting of the bin walls.

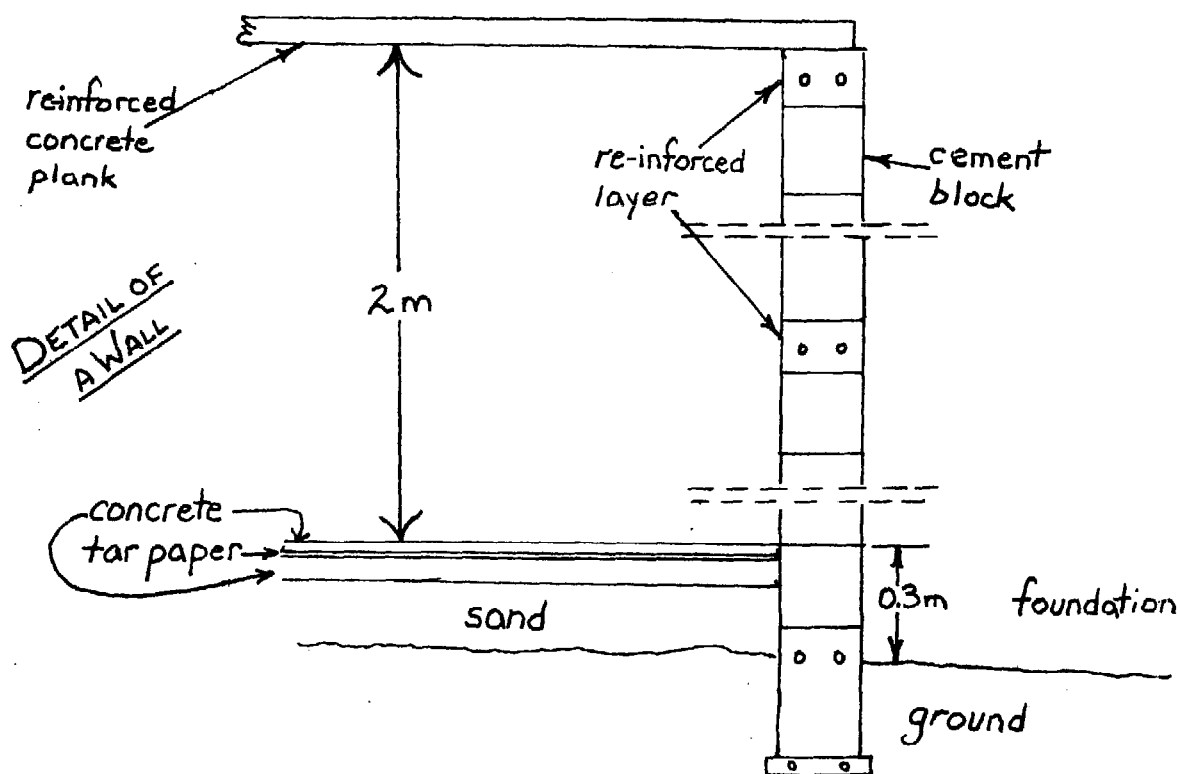

## 2. Make the Floor

- . Fill and pack sand or coarse gravel in the bins to a height 20cm above ground level. This layer of sand or gravel will reduce the amount of ground moisture which will be in contact with the floor slab.
- . Lay a 7cm thick floor slab of re-inforced concrete on the hard-packed sand.
- . Put a layer of tar paper (or other waterproofing material) on the concrete floor slab.

- . Coat all edges and seams of the tar paper with a heavy layer of roofing tar.
- . Pour a final 3cm thick layer of concrete on top of the tar paper. This will protect the tar paper moisture barrier from being damaged later during storage. The final floor level is approximately 30cm above ground level.

### 3. Finish the Walls

- . Cover the walls with a rough cement plaster on both the inside and outside.
- . Paint the outside walls with coal tar or other water-repellant material.

### 4. Cover the Bins

- . Make 8 individual slabs of reinforced concrete.
- . Make the slabs on the ground using reusable wooden frames.
- . Make a form which leaves a 60cm x 60cm opening for filling the bins.
- . Place the re-inforced slabs side by side to cover the silo cells.
- . Join all edges and seams with a heavy layer of roofing tar.
- . Fill with grain, put concrete cover over the filling hole and seal with roofing.

### 5. Make a Roof

- . Cover the entire building with a roof, for example, of corrugated sheet metal or local thatch.

### 6. Dig a Drainage Ditch

- . Dig a gutter along the sides of the building where the roof is pitched.
- . Slope the ground away from the foundation.



## **Appendix A**

This Appendix contains some examples of different ways of presenting grain storage information. The examples are from Asia, Africa, and South America, thus highlighting the fact that good grain storage is an important subject all over the world.

# MPEPU WA IPELEGISIWA

## GRAIN STORAGE IN MUD CRIBS

The traditional Botswana designs of mud cribs are easy to build and the materials cost very little. By taking more care over some details during construction, you can reduce the risk of insect damage to stored grain.

### BUILDING A MUD CRIB

Choose a place where the ground is firm and well drained, because a crib full of grain is heavy and may sink into soft or wet ground.

Bring several large, smooth stones and bury them firmly in the ground to form a base.

Use strong, straight poles for the main crib supports and lay them on the stones. Cut notches or fix pegs at the ends of these poles to prevent the floor poles from slipping.

Make a floor of mud and build up the mud walls.  
Reinforce the mud ceiling with poles.

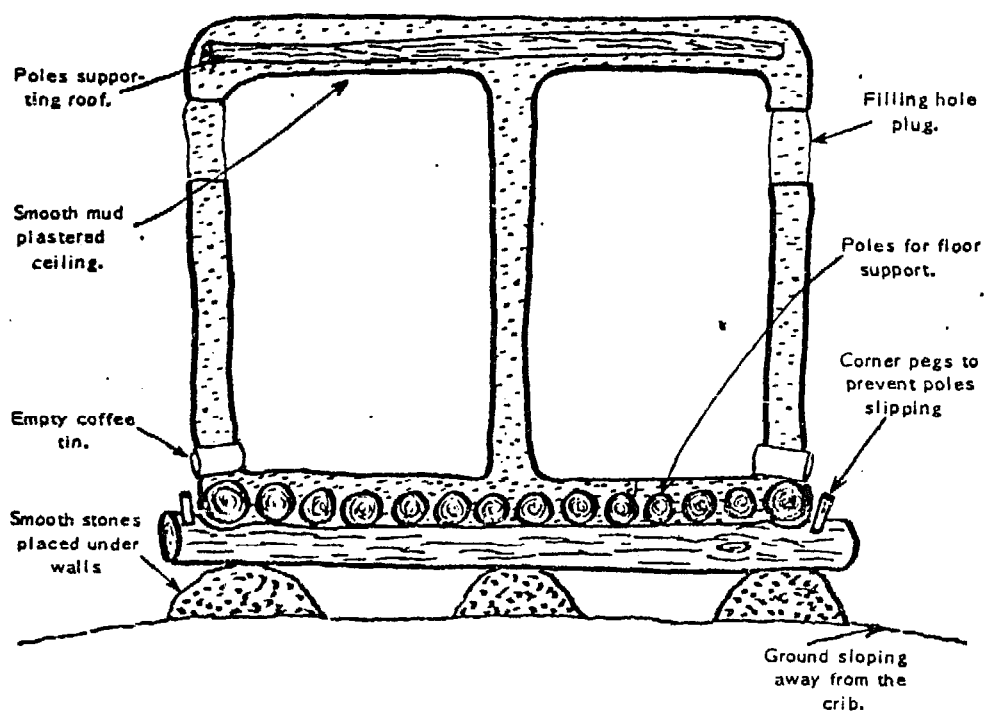

Make an outlet at the bottom of each compartment to permit easy removal of grain. Use an empty coffee or dried milk tin with a lid of the press-in type. First cut out the bottom, then build the tin into the wall at floor level.

Build the walls right up to the ceiling so that each compartment is completely separate and there is no chance of insects moving from one compartment to the next.

Plaster the inside walls and ceilings. Insects hide in cracks and crevices and in the poles of the ceilings. Therefore plaster the ceilings also, so that there is no gap between the walls and ceilings.

Method of removing grain.

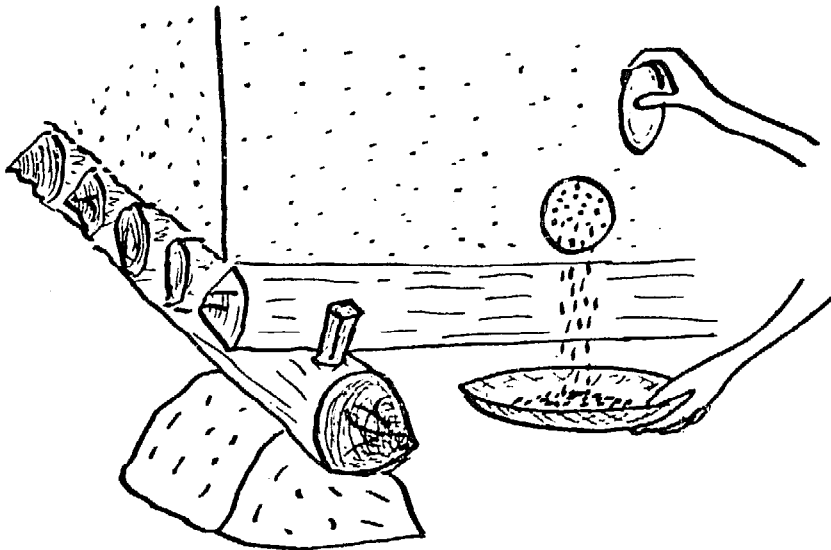

Wide thatch to keep rain and sun off the mud crib.

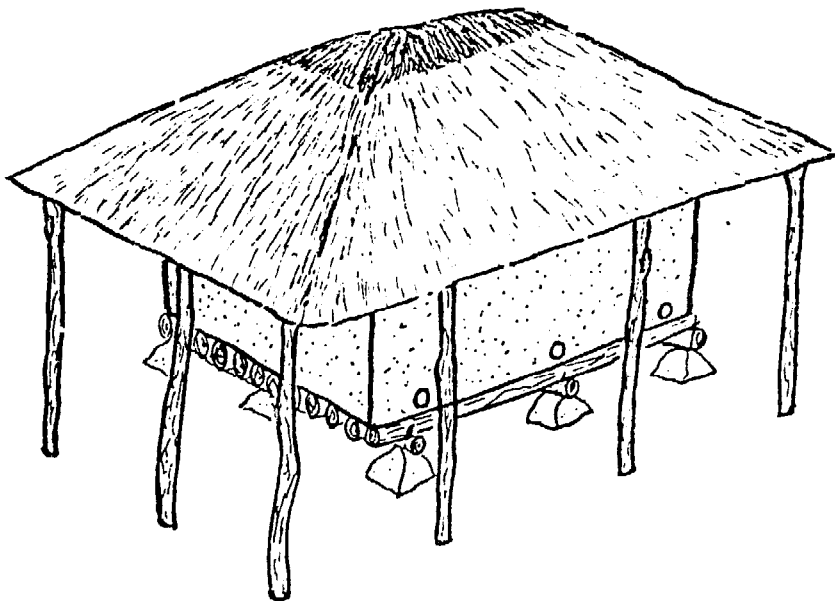

Cover the completed mud crib with a thatch roof supported on separate poles. Thatch should be thick and rain proof especially along the ridge. The roof must also extend well beyond the crib so that rain cannot reach the mud walls, and the hot rays of the sun never shine on the crib.

The plug for filling the crib should be smeared over with mud to make the crib airtight and insect proof. Grain is removed by opening the lid of the tin at the bottom of the wall.

#### USING A MUD CRIB

The crib should be repaired before each harvest. Mend the thatch and re-plaster over cracks in the walls, floor and ceiling.

Thoroughly clean out the empty crib by brushing. Do not keep old baskets, skins, sacks, etc. on top of the mud crib. These things harbour the beetles that attack grain and it is easy for them to walk into the crib.

Make sure that new grain is always quite dry and has been winnowed or sieved before you put it into a crib. Never mix new grain with old grain remaining from the previous year.

To stop insects damaging your grain, admix Kopthion or Pyrethrum dust (1 packet of dust to each 200 lb. of grain.) These insecticides are preferred but the ash from cattle dung or wood may be used. Mix not less than one bucket of sieved ash with each 200 lb. of grain. Examine the condition of your grain every 2 months by removing a sample and looking for live insects. If you find them, remove the grain, winnow it and admix Kopthion or pyrethrum before returning it to the crib.

#### CAUTION :

Grain intended for human consumption should be first sieved or winnowed and washed — especially if it has been treated with insecticide or ash.

If you would like further help, ask your Agricultural Demonstrator.

**KEEP THIS LEAFLET FOR FUTURE REFERENCE**

**SAVE GRAIN**

A-7

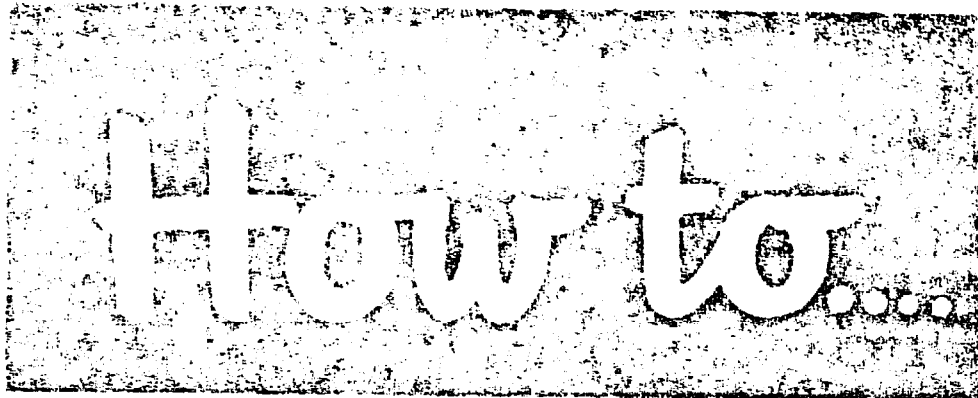

**PROTECT YOUR  
GRAIN IN STORAGE  
FROM DAMAGE**

---

*Distributed through :*

**SAVE GRAIN CAMPAIGN**

(Country Wide Programme)  
DEPARTMENT OF FOOD,  
NEW DELHI-1.

*Apply the 5 Golden Rules :*

- **Dry and clean your grain before storing.**
- **Use dunnage to avoid moisture damage to grain stored in bags.**
- **Use domestic bins or improve your storage structure.**
- **Fumigate with EDB ampoules to avoid insect damage.**
- **Use anticoagulant for rat control.**



**1. Dry and clean your grain before storing.**

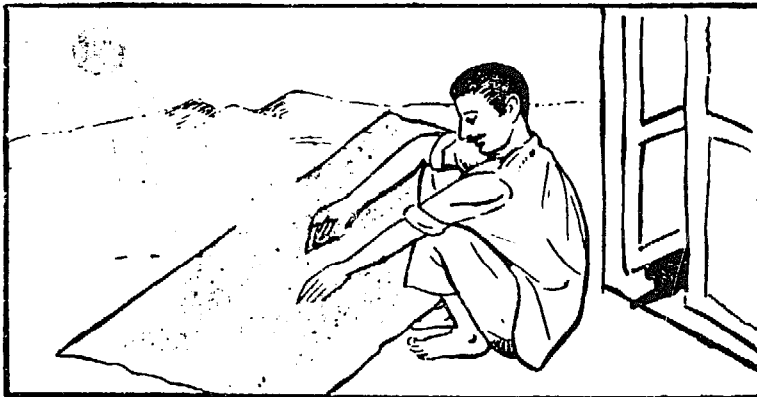

Dry grain stores longer



Clean grain stores better



**2. Use dunnage to avoid moisture damage to grain stored in bags.**

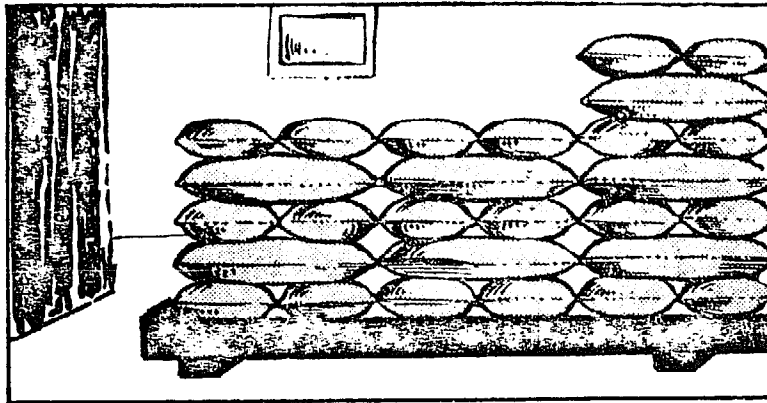

Wooden crate and bamboo mat prevent moisture pick up from ground.

**3. Use domestic metal bins.**

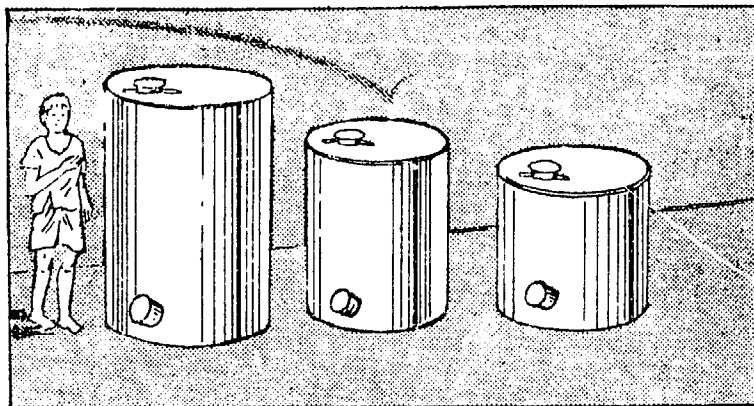

Select the bins to suit your needs. Improved bins are moisture proof and rat proof. It is easier to fumigate grain in them for insect control.

OR

Improve your storage structure

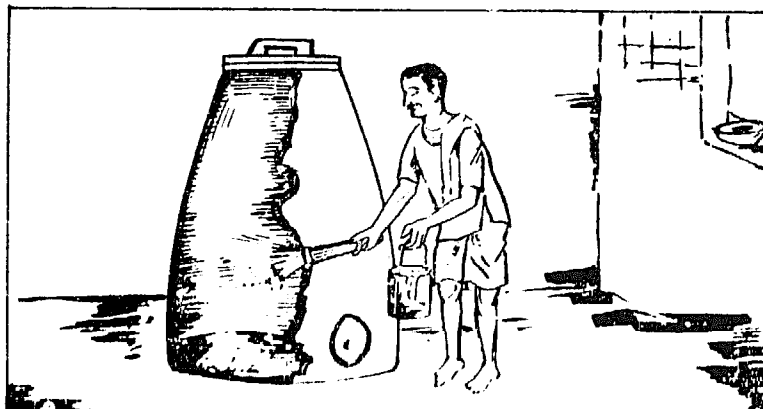

Examine your storage structure before storing grain. Clean it. Attend to cracks and crevices, and white wash it and also make it rat proof and moisture proof as far as possible.

**4. Fumigate with EDB ampoules to avoid insect damage.**

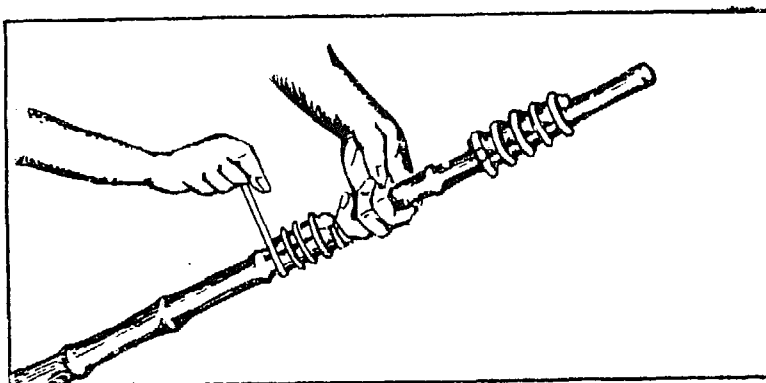

Fumigate when the grain is stored. Check periodically and fumigate again if you find live insects.

**5. Use anticoagulant for rat control.**

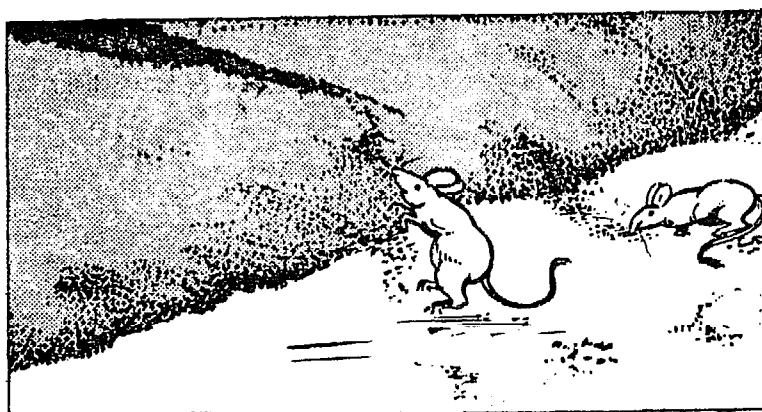

Rats damage stored grain and contaminate it with their excreta

FOR ADVICE ON YOUR STORAGE

PROBLEMS AND TRAINING

CONTACT ANY OF THE

FOLLOWING PLACES

IN PERSON OR

BY POST :

— : o : —

## SAVE GRAIN CAMPAIGN

Department of Food  
Ministry of Agriculture  
Krishi Bhavan  
New Delhi-1.

OR

Post Box No. 10  
Hapur (U.P.)

Post Box No. 7823  
Bombay

Post Box No. 509  
Patna (Bihar)

Post Box No. 22  
Bapatla (A.P.)

Post Box No. 158  
Ludhiana (Pb)

---

*Prepared by :*

**INDIAN GRAIN STORAGE INSTITUTE**

**HAPUR (U. P.)**

**CONSERVE SANO SU MAIZ**

A-13

# **EN TROJAS**

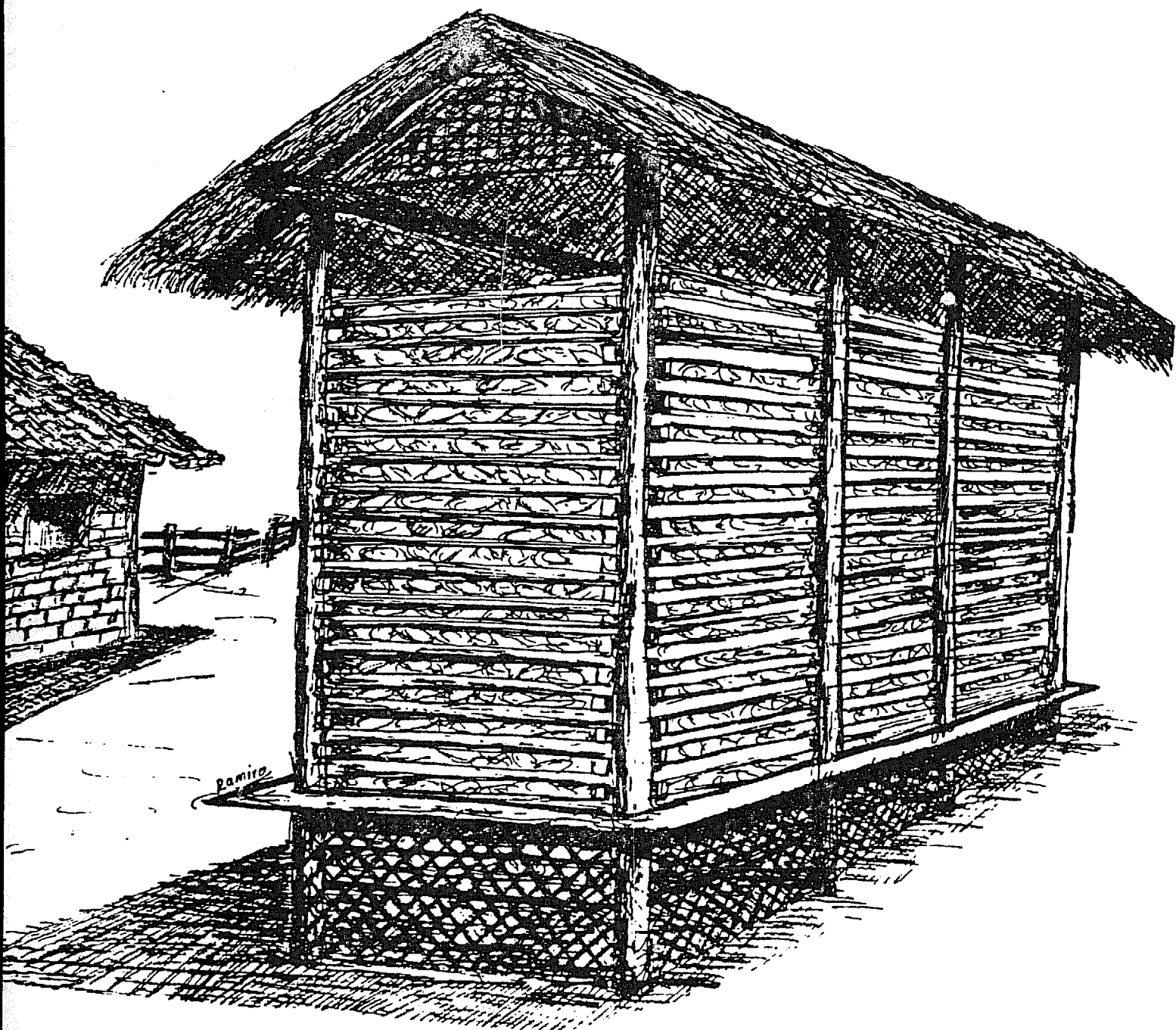

**MINISTERIO DE AGRICULTURA Y GANADERIA**

**Sección de Productos Almacenados-Extensión**

Managua, D.N., Nicaragua, C.A.

PRESERVE CORN SAFELY IN STORAGE BARNs

MINISTRY OF AGRICULTURE

Division of Stored Products-Extension

Managua, D.N., Nicaragua, C.A.

**Preparado por:** Ramiro López  
Asistente de Extensión de  
Productos Almacenados.

**Revisado por:** Agro. Francisco Estrada  
Jefe de Extensión de  
Productos Almacenados,  
M.A.G.

## EVITE PERDIDAS DE SU MAIZ EN LA TROJA.

Cada año, durante el período comprendido entre la cosecha y el momento en que el producto llega al consumidor, el exceso de humedad del grano, el ataque de roedores, hongos, insectos y pájaros, originan pérdidas considerables al agricultor y al comerciante.

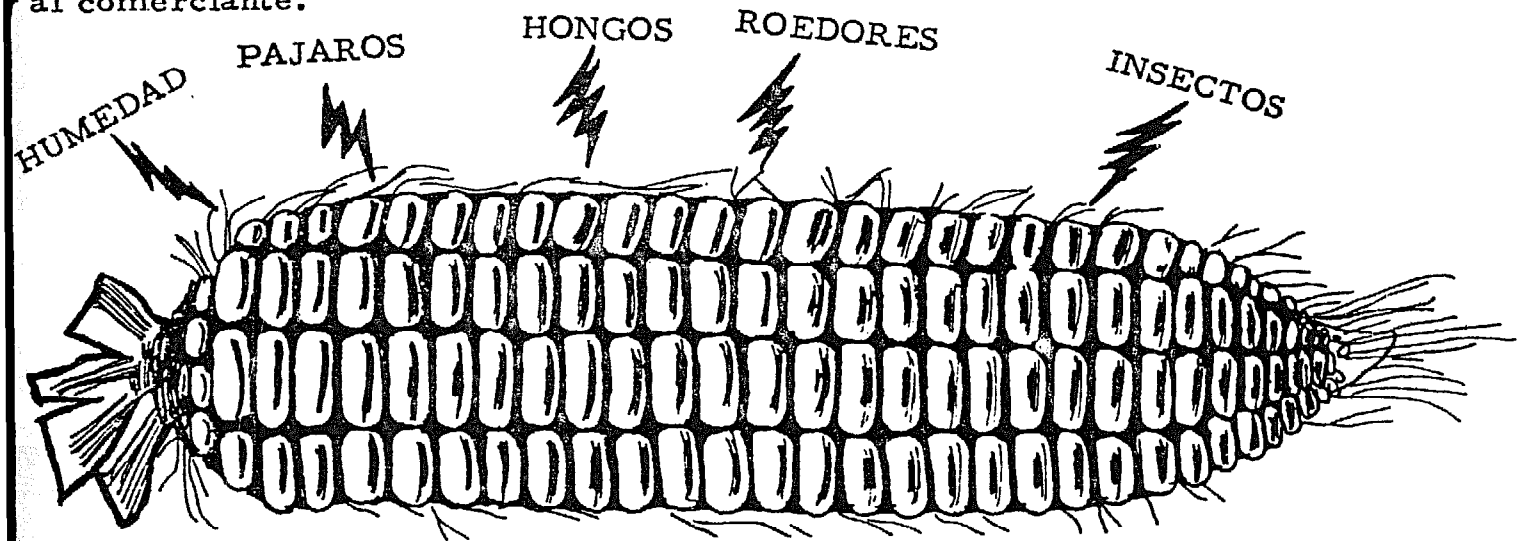

ESTOS FACTORES AFECTAN EL BUEN ALMACENAMIENTO DEL MAIZ

La manera de evitar tales pérdidas, es el control sobre las causas antes mencionadas, mediante un manejo eficiente de los granos, y dándoles una adecuada protección durante el almacenamiento.

La humedad, el primero de estos factores, puede controlarse de una manera efectiva, mediante un buen secamiento del grano, antes de guardarlo en el almacén o granero; bajando su contenido de humedad hasta un 12% o sea cuando esté bien seco.

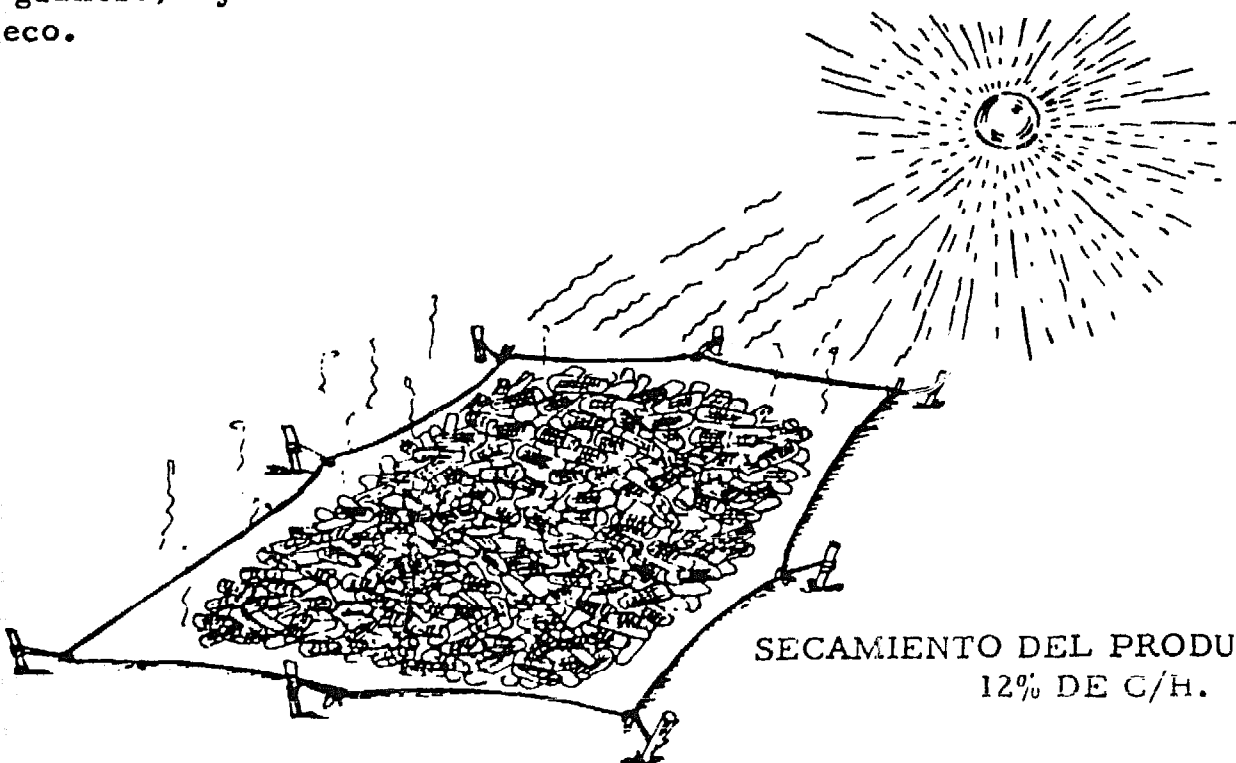

SECAMIENTO DEL PRODUCTO HASTA  
12% DE C/H.

## PREVENT STORAGE LOSSES OF YOUR CORN IN THE BARN

Each year, during the period between the time of harvest and the time when the grain reaches the consumer, there are considerable losses for the farmer and merchant. These losses are due to excess grain moisture, the attack of rodents, molds, insects and birds.

MOISTURE    BIRDS            MOLD                    RODENTS                INSECTS

These factors affect the good storage of grain

The best way to prevent such losses is to control the causes by proper handling and adequate protection of the grain during storage.

Dampness, the first of these causes of grain loss, can be controlled effectively by good drying before storage. The safe moisture content for corn is 12% or lower.

DRYING THE PRODUCT TO 12% OR LOWER

Prácticamente, podemos calcular, si la humedad en el grano está buena para conservarlo, cuando al morderlo, éste se quiebra, sin presentar elasticidad y que no esté lechoso.

También podemos saber que el grano no está aún bueno para almacenarse, cuando al introducir la mano entre estos granos, sentimos el calor proveniente de ellos, que por exceso de humedad se encuentra en plena actividad respiratoria; en cambio, se sentirá fresco el grano cuando debido al secamiento, haya disminuido dicha actividad; entonces los granos estarán reposando y podrán ser almacenados, sin mucho riesgo de que se desarrollen hongos, y sin peligro de que se pudran.

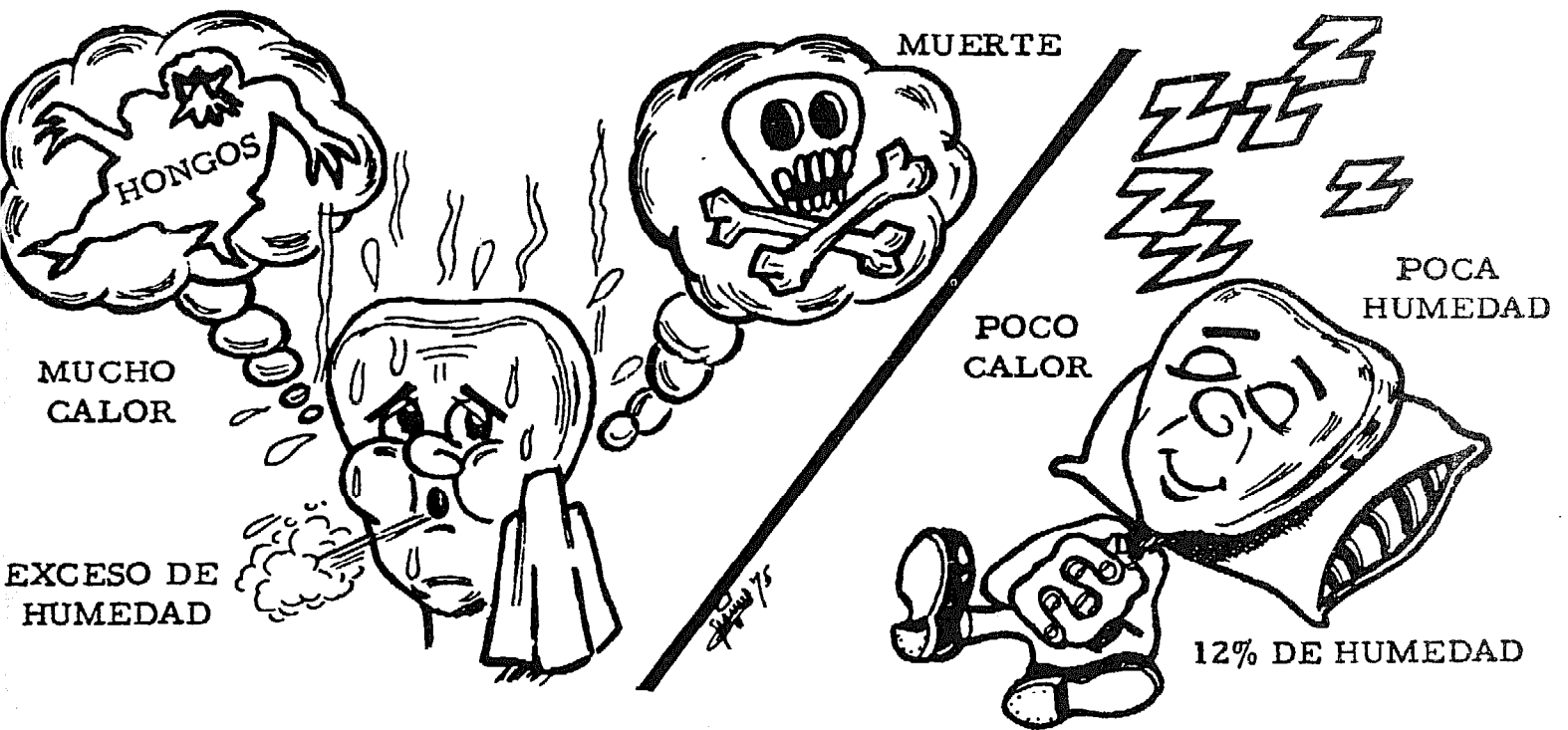

La humedad y el calor excesivos, son ambientes propicios para que se desarrollen hongos que ocasionarán daño al producto que se almacena.

El daño por roedores puede evitarse en gran parte proporcionando al local de almacenamiento una adecuada protección, contra el acceso de las ratas. También manteniendo los alrededores del granero limpio de malezas y desperdicios, ya que estos roedores prefieren no movilizarse por sitios despejados.

Es muy efectivo para su control el uso de raticidas en forma de cebos, de los que se venden en el comercio, tales como Racumín, Zelio, etc.

No se deben dejar estos cebos al alcance de los niños ni de los animales domésticos, porque son productos muy venenosos.



In practice, we can check the moisture content in the grain which is safe for good storage by biting it. Dry grain is hard, so it will break with a sharp crack, rather than crushing easily like wet grain.

We can also find out if grain is in good condition for storage by touching it. If we feel heat rising from the grain, it is too wet. If the grain is excessively wet, it will respire, producing heat and moisture. On the other hand, dry grain will feel cool. If grain is giving off heat, it should be dried immediately to assure storage without risk of mold development and rotting.

## DEATH

## MOLD

TOO MUCH  
HEATLITTLE HEAT  
LITTLE MOISTURETOO MUCH  
MOISTURE

12% MOISTURE

Moisture and excessive heat are favorable conditions for the growth of molds which will damage the grain.

Damage by rodents can be avoided to a large extent by protecting the storage area against the invasion of rats. Also, the surrounding areas of the granary should be kept clean of weeds and garbage as rodents prefer not to move through open, clear areas. The use of pesticides such as Racumin, Zelio, etc., in the form of bait, is effective for control of rodents.

These pesticides should not be left within the reach of children or pets because they are extremely poisonous products and can cause serious illness or death. Rat poisons should always be used very carefully, following recommended instructions.

## COLOCACION DE CEBOS PARA RATAS

LATAS

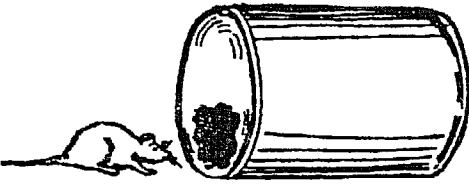

BAMBU

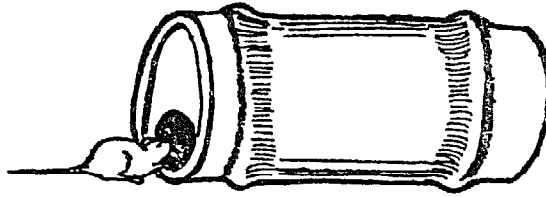

CAJAS

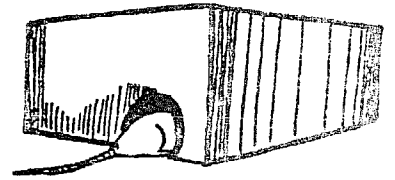

EN LUGARES TRANSITADOS POR LAS RATAS,  
FUERA DEL ALCANCE DE NIÑOS Y  
ANIMALES DOMESTICOS.

El daño por insectos, es el que generalmente causa mayores pérdidas en los productos que se almacenan. Su control se debe ejercer desde el momento en que está comenzando a florecer en el campo el maíz que se piensa cosechar y almacenar. En este tiempo en que ya está espigando el maíz, los insectos pueden estar en alguna troja infestada, cercana al plantío de maíz; vuelan hacia el campo en busca de nuevo alimento y comienzan a penetrar la mazorca por las aberturas de la tuza: resultándoles más fácil la penetración, cuando esta tuza ofrece escasa protección al grano.

Es por esto que algunas variedades mejoradas, se pican más fácilmente que las variedades criollas, pues éstas, generalmente poseen buena cobertura.

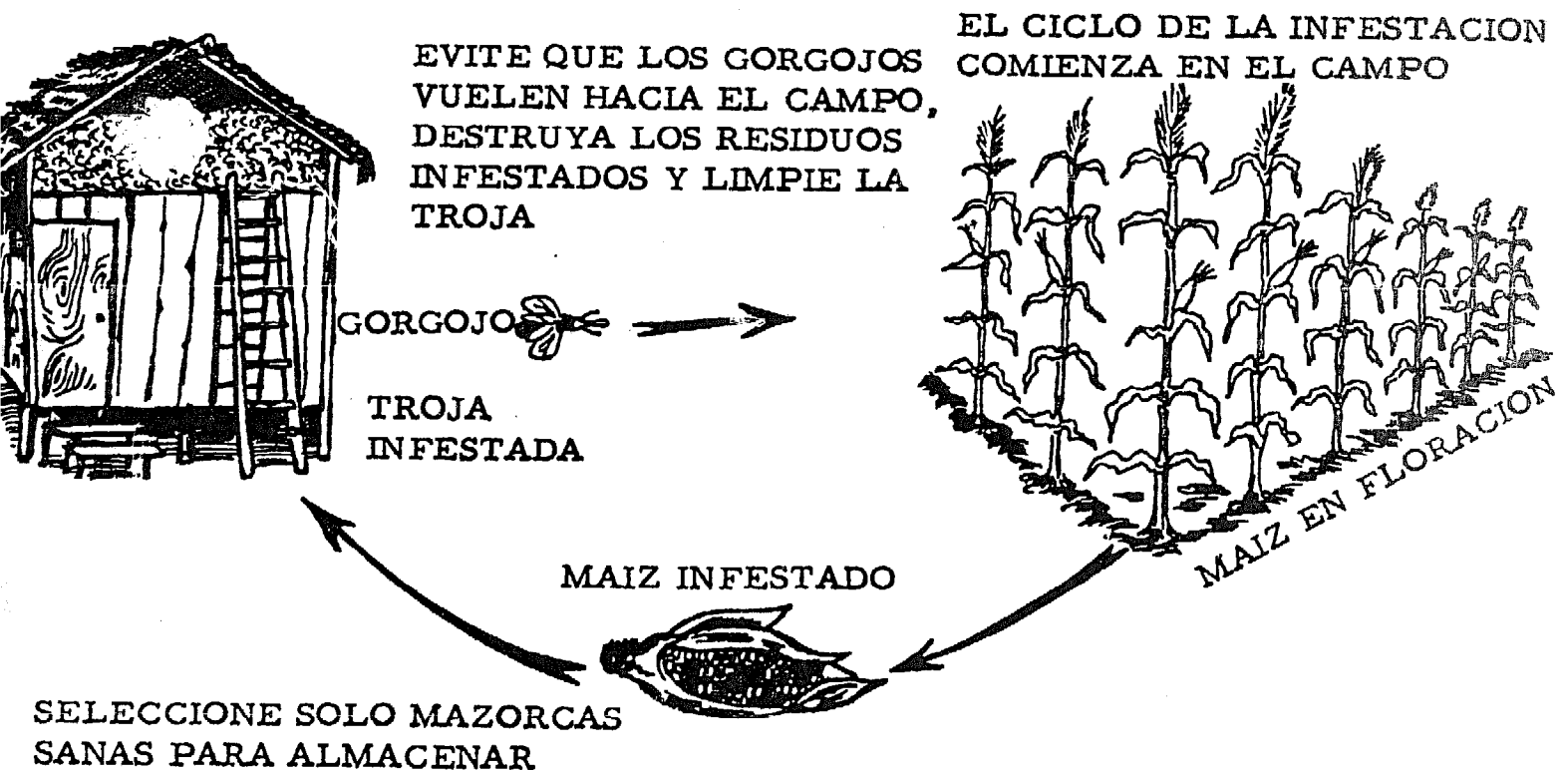

## PLACEMENT OF BAIT FOR MICE/RATS

CANS

BAMBOO

BOXES

IN PLACES TRAVELED BY RATS OUT  
OF THE REACH OF CHILDREN AND FARM ANIMALS

Generally, the greatest losses in stored products are caused by insect damage. Insect control should be exercised from the moment the corn is beginning to mature in the field through the time when the corn is harvested and stored. Insects may be in an infested barn, near the grain field, flying through the field in search of new food, or already beginning to penetrate the ear of corn through openings in the corn husk. The only natural protection of the corn cob is the husk, which can be penetrated by insects.

Some of the newly developed varieties of corn have husks which are more easily penetrated than traditional domestic varieties. Extra precautions against insect invasion need to be taken with these newer varieties.

THE CYCLE OF INFESTA-  
TION BEGINS IN THE  
FIELD

PREVENT INSECTS FROM  
FLYING TO THE FIELD,  
DESTROY INFESTED REMAINS  
AND CLEAN THE BARN

INSECT

MATURE CORN

INFESTED BARN

INFESTED CORN

SELECT ONLY HEALTHY EARS OF CORN  
FOR STORAGE

111 YARDAS CUADRADAS



6 ONZAS (175 c.c.)  
MALATHION LIQUIDO 57%

1 GALON DE AGUA.

Para evitar esta infestación en el campo, se debe limpiar el granero de todos los residuos de la cosecha anterior, que puedan estar infestados, y que marlos o destruirlos. Luego hacer una aplicación de Malathión líquido al 57%, diluyendo primero 17 1/2 cucharadas (6 onzas) de este insecticida, en un galón de agua. Con una bomba de aspersión rociar completamente el techo, las paredes y el piso del granero. Con un galón de esta mezcla, se podrá cubrir una superficie de 111 yardas cuadradas.

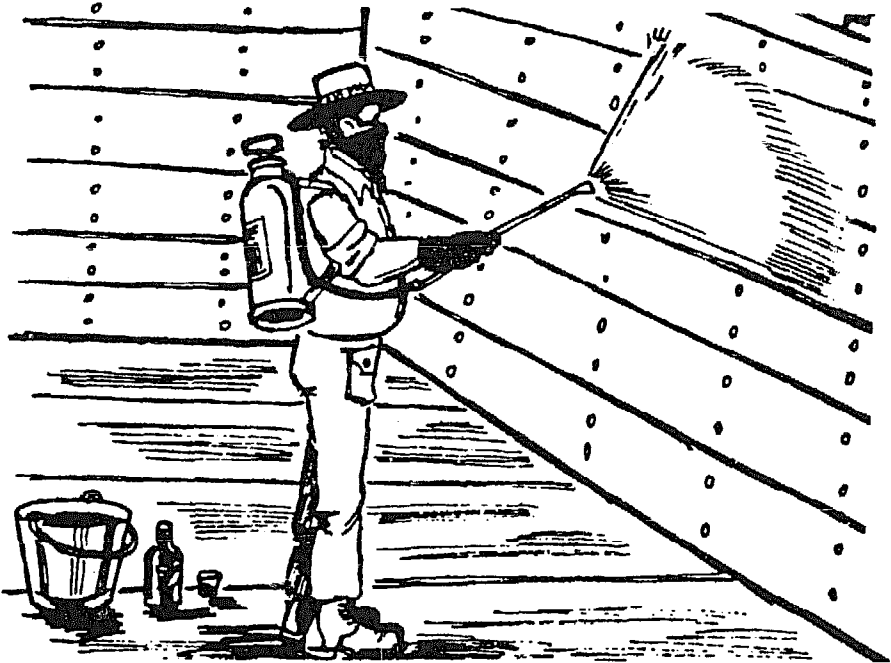

APLICAR MALATHION LIQUIDO, SOBRE LAS PAREDES, TECHO Y PISO DEL GRANERO.

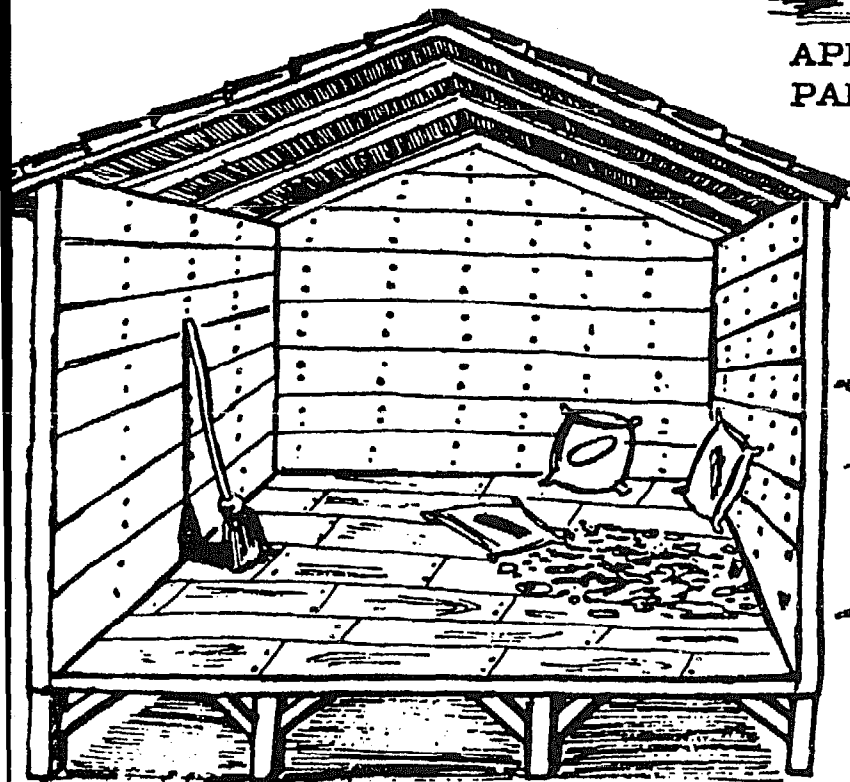

BARRER Y LIMPIAR EL GRANERO  
LIMPIAR LOS ALREDEDORES

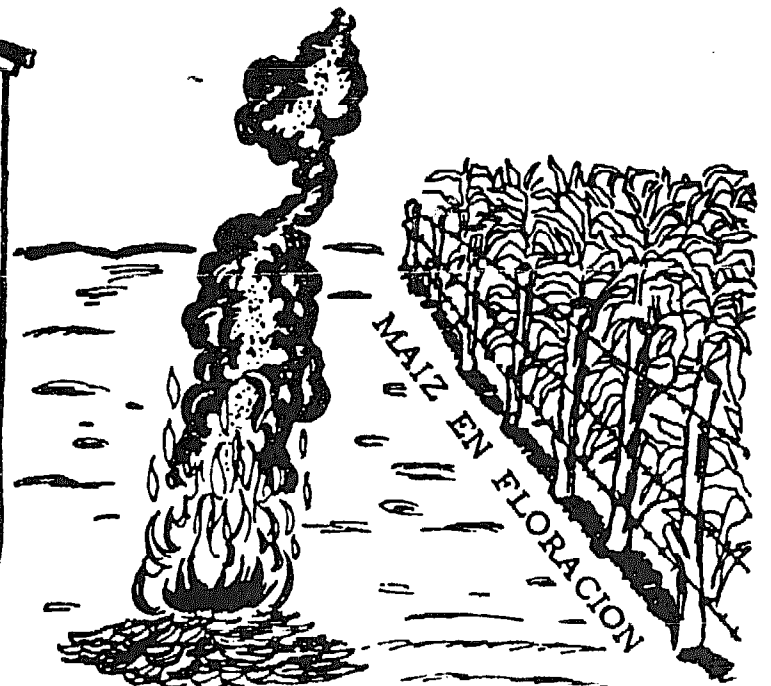

QUEMAR LOS RESIDUOS

A-18-1

111 SQUARE YARDS

6 OUNCES (175 c.c.)  
MALATHION LIQUID 57%

1 GALLON WATER

In order to prevent infestation in the field, the granary should be cleaned of all the remains of the previous harvest, which may be infested, and these remains burned or destroyed. Next make an application of Malathion liquid of 57% by diluting 17 1/2 spoons (6 oz.) of this insecticide in a gallon of water. Using a sprayer, completely cover the ceiling, walls, and floor surfaces of the granary. With a gallon of this mixture, a surface of 111 square yards can be covered.

APPLY MALATHION LIQUID ON THE  
WALLS, CEILING AND FLOOR OF THE  
GRANARY

SWEEP AND CLEAN THE GRANARY  
CLEAN THE SURROUNDING AREA

MATURING CORN

BURN THE REMAINS

Al llevar el maíz cosechado hacia la troja o granero, para almacenarlo, se deben seleccionar las mazorcas sanas, evitando guardar mazorcas picadas que infestarián a las otras mazorcas.



### SELECCIONE SOLO MAZORCAS SANAS PARA ALMACENAR

No se debe dejar el maíz ya maduro doblado o sin doblar en el campo, por mucho tiempo, porque queda expuesto a la infestación de insectos y al ataque de ratas y pájaros, durante un período más prolongado. Se debe proceder a la cosecha, tan pronto como lo permitan las condiciones del ambiente y el contenido de humedad del grano.

Para proteger al maíz que se va almacenar en trojas, se recomienda aplicar el insecticida Malathion en polvo al 2%. Este se debe aplicar por capas, es decir colocando primero, sobre el piso donde estará la troja, una ligera capa de insecticida, después se coloca la primera capa de mazorcas, luego otra capa de insecticida, y así sucesivamente hasta dejar la troja llena a la altura deseada. Las dosis que se recomiendan para el uso de este insecticida están de acuerdo al tamaño de las mazorcas. Así, tenemos que para los híbridos y variedades mejoradas, como el tamaño de la mazorca es un poco grande, hay que aplicar una onza de Malathion 2% en polvo (Triángulo Verde) por cada 100 mazorcas con tuza. Para las variedades criollas, como las mazorcas son más pequeñas, se debe aplicar una onza del insecticida por cada 150 mazorcas con tuza.

### APLICACION DE INSECTICIDA EN TROJAS DE MAIZ

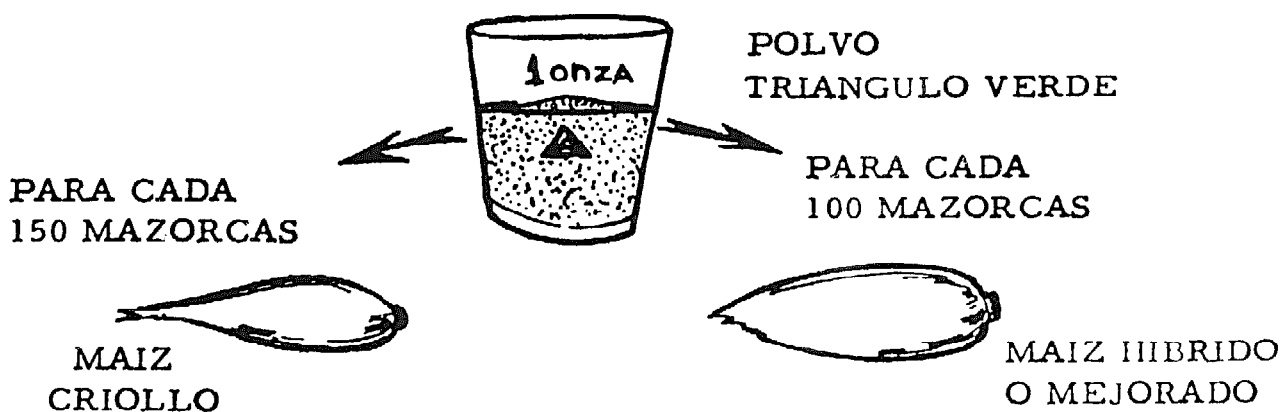

When the harvested corn is brought to the barn or granary for storage, the best ears of corn should be selected, avoiding the storage of ears which are already infested with insects, as these insects can easily infest other ears of corn.

SELECT ONLY HEALTHY EARS OF CORN FOR STORAGE

The ripened corn, whether piled on the ground or still on the stalk, should not be left in the field too long because over a prolonged period of time it is exposed to the attack of rodents and birds. The harvest should be carried out as soon as the climatic conditions and moisture content of the grain permit.

To protect the corn to be stored in barns, it is recommended that 2% Malathion insecticide in powder be applied.

This should be applied in layers. First, dust a thin layer of insecticide on the floor where the grain will be stored. Next, after the first ears of corn are placed, dust another layer of insecticide and so-on until the barn is filled to the desired level. The doses recommended for the use of this insecticide are in accordance with the size of the ears of corn. Thus, we have to apply one ounce of 2% Malathion in powder (green triangle) for every 100 ears of hybrid and newly developed varieties. As the ears of the native varieties are smaller, one ounce of insecticide for every 150 ears should be applied.

Este polvo debe ser espolvoreado sobre la superficie de todas las mazorcas, de modo que las proteja totalmente. Se puede lograr una aplicación uniforme, utilizando una media de tela de Nylon o cualquier bolsa de tela rala, que permita al polvo filtrarse fácilmente hasta las mazorcas.

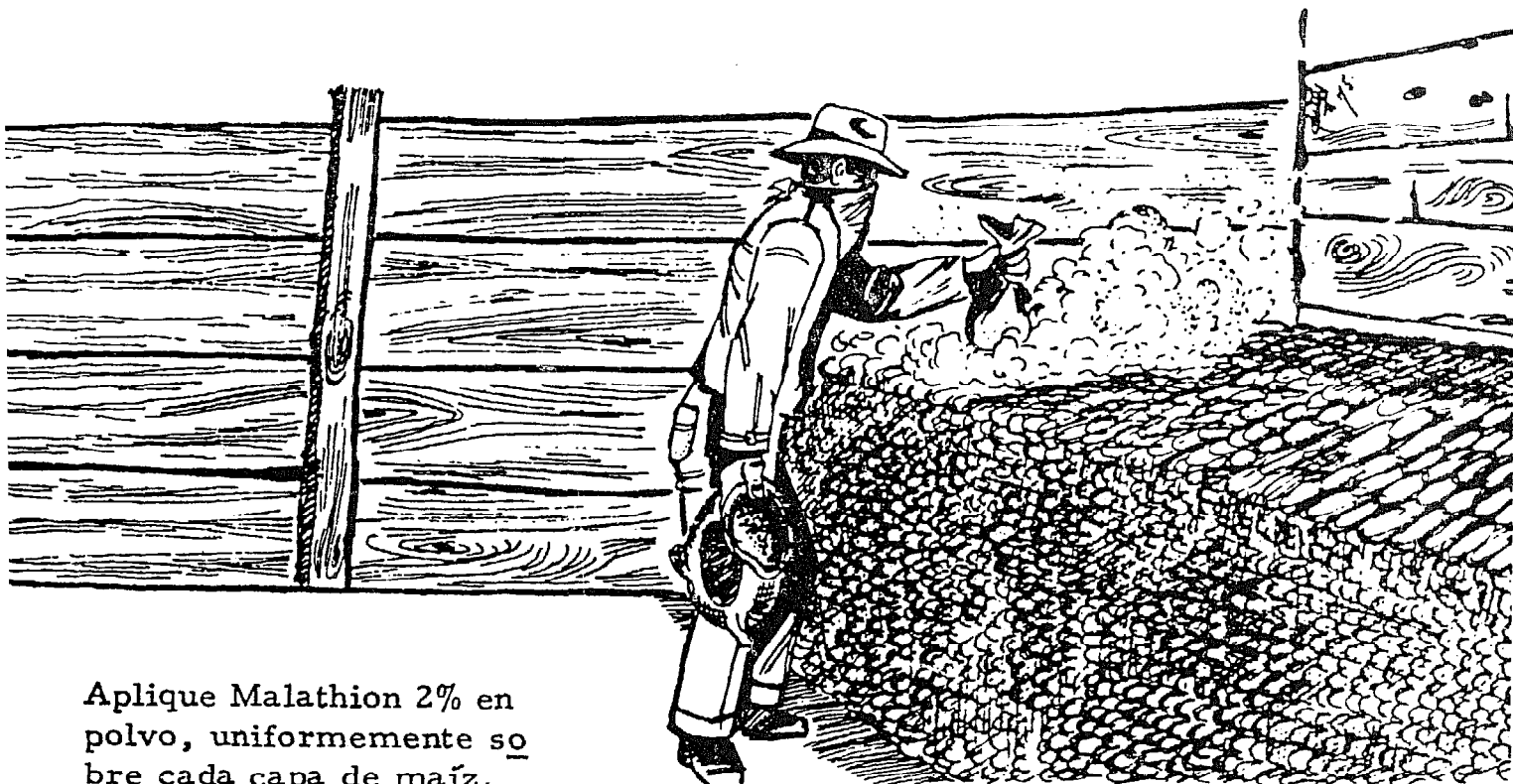

Aplique Malathion 2% en polvo, uniformemente sobre cada capa de maíz.

Se debe aplicar exactamente la cantidad de insecticida que se recomienda y seguir los métodos indicados, para evitar malos efectos del polvo por una defectuosa aplicación.

A decorative flourish consisting of two stylized, symmetrical scroll-like shapes.



A-20-1

APPLICATION OF INSECTICIDE IN CORN BARN

POWDER (GREEN TRIANGLE)

FOR EVERY 100 EARS

FOR EVERY 150 EARS

NATIVE CORN

HYBRID CORN

This powder should be sprinkled on the surface of all of the ears of corn in a way that totally protects them. A uniform application may be obtained by using a nylon sock or any sack or bag with a loose weave which permits the powder to easily be filtered through to the ears of corn.

Apply 2% Malathion in  
powder uniformly over  
each layer

In order to avoid problems caused by the improper application of insecticide, the exact recommended quantity should be used and the indicated methods followed.

## Appendix B

This Appendix contains excerpts from an article which appeared in Tropical Stored Products Information in 1971. It is included here to give you some idea as to the types and number of moisture meters which are available. A Table included at the end of this article also lists the names and addresses of the manufacturers and/or suppliers of the meters so that you can write for further information.

The following material is taken from Tropical Stored Products Information, Tropical Products Institute, 1971, VOL. 21

## GUIDANCE IN THE SELECTION OF MOISTURE METERS FOR DURABLE AGRICULTURAL PRODUCE

by

T N Okwelogu

Tropical Stored Products Centre  
(Tropical Products Institute), Slough

### Sources of Information

The three principal sources of information available to the prospective user are (1) newspapers, magazines and journals, (2) manufacturers' brochures, and (3) organizations in a position to give unbiased information about moisture meters.

Some newspapers, magazines and journals, which occasionally contain information about meters, include the Financial Times, Electronic Age, and Power Farming. Whilst manufacturers are always helpful in supplying plenty of information about their own range of meters, information about a much wider range of meters will be more likely to be obtained from organizations having unbiased interest in these instruments. Examples of such organizations are (1) Tropical Stored Products Centre, (Tropical Products Institute), Slough, England, (2) Grain Storage Department, Pest Infestation Control Laboratory, Ministry of Agriculture, Fisheries and Food, Slough, England, (3) National Institute of Agricultural Engineering, Wrest Park, Silsoe, Beds, England, (4) Grains Division, Agricultural Marketing Service, United States Department of Agriculture, Agricultural Research Centre, Beltsville, Maryland 20705, USA. Articles on moisture meters sometimes appear in the publications of these and other similar organizations.

Tables I and II give details of some available moisture meters, particularly how they can be obtained and the commodities with which they may be used. **These details are based upon information provided by the manufacturers of the meters.**

With every piece of information, it is important to ask the question: is this information sufficient for a decisive opinion to be formed about the meter? Where the answer is 'no', further enquiries should be made.

### Factors to Consider in Making a Choice

It can be seen from Tables I and II that for any specific purpose, several meters can be found, making the problem of choice a real one, indeed. A satisfactory selection is likely to be achieved when adequate thought has been given to the following factors:

1. Meter types and their implications.
2. Characteristics of the commodity.
3. Requirements of the work for which a meter is sought.
4. Business considerations.

## B-4

### Principles and Implications of Meter Types

Most manufacturers indicate the principles upon which the action of their meters is based. An appreciation of the implications of such principles will, no doubt, be of considerable value in deciding which of several meters will be the most suitable. The meters commonly used with durable agricultural products fall into five groups, according to the principles of their action:

1. Those involving chemical interaction between calcium carbide and the product water, with the evolution of acetylene gas, the pressure of which is subsequently measured.
2. Those involving heat-drying of the product, the attendant loss being ascribed to evaporated produce water.
3. Those involving the measurement of electrical conductivity (or resistance) of the product, since the value of this property is relatable to the moisture content, within a suitable range of moisture contents.
4. Those involving the measurement of the dielectric constant of the product (or capacitance of the electrical system of which the product is a component), since the value of this property changes with the moisture content, within a suitable range of moisture contents.
5. Those involving the measurement of that atmospheric relative humidity which is in equilibrium with the product moisture, since, under equilibrium conditions, there is a definite relationship between the moisture content of a product and the ambient relative humidity.

Heat-drying methods require a suitable source of power-supply or fuel, which may not be available. Methods based on the evolution of acetylene gas require regular supplies of fresh calcium carbide, which is not a safe commodity to handle by post, because of the risk of explosion. Meters measuring the inter-granular relative humidity require, firstly, a knowledge of the relationship between the produce moisture content and the relative humidity of the inter-granular air; secondly, a periodic check on their calibrations; and thirdly, in some cases, large quantities of produce which must have remained undisturbed for sometime prior to testing.

The electrical meters are faster, and in the main, less demanding on calibration checks, but require skilled servicing. Also, they give less reliable readings outside the middle region of the range of moisture contents for which they are calibrated. The accuracy of the probe-type electrical meters is affected by variations in the pressure exerted by the produce on the electrodes, while the consistency of the readings of those meters which measure the dielectric constant is affected by inconsistent packing of the sample in the test chamber.

Attention has been focused above on the less favourable features of the meter groups mainly because they are more likely to be overlooked. Information on the merits of any meter will not normally be difficult to obtain, and Tables I and II show the relative merits of the meters discussed in the present article.

### Characteristics of the Commodity

The commodity to be tested imposes a number of limitations, and these must be taken into account when considering the use of any meter. Perhaps the best way to do this is to answer questions such as the following.

First, is the chemical nature or any normal pre-treatment of the produce likely to interfere with the use of the meter? For instance, meters measuring electrical conductivity may not be suitable for produce, like salt-fish, which will become highly conductive when damp. Again, for commodities like dried egg or milk, a heat-drying meter may not be suitable.

Second, is the moisture content to be measured outside the range for which the meter is calibrated? For example, very few electrical meters are known to be suitable for a product like made-tea whose moisture content is normally required to be below 5 per cent, that is outside the range of moisture contents for which most electrical meters are calibrated.

Third, is the milling property of the produce incompatible with the effective use of the meter? For example, commodities like macadamia nuts, palm kernels and copra are not easily ground, while others like cashew nuts (not the kernels) are simply not amenable to grinding.

Fourth, are the unit size and shape of the produce likely to affect the efficient use of the meter? The construction of the meter may be such that it cannot be pushed into floury or powdery produce without hampering the measurement of moisture. Again, larger products like cocoa beans, unshelled groundnuts, cashew nuts and pieces of illipe nuts (*Shorea* spp.) will present packing problems with some meters.

If the answer to each of the above questions is an unqualified 'No', then the meter may be considered suitable for the product. But a 'Yes' answer can make all the difference between a meter being chosen or rejected. In such a case, steps should be taken to see what, if anything, has been done to solve the problem, either by the manufacturer or by someone else.

#### **Nature of the Situation Needing a Moisture Meter**

In an article of this kind, it is not easy, even if it is possible, to cover all the situations where the use of a moisture meter may be desired. However, such situations are likely to fall into one or the other of the following categories:

1. Knowing whether grain is at the right stage for harvesting.
2. The processing, (eg drying or milling), of foodstuffs.
3. Bulking or packaging produce for storage.
4. Commercial transaction, where moisture content is part of the basis for payments.
5. Produce Inspection Service.

All the above situations require moisture meters which are not fragile, which are consistently accurate within limits acceptable for the particular purpose, and whose performance is little affected by the operating conditions of space, temperature, pressure, light, dust or wind. They also require, to a greater or lesser extent, meters that are simple to operate, portable and capable of taking remote measurements, as with probe-electrodes, or stem hygrometers.

#### **Business Considerations**

The purpose for which the use of a meter is usually contemplated is two-fold: to increase or improve productivity, (that is, the flow of goods and services), and to ensure economical operations.

Productivity can be improved by employing a meter which can give results rapidly; a meter for which spares and facilities for servicing and/or calibration are easily available; a meter which does not depend upon sources of operating power that run out, break down, or become short in supply (eg battery, mains supplies, gas, paraffin and other fuel).

Economy of operation implies keeping down to the minimum both capital and operating costs, and/or increasing the return to unit cost. Additionally, the wider the range of commodities that a meter can test, the more economical will be its use. Likewise, the less destructive a test is, the less will be the incidental loss to production, caused by the use of a meter. Although this kind of loss may appear small, it must be realised that its magnitude will depend on how much produce is damaged at each test, and how many times such tests are carried out on a given product.

#### **Conclusions**

It should be clear from these discussions that very few meters, if any, can win the top position in every conceivable area of consideration, and that there is no magic formula for choosing a meter. But where a choice has to be made, the final responsibility for it must be that of the buyer.

He must have a knowledge of the commodity to be tested and the accuracy required of a determination of its moisture content; the availability of the meter, and the cost of operating it; the conditions under which the meter will be operated; the ease of obtaining spares and facilities for servicing or calibrating the meter; the type of power supply required and available. And when a provisional choice has been made, it is often advisable to obtain the meter on loan for trial before buying.

**Bibliography**

- ANON. 1953. The Quicktest grain moisture tester. *Report nat. Inst. agric. Engng*, No. 83 (Nov.), 5 pp.
- ANON. 1966. Farm grain drying and storage. *Min. Agric. Fisheries and Food, Bull.*, No. 149, 123-129.
- BANNER, E H W. 1958. *Electronic measuring instruments*. London: Chapman and Hall, 2nd edn, revised xi + 496 pp.
- LEFKOVITCH, L P and PIXTON, S W. 1967. Calibrating moisture meters. *J. stored. Prod. Res.*, 3 (2), 81-89.
- MACKAY, P J. 1967. The measurement of moisture content. *Trop. stored Prod. Int.*, (14), 21-29.
- PANDE, A and PANDE, C S. 1962. Physical methods of moisture measurement. Part I: Conductivity. *Instrum. Pract.*, 16(7), 896-903.
- PANDE, A and PANDE, C S. 1962. Physical methods of moisture measurement. Part 2: Dielectric, sonic, ultrasonic, microwave and electrolytic methods. *Instrum. Pract.*, 16(8), 988-995.
- PIXTON, S W. 1967. Moisture content - its significance and measurement in stored products. *J. stored Prod. Res.*, 3(1), 35-47.
- STEVENS, G N. 1968. The measurement of grain moisture content by rapid methods. *Tech. Note Home-Grown Cereals Auth.* No. 5, 3 pp.
- WARNER, M G R and HARRIES, G O. 1956. An investigation into the performance of five typical rapid methods of measuring the moisture content of grain. *Report nat. Inst. agric. Engng*, No. 46, (Mar.), 43 pp.
- ZELNY, L and HUNT, W H. 1962. Moisture measurement in grain. For presentation at the 1962 Winter Meeting of the *Amer. Soc. Agric. Engineers*, Chicago, Illinois, Dec. 11-14. Paper No. 62-926, 32 pp. (Details from the authors: Standardisation and Testing Branch, Grain Division, Agric. Marketing Service, USDA, Agric. Research Centre, Beltsville, Maryland).

Table 1 Details of some available proprietary moisture meters<sup>1</sup>

Meters under principles of action	Power supply: B Battery G Self-generating M Mains N None required	Test speed: + Under 1 min .. 1-5 min +++ over 5 min	Accuracy (Within % MC)	Price rating: * Under £50 ** £50 - £100 *** Over £100	Manufacturer/Supplier
<b>CHEMICAL (C)</b>					
C.1 Speedy	N	+++	0.5	*	Thomas Ashworth & Co Ltd Sycamore Avenue, Burnley, Lancs, England
<b>DRYING (D)</b>					
D.1 X17 Agat	M	+++	0.3	*	A.B.G.L. Jacoby Box 23014Y, Stockholm 23 Sweden
D.2 Cenco Moisture Balance	M	++	0.2	*	Cenco Instrumenten Mirj. n.v. Konijnenberg 40, Post Box 336 Breda, Holland
D.3 Dynatronic IR Moisture Analyzer Mark II	M	++	0.2	***	Lab-Line Instruments International Lab-Line Plaza 15th & Bloomingdale Aves, Melrose Park, Illinois, USA
D.4 Is Crop Tester	M	+++	1.0	*	Tower Silos Ltd 2 Brock Street, Bath Somerset, England
D.5 Vacuum Moisture Tester	M	++	0.1	***	Townson & Mercer Ltd Croydon CR9, 4EG, England
<b>ELECTRICAL CONDUCTIVITY (Ec)</b>					
Ec.1 KPM Aqua Boy	B	+	0.2	**	K.P. Mundinger GmbH D-7253 Renningen, W. Germany
Ec.2 Universal Moisture Tester	G	++	0.2	***	} Burrows Equipment Co 1316 Sherman Avenue Evanston, Illinois, 60204 USA
Ec.3 Safe Crop Moisture Tester	B,M	++	0.5	**	

Footnotes are explained on p. 28.

(Contd)

Table 1 (contd)

Meters under principles of action		Power supply:	Test speed:	Accuracy (Within % MC)	Price rating:	Manufacturer/Supplier
		B Battery G Self-generating M Mains N None required	+ Under 1 min ++ 1-5 min +++ over 5 min		. Under £50 . . £50-£100 . . . Over £100	
<b>ELECTRICAL CONDUCTIVITY (Ec) (contd)</b>						
Ec.4	Agil Moisture Meter	B	+	1.0 - 2.0	.	Agil Ltd, Nicholson House Nicholson's Walk Maidenhead, Berks. England
Ec.5	Hart Moisture Meter K101, K103	B,M	+	0.2	. . .	Hart Moisture Meters, Inc 400 Bayview Ave, Amityville N.Y. 11701, USA
Ec.6	'Hydraprobe' Copro Moisture Meter	B	+	2.0	.	Coe's (Derby) Ltd Thirsk Place, Ascot Drive Derby, DE2 8JL, England
Ec.7	Marconi Moisture Meter TF933B	B,M	++	0.5	. .	Marconi Instruments Ltd Longacre, St Albans Herts, England
Ec.8	Protimeter Grainmaster	B	++	0.5	. .	Protimeter Ltd Field House Lane Marlow, Bucks. England
Ec.9	ScottMec-Oxley	G	+	1.0	. .	Scottish Mechanical Light Industries Ltd 42-44 Waggon Road, Ayr Scotland
Ec.10	Siemens Moisture Meter	B,M	++	0.5	. . .	Siemens (UK) Ltd Grt West House, Grt West Rd Brentford, Middx, England
<b>DIELECTRIC CONSTANT (Ed)</b>						
Ed.1	Cera Tester	B	+	0.3	. .	A/S N. Foss Electric 39 Roskildevej, 3400 Hillerød, Denmark



Table I (contd)

Meters under principles of action	Power supply: B Battery G Self-generating M Mains N None required	Test speed: + Under 1 min ++ 1 - 5 min +++ over 5 min	Accuracy (Within % MC)	Price rating: * Under £50 ** £50 - £100 *** Over £100	Manufacturer/Supplier
<b>DIELECTRIC CONSTANT (Ed) (contd)</b>					
Ed.2 Kappa-Janes Moisture Meter	B,M	++	0.5	***	Kappa Janes Electronics 27 Stewart Avenue Shepperton, Middx, England
Ed.3 Burrows Moisture Recorder	M	+++	0.3	***	Burrows Equipment Co 1316 Sherman Ave, Evanston Illinois 60204, USA
Ed.4 Lippke Moisture Meter FK-R-6	M	+	0.5	***	Paul Lippke K.G. 545 Neuwied PO Box 1760, Germany
Ed.5 Wile	B	++	1.0	*	OY Fima Ltd, Helsinki 70 Finland
Ed.6 Super-Matic Foss	M	++	0.3	***	A/S N. Foss Electric 39 Roskildevej, 3400 Hillerød, Denmark
Ed.7 Transhyrolair	B	-	1.0	*	Les Applications Industrielles de la Radio 236 Chemin des Vitarelles Tournepuille(31) France
Ed.8 Steinlite Meters	B,M	++	0.3	***	Seedburo Equipment Co 618 West Jackson Boulevard Chicago, Illinois 60606 USA
Ed.9 Dole 300 Moisture Tester	B,M	+	-	**	Eaton Yale & Towne Inc Dole Division, 191 E North Avenue, Carol Stream Illinois 60187, USA
Ed.10 Cae Moisture Meter Model 919	B	+	0.3	**	Canadian Aviation Electronics Ltd, Winnipeg 4, Canada

(Contd)

Table 1 (contd)

Meters under principles of action	Power supply: B Battery G Self-generating M Mains N None required	Test speed: + Under 1 min ++ 1-5 min +++ over 5 min	Accuracy (Within % MC)	Price rating: * Under £50 ** £50-£100 *** Over £100	Manufacturer/Supplier
Ed.11 G-C-Wyndham Moisture Meter	B	+	0.5 - 1.0	*	E J Chapman & Co Ltd Martley, Worcester, England
Ed.12 C.D.C. Automatic Moisture Meters Hyb 24, Hyb 25 Hyb 42, Hyb 43	M B	+ +	0.3 0.5	*** ***	Compagne des Compteurs (GB) Ltd, Terminal House Grosvenor Gdns, London SW1 England
<b>INTER-GRANULAR RH (H)</b>					
H.1 Dip-Shaft Humidity Indicator	N	+++	1.0	*	Abrax Inc, 179'15H Jamaica Ave, Jamaica, New York 11432, USA
H.2 Quicktest Models 1 and 2	N	+++	1.0	*	Opanco! Ltd 10/11 Gamage Building Holborn Circus, London EC1 England

\* All the information given in this table has come from the manufacturers

- Data not available

NB The exclusion of an instrument from this table does not necessarily imply the author's disapproval of its use with agricultural produce.

Table II Commodities and some candidate moisture meters\*

Meter Ref. No.	Moisture Meter	Range of produce Moisture Content (%) M - Max. range encountered in practice	SAMPLE SIZE (g): S small under 10 M moderate 10 - 100 L large above 100	COMMODITIES (+)																				
				Beans	Cashewnut	Cereals and products	Cocoa beans and products	Coconut (copra)	Coconut desiccated	Coffee beans	Cottonseed	Cowpeas/peas/grans	Dried fruit and nuts	Fishmeal/shreds	Groundnut	Horticultural seed	Milk powder	Palm kernel	Sesame or Benneised	Soya bean	Sunflower seed	Tea	Tobacco	
C1	Speedy	0-50	S-M																					
D1	X 17 Agat Moisture Meter	M	M																					
D2	Cenco Moisture Balance	M	M																					
D3	Dynatron IR M. Analyzer	M	S-M																					
D4	Is Crop Tester	M	L																					
D5	Vacuum M. Tester	M	S																					
Ed1	KP-1 Aqua B. J.	2-30	L																					
Ed2	Umic M. Tester	9-40	L																					
Ed3	Safe Crop M. Tester	11-30	L																					
Ed4	Agri M. Tester	14-30	L																					
Ed5	Hart M. Meter K 101, K 103	Variable	M-L																					
Ed6	"Hydraprobe" Copra M.M.	4-14	M																					
Ed7	Marcom M.M. TF 933B	4-25	S																					
Ed8	Protonmeter Grandmaster	10-35	M-L																					
Ed9	Smartec-Oxley	10-25	L																					
Ed10	Snyder's M. Tester	3-45	L																					
Ed11	Cera Tester	8-30	M																					
Ed12	Kaplan-James M.M.	0.5-60	M																					
H1	Burrows M. Recorder	6-35	L																					
H2	Lipke M.M. FK-R-6	0-20	L																					
	Wile	10-34	M																					
	Super Matic Foss	6-40	L																					
	Transhygronair	9-40	L																					
	Stearns Meters	4-36	L																					
	Dole 300 M. Tester	6-30	M																					
	Cae Moisture M. Model 919	9-25	L																					
	G-C-Wyndham M.M.	10-30	L																					
	C.D.C. Moisture Meters	5-35	L																					
	Dip-Staff Humidity Indicator	M	L																					
	Quicktest Models 1 and 2	M	L																					
	AVAILABLE NUMBER OF METERS at the least:			8	1	29	7	2	1	12	4	5	4	2	10	7	3	2	2	9	6	2	7	

\*All the information in this table has come from the manufacturers.

\*\*As used in Table I of this article.

--Data not available.

NB The exclusion of an instrument from this table does not necessarily imply the author's disapproval of its use with agricultural produce.

## Appendix C

The following material is taken from Guidelines for the Use of Insecticides, published by the

Agricultural Research Services  
and Forest Service of the  
United States Department of Agriculture

The section of the Guidelines included here contains information on applying insecticides with sprayers and power dusters, safety precautions, and protection of wildlife from insecticides. The section of this book pertaining to insecticide dosages, formulations, and applications for use with stored grain is included in entirety. This information is included because it is often hard for development workers to get such complete information.

The entire publication includes insect control for crops, livestock, households, forests, and forest products.

## OTHER MEANS OF INSECT CONTROL

In addition to the use of insecticides, there are a number of other ways to control or to help control injurious insects. Natural controls, such as parasites, predators, diseases, and adverse weather conditions, are continually at work. Often they reduce populations of injurious insects and keep them at levels that are not economically damaging. Also, good sanitation and housekeeping are essential for the effective control of house flies, stable flies, cockroaches, fleas and stored-product insects, even when these practices are supplemented by chemical controls. Cultural practices and mechanical devices aid materially in the control of the pink bollworm, boll weevil, tobacco hornworm, white pine weevil, and certain bark beetles. Crop varieties resistant to insects have been developed and are available to avoid or reduce damage by such insects as the hessian fly, wheat stem sawfly, spotted alfalfa aphid, and the European corn borer.

When harvested products are subjected to heat or extreme cold in storage, insect infestations are often destroyed or inhibited. Insect-free commodities can be protected by insect-resistant packaging and sanitation in storage and in marketing channels.

More satisfactory control of insect pests may frequently be obtained by carefully integrating the use of insecticides or fumigants with biological control agents and other nonchemical measures. This approach to insect control is most effective when the total population of the insect is attacked on a continuous basis (compared with treatment of seasonal infestations in individual fields). Often when such integrated control is practiced, insecticides are needed only to supplement the other control measures. However, for this method, all means of control of a pest insect must be considered to coordinate them to the greatest advantage and with the least harmful effect on other living organisms in the environment. Consult your State agricultural experiment station for the latest information. Do not use insecticides or fumigants unless they are needed.

## APPLICATION OF INSECTICIDES

The key to effective use of an insecticide without injury to the treated plant, animal, or agricultural product is to follow directions on the label. Do not use any insecticide preparation for any purpose for which it is not specified. Most oil sprays prepared for application to walls of buildings will

injure living plants or animals. Insecticide concentrates prepared for application to plants may injure or kill treated animals or result in illegal residues in animal tissues or byproducts.

Only general information can be given here on the effective application of insecticides since much depends on the habits of the insect pest, the kind of damage that it causes, the nature and condition of the infested plants, animals, or commodities to be treated, weather conditions, and application equipment, as well as the type and formulation of the insecticide to be applied. For information to meet special needs, consult your State agricultural experiment station.

### **Weather Conditions**

Wind, rain, and sun play an important part in the control you get from outdoor use of insecticides. Keep an eye on the weather. Local weather reports may be helpful in planning insecticide applications. Before you start to treat, watch the tops of trees or use other means to determine the direction and the amount of wind. Some air movement is helpful. Winds, however, can cause an insecticide dust or spray to be unevenly distributed on the plants and to drift away from target areas.

If rain is predicted, postpone treatment, if possible. Rain falling soon after you treat may reduce the effectiveness of an insecticide deposit. Cold weather may have the same effect. Some insecticides must be applied at temperatures above 50° F. to be effective.

Extremes in weather during or following the spraying of fruit trees may lead to fruit or foliage injury. Russeting of fruit may be increased by pesticide sprays if they are applied at night or during cool, rainy, or humid weather. Emulsifiable materials are more likely to cause injury than are wettable powders.

High wind and low temperature make control of insects by fumigation difficult. High winds may reduce gas concentration even in well-sealed warehouses. Insects are difficult to kill by fumigation at temperatures below 60° F.

### **Condition of Host Plant or Animal**

The type and density of plant foliage, as well as the extent of coverage needed, may influence the choice of formulation that is applied. In some

C 14  
instances, a coarse spray will control insects more effectively; in others, a fine spray, mist, or fog will be more effective. Plants with smooth leaves are likely to have a quicker runoff of spray material than those with rough leaves. However, stickers that are included in the formulation, or that may be added, help the material adhere to the plants.

Sick, emaciated, or stressed animals may react unfavorably to some treatments that normally are harmless. Thick hair on livestock may keep the insecticide from penetrating. Consider all such circumstances in selecting an insecticide, type of formulation, or type of equipment that will provide the best and safest control of the target pest.

### **Diluting and Mixing Sprays**

Most spray material are formulated with enough wetting and sticking agents to correct for water hardness and to improve other physical properties of the spray.

Before mixing two or more pesticides or adding wetting or sticking agents, read the labels and consult the manufacturer, a spray compatibility chart, or a spray bulletin regarding possible injury to plants.

### **Calibration of Equipment for Applying Insecticides<sup>1</sup>**

At the start of each growing season, thoroughly inspect and calibrate all equipment you will use to apply insecticides. Repeat whenever you use a different rate of application. Apply the correct dosage, not only to control the insect pest effectively but also to avoid plant injury and to be certain that any residue remaining at the time of harvest or feeding does not exceed the tolerance established for that particular chemical on the crop you treat.

*Power Sprayers.*—Before calibration, the spray nozzles should be checked for obvious wear, foreign material, and choice of proper type and size. Where the sprayer has many nozzles, the flow rate of each nozzle should be checked using water at the planned operating pressure by catching all of the spray for a measured time. Nozzles that differ by more than 5 percent from the average of the rest should be replaced before calibrating the sprayer. If possible, the

---

<sup>1</sup> Information furnished by the Agricultural Research Service, USDA.

sprayer should be calibrated with a liquid containing no pesticide but similar in weight and viscosity. Then, the calibration should be confirmed by measuring the application of a small measured amount of actual pesticide mixture when beginning on the area to be treated and the equipment or the mixture ratio adjusted to correct for the change, if any, in the rate with actual pesticide material. Usually, water is most logical material to use for calibration, but occasionally some pesticide mixtures flow more like fuel oil or vegetable oil, in which case these mixtures should be used for calibration. When a liquid containing no pesticide can be used for calibration, the user can use the *Simplified Method* described below. If the pesticide or the sprayer construction somehow requires use of the actual pesticide for realistic operation, then the *Full Calculation Method* must be used.

*Simplified method:* (1) Place two markers (stakes, cans, and so forth) on the ground 40 rods (660 feet) apart. (2) Partially fill the sprayer with water (or the other liquid being used) and operate until all nozzles are discharging evenly. Fix a vessel of appropriate size (a 2½-gallon can, for example) under one nozzle so that it will collect all the spray coming from it. (3) Operate the sprayer one round trip between the markers at the speed, pressure, and other settings as you intend to use them, with the sprayer in full operation. Spray only between the markers. (4) Measure the amount collected from the nozzle and multiply it by the total number of nozzles to get the total amount sprayed. (5) Multiply the number of gallons sprayed by 33 and divide by the number of feet of width sprayed. The result of this calculation will be the number of gallons applied per acre.

*Example:* Suppose the boom on the sprayer contained 12 nozzles and covered a swath of 20 feet, and that you collected 3¾ pints of spray from one nozzle during the round trip. Twelve times 3¾ pints equals 39 pints, or 4.875 gallons. This times 33, divided by 20, equals 8.0 gallons per acre.

It may not be practical to collect the spray used during a run in the field with certain types of equipment. Aircraft sprayers, mist blowers, and foggers are examples of such equipment. For this equipment, the amount used during the calibration run must be found from the net amount taken from the tank. To do this, the tank must be filled to an accurate liquid level mark (preferably filled to just to the point of overflow). The sprayer is then operated over the calibration distance and the amount required to refill the sprayer to the same level is measured. To be accurate, the sprayer must be in exactly the same position (preferably level) both times when the level is

measured. In certain types of sprayers, such as aircraft, it may not be possible to make an accurate level mark or to fill the tank to overflow. With this equipment, the sprayer must be first partially filled, then operated until all lines and booms are filled, and then the tank drained. A measured amount of liquid is then put into the tank and the sprayer is operated over the calibration distance, and the tank then drained as before, measuring the amount that drains out. The amount used is the difference between the amount that was put into the tank and the amount that was drained out.

*Full calculation method:* To calculate the application rate of the sprayer, you must know the speed of the sprayer, the width of swath sprayed, and total flow rate from the sprayer nozzles.

1. The speed may often be taken from a speedometer. If there is no speedometer available, measure the time it takes to drive the equipment at the intended speed over a measured course at the intended speed with the tank half full. The speed can be calculated from these measurements.

*Example:* Suppose it requires 3 minutes and 20 seconds (200 seconds) to go 80 rods (¼ mile). The speed equals ¼ divided by 200, multiplied by 3,600 (the number of seconds in an hour), which would be 4.5 mph.

2. The flow rate can be calculated by multiplying the number of nozzles times the rating given by the manufacturer for operation at the pressure being used, if the nozzles are new and have not worn very much.

*Example:* Suppose the sprayer has 12 nozzles rated at 0.4 gallon/minute at the pressure you intend to use. The total flow equals 12 times 0.4, which is 4.8 gallons/minute.

You may not be able to use the manufacturer's rating if the nozzles have worn somewhat, or if the manufacturer has not supplied a rating at the pressure you intend to use, or the manufacturer's rating is not conveniently available. Then, the flow rate will have to be obtained by measuring the spray caught from a nozzle for a measured time.

*Example:* Suppose there are 12 nozzles on a sprayer and you catch 1 quart and 6 fluid ounces (38 fluid ounces) from one nozzle in 1 minute. Since there are 128 fluid ounces in a gallon, the flow rate of the entire sprayer equals 38 times 12, divided by 128, which is 3.56 gallons per minute.

3. The swath width must be determined by a method appropriate to the sprayer being used. The swath width of an airplane sprayer, air-blast sprayer, or fogger will have to be determined from the manufacturer's literature or perhaps from a research report on the particular equipment in use. A boom sprayer will have a swath equal to the boom width plus the width covered by end nozzle, if there are nozzles on the very ends of the boom.

Example: Suppose a sprayer has a boom 18 feet 4 inches long, having a nozzle at each end that also covers 20 inches apiece. Recognizing that only half the spray from each end nozzle will go outside the boom, the swath will be 18 feet 4 inches plus 20 inches, which equals 20 feet.

In contrast, if you are only spraying a narrow band over each row of a crop grown in rows, the total swath will be equal to the width of the band times the number of rows.

Example: Suppose you have spray equipment attached to a 8-row planter, which sprays only a 12-inch (1 foot) band over each row. The actual swath being treated is equal to 8 times one, which is 8 feet width of swath.

4. The application rate of the sprayer can be calculated when the speed, swath width, and flow rate are known. The following formula can be used to take into account the number of fleet in a mile, the number of square feet in an acre, and the number of minutes in an hour.

$$\frac{495 \times (\text{total flow rate in gallons/min.})}{(\text{swath width in feet}) \times (\text{speed in mph})} = \text{gallons per acre}$$

Example: Suppose the flow rate is 4.8 gallons per minute, the swath width is 20 feet, and speed is 4.5 mph. Then the volume of spray applied is 495 times 4.8, divided by 4.5, divided again by 20, which is 26.4 gallons per acre.

*Changing or adjusting the application rate:* If the application rate found from the calibration is not what is desired, it may be changed by changing the size and number of nozzles, the speed, or the pressure. If large changes are necessary, the size and number of nozzles must be changed. Decreasing the speed will increase the application rate proportionately, while increasing

speed will decrease it. However, the acreage that can be covered per day will be reduced if speed is reduced, so users may not wish to make very large changes in speed. You should not try to change application rate very much by changing pressure, because this will also change the pattern and the droplet size of the spray. It is useful to know, also, that increasing pressure 10 percent increases the nozzle flow only 5 percent, 21 percent increases nozzle flow 10 percent, and 44 percent increases nozzle flow 20 percent, so that changing nozzle flow requires proportionately much larger changes in pressure.

*Power Dusters:* -Before starting a dusting operation, check the application rate of the duster unit. Dust mixtures vary in density, and the application rate can vary at a given setting of the feed regulator.

1. Measure off a convenient area between one-fourth acre and 1 acre.

Example: Eight 40-inch rows ¼ mile long, which equals 0.808 acre.

2. Fill the dust hopper to an accurate level mark and set the dust feed regulator according to the manufacturer's recommendation for the desired application rate.

3. Dust the measured area. Drive at a constant speed because the speed affects the application rate. Use a speedometer if possible.

4. Refill the hopper to the previous level from a weighed amount of dust. Subtract from this weight the amount left over after refilling the hopper, which gives the amount applied to the measured area. This amount divided by the area gives the application rate. Example: Suppose a bag containing 50 pounds was used to refill the hopper, after which it contained 34 pounds. The amount used was then 16 pounds. Dividing this by 0.808 acre gives 19.8 pounds per acre.

*Applicators For Granules:* -Many equipment manufacturers and some producers of granular insecticides provide tables showing the proper settings of the feed mechanism for selected flow rates of specific materials. This will provide an approximate guide for the user in adjusting the equipment. Because of manufacturing differences in both the granular material and the application equipment, the user should check this with a measured calibration.



Disconnect the tubes from the spreaders, and affix paper bags in place of the spreader, to collect all of the granules fed out. Run the spreader over a measured course of 1,320 feet and weigh the material collected. Multiply this weight by 33 and divide by the number of feet of width the applicator covers from the dispenser measured. This will give the pounds applied per acre.

**Example:** Suppose the discharge from two tubes are to be spread over one 40-inch (3.3 feet) row width, and you collected 4 pounds of material when operating over a total of 1,320 feet (40 rods each way, round trip). Four times 33, divided by 3.3, equals 40 pounds per acre.

If this calculation shows the application rate is not what is intended, adjust the settings appropriately, and repeat the calibration procedure. Remember that the feed mechanism of most granular applicators does not feed the material at a rate proportional to the speed of the equipment, even though it is often driven by a wheel on the ground. Because of this, the speed of the equipment must be constant, and the application rate can be increased or decreased by decreasing or increasing, respectively, the ground speed of the equipment.

**Confirming calibration with first application:** After calibration, you should try a partial load of actual pesticide mix to confirm that the calibration measurements and calculations were accurate. This will give you a chance to make a last minute adjustment in the operation of your equipment before treating an entire field.

**Example:** Suppose a field ¼ mile long is being treated with a sprayer having a swath of 20 feet, and the calibration indicated that it was applying 8 gallons per acre. Since 10 swaths the length of the field equals 6.06 acres, which should require 48.5 gallons, the operator might put about 53 gallons in the tank for the first load. After 10 swaths have been completed, the tank can then be checked to see about how much more or less than the expected 4.5 gallons of spray mixture remain.

### PRECAUTIONS

The following safeguards are to protect handlers of insecticides and treated objects, consumers of treated crops and animals, honey bees, fish, wildlife, domestic animals, fish pools, bird baths, creeks, feeding dishes of animals, and our basic natural resources—water, soil, and air.

Pesticides used improperly can be injurious to man, animals, and plants. Follow the directions and heed all precautions on the labels.

Store pesticides in original containers under lock and key—out of the reach of children and animals—and away from food and feed.

Apply pesticides so that they do not endanger humans, livestock, crops, beneficial insects, fish, and wildlife. Do not apply pesticides when there is danger of drift, when honey bees or other pollinating insects are visiting plants, or in ways that may contaminate water or leave illegal residues.

Avoid prolonged inhalation of pesticide sprays or dusts; wear protective clothing and equipment if specified on the container.

If your hands become contaminated with a pesticide, do not eat or drink until you have washed. In case a pesticide is swallowed or gets in the eyes, follow the first aid treatment given on the label, and get prompt medical attention. If a pesticide is spilled on your skin or clothing, remove clothing immediately and wash skin thoroughly.

When spraying near dwellings, be sure you have left no puddles of spray on hard soil surfaces. Also check children's playthings such as mud pie dishes or other containers that may retain the spray solution and endanger small children who may enter the area later.

Do not clean spray equipment or dump excess spray material near ponds, streams, or wells. Because it is difficult to remove all traces of herbicides from equipment, do not use the same equipment for insecticides or fungicides that you use for herbicides.

Dispose of empty pesticide containers promptly. Have them buried at a sanitary land-fill dump, or crush and bury them in a level, isolated place.

**NOTE:** Some States have restrictions on the use of certain pesticides. Check your State and local regulations. Also, because registrations of pesticides are under constant review by the Federal Environmental Protection Agency, consult your county agricultural agent or State Extension specialist to be sure the intended use is still registered.

## Protection of Persons Using Insecticides

In handling any insecticide, avoid repeated or prolonged contact with skin and prolonged inhalation of dusts, mists, and vapors. Wear clean, dry clothing, and wash hands and face before eating or smoking. Launder clothing daily.

Avoid spilling the insecticide on the skin and keep it out of the eyes, nose, and mouth. If you spill any on your skin or clothing, remove contaminated clothing immediately and wash the skin thoroughly with soap and water. Launder clothing before wearing it again. If the insecticide gets in the eyes, flush with plenty of water for 5 minutes and get medical attention.

The following insecticides can be used without special protective clothing or devices. In all cases, follow the label precautions.

Abate	ovex
<i>Bacillus thuringiensis</i>	paradichlorobenzene
calcium arsenate	paris green
carbaryl	Perthane
chlorobenzilate	piperonyl butoxide
cryolite	pyrethrins
dicofol	ronnel
diphenylamine	rotenone
Kepon	ryania
lead arsenate	sabadilla
lime sulfur	Strobane
malathion	sulfur
metaldehyde	TDE
methoxychlor	tetradifon
mirex	trichlorfon
naphthalene	zineb
oxythioquinox	

The following insecticides can be absorbed directly through the skin in harmful quantities. When working with these insecticides in any form, take extra care not to let them come in contact with the skin. Wear protective clothing and respiratory devices as directed on the label.

benzene hexachloride  
binapacryl  
chlordane  
chlorpyrifos  
coumaphos  
crotoxyphos  
cruformate  
diazinon  
dichlorvos  
dimethoate  
dioxathion  
endosulfan

The following insecticides are highly toxic and may be fatal if swallowed, inhaled, or absorbed through the skin. These materials should be applied only by a person who is thoroughly familiar with their hazards and who will assume full responsibility for proper use and comply with all the precautions on the labels.

aldicarb	endrin
aldrin	EPN
Bux	famphur
azinphosmethyl	methomyl
carbofuran	methyl parathion
carbophenothion	Methyl Trithion
compound 4072	mevinphos
Dasanit	mexacarbate
demeton	monocrotophosph
dichloropropane-dichloropropene	nicotine sulfate
mixture	parathion
dicrotophos	phorate
dieldrin	phosphamidon
disulfoton	Telone
DN-111	tepp
Dyfonate	

The following insecticides are used in closed spaces as fumigants. Because of their volatility and toxicity, they are considered to be hazardous when inhaled. In closed spaces these fumigants should be used only by a licensed

pest control operator or by a qualified person who is thoroughly familiar with their hazards, who will assume full responsibility for their proper use, and who knows he must comply with all precautions on the labels. The value given in parentheses after each material is the maximum average atmospheric concentration (threshold limit) of the insecticide, by volume, to which workers may be exposed for an 8-hour day without injury to health. These threshold limit values were adopted at the 30th Annual Meeting of the American Conference of Governmental Industrial Hygienists, May 1968.

acrylonitrile (20 p.p.m.)	ethyl formate (100 p.p.m.)
aluminum phosphide	ethylene dibromide (25 p.p.m.) <sup>2</sup>
(as phosphine 0.3 p.p.m.)	ethylene dichloride (200 p.p.m.)
calcium cyanide (5 mg. dust per cubic meter) <sup>2</sup>	ethylene oxide (50 p.p.m.)
carbon disulfide (20 p.p.m.)	hydrogen cyanide (10 p.p.m.)
carbon tetrachloride (10 p.p.m.)	methyl bromide (20 p.p.m.) <sup>3</sup>
chloroform (50 p.p.m.) <sup>3</sup>	methyl formate (100 p.p.m.)
chloropicrin (0.1 p.p.m.)	propylene oxide (100 p.p.m.)
	sulfonyl fluoride (5 p.p.m.)

Reduce the danger of skin exposure to insecticides by wearing protective clothing and equipment as specified on the label. If specified, wear a respirator or mask designed for protection against the particular insecticide being used. Directions for use or illustrative material must contain the names of the pesticide being used. Fullface masks should always be worn by persons applying fumigants in buildings or warehouses. They should also be worn by persons applying the type of insecticide aerosols used in commercial greenhouses and warehouses. In many cases masks or respirators are needed by persons loading insecticides into aircraft or applying them by aircraft.

The gas methyl chloride used as a propellant in greenhouse aerosols and the liquid fumigants carbon disulfide, ethyl formate, ethylene oxide, methyl formate, and propylene oxide are flammable and explosive. Never use them near heat or fire in any form. Never open containers of these chemicals where there is little air in circulation without wearing an adequate fullface mask. Do not transfer any liquid fumigant from one container to another in a closed room; do not breathe the fumes.

<sup>2</sup> Not from list of threshold limit values.

<sup>3</sup> Ceiling limit not to be exceeded.

## Protection of Persons Handling Treated Plants or Objects

If you must transplant or otherwise handle plants within 5 days after treatment with azinphosmethyl, demeton, disulfoton, endrin, or parathion or within 1 day after treatment with methyl parathion or mevinphos, protect your skin by wearing clean, dry cotton gloves. If gloves become wet, thoroughly wash the hands and put on clean gloves. If you must work in close contact with treated crops, as in thinning or harvesting, you should also wear dry, clean, tightly woven clothing.

If concentrated pesticide is spilled on the ground, remove or bury the contaminated soil. This is especially important in areas where small children play.

## Treatment for Poisoning

If a person is poisoned by an insecticide, call a physician and give first aid immediately. If breathing has stopped, give artificial respiration. If two persons are present, one should give first aid while the other obtains the insecticide container and calls the physician. Tell him the name of the insecticide and obtain instructions.

In general it is advisable to induce vomiting if the victim has swallowed a high toxic insecticide and is not in an unconscious state and a physician will not be available within 30 minutes. A tablespoonful of salt or baking soda in a glass of warm water will help induce vomiting. Have the victim lie down and keep him quiet until you get advice from a physician. Keep the victim warm.

If a concentrate or oil solution has been spilled on the skin or clothing, remove contaminated clothing and wash skin with soap and water. If a person feels sick while using an insecticide or shortly afterward, call a physician immediately. In all cases make available the insecticide container and any attached labeling. Information provided by them is extremely valuable to the physician. Inform him of recent contacts with insecticides. The one most obvious to you may not be the one to blame.

If a person is overcome by the vapor of a fumigant, prompt, on-the-spot action is essential. Carry the victim outdoors or to a room free of gas and lay him down. Remove contaminated clothing and keep him warm. Administer first aid treatment immediately. If breathing has stopped, give artificial

respiration. Call a physician immediately. Fumigators should have kits properly equipped with antidotes required for first aid treatment of a victim of the specific fumigant being used and instructions on treatments that are to be administered only by a physician.

In many cities a Poison Control Center will have available information concerning symptoms and treatment of cases of actual or suspected poisoning by pesticides; consult your local telephone directory. For a list of poison control centers, see Public Health "Directory Poison Control Centers," 1971 single copy available from Bureau of Chemical Hazards, Consumer Products Safety Commission, 5401 Westbard Ave., Bethesda, Md. 20016, or "Pesticide Handbook—Entoma," by D. E. H. Frear (24th ed., 1972), College Science Publishers, College Station, Pa. 16801.

### **Protection of Fish and Wildlife**

No chemical control of insects should be undertaken unless the expected benefits outweigh possible hazards to other animals. To minimize damage to fish and wildlife, do not use persistent chlorinated hydrocarbon insecticides when alternative insecticides of lesser hazard are available. Select insecticides and methods of application that are least hazardous and apply them at minimum effective dosages.

Avoid drift of insecticides as much as possible and limit applications of insecticides to the target area. To prevent damage to fish, birds, and other animals, be careful not to contaminate streams, lakes, marshes, and grazing or browsing areas by improper application or excessive drift of insecticides. Where drift is difficult to control, use sprays or granules instead of dusts, and ground applications instead of air applications.

Aircraft spraying in forest areas should be kept under aerial and ground surveillance at all times to insure precise application. Operations should be suspended any time the deposit pattern is not right. Monitor spray projects before, during, and after spraying to evaluate the effects of the insecticide on fish, wildlife, livestock, beneficial insects, water, soil, and plants. Pilots should fly spray planes at least 500 feet high when going back and forth between the airstrip and spray block. They should carefully choose a route parallel to but not over streams and avoid flights over lakes, ponds, farm buildings, or pastures. They should check frequently to be sure that calibration is correct and all components are in good operating condition.

Field borders, hedgerows, ditchbanks, stream margins, and wood edges are prime wildlife habitat. Insofar as feasible, avoid treating them. "Dressing the field margins" can be very hard on desirable animal life. Be careful to avoid leaving treated seed or insecticide granules on the surface; this is especially necessary at turnrows. Overlapping swaths of insecticides are dangerous in doubling or tripling the danger to wildlife. This danger is greatest near aerial turning points, where several swaths may overlap, if care is not taken to prevent it.

Do not clean spray equipment or dump excess spray materials in or near streams or other water areas where drainage could contaminate water.

In forest spraying by aircraft, lay out spray blocks and flight lines to minimize drift into water, marshes, grazing, and other sensitive areas. Spray as near treetop levels as safety permits to minimize drift. Leave a nonspray strip along critical streams, lakes, ponds, and any other areas that may be adversely affected. Spray only when the wind velocity is less than 6 miles per hour and the temperature is less than 68°F. Early morning or late evening hours are usually best for air operations. In aerial spraying of nonforest areas, take similar precautions.

### **Protection of Insect Parasites and Predators**

A program of crop or forest pest control should be designed to take maximum advantage of any biological control factors that may be present. Whenever possible, the insecticide should be selective against the pest species concerned and of minimum danger to beneficial insects. If parasites or predators are abundant, it may be advantageous to defer or omit insecticide treatments.

### **Protection of Honey Bees and Other Insect Pollinators**

More than half the crops listed in this handbook are dependent on insect pollination. An insecticide applied to these crops is of doubtful value if it destroys the pollinators while destroying the harmful insects. Most of this pollination is performed by honey bees. Protect them. Much of the damage to bees by insecticides can be prevented if you do not treat crops in bloom while

bees are visiting the field. Treatment at night is safest. Other steps that will reduce bee losses are:

- Use pesticides only when needed.
- Use the lowest effective dosage and make a minimum number of applications.
- Use a material that is least hazardous to bees but will control the insect pest, if applications must be made while bees are actively visiting the area.
- Use granules or dilute sprays instead of dusts. They are usually less hazardous. Application with ground equipment is less hazardous to bees than application with aerial equipment.
- Avoid drift of insecticides into bee yards and adjacent crop or wild plants in bloom.
- Do not apply insecticides if apiaries are near enough to be unavoidably affected; notify the beekeeper so he can move the hives in time.

chloropyrifos  
crotoxyphos  
Dasanit  
diazinon  
dichlorovos  
dicrotophos  
dieldrin  
dimethoate  
dyfonate  
EPN  
famphur  
fenthion  
heptachlor  
imidan

lead arsenate  
lindane  
malathion (as ULV or dust)  
methyl parathion  
Methyl Trithion  
mevinphos  
mexacarbate  
monocrotophos  
naled  
parathion  
phosphamidon  
propoxur  
tepp  
(Trichlorfon as a dust)

The following materials are toxic to bees and should not be applied when bees are actively visiting the area:

carbophenothion  
chlordane  
coumaphos  
crotoxyphos  
demeton  
disulfoton  
endosulfan  
endrin  
malathion as E.C.

mirex  
naled as E.C.  
perthane  
phorate  
phosalone  
propoxur  
ronnel  
TDE

The following lists indicate which insecticides are hazardous to honey bees, as determined by laboratory and field tests. These materials are hazardous to bees when applied as foliar treatments to agricultural and ornamental plants (including home garden applications), mosquito abatement treatments (except granular products) and foliage treatment to forests or shade trees. The materials are not hazardous when used as soil applications or dormant applications. For further information consult the pesticide container label. For information applicable to local conditions, consult your State agricultural experiment station.

**Hazardous.**—The following materials are highly toxic to bees exposed to direct treatment or residues. Do not apply these materials while plants are in bloom.

aldicarb	Bux
aldrin	calcium arsenate
azinphosmethyl	carbaryl
benzene hexachloride	carbofuran

### Avoiding Harmful Residues in or on Food and Feed

Residues in excess of the established legal tolerances can be avoided by applying only those insecticides specified for use on the crop or livestock and by following indicated schedules. Do not exceed recommended dosages. Observe carefully the safety restrictions, especially the required interval between the last application and harvest or feeding, and between the last application and slaughter of animals.

Avoid drift of insecticide sprays or dust to nearby crops or livestock, especially from applications by aircraft and other power equipment. Do not

allow poultry, dairy animals, or meat animals to feed on plants or drink water contaminated by drift of insecticides.

Certain root crops, such as sugarbeets, peanuts, carrots, and parsnips, are susceptible to contamination from residues of certain organochlorine insecticides in the soil. Do not apply aldrin, chlordane, dieldrin, endrin, heptachlor, or toxaphene to soils where the crop rotation includes one of these crops unless a finite tolerance has been established for the insecticide.

Byproducts from a number of crops treated with insecticides may be safely fed to livestock or poultry if the crops are harvested or fed after the specified waiting period. However, when byproducts from some crops treated with certain insecticides are fed to livestock, insecticide residues in excess of established tolerances may appear in meat, milk, or eggs. Before using an insecticide, read carefully the safety restrictions in the last column of the tables beginning on page 1.1 of this handbook to determine if such byproducts as sweet corn husks, citrus pulp, bagasse, alfalfa threshings, apple pomace, bean and pea vines, sugarbeet tops, cull potatoes, trimmings from leafy vegetables, and gin waste from cotton are safe for feeding to dairy animals, poultry, or animals being finished for slaughter.

In storage areas apply only those insecticides registered for the purpose. A commodity that comes in contact with floors or walls treated with an insecticide not registered for use in storage areas may become contaminated and be liable to confiscation. Repeated applications of some fumigants will cause residues to build up in the commodities. Be sure to follow the instructions on the registered label. Such a label will include an Environmental Protection Agency (EPA) Registration Number.

#### **Safe Disposal of Empty Insecticide Containers and Surplus Insecticides**

The careful disposal of empty insecticide containers and surplus insecticides is an important part of safe insecticide use. When possible, growers should carry their empty insecticide containers to a sanitary land-fill and have them buried. Do not abandon them on the land-fill. Inform the operator of the nature of the residues in the containers. Warn him of any danger of poisonous vapors if burned. Crush or puncture containers to prevent reuse.

If a suitable land-fill is not available, break or crush glass and metal containers (except pressurized cans) and bury them in an isolated place where

they will not contaminate water supplies. Pour excess insecticides into a hole at least 18 inches deep, dug in level ground in an isolated place where they will not contaminate water supplies. Cover with dirt. If you have trash collection service, wrap small empty containers in several layers of newspapers before placing them in trash cans.

Sell large drums that contained insecticides to a firm dealing in used drums or barrels. The firm should have equipment to neutralize the toxicity of the adhering insecticides. Do not attempt to use the drums where they could become a source of contamination to feed or water. Old pesticide drums used as floats corrode and thus cause serious fish kills.

Do not dump containers or leftover chemicals in gullies, ditches, streams, woods, or trash heaps.

For more specific information on the safe use of insecticides, consult your State agricultural experiment station or one of the following U.S. Department of Agriculture publications:

Program Aid 622, "Farmers' Checklist for Pesticide Safety"

Program Aid 589, "Safe Use of Pesticides in the Home—in the Garden"

ARS 33-76-2, "Respiratory Devices for Protection Against Certain Insecticides"

Program Aid 727, "Use Chemicals Safely in the Production of Beef Cattle, Swine, and Sheep."

#### **TOXICITY OF INSECTICIDES**

All insecticides must be considered potentially toxic to man and animals. However, the degree of toxicity is one of several factors in the use of insecticides that determine the hazard to man. *The primary hazard lies in failure to follow the precautions and directions for use indicated on the insecticide label and summarized in this handbook.* These precautions and directions depend not only on the degree of toxicity and the nature of toxicity of the insecticide but also on its stability. Some highly toxic insecticides that must be handled with great caution dissipate so rapidly upon exposure on plants or animals or in the soil that they create no serious residue

problems. On the contrary, some insecticides of low toxicity persist in the soil, on plants, and in meat and fat of animals that feed on these plants and may thus create critical residue problems.

In general, arsenical insecticides are very stable and may accumulate in the soil in quantities sufficient to injure plants. Small quantities are taken up by plants, which in time are eaten by animals.

Some organochlorine insecticides may also persist in the soil for years. Certain crops grown in such soils may pick up enough insecticide through contamination or translocation to exceed tolerances, even though the insecticide was not applied to them but to previous crops in the rotation. For example, enough aldrin or chlordane may persist in soil from year to year to contaminate such sensitive root crops as sugarbeets or carrots.

Organophosphorus insecticides generally are more toxic to animals than organochlorines. However, the organophosphorus insecticides usually do not leave highly persistent residues on treated plants or animals and are less likely to accumulate in animal tissues. Diazinon and parathion applied to the soil become ineffective within 2 or 3 months and are not problems in rotation of crops. The persistence of insecticides is reflected in the waiting periods required between application and harvest. The toxicity of insecticides is a major factor in determining the tolerances set. The tolerance is set at a safe level as determined by data obtained in animal feeding studies. An adequate safety factor is used in translating animal data to man. However, a tolerance is not established at a level higher than required for the purpose in accordance with good agricultural practice even if the toxicity of the pesticide is so low that a higher tolerance would be safe. Many factors must be considered in selecting an insecticide for a specific purpose. Whenever possible, preference should always be given to insecticides that have low toxicity, persist only a short time, and do not accumulate in animal tissues.

The following two tables provide information on the acute toxicity of various insecticides. In the first table, acute oral and dermal LD<sub>50</sub> (lethal dosage) values are given for most of the compounds included in this handbook. An LD<sub>50</sub> value is a statistical estimate of the dosage necessary to kill 50 percent of a population of white rats or other test animals within a specified period under standardized conditions in the laboratory. The toxicity of a chemical to such animals may vary, however, with species, age, sex, and nutritional state, and with the formulation of the insecticide and the manner of administration. Also the LD<sub>50</sub> values are usually expressed in terms of a single dosage, which provides little or no information on possible cumulative effects of repeated dosages of the compound.

In the second table are given the acute LC<sub>50</sub> values (lethal concentration) of some of the common insecticides for two fresh water fishes—rainbow trout and bluegills.

LD<sub>50</sub> or LC<sub>50</sub> values are useful in comparing different chemical compounds. However, they have certain limitations, and caution must be used in interpreting them in relation to actual use hazards. Since the values are obtained for other animals or fish, they can be applied to man only with reservations. Under comparable conditions and dosages, highly toxic substances are more hazardous than less toxic substances. However, such factors as dosage, frequency of application, and characteristics with respect to accumulation and persistence in animal tissues must be considered. For example, a highly toxic material applied at a low dosage may be less hazardous than a much less toxic one applied at a high dosage.

#### Acute Oral and Dermal LD<sub>50</sub> Values of Insecticides for Test Animals

(Data assembled by the Atlanta Toxicology Branch, Division of Pesticides, Bureau of Science, Food and Drug Administration, Consumer Protection and Environmental Health Service, Public Health Service, U.S. Department of Health, Education, and Welfare. Most of the values are based on standardized tests by the Atlanta Toxicology Laboratory of the Division of Pesticides; a few are based on publications from other laboratories. All values are for white rats unless otherwise indicated.)

Insecticide	Oral LD <sub>50</sub> (mg./kg.)		Dermal LD <sub>50</sub> (mg./kg.)	
	Males	Females	Males	Females
<i>Organochlorine Insecticides</i>				
aldrin	39	60	98	98
benzene hexachloride	1,250	..	..	..
chlordane	335	430	840	690
chlorobenzilate	1,040	1,220	..	>5,000
dichloropropane-				
dichloropropene	140	..	1,200	..
dicrofol	1,100	1,000	1,230	1,000
dieldrin	46	46	90	60
endosulfan	43	18	130	74

See footnotes at end of table.

Acute Oral and Dermal LD<sub>50</sub> Values of Insecticides for Test Animals—Continued

Insecticide	Oral LD <sub>50</sub> (mg./kg.)		Dermal LD <sub>50</sub> (mg./kg.)	
	Males	Females	Males	Females
endrin	17.8	7.5	18	15
ethylene dichloride	1 770	..	1, 2 3,890	..
heptachlor	100	162	195	250
Kepon	125	125	>2,000	>2,000
lindane	88	91	1,000	900
methoxychlor	5,000	5,000	..	>6,000
mirex	740	600	>2,000	>2,000
paradichlorobenzene	3,850	3,900	..	..
Pertthane	>4,000	>4,000	..	..
Sirobane	1 200	..	1, 2 >5,000	..
TDE	>4,000	>4,000	1, 2 >4,000	..
Telone	1 250-500	..	..	..
tetradifon	1 >14,700	..	1, 2 >10,000	..
toxaphene	90	80	1,075	780

*Organochlorine Insecticides—Continued*

*Organophosphorus Insecticides*

Abate	8,600	13,000	>4,000	>4,000
azinphosmethyl	13	11	220	220
carbophenothion	30	10	54	27
chlorpyrifos	155	82	202	..
coumaphos	41	15.5	860	..
croxyphos	110	74	375	202
crufomate	635	460	..	..
Dasanit	4.1	1.8	19	4.1
demeton	6.2	2.5	14	8.2
diazinon	108	76	900	455

See footnotes at end of table.

Acute Oral and Dermal LD<sub>50</sub> Values of Insecticides for Test Animals—Continued

Insecticide	Oral LD <sub>50</sub> (mg./kg.)		Dermal LD <sub>50</sub> (mg./kg.)	
	Males	Females	Males	Females
dichlorvos	80	56	107	75
dicrotophos	21	16	43	42
dimethoate	215	245	610	610
dioxathion	43	23	235	63
disulfoton	6.8	2.3	15	6
Dyfonate	1 >16.5	..	1, 2 >150	..
EPN	36	7.7	230	25
ethion	65	27	245	62
famphur	1 >35	..	1, 2 >1,460	..
fenthion	215	245	330	330
Imidan	113	160	>2,000	1,550
malathion	1,375	1,000	>4,444	>4,444
methyl parathion	14	24	67	67
Methyl Trithion	98	120	215	190
mevinphos	6.1	3.7	4.7	4.2
monocrotophos	17.5	20	126	112
naled	250	..	800	..
Nemacide	270	..	..	..
parathion	13	3.6	21	6.8
phorate	2.3	1.1	6.2	2.5
phosalone	120	135-170	1,390	..
phosphamidon	23.5	23.5	143	107
ronnel	1,250	2,630	..	>5,000
tepp	1.05	..	2.4	..
tetrapopyl	..	..	..	..
thiopyrophosphate	1 1,450	..	2,100	1,800
trichlorfon	630	560	>2,000	>2,000

*Organophosphorus Insecticides—Continued*

See footnotes at end of table.



Acute Oral and Dermal LD<sub>50</sub> Values of Insecticides for Test Animals—Continued

Insecticide	Oral LD <sub>50</sub> (mg./kg.)		Dermal LD <sub>50</sub> (mg./kg.)	
	Males	Females	Males	Females
aldicarb	0.8	0.65	3	2.5
Bux	95	63	242	156
carbaryl	850	500	>4,000	>4,000
carbofuran	8.7	8.0	>1,000	>1,000
mexacarbate	19	34	>2,000	>2,500
zineb	>5,000	>5,000	>2,500	>2,500
<i>Carbamate Insecticides</i>				
binapacryl	63	58	810	720
calcium arsenate	..	298	..	>2,400
cryolite	1 200	..	..	..
DN-111	1 330	..	1, 4 >1,000	..
ethylene dibromide	146	117	1, 2, 3 300	..
lead arsenate	..	1,050	..	>2,400
metalddehyde	1, 5 ca. 1,000	..	..	..
naphthalene	2,200	2,400	>2,500	>2,500
nicotine sulfate	..	83	..	285
ovex	1 2,050	..	..	..
oxythioquinox	1,800	1,100	>2,000	>2,000
paris green	..	100	..	>2,400
propoxur	83	86	>2,400	>2,400
pyrethrins	470	263	1, 2 >1,880	..
rotenone	1 50-75	..	1, 2 >940	..
ryania	1 1,200	..	1, 2 >4,000	..
Uniroyal DO14	1,480	1,480	250	680

<sup>1</sup> Sex not indicated.  
<sup>2</sup> Value for guinea pigs.  
<sup>3</sup> Value for rabbits.  
<sup>4</sup> Value for guinea pigs.  
<sup>5</sup> Value for dogs.

Acute 24-Hour LC<sub>50</sub> Values of Insecticides for Rainbow Trout and Bluegills

(Data provided by Fish-Pesticide Research Laboratory, U.S. Department of the Interior, Columbia, Mo. Rainbow trout were tested at 55° F. and bluegills at 65° or 75°. Certain persistent insecticides exhibit cumulative toxicity for fish and shellfish at levels lower than shown in this study.)

Insecticide	LC <sub>50</sub> for rainbow trout (p.p.b.)	LC <sub>50</sub> for bluegills (p.p.b.)
Abate	8,200	—
aldrin	14	22
azinphosmethyl	14	22
benzene hexachloride	76	560
binapacryl	42	41
carbaryl	3,500	3,400
carbophenothion	—	24
chlordan	22	54
chlorobenzilate	750	—
chlorpyrifos	32.6	3.4
crotoxyphos	140	760
cryolite	160,000	400,000
cube extract formulation (4.85 percent rotenone)	32	24
demeton	—	195
diazinon	380	54
dichlorvos	500	1,000
dichrotophos	15,000	38,000
dicofol	110	960
dieltrin	6	14
dimethoate	20,000	28,000
dioxathion	130	16
disulfoton	2,450	65
endosulfan	1.8	2.2
endrin	.7	.8
EPN	210	370
ethion	1,300	700
fenthion	840	1,800

Acute 24-Hour LC<sub>50</sub> Values of Insecticides for Rainbow Trout and Bluegills—Continued

Insecticide	LC <sub>50</sub> for rainbow trout (p.p.b.)	LC <sub>50</sub> for bluegills (p.p.b.)
heptachlor	15	35
Kepon	66	260
lime sulfur	10	48
lindane	30	61
malathion	100	120
methoxychlor	20	31
methyl parathion	7,000	8,500
Methyl Trithion	1,800	1,200
mevinphos	34	41
mexacarbate	7,000	—
mirex	126,000	>100,000
món ochrotophos	12,000	23,000
oxythioquinox	1,550	110
naled	250	2,200
Nemacide	1,600	4,300
ovex	860	870
parathion	2,000	56
Perthane	9	21
phorate	25	10
phosalone	11,000	5,100
phosphamidon	4,500	26,000
piperonyl butoxide	—	8,800
pyrethrins extract <sup>1</sup>	56	78
ryania	—	24,000
Strobane	12	15
TDE	30	56
tetradifon	3,700	1,100
toxaphene	7.6	7.2
trichlorfon	27,500	5,600

<sup>1</sup> Synergized formulation containing 4.85 percent of pyrethrins.

CHEMICALS REFERRED TO IN THIS HANDBOOK

[Common names for pesticides approved by the American National Standards Institute are indicated by an asterisk. Chemical names conform to those used in "Acceptable Common Names and Chemical Names for the Ingredients Statement on Pesticide Labels," 2d ed., 1972. Pesticides Regulations Division, Environmental Protection Agency.]

Name Used	Identity
Abate®	<i>O,O,O',O'</i> -tetramethyl <i>O,O'</i> -thiodi- <i>p</i> -phenylene phosphorothioate
acrylonitrile	acrylonitrile
aldicarb (Temik®)	2-methyl-2-(methylthio)propionaldehyde <i>O</i> -(methylcarbamoyl)oxime
*aldrin	hexachlorohexahydro- <i>endo</i> , <i>exo</i> -dimethanonaphthalene 95% and related compounds 5%
aluminum phosphide	aluminum phosphide
azinphosmethyl	<i>O,O</i> ,-dimethyl <i>S</i> -[(4-oxo-1,2,3-benzotriazin-3(4H)-yl)methyl] phosphorodithioate
benzene hexachloride	1,2,3,4,5,6-hexachlorocyclohexane, consisting of several isomers and containing a specified percentage of <i>gamma</i> isomer
*binapacryl	2- <i>sec</i> -butyl-4,6-dinitrophenyl 3-methyl-2-butenoate
borox	sodium tetraborate decahydrate
boric acid	boric acid
Bux®	a mixture of 3 parts <i>m</i> -(1-methylbutyl)phenyl methylcarbamate and 1 part <i>m</i> -(1-ethylpropyl)-phenyl methylcarbamate
calcium arsenate	calcium arsenate
calcium cyanide	calcium cyanide
*carbaryl	1-naphthyl methylcarbamate
*carbofuran (Furadan®)	2,3-dihydro-2,2-dimethyl-7-benzofuranyl methylcarbamate
carbon disulfide	carbon disulfide
carbon tetrachloride	carbon tetrachloride
*carbophenothion	<i>S</i> -[[( <i>p</i> -chlorophenyl)thio]methyl] <i>O,O</i> -diethyl phosphorodithioate

**Name Used**

**Identity**

chlordan, technical . . . octachloro-4,7-methanotetrahydroindan 60% and related compounds 40%  
 chlorobenzilate . . . ethyl 4,4'-dichlorobenzilate  
 chloroform . . . chloroform  
 chloropicrin . . . trichloronitromethane  
 \*chlorpyrifos(Dursban®) . . . *O,O*-diethyl *O*-(3,5,6-trichloro-2-pyridyl) phosphorothioate  
 Compound 4072 . . . 2-chloro-1-(2,4-dichlorophenyl)vinyl diethyl phosphate  
 coumaphos . . . . . *O,O*-diethyl *O*-(3-chloro-4-methyl-2-oxo-2H-1-benzopyran-7-yl) phosphorothioate.  
 crotoxyphos . . . . . dimethyl phosphate of *alpha*-methylbenzyl 3-hydroxy-*cis*-crotonate  
 \*cruformate (Ruelene®) . . . 4-*tert*-butyl-2-chlorophenyl methyl methylphosphoramidate  
 cryolite . . . . . sodium hexafluoroaluminate  
 Dasanit® . . . . . *O,O*-diethyl *O*-[*p*-(methylsulfinyl)phenyl] phosphorothioate  
 demeton . . . . . *O,O*-diethyl *O*-[2-(ethylthio) ethyl] phosphorothioate and *O,O*-diethyl *S*-[2-(ethylthio) ethyl] phosphorothioate  
 diazinon . . . . . *O,O*-diethyl *O*-(2-isopropyl-6-methyl-4-pyrimidinyl) phosphorodithioate.  
 dichloropropane-dichloropropene mixture  
 dichloropropene.  
 dichlorovos, technical . . . 93 percent 2,2-dichlorovinyl dimethyl phosphate and 7 percent related compounds  
 dicofol . . . . . 1,1-bis(*p*-chlorophenyl)-2,2,2-trichloroethanol  
 dicrotophos . . . . . dimethyl phosphate ester with 3-hydroxy-*N,N*-dimethyl-*cis*-crotonamide  
 dieldrin . . . . . hexachloroepoxyoctahydro-*endo,exo*-dime thanonaphthalene 85% and related compounds 15%  
 \*dimethoate . . . . . *O,O*-dimethyl *S*-(*N*-methylcarbamoyl methyl phosphorodithioate  
 \*dioxathion . . . . . 2,3-*p*-dioxanedithiol *S,S*-bis(*O,O*-diethyl phosphorodithioate)

**Name Used**

**Identity**

diphenylamine . . . . . diphenylamine  
 disulfoton . . . . . *O,O*-diethyl *S*-[2-(ethylthio)ethyl] phosphorodithioate  
 DN-111® . . . . . 4,6,-dinitro-*o*-cyclohexylphenol, dicyclohexylamine salt  
 dormant oil . . . . . a formulation of petroleum oil phytotoxic to foliage prepared for sprays on dormant plants, usually an emulsifiable concentrate of high oil content  
 Dyfonate® . . . . . *O*-ethyl *S*-phenyl ethylphosphonodithioate  
 \*endosulfan . . . . . 6,7,8,9,10,10-hexachloro-1,5,5a,6,9,9a-hexahydro-6,9-methano-2,4,3-benzodioxathiepin 3-oxide  
 endrin . . . . . hexachloroepoxyoctahydro-*endo-endo*-dimethanonaphthalene  
 EPN . . . . . *O*-ethyl *O*-(*p*-nitrophenyl) phenylphosphonothioate  
 \*ethion . . . . . *O,O,O',O'*-tetraethyl *S,S'*-methylenebisphosphorodithioate  
 ethylene dibromide . . . . . 1,2,-dibromoethane  
 ethylene dichloride . . . . . 1,2,-dichloroethane  
 ethylene oxide . . . . . ethylene oxide  
 ethyl formate . . . . . ethyl formate  
 famphur . . . . . *O,O*-dimethyl *O*-[*p*-(dimethylsulfamoyl)phenyl] phosphorothioate  
 fenthion . . . . . *O,O*-dimethyl *O*-[4-(methylthio)-*m*-tolyl] phosphorothioate  
 Flit MLO® . . . . . Mosquito larvicide oil (99% mineral oil)  
 heptachlor . . . . . heptachlorotetrahydro-4,7- methanoindene and related compounds  
 hydrogen cyanide . . . . . hydrocyanic acid  
 Imdan® . . . . . N-(mercaptomethyl) phthalimide  
 Kepone® . . . . . *S,O,O*-dimethyl phosphorodithioate  
 lead arsenate . . . . . 2H-cyclobuta [cd] pentalen-2-one lead arsenate

Name Used	Identity	Name Used	Identity
lime sulfur	30% calcium polysulfide and various small amount of calcium thiosulfate plus water and free sulfur	*phorate	<i>O,O</i> -diethyl <i>S</i> -[(ethylthio)methyl] phosphorodithioate
lindane	1,2,3,4,5,6-hexachlorocyclohexane, <i>gamma</i> isomer of not less than 99% purity	*phosalone	<i>O,O</i> -diethyl <i>S</i> -[(6-chloro-2-oxobenzoxazolin-3-yl)methyl] phosphorodithioate
malathion	<i>O,O</i> -dimethyl dithiophosphate of dimethyl mercaptosuccinate	*phosphamidon	2-chloro-2-diethylcarbamoyl-1-methylvinyl dimethyl phosphate
maldehyde	metaldehyde	piperonyl butoxide, technical	(butylcarbityl) 6-propylpiperonyl ether 80% and related compounds 20%
*methomyl	<i>S</i> -methyl <i>N</i> -[(methylcarbamoyl)oxy]-thioacetimidate	*propargite	2-( <i>p-tert</i> -butylphenoxy)cyclohexyl 2-propynyl sulfite
methoxychlor, technical	1,1,1-trichloro-2,2-bis( <i>p</i> -methoxyphenyl)ethane 88% and related compounds 12%	propoxur	<i>o</i> -isopropoxyphenyl methylcarbamate
methyl bromide	bromomethane	propylene oxide	propylene oxide
methyl chloride	chloromethane	pyrethrins	the active insecticidal constituents of pyrethrum
methyl formate	methyl formate	*ronnel	<i>O,O</i> -dimethyl <i>O</i> -(2,4,5-trichlorophenyl) phosphorothioate
methyl parathion	<i>O,O</i> -dimethyl <i>O</i> -( <i>p</i> -nitrophenyl) phosphorothioate	rotenone	the primary active compound of derris and cube roots
Methyl Trithion®	<i>S</i> -[( <i>p</i> -chlorophenyl)thio]methyl] <i>O,O</i> -dimethyl phosphorodithioate	ryania (ryanodine)	powdered stemwood of <i>Ryania speciosa</i>
mevinphos, technical	2-carbone thoxy-1-methylvinyl dimethyl phosphate <i>alpha</i> isomer and related compounds	sabadilla	ground seeds of sabadilla containing veratrine, a complex mixture of alkaloids
*mexacarbate (Zectran®)	4-(dimethylamino)-3,5-xylyl methylcarbamate	Strobane®	terpene polychlorinates (65 percent chlorine)
mirex	dodecachlorooctahydro-1,3,4-metheno-1 <i>H</i> -cyclobuta [ <i>cd</i> ] pentalene	sulfur	sulfur
monocrotophos	dimethyl phosphate of 3-hydroxy- <i>N,N</i> -dimethyl- <i>cis</i> -crotonamide	sulfuryl fluoride	sulfuryl fluoride
*naled	1,2-dibromo-2,2-dichloroethyl dimethyl phosphate	summer oil	a formulation of petroleum oil prepared for use in sprays to plant foliage, usually an emulsifiable concentrate of high oil content
naphthalene	naphthalene	tartar emetic	antimony potassium tartrate
Nemacide	<i>O</i> -(2,4-dichlorophenyl) <i>O,O</i> -diethyl phosphorothioate	TDE	dichlorodiphenyldichloroethane
*ovex	<i>p</i> -chlorophenyl <i>p</i> -chlorobenzenesulfonate	Telone®	mixed dichloropropenes
oxythioquinox	6-methyl-2,3-quinoxalinedithiol cyclic <i>S,S</i> -dithiocarbonate	tepp	tetraethyl pyrophosphate
paradichlorobenzene	<i>p</i> -dichlorobenzene	*tetradifon	4-chlorophenyl 2,4,5-trichlorophenyl sulfone
parathion	<i>O,O</i> -diethyl <i>O</i> -( <i>p</i> -nitrophenyl) phosphorothioate	tetrapropyl thiopyrophosphate (Aspon®)	<i>O,O,O,O</i> -tetrapropyl dithiopyrophosphate
paris green	copper acetoarsenite	toxaphene	chlorinated camphene containing 67-69 percent chlorine
Perrthane®	diethylphenyldichloroethane and related compounds	trichlorfon	dimethyl (2,2,2-trichloro-1-hydroxyethyl)-phosphonate
		zineb	zinc ethylenebis [dithiocarbamate]

**EXPLANATION OF TABLES THAT FOLLOW**

The tables that follow list the insecticides to use in the control of the major insect pests and give the formulations to purchase, dosages to use, and brief instructions on where and when to apply these insecticides. The tables also include the legal tolerances for insecticide residues permitted on food or feed products and the minimum time that must be allowed after applying the suggested dosages of insecticides in order to meet these tolerances. Other safety restrictions on the specific use of certain insecticides are given in the last column of the same page as the insecticide. Always read these safety restrictions to see if any of them apply to the insecticide that you plan to use and then observe those that are appropriate. For general precautions in the use of insecticides, see page .

With a few exceptions, the crops, insects, and insecticides are listed alphabetically. See page for the identification of the insecticides.

The insecticides listed for each insect are alternatives and are to be used separately unless mixtures of two or more materials are indicated by plus (+) signs.

"Formulation" refers to the form of the insecticide, usually as purchased. Dusts, baits, fumigants, aerosols, and granules are generally applied at the strength purchased. Emulsifiable concentrates, wettable powders, suspension concentrates, and powders are to be diluted with water unless otherwise indicated. The amount of water to use will depend on the output of the equipment.

A single entry in a box applies to all the insecticides and formulations opposite that box, except as specified.

A dash in any column indicates that there is no appropriate entry.

The word "extended" in the tolerance column means that the registration for this particular use of the insecticide has been extended to allow time for the establishment of a finite tolerance. It will be withdrawn when the extension expires. Therefore, the insecticide must not be used on the indicated crop or animal without determining whether the registration is still in effect. Check with your county agricultural agent or with your State agricultural experiment station.

The term "nonfood use" in the tolerance column means that a tolerance is not needed. The Pesticides Regulation Division has determined that based on

consideration of the pattern of use and the nature of the chemical, there is no reasonable expectation of any residue reaching and being retained in or on food or feed.

The word "safe" in the tolerance column means that the insecticide is "generally recognized as safe GRAS" under the provisions of 21 CFR 120.2 of the Federal Food, Drug, and Cosmetic Act as amended. A tolerance is not needed for such insecticides. Also, when "exempt" appears in this column, it means that under the provisions of this act, the insecticide used in this specific way has been exempted from the requirement for establishment of a tolerance.

The following abbreviations are used:

- Bait . . . . . B
- Dust . . . . . D
- Emulsifiable concentrate . . . . . EC
- Fumigant . . . . . F
- Granules . . . . . G
- Solution . . . . . soln.
- Spray . . . . . S
- Ultra low volume concentrate . . . . . ULV
- Wettable powder . . . . . WP

The insecticide dosages given in this handbook are the maximums suggested for mature plants and animals. Often they may be reduced for immature plants or animals without loss in effectiveness. Effective dosages may also be reduced by careful attention to application under favorable weather conditions. However, be careful not to exceed the suggested dosages except as indicated on the registered insecticide label. Dosages larger than those suggested in these tables may leave illegal residues on the harvested product unless more time is allowed between the last application and harvest than is suggested in the table.

The principles followed in the commercial use of insecticides on crops, livestock, or stored products should also be followed in their use in the home and the home garden. However, untrained persons should not use any insecticide labeled POISON and illustrated with the drawing of the skull and crossbones.

Trade names are used in this handbook solely for the purpose of providing specific information. Mention of a trade name does not constitute a guarantee or warranty of the product by the U.S. Department of Agriculture.

STORED PRODUCT INSECTS

COMMODITY, STORAGE, AND INSECT	INSECTICIDE OR TREATMENT	TOLERANCE (p. p. m.)	FORMULATION	DOSAGE (active ingredient per 1,000 cu. ft. unless otherwise stated)	HOW, WHERE, AND WHEN TO APPLY	SAFETY RESTRICTIONS
<b>FRUITS, DRIED—</b> Raisins (processed) (con.)	Ethyl formate or methyl formate	250	F	5 ml./case	During summer in cases just before sealing.	Fumigants should be applied only by a trained operator.
In bulk 30-lb cases Saw-toothed and merchant grain beetles, dried-fruit beetles, Indian meal moth				7 ml./case	During winter in cases just before sealing.	
In storage Saw-toothed and merchant grain beetles, dried-fruit beetles, Indian meal moth	Cold storage	..	..	32° - 40° F. and 50%-60% relative humidity.	Storage life is about 1 year if moisture content is not above 15% - 20%.	
<b>FURNISHINGS—(See page 14.10)</b>						
<b>FABRICS—</b>						
<b>Furnishings)</b>						
<b>FURS</b>						
In the home Clothes moths and carpet beetles	Cold storage	..	..	34° - 40° F. and 44%-55% relative humidity.	Professional storage is advisable.	
<b>GRAIN—Barley (See GRAIN—Corn, shelled)</b>						
Control measures for insects in stored barley are the same as in GRAIN—Corn, shelled, page 14.24.						
<b>GRAIN—Corn, ear</b>						
In bags in ware-house Grain weevils, lesser grain borer, grain beetles, Angoumois grain moth, Indian meal moth	Hydrogen cyanide Methyl bromide	100 50 (inorganic bromide)	F F	3 lb. 2 lb. 4 lb.	Space fumigation. Space fumigation. 24 hours at 80° F. or above. Space fumigation. 24 hours at 50° - 59° F.	Fumigants should be applied only by a trained operator. Do not fumigate with hydrogen cyanide (HCN) at temperatures below 60° F. Aerate for 24 hours after treatment. Aerate after fumigation with methyl bromide.

STORED-PRODUCT INSECTS

COMMODITY, STORAGE, AND INSECT	INSECTICIDE OR TREATMENT	TOLERANCE (p. p. m.)	FORMULATION	DOSAGE (active ingredient per 1,000 cu. ft. unless otherwise stated)	HOW, WHERE, AND WHEN TO APPLY	SAFETY RESTRICTIONS
GRAIN—Corn, ear (con.)	Methyl bromide	50 (inorganic bromide)	F	2 lb.	Cover crib with gastight tarpaulin. 24 hours at 60° F. or above.	
In perforated steel crib bins Grain weevils, lesser grain borer, grain beetles, Angoumois grain moth, Indian meal moth	Carbon tetrachloride + carbon disulfide (80:20 mixture)	Exempt	F	6 gal./1,000 bu.	Distribute fumigant evenly over surface. Cover crib with gastight tarpaulin.	
In wooden crib bins Grain weevils, lesser grain borer, grain beetles, Angoumois grain moth, Indian meal moth	Ethylene dichloride + carbon tetrachloride (75:25 mixture)	Exempt	F	6 gal./1,000 bu.	Distribute fumigant evenly over surface. Cover crib with gastight tarpaulin.	
GRAIN—Corn, shelled or ear	Chloropicrin	Exempt	F	1.5 lb./1,000 cu. ft. of space above grain.	Apply as fine spray or vapor into space over top of grain to control moths in surface layer. 70° F. or above.	Fumigants should be applied only by a trained operator.
In bulk Indian meal moth	Mineral oil	200	S	2 lb./1,000 cu. ft. of space above grain.	Apply as fine spray or vapor into space over top of grain to control moths in surface layer. Below 70° F.	Do not release aerosol near an open flame.
					Protective treatment with oil spray on surface. In South—First application after grain is fumigated; second in July or August. In North—First application after harvest following fumigation; second in April or May of next year.	Mineral oil to meet specification established by Food and Drug Administration.

Use Pesticides Safely—Follow the Label

STORED-PRODUCT INSECTS

COMMODITY, STORAGE, AND INSECT	INSECTICIDE OR TREATMENT	TOLERANCE (p. p. m.)	FORMULATION	DOSAGE (active ingredient per 1,000 cu. ft. unless otherwise stated)	HOW, WHERE, AND WHEN TO APPLY	SAFETY RESTRICTIONS
GRAIN—Corn, shelled or ear (con.) Flying insects	Pyrethrins + piperonyl butoxide	3 + 20*	Oil soln. % by wt. Pyrethrins 0.2 + piperonyl butoxide 2.0 + tetrachloroethylene 50.0 + deodorized kerosene 47.8	0.006 + 0.06 lb./1,000 cu. ft. of airspace.	Apply with thermal aerosol generator.	
In warehouses Grain weevils, lesser grain borer, grain beetles, Angoumois grain moth, Indian meal moth	Malathion (premium grade)	8	EC	0.63 lb./1,000 bu.	Spray into grain stream as it goes into storage. Mix with water—3 - 5 gal./1,000 bu.	Soft insect-susceptible varieties are difficult to protect. The dust will cause downgrading of market grain.  Fumigants should be applied only by a trained operator.  Do not recirculate phosphine from aluminum phosphide.  Under no conditions shall any processed food or animal feed come in contact with any aluminum phosphide nor with aluminum phosphide residues.
				0.32 lb. in 1 to 2 gal. water/1,000 sq. ft.	Surface spray. Will not control insects established beneath the surface.	
				0.06 + 0.6 lb./1,000 bu.	Spray into grain stream as it goes into storage. Mix with water—3 - 5 gal./1,000 bu.	
GRAIN—Corn, shelled (also Barley and Oats) In concrete or metal upright bins, 3,200-bu. metal bins, or farm-type metal bins Grain weevils, lesser grain borer, grain beetles, Angoumois grain moth, Indian meal moth	Aluminum phosphide	0.1** (phosphine)	F	3 tablets/ton or 90 tablets/1,000 bu.	Add to grain stream. Fumigate for 5 days at 54° - 59° F., 4 days at 60° - 68° F., or 3 days at 69° F. or above.	
				10 pellets/ton or 300 pellets/1,000 bu.		

\*Tolerance for pyrethrins and piperonyl butoxide on oats is 1 + 8 p.p.m.

\*\*The tolerance for phosphine on processed commodities is 0.01 p.p.m. and on raw products, 0.1 p.p.m.



STORED-PRODUCT INSECTS

COMMODITY, STORAGE, AND INSECT	INSECTICIDE OR TREATMENT	TOLERANCE (p. p. m.)	FORMULATION	DOSAGE (active ingredient per 1,000 cu. ft. unless otherwise stated)	HOW, WHERE, AND WHEN TO APPLY	SAFETY RESTRICTIONS	
GRAIN—Corn, shelled (also Barley and Oats) (con.)  In concrete or metal upright bins, 3,200-bu. metal bins, or farm-type metal bins Grain weevils, lesser grain borer, grain beetles, Angoumois grain moth, Indian meal moth	Calcium cyanide	25 (hydrogen cyanide)	F	12 - 15 lb./1,000 bu.	Mix into grain stream at 70° F. or above.	Fumigants should be applied only by a trained operator.	
	Carbon tetrachloride + carbon disulfide (80:20 mixture)	Exempt	F	3 gal./1,000 bu.*	Gravity-distribution fumigation. Surface application or layering method. 60° F. or above.	Aerate after fumigation.	
				1.75 gal.*	Forced-distribution fumigation. Closed-recirculation or single-pass. 60° F. or above.		
				2 gal.*	Forced-distribution fumigation. Closed-recirculation or single-pass. Below 60° F.		
	Chloroform + carbon disulfide + ethylene dibromide	50 (inorganic bromide) Others exempt	F		2.25 gal./1,000 bu.*	Gravity-distribution fumigation. Surface application or layering method. 60° F. or above.	
					2.75 gal./1,000 bu.*	Gravity-distribution fumigation. Surface application or layering method. Below 60° F.	
	Chloropicrin	Exempt	F		3 lb./1,000 bu.*	Gravity-distribution fumigation. Surface application. 70° F. or above.	
					4 lb./1,000 bu.*	Gravity-distribution fumigation. Surface application. Below 70° F.	
	Chloropicrin + methyl chloride (85:15 mixture)	Exempt	F		2 lb.	Forced-distribution fumigation. Closed-recirculation or single-pass. 70° F. or above.	
					3 lb.	Forced-distribution fumigation. Closed-recirculation or single-pass. Below 70° F.	

\*Double the dosage if used in wooden bins.

STORED PRODUCT INSECTS

COMMODITY, STORAGE, AND INSECT	INSECTICIDE OR TREATMENT	TOLERANCE (p. p. m.)	FORMULATION	DOSAGE (active ingredient per 1,000 cu. ft. unless otherwise stated)	HOW, WHERE, AND WHEN TO APPLY	SAFETY RESTRICTIONS
GRAIN—Corn, shelled (also Barley and Oats) (con.) In concrete or metal upright bins, 3,200-bu. metal bins, or farm-type metal bins Grain weevils, lesser grain borer, grain beetles, Angoumois grain moth, Indian meal moth	Ethylene dibromide + methyl bromide (70:30 mixture)	50 (inorganic bromide)	F	24 - 36 oz./1,000 bu.*	Gravity-distribution fumigation. Surface application or layering method. 70° F. or above in farm-type bins.	Fumigants should be applied only by a trained operator.
	Ethylene dibromide + methyl bromide (30:70 mixture)	50 (inorganic bromide)	F	30 - 36 oz./1,000 bu. 1.125 - 1.5 lb.*	Probe fumigant into hotspot. Forced-distribution fumigation. Closed-recirculation or single-pass. 70° F. or above.	Aerate after fumigation.
	Ethylene dichloride + carbon tetrachloride (75:25 mixture)	Exempt	F	2 - 3 lb.* 4.5 gal./1,000 bu.*	Forced-distribution fumigation. Closed-recirculation or single-pass. Below 70° F. Gravity distribution fumigation. Surface application or layering method. 70° F. or above.	Do not fumigate with hydrogen cyanide (HCN) at temperatures below 60° F. Aerate for 24 hours after treatment.
	Ethylene dibromide + ethylene dichloride + carbon tetrachloride (5: 35: 60 mixture)	50 (inorganic bromide) Others exempt	F	2.5 gal.* 3.5 gal.*	Forced distribution fumigation. Closed-recirculation or single-pass. 70° F. or above. Forced-distribution fumigation. Closed-recirculation or single-pass. Below 70° F.	Do not recirculate phosphine from aluminum phosphide.
In flat storage Beetles and moths	Hydrogen cyanide	100	F	3 lb.	Forced-distribution fumigation. Closed-recirculation or single-pass.	
	Methyl bromide	50 (inorganic bromide)	F	2 lb. 3 lb.	Forced-distribution fumigation. Closed-recirculation or single-pass. 24 hours at 60° F. or above. Forced-distribution fumigation. Closed-recirculation or single-pass. 24 hours at below 60° F.	
	Aluminum phosphide	0.1** (phosphine)	F	3 tablets/ton or 90 tablets/1,000 bu.	Probe tablets into corn. Fumigate for 5 days at 54° - 59° F., 4 days at 60° - 68° F., or 3 days at 69° F. or above.	

\*Double the dosage if used in wooden bins.

\*\*The tolerance for phosphine on processed commodities is 0.01 p.p.m. and on raw products, 0.1 p.p.m.

STORED-PRODUCT INSECTS

COMMODITY, STORAGE, AND INSECT	INSECTICIDE OR TREATMENT	TOLERANCE (p. p. m.)	FORMULATION	DOSAGE (active ingredient per 1,000 cu. ft. unless otherwise stated)	HOW, WHERE, AND WHEN TO APPLY	SAFETY RESTRICTIONS
<b>GRAIN—Corn, shelled (also Barley and Oats) (con.)</b> In flat storage Grain weevils, lesser grain borer, grain beetles, Angoumois grain moth, Indian meal moth	Calcium cyanide	26 (hydrogen cyanide)	F	15 - 20 lb./1,000 bu.	Mix into grain as it is being placed in storage.	
	Carbon tetrachloride + carbon disulfide (80:20 mixture)	Exempt	F	4.5 gal.	Gravity-distribution fumigation. Surface application or layering method. 70° F. or above.	Aerate after fumigation.
				2 gal.	Forced-distribution fumigation. Closed-recirculation or single-pass. 60° F. or above.	Fumigants should be applied only by a trained operator.
				2.25 gal.	Forced-distribution fumigation. Closed-recirculation or single-pass. Below 60° F.	
	Chloroform + carbon disulfide + ethylene dibromide (71.25: 23.75: 5.0 mixture)	50 (inorganic bromide) Others exempt	F	3.75 gal./1,000 bu.	Gravity-distribution fumigation. 70° F. or above.	
				4.25 gal./1,000 bu.	Gravity-distribution fumigation. Below 70° F.	
	Chloropicrin + methyl chloride (85:15 mixture)	Exempt	F	2 lb.	Forced-distribution fumigation. Closed-recirculation or single-pass. 70° F. or above.	
				3 lb.	Forced-distribution fumigation. Closed-recirculation or single-pass. Below 70° F.	
	Ethylene dibromide + methyl bromide (30:70 mixture)	50 (inorganic bromide)	F	1.5 lb.	Forced-distribution fumigation. Closed-recirculation or single-pass. 70° F. or above.	
				2.5 lb.	Forced-distribution fumigation. Closed-recirculation or single-pass. Below 70° F.	
	Ethylene dibromide + methyl bromide (70:30 mixture)	50 (inorganic bromide)	F	30 - 36 oz./1,000 bu.	Probe fumigant into hotspot	

STORED-PRODUCT INSECTS

COMMODITY, STORAGE, AND INSECT	INSECTICIDE OR TREATMENT	TOLERANCE (p. p. m.)	FORMULATION	DOSAGE (active ingredient per 1,000 cu. ft. unless otherwise stated)	HOW, WHERE, AND WHEN TO APPLY	SAFETY RESTRICTIONS
<p><b>GRAIN—Corn, shelled (also Barley and Oats) (con.)</b></p> <p>In flat storage Grain weevils, lesser grain borer, grain beetles, Angoumois grain moth, Indian meal moth</p>	Ethylene dichloride + carbon tetrachloride (75:25 mixture)	Exempt	F	6 gal./1,000 bu. 2.75 gal.	Gravity-distribution fumigation. 70° F. or above. Forced-distribution fumigation. Closed-recirculation or single-pass. 70° F. or above.	Fumigants should be applied only by a trained operator. Aerate after fumigation.
	Ethylene dibromide + ethylene dichloride + carbon tetrachloride (5: 35: 60 mixture)	50 (inorganic bromide) Others exempt	F	4.25 gal./1,000 bu.	Forced-distribution fumigation. Closed-recirculation or single-pass. Below 70° F. Gravity-distribution fumigation. 70° F. or above.	Do not fumigate with hydrogen cyanide (HCN) at temperatures below 60° F. Aerate for 24 hours after treatment.
	Hydrogen cyanide	100	F	3 lb.	Forced-distribution fumigation. Closed-recirculation or single-pass.	
	Methyl bromide	50 (inorganic bromide)	F	2 lb.	Forced-distribution fumigation. Closed-recirculation or single-pass. 24 hours at 60° F. or above.	
	Malathion (premium grade).	8	EC	0.63 lb./1,000 bu.	Forced-distribution fumigation. Closed-recirculation or single-pass. 24 hours at below 60° F. Mix with water 3 · 5 gal./1,000 bu. Spray on grain stream as it goes into storage.	Fumigants should be applied only by a trained operator. Repeated surface sprays with malathion may cause excessive residues.
			D	0.32 lb./1,000 sq. ft. of surface area. 0.6 lb./1,000 bu.	Surface spray. Will not control insects already established beneath the surface. Mix dust into wheat before storing.	

Use Pesticides Safely—Follow the Label

STORED-PRODUCT INSECTS

COMMODITY, STORAGE, AND INSECT	INSECTICIDE OR TREATMENT	TOLERANCE (p. p. m.)	FORMULATION	DOSAGE (active ingredient per 1,000 cu. ft. unless otherwise stated)	HOW, WHERE, AND WHEN TO APPLY	SAFETY RESTRICTIONS
GRAIN—Corn, shelled (also Barley and Oats) (con.)	Pyrethrins + piperonyl butoxide	3 + 20*	EC or oil soln.	0.08 + 0.6 lb./1,000 bu.	Mix with water 3 - 5 gal./1,000 bu. Apply as protective spray to grain before it is stored.	Fumigants should be applied only by a trained operator. Repeated surface sprays with malathion may cause excessive residues.
				0.06 + 0.83 lb./1,000 bu.	Mix dust into wheat before storing.	
In flat storage Grain weevils, lesser grain borer, grain beetles, Angoumois grain moth, Indian meal moth			D			
In bulk, in freight cars Grain weevils, lesser grain borer, grain beetles, Angoumois grain moth, Indian meal moth	Ethylene dibromide + ethylene dichloride + carbon tetrachloride (5: 35: 60 mixture)	50 (inorganic bromide) Others exempt	F	5.75 gal./1,000 bu.	Apply from outside of car using hand or power sprayer.	
In bulk, in freight cars and van trucks Grain weevils, lesser grain borer, grain beetles, Angoumois grain moth, Indian meal moth	Chloropicrin	Exempt	F	3 lb.	Recirculation fumigation. 70° F. or above.	
				4 lb.	Recirculation fumigation. Below 70° F.	
Storage bin Grain weevils, lesser grain borer, grain beetles, Angoumois grain moth, Indian meal moth	Malathion (premium grade)	8 on grain	EC	0.45 lb./1,000 sq. ft.	Mix with water. At least 2 - 4 weeks before grain is binned, spray inside walls and floor of bin at rate of 2 gal./1,000 sq. ft.	
				0.4 lb./1,000 sq. ft.		
	Methoxychlor	2 on grain	WP, EC			
	Pyrethrins + piperonyl butoxide	3 + 20	Soln.	0.013 - 0.13 lb./1,000 sq. ft.	Mix with water and apply to walls and floor of empty storage at the rate of 2 gal./1,000 sq. ft.	

\*Tolerance for pyrethrins and piperonyl butoxide on oats is 1 + 8 p.p.m.

Issued October 1972

Use Pesticides Safely—Follow the Label

STORED-PRODUCT INSECTS

COMMODITY, STORAGE, AND INSECT	INSECTICIDE OR TREATMENT	TOLERANCE (p. p. m.)	FORMULATION	DOSAGE (active ingredient per 1,000 cu. ft. unless otherwise stated)	HOW, WHERE, AND WHEN TO APPLY	SAFETY RESTRICTIONS
Control measures for insects in stored oats are the same as in GRAIN—Corn, shelled, page 14.24.						
GRAIN—Popcorn						
In bags in freight cars Grain weevils, lesser grain borer, grain beetles, Angoumois grain moth, Indian meal moth	Methyl bromide	240 (inorganic bromide)	F	15 lb. in refrigerator car.	Fumigate for 24 hr.	Fumigants should be applied only by a trained operator.  Do not fumigate with hydrogen cyanide (HCN) at temperatures below 60° F. Aerate for 24 hours after treatment.  Aerated after fumigation.
				14 lb. in wooden car.		
				10 lb. in steel car.		
In bags in ware houses, in fumigation chambers, or under tarpaulins Grain weevils, lesser grain borer, grain beetles, Angoumois grain moth, Indian meal moth	Hydrogen cyanide  Methyl bromide	100  240 (inorganic bromide)	F  F	1 lb.	Perforated steel cribs should be covered with tarpaulins. Fumigate 24 hr. at 70° F. or above.	
				1.5 lb.		
In bulk, in packer bins with circulation systems Grain weevils, lesser grain borer, grain beetles, Angoumois grain moth, Indian meal moth	Methyl bromide	240 (inorganic bromide)	F	1.5 lb.	Recirculation fumigation. 24 hr. at 70° F. or above.	
				2 lb.	Recirculation fumigation: 24 hr. at 60° - 69° F.	
				2.5 lb.	Recirculation fumigation. 24 hr. at 50° - 59° F.	
				3 lb.	Recirculation fumigation. 24 hr. at 40° - 49° F.	
In perforated steel crib bins Grain weevils, lesser grain borer, grain beetles, Angoumois grain moth, Indian meal moth	Methyl bromide	240 (inorganic bromide)	F	2 lb.	Cover crib with gastight tarpaulin. 24 hr. at 60° F. or above.	

STORED-PRODUCT INSECTS

COMMODITY, STORAGE, AND INSECT	INSECTICIDE OR TREATMENT	TOLERANCE (p. p. m.)	FORMULATION	DOSAGE (active ingredient per 1,000 cu. ft. unless otherwise stated)	HOW, WHERE, AND WHEN TO APPLY	SAFETY RESTRICTIONS
GRAIN—Popcorn (con.)	Carbon tetrachloride + carbon disulfide (80:20 mixture)	Exempt	F	1 oz. in 100-lb. metal can.	Distribute fumigant evenly over surface and expose for 24 hr.	Fumigants should be applied only by a trained operator. Aerate after fumigation.
	Ethylene dichloride + carbon tetrachloride (75:25 mixture)	Exempt	F			
In wooden crib bins Grain weevils, lesser grain borer, grain beetles, Angoumois grain moth, Indian meal moth	Carbon tetrachloride + carbon disulfide (80:20 mixture)	Exempt	F	6 gal./1,000 bu.	Distribute fumigant evenly over surface. Cover crib with gastight tarpaulin. 60° F. or above.	
	Ethylene Dichloride + carbon tetrachloride (75:25 mixture)	Exempt	F	6 gal./1,000 bu.	Distribute fumigant evenly over surface. Cover crib with gastight tarpaulin. 70° F. or above.	
In wooden or metal bins Grain weevils, lesser grain borer, grain beetles, Angoumois grain moth, Indian meal moth	Carbon tetrachloride + carbon disulfide (80:20 mixture)	Exempt	F	5 gal./1,000 bu.	Distribute fumigant evenly over surface. Cover crib with gastight tarpaulin. 60° F. or above.	
	Ethylene dichloride + carbon tetrachloride (75:25 mixture)	Exempt	F	5 gal./1,000 bu.	Distribute fumigant evenly over surface. Cover crib with gastight tarpaulin. 70° F. or above.	
GRAIN—Rice enriched	Aluminum phosphide	0.01° (phosphine)	F		In tarpaulin fumigation place tablets or pellets in trays at each corner of stack.	Fumigants should be applied only by a trained operator.
				45 tablets	Fumigate for 5 days at 54° - 59° F., 4 days at 60° - 68° F., or 3 days at 69° F. or above.	Aerate products 48 hours before offering to consumer.

\*The tolerance for phosphine on processed commodities is 0.01 p.p.m. and on raw products, 0.1 p.p.m.

Issued October 1972

Use Pesticides Safely—Follow the Label

STORED-PRODUCT INSECTS

COMMODITY, STORAGE, AND INSECT	INSECTICIDE OR TREATMENT	TOLERANCE (p. p. m.)	FORMULATION	DOSAGE (active ingredient per 1,000 cu. ft. unless otherwise stated)	HOW, WHERE, AND WHEN TO APPLY	SAFETY RESTRICTIONS
<p>GRAIN—Rice enriched (con.)</p> <p>In packages Saw-toothed grain beetle, flour beetles, Indian meal moth</p>	<p>Aluminum phosphide (phosphine)</p>	<p>0.01*</p>	<p>F</p>	<p>165 pellets</p>	<p>Fumigate for 4 days at 54° - 59° F., 3 days at 60° - 68° F., or 2 days at 69° F. or above.</p>	<p>Under no conditions shall any processed food or animal feed come in contact with any <u>aluminum phosphide</u> nor with <u>aluminum phosphide</u> residues.</p>

\*The tolerance for phosphine on processed commodities is 0.01 p.p.m. and on raw products, 0.1 p.p.m.



STORED-PRODUCT INSECTS

COMMODITY, STORAGE, AND INSECT	INSECTICIDE OR TREATMENT	TOLERANCE (p. p. m.)	FORMULATION	DOSAGE (active ingredient per 1,000 cu. ft. unless otherwise stated)	HOW, WHERE, AND WHEN TO APPLY	SAFETY RESTRICTIONS
GRAIN—Rice, enriched (con.) In packages Saw-toothed grain beetle, flour beetles, Indian meal moth	Methyl bromide	125 (inorganic bromide)	F	1.5 oz./1,000 lb.	4 hr. at 70° F. or above in atmospheric chamber.	Fumigants should be applied only by a trained operator.  Aerate after fumigation with <u>methyl bromide</u> .  Under no conditions shall any processed food or animal feed come in contact with any <u>aluminum phosphide</u> nor with <u>aluminum phosphide</u> residues. Aerate products 48 hours before offering to consumer.  Repellent pyrethrins + piperonyl butoxide treatment not to be used on bags of less than 50 lb. size.
				1.75 lb.	6 hr. at 70° F. or above in atmospheric chamber.	
				1 oz./1,000 lb.	12 hr. at 70° F. or above in atmospheric chamber.	
				1.5 lb.	2 hr. at 65° F. or above in vacuum chamber.	
				0.5 oz./1,000 lb.	3 hr. at 65° F. or above in vacuum chamber.	
				0.75 lb.		
				1.5 oz./1,000 lb.		
				3 lb.		
				0.75 oz./1,000 lb.		
				2 lb.		
In bags Saw-toothed grain beetle, flour beetles, Indian meal moth	Pyrethrins + piperonyl butoxide + insect-tight kraft bags.	1 + 10	WP	5 ± 1 mg. pyrethrins + 50 ± 10 mg. piperonyl butoxide /sq. ft. of bag surface.	The insect-repellent treatment is to be applied on the paper used as the outer ply of multiwall bags having insect-tight construction as in specifications available from ARS.	
GRAIN—Rice milled In bags or cartons in fumigation chambers Saw-toothed grain beetle, flour beetles, Indian meal moth	Aluminum phosphide	0.01* (phosphine)	F		In tarpaulin fumigation, place tablets or pellets in trays at each corner of stack.	
				45 tablets	Fumigate for 5 days at 54° - 59° F., 4 days at 60° - 68° F., or 3 days at 69° F. or above.	
				165 pellets	Fumigate for 4 days at 54° - 59° F., 3 days at 60° - 68° F., or 2 days at 69° F. or above.	

\*The tolerance for phosphine on processed commodities is 0.01 p.p.m. and on raw products, 0.1 p.p.m.

Use Pesticides Safely—Follow the Label

STORED-PRODUCT INSECTS

COMMODITY, STORAGE, AND INSECT	INSECTICIDE OR TREATMENT	TOLERANCE (p. p. m.)	FORMULATION	DOSAGE (active ingredient per 1,000 cu. ft. unless otherwise stated)	HOW, WHERE, AND WHEN TO APPLY	SAFETY RESTRICTIONS
GRAIN—Rice, milled (con.)	Methyl bromide	125 (inorganic bromide)	F	1.5 oz./1,000 lb. 1.75 lb.	4 hr. at 70° F. or above in atmospheric chamber.	Fumigants should be applied only by a trained operator.
In bags in fumigation chambers Saw-toothed grain beetle, flour beetles, Indian meal moth				1 oz./1,000 lb. 1.5 lb.	6 hr. at 70° F. or above in atmospheric chamber.	Aerate after fumigation with <u>methyl bromide</u> .
				0.5 oz./1,000 lb. 0.75 lb.	12 hr. at 70° F. or above in atmospheric chamber.	
				1.5 oz./1,000 lb. 3 lb.	2 hr. at 65° F. or above in vacuum chamber.	
				0.75 oz./1,000 lb. 2 lb.	3 hr. at 65° F. or above in vacuum chamber.	
In bins Saw-toothed grain beetle, flour beetles, Indian meal moth	Methyl bromide	125 (inorganic bromide)	F	1 lb.	Fumigate in packer bins for 15 hr.	Aerate after fumigation with <u>methyl bromide</u> .
Storage bin Saw-toothed grain beetle, flour beetles, Indian meal moth	Malathion (premium grade)	8	EC	0.45 lb./1,000 sq. ft.	Mix EC or WP with water. Spray inside walls and floor of bin at rate of 2 gal./1,000 sq. ft. at least 2 weeks before grain is binned.	
	Methoxychlor	2	WP, EC	0.4 lb./1,000 sq. ft.		
	Pyrethrins + piperonyl butoxide	3 + 20	Oil soln.	0.013 - 0.13 lb./1,000 sq. ft.		

STORED-PRODUCT INSECTS

COMMODITY, STORAGE, AND INSECT	INSECTICIDE OR TREATMENT	TOLERANCE (p. p. m.)	FORMULATION	DOSAGE (active ingredient per 1,000 cu. ft. unless otherwise stated)	HOW, WHERE, AND WHEN TO APPLY	SAFETY RESTRICTIONS
GRAIN—Rice milled (con.) In cartons in fumigation chambers Saw-toothed grain beetle, flour beetles, Indian meal moth	Methyl bromide	125 (inorganic bromide)	F	1.25 oz./1,000 lb.	15 hr. at 70° F. or above in atmospheric chamber.	Fumigants should be applied only by a trained operator.
				1.75 lb.		
Mill equipment Saw-toothed grain beetle, flour beetles, Indian meal moth	Carbon tetrachloride + ethylene dichloride + ethylene dibromide (21:64: 15 mixture) Ethylene dibromide + methyl bromide (70:30 mixture) Ethylene dichloride + carbon tetrachloride (75:25 mixture)	125 (inorganic bromide) Others exempt	F	2 oz./1,000 lb.	2 hr. at 65° F. or above in vacuum chamber.	Aerate after fumigation with methyl bromide.
				4.25 lb.		
				1.5 oz./1,000 lb.	3 hr. at 65° F. or above in vacuum chamber.	
				3 lb.		
				1.25 oz./1,000 lb.	12 hr. at 65° F. or above in vacuum chamber.	
				2.5 lb.		
0.5 - 1.5 pt. in area to be treated.	Spot fumigation of machinery every 2 weeks.					

STORED-PRODUCT INSECTS

COMMODITY, STORAGE, AND INSECT	INSECTICIDE OR TREATMENT	TOLERANCE (p. p. m.)	FORMULATION	DOSAGE (active ingredient per 1,000 cu. ft. unless otherwise stated)	HOW, WHERE, AND WHEN TO APPLY	SAFETY RESTRICTIONS
GRAIN—Rice, milled (con.) In packages in the home Saw-toothed grain beetle, flour beetles, Indian meal moth	Freezing	--	--		Whenever infestation is suspected, hold in freezer at 0° F. for 4 days. Store in insect-proof containers such as glass jars.	Fumigants should be applied only by a trained operator.
	Heating	--	--		Whenever infestation is suspected, heat to 120° F. in oven. Hold for 0.5 hr. Store in insect-proof containers such as glass jars.	Aerate after fumigation.
GRAIN—Rice, rough In bags in warehouse Rice weevil, Angoumois grain moth, lesser grain borer, grain beetles	Methyl bromide	50 (inorganic bromide)	F	1.25 lb.	Expose for 16 - 24 hr.	Do not recirculate <u>aluminum phosphide</u> .
	Aluminum phosphide	0.1* (phosphine)	F		Place tablets or pellets on metal trays at each corner of stack under tarpaulin. Fumigate for 5 days at 54° - 59° F., 4 days at 60° - 68° F., or 3 days at 69° F. or above. Fumigate for 4 days at 54° - 59° F., 3 days at 60° - 68° F., or 2 days at 69° F. or above.	

\*The tolerance for phosphine on processed commodities is 0.01 p.p.m. and on raw products, 0.1 p.p.m.

STORED-PRODUCT INSECTS

COMMODITY, STORAGE, AND INSECT	INSECTICIDE OR TREATMENT	TOLERANCE (p. p. m.)	FORMULATION	DOSSAGE (active ingredient per 1,000 cu. ft. unless otherwise stated)	HOW, WHERE, AND WHEN TO APPLY	SAFETY RESTRICTIONS
GRAIN—Rice, rough (con.)	Methyl bromide	50 (inorganic bromide)	F	1.5 lb.	Expose for 24 hr. at 70° F. or above.	Fumigants should be applied only by a trained operator.
Calcium cyanide	25 (hydrogen cyanide)	F	12 lb./440 cwt.**	Mix into grain. Do not use in flat storage.	Do not recirculate <u>aluminum phosphide</u> .	
						Carbon tetrachloride + carbon disulfide (80:20 mixture)
Ethylene dichloride + carbon tetrachloride (75:25 mixture)	Exempt	F	4 - 5 gal./440 cwt.  3 gal./440 cwt.**	Gravity-distribution fumigation. At 75° F. or above.	Do not use <u>aluminum phosphide</u> on rice stored on the farm.	

\*The tolerance for phosphine on processed commodities is 0.01 p.p.m. and on raw products, 0.1 p.p.m.

\*\*Double the dosage if used in wooden bins.

STORED-PRODUCT INSECTS

COMMODITY, STORAGE, AND INSECT	INSECTICIDE OR TREATMENT	TOLERANCE (p. p. m.)	FORMULATION	DOSAGE (active ingredients per 1,000 cu. ft. unless otherwise stated)	HOW, WHERE, AND WHEN TO APPLY	SAFETY RESTRICTIONS
GRAIN—Rice, rough (con.)  In flat storage, concrete or metal upright bins, or farm-type metal bins Rice weevil, Angoumois grain moth, lesser grain borer, grain beetles	Malathion (premium grade)	8	EC	0.63 lb./440 cwt.	Treat as rice is being placed in storage.	Fumigants should be applied only by a trained operator.
	Pyrethrins + piperonyl butoxide	3 + 20	EC	0.2 + 2.0 lb./440 cwt.	Treat as rice is being placed in storage.	Aerate after fumigation with methyl bromide. Do not release aerosol near open flames.
	Methyl bromide	50 (inorganic bromide)	F	1.5 - 2 lb.	Forced-distribution fumigation in flat storage. Expose for 24 - 36 hours.	Aerosols may be used against exposed insects only.
In flat storage, concrete or metal upright bins, or farm-type metal bins Moths, surface infestation	Malathion (premium grade)	8	EC	0.02 lb./100 sq. ft. of surface area.	Surface spray will not control insects already established beneath surface.	
	Methyl bromide	50 (inorganic bromide)	F	1 lb.	Expose for 16 to 24 hr. at 60° F. or above. Dosage calculated for overhead space only.	
	Pyrethrins + piperonyl butoxide	3 + 20	Oil soln. % by wt. Pyrethrins 0.2 + piperonyl butoxide 2.0 + tetrachloroethylene 50.0 + deodorized kerosene 47.8	0.006 + 0.06 lb./1,000 cu. ft. of airspace over the load.	Apply with thermal aerosol generator.	
In freight cars Rice weevil, Angoumois grain moth, lesser grain borer, grain beetles	Methyl bromide	50 (inorganic bromide)	Pyrethrins 0.5 + piperonyl butoxide 5.0 + tetrachloroethylene 50.0 + deodorized kerosene 44.5	0.006 + 0.06 lb./1,000 cu. ft. of airspace over the load.	Apply with mechanical aerosol generator or as a mist spray.	Fumigants should be applied only by a trained operator.
			F	10 - 12 lb./car. 12 - 15 lb./car.	Bags or bulk in steel freight car. Bags or bulk in wooden freight car.	

STORED-PRODUCT INSECTS

COMMODITY, STORAGE, AND INSECT	INSECTICIDE OR TREATMENT	TOLERANCE (p. p. m.)	FORMULATION	DOSAGE (active ingredient per 1,000 cu. ft. unless otherwise stated)	HOW, WHERE, AND WHEN TO APPLY	SAFETY RESTRICTIONS
GRAIN—Rice, rough (con.) Storage bin Rice weevil, Angoumois grain moth, lesser grain borer, grain beetles	Malathion (premium grade)	8 on grain	EC	0.45 lb./1,000 sq. ft.	Mix with water. At least 2 - 4 weeks before grain is binned, spray inside walls and floor of bin at rate of 2 gal./1,000 sq. ft.	Aerate after fumigation with methyl bromide.
	Methoxychlor	2 on grain	WP, EC	0.4 lb./1,000 sq. ft.		
	Pyrethrins + piperonyl butoxide	3 + 20	Soln.	0.013 - 0.13 lb./1,000 sq. ft.	Mix with water and apply to walls and floor of empty storage at the rate of 2 gal./1,000 sq. ft.	
Control measures for insects in stored rye are the same as in GRAIN - Wheat, page 14.51.						
GRAIN—Sorghum In bags in warehouse Grain weevils, lesser grain borer, grain beetles, Angoumois grain moth, Indian meal moth	Aluminum phosphide	0.1* (phosphine)	F		In tarpaulin fumigation place tablets or pellets in trays at each corner of stack.	Fumigants should be applied only by a trained operator.
				45 tablets	Fumigate for 5 days at 54° - 59° F., 4 days at 60° - 68° F., or 3 days at 69° F. or above.	
				165 pellets	Fumigate for 4 days at 54° - 59° F., 3 days at 60° - 68° F., or 2 days at 69° F. or above.	
Methyl bromide	50 (inorganic bromide)	F	4 lb.	Space fumigation. 60° F. or above.	Fumigants should be applied only by a trained operator.	
			6 lb.	Space fumigation. Below 60° F.		

\*The tolerance for phosphine on processed commodities is 0.01 p.p.m. and on raw products, 0.1 p.p.m.

Issued October 1972

Use Pesticides Safely—Follow the Label

STORED PRODUCT INSECTS

COMMODITY, STORAGE, AND INSECT	INSECTICIDE OR TREATMENT	TOLERANCE (p. p. m.)	FORMULATION	DOSAGE (a. liter ingredient per 1,000 cu. ft. unless otherwise stated)	HOW, WHERE, AND WHEN TO APPLY	SAFETY RESTRICTIONS
GRAIN—Sorghum (con.)						
In bulk Moths, surface infestation	Chloropicrin	Exempt	F	1.5 lb./1,000 cu. ft. of space above grain.	Apply as fine spray or vapor into space over top of grain to control moths in surface layer. 70° F. or above.	Aerate after fumigation with <u>methyl bromide</u> . Repeated surface sprays with <u>malathion</u> will cause excessive residues.
				2 lb./1,000 cu. ft. of space above grain.	Apply as fine spray or vapor into space over top of grain to control moths in surface layer. Below 70° F.	
In bulk Grain weevils, lesser grain borer, grain beetles, Angoumois grain moth, Indian meal moth	Malathion (premium grade)	B	EC	0.63 lb./1,000 bu.	Mix with water 3 - 5 gal./1,000 bu. Spray on grain stream as it goes into storage.	Fumigants should be applied only by a trained operator. Do not recirculate <u>aluminum phosphide</u> . Do not apply calcium cyanide in wooden bins.
				0.32 lb./1,000 sq. ft. of surface area.	Surface spray. Will not control insects already established beneath the surface.	
In bulk, in concrete or metal elevator bins, 3,200-bu. metal bins, or farm-type metal bins Grain weevils, lesser grain borer, grain beetles, Angoumois grain moth, Indian meal moth	Aluminum phosphide	0.1* (phosphine)	F	0.6 lb./1,000 bu.	Mix dust into grain before storing.	
				3 tablets/ton or 90 tablets/1,000 bu.	Add to grain stream. Fumigate for 5 days at 54° - 59° F., 4 days at 60° - 68° F., or 3 days at 69° F. or above.	
				10 pellets/ton or 300 pellets/1,000 bu.	Add to grain stream. Fumigate for 4 days at 54° - 59° F., 3 days at 60° - 68° F., or 2 days at 69° F. or above.	
				15 - 20 lb./1,000 bu.	Mix into grain as it is being binned.	
	Calcium cyanide	25 (hydrogen cyanide)	F			

\*The tolerance for phosphine on processed commodities is 0.01 p.p.m. and on raw products, 0.1 p.p.m.



STORED-PRODUCT INSECTS

COMMODITY, STORAGE, AND INSECT	INSECTICIDE OR TREATMENT	TOLERANCE (p. p. m.)	FORMULATION	DOSAGE (active ingredient per 1,000 cu. ft. unless otherwise stated)	HOW, WHERE, AND WHEN TO APPLY	SAFETY RESTRICTIONS
<b>GRAIN—Sorghum (con.)</b> In bulk, in concrete or metal elevator bins, 3,200-bu. metal bins, or farm-type metal bins Grain weevils, lesser grain borer, grain beetles, Angoumois grain moth, Indian meal moth	Carbon tetrachloride + carbon disulfide (80:20 mixture)	Exempt	F	4 gal./1,000 bu.*	Gravity-distribution fumigation. Surface application or layering method. 60° F. or above.	
				2.25 gal.	Forced-distribution fumigation. Closed-recirculation or single-pass. 60° F. or above.	
				3.5 gal.	Forced-distribution fumigation. Closed-recirculation or single-pass. Below 60° F.	
	Chloroform + carbon disulfide + ethylene dibromide (71.25: 23.75: 5.0 mixture)	50 (inorganic bromide) Others exempt	F	3.5 gal./1,000 bu.*	Gravity-distribution fumigation. 70° F. or above.	Fumigants should be applied only by a trained operator.
	Chloropicrin	Exempt	F	4.5 gal./1,000 bu.*	Gravity-distribution fumigation. Below 70° F.	Aerate after fumigation.
				4 lb./1,000 bu.**	Gravity-distribution fumigation. 70° F. or above.	
				5 lb./1,000 bu.**	Gravity-distribution fumigation. Below 70° F.	
	Chloropicrin + methyl chloride (85: 15 mixture)	Exempt	F	4 lb.	Forced-distribution fumigation. Closed-recirculation or single-pass. 70° F. or above.	
				5 lb.	Forced-distribution fumigation. Closed-recirculation or single pass. Below 70° F.	
	Ethylene dibromide + ethylene dichloride + carbon tetrachloride (5: 35: 60 mixture)	50 (inorganic bromide) Others exempt	F	4 gal./1,000 bu.**	Gravity-distribution fumigation. Surface application or layering method. 70° F. or above.	

\*Double the dosage if used in wooden bin.  
 \*\*Double the dosage if used in wooden bin. Maximum chloropicrin dosage to be 6 lb./1,000 bu.

STORED-PRODUCT INSECTS

COMMODITY, STORAGE, AND INSECT	INSECTICIDE OR TREATMENT	TOLERANCE (p. p. m.)	FORMULATION	DOSAGE (active ingredient per 1,000 cu. ft. unless otherwise stated)	HOW, WHERE, AND WHEN TO APPLY	SAFETY RESTRICTIONS
GRAIN—Sorghum (cont.) In bulk, in concrete or metal elevator bins, 3,200-bu. metal bins, or farm-type metal bins Grain weevils, lesser grain borer, grain beetles, Angoumois grain moth, Indian meal moth	Ethylene dibromide + methyl bromide (70:30 mixture)	50 (inorganic bromide)	F	48 - 60 oz./1,000 bu.	Probe fumigant into hotspot.	
	Ethylene dichloride + carbon tetrachloride (75:25 mixture)	Exempt	F	5 gal./1,000 bu.*	Gravity-distribution fumigation. Surface application or layering method. 70° F. or above.	
	Ethylene dichloride + carbon tetrachloride (75:25 mixture)	Exempt	F	3.25 gal.	Forced-distribution fumigation. Closed-recirculation or single-pass. 70° F. or above.	Fumigants should be applied only by a trained operator.
In bulk, in concrete or metal bins Grain weevils, lesser grain borer, grain beetles, Angoumois grain moth, Indian meal moth	Methyl bromide	50 (inorganic bromide)	F	4.75 gal.	Forced-distribution fumigation. Closed-recirculation or single-pass. Below 70° F.	Aerate after fumigation.
				2.25 - 3 lb.	Forced-distribution fumigation. Closed-recirculation or single-pass. 60° F. or above.	
				4 lb.	Forced-distribution fumigation. Closed-recirculation or single-pass. Below 60° F.	
In bulk, in freight cars and van trucks Grain weevils, lesser grain borer, grain beetles, Angoumois grain moth, Indian meal moth	Chloropicrin	Exempt	F	3 lb.	Forced-distribution fumigation. Closed-recirculation or single-pass. 60° F. or above.	
				5 lb.	Forced-distribution fumigation. Closed-recirculation or single-pass. Below 60° F.	
In bulk, in freight cars and van trucks Grain weevils, lesser grain borer, grain beetles, Angoumois grain moth, Indian meal moth	Chloropicrin	Exempt	F	4 lb.	Recirculation fumigation. 70° F. or above.	
				6 lb.	Recirculation fumigation. Below 70° F.	

\*Double the dosage if used in wooden bins.

STORED-PRODUCT INSECTS

COMMODITY, STORAGE, AND INSECT	INSECTICIDE OR TREATMENT	TOLERANCE (p. p. m.)	FORMULATION	DOSEAGE (active ingredient per 1,000 cu. ft. unless otherwise stated)	HOW, WHERE, AND WHEN TO APPLY	SAFETY RESTRICTIONS
GRAIN—Sorghum (con.) In bulk, in freight cars and van trucks Grain weevils, lesser grain borer, grain beetles, Angoumois grain moth, Indian meal moth (con.)	Methyl bromide	50 (inorganic bromide)	F	4 lb. 6 lb.	Recirculation fumigation. 70° F. or above. Recirculation fumigation. Below 70° F.	Fumigants should be applied only by a trained operator. Aerate after fumigation.
	Ethylene dibromide + ethylene dichloride + carbon tetrachloride (5: 35: 60 mixture)	50 (inorganic bromide) Others exempt	F	7.25 gal./1,000 bu.	Apply from outside of car using hand or power sprayer.	
In flat storage Grain weevils, lesser grain borer, grain beetles, Angoumois grain moth, Indian meal moth	Aluminum phosphide	0.1* (phosphine)	F	3 tablets/ton or 90 tablets/1,000 bu.	Gravity-distribution fumigation. Fumigate for 5 days at 54° - 59° F., 4 days at 60° - 68° F., or 3 days at 69° F. or above.	Do not recirculate aluminum phosphide.
	Calcium cyanide	25 (hydrogen cyanide)	F	15 - 20 lb./1,000 bu.	Mix into grain as it is being placed in storage.	
	Carbon tetrachloride + carbon disulfide (80:20 mixture)	Exempt	F	6 gal./1,000 bu. 2.75 gal. 4 gal.	Gravity-distribution fumigation. 60° F. or above. Forced-distribution fumigation. Closed-recirculation or single-pass. 60° F. or above. Forced-distribution fumigation. Closed-recirculation or single-pass. Below 60° F.	

\*The tolerance for phosphine on processed commodities is 0.01 p.p.m. and on raw products, 0.1 p.p.m.

STORED-PRODUCT INSECTS

COMMODITY, STORAGE, AND INSECT	INSECTICIDE OR TREATMENT	TOLERANCE (p. p. m.)	FORMULATION	DOSAGE (active ingredient per 1,000 cu. ft. unless otherwise stated)	HOW, WHERE, AND WHEN TO APPLY	SAFETY RESTRICTIONS
GRAIN—Sorghum (con.)  In flat storage Grain weevils, lesser grain borer, grain beetles, Angoumois grain moth, Indian meal moth (con.)	Chloroform + carbon disulfide + ethylene dibromide <sup>a</sup> (71.25: 23.75: 5.0 mixture)	50 (inorganic bromide) Others exempt	F	5.5 gal./1,000 bu.	Gravity-distribution fumigation. 70° F. or above.	Fumigants should be applied only by a trained operator.  Aerate after fumigation.
				6.5 gal./1,000 bu.		
	Ethylene dibromide + ethylene dichloride + carbon tetrachloride (5:35:60 mixture)	50 (inorganic bromide) Others exempt	F	6 gal./1,000 bu.	Gravity-distribution fumigation. 70° F. or above.	
	Chloropicrin + methyl chloride (85:15 mixture)	Exempt	F	4 lb.	Forced-distribution fumigation. Closed-recirculation or single-pass. 70° F. or above.	
					5 lb.	
	Ethylene dibromide + methyl bromide (30:70 mixture)	50 (inorganic bromide)	F	2.25 - 3 lb.	Forced-distribution fumigation. Closed-recirculation or single-pass. 70° F. or above.	
					4 lb.	
Ethylene dibromide + methyl bromide (70:30 mixture)	50 (inorganic bromide)	F	48 oz./1,000 bu.	Probe fumigant into hotpot.		

STORED-PRODUCT INSECTS

COMMODITY, STORAGE, AND INSECT	INSECTICIDE OR TREATMENT	TOLERANCE (p. p. m.)	FORMULATION	DOSAGE (active ingredients per 1,000 cu. ft. unless otherwise stated)	HOW, WHERE, AND WHEN TO APPLY	SAFETY RESTRICTIONS	
GRAIN—Sorghum (con.) In flat storage Grain weevils, lesser grain borer, grain beetles, Angoumois grain moth, Indian meal moth (con.)	Ethylene dichloride + carbon tetrachloride (75:25 mixture)	Exempt	F	7.5 gal./1,000 bu.	Gravity-distribution fumigation. 70° F. or above.	Fumigants should be applied only by a trained operator.	
				3.75 gal.			Forced-distribution fumigation. Closed-recirculation or single-pass. 70° F. or above.
				5.25 gal.			Forced-distribution fumigation. Closed-recirculation or single-pass. Below 70° F.
Storage bin Grain weevils, lesser grain borer, grain beetles, Angoumois grain moth, Indian meal moth	Methyl bromide	50 (inorganic bromide)	F	4 lb.	Forced-distribution fumigation. Closed-recirculation or single-pass. 60° F. or above.	Aerate after fumigation.	
				5 lb.	Forced-distribution fumigation. Closed-recirculation or single-pass. Below 60° F.		
				0.45 lb./1,000 sq. ft.	Mix with water. At least 2 - 4 weeks before grain is binned, spray inside walls and floor of bin at rate of 2 gal./1,000 sq. ft.		
	Malathion (premium grade)	8 on grain	EC	0.4 lb./1,000 sq. ft.	Mix with water and apply to walls and floor of empty storage at the rate of 2 gal./1,000 sq. ft.		
				Methoxychlor	2 on grain	WP, EC	
	Pyrethrins + piperonyl butoxide	3 + 20	Soln.	0.013 - 0.13 lb./1,000 sq. ft.			

STORED-PRODUCT INSECTS

COMMODITY, STORAGE, AND INSECT	INSECTICIDE OR TREATMENT	TOLERANCE (p. p. m.)	FORMULATION	DOSAGE (active ingredients per 1,000 cu. ft. unless otherwise stated)	HOW, WHERE, AND WHEN TO APPLY	SAFETY RESTRICTIONS
GRAIN—Wheat and Rye	Methyl bromide	50 (Inorganic bromide)	F	2 lb.	Space fumigation. 60° F. or above.	Fumigants should be applied only by a trained operator.
				4 lb.	Space fumigation. Below 60° F.	
In bulk Grain weevils, lesser grain borer, grain beetles, Angoumois grain moth, Indian meal moth	Methion (premium grade)	8	EC	0.63 lb./1,000 bu.	Mix with water 3 - 5 gal./1,000 bu. Spray on grain stream as it goes into storage.	Do not release aerosol near an open flame. Aerate after fumigation with methyl bromide or chloropicrin.
				0.32 lb./1,000 sq. ft. of surface area.	Surface spray. Will not control insects already established beneath the surface.	
				0.6 lb./1,000 bu.	Mix dust into grain before storing.	
				0.06 + 0.6 lb./1,000 bu.	Mix with water, 3 - 5 gal./1,000 bu. Apply as protective spray to grain before it is stored.	
Moths, surface infestation	Chloropicrin	Exempt	F	0.06 + 0.83 lb./1,000 bu.	Mix dust into grain before storing.	
				1.5 lb./1,000 cu. ft. of space above grain.	Apply as fine spray or vapor into space over top of grain to control moths in surface layer. 70° F. or above.	
In bulk or in bags Flying insects	Pyrethrins + piperonyl butoxide	3 + 20	Oil soln. % by wt. Pyrethrins 0.2 + piperonyl butoxide 2.0 + tetrachloroethylene 50.0 + deodorized kerosene 47.8	2 lb./1,000 cu. ft. of space above grain.	Apply as fine spray or vapor into space over top of grain to control moths in surface layer. Below 70° F.	
				0.006 + 0.06 lb./1,000 cu. ft. of airspace.	Apply with thermal aerosol generator.	

Use Pesticides Safely—Follow the Label

STORED-PRODUCT INSECTS

COMMODITY, STORAGE, AND INSECT	INSECTICIDE OR TREATMENT	TOLERANCE (p. p. m.)	FORMULATION	DOSSAGE (active ingredient per 1,000 cu. ft. unless otherwise stated)	HOW, WHERE, AND WHEN TO APPLY	SAFETY RESTRICTIONS
GRAIN—Wheat and Rye (con.)  in bulk, in concrete or metal bins, farm-type metal bins, or large steel tanks Grain weevils, lesser grain borer, grain beetles, Angoumois grain moth, Indian meal moth	Aluminum phosphide	0.1* (phosphine)	F	3 tablets/ton or 90 tablets/1,000 bu.**	Add to grain stream. Fumigate for 5 days at 54° - 59° F., 4 days at 60° - 68° F., or 3 days at 69° F. or above.	Fumigants should be applied only by a trained operator.
				10 pellets/ton or 300 pellets/1,000 bu.	Add to grain stream. Fumigate for 4 days at 54° - 59° F., 3 days at 60° - 68° F., or 2 days at 69° F. or above.	
	Calcium cyanide	25 (hydrogen cyanide)	F	12 - 15 lb./1,000 bu. 20 lb./1,000 bu.	Mix into grain. Mix into grain. In 3,200-bu. metal bins.	Do not recirculate aluminum phosphide.
	Carbon tetrachloride + carbon disulfide (80:20 mixture)	Exempt	F	2.5 gal./1,000 bu.**	Gravity-distribution fumigation. 60° F. or above.	
				1.5 gal.**	Forced-distribution fumigation. Closed-recirculation or single-pass. 60° F. or above.	
				1.75 gal.**	Forced-distribution fumigation. Closed-recirculation or single-pass. Below 60° F.	
	Chloroform + carbon disulfide + ethylene dibromide (71.25: 23.75: 5.0 mixture)	50 (inorganic bromide) Others exempt	F	1.75 gal./1,000 bu.**	Gravity-distribution fumigation. 70° F. or above.	
				2.75 gal./1,000 bu.**	Gravity-distribution fumigation. Below 70° F.	

\*The tolerance for phosphine on processed commodities is 0.01 p.p.m. and on raw products 0.1 p.p.m.

\*\*Double the dosage if used in wooden bins.

STORED-PRODUCT INSECTS

COMMODITY, STORAGE, AND INSECT	INSECTICIDE OR TREATMENT	TOLERANCE (p. p. m.)	FORMULATION	DOSAGE (active ingredient per 1,000 cu. ft. unless otherwise stated)	HOW, WHERE, AND WHEN TO APPLY	SAFETY RESTRICTIONS
GRAIN—Wheat and Rye (con.)  In bulk, in concrete or metal bins, farm-type metal tanks or large steel tanks Grain weevils, lesser grain borer, grain beetles, Angoumois grain moth, Indian meal moth (con.)	Chloropicrin	Exempt	F	2 lb./1,000 bu.*	Gravity-distribution fumigation. 70° F. or above.	Fumigants should be applied only by a trained operator.  Do not fumigate with hydrogen cyanide (HCN) at temperatures below 60° F. Aerate for 24 hours after treatment.
				3 lb./1,000 bu.*	Gravity-distribution fumigation. Below 70° F.	
	Chloropicrin + methyl chloride (85:15 mixture)	Exempt	F	2 lb.	Forced-distribution fumigation. Closed-recirculation or single-pass. 70° F. or above.	
				3 lb.	Forced-distribution fumigation. Closed-recirculation or single-pass. Below 70° F.	
	Ethylene dibromide + ethylene dichloride + carbon tetrachloride (5:35:60 mixture)	50 (inorganic bromide) Others exempt	F	2.25 gal./1,000 bu.*	Gravity-distribution fumigation. Surfaces application or layering method. 70° F. or above.	
					3 gal./1,000 bu.*	
Ethylene dichloride + carbon tetrachloride (75:25 mixture)	Exempt	F	1.75 gal.	Forced-distribution fumigation. Closed-recirculation or single-pass. 70° F. or above.		
				2.75 gal.		Forced-distribution fumigation. Closed-recirculation or single-pass. Below 70° F.

\*Double the dosage if used in wooden bins.



STORED-PRODUCT INSECTS

COMMODITY, STORAGE, AND INSECT	INSECTICIDE OR TREATMENT	TOLERANCE (p. p. m.)	FORMULATION	DOSAGE (active ingredient per 1,000 cu. ft. unless otherwise stated)	HOW, WHERE, AND WHEN TO APPLY	SAFETY RESTRICTIONS
GRAIN—Wheat and Rye (con.)  In bulk, in concrete or metal bins, farm-type metal bins, or large steel tanks Grain weevils, lesser grain borer, grain beetles, Angoumois grain moth, Indian meal moth (con.)	Methyl bromide	50 (inorganic bromide)	F	2 lb.	Forced-distribution fumigation. Closed-recirculation or single-pass. 60° F. or above.	Fumigants should be applied only by a trained operator.
				3 lb.	Forced-distribution fumigation. Closed-recirculation or single-pass. Below 60° F.	
	Ethylene dibromide + methyl bromide (30:70 mixture)	50 (inorganic bromide)	F	1.5 lb.	Forced-distribution fumigation. 70° F. or above.	Aerate after fumigation.
				2.5 lb.	Forced-distribution fumigation. Below 70° F.	
	Ethylene dibromide + methyl bromide (70:30 mixture)	50 (inorganic bromide)	F	30 - 38 oz./1,000 bu.	Probe fumigant into hotspot.	
				3 tablets/ton or 90 tablets/1,000 bu.	Fumigate for 5 days at 54° - 59° F., 4 days at 60° - 68° F., or 3 days at 69° F. or above.	
	Aluminum phosphide	0.1	F	2 lb.	Recirculation fumigation. 70° F. or above.	Do not recirculate aluminum phosphide.
				3 lb.	Recirculation fumigation. Below 70° F.	

STORED-PRODUCT INSECTS

COMMODITY, STORAGE, AND INSECT	INSECTICIDE OR TREATMENT	TOLERANCE (p. p. m.)	FORMULATION	DOSAGE (active ingredient per 1,000 cu. ft. unless otherwise stated)	HOW, WHERE, AND WHEN TO APPLY	SAFETY RESTRICTIONS
GRAIN—Wheat and Rye (con.)	Methyl bromide	50 (inorganic bromide)	F	2 lb.	Recirculation fumigation. 70° F. or above.	Fumigants should be applied only by a trained operator.
				3 lb.	Recirculation fumigation. Below 70° F.	
In elevator machinery Grain weevils, lesser grain borer, grain beetles, Angoumois grain moth, Indian meal moth (con.)	Ethylene dibromide + ethylene dichloride + carbon tetrachloride (5: 35: 50 mixture)	50 (inorganic bromide) Others exempt	F	5 gal./1,000 bu.	Apply from outside of car using hand or power sprayer.	Do not recirculate aluminum phosphide.
				1.5 - 2 oz./boot or leg.	Apply as often as necessary to prevent infestation from becoming established.	
In elevator tunnels, gallery floor, and headhouse Grain weevils, lesser grain borer, grain beetles, Angoumois grain moth, Indian meal moth	Methoxychlor	2	EC or WP	0.4 lb./1,000 sq. ft.	Apply as residual spray about 3 times during the summer. Clean area thoroughly before spraying.	
				0.013 - 0.13 lb./1,000 sq. ft.		
				4 oz./ft. in screw conveyors.		
In flat storage Grain weevils, lesser grain borer, grain beetles, Angoumois grain moth, Indian meal moth	Aluminum phosphide	0.1* (phosphine)	F	3 tablets/ton or 90 tablets/1,000 bu.	Place tablets in grain mass. Fumigate for	Mix into grain.
				15 - 20 lb./1,000 bu.	5 days at 54° - 59° F., 4 days at 60° - 68° F., or 3 days at 68° F. or above.	
	Calcium cyanide	25 (hydrogen cyanide)	F			

\*The tolerance for phosphine on processed commodities is 0.01 p.p.m. and on raw products, 0.1 p.p.m.

STORED-PRODUCT INSECTS

COMMODITY, STORAGE, AND INSECT	INSECTICIDE OR TREATMENT	TOLERANCE (p. p. r.)	FORMULATION	DOSAGE (active ingredient per 1,000 cu. ft. unless otherwise stated)	HOW, WHERE, AND WHEN TO APPLY	SAFETY RESTRICTIONS
GRAIN—Wheat and Rye (con.)  In flat storage Grain weevils, lesser grain borer, grain beetles, Angoumois grain moth, Indian meal moth (con.)	Carbon tetrachloride + carbon disulfide (80:20 mixture)	Exempt	F	4 gal./1,000 bu.  1.75 gal.  2 gal.	Gravity-distribution fumigation. 60° F. or above.  Forced-distribution fumigation. 60° F. or above.  Forced-distribution fumigation. Below 60° F.	Fumigants should be applied only by a trained operator.
	Chloroform + carbon disulfide + ethylene dibromide (71.25: 23.75: 5.0 mixture)	50 (inorganic bromide) Others exempt	F	3.25 gal./1,000 bu.  3.75 gal./1,000 bu.	Gravity-distribution fumigation. 70° F. or above.  Gravity-distribution fumigation. Below 70° F.	
	Chloropicrin + methyl chloride (85:15 mixture)	Exempt	F	2 lb.  3 lb.	Forced-distribution fumigation. 70° F. or above.  Forced-distribution fumigation. Below 70° F.	
	Ethylene dibromide + ethylene dichloride + carbon tetrachloride (5: 35: 60 mixture)	50 (inorganic bromide) Others exempt	F	3.75 gal./1,000 bu.	Gravity-distribution fumigation. 70° F. or above.	
	Ethylene dibromide + methyl bromide (30:70 mixture)	50 (inorganic bromide)	F	1.125 - 1.5 lb.  2 - 3 lb.	Forced-distribution fumigation. 70° F. or above.  Forced-distribution fumigation. Below 70° F.	
	Ethylene dibromide + methyl bromide (70:30 mixture)	50 (inorganic bromide)	F	30 - 36 oz./1,000 bu.	Probe fumigant into hotspot.	Aerate after fumigation.

STORED-PRODUCT INSECTS

COMMODITY, STORAGE, AND INSECT	INSECTICIDE OR TREATMENT	TOLERANCE (p. p. m.)	FORMULATION	DOSAGE (active ingredient per 1,000 cu. ft. unless otherwise stated)	HOW, WHERE, AND WHEN TO APPLY	SAFETY RESTRICTIONS
GRAIN—Wheat and Rye (con.)	Ethylene dichloride + carbon tetrachloride (78:25 mixture)	Exempt	F	4.5 gal./1,000 bu. 2 gal. 3 gal.	Gravity-distribution fumigation. 70° F. or above. Forced-distribution fumigation. 70° F. or above. Forced-distribution fumigation. Below 70° F.	Fumigants should be applied only by a trained operator.
In flat storage Grain weevils, lesser grain borer, grain beetles, Angoumois grain moth, Indian meal moth (con.)	Methyl bromide	50 (inorganic bromide)	F	2 lb. 3 lb.	Forced-distribution fumigation. Recirculation or single-pass. 60° F. or above. Forced-distribution fumigation. Recirculation or single-pass. Below 60° F.	Aerate after fumigation.
Storage bin or ship's hold Grain weevils, lesser grain borer, grain beetles, Angoumois grain moth, Indian meal moth	Malathion (premium grade)	8 on grain	EC	0.45 lb./1,000 sq. ft.	Mix with water. At least 2 - 4 weeks before grain is binned, spray inside walls and floor of bin at rate of 2 gal./1,000 sq. ft.	
	Methoxychlor	2 on grain	WP, EC	0.4 lb./1,000 sq. ft.		
	Pyrethrins + piperonyl butoxide	3 + 20	Soln.	0.013 - 0.13 lb./1,000 sq. ft.	Mix with water and apply to walls and floor of empty storage at the rate of 2 gal./1,000 sq. ft.	
GUMS In storage Saw-toothed and flat grain beetles, flour beetles, cigarette beetle, <i>Trogoderma</i> sp., Indian meal moth	Propylene oxide	300 (propylene oxide)	F		Follow manufacturer's directions on label.	Fumigants should be applied only by a trained operator.

## Appendix D

The following article is extracted from a manual prepared for VITA by Joseph H. Boatwright, Sr. It is included here because, in many parts of the world, soil is used for construction. A farmer may not be able to buy tar or asphalt to use for waterproofing his silo. But he can look around and see what is available locally for making his silo waterproof. He can try these methods on an underground storage pit or on his home. You may find some interesting ideas to pass on from this material.

## WATERPROOFING SOIL CONSTRUCTION

BY

Joseph H. Boatwright, Sr.

### PREFACE

This manual is concerned with the methods of waterproofing all types of soil construction. It shows how to make use of all forms of local vegetation to produce gums, resins, and oils that can be used as waterproofing agents. Very few tools are necessary, and they can be made from local materials.

The plants which contain these gums, resins, and oils are different from one part of the world to another. So no effort is made to identify the various plants; some of the more common ones are given as examples of what one might expect to find and use.

One part of this material is devoted to the method of getting out the gums, resins, and oils; the other part talks about making necessary equipment from local materials. All measurements are given in terms of the height of a man, the width of a man's hand, the length of a finger, etc; there is no need to use rulers or tape measures.

### TREES

Trees are a good source of waterproofing material. The first and best place to look is the sap of the tree.

Many trees will not have a free flowing sap; many will not have a useful sap. All kinds of trees in the neighborhood must be tested. To test a tree -- cut through the bark to the wood with a knife, leaving a bare

place on the wood about the width of one finger and as long as a man's hand. This cut should slant downward, so any sap that drains will flow toward the lower end. At the bottom of the lower end, place a cup to collect any liquid that flows. These cups can be made from gourds, coconuts, or a section of bamboo stalk. See Figure 1. below showing how this should be done.

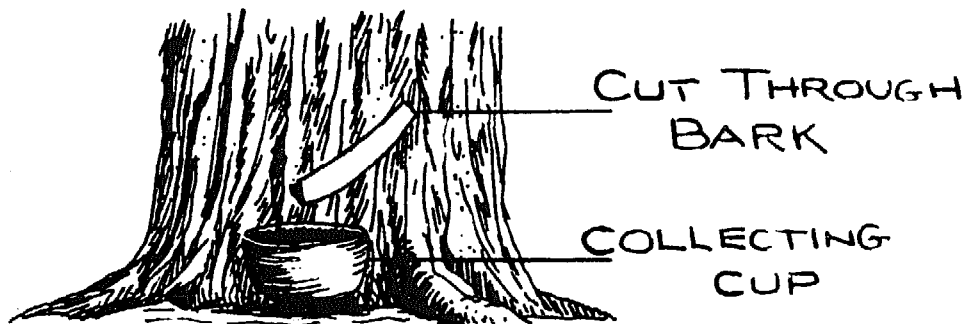

Figure 1.

### Testing the Sap

Watch this cut for several days to see if any sap flows. If it does not, no other trees of this type should be tapped. If the sap does flow, collect a cupful. Test the sap to see if it will waterproof mud or soil walls. To do this, brush or wipe the sap on the walls; be careful to soak all of the wall in the test area. It is better to have too much sap on the wall than not enough. Allow the sap to remain for two or three days - it may, or may not, dry. Then throw water on the test area. If the color of the wall darkens, it indicates that the water has wet the mud or soil, and the sap did not waterproof the wall. If the color of the wall does not change, then this sap is a good waterproofing agent.

### Collecting the Sap

Be sure to remember which kind of tree supplied this sap. All trees of this same type should be tapped for their sap. Search for these trees. Tap every one of them just like the first tree. If there are not enough trees of this kind in the neighborhood, then test other kinds of trees for their sap. Test the sap in the same manner as before. Collect the sap from each tree every few days, and store it in a larger container - this container may be a bucket, skin, or a large section of bamboo. When a large amount of sap has been collected, waterproof another section of your home. Continue the process until the entire building has been waterproofed. Then waterproof the inside just like you did the outside.

### Test Fruits for Oil

If none of the trees in the neighborhood give sap, try the fruit of the tree - berries, nuts, seeds, or fruit. Allow the fruit to ripen on the tree. Then pick it. Place it in the sun so that it dries completely. Then the seeds may be picked out easily. Collect enough seeds to make a pile at least as high as a man's knee. Several piles this high will have to be collected to produce enough oil. The seeds should be crushed. Do this by placing them on a large, flat rock, and mash them with a smaller stone. Crush them thoroughly, deposit them in a cloth bag, and place the bag in a large pot. Add water to the pot until it covers the bag, and then place the pot on a fire. Heat until the water comes to a boil. If oil comes to the surface of the water, skim it off and collect it in another container. Continue cooking the seeds until no more oil comes to the surface. At this point take the pot off the fire, drain off all the water, and put the bag in a press. See Figure 2.

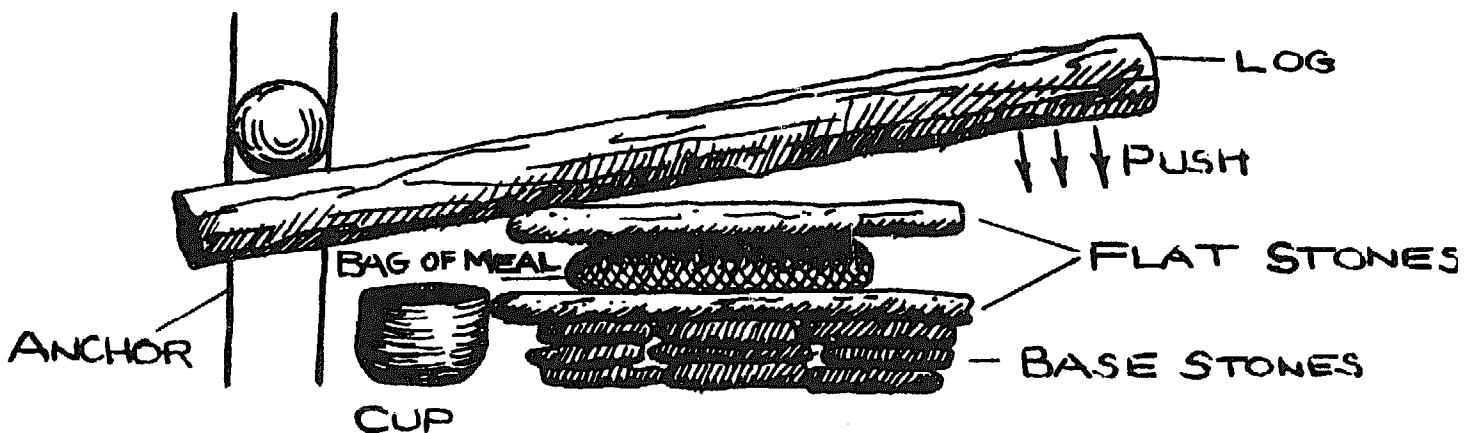

Figure 2.

Oil and water will come out of the seeds. Separate the oil from the water, and save it with the other oil you have collected. Continue pressing until no more oil comes out. Since this is a rather involved operation, it is not a one-man job.

### Test the Nuts

If the tree has nuts instead of berries or seeds, the hulls must be removed before the nuts can be crushed. Save the hulls separately, as they may contain a resin or oil. Crush the nuts, and express the oil from them as outlined above.

Test the hulls of the nuts to see if they have any oils or resins. Place the hulls on a sheet of metal, or in a metal can, and put it on a small fire of hot coals, no flame. If the hulls contain oil or resin, it will flow out onto the metal. Do NOT let the metal get red hot, because the resin or oil will be burned. Any resin or oil should be collected



and added to the oil already saved. The resin or oil from the hulls usually has a very high melting point, so it will turn solid when cooled, and cannot be applied. It must be mixed with other oils with a lower melting point. Hulls that produce no resin or oil may be thrown away.

### Test the Leaves

Some trees produce a gum, and deposit it on their leaves. To see if the leaves have a usable gum:

- . Dry the leaves.
- . Cook them on metal as above.
- . If a gum flows out on the metal sheet, save it and mix it with your oil.
- . These gums also must be mixed with oil, or they cannot be used.

Bamboo, and possibly other grasses with tough stalks, contains a resin dispersed throughout the fibers of the stalk. To collect this resin:

- . Dry the bamboo in the sun until it is brown.
- . Crush the dried bamboo with rocks until it is broken up into small fibers.
- . Place the fibers on a metal sheet, and spread them out so that they form a thin layer.
- . Place the metal sheet over glowing coals.
- . Heat until the resin flows out on the metal.
- . Collect the resin as it drips off the sheet, and immediately mix it with oil. One warning: if too much resin (from the bamboo or other plants) is mixed with oil, the oil mixture will begin to harden as it cools. If this happens, add more oil until the mixture stops hardening as it cools.

### Coconut Palms

Coconut palms may be treated separately, since they are a fairly common tree in many parts of the world. The trees will yield no sap or gum, but an excellent oil can be obtained from the coconut itself:

- . Remove the husk from the ripened coconut.
- . Break the nut open.
- . Drain the milk.
- . Remove the meat from the shell after it has been dried.
- . Cook the meat as soon as a sufficient quantity has been gathered from the dried shells. Cooking alone may yield sufficient oil; pressing may be tried after cooking, but only if a significant amount of oil can be obtained.

By-products from each of the above should not be discarded, but saved and used to the best advantage. The meal from the seeds, berries, nuts,

etc. is rich in protein and can be used as a food supplement. There is the danger that some seeds, such as the bastor bean, can be harmful to human beings. Therefore, it is wisest to use the meal from trees as fodder for cattle, hogs, etc. Only the meal obtained from grain and grasses is completely safe for human beings. If excess oil is produced, it may be used in lamps or made into soap, as described later. Coconut shells are most useful as cups, dishes, lamps, containers, etc. The residue from cooking bamboo, nut hulls, etc. may be used as a form of charcoal for almost flameless fires.

## BUSHES

Bushes may be treated in the same manner as trees, except that there is little reason to try extracting the sap from them since the stalk of most is so small it is impractical to tap them. However, they do produce berries and nuts that may be dried, crushed, and pressed as described earlier in TREES. Many bushes produce an edible fruit which should be eaten first, and the seeds saved and dried for crushing and pressing.

## VINES

Most vines produce berries, some of which are edible. The seeds, in either case, may be crushed for oil, just as shown earlier in this manual. There are other vines from which the sap will flow quite readily. In this case, the vines are simply skinned, or cut, on one side, and the sap will begin to flow out. This sap, like that of the trees, will have to be tested. Since the sap from some vines is as thin as water, it cannot be used just as it comes from the vine. A sap such as this will have to be cooked over a low flame first to try to thicken it. If cooking does not thicken the sap, throw it away, and do not use that vine again. If cooking does thicken the sap, apply the thick sap to the walls of a house, and test it as was done with the sap from trees. If the thick sap acts as a waterproofing agent, tap as many vines of this type as can be found. After a large quantity of sap has been collected, cook all of it at once, and then use it as a waterproofing agent.

## GRASSES

All grasses produce seeds of one kind or another, but most are much smaller than those found on other types of plant life. While it may seem

impractical to bother with grasses, this is the largest source of vegetable oil for many people today.

The seeds should not be gathered until the grass has turned brown; then the seeds will be easy to remove by holding the stalk between the thumb and index finger. Draw the stalk through the two fingers, and the seeds will fall off in the hand. Collect as many seeds as possible, since each seed yields only a very, very small amount of oil. Crush the seeds as discussed before. Cook and press them. If enough seeds are used, a large quantity of oil can be obtained. This oil may be used as is without testing, since it is well known that such oils are excellent waterproofing agents.

It must be added here that the oil, the meal, and the whole seed itself are highly nutritious. If the village is lacking in food, forget about waterproofing, and use all the edible seeds for food purposes. If the people have adequate food, then the seeds may be crushed, and the meal fed to any domesticated animals on hand: cattle, horses, hogs, sheep, or similar animals. Under no circumstances should excess seeds, oil, or meal be discarded; it should be used as food.

## OTHER PLANTS

Plants which do not fall into the category of trees, bushes, vines, or grasses still produce seeds of one kind or another. We suggest that all seeds be picked regardless of their origin, and cooked and pressed to see if they contain oil in sufficient quantity to be useful. If the oil yield is large enough, gather all the seeds of that type, and use them as a source of oil.

## EQUIPMENT

One of the first pieces of equipment needed will be a brush. Bristles for a brush can be vegetable fibers, hairs from a horse's tail, or hair from the tail of any animal, if the hairs are long enough, stiff enough, and straight enough. The hairs should be fairly stiff (about as stiff as those from horse's tail or mane, or those from hogs), straight, and as long as from the tip of the middle finger to the wrist. The handle can be any kind of hardwood; a piece of bamboo is excellent. To make a brush:

- . Choose a piece of hardwood about as big around as the little finger, and twice as long as the bristles.

- . Grasp a small bundle of bristles within a circle made by the thumb and forefinger.
- . Insert the handle in the middle of this bundle of bristles so that one half the length of the bristles is along the handle, and the other half is loose.
- . Tie the bristles around the handle with a leather thong, vegetable fiber, or any strong cord.
- . Tie once at the end of the handle, then once at the end of the bristles, then tie once between these two. Be sure to tie as tight as possible, so the bristles will not come loose. It is better that two men make the brushes because one man will find it difficult to hold the bristles and tie at the same time.
- . Trim the bristles at the loose end, so that all of them are the same length from the handle. See Figure 3 below.

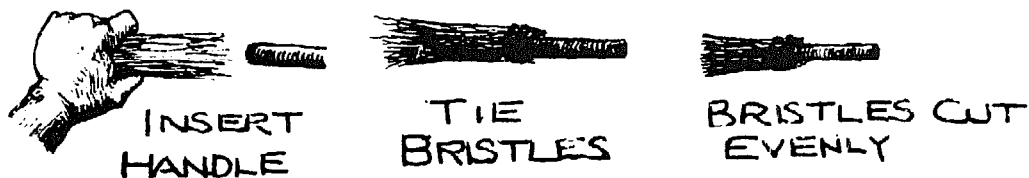

Figure 3.

The next piece of equipment needed is a cup for collecting the sap as it drains from the tree or vine. Any hollow object can be used with ease. We mentioned earlier that gourds, coconut shells, or sections of bamboo stalks may be used. Figure 4 below shows how these will appear.

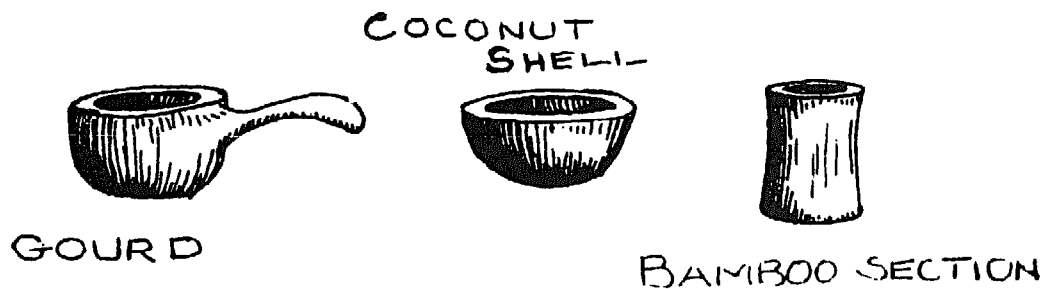

Figure 4.

Cook the meal in bags made of any coarse fiber or cloth. Their size is immaterial; the only requirement is that they are not wider or longer than the stones in the press (they should be somewhat smaller). See Figure 2. They may be made in a square or round shape, and made to contain as much meal as may be cooked at one time. The cloth should be strong enough to withstand the pressure of the press. If the cloth is not strong, the bags will burst, and the meal will spill out.

### BUILDING PRESSES

Two types of presses may be constructed: one is shown in Figure 2., and will be described below. The other, the Chinese wedge press, will be described and illustrated.

A small stone base, about ankle high, will support the flat bottom stone of the press. The bottom stone of the press should be slanted so the oil flowing onto it drains toward one end into the container placed there. A flat stone about the same size as the bottom stone is the top stone of the press. A log about as long as the height of two men and as thick as a man's thigh is the lever for the press. This log will have to be very strong to support the weight of five or six heavy men. One end of this log is anchored as close as possible to the stone base, and to the ground very securely, so it will not rise when the men press on the other end. To use the press, place the bottom stone on the base, and the collecting cup at one end. Place the bag of meal on the bottom stone, and the flat top stone on top of the bag. Next, place the long, heavy log on the top stone, with one end anchored securely. When all of the equipment and log are in place, about five or six heavy, strong men should press down on the free end of the log, applying all of their weight to the log at once to exert as much pressure as possible. As they press, oil and water will be expressed from the meal. The mixture will run down the bottom stone, and be collected in the cup. Continue pressing until all the meal has been pressed, and all the oil collected. After the mixture has been standing a while, the oil will float on top of the water. Scoop off the oil, and discard the water. This process may be repeated until enough oil has been prepared for the entire village.

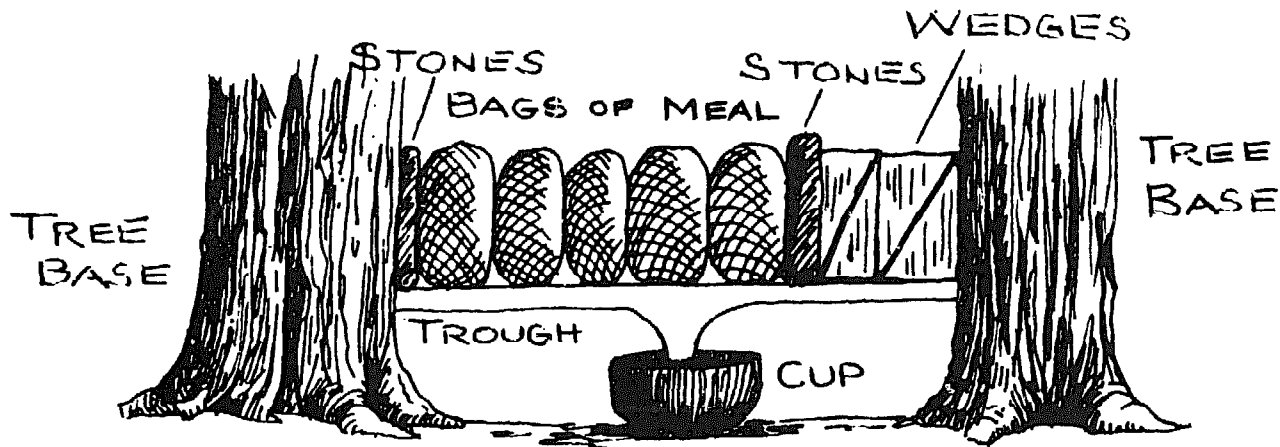

Figure 5.

### Chinese Wedge Press

Obviously, from the appearance of the press, it will require tools for both its construction and operation. If the tools are available, or can be constructed, this press is far more efficient than that shown in Figure 2. If tools, such as saws, axes, mallets, and an ample supply of cloth (for the bags) are available, we suggest that the wedge press be used.

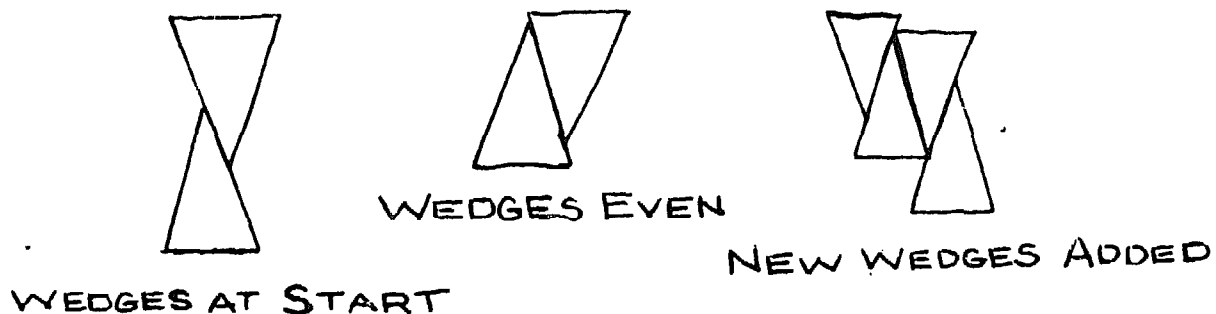

Figure 6.

Trees are the end braces since they are sturdy. If two closely placed trees are not available, two strong logs may be used in their place: each log should be as thick as the thigh of a man, and should be two-thirds as tall as a man. Each log should be buried upright in the ground one-half of its length. Then each log should have an angle brace (see Figure 7) on the outside; the press will be placed between the logs.



Figure 7.

Any number of bags may be placed in the press at the same time, as the force exerted by the wedges will be distributed equally throughout. Place the first two wedges in the press, and then add enough bags to fill the press tightly. The bags should have flat stones larger than the bags placed at each end so that neither the tree or wedge will press unevenly into the end bags. The bags may be of the same general size and shape as those used in the other press. The base trough may be made of wood or stone, as long as its shape permits the oil to flow into a container. The drain may be in the center, or at either end. The wedges should be started as shown in the diagram in Figure 5. The wedges are to be placed horizontally so that they may be driven from the sides. As the wedges are driven in, new wedges can be added to increase the pressure. (The meal will be compacted as the pressure is increased, and more wedges will be needed to maintain the pressure). The wedges may be made of nearly any kind of wood, but hardwood is preferable. The wedge should be as long as a man's arm from his wrist to his elbow, and as wide as the meal bag. The wedge should have a fairly fine edge at one end, and be as thick as the breadth of a man's hand at the other end. The wedges should be driven with a wooden mallet, which can be made very easily (See Figure 8).



Figure 8.

Cut a log as thick as a man's thigh and as long as a man's foot. In the center and in one side, a hole should be drilled (burnt, carved, etc.) All the way through the log. The diameter of the hole should be the width of two fingers. Insert the handle (which is made of very tough wood) into this hole. The handle should be about as long as a man's arm. Drive it into the hole as deeply as possible, and so tightly that two men cannot pull them apart. When the handle is tight, the mallet is ready to use.

When all the oil and water have been pressed from the meal, take out the old bags and add a new lot. The operation can be repeated until all the cooked meal has been pressed.

One further note: when driving the wedges, one man should drive the wedge on one side, while another man drives the wedge on the other side. They should strike their blows at the same time. If this is not done, it is possible that the bags and wedges will buckle, and everything will be pushed out of the press.

## PAINTING

Before painting, brush off all loose dirt, trash, vines, vegetable growth, etc. The soil should be as firm as possible for best results. It is also important to paint only in dry weather.

In painting soil construction with sap, oil, etc. make sure to cover the surface completely. Fill the brush before each stroke. The strokes should be made horizontally. Start painting at the top of the wall, and work toward the bottom. If any of the sap or oil runs down the wall, brush it out as you work down the wall. It is easy to tell if any areas have been left unpainted because these waterproofing agents will darken the soil. It is much wiser to apply too much agent to the wall than not enough: one small unpainted area can absorb enough water to ruin the rest of the wall. These agents also may be used on wood framing, windows, etc.

If the soil, or wood, is wet or even damp, the waterproofing agent will not stick well and will not protect the walls.

While the resins in sap and gums will dry to a fairly hard film, the oils will usually not dry at all. But they still make the building very waterproof. In fact these oils will be effective waterproofing agents for a longer period of time.

The easiest way to find out if the walls need repainting is to throw water on them. If the walls darken in color (from absorption of water by the soil), they need repainting. If they remain essentially unchanged



in color, the waterproofing agent is still effective. If repainting is needed, add a new coat of waterproofing agent. It does not matter which type of agent has been applied first, nor does it matter which type is used for the second or even the third coat. Any type may be applied over the other with good results. On the average, these waterproofing agents should last from one to two years, depending upon the weather, etc.

#### GENERAL

The classification of gums, resins, and oils is very general. The gums occur as solids as described earlier; the resins, while mentioned, are not identified - they are a component of the sap, and remain as a solid substance when the sap dries. The oils are found in virtually all seeds and nuts regardless of their source.

It is impossible for us to identify the various trees, bushes, vines, grasses, etc. that will provide the various types of waterproofing agents. The selection of these will have to be entirely on a trial and error method. Saps from several different types of trees often can be mixed together, but this too will have to be on a trial and error basis. The gums can be mixed with each other, occasionally with the oils, but seldom with the saps. All oils can be intermixed; in fact, the seeds and nuts themselves can be mixed together prior to crushing, and then cooked and pressed together. Sometimes oils can be mixed with saps, but this will have to be done on a trial and error basis.

While it is easy enough to construct new brushes, it is also very easy to keep the original brushes in good condition. Since water will not clean these brushes, there is no point in trying to wash them. The best solution is to saturate each brush with oil, and then place it in a container of water. Cover the container so the water cannot evaporate. The oil will prevent the resins and gums from hardening, and the water will stop the oil from drying.

## Appendix E

### WORKING PAPER ON THE VOLUNTEER ROLE IN GRAIN STORAGE

The following working paper was originally presented at a regional grain storage seminar held in Cotonou, Benin, West Africa, in 1974. The seminar was sponsored by the International Secretariat of Voluntary Services, the UN Food and Agriculture Organization, and the U.S. Agency for International Development.

The seminar's purpose was to encourage the initiation of farmer-oriented storage extension programs through the sharing of practical information and field experiences. It was attended by over 100 participants from nineteen countries in Africa, Europe, and North America. A handbook/report was published, by the German Agency for Technical Cooperation Ltd., which includes all working papers, discussions (summarized), and construction plans for various silo and dryer models reviewed during the seminar. Several of the modified plans presented in this manual are included in the seminar report. It is available from the seminar secretary, Mr. David Dichter. His address is: David Dichter and Associates, Development Assistance Programmes, 9 rue de Vermont, 1202 Geneva, Switzerland.

WEST AFRICAN SEMINAR ON THE VOLUNTEER ROLE IN FARM  
AND VILLAGE-LEVEL GRAIN STORAGE

DECEMBER 13-23, 1974

COTONOU, DAHOMEY

WORKING PAPER No . 1

PROBLEMS RELATED TO POPULARIZING NEW FARM-LEVEL  
GRAIN STORAGE TECHNOLOGY

Carl Linblad  
Mark Newman  
Roger Vinita  
United States Peace Corps  
Volunteers to Dahomey (Benin)

Attached to the

Agriculture Service  
Ministry of Rural Development  
and Cooperative Action

## INTRODUCTION

Since 1967, the Agriculture Service of Dahomey and the United States Peace Corps have collaborated in creating, implementing and evolving a farm-level grain storage program in southern Dahomey. One result of this joint program is the actual construction of over two hundred and fifty individual storage units. Another result is seven years of cumulative experience in working through some of the practical day-to-day problems of popularizing new farm-level grain storage technology. This shared experience by two organizations, one a governmental agency and the other an international volunteer agency, forms the basis for this paper.

The authors see the primary purpose of this paper as a presentation of some of the major considerations in the planning and establishment of a farm-level grain storage program. Of secondary importance is a brief history, attached as an appendix, of the collaboration of the Agriculture Service and the Peace Corps in evolving the program.

While the authors' program is limited to Dahomey and primarily one type of storage facility; it is hoped that their practical experience will be of benefit to others initiating similar programs, regardless of the storage method adopted. The paper is not an instruction manual nor a "how-to-do-it" guide to popularizing new techniques in grain storage. Rather, it is a brief discussion, with specific examples based on the author's experience of five major areas of concern in planning a new grain storage project:

1. Assessment of the problem
2. Choice of the improved method to popularize
3. Financial considerations
4. Stimulating interest in improved storage methods
5. The extension and integration of the project into the local infrastructure.

---

1 See "Construction Manual for the 4.5 Ton and 2.5 Ton Cement Silo and the Mud Walled Grain Dryer" by U. S. Peace Corps Volunteers, October 27, 1974.

## Part I. Assessment of the Problem

The initial phase in the planning of a project to improve grain storage technology is an analysis of the problem from the point of view of the farmer in the particular locality to be served. He is the key ingredient. Any program must be based upon realities as seen by the farmer who will be storing his grain.

In Dahomey, the traditional corn-growing farmer lives in a small village and annually cultivates up to 3 hectares (7 - 1/2 acres) by hand. His annual yield with two growing seasons could be estimated at 600-800 kg/hectare or a total of 1,800-2,400 kg. This is classic subsistence farming, probably not unlike that of most corn-growing farmers in the developing world.

Traditional storage methods. Initially in the consideration, choice and planning of an improved storage program it is advisable to analyze local traditional methods in order to (1) understand their shortcomings and therefore the need for improved techniques and (2) investigate for possible simple, yet effective, improvements. Certainly, minor and effective changes to existing methods of storage are easier to popularize than the introduction of complex and costly alternatives. For example, perhaps improved sealing of traditional granaries or a broad-based program of insecticide treatment could have significant immediate effects.

At any rate, the important point is to think about the traditional methods of storage from the farmer's viewpoint. Does he find that the traditional methods are inefficient? Does the rapid rate of insect multiplication make it impossible to store grain over a long period of time with his traditional method? Do mold growth and rotting present problems? What about rodents and birds? How much grain does he actually lose with his traditional methods of storage?

Market Price Realities. As a practical matter, farmers will not be inclined to change their traditional storage methods unless there will be sufficient financial returns from whatever additional labor, time or cash inputs are required by the improved storage techniques. Therefore, the economics of the improved techniques as affecting subsistence farmers must be carefully studied.

Local market price information is needed. What are the prices of grain at harvest time and at the yearly high? Also, does the farmer have large financial demands at harvest time? What are his spending habits? Does he normally have to sell his grain before prices have started to reach their seasonal high? How much fluctuation is there in the price on the local market? Are there other more lucrative markets he can reach easily? Is transportation of his crops to the market expensive or impractical?

There are other economic and market factors to consider. For example, traditionally, grain in Dahomey is sold in markets by volume rather than by weight. This could work against the adoption of improved storage methods. The improved quality of well-stored grain, for instance, could bring few benefits if the farmer not using improved methods can mix a large proportion of his damaged corn with good grain and thus sell it at the same price as well-stored grain.

Similarly, are grain prices keeping pace with inflationary price rise in the cost of the new storage techniques? Also, increased transportation prices, for example, can reduce potential profits. In short, the economies, that is, the practical benefits of a new method, must be thought through from the farmer's standpoint or, it may fail to be accepted because of simple economic realities.

Social Customs and Traditions. Similarly, local customs and traditions should be carefully studied from the farmers viewpoint to see what impact they might have on the introduction of a particular storage technique. The use of insecticides, for example, may require careful planning. If farmers are used to leaving their maize unhusked during storage, will they resist? Will insecticide-treated grain have a changed taste or odor? Is treated grain acceptable by the farmer for his own consumption? Is it acceptable for sale locally? Have there been any bad experiences in the locality as a result of the misuse of insecticides?

Another example of the importance of social customs is the farmer's attitude toward centralization of storage facilities. Does the farmer traditionally build a grainary in his field and leave the crops stored there until needed? Would a central storage silo cause him transportation problems? Will he resist co-operative storing because he doesn't want his neighbor to know how much he has produced? Social factors such as these can affect the success of a new storage program.

Having analyzed the problems from the point of view of the farmer, the planning agency or organization must decide upon the scope of the program it hopes to introduce and to what extent it can support the program.

Personnel considerations. The providing of new information and training and support for the introduction of improved storage methods requires considerable personnel. Does the agency have sufficient manpower? Will the personnel need training in the new techniques? Will voluntary extension personnel be needed? To whom will volunteers be responsible? What will their role be in relation to the permanent extension personnel? How will coordination be arranged? Is the organizing agency willing to assign permanent personnel to assure the success of the program? Staffing and training therefore, are extremely important in planning a new program.

Material Availability. The supply of necessary materials must be assured as well. To what extent is the project dependent upon vital materials which are influenced by outside forces, ie., regional or world shortages, inflation. Cement, insecticides, tin sheeting, re-rod, sand, water, screening, wood ---- are they readily available? Who will be responsible for assuring the supply of needed materials? How reliable is that person or agency? How reliable is the supply? Lack of critical items when needed will undermine the farmer's confidence in the program.

Transportation. Are local transportation facilities available and adequate for the needs of the program? If they are not, provisions for vehicle support must be made. In such a case, decisions must be made as to the use of the vehicles before precedents are set. If farmers are dependent on a project to transport their harvests, this may prevent the development of local transport and cause difficulties when the project can no longer continue such support.

Commercialization. Marketing success of grains stored using improved methods will influence the rapidity with which those methods are accepted. For example, if local market prices do not fluctuate as greatly as those in urban centers, the sponsoring agency may want to consider the planning and support of organized transportation for commercialization. The program should consider the available means of commercialization and look for improvements to enhance the value of the improved storage techniques. For example, the sponsoring agency may want to reward farmers for the improved quality of their grain by introducing some system of quality grading or sale by weight to help popularize their techniques.

The above brief summary includes some of the major factors an agency must evaluate in deciding at what level it is willing to and capable of participating in a program for new grain storage techniques.

Having thus considered the problem, one is better prepared to choose the particular means of improving storage which is best suited for the new program.

## Part II. Choice of the Improved Method to Popularize

The choice of an improved storage technique for popularization should result from an analysis of the existing problems. Clearly, the economic factor will weigh very heavily. In dealing with subsistence-level farmers with very limited cash resources, the total cost of construction, repair and utilization of a new technique must be measured carefully against the effectiveness and practical benefit to the farmer. This type of calculation generally requires time for both study and testing of the new method, two factors which are important to the process of choosing a storage technique.

Scientific testing. The importance of scientific testing cannot be over-estimated. Such analysis, before introducing the new storage technique to the farmer, can avoid many problems.

Scientific testing lends authenticity and permits the sponsoring agency to defend confidently such factors as reliability and efficiency. For example, the Institute of Research for Tropical Agriculture (IRAT), in Dahomey, has greatly advanced storage techniques in that country by its testing of many storage methods, among them; local grainaries with and without insecticides, cribs, artificial dryers, cement stave and metal silos. The results of these experiments have produced information important to the planning, choice and policy of grain storage programs in Dahomey.

Testing, therefore, is an important step in choosing a particular method of improved grain storage.

Field Experience. Less formal, but equally revealing, is field experimentation. For example, field trials can help to verify the adaptability of local materials as substitutes for more obvious and costly imported materials.

Field tests uncover hidden problems and unanticipated social impediments. They can indicate the level of farmer interest in the proposed new technique.

An example of the value of field tests in Dahomey was demonstrated when they revealed that storage in butyl bags was impractical because common over-filling caused bursting, and rats or sharp objects easily pierced the bag destroying its air tightness. In effect, the field testing of a new technique provides a kind of market sampling of the locality before larger-scale popularization.

The use of permanent extension agents or Volunteers in performing field tests can be effective. In Dahomey, for example, Peace Corps Volunteers performed useful field experimentation in the early years that resulted in much practical information essential to developing the grain storage program here.

Such field experiments must be clearly described as such to farmers to avoid false impressions and to permit adjustments of the program. Thus protected, one can obtain valuable information pertaining to such additional questions as (1) how much training time and supervision is necessary to assure proper construction and/or proper use? (2) can the farmer maintain



the technique himself? (3) are special tools required? (4) will the existing agriculture extension system support the new technique?

The final choice of a particular storage method to popularize will be a balance of many of the factors previously discussed in the context of local conditions. To help the reader assess the various grain storage methods presented during the seminar, a "table of consideration" is attached to aid in one's analysis. Participants can fill in any information which they feel is pertinent and valuable to their specific purposes.

### Part III. Methods of Financing the Introduction of New Storage Techniques

The organization of the financial aspects of a new program of improved grain storage techniques is essential to the smooth start of the program. There are several types of financing available from which to choose, among which are included:

1. Direct cash investment by participating farmer
2. Credit financing
3. Price supports
4. Grants

#### 1. Direct cash investment by participating farmer

Cash payment for any improved storage technique is the simplest and most direct method of financing. It requires a minimum of administrative, financial and coordinating burdens for the sponsoring agency. Furthermore, cash programs using the personal financial resources of the farmer can be the method of financing which gives the widest and fastest possible popularization of a program, providing that they are relatively inexpensive and accessible to small farmers.

In countries with an average annual per capita income of less than \$100, such as Dahomey, many methods of storage which are relatively low-cost will still be beyond the means of the average small farmer. In this case, high cash requirements can severely limit the scope of a program and the speed of its acceptance.

If the cost of the new technique is too high, the benefits derived from the improvements may be concentrated in the hands of farmers at the highest income level or even with merchants and civil servants who are quick to see the monetary advantages of improved storage methods.

Thus, other methods of financing will have to be considered if the average farmer is to participate in improved storage programs. Later, as a result of his use of improved methods, his increased income may permit him to assume more financial responsibility for additional improvements.

#### 2. Credit Financing

Credit financing can increase the potential availability of improved storage methods to the low-income farmer.

A. Selection of credit recipients is an important consideration. If the project uses financial criteria similar to those used for bank loans, most small farmers will not have sufficient resources or collateral to merit credit. In order to make credit available to those who need it most, without risking a low rate of repayment, it may be necessary to allow repayment of loans in kind or make provisions for a commercialization program for the grain stored.

To participate in a credit program, a farmer should be asked to show his degree of interest in the project, beforehand. This can be judged through the requirement of a cash advance or the supplying of specific materials or labor.

B. The System of repayment of the credit loan should be well-planned before the program begins. Provisions should be made for the eventuality that a certain proportion of the loans will not be repaid sometimes due to circumstances beyond his control, such as crop failure. The terms and requirements of the credit program must be clearly explained to all farmer participants and to all extension personnel to assure that all parties concerned understand the responsibilities being assumed.

### 3. Price Supports

Another way of financing a program of improved grain storage techniques is by price support contributions by the sponsoring agency. This is a form of gift but it is for the purpose of underwriting the program. For example, it might involve granting a portion of the cash value of construction materials or transportation expenses, the remainder being paid for by the interested farmer or cooperative.

Price supports can provide a valuable alternative to cash and credit financing, especially when there are rapid increases in the prices of building materials or insecticides without equivalent increases in the prices that farmers receive for their produce. Price supports used in conjunction with a cash program can serve to avoid the repayment problems inherent in credit, thus decreasing the administrative burdens of the program.

Un-repayed credit becomes a gift. If a high percentage of reimbursement cannot be assured by a credit program, it might be better to distribute the available financial resources through the use of price supports. This would make it possible to extend the benefits of the program to more people.

A price support program, while limited by the resources available, has many of the advantages of a cash program. The project personnel has a smaller and less complicated administrative work-load than a credit program. Another advantage is that the interest of the farmer is assured by his cash participation.

### 4. Grants

Grants provide a means of having programs quickly accepted by farmers; their scope is limited only by the financial capabilities of the granting agency. However, grants can present problems to the long-term development of a program. Once the project funds have been exhausted for grant financing, it may be difficult to convince farmers to pay their own money for what others have been given free. In this case, there may be a lag in popularization while farmers wait to assure themselves that no further gifts will be forthcoming.

There is another problem that may result from the donation of a grant: Since the investment by the farmer is minimal, his interest in the upkeep and proper use of the items received may also be minimal.

If grants for the total cost of the storage method are to be given to farmer participants, better results may be assured by careful selection of recipients, thorough explanation of the practical advantages and use of the storage method, followed by continued supervision in its proper use.

#### Part IV. Stimulating Interest in Improved Storage Methods

There are many methods of popularizing a new storage technique or of stimulating interest in it. The manner in which it is done can directly affect the number of farmers who will choose to try the new technique.

It is best that the program be completely planned before commencing active popularization at the farmer level, in order to avoid confusion or delays. For example, project field agents should be trained and fully informed about the program before they begin discussing it with farmers. The storage method should have been tested. The financial arrangements should be settled and agreed upon. Transportation problems should be resolved. Provisions should be made for the rapid acceptance and expansion of the program. Once all these matters are prepared, then the popularization can begin.

##### Demonstration Methods

Demonstration of improved storage methods can be very effective in convincing farmers to adopt the new method for themselves. Demonstration models should be highly visible and built to attract a lot of attention. Possible locations for demonstration sites are: near the home of an individual farmer, at farmers' cooperatives, at agricultural youth clubs, at agricultural expositions or on publicly owned land.

Important considerations in attracting the farmers' attention are: Is the location easily seen? Is adequate, easily interpreted information provided? If it is built for an individual farmer, is he well-respected? Will he use the site? Are there local personnel available who can explain the method? Will the site be attractive and well-maintained?

##### On Farm Demonstrations

Because of some traditional farmers' reluctance to adopt new methods, the initial demonstration sites may need to be built on a total gift or price-supported basis, perhaps with a guarantee to reimburse any losses in the event of failure. However, when the demonstration site is installed as a gift, recipients may have little stake in its success. Since the purpose of a demonstration site is to spread the knowledge of good results, special care should be taken that such sites are well chosen to reduce problems of mis-use or abandonment. It is a good idea for the selection of farmers for demonstration sites to be done with the aid of local agricultural extension or government authorities. Additionally, close supervision and careful explanation of storage techniques will help to assure good results and positive propaganda.

##### Agricultural Expositions

The high visibility offered by agricultural fairs presents an excellent opportunity for display, explanation and discussion of demonstration models. An explanation in the local language by a farmer already convinced of the method through personal experience and success can greatly increase the impact of an agricultural fair demonstration. Follow-through is increased by handing out simple flyers which briefly explain the storage method and give names and addresses to contact for more detailed information and assistance.

### Demonstration Sites on Public Lands

Sites near market places, health clinics or local agricultural offices can be very effective demonstration locations. Since this type of site generally has no single owner or person responsible for its operation, assurance should be made in its planning to provide for continued and proper use because an unused storage unit can be a bad advertisement. Increased credibility and effectiveness can be provided by assistance of local agricultural extension agents in demonstration site operation and information dissemination and by inviting local farmers to participate in all aspects of its use. Whenever possible, transportation of interested farmers to a demonstration site can increase its impact.

### Use of Radio and Newspapers

For more widespread popularization purposes, agricultural radio programs and newspapers can be used. Since these methods lack the visual impact and opportunity for questions provided by actual demonstration sites, explanations must be clearly and convincingly focused at the level of knowledge of the prospective users, preferably in the local language or with simple self-explanatory diagrams and pictures.

### Conclusion

With all of the above methods for creating interest through demonstration and information dissemination, emphasis should be placed on the practical benefit of the new storage method and all popularization efforts should be designed for high visibility and comprehension at the level of the farmers for whom the project is aimed.

## Part V. Integration into the Local Infrastructure

A grain storage program can have a more lasting and broader impact if it is closely integrated with agricultural extension services, farmers' organizations, local craftsmen and the local marketing structure. Additionally, such integration can reduce the program's organizational and logistical responsibilities. For example, the management of insecticide supplies might be turned over to merchants' or farmers' organizations. Craftmen, once trained in storage construction skills, can take over further training through apprenticeship of younger craftsmen. Agricultural agents can supervise drying, treatment and storage. Involvement at all levels of the agricultural, economic and social sectors will help bring about an integration which hopefully results in adaptation of the storage method.

Coordination with other related projects can also extend the long-range effect of a grain storage project. For example, a broader more effective base might be gained by joining forces with grain commercialization programs or improved production projects which encourage the use of fertilizers, improved seeds and/or animal traction. This type of coordination can provide complementary benefits for other sectors of activity as well.

To achieve real and continued integration, one of the project's conscious goals must be just that, integration. Contact between project coordinators through regular meetings or frequent interchange can help to keep communication going and to facilitate cooperation. In addition, competent and thorough training will increase the value of the project extension workers' contribution toward integration. Training sessions can be held "on site" for direct experience or, in the case of large groups, short instruction courses can be incorporated at local training institutes or schools.

Given the temporary nature of third-party developmental aid, a project relying on this type of support cannot expect to have long-term duration if integration into existing infrastructures is not undertaken. The sooner integration begins, the less is the risk caused by the eventual or sudden loss of outside project support, local participation and local adaptation.

APPENDIXBrief History of the Grain Storage  
Program of the Agriculture Service  
of Dahomey and the U. S. Peace Corps

It was in 1967 that the Agriculture Service of Dahomey under the Ministry of Rural Development first asked for U.S. Peace Corps volunteers to assist it in implementing a new program of grain conservation at the farm level in southern Dahomey. Problems with grain storage had always been acute in Dahomey.

The vast majority of maize produced annually in Dahomey is grown in the southern half of the country where there is constantly high humidity and temperatures which foster rotting as well as the multiplication of maize-consuming insects. The traditional method of storage in southern Dahomey is in loosely-woven palm thatched granaries raised on wooden stilts. The only real protection against attack by rodents and insects is offered by the husk on each ear of maize, resulting in 30% average loss of the 300,000 tons approximate annual production. The estimated value of maize lost annually to the combined effects of insects, rodents and rot is a minimum of 600,000,000 CFA (about \$3million).

The idea behind the original request was to introduce to individual farmers the use of the insecticide, Phostoxin, with steel drums and butyl sacks furnished by the Office of Agricultural Commercialization of Dahomey (now S.O.C.A.D.) under a grant by US AID.

Thus, the initial impetus to the project was aimed at popularizing a new storage technique at the farm level. It also entailed assessment of traditional systems of storage and experimentation with a variety of potential improved methods of storage. One of these methods was the cement stave silo, adapted from larger models used in the United States, and the mud-walled Brooks dryer, developed at Ibadan, Nigeria, and adopted by the Institute of Research of Tropical Agriculture (I.R.A.T.) at Niaouli, Dahomey.

Since the process of artificial drying and storage in a new type of silo was experimental, and the results could not be guaranteed, the majority of the expenses of constructing the first units for individual pilot farmers were paid for by the U.S. Embassy Self-Help Fund.

Over the first few years, the Agricultural Service and the Volunteers constantly tried modifications in the design of the silos and dryers. During this period of experimentation Dahomean Agricultural extension agents and local officials offered their help and advice. Cumulative results of field testing did indicate to the Agricultural Service and the Peace Corps that the Cement stave silo merited carefully controlled scientific experimentation to determine its reliability of performance.

By 1971, it was clear that (1) farmers in Southern Dahomey were ready to accept new methods of storing corn, (2) the earthen dryer was effective and had potential for popularization, and (3) there were two types of silos -- cement stave and sheet metal (the latter developed by I.R.A.T.) which appeared promising for farm level storage.

At this point, it was decided by the Agricultural Service, the Peace Corps and I.R.A.T. that controlled tests should be performed. Accordingly, an experiment was installed at the I.R.A.T. station at Niaouli. Twelve cement stave silos and twelve sheet metal silos were built and placed under a large shelter. The silos were filled at the end of October, 1971, periodically tested and emptied in June 1972. They were then refilled with new maize in November, 1972, similarly tested and emptied in May, 1973. The results of these trials demonstrated that both types of silos, if treated with insecticide, store maize extremely well. It was determined that maize dried to a moisture content of 12% and treated with any of a variety of insecticides could be stored in cement stave silos for at least six months with average losses of not more than 3 percent.

During this time, volunteers had been working with local agricultural officials to popularize and build silos and dryers for interested farmers who could afford the units which had an average cost of \$70-\$80 (without expensive tin roofed shelter). It was after the I.R.A.T. tests that the director of the Dahomean Agricultural Service decided to officially adopt this system, and the National Cereals Commission of Dahomey committed 5 million CFA (\$20,000) for the credit construction of 100 storage units for individual farmers each consisting of a 4.5 ton cement stave silo, an earthen dryer, and a tin-roofed shelter. The first ten units were built in the region of Sakété, under the supervision of a technical agent of the Agricultural Service and a Peace Corps Volunteer. These completed units were officially accepted by the Minister of Rural Development and Cooperative Action in June, 1974, and work has been authorized on construction of another twenty in the three southern provinces of Dahomey.

The National Cereals Commission has established criteria for the 100 farmers who are to receive this credit. The participants must:

1. be a farmer
2. cultivate at least two hectares (5 acres) of maize per year
3. reside in the district where the silo is to be built
4. be recognized by local agricultural agents as a progressive and cooperative individual
5. be willing to sign a contract for the repayment of the loan
6. make a 10,000 CFA (\$40) cash advance as an indication of serious intent.

The loan is to be paid off in six equal annual payments at 2% interest. Payment can be made in cash or the equivalent value of maize at a pre-determined value of 25 cfa/kg (the average price of maize at the time of harvest has been from 6 to 10 cfa/kg).

Over the years, the collaboration has grown between the Peace Corps and the Agricultural Service and particularly its Division of Crop Protection which has a supervisory role with respect to the volunteers. Requests for and assignment of volunteers is handled through these offices. A volunteer with experience in the program in Dahomey has traditionally been designated as "Coordinator" by the Dahomean officials and Peace Corps staff, and he acts as a liaison between the grain storage volunteers in the field, the Peace Corps staff in Cotonou, and the government agricultural officials in Porto-Novo. The Peace Corps, besides furnishing volunteers, has helped find outside funding for program related projects.



# Appendix F

## BIBLIOGRAPHY

The information in this manual is not and can not be complete. The information presented here cannot be immediately applicable or appropriate to all regions or to every storage need. You may well require further technical assistance in adapting these materials and others to your grain storage situation. Some of that help can come from books; much, from organizations and people.

The Tropical Products Institute (TPI) may already be a familiar name to you. This agency does a great deal to gather and distribute information worldwide on grain and grain storage problems. Materials from the TPI library have been of great value in the preparation of this manual.

Peace Corps and VITA are grateful to TPI for its permission to reprint that agency's bibliography of materials on the various aspects of farm-level grain storage.

---

## Tropical Products Institute

---

**G64**

# **Crop storage bibliography (with particular reference to the storage of durable agricultural produce in tropical and sub-tropical countries)**

---

Mrs. S. M. Blatchford and A. J. Wye

This bibliography has been produced by the Tropical Products Institute, a British Government organization which helps developing countries to derive greater benefits from their renewable resources.

Reproduction of this bibliography, in whole or in part, is gladly permitted provided that full acknowledgement is given to the Tropical Products Institute, Foreign and Commonwealth Office, (Overseas Development Administration), and to the authors.

Requests for further information on this subject should be addressed to:

Tropical Stored Products Centre  
(Tropical Products Institute)  
London Road  
Slough SL3 7HL  
Bucks.

# Contents

---

	* Page
TEXTBOOKS	F-5
JOURNALS	F-5
ANNUAL REPORTS	F-5
HANDBOOKS, BULLETINS, SPECIAL REPORTS	F-6
ADVISORY LEAFLETS	F-9
SCIENTIFIC PAPERS	F-10

\* Re-numbered in  
this manual

## NOTES

This bibliography attempts to bring together a selection of the more important publications dealing with tropical crop storage; it clearly cannot be exhaustive.

Where possible, the prices (at time of publication) and addresses are given for obtaining publications listed here, excluding scientific papers. A list of the most common addresses appears below.

***BRITISH STANDARDS INSTITUTION:***

Sales Branch, 101-113, Pentonville Road, London, N.1.

***MINISTRY OF AGRICULTURE, FISHERIES and FOOD:***

Tolcarne Drive, Pinner, Middlesex.

***UNITED NATIONS: FOOD & AGRICULTURE ORGANIZATION:***

Distribution & Sales Section, Via delle Terme di Caracalla, 00100 Rome, Italy.

***UNITED STATES: DEPARTMENT OF AGRICULTURE:***

Superintendent of Documents, U.S. Government Printing Office, Washington D.C. 20402, U.S.A.

- 
- ANDERSON, J.A. and ALCOCK, A.W.* (Eds).  
1954 Storage of cereal grains and their products. St. Paul, Minn: Amer. Ass. Cereal Chem., 1954, ix + 515 pp. (Out of print: obtainable from Univ. Microfilms, Ann Arbor, Mich., price £10.00. Currently under revision).
- BUSVINE, J.R.*  
1966 Insects and hygiene. The biology and control of insect pests of medical and domestic importance. London: Methuen and Co., 1966; 2nd rev. edn, xi + 467 pp. Price £5.00.
- CHRISTENSEN, C.M. and KAUFMANN, H.H.*  
1969 Grain storage. The role of fungi in quality loss. Minneapolis, Minn.: Univ. Minnesota Press, 1969, vii + 153 pp. Price \$6.50.
- COTTON, R.T.*  
1963 Pests of stored grain and grain products. Minneapolis, Minn: Burgess Publ. Co., 1963, rev. edn, 2 + i + 318 pp. (Out of print).
- MUNRO, J.W.*  
1966 Pests of stored products. London: Hutchinson (The Rentokil Library), 1966, 234 pp. Price £2.10.
- TRISVYATSKII, L.A.*  
1966 Storage of grain. Moscow: Izdatel'stva 'Kolos', 1966, 3rd edn, 406 pp. (Translated into English by Keane, D.M. and edited by Kent, N.L. & Freeman, J.A. Boston Spa: natn. Lending Libr., 1969, 3 volumes, 244, 287 & 307 pp. Price £1.25 per vol., £3.75 the set).
- 

## Journals

---

- BULLETIN OF GRAIN TECHNOLOGY.*  
Quarterly. Hapur: Foodgrain Technologists' Research Association of India. Price \$3.00 per annum.
- JOURNAL OF STORED PRODUCTS RESEARCH.*  
Quarterly. Oxford: Pergamon Press. Price £12.00 per annum.
- TROPICAL STORED PRODUCTS INFORMATION.*  
Biannual. Bulletin of the Tropical Stored Products Centre (Tropical Products Institute). Free. (Enquiries to the Tropical Stored Products Centre, (TPI), London Road, Slough SL3 7HL, Bucks).
- 

## Annual Reports

---

- CENTRAL FOOD TECHNOLOGICAL RESEARCH INSTITUTE.*  
Annual reports of the C.F.T.R.I., Mysore - 2, India. Priced.
- INFESTATION CONTROL.*  
Reports of the Infestation Control Laboratory (Ministry of Agriculture, Fisheries & Food). London: HMSO. Priced.

**NIGERIAN STORED PRODUCTS RESEARCH INSTITUTE.**

Annual reports of the Nigerian Stored Products Research Institute, Federal Ministry of Trade. Lagos: Fed. Minist. Inform., Printing Div. Priced.

**PEST INFESTATION RESEARCH.**

Annual reports of the Pest Infestation Laboratory (Agricultural Research Council). London: HMSO. Priced.

**TROPICAL PRODUCTS INSTITUTE.**

Annual reports (up to and including 1967) and then Biennial reports of the Tropical Products Institute, (Overseas Development Administration). May be priced. (Enquiries to the Scientific Secretariat, Tropical Products Institute, 56-62 Gray's Inn Road, London WC1X 8LU).

**TROPICAL STORED PRODUCTS CENTRE: MINISTRY OF OVERSEAS DEVELOPMENT.**

1970. Tropical Stored Products Centre. A Report on the work 1965 – 1966. (The work of the Centre prior to 1965 was reported as part of the Annual Report 'Pest Infestation Research'; from July 1967 it forms a part of the Annual and Biennial Reports of the Tropical Products Institute. Enquiries to the Tropical Stored Products Centre, (TPI), London Road, Slough SL3 7HL, Bucks).

## Handbooks, Bulletins, Special Reports

- BROWN, W.B.** 1959 Fumigation with methyl bromide under gas-proof sheets. Dep. Sci. Ind. Res., Pest Infest. Res. Bull. No. 1. London: HMSO, 1959, 2nd edn, ii + 44 pp. Price 22½p.
- COTTERELL, G.S. and HOWE, R.W.** 1952 Insect infestation of stored food products in Nigeria. (Report of a survey, 1948 – 50, and of control measures adopted). Colonial Res. Publ. No. 12. London: HMSO, 1952, 40 pp. Price 25p.
- EASTER, S.S.** 1947 (Ed). Preservation of grains in storage. Papers presented at the international meeting on infestation of foodstuffs, London, 5 – 12 Aug., 1947. Wash., D.C. : Fd. Agric. Org. agric. Stud. No. 2, 1948, 174 pp. Price \$1.50.
- FREEMAN, J.A.** 1958 Control of pests in stored agricultural products with special reference to grain. Report of a survey in North and South America and certain Mediterranean countries in 1954 and 1955. Org. eur. econ. Coop., eur. Productivity Agency Project No. 212, Feb. 1958. Paris: OEEC, 1958, 169 pp. Price 57½p. (OEEC Dist. & Sales Serv., 33 Rue de Franqueville, Paris 16e and overseas agents).
- FURMAN, D.L.** 1968 Suggested guide for the use of insecticides to control insects affecting crops livestock, households, stored products, forests and forest products. U.S. Dep. Agric., agric. Res. Serv., agric. Handbk No. 331, 1968, rev. edn, xvi + 273 pp + 2 app. Price \$1.50.
- HALL, D.W.** 1970 Handling and storage of food grains in tropical and sub-tropical areas. FAO agric. Dev. Paper No. 90. Rome: UNFAO, 1970, xiv + 350 pp. Price US \$6 (£2.40).

*HINTON, H.E. and CORBET, A.S.*

1963 Common insect pests of stored food products. A guide to their identification. Econ. Ser. Brit. Museum (nat. Hist.), No. 15. London: British Museum, 1963, 4th edn, vi + 61 pp. Price 17½p.

*HOLMAN, L.E.*

1960 (Compiler). Aeration of grain in commercial storages. U.S. Dep. Agric., Mktg Res. Rep. No. 170, 1960 (revised and reprinted Sept. 1966), 46 pp. Price 35 ¢.

*HUGHES, A.M.*

1961 The mites of stored food. Tech. Bull. Minist. Agric. Fish. Fd, No. 9, 1961, vi + 287 pp. London: HMSO. Price 87½p.

*INTERNATIONAL: EUROPEAN AND MEDITERRANEAN PLANT PROTECTION*

*ORGANISATION.* Report of the international conference on the protection of stored products, Lisbon 27 – 30 Nov. 1967. EPPO Publications, Ser. A, No. 46-E. Paris: EPPO, 1968, 171 pp. Price £1.65. (EPPO, 1 rue le Notre, Paris).

*INTERNATIONAL: EUROPEAN AND MEDITERRANEAN PLANT PROTECTION*

*ORGANIZATION.* Report of the working party on Stored Products of Tropical Origin (Hamburg, 5 – 6 Nov. 1968). EPPO Publications, Ser. A, No. 51-E. Paris: EPPO, 1969, 38 pp + 7 tables. Price 50p. (EPPO, 1 rue le Notre, Paris).

*INTERNATIONAL: EUROPEAN AND MEDITERRANEAN PLANT PROTECTION*

*ORGANISATION.* Report of the Working Party on Stored Products of Mediterranean Origin (Lisbon, 13 – 14 March, 1969). EPPO Publications, Ser. A, No. 56. Paris: EPPO, 1970, 85 + xxx pp. Price unknown. (EPPO, 1 rue le Notre, Paris).

*JOUBERT, P.C. and DE BEER, P.R.*

1968 The toxicity of contact insecticides to seed-infesting insects. Series No. 6. Tests with bromophos on maize. S. Afr. Dep. Agric., tech. Serv., tech. Commun. No. 84. Pretoria: Government Printer, 1968, 9 pp.

*KAMEL, A.H. and SHAHBA, B.A.*

1958 Protection of stored seeds in Egypt. Bull. Minist. Agric. Egypt, Ext. Dep., No. 295. Cairo: General Organization for Government Printing Offices, 1958, 16 pp.

*LAHUE, D.W.*

1969 Evaluation of several formulations of malathion as a protectant of grain sorghum against insects – in small bins. U.S. Dep. Agric., agric. Res. Serv., Mktg Res. Rep. No. 828, 1969, iv + 19 pp. Price 20 ¢.

*LAHUE, D.W.*

1970 Evaluation of malathion, diazinon, a silica aerogel and a diatomaceous earth as protectants on wheat against lesser grain borer attack ... in small bins. U.S. Dep. Agric., agric. Res. Serv., Mktg Res. Rep. No. 860, 1970, iv + 12 pp.

*LOCHNER, E.H.W.*

1963 Safe storage of food grains in the Republic of South Africa. S. Afr. Dep. Agric., tech. Serv., tech. Commun. No. 13. Pretoria: Government Printer, 1963, ii + 45 pp.

*LOCHNER, E.H.W.*

1964 Fumigation of maize in railway trucks in transit to the ports. (In Africaans with English Summary). S. Afr. Dep. Agric., tech. Serv., tech. Commun. No. 25. Pretoria: Government Printer, 1964, ii + 62 pp.

- McFARLANE, J.A., MARTIN, H.G., DIXON, W.B. and MOLLISON, D.W.*  
1961 Prevention and control of infestation of stored grain by insect pests and rodents. Prepared jointly by the Storage and Infestation Division (Mktg Dept, Minist. Trade and Ind.) and Plant Protection Division (Minist. Agric. and Lands). Kingston, Jamaica: Govt Printer, 1961, iii + 57 pp.
- MONRO, H.A.U.*  
1971 Manual of fumigation for insect control. F.A.O. agric. Studies, No. 79. Rome: FAO, 1971, xii + 381 pp. Second edn, revised. Price £2.80.
- ORDISH, G.*  
1967 (Gen. Ed). Pest control in groundnuts. PANS Manual No. 2. London: Minist. Overseas Dev., trop. Pestic. Res. H.Q. & Inf. Unit, 1967, iv + 138 pp. Price 45p. (56-62 Gray's Inn Rd, London, WC1X 8LU).
- PREVETT, P.F.*  
1959 An investigation into storage problems of rice in Sierra Leone. Colonial Res. Studies, No.28. London: HMSO, 1959, 52 pp.
- RANSOM, W.H.*  
1960 Buildings for the storage of crops in warm climates. Dep. sci. ind. Res. Trop. Building Studies, No. 2. London: HMSO, 1960, 24 pp. Price 22½p.
- SALMOND, K.F.*  
1957 Investigations into grain storage problems in Nyasaland with special reference to maize (*Zea mays* L.). Colonial Res. Publ No. 21. London: HMSO, 1957, 49 pp. Price 22½p.
- SMITH, C.V.*  
1969 Meteorology and grain storage. Tech. Note U.N. Wld met. Org., No. 101 (WMO No. 243 TP 133). Geneva: Secretariat of World Meteorological Organisation, 1969, xvi + 47 pp. Price £1.00.
- STEELE, B.*  
1970 (Gen. Ed.). Pest control in rice. PANS Manual No. 3. London: Minist. Overseas Dev. trop. Pestic. Res. H.Q. & Inf. Unit, 1970, ii + 270 pp. Price 62½p. (56-62 Gray's Inn Rd, London WC1X 8LU).
- UNITED NATIONS: FOOD AND AGRICULTURE ORGANIZATION.*  
1968 Improved storage and its contribution to world food supplies. Chapter 4 in 'State of Food and agriculture, 1968', pp 115 – 143. Rome: FAO, 1968, 205 pp. Price \$5.75 or £2.30.
- UNITED NATIONS: FOOD AND AGRICULTURE ORGANIZATION.*  
1969 Crop Storage. Technical Report No. 1 of the Food Research and Development Unit, Accra, Ghana. Prepared for the Government of Ghana by FAO acting as executing agency for the United Nations Development Programme, based on the work of J. Rawnsley. PL:SF/GHA 7. Rome: FAO, 1969, ix + 89 pp + 7 app.
- UNITED STATES: DEPARTMENT OF AGRICULTURE: AGRICULTURAL MARKETING SERVICE, BIOLOGICAL SCIENCES BRANCH, STORED PRODUCTS INSECTS SECTION.*  
1958 Stored grain pests. U.S. Dep. Agric. Fmrs Bull. No. 1260, 1958, rev., 46 pp. Price 25 ¢.
- WOGAN, G.N.*  
1965 (Ed.). Mycotoxins in foodstuffs. Proceedings of a symposium at Massachusetts Inst. Technol., March 1964. Cambridge, Mass: Mass. Inst. Technol. Press, 1965, xii + 291 pp. Price £3.75.
- WORLD FOOD PROGRAMME.*  
1970 Food storage manual. (Prepared by the Tropical Stored Products Centre, Ministry of Overseas Development). Rome: FAO, 1970, 3 vols, 820 pp. Price \$18.

---

## Advisory Leaflets

---

**BOOTH, C., HOLLIDAY, P. and SUBRAMANIAN, C.V.**

1969 C.M.I. descriptions of pathogenic fungi and bacteria. Set 22, sheets 211 – 220. Kew: Commonw. Mycol. Inst., 1969. Price 25p. (Commonw. Mycol. Inst., Ferry Lane, Kew, Surrey).

**BRITISH STANDARDS INSTITUTION.**

1967 Methods for sampling oilseeds. Br. Stand. No. 4146, 1967, 16 pp. Price 30p.

**BRITISH STANDARDS INSTITUTION.**

1968 Methods of test for cereals and pulses. Part 2. Determination of moisture content of cereals and cereal products (basic reference method). Br. Stand. No. 4317, Part 2, 1968, 12 pp. Price 25p.

**BRITISH STANDARDS INSTITUTION.**

1968 Methods of test for cereals and pulses. Part 4. Determination of impurities in pulses. Br. Stand. No. 4317, Part 4, 1968, 7 pp. Price 20p.

**BRITISH STANDARDS INSTITUTION.**

1969 Methods for sampling cereals (as grain). Br. Stand. No. 4510, 1969, 19 pp. Price 50p.

**BRITISH STANDARDS INSTITUTION.**

1969 Methods for sampling pulses. Br. Stand. No. 4511, 1969, 16 pp. Price 40p.

**BRITISH STANDARDS INSTITUTION.**

1969 Recommended common names for pesticides. Br. Stand. No. 1831, 1969, 4th rev., 107 pp. Price £2.00.

**HARMOND, J.E.; BRANDENBURG, N.R. and KLEIN, L.M.**

1968 Mechanical seed cleaning and handling. U.S. Dep. Agric., agric. Res. Serv. (in conj. w. Oregon agric. Exp. Stn), agric. Handbk No. 354, 1968, 56 pp. Price 55 ¢.

**MINISTRY OF AGRICULTURE, FISHERIES and FOOD.**

1966 Fumigation with the liquid fumigants carbon tetrachloride, ethylene dichloride and ethylene dibromide. Precautionary measures. London: HMSO, 1966, rev. edn, i + 8 pp. Price 7½p.

**MINISTRY OF AGRICULTURE, FISHERIES and FOOD.**

1968 Heating of grain in store. Minist. Agric. Fish. Fd, Adv. Leaflet No. 404, 1968, rev., 6 pp. Single copies free.

**MINISTRY OF AGRICULTURE, FISHERIES and FOOD.**

1968 Insect pests in food stores. Minist. Agric. Fish. Fd, Adv. Leaflet No. 483, 1968, rev., 8 pp. Single copies free.

**MINISTRY OF AGRICULTURE, FISHERIES and FOOD.**

1969 Fumigation with ethylene oxide. Precautionary measures, 1969. London: HMSO, 1969, 8 pp. Price 9p.

**UNITED STATES: DEPARTMENT OF AGRICULTURE: AGRICULTURAL RESEARCH SERVICE, AGRICULTURAL ENGINEERING RESEARCH DIVISION.**

1969 Guide lines for mold control in high-moisture corn. U.S. Dep. Agric., Fmrs Bull. No. 2238, 1969, rev., 16 pp. Price 10 ¢.



1969

Controlling insects in farm-stored grain. U.S. Dep. Agric., Leaflet No. 553, 1969, 8 pp. Price 10 ¢.

## Scientific Papers

A full list of papers published by staff of the Tropical Stored Products Centre is available on request from the TSPC, (TPI), London Road, Slough SL3 7HL, Bucks).

AMARO, J.P. and CANCELA DA FONSECA, J.P.

1957

Panorama actual dos problemas fitossanitarios dos produtos armazenados em Africa. (Comprehensive survey of phytosanitary problems of stored products in Africa). *Garcia de Orta*, 5 (4), 675 – 699.

ASHMAN, F.

1963

The chemical control of stored food insect pests in Kenya. *J. agric. vet. Chem.*, 4 (2), 44–48.

ASHMAN, F.

1966

An assessment of the value of dilute dust insecticides for the protection of stored maize in Kenya. *J. appl. Ecol.*, 3(1), 169 – 179.

ASHMAN, F.

1966

Inspection methods for detecting insects in stored produce. *Trop. stored Prod. Inf.*, (12), 481 – 494.

ASHMAN, F., ELIAS, D.G., ELLISON, J.F. and SPRATLEY, R.

1969

An instrument for detecting insects within food grains. *Milling*, 151 (3), 32, 34 & 36.

ATTIA, R. and KAMEL, A.H.

1965

The fauna of stored products in U.A.R. *Bull. Soc. ent. Egypte*, 49, 221 – 232.

BAILEY, S.W.

1956

Airtight storage of grain, its effects on insect pests. II. *Calandra oryzae* (small strain). *Aust. J. agric. Res.*, 7 (1), 7 – 19.

BAILEY, S.W.

1957

Airtight storage of grain, its effects on insect pests. III. *Calandra oryzae* (large strain). *Aust. J. agric. Res.*, 8 (6), 595 – 603.

BAILEY, S.W.

1962

The effects of percussion on insect pests of grain. *J. econ. Ent.*, 55 (3), 301 – 305.

BAILEY, S.W.

1965

Airtight storage of grain – its effect on insect pests. IV. *Rhyzopertha dominica* (F.) and some other Coleoptera that infest stored grain. *J. stored Prod. Res.*, 1 (1), 25 – 33.

BARNES, J.M.

1969

Pesticide residues as hazards. *PANS*, 15 (1), 2 – 8.

BREESE, M.H.

1960

The infestibility of stored paddy by *Sitophilus sasakii* (Tak.) and *Rhyzopertha dominica* (F.). *Bull. ent. Res.*, 51 (3), 599 – 630.

BREESE, M.H.

1963

Studies on the oviposition of *Rhyzopertha dominica* (F.) in rice and paddy. *Bull. ent. Res.*, 53 (4), 621 – 637.

- BURRELL, N.J.** The chilled storage of grain. *Ceres*, (5), 15–20.  
1969
- CABRAL, A.L. and MOREIRA, I.S.**  
1960 Da ocorrência de algumas pragas de produtos ultramarinos en poroes de navios mercantes (Carreira da Guiné). (Occurrence and distribution of some pests of stored products in ships' holds of cargo ships of the Guinea Line). *Garcia de Orta*, 8 (1), 47–57.
- CASWELL, G.H.** The infestation of cowpeas in the Western Region of Nigeria. *Trop. Sci.*, 3 (4), 154 – 158.  
1961
- CASWELL, G.H. and CLIFFORD, H.T.**  
1960 Effect of moisture content on germination and growth of fumigated maize grain. *Emp. J. exp. Agric.*, 28, 139 – 149.
- CHRISTENSEN, C.M. and KAUFMANN, H.H.**  
1965 Deterioration of stored grains by fungi. *A. Rev. Phytopath.*, 3, 69 – 84.
- CHRISTENSEN, C.M. and LOPEZ, L.C.**  
1963 Pathology of stored seeds. *Proc. int. Seed Test. Ass.*, 28, 701 – 711.
- CLARKE, J.H.** Fungi in stored products. *Trop. stored Prod. Inf.*, (15), 3 – 14.  
1968
- COAKER, T.H.** 'Insack' treatment of maize with insecticide for protection against storage pests in Uganda. *E. Afr. agric. J.*, 24 (4), 244 – 250.  
1959
- COLLINGS, H.** Hermetic sealing of a stack of maize with bituminous roofing felt. *Trop. Agric., Trin.*, 37 (1), 53 – 60.  
1960
- COURSEY, D.G.** Yam storage. I : a review of yam storage practices and of information on storage losses. *J. stored Prod. Res.*, 2 (3), 229 – 244.  
1967
- COVENEY, R.D.** Sacks for the storage of food grains. *Trop. stored Prod Inf.*, (17), 3–22.  
1969
- CRANHAM, J.E.** Insect infestation of stored raw cocoa in Ghana. *Bull. ent. Res.*, 51 (1), 203 – 222.  
1960
- DAVEY, P.M. and ELCOATE, S.**  
1967 Moisture content/relative humidity equilibria of tropical stored produce. Part 3. Legumes, spices and beverages. *Trop. stored Prod. Inf.*, (13), 15 – 34.
- DAVIES, J.C.** Aluminium phosphide for bulk grain fumigation in Uganda. *E. Afr. agric. J.*, 24 (2), 103 – 105.  
1958
- DAVIES, J.C.** A note on the control of bean pests in Uganda. *E. Afr. agric. J.*, 24 (3), 174 – 178.  
1959
- DAVIES, J.C.** Coleoptera associated with stored products in Uganda. *E. Afr. agric. J.*, 25 (3), 199 – 201.  
1960
- DAVIES, J.C.** Storage of maize in a prefabricated aluminium silo in tropical conditions. *E. Afr. agric. J.*, 25 (4), 225 – 228.  
1960

- DAVIES, J.C. Experiments on the crib storage of maize in Uganda. *E. Afr. agric. J.*, 26  
1960 (1), 71 – 75.
- DEXTER, S.T., CHAVES, A.M. and EDJE, O.T.  
1969 Drying or anaerobically preserving small lots of grain for seed or food.  
*Agron. J.*, 61 (6), 913 – 919.
- ELDER, W.B. CSIRO develops aeration system for farm-stored grain. *Pwr Fmg Bett. Fmg*  
1969 *Dig.*, 78 (10), 10 – 13.
- FULLERTON, R.L. Low-cost farm buildings for storage and equipment housing in Ghana.  
1968 *Ghana J. agric. Sci.*, 1 (2), 165 – 170.
- GILES, P.H. The storage of cereals by farmers in Northern Nigeria. *Trop. Agric., Trin.*,  
1964 41 (3), 197 – 212.
- GILES, P.H. Control of insects infesting stored sorghum in Northern Nigeria. *J. stored*  
1965 *Prod. Res.*, 1 (2), 145 – 158.
- GILES, P.H. Maize storage: the problem of today. *Trop. stored Prod. Inf.*, (14), 9 – 19.  
1967
- GILES, P.H. Observations in Kenya on the flight activity of stored products insects,  
1969 particularly *Sitophilus zeamais* Motsch. *J. stored Prod. Res.*, 4 (2), 317 – 329.
- GOLUMBIC, C. and DAVIS, D.F.  
1966 Radiation disinfestation of grain and seeds. *Proc. Symp. Food Irradiation*,  
Karlsruhe, 1966, pp 473 – 488. Vienna : Int. Atomic Energy Agency.
- GONEN, M. and CALDERON, M.  
1968 Changes in the microfloral composition of moist sorghum stored under  
hermetic conditions. *Trop. Sci.*, 10 (2), 107 – 114.
- GRAHAM, W.M. Warehouse ecology studies of bagged maize in Kenya. I. The distribution  
1970 of adult *Ephestia (Cadra) cautella* (Walker) (Lepidoptera, Phycitidae).  
II. Ecological observations of an infestation by *E. cautella*. III. Distribution  
of the immature stages of *E. cautella*. IV. Reinfestation following  
fumigation with methyl bromide gas. *J. stored Prod. Res.*, 6 (2): I, 147 –  
155; II, 157 – 167; III, 169 – 175; IV, 177 – 180.
- GREEN, A.A. The protection of dried sea-fish in South Arabia from infestation by  
1967 *Dermestes frischii* Kug. (Coleoptera, Dermestidae). *J. stored Prod. Res.*,  
2 (4), 331 – 350.
- HALL, D.W. Prevention of waste of agricultural produce during handling, storage and  
1968 transportation. *Trop. stored Prod. Inf.*, (15), 15 – 23.
- HALL, D.W. Food storage in the developing countries. *J. R. Soc. Arts*, 117 (5156),  
1969 562 – 579.
- HALLIDAY, D. Build-up of free fatty acid in Northern Nigerian groundnuts. *Trop. Sci.*, 9  
1967 (4), 211 – 237.

- HAYWARD, L.A.W.** Infestation control in stored groundnuts in Northern Nigeria. *Wild Crops*, 1963 **15** (2), 63 – 67.
- HOWE, R.W.** Entomological problems of food storage in Northern Nigeria. *Bull. ent. Res.*, **43** (1), 111 – 144. 1952
- HOWE, R.W.** A summary of estimates of optimal and minimal conditions for population increase of some stored products insects. *J. stored Prod. Res.*, **1** (2), 177 – 184. 1965
- HOWE, R.W.** Losses caused by insects and mites in stored foods and feeding stuffs. *Nutr. Abstr. Rev.*, **35**, 285 – 293. 1965
- HOWE, R.W. and CURRIE, J.E.** 1964 Some laboratory observations on the rates of development, mortality and oviposition of several Bruchidae breeding in stored pulses. *Bull. ent. Res.*, **55** (3), 437 – 477.
- HYDE, M.B.** Hazards of storing high-moisture grain in airtight silos in tropical countries. 1969 *Trop. stored Prod. Inf.*, (18), 9 – 12.
- JOFFE, A.** Moisture migration in horizontally stored bulk maize: influence of grain-infesting insects under South African conditions. *S. Afr. J. agric. Sci.*, **1** (2), 175 – 193. 1958
- JOFFE, A.** The effect of physical disturbance or 'turning' of stored maize on the development of insect infestation. I. Grain elevator studies. *S. Afr. J. agric. Sci.*, **6**, 55 – 64. 1963
- KAPUR, N.S. and SRIVASTAVA, H.C.** 1959 Storage and preservation of fatty foods. *Food Sci., Mysore*, **8**, 257 – 262.
- KHALIFA, A.** On open-air and underground storage in the Sudan. *Bull. Soc. ent. Egypte*, **53** (44), 129 – 142. 1960
- KHALIFA, A.** The relative susceptibility of some varieties of sorghum to *Trogoderma* attack. *Emp. J. exp. Agric.*, **30** (118), 133 – 136. 1962
- KOCKUM, S.** Protection of cob maize stored in cribs. *E. Afr. agric. J.*, **19** (2), 69 – 73. 1953
- KOCKUM, S.** Control of insects attacking maize on the cob in crib stores. *E. Afr. agric. J.*, **23** (4), 275 – 279. 1958
- LE PELLEY, R.H. and KOCKUM, S.** 1954 Experiments in the use of insecticides for the protection of grains in storage. *Bull. ent. Res.*, **45** (2), 295 – 311.
- McFARLANE, J.A.** An annotated record of Coleoptera, Lepidoptera, Hemiptera and Hymenoptera associated with stored produce in Jamaica. *Trop. Agric., Trin.*, **40** (3), 211–216. 1963
- McFARLANE, J.A.** The productivity and rate of development of *Sitophilus oryzae* (L.) (Coleoptera, Curculionidae) in various parts of Kenya. *J. stored Prod. Res.*, **4** (1), 31 – 51. 1968
- McFARLANE, J.A.** Stored products insect control in Kenya. *Trop. stored Prod. Inf.*, (18), 13 – 23. 1969

- McFARLANE, J.A.** Treatment of large grain stores in Kenya with dichlorvos slow-release strips for the control of *Cadra cautella*. *J. econ. Ent.*, **63** (1), 288 – 292.  
1970
- MACKAY, P.J.** Theory of moisture in stored produce. *Trop. stored Prod. Inf.*, (13), 9 – 14.  
1967
- MAJUMDER, S.K. and BANO, A.**  
1964 Toxicity of calcium phosphate to some pests of stored grain. *Nature, Lond.*, **202** (4939), 1359 – 1360.
- MAJUMDER, S.K., KRISHNAMURTHY, K. and GODAVARI BAI, S.**  
1961 Pre-harvest prophylaxis for infestation control in stored food grains. *Nature, Lond.*, **192** (4800), 375 – 376.
- MAJUMDER, S.K., NARASIMHAN, K.S. and SUBRAHMANYAN, V.**  
1959 Insecticidal effects of activated charcoal and clays. *Nature, Lond.*, **184** (4693), 1165 – 1166.
- MAJUMDER, S.K. and NATARAJAN, C.P.**  
1963 Some aspects of the problem of bulk storage of foodgrains in India. *Wld Rev. Pest Control*, **2** (2), 25 – 35.
- MISHRA, A.B., SHARMA, S.M. and SINGH, S.P.**  
1969 Fungi associated with *Sorghum vulgare* under different storage conditions in India. *PANS*, **15** (3), 365 – 367.
- PAGE, A.B.P. and LUBATTI, O.F.**  
1963 Fumigation of insects. *A. Rev. Ent.*, **8**, 239 – 264.
- PARKIN, E.A.** The protection of stored seeds from insects and rodents. *Proc. Int. Seed Test. Ass.*, **28** (4), 893 – 909.  
1963
- PARKIN, E.A.** The onset of insecticide resistance among field populations of stored product insects. *J. stored Prod. Res.*, **1** (1) 3 – 8.  
1965
- PINGALE, S.V., KADKOL, S.B., RAO, M.N., SWAMINATHAN, M. and SUBRAHMANYAN, V.**  
1957 Effect of insect infestation on stored grain: II. Studies on husked, hand-pounded, milled raw rice and parboiled milled rice. *J. Sci. Fd Agric.*, **8** (9), 512 – 516.
- PINGALE, S.V., RAO, M.N. and SWAMINATHAN, M.**  
1954 Effect of insect infestation on stored wheat. I. Studies on soft wheat. *J. Sci. Fd Agric.*, **5** (1), 51 – 54.
- FIXTON, S.W.** Moisture content – its significance and measurement in stored products. *J. stored Prod. Res.*, **3** (1), 35 – 47.  
1967
- PIXTON, S.W.** A possible rapid method of determining the moisture content of high-moisture grain. *J. Sci. Fd Agric.*, **21** (9), 465 – 467.  
1970
- POINTEL, J-G.** Contribution a la conservation du niébé, du vouandzou, du maïs, des arachides et du sorgho. (Contribution to the preservation of cowpeas, *Voandzeia subterranea* (Bambarra groundnut), maize, groundnuts and sorghum). *Agron. trop.*, Nogent, **23** (9), 982 – 986.  
1968

- POINTEL, J-G.** 1969 Essai et enquête sur greniers à maïs togolais. (A trial and survey on Togolese maize granaries). *Agron. trop.*, Nogent, 24 (8), 709 – 718.
- PRADHAN, S., MOOKHERJEE, P.B. and SHARMA, G.C.** 1965 Pusa bin for grain storage. *Indian Fmg*, 15 (1), 14 – 16.
- PREVETT, P.F.** 1959 A study of rice storage under tropical conditions. *J. agric. Engng Res.*, 4 (3), 243 – 254.
- PREVETT, P.F.** 1964 The distribution of insects in stacks of bagged groundnuts in Northern Nigeria. *Bull. ent. Res.*, 54 (4), 689 – 713.
- QURESHI, Z.A., WILBUR, D.A. and MILLS, R.B.** 1970 Irradiation of early instars of the Angoumois Grain Moth. *J. econ. Ent.*, 63 (4), 1241 – 1247.
- RHYNEHART, T.** 1960 The control of insects infesting groundnuts after harvest in the Gambia: IV. The practical application of control measures. *Trop. Sci.*, 2 (3), 134 – 139.
- ROBERTSON, J.V.** 1968 Trials with small capacity grain silos in Dar es Salaam, Tanzania. *E. Afr. agric. for J.*, 34 (2), 263 – 276.
- ROWLANDS, D.G.** 1967 The metabolism of contact insecticides in stored grains. *Residue Rev.*, 17, 105 – 177.
- SARID, J.N. and KRISHNAMURTHY, K.** 1965 Storage structures for large scale handling and preservation of food grain. *Bull. Grain Tech.*, 3 (2), 62 – 69.
- SARID, J.N. and KRISHNAMURTHY, K.** 1968 Protection of marketable grain. *Bull. Grain Tech.*, 6 (1), 16 – 20.
- SARID, J.N., RAI, L., KRISHNAMURTHY, K. and PINGALE, S.V.** 1965 Studies on the large scale storage of food grains in India. Part II. Studies on the relative suitability of cement concrete and aluminium bins for storing wheat. *Bull. Grain Tech.*, 3 (4), 135 – 141.
- SARID, J.N., RAI, L. and PINGALE, S.V.** 1967 Studies on the large scale storage of food grains in India. Part III. Studies on the insect and temperature fluctuations in bag storage of wheat. *Bull. Grain Tech.*, 5 (1), 3 – 11.
- SODERSTROM, E.L.** 1970 Effectiveness of green electroluminescent lamps for attracting stored-product insects. *J. econ. Ent.*, 63 (3), 726 – 731.
- SOUTHGATE, B.J.** 1965 Plastics films for the bulk storage of food. *Plast. Inst. Trans. & J.*, 33 (103), 11 – 15.
- STRONG, R.G. and LINDGREN, D.L.** 1960 Germination of cereal, sorghum and small legume seeds after fumigation with hydrogen phosphide. *J. econ. Ent.*, 53 (1), 1 – 4.
- STRONG, R.G. and LINDGREN, D.L.** 1961 Effect of methyl bromide and hydrocyanic acid fumigation on the germination of corn seed. *J. econ. Ent.*, 54 (8), 764 – 770.

- SWAINE, G.** Trials on the underground storage of maize of high moisture content in  
1957 Tanganyika. *Bull. ent. Res.*, 48 (2), 397 – 406.
- VENKAT RAO, S., NUGGEHALLI, R.N., PINGALE, S.V., SWAMINATHAN, M. and  
SUBRAHMANYAN, V.**  
1960 Effect of insect infestation on stored field bean (*Dolichos lablab*) and  
black gram (*Phaseolus mungo*). *Fd Sci., Mysore*, 9, 79 – 82.
- VENKAT RAO, S., NUGGEHALLI, R.N., SWAMINATHAN, M., PINGALE, S.V. and  
SUBRAHMANYAN, V.**  
1958 Effect of insect infestation on stored grain: III. Studies on Kaffir corn  
(*Sorghum vulgare*). *J. Sci. Fd Agric.*, 9 (12), 837 – 839.
- WATTERS, F.L.** Effects of grain moisture content on residual toxicity and repellency of  
1959 malathion. *J. econ. Ent.*, 52 (1), 131 – 134.
- WATTERS, F.L.** Physical methods of insect control. *Proc. Ent. Soc. Manitoba*, 21,  
1965 18 – 27.
- WATTERS, F.L.** An appraisal of gamma irradiation for insect control in cereal foods.  
1968 *Manitoba Ent.*, 2, 37–45.
- WILKIN, D.R. and GREEN, A.A.**  
1970 Polythene sacks for the control of insects in grain. *J. stored Prod. Res.*,  
6 (1), 97 – 101.
- WRIGHT, F.N.** New storage, transportation and handling techniques for tropical agricultural  
1965 produce. *Congr. Prot. Cult. trop.*, Marseilles, 1965, pp 93 – 98. Marseilles:  
Chambre de Commerce et d'Industrie.
- WRIGHT, F.N. and SOUTHGATE, B.J.**  
1962 The potential uses of plastics for storage with particular reference to rural  
Africa. *Trop. Sci.*, 4 (2), 74 – 81.

\* \* \* \* \*

## Conversion Tables

Simple methods are given here for converting English and metric units of measurement. Following these is a series of useful conversion tables for units of area, volume, weight, pressure and power.



## LENGTH CONVERSION

The chart in Figure 3 is useful for quick conversion from meters and centimeters to feet and inches, or vice versa. For more accurate results and for distances greater than 3 meters, use either the tables in Figure 2 or the equations.

The chart in Figure 3 has metric divisions of one centimeter to three meters, and English units in inches and feet to ten feet. It is accurate to about plus or minus one centimeter.

Example:

An example will explain how to use the tables. Suppose you wish to find how many inches are equal to 66cm. On the "Centimeters into Inches" table look down the leftmost column to 60cm and then right to the column headed 6cm. This gives the result, 25.984 inches.

FIGURE 1

Equations:

1 inch	=	2.54cm
1 foot	=	30.48cm
	=	0.3048m
1 yard	=	91.44cm
	=	0.9144m
1 mile	=	1.607km
	=	5280 feet
1cm	=	0.3937 inches
1m	=	39.37 inches
	=	3.28 feet
1km	=	0.62137 miles
	=	1000 meters

FIGURE 2

INCHES INTO CENTIMETERS  
(1 in. = 2.539977 cm.)

inches	0	1	2	3	4	5	6	7	8	9
0	cm.	2.54	5.08	7.62	10.16	12.70	15.24	17.78	20.32	22.86
10		25.40	27.94	30.48	33.02	35.56	38.10	40.64	43.18	45.72
20		50.80	53.34	55.88	58.42	60.96	63.50	66.04	68.58	71.12
30		76.20	78.74	81.28	83.82	86.36	88.90	91.44	93.98	96.52
40		101.60	104.14	106.68	109.22	111.76	114.30	116.84	119.38	121.92
50		127.00	129.54	132.08	134.62	137.16	139.70	142.24	144.78	147.32
60		152.40	154.94	157.48	160.02	162.56	165.10	167.64	170.18	172.72
70		177.80	180.34	182.88	185.42	187.96	190.50	193.04	195.58	198.12
80		203.20	205.74	208.28	210.82	213.36	215.90	218.44	220.98	223.52
90		228.60	231.14	233.68	236.22	238.76	241.30	243.84	246.38	248.92

CENTIMETERS INTO INCHES  
(1 cm. = 0.3937 in.)

cm.	0	1	2	3	4	5	6	7	8	9
0	inches	0.394	0.787	1.181	1.575	1.969	2.362	2.756	3.150	3.543
10		3.937	4.331	4.724	5.118	5.512	5.906	6.299	6.693	7.087
20		7.874	8.268	8.661	9.055	9.449	9.843	10.236	10.630	11.024
30		11.811	12.205	12.598	12.992	13.386	13.780	14.173	14.567	14.961
40		15.748	16.142	16.535	16.929	17.323	17.717	18.110	18.504	18.898
50		19.685	20.079	20.472	20.866	21.260	21.654	22.047	22.441	22.835
60		23.622	24.016	24.409	24.803	25.197	25.591	25.984	26.378	26.772
70		27.559	27.953	28.346	28.740	29.134	29.528	29.921	30.315	30.709
80		31.496	31.890	32.283	32.677	33.071	33.465	33.858	34.252	34.646
90		35.433	35.827	36.220	36.614	37.008	37.402	37.795	38.189	38.583

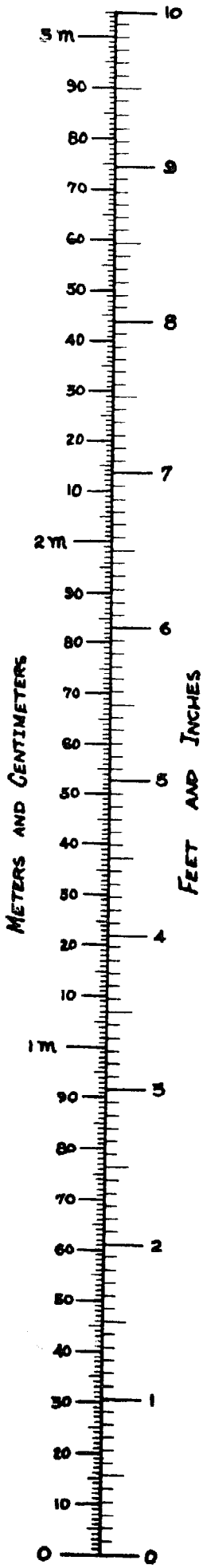

FIGURE 3

**WEIGHT CONVERSION**

The chart in Figure 5 converts pounds and ounces to kilograms and grams or vice versa. For weights greater than ten pounds, or more accurate results, use the tables (Figure 4) or conversion equations. See "Length Conversion," Figure 2, for an example of the use of the tables.

On the chart, notice that there are sixteen divisions for each pound to represent ounces. There are 100 divisions only in the first kilogram, and each division represents ten grams. The chart is accurate to about plus or minus twenty grams.

Equations:

- 1 ounce = 28.35 grams
- 1 pound = 0.4536 kilograms
- 1 gram = 0.03527 ounce
- 1 gram = 2.205 pounds

FIGURE 5

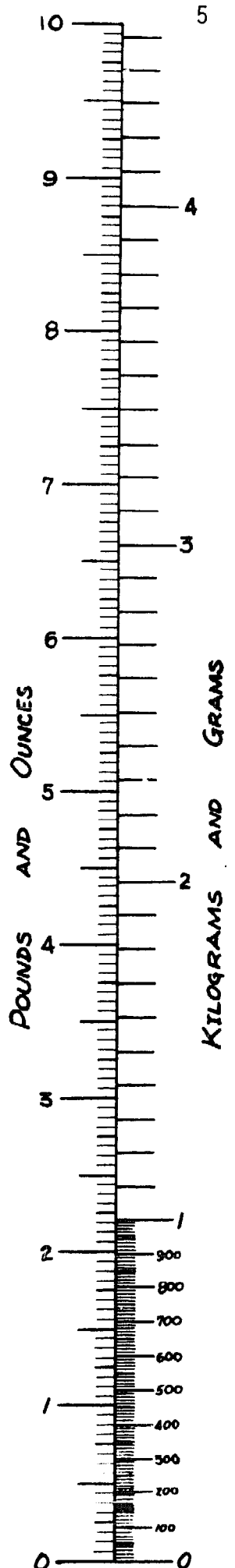

FIGURE 4

KILOGRAMS INTO POUNDS  
(1 kg. = 2.20463 lb.)

kg.	0	1	2	3	4	5	6	7	8	9
0	lb.	2.20	4.41	6.61	8.82	11.02	13.23	15.43	17.64	19.84
10	22.05	24.25	26.46	28.66	30.86	33.07	35.27	37.48	39.68	41.89
20	44.09	46.30	48.50	50.71	52.91	55.12	57.32	59.53	61.73	63.93
30	66.14	68.34	70.55	72.75	74.96	77.16	79.37	81.57	83.78	85.98
40	88.19	90.39	92.59	94.80	97.00	99.21	101.41	103.62	105.82	108.03
50	110.23	112.44	114.64	116.85	119.05	121.25	123.46	125.66	127.87	130.07
60	132.28	134.48	136.69	138.89	141.10	143.30	145.51	147.71	149.91	152.12
70	154.32	156.53	158.73	160.94	163.14	165.35	167.55	169.76	171.96	174.17
80	176.37	178.58	180.78	182.98	185.19	187.39	189.60	191.80	194.01	196.21
90	198.42	200.62	202.83	205.03	207.24	209.44	211.64	213.85	216.05	218.26

POUNDS INTO KILOGRAMS  
(1 lb. = 0.45359 kg.)

lb.	0	1	2	3	4	5	6	7	8	9
0	kg.	0.454	0.907	1.361	1.814	2.268	2.722	3.175	3.629	4.082
10	4.536	4.990	5.443	5.897	6.350	6.804	7.257	7.711	8.165	8.618
20	9.072	9.525	9.979	10.433	10.886	11.340	11.793	12.247	12.701	13.154
30	13.608	14.061	14.515	14.969	15.422	15.876	16.329	16.783	17.237	17.690
40	18.144	18.597	19.051	19.504	19.958	20.412	20.865	21.319	21.772	22.226
50	22.680	23.133	23.587	24.040	24.494	24.948	25.401	25.855	26.308	26.762
60	27.216	27.669	28.123	28.576	29.030	29.484	29.937	30.391	30.844	31.298
70	31.751	32.205	32.659	33.112	33.566	34.019	34.473	34.927	35.380	35.834
80	36.287	36.741	37.195	37.648	38.102	38.555	39.009	39.463	39.916	40.370
90	40.823	41.277	41.730	42.184	42.638	43.091	43.545	43.998	44.452	44.906

FIGURE 1

## TEMPERATURE CONVERSION

The chart in Figure 1 is useful for quick conversion from degrees Celsius (Centigrade) to degrees Fahrenheit and vice versa. Although the chart is fast and handy, you must use the equations below if your answer must be accurate to within one degree.

Equations:

$$\text{Degrees Celsius} = \frac{5}{9} \times (\text{Degrees Fahrenheit} - 32)$$

$$\text{Degrees Fahrenheit} = 1.8 \times (\text{Degrees Celsius}) + 32$$

Example:

This example may help to clarify the use of the equations; 72F equals how many degrees Celsius?

$$72F = \frac{5}{9} (\text{Degrees F} - 32)$$

$$72F = \frac{5}{9} (72 - 32)$$

$$72F = \frac{5}{9} (40)$$

$$72F = 22.2C$$

Notice that the chart reads 22C, an error of about 0.2C.

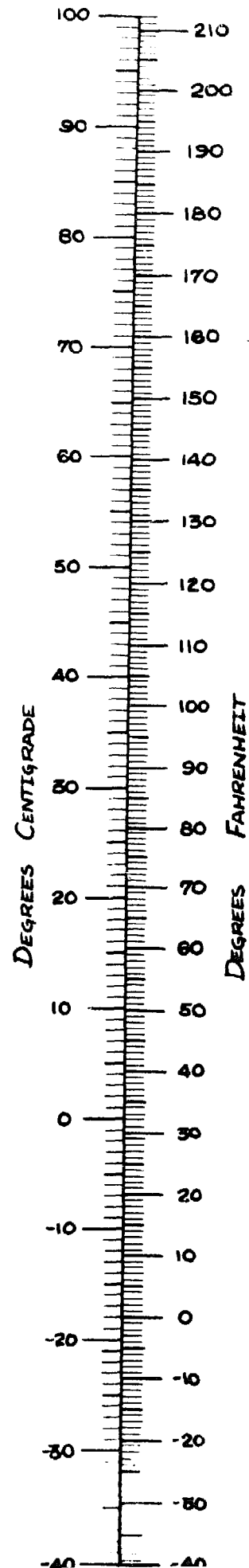

## Conversion Tables

### Units of Area

1 Square Mile	= 640 Acres	= 2.5899 Square Kilometers
1 Square Kilometer	= 1,000,000 Square Meters	= 0.3861 Square Mile
1 Acre	= 43,560 Square Feet	
1 Square Foot	= 144 Square Inches	= 0.0929 Square Meter
1 Square Inch	= 6.452 Square Centimeters	
1 Square Meter	= 10.764 Square Feet	
1 Square Centimeter	= 0.155 Square Inch	

### Units of Volume

1.0 Cubic Foot	= 1728 Cubic Inches	= 7.48 U.S. Gallons
1.0 British Imperial Gallon	= 1.2 U.S. Gallons	
1.0 Cubic Meter	= 35.314 Cubic Feet	= 264.2 U.S. Gallons
1.0 Liter	= 1000 Cubic Centimeters	= 0.2642 U.S. Gallons

### Units of Weight

1.0 Metric Ton	= 1000 Kilograms	= 2204.6 Pounds
1.0 Kilogram	= 1000 Grams	= 2.2046 Pounds
1.0 Short Ton	= 2000 Pounds	

## Conversion Tables

### Units of Pressure

1.0 Pound per square inch	= 144 Pounds per square foot
1.0 Pound per square inch	= 27.7 Inches of Water*
1.0 Pound per square inch	= 2.31 Feet of Water*
1.0 Pound per square inch	= 2.042 Inches of Mercury*
1.0 Atmosphere	= 14.7 Pounds per square inch (PSI)
1.0 Atmosphere	= 33.95 Feet of Water
1.0 Foot of Water = 0.433 PSI	= 62.355 Pounds per square foot
1.0 Kilogram per square centimeter	= 14.223 Pounds per square inch
1.0 Pound per square inch	= 0.0703 Kilogram per square centimeter

\* at 62 degrees Fahrenheit (16.6 degrees Celsius)

### Units of Power

1.0 Horsepower (English)	= 746 Watts = 0.746 Kilowatt (KW)
1.0 Horsepower (English)	= 550 Foot Pounds per second
1.0 Horsepower (English)	= 33,000 Foot Pounds per minute
1.0 Kilowatt (KW) = 1000 Watts	= 1.34 Horsepower (HP) English
1.0 Horsepower (English)	= 1.0139 Metric Horsepower (cheval-vapeur)
1.0 Metric Horsepower	= 75 Meters X Kilogram/Second
1.0 Metric Horsepower	= 0.736 Kilowatt = 736 Watts