

**AT** MICROFICHE  
REFERENCE  
LIBRARY

A project of Volunteers in Asia

How to Make a Solar Cabinet Dryer for Agricultural  
Produce

Published by:

Brace Research Institute  
MacDonald College  
McGill University  
Ste. Anne de Bellevue 800  
Quebec, Canada H9X 1C0

Paper copies are \$ 1.50.

Available from:

Brace Research Institute  
MacDonald College  
McGill University  
Ste. Anne de Bellevue 800  
Quebec, Canada H9X 1C0

Reproduced by permission of the Brace Research  
Institute.

Reproduction of this microfiche document in any  
form is subject to the same restrictions as those  
of the original document.

McGill University  
Faculty of Engineering  
BRACE RESEARCH INSTITUTE

# How To Make A SOLAR CABINET DRYER FOR AGRICULTURAL PRODUCE

Do-it-Yourself Leaflet No. L-6

March, 1965

Revised March, 1973

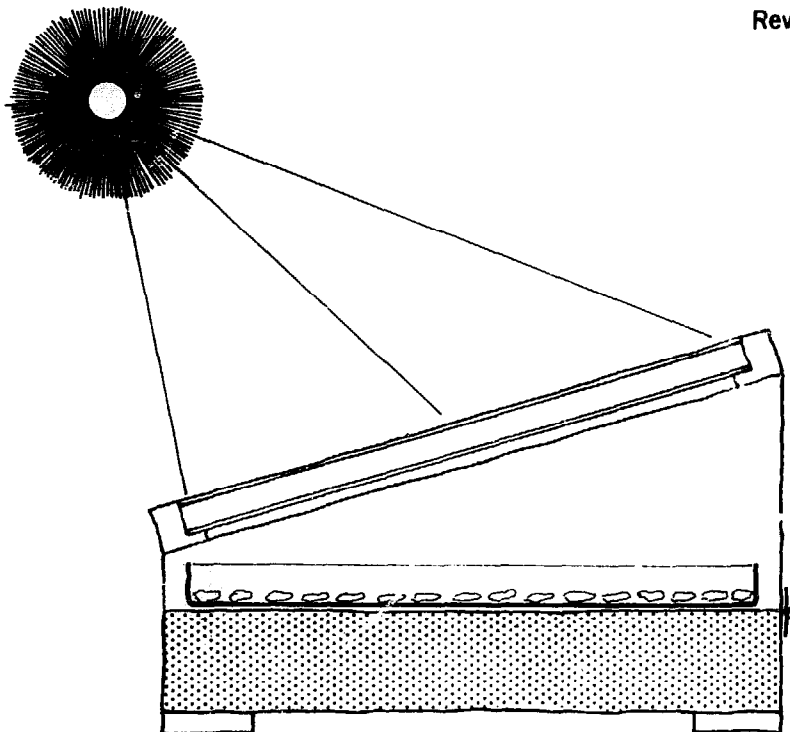

BRACE RESEARCH INSTITUTE  
MACDONALD COLLEGE OF MCGILL UNIVERSITY  
STE. ANNE DE BELLEVUE 800  
QUEBEC, CANADA

## Introduction

The solar drying of agricultural produce is extensively practised in most parts of the world. It has found special significance among the rural populations living in Mediterranean type climates. These areas are characterized by dry warm summers which make drying particularly attractive for the preservation of agricultural surpluses for the winter season. Traditional natural sun drying techniques take advantage of the clear, warm, often rainless summer days. Material is laid directly on the ground or upon smooth surfaces, such as rooftops, and turned manually until dry. Unfortunately this natural dehydration process is subject to contamination from the following sources:

- (a) Airborne dust and blown debris
- (b) Insect infestation
- (c) Animal and human interference

To reduce this contamination and improve product quality, it is essential that the drying matter be enclosed and dehydrated under cover. In addition, sun drying methods cannot often either effectively or evenly reduce moisture contents to the low levels required. This frequently results in a improperly dried material, which cannot be stored for a satisfactory length of time. In order to counteract these difficulties while still using solar energy, the development has been undertaken of a simple solar cabinet dryer.

## Description

The dryer is essentially a solar hot box, in which fruit, vegetables or other matter can be dehydrated. In essence it consists of a rectangular container, insulated at its base and preferably at the sides, and covered with a double-layered transparent roof. Solar radiation is transmitted through the roof and absorbed on the blackened interior surfaces. Owing to the insulation, the internal temperature is raised. Holes are drilled through the base to induce fresh ventilating air into the cabinet. Outlet ports are located on the upper parts of the cabinet side and rear panels. As the temperature increases, warm air passes out of these upper apertures by natural convection creating a partial vacuum and inducing fresh air up through the base. As a result there is a constant perceptible flow of air over the drying matter, which is placed on perforated trays on the interior cabinet base.

## Method of Construction

There are many forms which the construction of such a dryer can take. Nevertheless, the following general recommendations can be applied to all dryers of this type: (see Figs. No. 1 and 2).

- (1) the length of the cabinet should be at least three times the width so as to minimize the shading effect of the side panels.

- (2) the angle of the slope of the roof covering should be taken from Fig. No. 3. This gives the optimum angle for drying seasons as a function of the latitude. The graph is equally applicable to areas north and south of the equator.
- (3) the transparent cover should be made from two layers of either of the following:
  - (a) Glass panes (18 oz. or 2 mm. thick)
  - (b) Plastic film (about 0.005 inch thick)

In general, the covers made with plastic film have a limited life. It is therefore necessary to use films which have been treated to give protection against ultra-violet radiation. The latter can be polyester, polyvinyl chloride or polyethylene. Generally films of the polyethylene for cellulose acetate types should not be used due to their limited life. They would have to be replaced at the end of each drying season and might not give as favourable results in service. Although it may be advantageous to replace covers seasonally in certain cases, trouble may occur with films not being able to withstand the high cabinet temperatures generated. These may reach as high as 80 to 100 degrees centigrade in some dryers. We would advise people interested in this type of unit to adapt ordinary window glass, supported by a suitable frame to their installations. The use of a sealant to hold it to the frame is a possibility, but if a sealant is not used, the glass should be held firmly in place by a suitable frame, painted black.

- (4) In general, the framework of the cabinet may be constructed as follows:
  - (a) Portable Models: wood, metal, hardboard, plywood for the more sophisticated units; or basketwork, wicker or bamboo for the more primitive units. Perforated cabinet bases and side panels might possibly be fabricated by placing insulation between layers of blackened wicker or open basketwork. This would cut down costs and make use of local industry.
  - (b) Permanent Structures: adobe, brick, stone or concrete.
- (5) The insulation should consist of locally available materials such as wood shavings, sawdust, bagasse, coconut fibre, reject wool or animal hair. In areas affected by wood ants, termites or other noxious insects, the susceptible materials should be properly protected before being placed in the insulation base.
- (6) The hot box should be constructed along the lines outlined in Figs. No. 1 and 2. The insulating layers should be at least 2 inches (5 cm.) thick, both for the base and side sections. Holes should be drilled in the insulated base and fitted with short lengths of plastic and rubberized garden hose (or bamboo, etc., if available). Where insect infestation is

- prevalent, all cabinet apertures should be covered with fine mosquito netting, (preferably fibreglass) or gauze. Generally the high temperature of the cabinet interior discourages insects, rodents, etc., from entering and feeding on the drying produce. Furthermore, in arid areas where there is a high concentration of airborne dust and debris, the transparent cover eliminates product contamination.
- (7) The transparent cover can be attached to a frame which can then be fixed to the chassis of the cabinet. Care must be taken to assure that the cover is completely watertight so as to avoid deterioration of the interior and wetting of the insulation. All components of the cover framework should be painted black or some other convenient dark colour to absorb the maximum solar radiation. Hold down strips should be secured to the upper exterior rim of the cover frame to protect the film against excessive wind suction lift.
  - (8) Once the cover and chassis are secured, several holes should be drilled in the rear and side panels. These provide the exit ventilation ports to remove the warm, moist air. The number of holes is dependant on the climatic conditions and the nature of the drying material. A satisfactory method is to initiate the dryer in the springtime, with a minimum of side ventilation ports and to continue drilling holes so as just to prevent internal moisture condensation. This system prevents an excess of ventilation ports being drilled.
  - (9) The rear panel should be fitted with access doors to give entry into the cabinet. All doors should be placed on the rear side to prevent excessive shadowing of the dryer during handling operations.
  - (10) Trays should be constructed as indicated, of galvanized chickenwire or some similar material. They should be placed on runners a few centimetres high so as to ensure a reasonable level of air circulation under and around the drying material.
  - (11) The interior of the cabinet should be painted black. The exteriors of the side, rear and base panels should be painted with aluminum paint. If desired, the interiors of the side and rear panels can be covered with a layer of aluminum foil. If the latter is not available, paint these surfaces black.

#### Operation of the Dryer

The dryer operation is not complicated. The produce to be dried should be pretreated in the usual manner (i.e. blanched and fumigated) and placed on the perforated trays, at a loading rate of about 1.5 lbs./ft.<sup>2</sup> (7.5 kgs/meter<sup>2</sup>) of drying area. A small thermometer inserted into one of the ventilation ports will prove very handy. The thermometer bulb should be shielded from the direct rays of the sun. The upper temperature limits which can be withstood by agricultural produce vary substantially.

Where the matter might suffer from the direct sun-rays or where the light colour of the produce reflects much of the incident radiation, it is advisable to cover the loaded trays in the dryer with a black plastic

mesh or black gauze. This should not inhibit the flow of air through the trays, but will absorb the radiation and transmit the heat to the produce through conduction and convection. The resultant temperature increase can be controlled by opening the rear access doors. This approximate temperature control system can easily be mastered with time and experience.

The following table gives some indication of the temperature limits and possible throughputs available with a dryer of the size and specifications shown in this pamphlet. The table should hold for dry, arid, cloudless Mediterranean type climates. The yields should be suitably modified for the cloudy, more humid temperate and tropical regimes.

### Capital Costs

The following tables outline the materials required for the construction of a small solar cabinet dryer and the costs involved. Labour costs were obtained from estimates given by local (Barbados) carpenters. It is interesting to note that a large proportion of the materials required are locally available in developing countries. This cuts down on expense and foreign exchange. An evaluation of a similar unit in Damascus, Syria, where the initial development work was undertaken, showed a total cost of \$14.00 (U.S.) as compared with \$23.00 (U.S.) for Barbados. In each case the labour costs were identical. However more of the materials required are manufactured locally in Syria resulting in a lower materials cost. Experiences in India and Africa show that this type of dryer can be constructed for the same price.

### Operating Costs

The amount of annual maintenance on the dryer is small, consisting mainly of keeping the transparent covers and interior of the cabinet clean. The unit could perhaps be repainted annually; however, this is not expensive. In humid tropical climates, assume the total life of a plastic covered unit as 5 years.

Therefore the operating costs are as follows:

	Cost/Year \$U.S.
Depreciation of Dryer	4.65
Annual Maintenance Costs	0.59
Interest on Capital Investment (6%)	1.35
Contingencies (5%)	0.30
Annual Operating Costs	<u>\$ 6.89</u>

This represents an operating cost of \$0.60 (U.S.) per square foot of drying area. Again when contrasted with a similar study in Syria, the operating cost there was about \$0.30 (U.S.) per square foot. If a

glass cover were to be used, a longer life duration might be expected. In general, the use of the dryer results in an average production cost increase of 5%.

#### Notes

In some cases it is preferable to have a plastic cover rather than a glass cover, to prevent breakage by flying stones, etc. However, the glass would normally have a longer life so that, in the final analysis, the farmer himself must decide which is the more economical. Presumably if the dryer were placed on a building roof, the glass might last 10 to 20 years without breakage.

With regard to labour costs, it must be stressed that all the construction to be undertaken is quite simple and could be performed easily by the farmer himself using simple hand tools. This would reduce the financial outlay of the farmer by about 25%.

A very practical auxiliary application of the dryer is for warming foods and other materials. It is particularly advantageous as a self-contained source of heat at 70-80 degrees Centigrade in the field and in isolated farm areas.

#### Enquiries

Additional information can be obtained from our report No. T.85 which is a production drawing for the solar cabinet dryer, and is available from the address below for a cost of \$2.00.

Enquiries and requests for additional copies of this leaflet should be addressed to:

The Director  
Brace Research Institute  
Macdonald College of McGill University  
Ste. Anne de Bellevue  
Québec H9X 3M1  
Canada

---

Other leaflets available:	Price
L-1 - How to Make a Solar Still (plastic covered)	\$1.25
L-2 - How to Make a Solar Steam Cooker	\$1.25
L-3 - How to Heat your Swimming Pool using Solar Energy	\$0.25
L-4 - How to Build a Solar Water Heater	\$1.25
L-5 - How to Construct a Cheap Wind Machine for Pumping Water	\$1.25
L-5F- French version of L-5	\$0.75
L-6 - How to Make a Solar Cabinet Dryer for Agricultural Produce	\$1.25
L-7 - Arabic Translation of L-6	\$1.25
L-8 - Spanish Translation of L-6	\$1.25
L-9 - French Translation of L-6	\$1.25
T-17- Simple Solar Still for the Production of Distilled Water*	\$1.25

Please remit payment with money order or add \$0.25 to your cheque for bank handling charges.

\* Also available in French, Arabic and Spanish

SOLAR CABINET DRYER

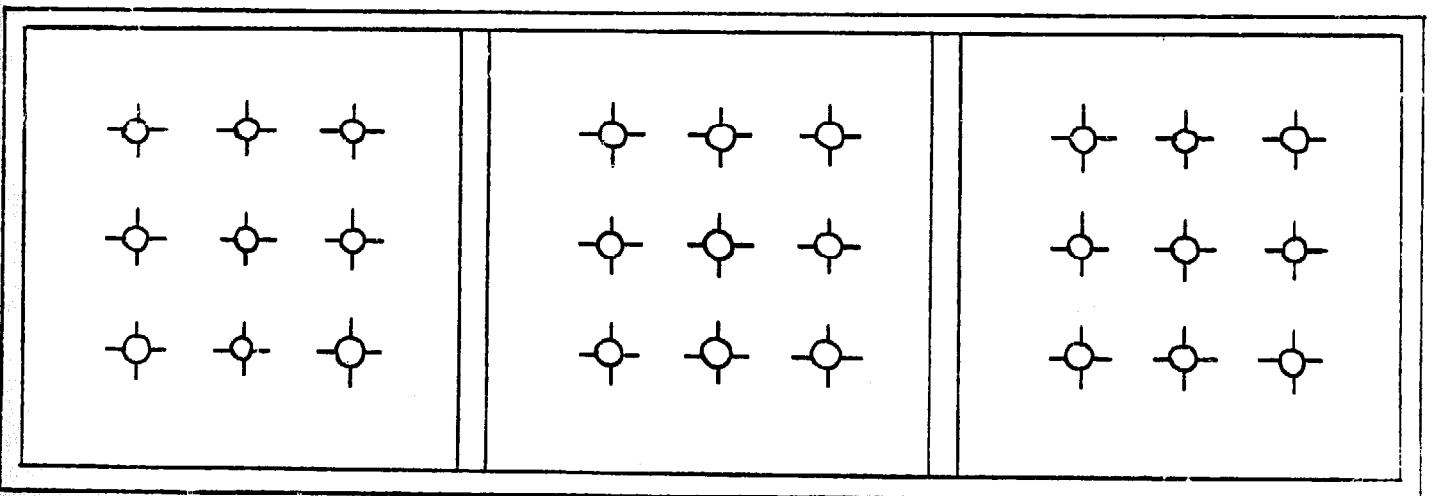
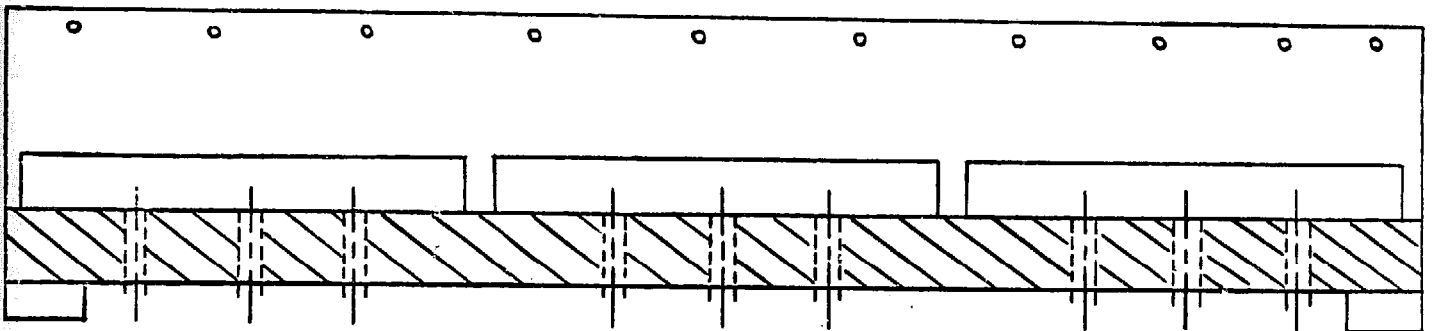
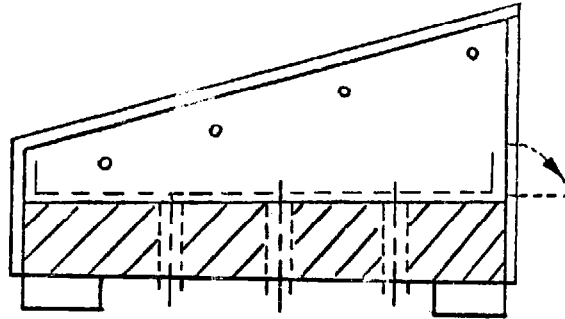
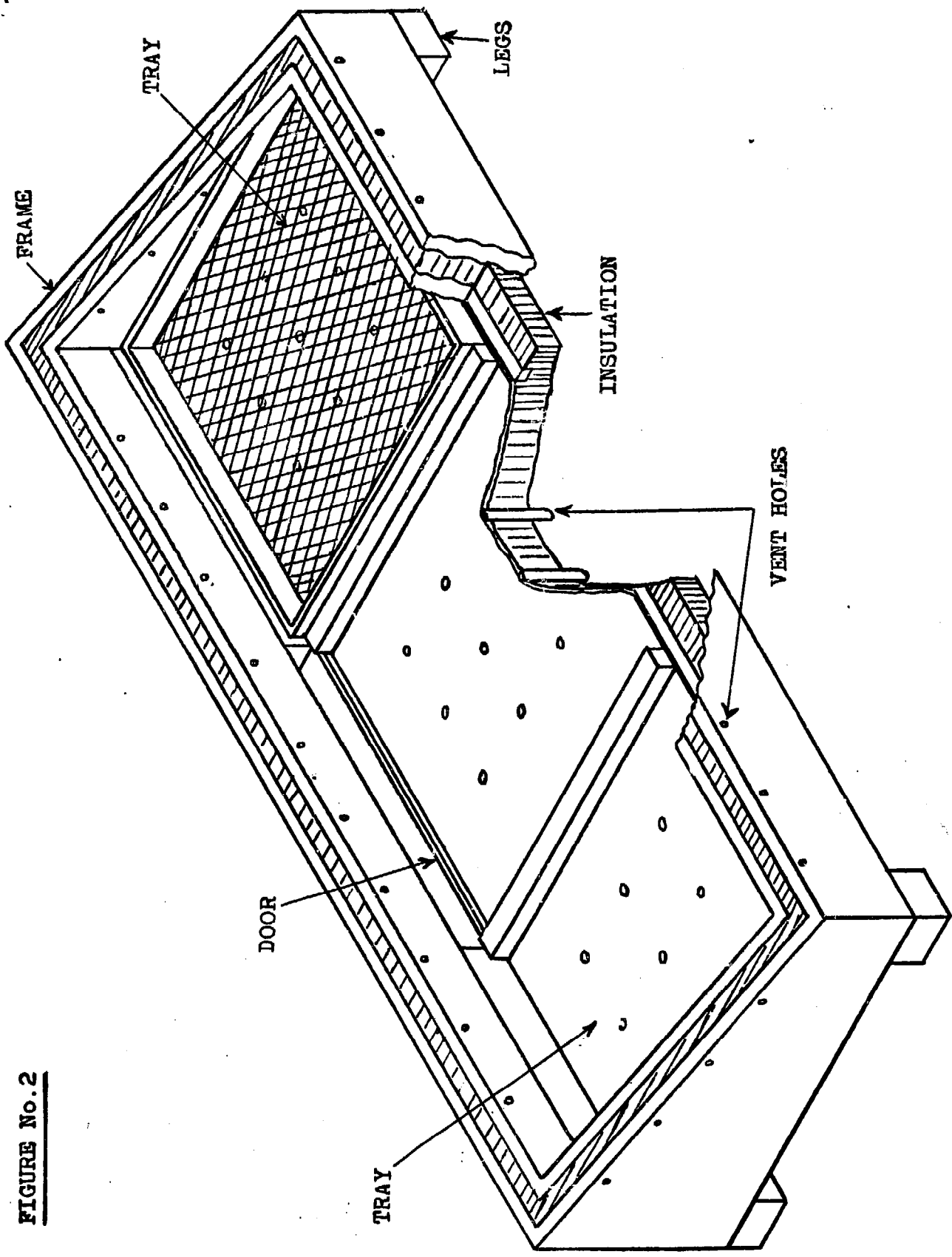

Figure No. 1      Scale    1 mm = 1 cm





**FIGURE No. 2**

# Angle of Slope of Dryer Cover

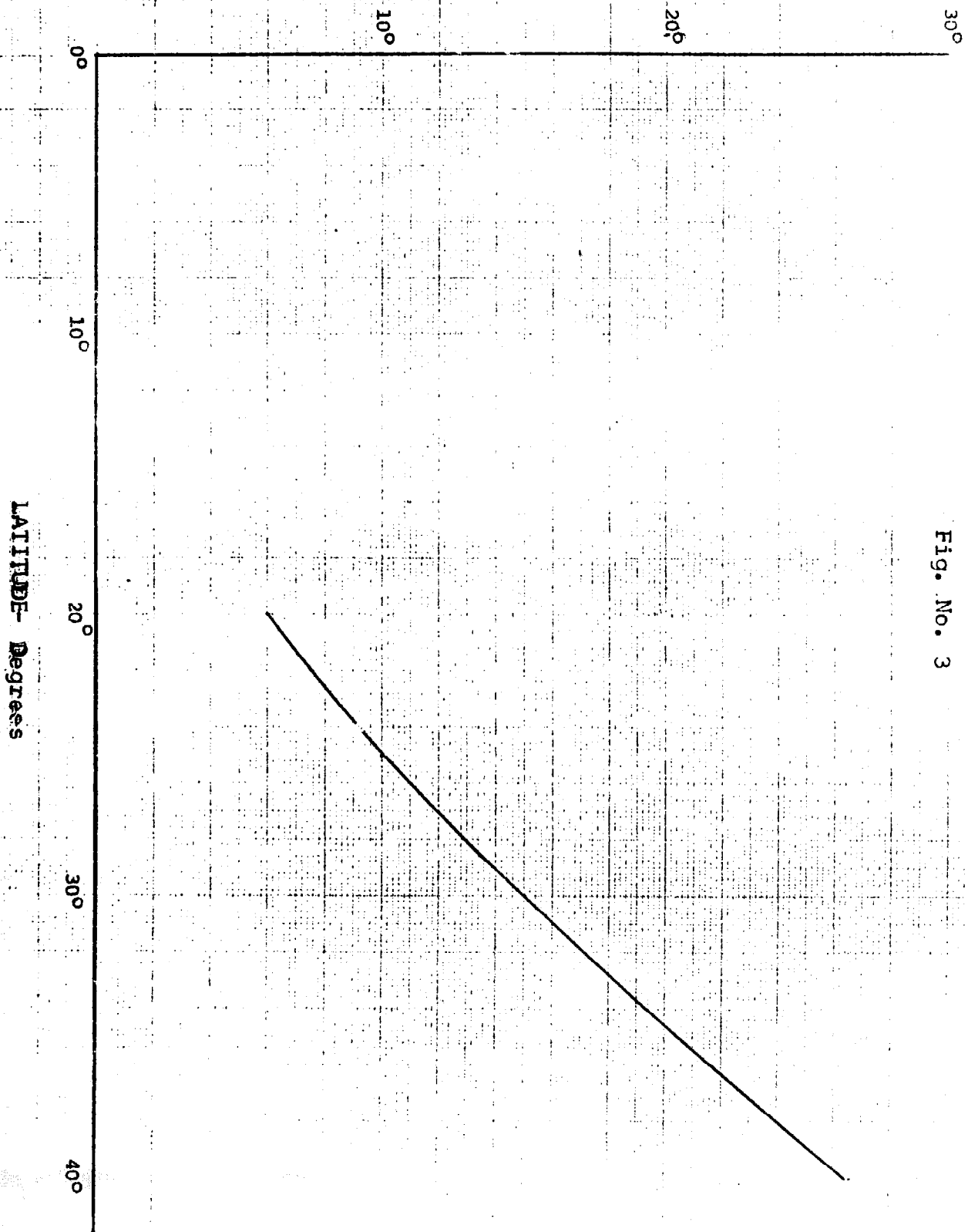

Fig. No. 3

LIST OF MATERIALS AND LABOUR COSTS FOR  
THE CONSTRUCTION OF A SOLAR CABINET DRYER

Item	Function	Number of pieces required	Dimensions (Centimeters)	Unit Cost	Total Cost \$U.S.
1. Glass	Transparent Glazing	4	96 cm x 69 cm (2mm thick) (18 oz. glass)	\$0.18/ft. <sup>2</sup>	\$5.15
2. Wood	See attached sheet				\$5.68
3. Hose	Bottom air ventilation	25	1/4 in. diameter 11 cm long (polyethylene)	\$0.12/ft.	\$1.30
4. Hinges	Rear doors	6	3 cm	\$0.10 each pair	\$0.30
5. Wood Shavings	To insulate under drying cabinet	-	to fill voids as indicated in drawings		NIL
6. Masonite Sheet	to frame cabinet	2	193 cm x 62 cm (1/8" thick)	\$0.06/ft. <sup>2</sup>	\$1.50
7. Aluminum Foil	internal cabinet reflectors	3	1 x 193 cm x 30 cm 2 x 62 cm x 28 cm	\$0.015/ft. <sup>2</sup>	\$0.15
8. Galvanized Chicken Wire	drying trays	3	60 cm x 60 cm (Maximum opening mesh = 1.5 cm)	\$0.065/ft. <sup>2</sup>	\$0.75
TOTAL MATERIALS COST =					\$14.83
With Glass Cover					
Materials Cost					
Add 10% for miscellaneous costs (to cover cost of paint, nails, screws, etc.)					
Total Material Cost					
Total Labour Cost					
Total Cost of Dryer					

(or about \$1.80 U.S. per foot squared by drying area)

\$14.83  
\$ 1.48 U.S.  
\$16.31 U.S.  
\$ 5.00 U.S.  
\$21.31 U.S.

WOODEN COMPONENTS USED IN CONSTRUCTION OF A SOLAR CABINET DRYER

Item and Function	No. of pieces required	Dimensions (in. cm.)	Volume of Wood cm <sup>3</sup>
1. Rear-Panel-with provision for inlet doors	1	193 x 37 x 2	14300
2. Side Panels	2	$\frac{66}{2} (37 + 17) \times 2$	7100
3. Front Panel	1	193 x 17 x 2	6450
4. Legs-to support a few centimetres off the ground	4	20 x 10 x 2	1600
5. Framework Braces-Internal	2	66 x 2 x 2	530
6. Cabinet floor supports-Internal	2	193 x 2 x 1	800
	2	62 x 2 x 1	250
7. Tray Runners-External-on cabinet floor	2	62 x 2 x 1	250
	2	62 x 4 x 1	500
8. Tray Steps-atop central cabinet runners (external)	2	62 x 2 x 1	250
9. Internal Glazing retaining strips	2	193 x 2 x 2	1550
	2	69 x 2 x 2	560
10. External Glazing retaining strips	2	193 x 2 x 1	800
	2	69 x 2 x 1	280
11. Tray Frames; eight per tray	24	60 x 4 x 1.3	7500
<b>TOTAL:</b>	<b>52</b>		<b>42720 cm<sup>3</sup></b>

Note: All wood listed is white pine, costs \$2.70 U.S. per cubic foot

Total: Cost of wood = 42720 x 2.70 = \$4.07 U.S.

28320

Add 10% for cutting loss \$ .41 U.S.

Total cost of cutting and preparing wood \$1.20 U.S.

Total Cost of Wood Members: \$5.68 U.S.

Produce	Amount Of Fresh Matter Dried per Unit Time	Maximum Allowable Temperature
Apricots	4.0 Kgs (8.8 lbs) per two days	150°F (66°C)
Garlic	2.6 Kgs (5.7 lbs) per two days	140°F (60°C)
Grapes	5.7 Kgs (12.6 lbs) per four days	190°F (88°C)
Okra	3.0 Kgs (6.6 lbs) per two days	150°F (63°C)
Onions	3.0 Kgs (6.6 lbs) per two days	160°F (71°C)

## Background Information on the Brace Research Institute

Brace Research Institute of McGill University was founded in 1959 to develop equipment and techniques for making dry lands available and economically useful for agricultural purposes. The Institute has concentrated on the problems effecting individuals or small communities in rural areas and is one of the few organizations with this basic objective.

In general, equipment developed by this Institute utilizes as many local resources as possible, whether human, energy or material, so that the technology can be easily adapted to the local environment. As a result, the Institute has concentrated on utilizing solar and wind energy as well as simple desalination systems, specifically concentrating on the problems that face isolated rural populations in developing arid areas.

Instructional manuals are available describing the use of solar energy for the

- (1) heating of water for domestic and commercial use
- (2) cooking of food
- (3) drying of agricultural produce
- (4) desalination of water for human, animal and agricultural use.

The adaptation of simple greenhouses combined with solar desalination systems for the production of food and water in arid areas is also being developed.

In addition, simple windmills for the production of electricity and the pumping of water have been developed.

Further inquiries should be directed to the

Brace Research Institute,  
Macdonald College of McGill University,  
Ste. Anne de Bellevue  
Québec, Canada  
HOA 1C0

**AT** MICROFICHE  
REFERENCE  
LIBRARY

A project of Volunteers in Asia

Solar Cabinet Dryer

Production Drawing

Published by:

Brace Research Institute  
MacDonald College  
McGill University  
Ste. Anne de Bellevue 800  
Quebec, Canada H9X 1C0

Paper copies are \$ 2.50.

Available from:

Brace Research Institute  
MacDonald College  
McGill University  
Ste. Anne de Bellevue 800  
Quebec, Canada H9X 1C0

Reproduced by permission of the Brace Research  
Institute, McGill University.

Reproduction of this microfiche document in any  
form is subject to the same restrictions as those  
of the original document.

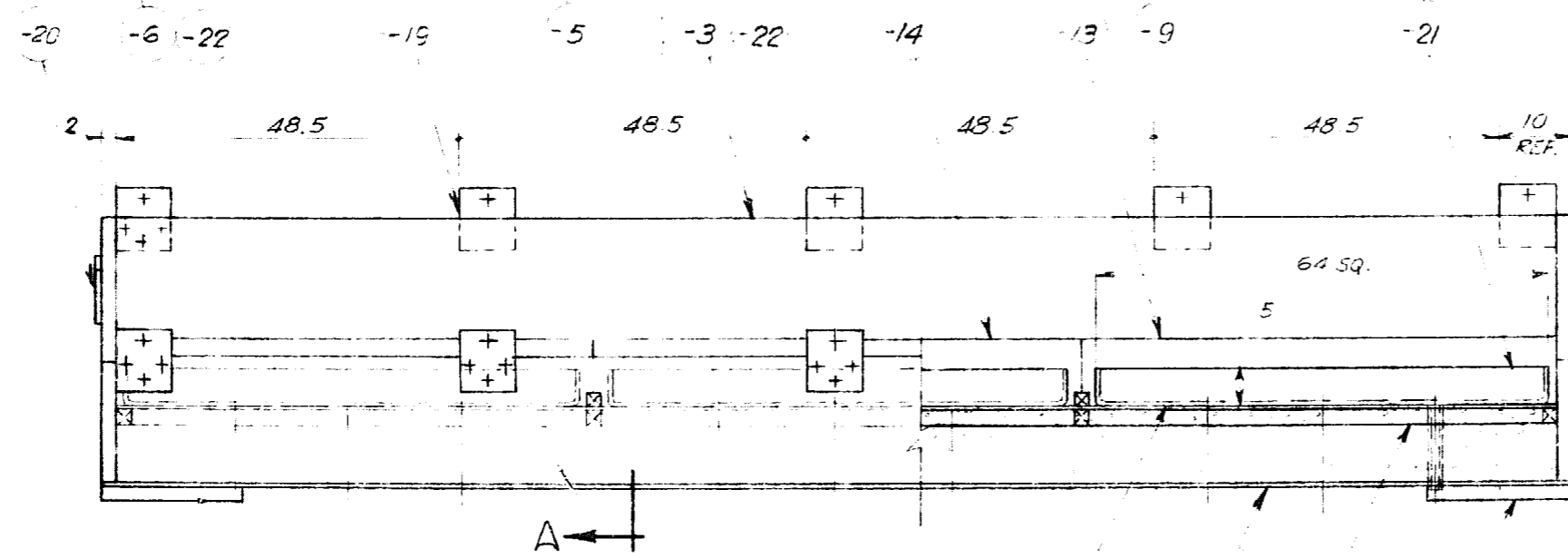
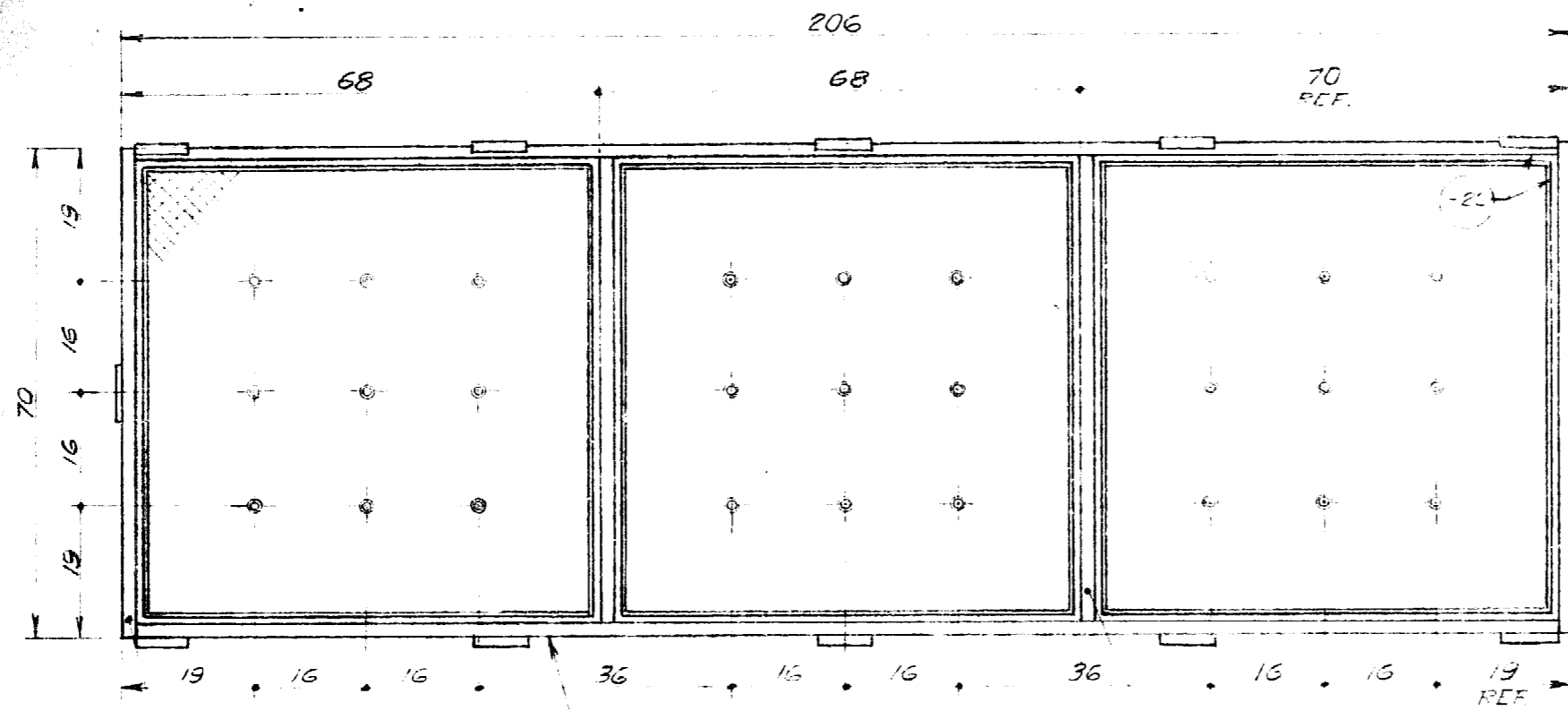

-1 CABINET ASSY  
 -2 ASSY. OMITTED  
 SCALE 1:8

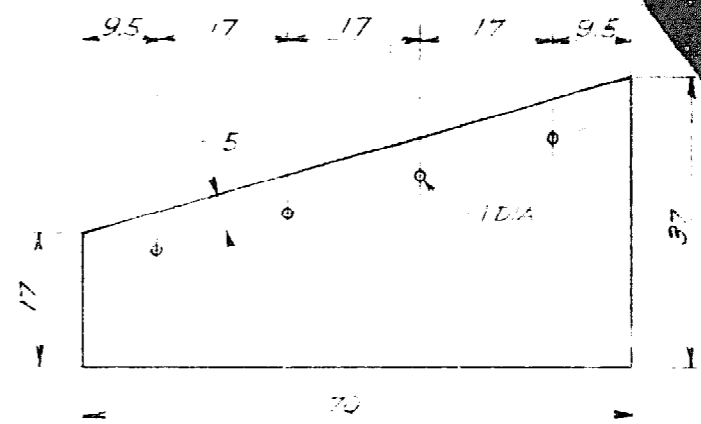

DETAIL -6

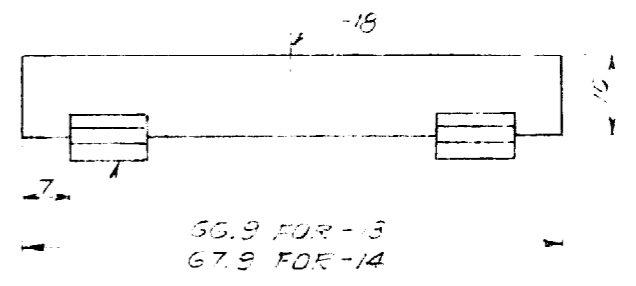

DETAILS -13 -14

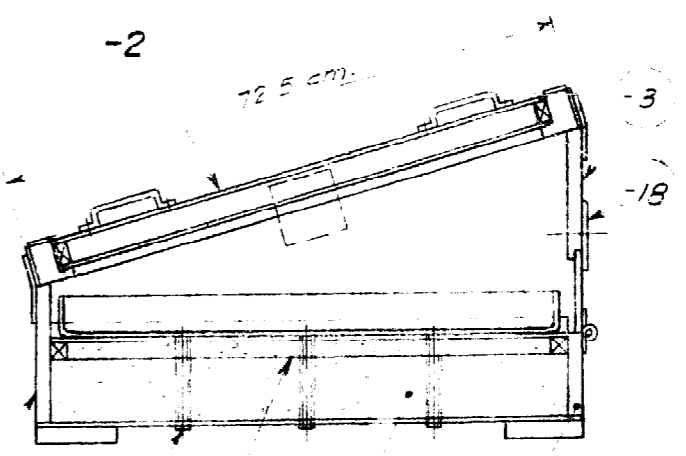

SECTION A



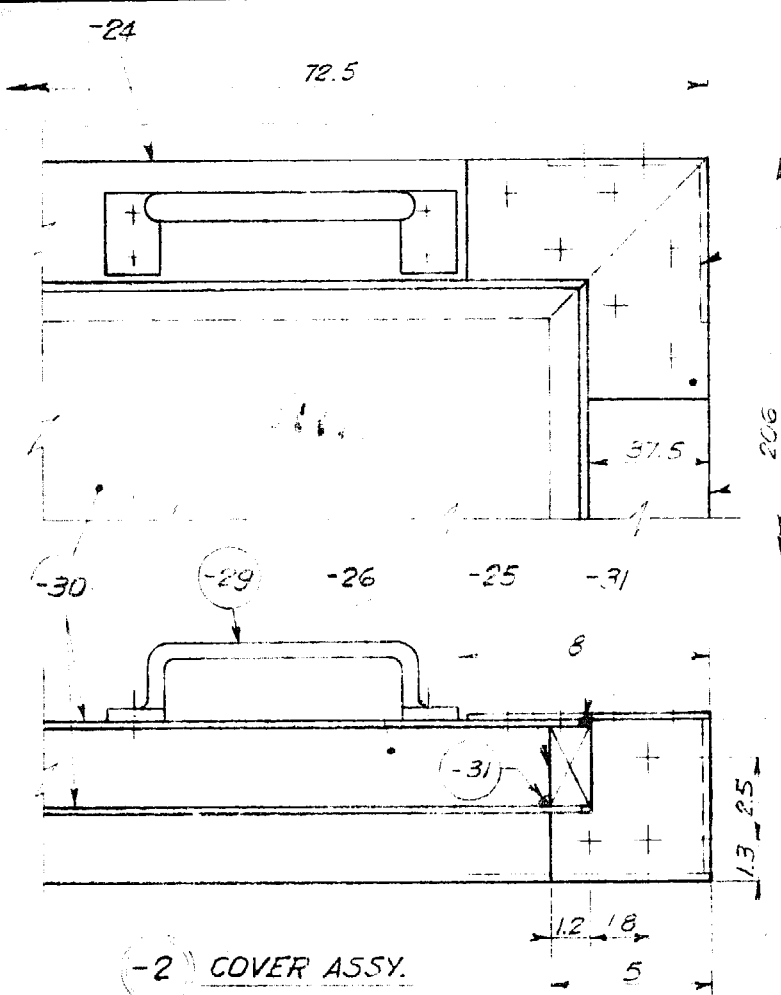

-2 COVER ASSY.  
SCALE 1:2

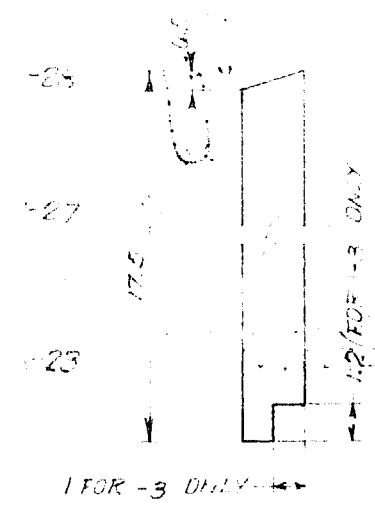

DETAILS -3 -5  
SCALE 1:2

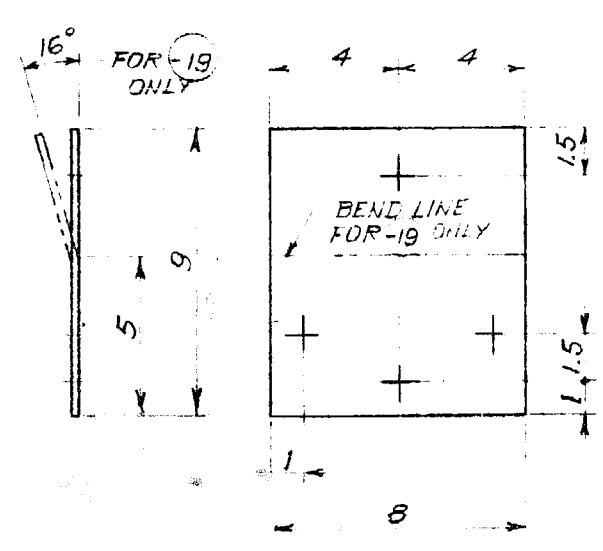

DETAILS -19  
SCALE 1:2

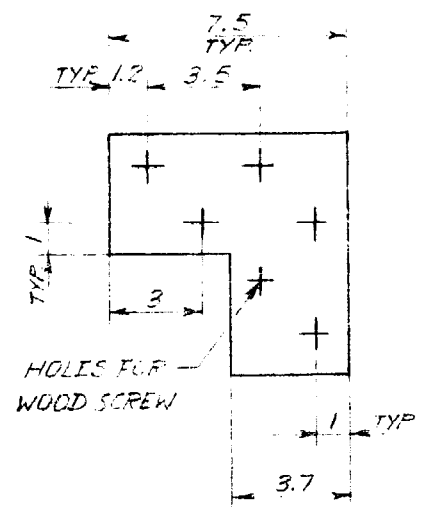

DETAIL -27  
SCALE 1:2

	31	SEALANT				
2	30	GLASS	2 mm THK. (13 OZ)	197.5 x 64.4 cm		2
4	29	HANDLE				4
4	28	REINFORCING CORNER	STEEL	4.5 x 10 LG.		4
4	27	REINFORCING PLATE	STEEL	7.5 x 7.5 x 0.2 cm		4
2	26	GLASS SPACER	WOOD	55 x 2.5 x 1.25 cm		2
2	25	GLASS SPACER	WOOD	198.5 x 2.5 x 1.25 cm		2
2	24	FRAME ELEMENT	WOOD	72.5 x 5 x 5 cm		2
2	23	FRAME ELEMENT	WOOD	206 x 5 x 5 cm		2
	22	INTERNAL CABINET REFLECTORS	ALUM. FOIL	DIFF. TO FIT		
3	21	TRAY-MESH 1.5 cm.	GALV. WIRE	74 x 74 cm		3
2	20	SUPPORT	STEEL PLATE	9 x 9 x 0.2 cm		2
10	19	SUPPORT	STEEL PLATE	9 x 9 x 0.2 cm		10
3	18	TWIST LATCH				3
6	17	HINGE		7 TO 10 cm LG.		6
27	16	HOSE AIR VENTILATION	POLYETHYLENE	1.3 DIA x 11 cm.		27
1	15	INSULATION	SEE TEXT	1.4 TO FIT		1
1	14	DOOR	WOOD	67.5 x 10 x 1 cm		1
2	13	DOOR	WOOD	66.9 x 10 x 1 cm		2
4	12	LEG	WOOD	20 x 10 x 2 cm		4
1	11	SHEET	MASONITE	202 x 56 x 0.3 cm		
1	10	SHEET	MASONITE	206 x 70 x 0.3 cm		1
2	9	TRAY RUNNERS	WOOD	66 x 2 x 2 cm		2
4	8	FRAME ELEMENT	WOOD	62 x 2 x 2 cm		4
2	7	FRAME ELEMENT	WOOD	202 x 2 x 2 cm		2
2	6	SIDE PANEL	WOOD	70 x 37 x 2 cm		2
1	5	FRONT PANEL	WOOD	202 x 17.5 x 2 cm		
1	4	REAR PANEL	WOOD	202 x 10.5 x 2 cm		1
1	3	REAR PANEL	WOOD	202 x 17.5 x 2 cm		1
	2	COVER ASSY.				1
	1	CABINET ASSY.				1
	ITEM	DESCRIPTION	MATERIAL	DIMENSION		TOTAL QTY.

C-6-033-2  
C-6-033-1

**BRACE RESEARCH INSTITUTE  
OF MCGILL UNIVERSITY**

**MACDONALD CAMPUS  
STE. ANNE DE BELLEVUE  
P.Q., CANADA**

SOLAR CABINET DRYER

SCALE AS NOTED

DRAWN	O. G.	OCT. 1972
CHECKED		
ASSEMBLY		
DWG. No.		

C-6-033