

AT MICROFICHE REFERENCE LIBRARY

A project of Volunteers in Asia

Construction of a Brick Hot Air Copra Drier

by: S. Mason.

Published by:

Department of Works and Supply

P.O. Box 1108

Boroko

Papua New Guinea

A limited number of copies are available free to serious groups.

Available from:

Department of Works and Supply

P.O. Box 1108

Boroko

Papua New Guinea

Reproduced by permission of the Department of Works and Supply, Papua New Guinea.

Reproduction of this microfiche document in any form is subject to the same restrictions as those of the original document.

**CONSTRUCTION OF A BRICK
HOT AIR COPRA DRIER**

PAPUA NEW GUINEA

DEPARTMENT OF PUBLIC WORKS

BUILDING RESEARCH STATION

TECHNICAL BULLETIN No. 9, JULY, 1972.

CONSTRUCTION OF A BRICK
HOT AIR COPRA DRIER

PAPUA NEW GUINEA
DEPARTMENT OF PUBLIC WORKS
BUILDING RESEARCH STATION

TECHNICAL BULLETIN NO. 9 JULY 1972

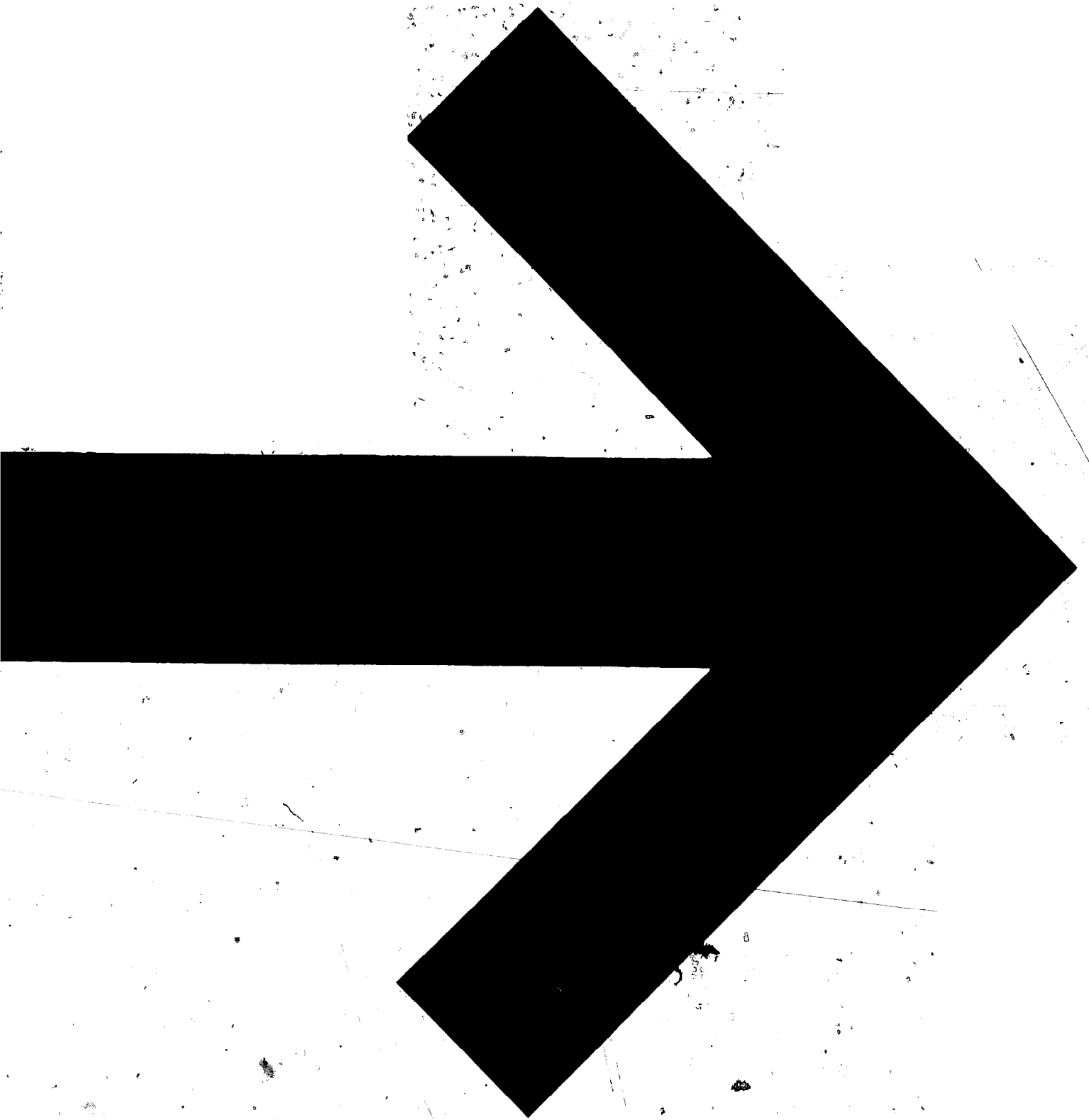

	PAGE
INTRODUCTION	1
ACKNOWLEDGEMENT	2
DESCRIPTION OF COPRA DRIER	3
TECHNICAL TERMS	4-5
CONSTRUCTION OF COPRA DRIER	6-15
MATERIALS LIST	16-18
LOADING AND DRYING	19-20
APPENDIX "A" PLAN	21-27
APPENDIX "B" WOODEN MOULDS	28-29

INTRODUCTION

Following a number of fires which destroyed bush material copra driers in areas with a proven brickmaking potential, a decision was made to develop a permanent material copra drier, in collaboration with the Department of Agriculture Stock and Fisheries.

A brick drier with an output of six 155 pound bags per week was designed to meet this requirement.

The purpose of this Bulletin is to assist the Indigenous copra grower who has had no experience in construction work, to construct his own drier; so that a better quality copra can be produced more economically.

Technical Bulletin No. 5 "Selection of Materials for Stabilised Brick Manufacture" should be studied to assist in selecting materials suitable to make bricks.

For a community effort the purchase of a brick machine is recommended and Technical Bulletin No. 6 "Manufacture of Stabilised Bricks Using Ramming Action Brick Machine" should be studied.

For individual Driers wooden brick moulds would be sufficient. See Appendix "B".

Bulletin compiled by,
S. MASON,
Senior Technical Officer

T.M. CROTTY,
DIRECTOR,
DEPARTMENT OF PUBLIC WORKS,
P.O. BOX 1108,
BOROKO.
PAPUA NEW GUINEA.

ACKNOWLEDGEMENT

Assistance rendered by the officers from D.A.S.F. Station Kapagere in testing the prototype drier is acknowledged; especially the comprehensive reporting and loading technique suggested by Mr. S.J. Hoare which has been included in the Bulletin.

DESCRIPTION OF DRIER

The drier consists of a brick building with a minimum of timber exposed in areas subject to the heated air flow from the firebox.

Fuel such as timber or coconut shells is fed into the firebox situated at the front of the drier. The heat from the fire warms a mild steel radiating plate on the hot air chamber which in turn heats the air within the drier.

Exhaust gases and smoke escape through a vertical flue at the rear of the drier. The flue incorporates a damper which is adjusted to maintain a temperature of 140-150°F within the drier.

A working area is provided and consists of a covered platform projecting from the front of the drier and may be constructed using round or milled timber. The platform is used during loading and unloading operations and doubles as an area on which the copra cools prior to bagging.

The flow of air in and out of the drier is controlled by a series of vents at the base and top of the walls.

Trays or shelves to hold the copra in the drier, are timber framed and covered with A.R.C. fabric and copra wire. (The fabric is to support the weight of the drying copra). These trays are located on projected brickwork.



TECHNICAL TERMS

GAUGE ROD is a length of timber on which the height of each brick course is marked.

A COURSE of brickwork is one row of bricks laid on a bed of mortar.

MORTAR is a composition of sand/cement/or sand/lime/cement mixed with water to a consistency of soft butter. (See Page 14 for proportions).

PROFILE is a wooden frame consisting of three uprights driven into the ground supporting two horizontal rails at right angles to each other and placed at a predetermined level on which the dimensions of the building are marked. These are placed adjacent to each corner of the building.

LUG is a piece of hoop iron bent at right angles. One leg is attached to a frame by screws or clouts and the other leg is built into the bed joint of the brickwork.

BED JOINT is the layer of mortar upon which the brick is laid.

FLUE is an opening, in this case formed by bricks, through which air flows.

DAMPER a piece of flat iron which can be moved in and out of a flue to control the flow of air.

PIN is a length of mild steel rod driven into the ground, the height of which indicates the depth of the concrete.

PEG is a length of 2" x 1" or 2" x 2" timber performing the same function as a pin.

TOP PLATE a length of timber fixed on top of the wall to which the roof is attached.

POLE PLATE a length of timber fixed to the side of the building as a supporting member.

PRECAST CONCRETE SLAB is a slab of concrete made with a conventional mixture of 4 parts gravel, 2 parts sand to 1 part cement and formed in a wooden mould and placed in position at a later date.

CONSTRUCTION OF THE DRIER

GAUGE ROD

A SMALL GAUGE representing one course and one joint is made out of a piece of timber with two nails driven through the timber 3 3/8" apart, equating one 3" brick plus a 3/8" bed joint.

With this small gauge a GAUGE ROD is marked out on a piece of 2" x 1" timber approximately 16 feet long. 9" is marked off at the bottom representing the depth of the concrete footing, then with the small gauge, the consecutive courses for the length of the rod are marked.

A light saw cut is made at each mark to ensure that they will not be erased. The courses are numbered and variations are marked on the rod in accordance with the plan, for example where bolts are built in the brickwork to carry the top plate for the roof and the bearer for the working platform; projections for the drying trays, height of the firebox and the loading and unloading door. This eliminates continual reference to the plan.

A smaller rod ~~is~~ approximately 15 courses is made on which the concrete footing depth is also shown. This saves continual handling of the heavier rod when checking the height of brickwork and depth of footings.

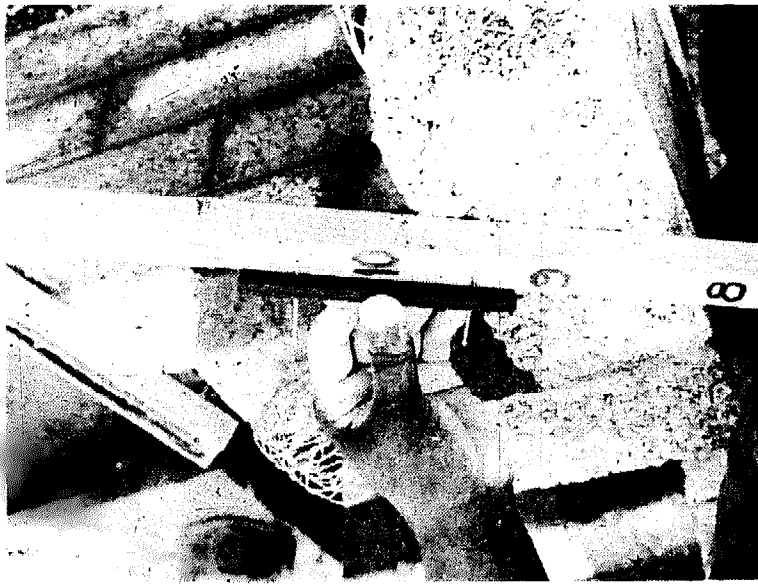

SETTING OUT

A site is chosen which is reasonably level and not subject to flooding.

From the plan a peg is set in the ground at the location of each corner of the building profiles are then erected 2 feet outside this line of pegs, one course above ground level.

On the horizontal member of the profile external dimensions of the walls are marked. A line is strung at these marks and checked for squareness by measuring the diagonals, and if equal, the building is square.

On either side of the wall line mark the position of the footings and transfer the line to this mark and immediately below the line break the ground with a pick to indicate the area to be excavated.



EXCAVATOR

Excavate the footings to a depth of 5 courses plus the depth of the concrete, by measuring with the gauge rod from the line strung between the profiles.

After all excavations are complete the section marked concrete is cut off the gauge rod.

The rod is held level to the line at the same course (5) when checking the excavations and a steel pin or wooden peg is driven into the ground until the top is level with the bottom of the gauge rod. These pins or pegs should be removed before the concrete hardens.

Reinforcing rods, 3/8" diameter of mild steel round are placed in the foundations and when covered by concrete, the minimum distance of the rods from the bottom and sides of the trench is two (2) inches.

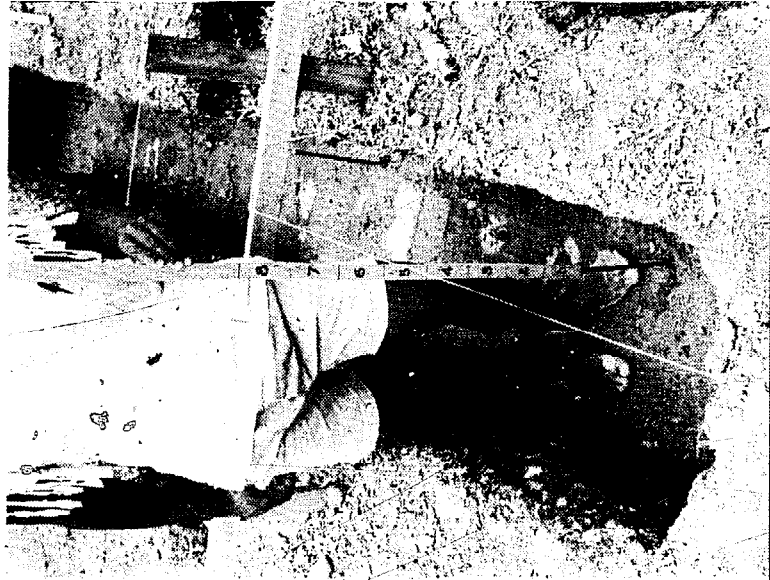

CONCRETOR

Concrete for the footings is generally mixed in the proportions of four parts aggregate, two parts sand to one part cement.

These proportions may have to be changed in various areas to suit the material which is available.

It may be found that river gravel when stockpiled has a sufficient quantity of sand without the addition of further fines.

In other cases it may be necessary to segregate the gravel and sand and regauge to achieve a well graded mix.

When the aggregate and cement have been thoroughly mixed, only sufficient water should be added and thoroughly mixed through the aggregate to make a workable mix, which would be similar to very soft butter.

For individuals unfamiliar with working concrete, advice should be sought from other persons in the area who have had this experience.

BRICKLAYER

String the line on the profile corresponding to the outside of the building and transfer it on to the concrete by holding the level against the line and steadying it with a short length of timber. Mark the concrete at the base of the level ensuring that it is marked on the side that is touching the line. This is done at the corners and along each side. Form up the Brickwork in the four corners. The rest of the brickwork is laid between these corners.

Build the brickwork up to one course above the profile level and place a nail in the bed joint at each corner level with the profile. The rod can then rest on the nails when checking the gauge.

At this level backfill against the brickwork and dismantle the profiles.

Courses in relation to the pin from the top of the concrete footing, are cut off the longer gauge rod.

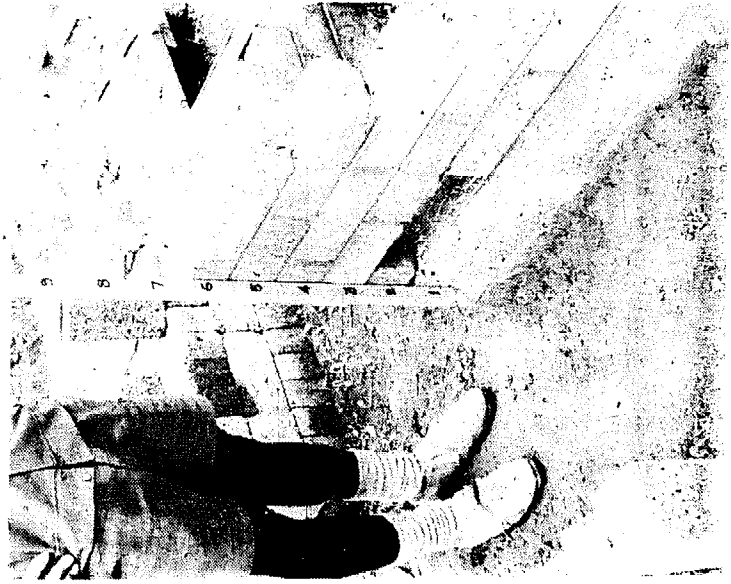
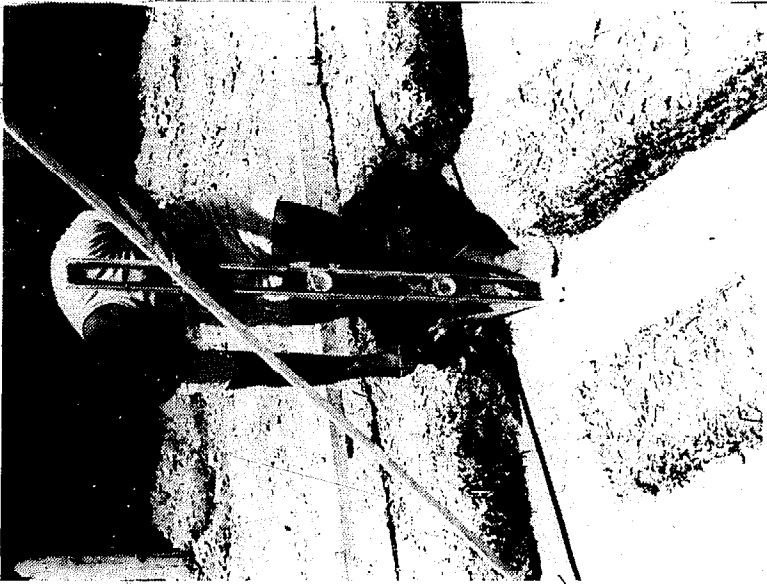

Three 3/8" diameter mild steel rods are placed across the top of the firebox opening to support the front wall.

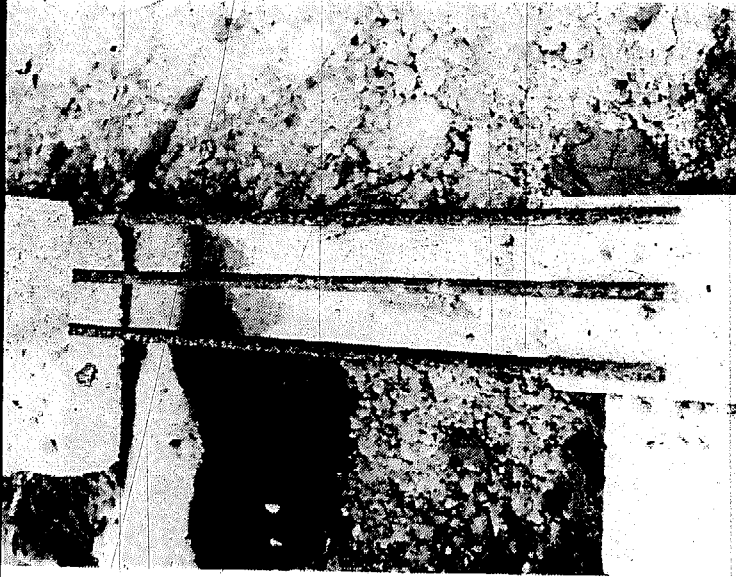

The loading and unloading door of the drier is attached to a wooden frame held in position by hoop iron lugs built into the brickwork at intervals. The top of the frame finishes in line with the top of the brickwork at the front, on which the top plate rests.

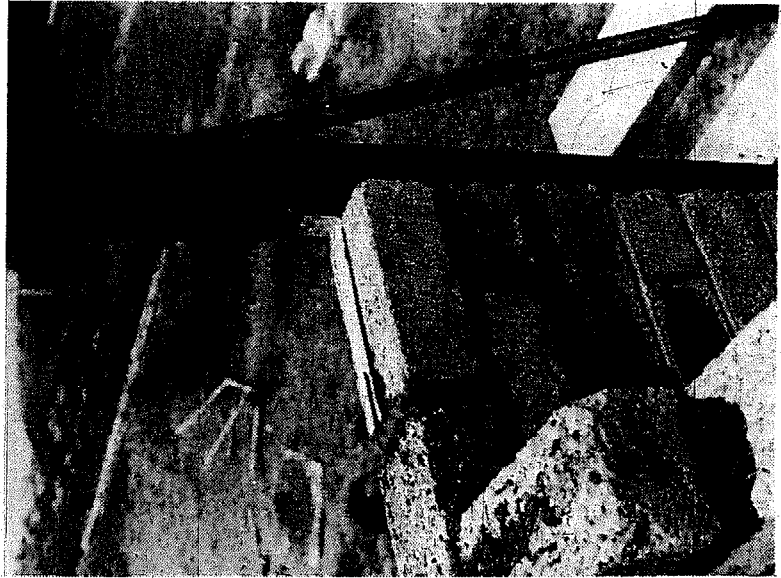

Openings near the base on each side admit cool air through a brick duct to a hot plate.



A hot plate of 3/8" mild steel plate is positioned over the hot air chamber on a bed of clay. Clay is packed along the sides and joined to prevent smoke contaminating the copra.



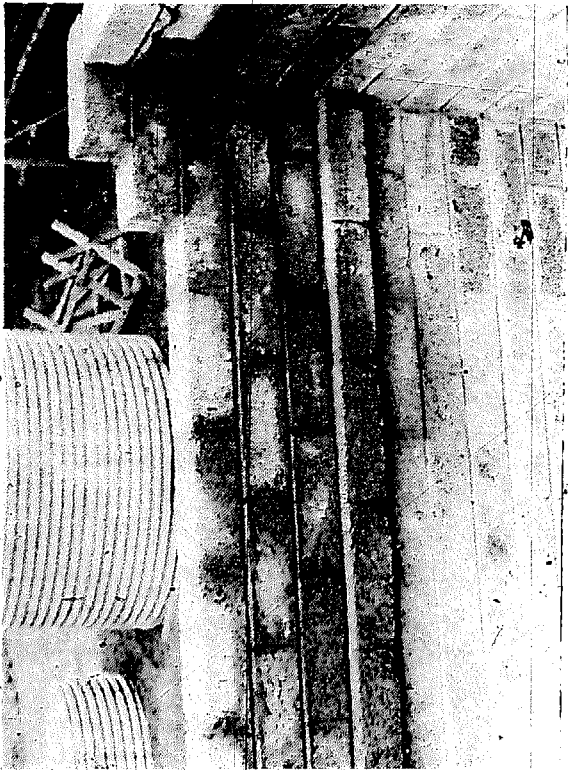

To support the drying trays bricks are projected at three levels on the two side walls.

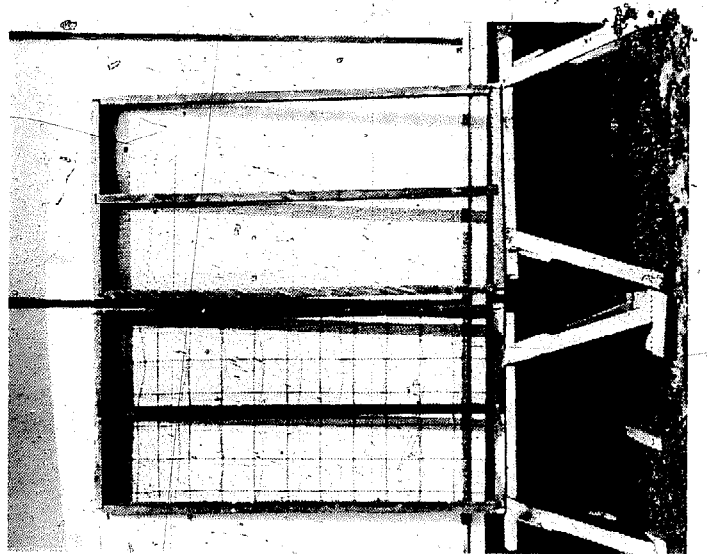

Bolts or mild steel rods are placed in the bed joint of the last course at the back of the drier, thus supporting the pole plate to which the roof sheeting is nailed.

Similar bolts or rods are placed between the firebox and door to hold the pole plate to support the working area platform.

The flue extends up past the roof 8 courses and incorporates an adjustable damper approximately 3 feet from the ground. A concrete cover is placed on top to stop water entering the flue.

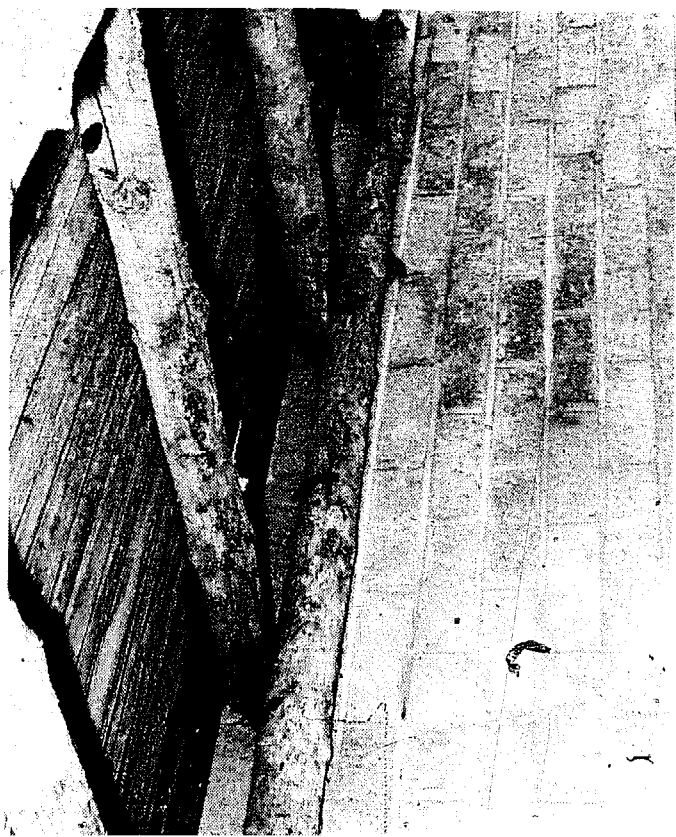
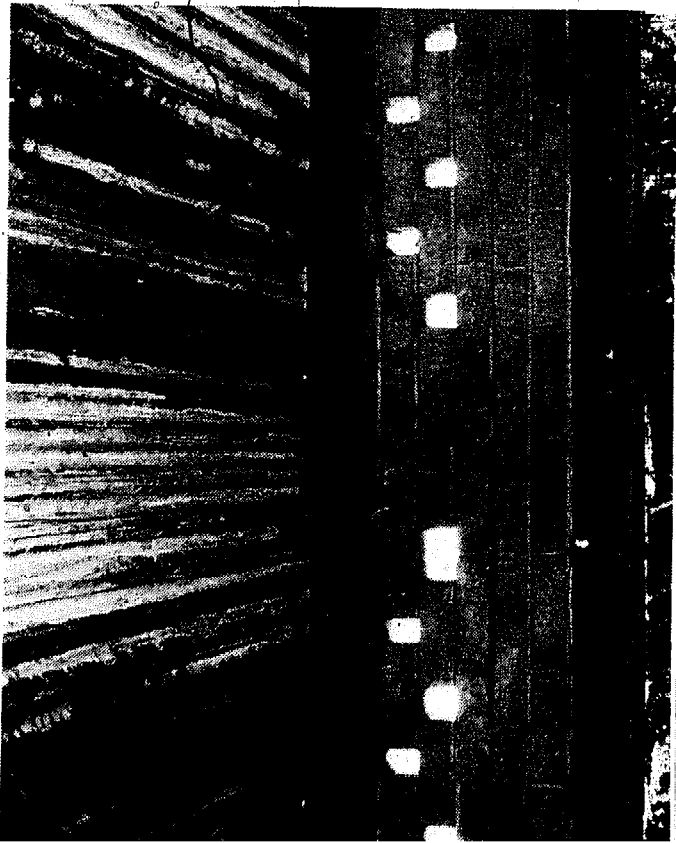

The plan shows a mixture of round and milled timber in the construction of the roof and working area. Round timber can be used where sawn timber is shown, but it is recommended that sawn timber be used on the drying trays, door and door frame.

The drier can be constructed on a brick or concrete footing. A brick footing is recommended if material for concrete is not readily available.

As most of the sands in the Territory are harsh to use, some additive is required to make a workable mortar mix.

Suggested mortar mixes are 6 parts fine sand, 1 part cement, 1 part lime; or 4 parts fine sand, 1 part cement mixed with water containing an egg-cup full of TEEPOL to 4 gallons of water.

The ideal material is a loamy sand which when mixed with cement and water is easily worked.

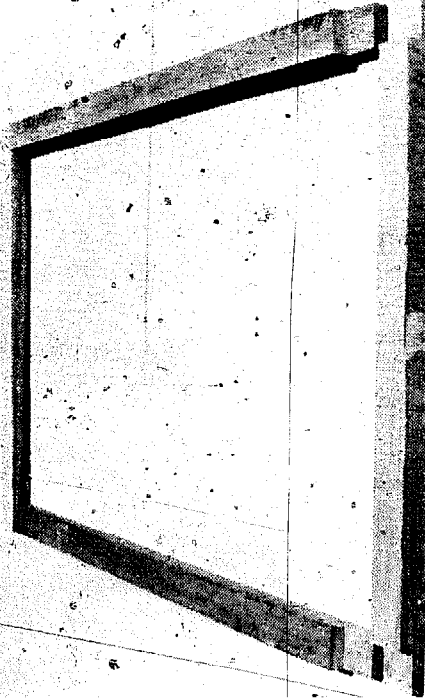

MATERIALS LIST

Several types of material can be used to make the bricks for the drier, such as; gravel, graded sands, gravel/sand, coronus (friable coral) and soft graded limestone.

Material for 2,000 bricks required to construct the drier.

Aggregate 10 cubic yards.
Cement 20 bags.

Materials for Door Frame

3" x 2" - 2/6' taken from gauge rod, courses 20 to 41.
2/4' to suit 5 bricks plus joints.

Hoop iron straps

1 1/4" x 16g x 12" - 6 only.

Materials for Door

3" x 2" - 2/6' to suit door frame.
3/4' to suit door frame.

6' x 3' galv. flat iron 26g. - 2 sheets.

10' galv. T. Hinges - 1 pair.

Materials for Trays

3" x 2" - 18/7'
12/3'

1/2" Copra wire 3' wide - 42 lin. ft.
A.R.C. Fabric 6' wide - 21 lin. ft.

MATERIALS LIST (Cont'd)

Concrete Footings

Aggregate 7/8" - 2 cub. yds.
Sand - 1 cub. yd.
Cement - 12 Bags
M.S.P. 3/8" - 160 Lin. Ft.

Materials for Working Area

4" x 4" uprights - 3/12'
2/13'
4/6'
4" x 3" bearers - 3/13' one a pole plate
4" x 2" joists - 7/9'
5" x 2" top plate - 1/16' front working area.
3" x 2" top plate - 1/16' above door.
5" x 2" pole plate - 1/7' back brick wall.
6" x 1" decking - 18/13'
4" x 2" bracing - 4/5'

Materials for Steps

5" x 2" stringers - 2/4'
4" x 2" treads - 3/3'

MATERIALS LIST (Cont'd)

Precast Concrete Slab for Firebox

Aggregate 7/8" - 3. cub. yds.
Sand - 1.5 cub. yds.
Cement - 1 Bag
A.R.C. Mesh - 12 Sq. ft.

Materials for Roof

Corrugated Galv. Iron - 6/10 sheets
3/8" sheets

Miscellaneous

Steel Plate Flat 3/8" - 6'3" x 2'6" Hot Plate
Steel Plate Flat 3/8" - 0'9" x 1'0" Damper

LOADING AND DRYING

The maximum initial charge of freshly skinned and broken half nuts that should be placed on the lower tray is 4 copra sacks of average size which when inverted on the tray and lined, make 3 layers of half nuts.

If more than 4 bags are put on the lower tray the movement of hot air rising from the steel heating plate is restricted and results in the lower level of half nuts becoming scorched.

The production sequence using 3 trays is shown on the following page.

To make the drying economical once firing has commenced it should be continued until all nuts are dried, as intermittent drying causes a wastage of fuel.

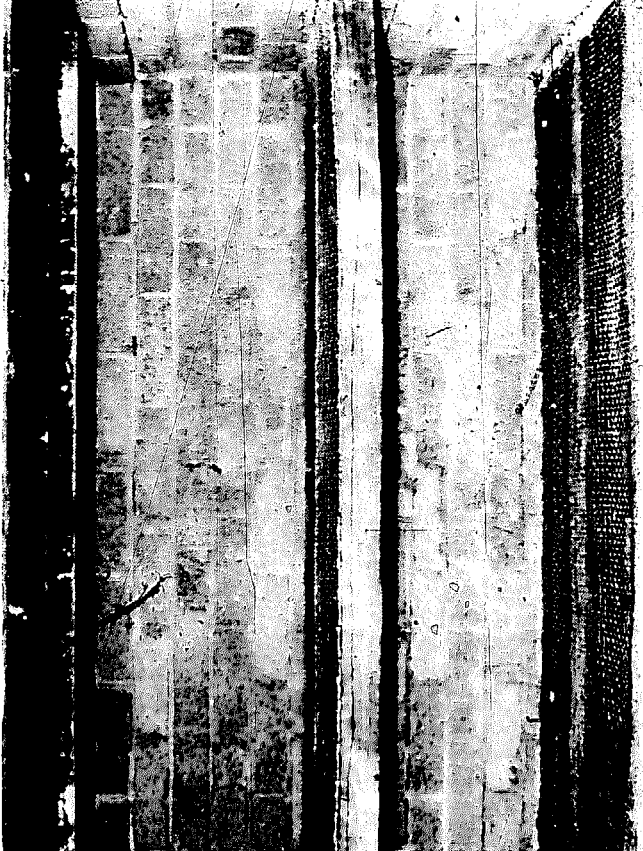

The following sequence is suggested:

Monday A.M. Commence firing

Monday P.M. Charge with 4 bags of half nuts and place on lower shelf.

Tuesday A.M. Continue firing

Tuesday P.M. Continue firing

Wednesday A.M. Remove shells and place copra on centre shelf to continue drying process.

Wednesday P.M. Continue firing

Thursday A.M. Continue firing

Thursday P.M. Continue firing, second batch from first tray shelled and placed on second shelf after having moved the first batch to the top shelf.

Friday A.M. Continue firing, first batch should be finished and removed to cool-before bagging.

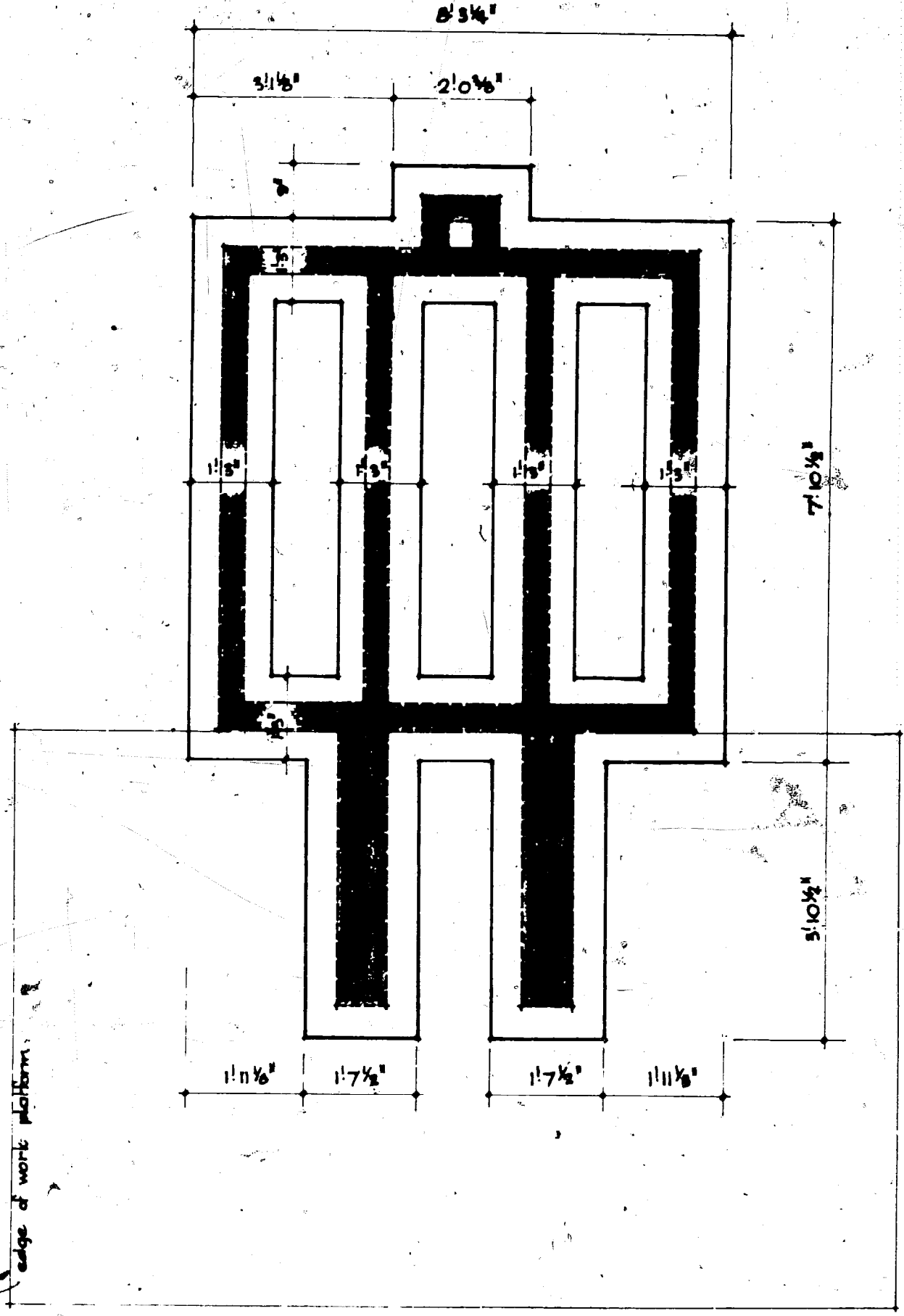

APPENDIX A
SECTION B-B

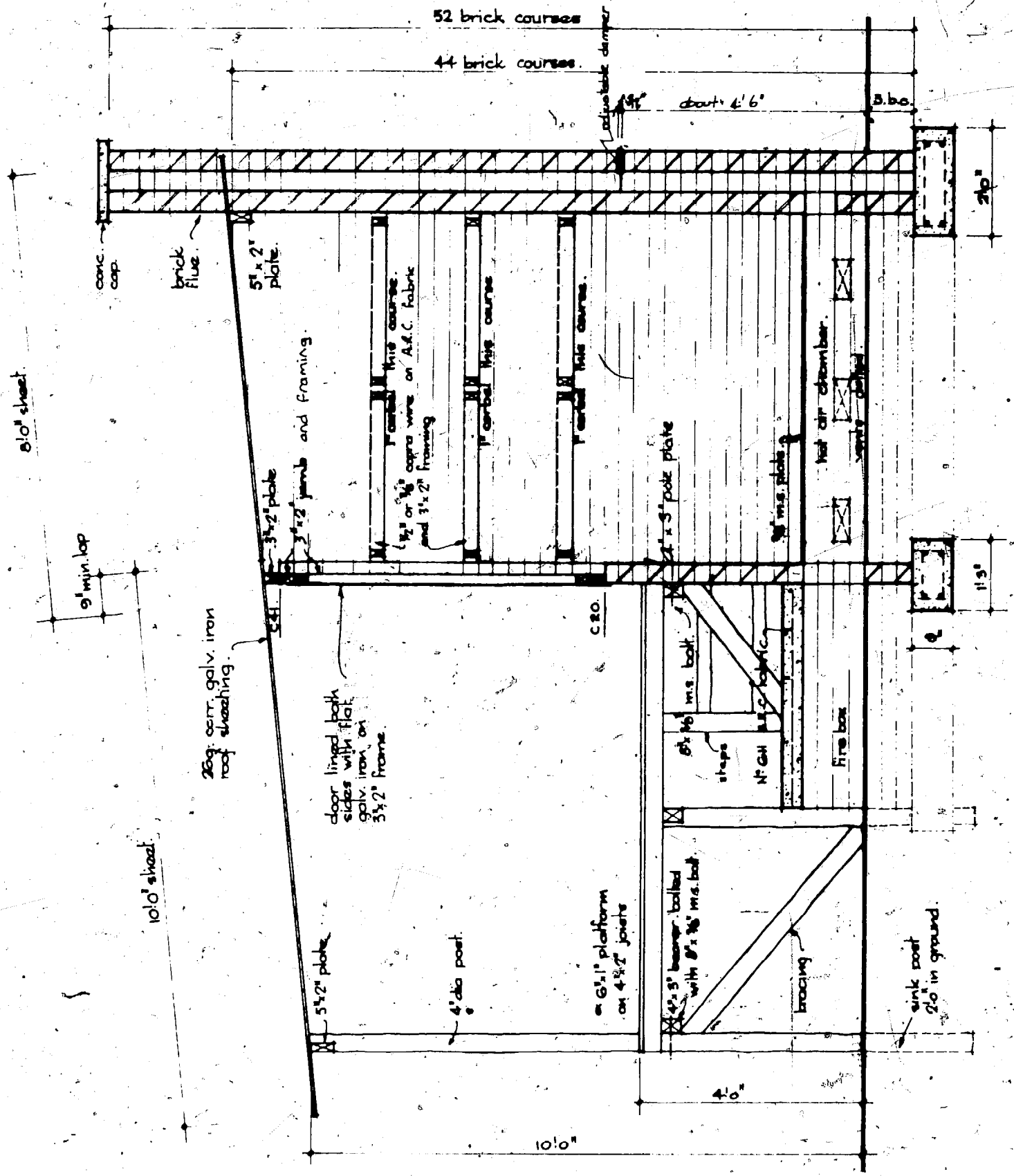

6'0" eave

9" min. lap

10'0" sheet

26g corr. galv. iron roof sheathing

door lined both sides with flat galv. iron on 3 1/2" x 2" frame

5 1/2" x 2" plate

4" dia. post

6 1/2" platform on 4 1/2" joists

4" x 3" beaver-balled with 2" x 3/8" ms. bolt

bracing

sink post 2'0" in ground

3 1/2" x 2" plate

3 1/2" x 2" joists and framing

1" coral ribs course
1/2" or 3/8" corr. wire on A.C.C. fabric and 3 1/2" x 2" framing

1" coral ribs course

1" coral ribs course

2 1/2" x 5" pole plate

3" ms. plate

net air chamber

3" x 3" door

52 brick courses

44 brick courses

adjustable damper

about 4'6"

B.B.

2'6"

1'3"

10'0"

4'0"

APPENDIX A
FRONT ELEVATION.

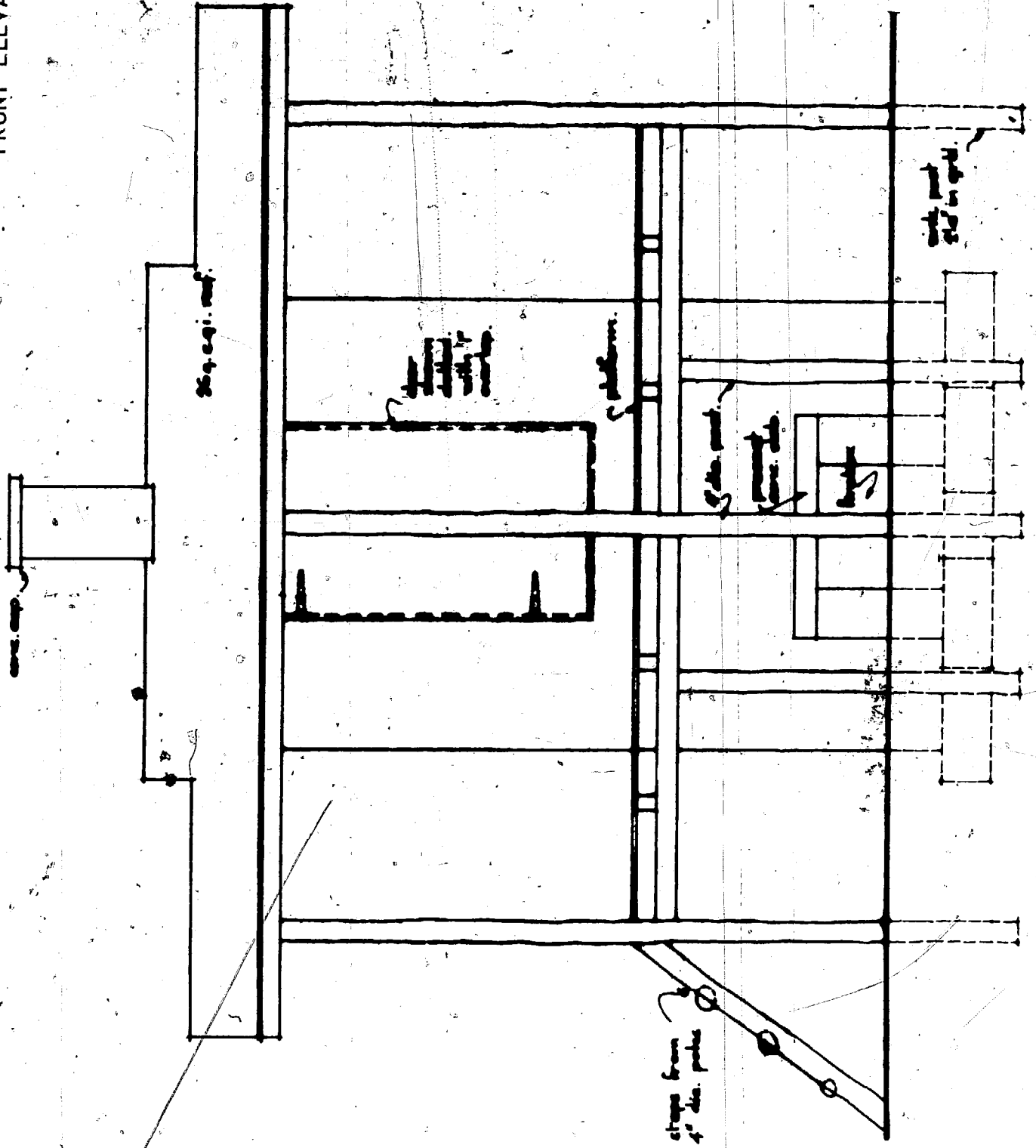

APPENDIX A
BACK ELEVATION.

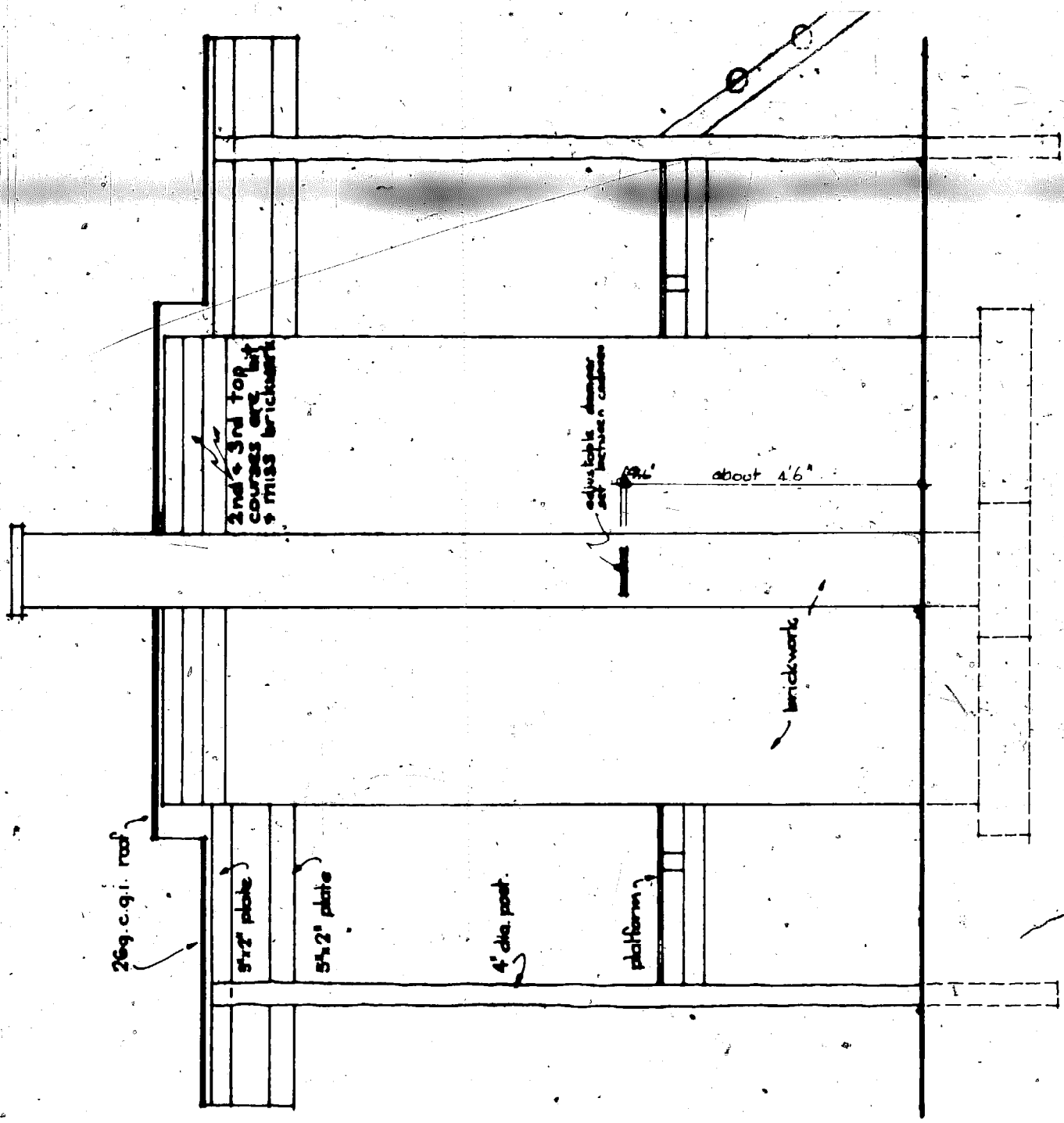

APPENDIX A
BRICK FOOTING.

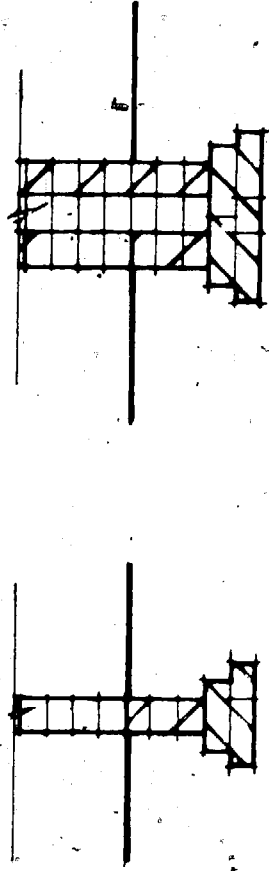

Alternative brick footing details.
Scale: 1/2" to 1'-0"

APPENDIX B

WOODEN MOULD

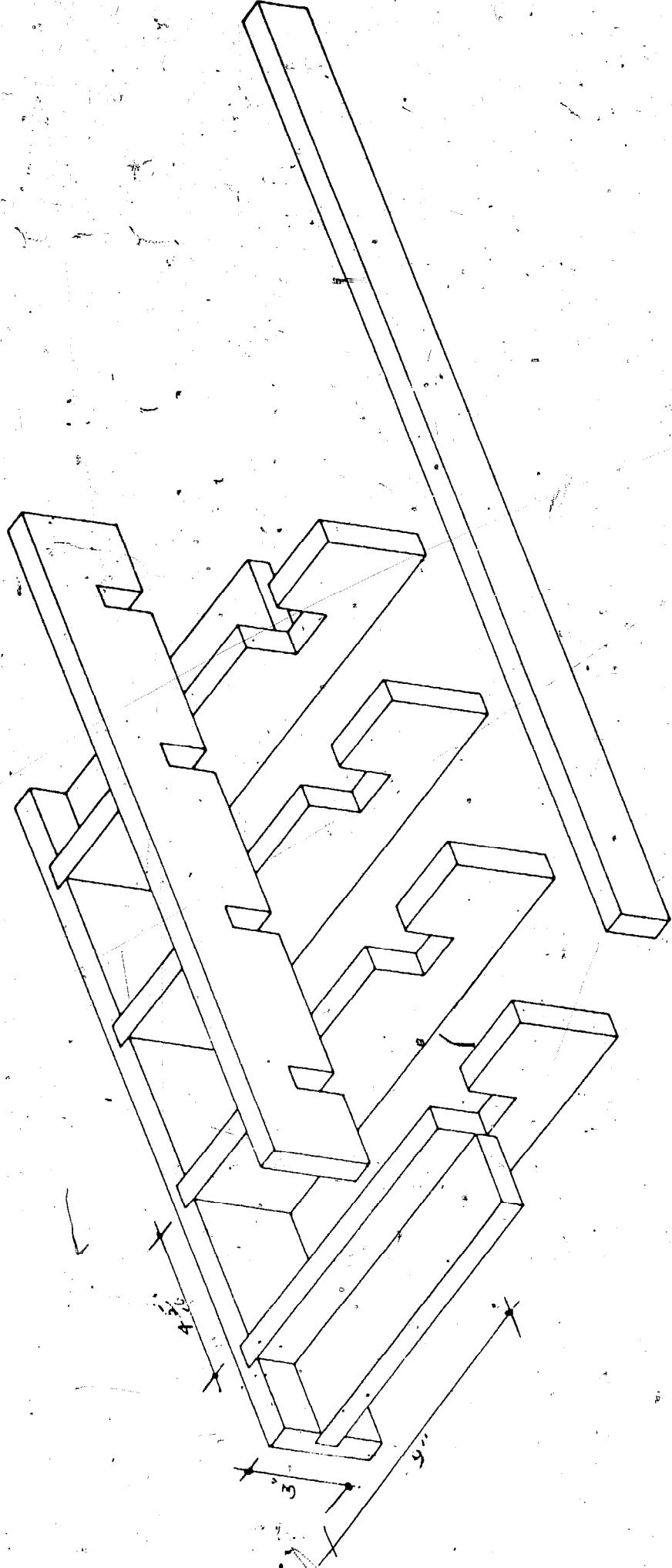

APPENDIX B
WOODEN MOULD.

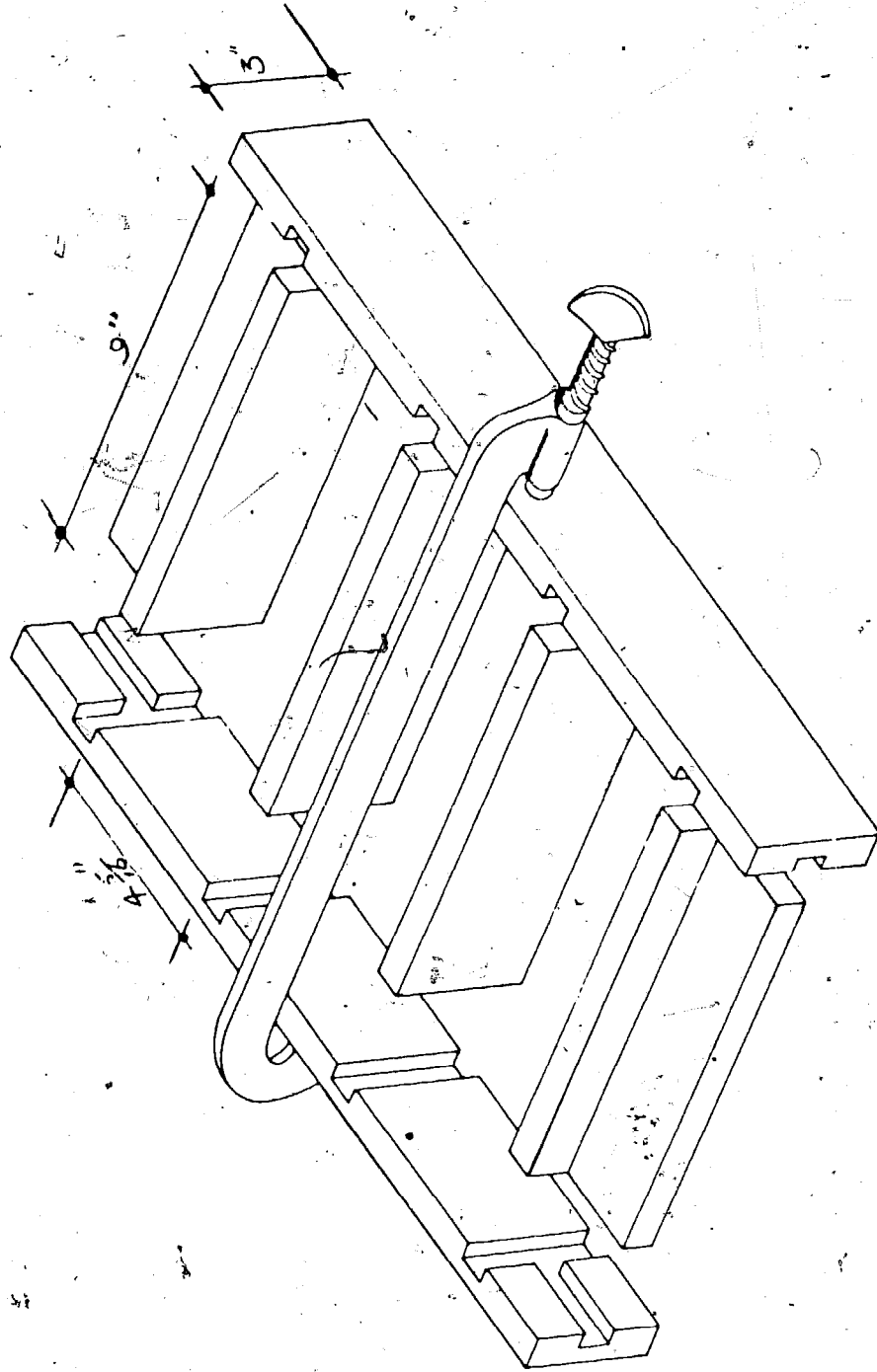

07

Construction of a Brick Hot Air Copra Drier

AT MICROFICHE
REFERENCE
LIBRARY



BUSINESS REPLY MAIL
FIRST CLASS PERMIT NO. 126 PALO ALTO, CA

NO POSTAGE
NECESSARY
IF MAILED
IN THE
UNITED STATES

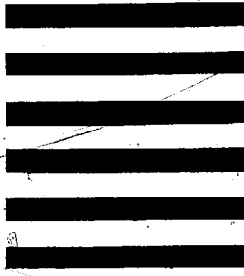

POSTAGE WILL BE PAID BY ADDRESSEE

The Asia Record

580 College Avenue
Palo Alto, California 94306