

AT **MICROFICHE
REFERENCE
LIBRARY**
A project of Volunteers in Asia

Harnessing and Implements for Animal Traction

By: Paul Starkey

Published by: **Friedr. Vieweg & Sohn
Verlagsgesellschaft mbH
Braunschweig, Germany**

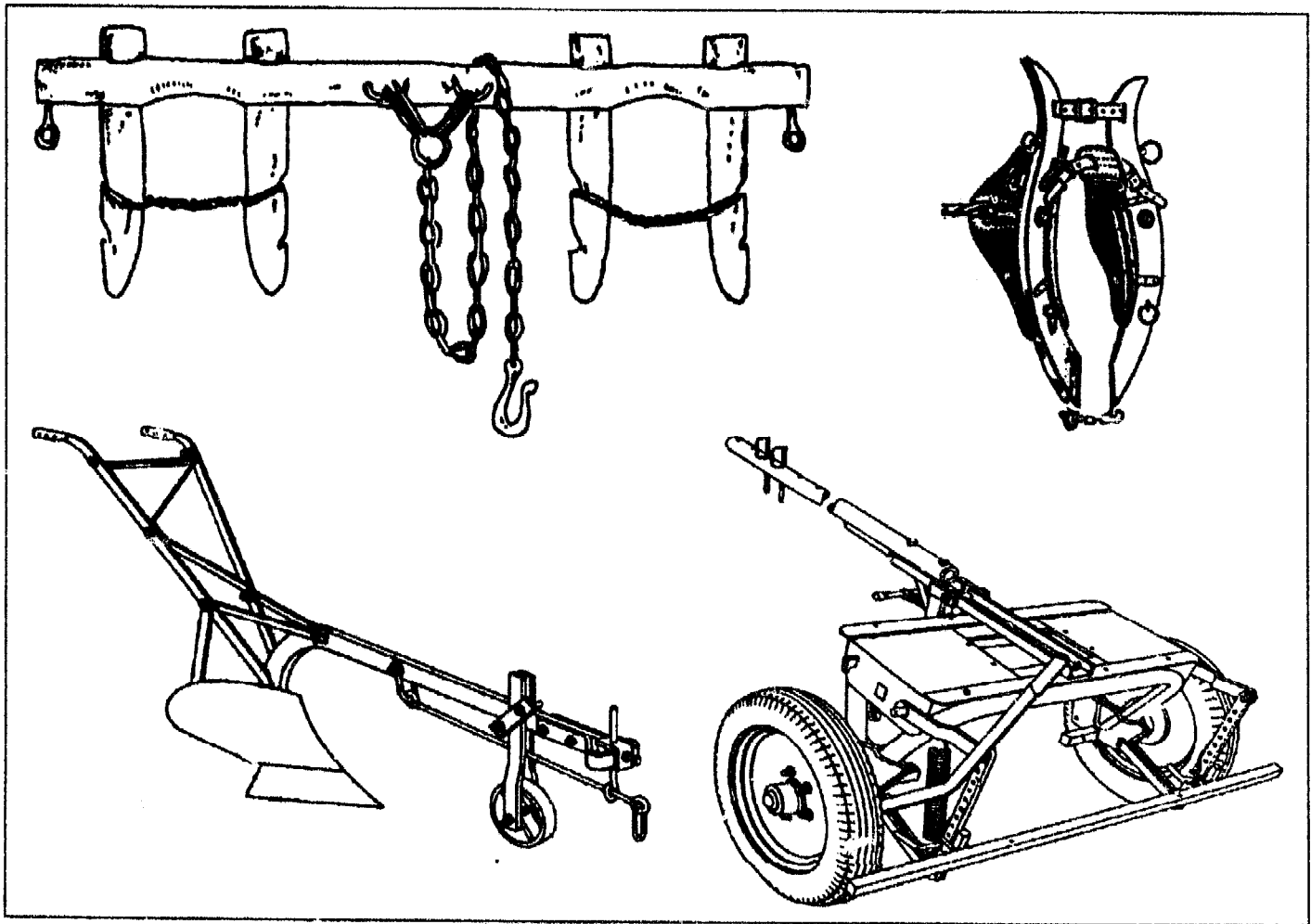
Available from: **Deutsches Zentrum für Entwicklungstechnologien--GATE
in: Deutsche Gesellschaft für Technische Zusammenarbeit
(GTZ) GmbH
Postbox 5180
D-6236
Federal Republic of Germany
Tel: (0 61 96) 79-0**

Reproduced with permission.

Reproduction of this microfiche document in any form is subject to the same restrictions as those of the original document.

Paul Starkey

Harnessing and Implements for Animal Traction



Vieweg

Deutsches Zentrum für Entwicklungstechnologien – GATE

Deutsches Zentrum für Entwicklungstechnologien – GATE – stands for German Appropriate Technology Exchange. It was founded in 1978 as a special division of the Deutsche Gesellschaft für Technische Zusammenarbeit (GTZ) GmbH. GATE is a centre for the dissemination and promotion of appropriate technologies for developing countries. GATE defines „Appropriate technologies“ as those which are suitable and acceptable in the light of economic, social and cultural criteria. They should contribute to socio-economic development whilst ensuring optimal utilization of resources and minimal detriment to the environment. Depending on the case at hand a traditional, intermediate or highly-developed can be the „appropriate“ one. GATE focusses its work on four key areas:

- *Technology Exchange*: Collecting, processing and disseminating information on technologies appropriate to the needs of the developing countries; ascertaining the technological requirements of Third World countries; support in the form of personnel, material and equipment to promote the development and adaptation of technologies for developing countries.
- *Research and Development*: Conducting and/or promoting research and development work in appropriate technologies.
- *Cooperation in Technological Development*: Cooperation in the form of joint projects with relevant institutions in developing countries and in the Federal Republic of Germany.
- *Environmental Protection*: The growing importance of ecology and environmental protection require better coordination and harmonization of projects. In order to tackle these tasks more effectively, a coordination center was set up within GATE in 1985.

GATE has entered into cooperation agreements with a number of technology centres in Third World countries.

GATE offers a free information service on appropriate technologies for all public and private development institutions in developing countries, dealing with the development, adaptation, introduction and application of technologies.

Deutsche Gesellschaft für Technische Zusammenarbeit (GTZ) GmbH

The government-owned GTZ operates in the field of Technical Cooperation. 2200 German experts are working together with partners from about 100 countries of Africa, Asia and Latin America in projects covering practically every sector of agriculture, forestry, economic development, social services and institutional and material infrastructure. – The GTZ is commissioned to do this work both by the Government of the Federal Republic of Germany and by other government or semi-government authorities.

The GTZ activities encompass:

- appraisal, technical planning, control and supervision of technical cooperation projects commissioned by the Government of the Federal Republic or by other authorities
- providing an advisory service to other agencies also working on development projects
- the recruitment, selection, briefing, assignment, administration of expert personnel and their welfare and technical backstopping during their period of assignment
- provision of materials and equipment for projects, planning work, selection, purchasing and shipment to the developing countries
- management of all financial obligations to the partner-country.

Deutsches Zentrum für Entwicklungstechnologien – GATE

in: Deutsche Gesellschaft für Technische Zusammenarbeit (GTZ) GmbH

Postbox 51 80

D-6236 Eschborn 1

Federal Republic of Germany

Tel.: (061 96) 79-0 Telex: 41 523-0 gtz d

Paul Starkey

Harnessing and Implements for Animal Traction

An Animal Traction Resource Book for Africa

A Publication of
Deutsches Zentrum für Entwicklungstechnologien – GATE
and Division 421 – Agricultural Production Systems
in: Deutsche Gesellschaft für Technische Zusammenarbeit (GTZ) GmbH



Friedr. Vieweg & Sohn Braunschweig/Wiesbaden

The Author: Paul Starkey studied Natural Science at Oxford University, Education at Cambridge University and Tropical Agricultural Development at the University of Reading. He worked in Malawi for four years, and for seven years he was a technical cooperation officer in Sierra Leone, where he initiated a national animal traction programme. He is now a consultant, specializing in animal traction, and also an Honorary Research Fellow at the Centre for Agricultural Strategy, University of Reading. His experience has been published in many journal articles and books. He has been closely involved in regional networking activities, and has been the Technical Adviser of the West Africa Animal Traction Network since its inception in 1985. His main professional interests are the improved utilization of draft animal power and stimulating closer international liaison in this field.

Books by the same author include:

Perfected Yet Rejected: Animal-drawn wheeled toolcarriers, GATE/Vieweg.
Animal traction directory: Africa, GATE/Vieweg.

Cover illustrations:

After: AETC, 1987; FSERT, undated; ILO, 1983g; ICRISAT, 1985.

Deutsche Bibliothek Cataloguing-in-Publication Data

Starkey, Paul:

Harnessing and implements for animal traction : an animal traction resource book for Africa / Paul Starkey. A publ. of Dt. Zentrum für Entwicklungstechnologien – GATE and Div. 421 – Agricultural Production Systems in: Dt. Ges. für Techn. Zusammenarbeit (GTZ) GmbH. – Braunschweig ; Wiesbaden : Vieweg, 1989

ISBN 3-528-02053-9

The author's opinion does not necessarily represent the view of the publisher.

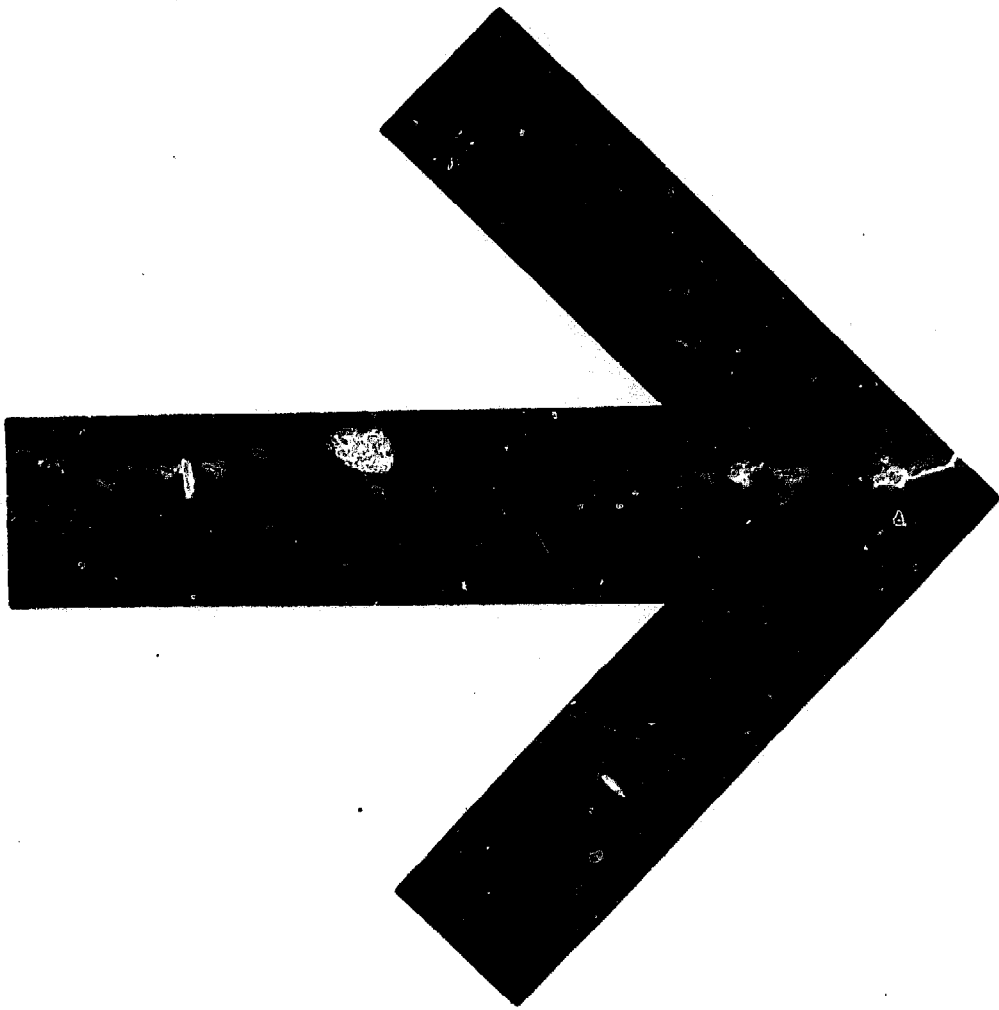
All rights reserved.

© Deutsche Gesellschaft für Technische Zusammenarbeit (GTZ) GmbH, Eschborn 1989.

Published by Friedr. Vieweg & Sohn Verlagsgesellschaft mbH, Braunschweig
Vieweg is a subsidiary company of the Bertelsmann Publishing Group International.

Printed in the Federal Republic of Germany by Lengericher Handelsdruckerei, Lengerich

ISBN 3-528-2053-9



This generously illustrated book contains the most comprehensive study of harnessing techniques and animal traction implements to have been produced for many years. Harnessing options for oxen, horses, donkeys, camels and buffaloes are reviewed, together with a wide spectrum of tillage implements, seeders, animal-drawn carts and other draft animal technologies. For each of these topics, the reader is guided through definitions and terminology, recent developments, technological choices, design options and assessments of practical advantages and disadvantages in actual farming systems. The author also tackles the vital issues of the selection or design of implements, research strategies and the supply and manufacture of equipment.

The author's fresh, thorough and pragmatic approach leaves few preconceptions unturned. The reader is encouraged and stimulated to see animal traction technology through farmer's eyes, and to reappraise future priorities for development projects, research institutions and extension programmes in the light of the past experiences in this field.

Several hundred carefully selected photographs and line drawings ensure that each subject is clearly illustrated, and make the publication attractive to a wide range of readers. Despite the wealth of information contained within this volume, the book constantly encourages readers to delve yet deeper into the subjects that interest them. Thus for every topic covered there are specific suggestions for further reading, together with the names and addresses of organizations with special interest in that field. This makes the book not only an authoritative reference work but also an invaluable resource book.



Deutsches Zentrum für Entwicklungstechnologie

ISBN 3-528-2053-9

Contents

Foreword by Bughard Kehr	7
Map of Africa	8
Preface by Peter Munzinger	9
Acknowledgements	10
1. Introduction	
1.1 Resource book objective	13
1.2 Context and approach	13
2. Some mechanical principles	
2.1 A very simplified approach to some mechanical principles	15
2.2 Forces and vectors	16
2.3 Work and power	19
2.4 Levers	24
3. Common harnessing systems	
3.1 Harnesses and yokes: clarification of definitions	27
3.2 Horn/head yokes	29
3.3 Withers/shoulder yokes	32
3.4 The length of yokes	34
3.5 Single yokes	35
3.6 Multiple Hitching	39
3.7 Harnessing for donkeys and horses	42
3.8 Harnesses for camels	48
3.9 Reining systems	50
4. Less common harnessing systems	
4.1 Full-collars and three-pad harnesses for cattle	53
4.2 Tyre collars and flexible harnesses	55
4.3 Collar-type yokes	57
4.4 The merits and demerits of collars for oxen	58
4.5 Harnesses for mixed teams	60
4.6 Load saddles for oxen	61
5. Harnessing: issues and resources	
5.1 The manufacture of yokes and harnesses	63
5.2 Some practical problems with harnessing systems	66
5.3 Research and development on harnessing systems	67

5.4	Choice of harnessing systems	71
5.5	Further reading and information sources	72
6. The selection of equipment		
6.1	Equipment evolution and development	73
6.2	Definition of requirements	74
6.3	Review of available production models	77
6.4	Review of previous adaptation work	77
6.5	Research and development	78
7. Implements commonly used for crop production		
7.1	Ards	81
7.2	Mouldboard plows	86
7.3	Ridging plows	92
7.4	Harrows	94
7.5	Seeders and planters	96
7.6	Cultivation tines	102
7.7	Simple multipurpose toolbars	107
7.8	Groundnut lifters	111
7.9	Equipment for irrigated rice cultivation	112
7.10	Further sources of information	115
8. Equipment for transport		
8.1	Pack animals	117
8.2	Sledges	118
8.3	Carts with two wheels	119
8.4	Wheel options for carts	120
8.5	Cart axles and bearings	124
8.6	Tyre punctures	126
8.7	Brakes, loads and assembly	128
8.8	Wheeled toolcarriers and four-wheel trailers	129
8.9	Further sources of information	130
9. Less conventional equipment		
9.1	Introduction	131
9.2	Wheeled toolcarriers	131
9.3	Harvesting equipment	134
9.4	Fertilizer applicators	136
9.5	Ridge-tiers	138
9.6	Weeder rollers	139
9.7	Land formation equipment	140
9.8	Water-raising equipment	144
9.9	Animal-powered gears and post-harvest operations	148
9.10	Forestry and road-building	154
9.11	Further information	156

10. Draft assessment and work rates

10.1	Implement draft	157
10.2	Working rates	162
10.3	"Light" and "heavy" work	170
10.4	"Average" power and "reasonable" work rates	172
10.5	High technology or simple assessment	174
10.6	Further sources of information	176

11. The supply and manufacture of animal traction equipment

11.1	Existing facilities	177
11.2	Donor influences	178
11.3	Problems of local workshops	179
11.4	Policy implications	182
11.5	Project options for the supply and manufacture of equipment	185
11.6	Spare part provision	187
11.7	Artisanal manufacture, modification and maintenance	190
11.8	Further reading and information sources	196

12. References 197**Appendices**

Abbreviations and acronyms	211
Glossary	214
Addresses of some organizations cited	217

Index 230

Foreword

This resource book was planned as a revised edition of the first animal traction handbook published by GTZ in 1981. It presents further technical information on Animal Traction and also reviews practical experiences during the last decade in many developing countries. The lessons to be learnt are manifold, but one aspect seems particularly important: those working with animal traction should avoid losing their perspective and objectivity by promoting Animal Traction with an ideological bias. Animal Traction, like other technologies, is only one means to the end of improving, on a sustainable basis, the livelihood of rural people. It is a link on a chain stretching from human labour to full mechanization, one stage in a long process. Some failures and disappointments in promoting Animal Traction teach us to see the technology in the broad context of the prevailing social, economic and farming environment. Only if we can thoroughly and intelligently assess and appraise the human and natural environment will we be able to come up with successful strategies and solutions.

In stark contrast to many developed countries where agriculture accounts for a small proportion of the economy, agriculture plays a

major role in the economies of most developing countries. The role of agriculture in development requires much greater care and attention. The importance of agriculture not only for the well-being of the people, but also for the entire developing economy is often seriously overlooked. Such neglect has slowed development and presents major difficulties to governments and donors trying to improve this sector.

This book highlights some of the problems and possible solutions of a small but vital area of agriculture. It aims to present Animal Traction in the context of the prevailing environments and farming systems. If this edition can provide development workers and decision makers with a constructive perspective on animal traction, then we will have achieved a great deal.

We at GTZ, together with the author and collaborators, sincerely hope that this book will reach those who are capable and willing to use the information presented. We hope they will be able to transform the ideas into intelligible action that can benefit and improve the livelihood of the rural poor in developing countries.

B. Kehr

Map of Africa

This map was kindly provided by the International Livestock Centre for Africa (ILCA). It is designed to show the approximate positions and sizes of African countries. It is included

for the convenience of readers only, and does not imply any expression of opinion concerning the delimitation of boundaries, territories, jurisdiction or legal status.



Preface

In 1978 an interdisciplinary team started to prepare the manual "Animal Traction in Africa". This was intended as a guide to assist planning and decision-making for development projects in Africa. The first version, in German, was published in 1981, followed by the English and French editions in 1982.

The "Animal Traction in Africa" manual was prepared mainly from an intensive literature analysis. At that time few publications were available so that perhaps undue authority had to be ascribed to old material, some dating back to colonial times. GTZ had begun to have experience with projects to promote draft animals in Africa, and this "early stage" knowledge was included, together with information derived from other national or international organizations and aid agencies.

Since 1978, nearly all African countries have started new development projects involving the utilization or promotion of draft animal power as a means to small-scale farm mechanization. External support for such projects has come from numerous sources. Since the publication of the first edition, several workshops have taken place at international, regional and national levels in order to improve information exchange in this neglected area. An international "expert consultation" on draft animal power was convened in 1982, and regional workshops have been held in west Africa (1985, 1986, 1988) and southern and eastern Africa (1983, 1987). The West Africa Animal Traction Network has now been formed and the International Livestock Centre for Africa (ILCA) is currently developing an Animal Traction Research Network.

As one consequence of this greater availability and exchange of information and worldwide experience, some of the views and statements expressed in "Animal Traction in Africa" began to seem dated, and occasionally misleading. Thus at the end of 1986 a proposal was put to GTZ to review the first edition and prepare a new one.

Following discussions between Burghard Kehr, Klaus Lengefeld, Henriette Mende, Ingeborg Reh, Paul Starkey and myself, it was decided to produce a series of specialized texts instead of one voluminous book. These "Animal Traction Resource Books" will aim to include information and experiences from around the world, but with special emphasis on, and reference to, Africa. Three thematic books are envisaged and these are intended to be used in close conjunction with the "Animal traction directory: Africa", already published in the same series. The themes will be:

- Harnessing and implements
- The working animal: selection, training, husbandry and nutrition
- Draft animal power: economic, social and environmental aspects

In this present book, Paul Starkey has used a stimulating and fresh approach to combine a detailed understanding of the practical problems encountered in the field with a comprehensive review of published information. In this way the objectives of the revision have been thoroughly met in regard to the two important topics of harnessing and implements.

Peter Manzinger
February 1989
Siavonga, Zambia

Acknowledgements

The author would like to thank sincerely all the many people who made the publication of this book possible.

Several colleagues read through drafts of this book and provided valuable comments, suggestions and additional information. Particular thanks go to:

- R. K. Bansal, ICRISAT/MIAC
- Dominique Bordet, CEEMAT
- Harry Gilbertson, AFRC-Engineering
- Michael Goe, ILCA
- Peter Howell, AFRC-Engineering
- Berghard Kehr, GTZ
- David Kemp, AFRC-Engineering
- Peter Lawrence, CTVM
- Mike Matthews, AFRC-Engineering
- Freda Miller, Reading University
- Peter Munzinger, GTZ
- Anne Pearson, CTVM
- Ingeborg Reh, TUB
- Caroline Starkey, Reading
- Gérard Le Thiec, CEEMAT.

Despite the help received from these and other people, it seems inevitable that there will be some inaccuracies or errors in the text. For these the author has to be responsible himself and he apologises in advance for any incorrect statements or impressions given. Should errors be noticed, the author would welcome factual corrections. He would also be happy to receive comments, observations and additional information on the topics covered. This would be particularly useful should any updated or translated edition be planned.

Various colleagues kindly allowed information from unpublished studies to be quoted.

Particular thanks go to Peter Howell of AFRC-Engineering, Dominique Bordet and Gérard Le Thiec of CEEMAT, Peter Lawrence and Anne Pearson of CTVM, R. K. Bansal of ICRISAT and Projet Aridoculture, Michael Klaij of ICRISAT, Niger and Joachim Betker of the University of Hohenheim.

The author is very grateful to all the organizations, institutions and individuals who provided photographs or line drawings. In order to give credit in the appropriate context, the illustrations have been acknowledged on the pages where they have been reproduced. In cases where illustrations have originated from other publications, a short form of the reference has been cited which will allow readers to obtain the full details of the publication concerned from the list of references (Chapter 12). In many cases, the illustrations used here are "original", in that they have never been published before in their present form. Nevertheless if similar illustrations from other publications were used in the conceptualization, design, development or realization of the drawings, that source has been fully acknowledged with the word "after".

All sources of illustrations are gratefully acknowledged. Particular thanks go to the following organizations or individuals for the assistance they provided in supplying photographs or line drawings:

- Agricultural Engineering Training Centre (AETC), Zimbabwe
- AFRC-Engineering
- Deutsche Gesellschaft für Technische Zusammenarbeit (GTZ)

- Centre for Tropical Veterinary Medicine (CTVM), Edinburgh
- Food and Agriculture Organization (FAO) of the United Nations
- International Crops Research Institute for the Semi-Arid Tropics (ICRISAT)
- International Livestock Centre for Africa (ILCA), Highlands Programme
- Institute of Agricultural History, Reading
- Intermediate Technology Publications
- International Labour Organisation (ILO)
- Ministry of Agriculture, Mozambique
- Jean-Louis Arrachart
- Henner Becker
- Henk Dibbits
- David Gibbon
- Michael Goe
- Enoch Gwani
- Peter Lawrence
- Peter Munzinger
- Anne Pearson
- Franz Rauch
- Piet Rijk

The author is grateful to the German Appropriate Technology Exchange (GATE) for publishing this book. Particular thanks go to Klaus Lengefeld and Henriette Mende who were closely involved from planning to completion.

Paul Starkey
March 1989

Centre for Agricultural Strategy,
University of Reading, Earley Gate,
Reading RG6 2AT, United Kingdom

A note on desk-top publishing

This book was created by the author using "desk-top publishing" (DTP) techniques. With the proliferation of computers within agricultural ministries and development projects, DTP is likely to become increasingly employed in the preparation of animal traction manuals and reports. For this reason some details of the steps and programs involved in the production of this book are provided for people interested in this technology.

The personal computer used for the DTP was an "IBM-AT-compatible" (made by Dell). The text was entered into a conventional word-processing program (Multimate). Some of the line drawings were created directly with a graphics program (Publisher's Paintbrush). Drawings from other sources were brought into the same graphics program using a Canon flat-bed scanner, and were then edited as necessary. Text and graphics were integrated within a specialized DTP program (Xerox Ventura Publisher), and printed by a Hewlett Packard laser printer (12 pels per mm or 300 dots per inch). This laser-printer output of laid-out text and drawings was used as the "camera-ready-copy" required to make conventional offset-printing plates at the printers. The original photographs were also scanned to produce computer graphics images that could be scaled and positioned within the DTP program. A printout of the page layout including the photographic images at relatively low resolution (300dpi) was submitted to the printers. This enabled them to make correctly-scaled high-resolution photographic plates from the original photos. The photographic plates were positioned in the offset plates in the appropriate gaps left in the "camera-ready copy". Final printing (on recycled paper) and binding were carried out by the printers using conventional techniques.

Plough or plow; draught or draft?

For those interested in the evolution of languages, it may be noted that while standard English spellings have been used in this text, with each of two commonly used words draught/draft and plough/plow the simpler of the alternative spellings has been adopted. All four spellings have been used in the English language for several hundred years and there are numerous ancient and recent precedents for the shorter, simpler versions. Current North American standards arose from the adoption of the simpler variations of the alternative spellings that were in use in English-speaking countries two to three hundred years ago. Although the "ugh" spellings have predominated in British publications for the last century, it would simplify terminology greatly if international publications used one spelling. Since the simpler alternatives have been used and accepted many times in the past, there seems little justification for maintaining the "ugh" spellings. Thus, in a continuation of the precedent set by other books in this series, "plow" and "draft" have been adopted here.

1. Introduction

1.1 Resource book objective

The subject of harnessing and equipment for animal traction is broad. It is important to people from diverse backgrounds with different levels of experience and education. Programme planners, extension workers, farmers, researchers, lecturers and students all have need for information on the subject, but while some need to start with very basic information, others require concise yet detailed technical content. Ideally there should be many different texts to meet these diverse requirements, ranging from simple extension manuals, filled with drawings of how to use and adjust animal-drawn implements, to specialist papers on implement working parameters or construction details. Luckily such an "ideal" situation does exist, the problem is that few people are aware of it! As should become apparent, there are very many useful documents, some widely disseminated and others little known, which together cover all the required levels of complexity. This book is not designed to replace these, but to lead people to them.

In past years there has been insufficient liaison between people working on harnessing and animal-drawn implements. As a result, there has been much unnecessary repetition of similar work, and limited opportunity to build on the experiences of others. Many misconceptions have arisen as to which equipment and techniques farmers have used successfully, and which implements farmers have found inappropriate. For this reason this book is intended to lead readers not only to printed sources, but to people and organiza-

tions with experience of the various topics discussed.

It should be clear that this book has not been conceived as a technical manual, for this would have inevitably fallen into the trap of being too simple, too complex, too general or too specific to be of wide-ranging value. Rather this book is intended as a resource document that can stimulate greater exchange of information between workers of many different levels and backgrounds. The objective has been to provide a thorough yet readable "state of the art" review, that informs people not only of further appropriate reading, but also makes them aware of organizations that may have relevant experience in the various subjects discussed.

1.2 Context and approach

In the earlier GTZ book *Animal Traction in Africa* (Munzinger, 1982) some very useful advice was given on harnessing and animal-drawn equipment (Viebig, 1982). Another widely used source of practical information was compiled by French workers in the 1960s and was published in French by CEEMAT as *Manuel de la culture avec traction animale* (CEEMAT, 1971). This was subsequently translated by FAO and published in English as *The employment of draught animals in agriculture* (FAO/CEEMAT, 1972). Both the GTZ publication and those of CEEMAT/FAO are still thoroughly recommended to the reader, and they are cited on several occasions in the following sections. Nevertheless it must be remembered that these books were the product of their times, and some of

the emphases and approaches may be less applicable today than when they were written. For example the CEEMAT/FAO publication discussed and illustrated several very heavy items of equipment that had been widely used in Europe. These have proved to have little application for smallholder farmers in tropical Africa. The previous GTZ animal traction book also illustrated some of these applications, and went on to emphasize more recent designs of equipment developed by researchers in Africa. As it transpired several of the illustrated designs (such as the TAMTU harrows and double plows) subsequently proved unacceptable to farmers, often because they were too heavy, too complicated or too expensive (Kjærby, 1983).

One objective of this present book is to give a more realistic impression of the *actual situation* with regard to animal traction in developing countries with special reference to Africa. It is also intended to provide ideas on future options. It is a specific intention to counteract the tendencies of many of those involved in animal traction development to present over-optimistic and rather euphoric views of the application of draft animal power, and various wonderful "new" techniques and designs. The problems of development are seldom that simple. The strong element of caution (considered by the author as "realism") may well be interpreted by some as pessimism. This is certainly not the intention as the author himself is both optimistic and enthusiastic about the potential for draft animal power. However in the past decade excessive optimism has often given way to great frustration among policy makers, researchers, extension workers and farmers. Such damaging disappointments could often have been avoided had a more realistic approach been

adopted, based on existing knowledge and previous experiences.

This background whereby unguarded optimism has led to disappointments should be borne in mind in the interpretation of each of the following chapters. It is not intended to dampen existing enthusiasm, but it is hoped that, by highlighting the potential problems, the resources and human energy available will be channelled in more constructive ways.

Should anyone read this book from cover to cover, they will inevitably be aware of repetitious themes. In practice few people read resource books so comprehensively: most people gather a general impression from the illustrations and captions, and then read only those sections of particular interest. For this reason key points and key references have sometimes had to be included in several sections. One recurrent theme will inevitably be that technical excellence is only one of many criteria to be used when assessing equipment and harnessing; farmers require materials and techniques that are affordable, sustainable and usable within the realities of their farming systems.

Finally, in the following chapters and appendices some implements have been referred to by trade names and mention has sometimes been made of specific manufacturers. The use of such names, and the provision of some addresses, is fully in line with the overall "resource book" objective of this publication. However it cannot be too strongly stressed that the mention of names should not be interpreted as approval or endorsement of any specific manufacturer or any particular implement design. Similarly no significance whatsoever should be drawn from the lack of mention of any manufacturer or design.

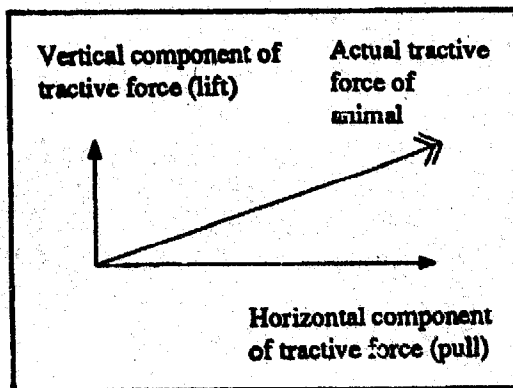
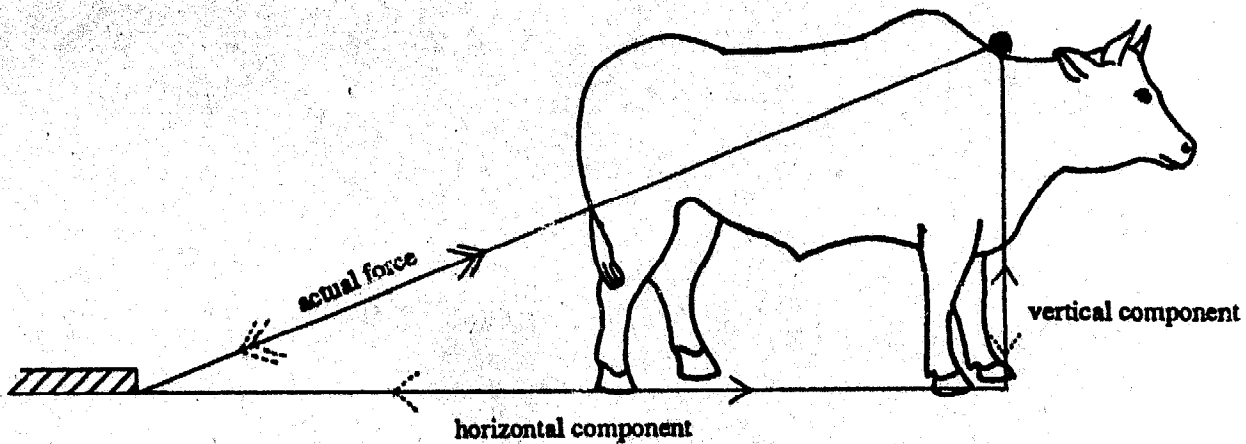
2. Some mechanical principles

2.1 A very simplified approach to some mechanical principles

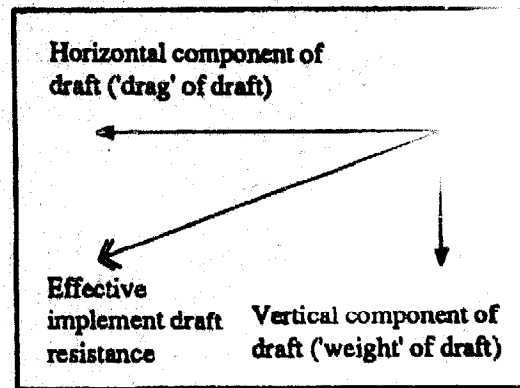
Many agriculturalists seem to regard mathematics and physics with trepidation and tend to skip over presentations that remind them of their previous struggles with these subjects. It is therefore not intended to present any detailed analyses of the dynamics of animal traction equipment, with impressive combinations of arrows, cosines, integration signs and Greek letters. For such technical details readers are referred to Devnani (1981), Viebig (1982), Crossley and Kilgour (1983), Goe (1987) and Matthews (1987). Nevertheless there are a few basic principles, which may be combined with common sense to provide a useful approach to animal traction equipment for people who would not consider grappling with the more complex theories of mechanics. Thus this brief section is intended to remind people of basic principles already known to them, and give some examples of the type of context in which they can be applied. In many cases, even a vague recollection of mathematical concepts learnt long ago, can help in interpreting and understanding different features of harnesses and equipment. Simple principles (rather than learned rules) can also be useful when it comes to assessing the advantages and disadvantages of various designs, and the significance of any modifications and adjustments.

In addition to some basic mechanical principles, it will be helpful to be familiar with the main units of measurement relating to animal-powered implements. The day-to-day application of such units is not essential because

comparative performances are more relevant than absolute values in the majority of field situations: farmers are more concerned with whether a particular combination of animals and implement can achieve acceptable work in a reasonable time, than with numbers illustrating weights, draft and power. Nevertheless there are great advantages in using standard units of measurement since this facilitates exchange of information between people in different countries; in the past meaningful exchange has been hampered by the wide range of different units that have been used when assessing animal drawn implements (horsepower, kilowatts, kilogram force, pound force, newtons, joules, miles per hour, kilometres per hour, metres per second, square metres per hour, hours per hectare, acres per day, etc.). Whenever practicable, internationally accepted standard units have been used in this book. Such units are merely convenient measures of magnitude, and do not convey any information as to the authority or reliability of numbers. While measurements obtained under accepted standard and repeatable test conditions can be widely applicable, there are very few standard measurements relating to animal draft, other than implement and animal weight and physical dimensions. When draft animals work pulling implements in a farmer's field or at a research station there are so many highly specific variables influencing the situation that the actual figures may have little relevance away from the conditions in which they were obtained. Thus although the use of international *units* is to be encouraged, these should not be confused with international test standards, and great care should be taken when interpreting data



Tractive forces



Resistance forces

Fig. 2-1: Illustration of the vertical and horizontal components of draft forces.

obtained in different circumstances. Similarly, because local conditions are so variable, it is generally unwise to ascribe "typical" values to agricultural operations. Nevertheless in order to make readers more familiar with the units that will be used in subsequent chapters, a few illustrative values of force, work and power will be given, merely as examples.

2.2 Forces and vectors

The first mechanical principles that might be recalled are those relating to forces. (Some people may even remember that Newton's first law was that a body will remain at rest or in straight-line motion unless acted upon by a force. His second related to changes in momentum and direction of movement as a result of forces, while his third was that ac-

tions and reactions are equal in magnitude and opposite in direction).

The standard unit of force is a newton (symbol N). The definition of a newton is based on the force resulting from acceleration acting on a mass of one kilogram. Since the acceleration due to the Earth's gravity is about 9.8 metres per sec², the weight of one kilogram mass (on most of the earth's surface) is about 9.8 newtons, i.e. *one kilogram of mass weighs about 10 newtons*. Thus although some purists may object, for all practical purposes a newton can be simply considered as a unit of force equivalent to 100 grams weight. Thus 10 N is equivalent to one kilogram (1 kg or 2.2 lb). Newton units are used in this book as these are the accepted international standard, and will be found in other references. Older texts have

generally referred to kilograms force (1 kg f = 10 N) or pounds force (1 lb f = 4.5 N). Some authors have used decanewtons (dN) which are broadly equivalent to kilograms and some have used kilonewtons (kN) equivalent to 100kg force. However for most people it should be sufficient to remember that *dividing the newton figure by 10* will give the kilogram equivalent. By way of illustration, a low-draft implement such as a light seeder might impose a draft resistance force of about 200N; a small mouldboard plow in light soils might require a tractive force of 500N while a double mouldboard plow in heavy soils might require a force of 2000N.

In scientific terms "weight" is actually a force, since it depends on the acceleration of gravity. A body can appear "weightless" in space, even though its "mass" does not change. The standard units of mass are grams and kilograms, while it has been noted that the units of force are newtons. A spring balance, even one calibrated in kilograms, actually measures weight not mass, and will give slightly different readings at different altitudes. Purists would calibrate spring balances in newtons, whether they are to be used as weighing instruments or as dynamometers for measuring draft forces. However for those concerned mainly with tilling the earth's surface, gravity can be considered approximately constant, and the interchange of the words "mass" and "weight" is unlikely to be a source of confusion. For this reason, the word "weight" will often be used in this book in the loose, colloquial sense, in which weight is measured in kilograms, rather than newtons.

Forces have direction as well as magnitude, and the concept of vectors is useful in studying them. Forces can be analysed in terms of three axes at right angles to each other, although many can be considered more simply and conveniently as acting in just one plane. In such cases a "diagonal" force (such as the pull on a traction chain), can be thought of in terms of vertical and horizontal components

(Fig. 2-1). Such a pull has an upward component and a forward component. If the pull were at an angle of 45° , these horizontal and vertical forces would be equal, so that as much of the applied force is being used in "lifting" as in "pulling". If it were possible to change the 45° pull into one that was almost parallel to the ground, the same force would have a much greater horizontal (forward) effect. One means of achieving a more effective horizontal force would be the use of a very long traction chain, and another would be to lower the point from which it were pulled. In terms of horizontal pull, short-legged oxen with a low-hitched harness and a very long traction chain would be more efficient than long-legged camels with a high hump harness and short chain. This exaggerated example illustrates two points: firstly that agriculturalists do not have to be engineers to be able to consider in a very simple but useful way the forces involved in the application of harnesses and equipment, and that such consideration may well lead to ideas for improving field adjustments or overall designs; secondly what may be theoretically optimal in terms of one aspect of efficiency may not be appropriate in terms of operational convenience or animal availability. Over-long chains make turning very difficult and short legged mini-beasts may not have sufficient power, speed or endurance. In practice, design considerations such as convenience, cost, availability and even appearance may outweigh technical refinements.

Fig. 2-2 gives a highly simplified diagram of some major forces acting on a plow. Some readers may have seen comparable diagrams with arrows going in other directions. This can be explained with reference to Newton's third law, since all the forces cited will have opposing forces (the pull of the animals is opposed by the draft of the implement; the downward force of the yoke due to gravity and the vertical component of the draft is opposed by the body of the animal as it stands and pulls). Fig. 2-2 is not actually a vector diagram, as it merely shows the directions of the

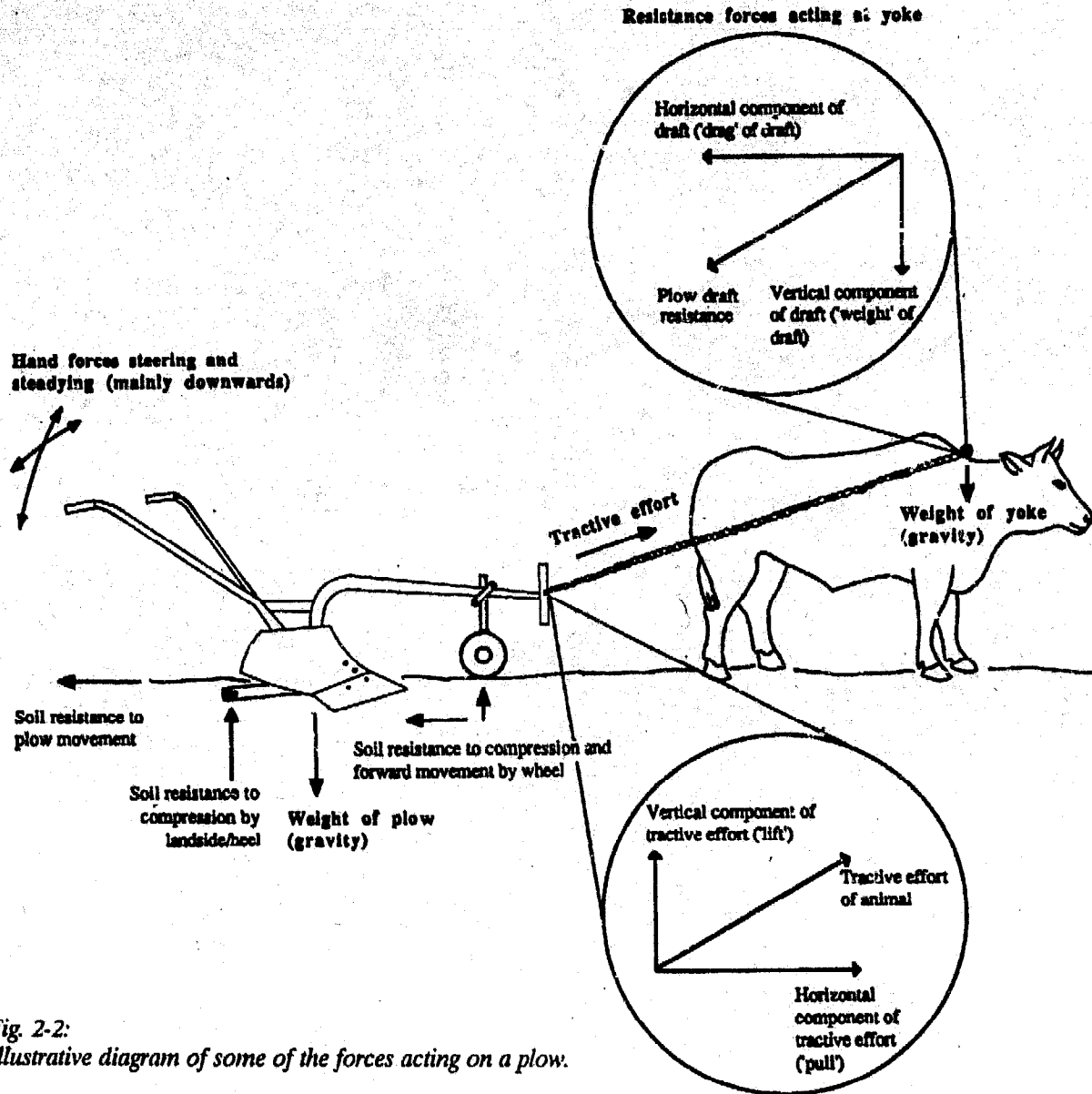


Fig. 2-2:
Illustrative diagram of some of the forces acting on a plow.

various forces, not their values. In a mathematical vector diagram, or triangle of forces, the lengths of the sides are directly proportional to the forces. In practice vectors are seldom included in diagrams of harnesses and plows since the actual forces are highly variable. If a comprehensive picture of all the different forces (actions and reactions) at work during a field operation were to be included in a diagram, a veritable spider's web of arrows could be created before even venturing into the third dimension. Fortunately for many practical purposes the different forces can be considered quite separately, and this

simplified approach can be particularly useful when reviewing settings and adjustments.

Although emphasis in this discussion has been placed on the forces associated with plows, similar forces are involved with other animal-drawn implements. For tillage implements, the soil resistance to forward movement is generally the most crucial. For wheeled implements or animal-powered gears, internal frictional resistance to the rotation of wheels, bearings or gears may be at least as important as the draft forces between the implement and the environment.

Summary of the units cited in this book and some equivalents

Quantity	Units	Symbol	Comparisons and approximate conversions
Mass	kilogram gram tonne	kg g t	1 kg = 2.2 lb; 1 lb = 0.45 kg 1000 g = 1 kg 1 t = 1000kg = 1 imp ton
Length	kilometre metre centimetre millimetre	km m cm mm	1 km = 0.621 miles; 1 mile = 1.61 km 1 m = 100 cm = 1000 mm = 1.09 yard = 3.28 ft 1 cm = 0.394 inch; 1 inch = 2.54 cm 1 mm = 0.04 inch
Time	second, hour, day	s, h, d	1 h = 60 mins = 3600 s
Area	square metre hectare	m ² ha	1 m ² = 1.20 sq yd; 1 sq yd = 0.84 m ² 1 ha = 10,000 m ² = 2.47acre; 1 acre = 0.405 ha
Volume	cubic metre litre	m ³ l	1 m ³ = 1000 litres = 220 gallons = 35.3 cu. ft 1 l = 0.22 imp gallons
Speed	metres per second kilometres per hour	m/s, m s ⁻¹ km/h or km h ⁻¹	1 m/s = 1 m s ⁻¹ = 3.6 kmh ⁻¹ = 2.24 mph = 3.28 ft s ⁻¹ 1 km/h = 1 km h ⁻¹ = 0.278 m s ⁻¹ = 0.62 mph; 1 mph = 1.6 km h ⁻¹
Force	newton decanewton kilonewton	N dN kN	1 N = 9.8 (=10) kg force (kgf) = 0.225 lb force (lbf) 1 dN = 10 N = 1 kgf = 2.25 lbf 1 kN = 1000 N = 100 kgf = 225 lbf = 0.10 tonf
Work or energy	joule kilojoule megajoule	J kJ MJ	1 J = 1 newton metre (Nm) 1 kJ = 1000 J = 737 ft.lb 1 MJ = 1000 kJ = 1,000,000 J
Power	watt kilowatt	W kW	1 W = 1 joule per second = 1 Nm s ⁻¹ 1 kW = 1000 W = 1.34 hp = 1.32 cv; 1 hp = 0.75 kw

2.3 Work and power

Work involves moving a force through a distance. As an implement is pulled through the soil, the animal or team exerts a tractive force and as it moves across a field, it performs work. Work done is not a function of time, so that however long an operation takes, the actual work done is the same. Plowing a field to a particular standard and depth entails the same amount of work (in principle) whether it is completed in one morning, in one day or in many days, whether the work is done by a single animal, a pair, or by a large team, and whether the animals pull a narrow plow through a long distance or a wide plow through a shorter distance. (In practice there

may be some small differences since some frictional forces vary with speed and surface to volume ratio). Although the actual work achieved in terms of plowing will be the same in all the cases cited, the number of animals and the *rate* of work may well have significant implications for total energy expenditure. (Animals are constantly using *metabolic* energy for maintenance, in a way comparable to the non-stop idling of a vehicle engine, so that a slow job or one involving more than one animal may involve higher metabolic energy expenditure; animals also perform work moving themselves, so that the shorter the distance they travel, the less work they do moving themselves; in such cases pulling a wide

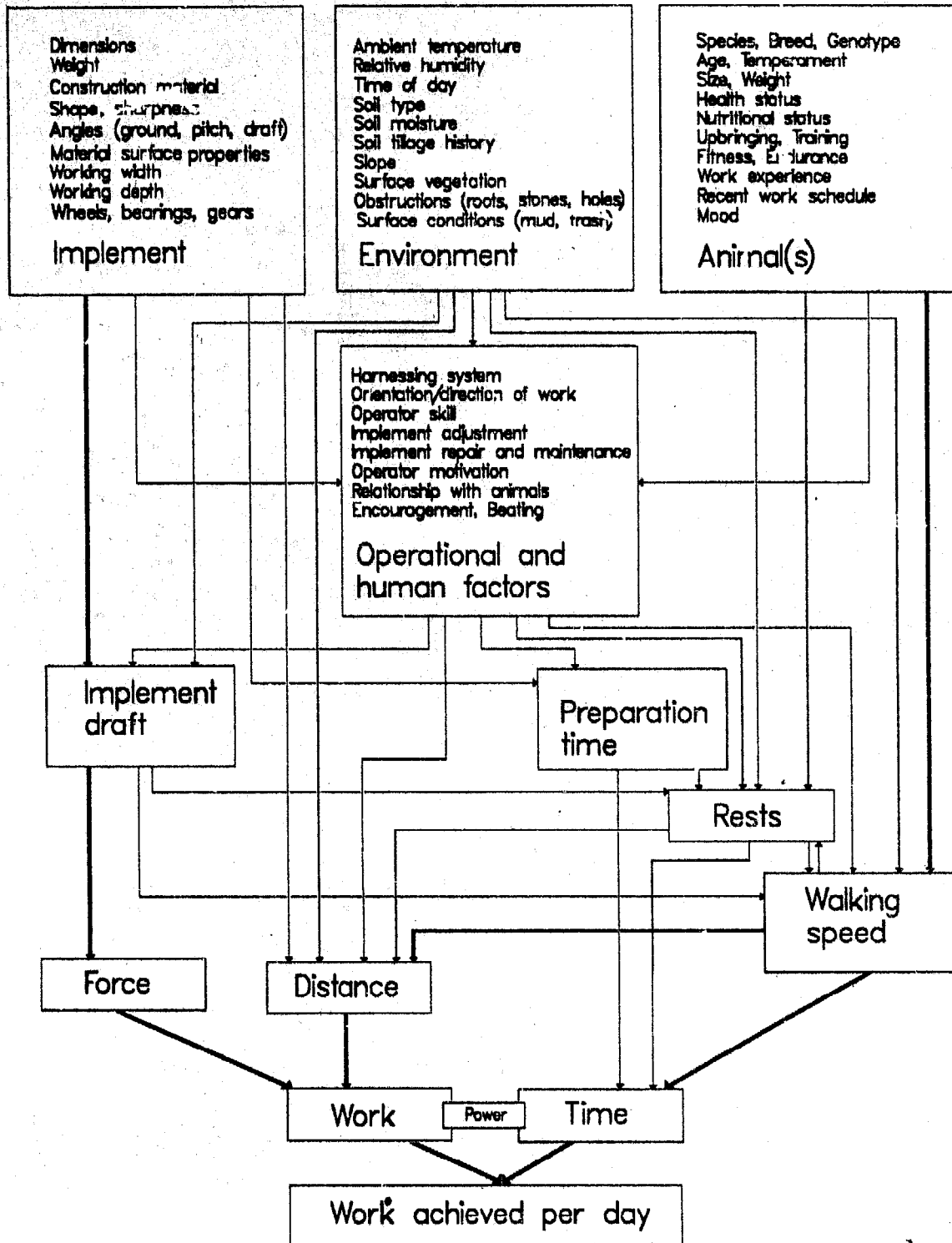


Fig. 2-3: Some of the factors influencing the work achieved per day by draft animals.
On the left side of the diagram: the shape, weight, width and working depth of the implement largely determine its draft in the prevailing environment, and thus the force the animal(s) have to apply to pull the implement.
On the right side of the diagram: the breed, size, weight, training, fitness, temperament and work schedule of the animal(s), together with the implement draft, will largely determine the walking speed and thus the power output and, depending on the distance covered in the day, the resulting work achievement.
Centre: implement draft, walking speed and non-working time are greatly influenced by a wide variety of interacting environmental, operational and human factors, only some of which are shown here.

implement though a short distance will involve less energy for walking than pulling a narrow implement through a long distance).

The units used to measure work are joules (J), kilojoules (kJ) or megajoules (MJ). A joule is the work of moving one newton through one metre. Since 1 kg weighs about 10 newtons, lifting one kilogram through one metre is equivalent to about 10 joules of work. Similarly pulling a 1000 N force through 1000 m (1 km) is equivalent to about one megajoule of work. By way of illustration, during a relatively light work schedule, a pair of 250 kg oxen might achieve 2.5 MJ of work in a day by pulling a 500 N force through a distance of 5000 m; in a more rigorous schedule, a pair of 350 kg oxen might achieve 12 MJ of work in a day by pulling a 800 N force through a distance of 15,000 m. Seeding a hectare of land with a low-draft (200 N) implement at 60 cm spacing (requiring travelling 17,000 m) might represent 3.3 MJ of work. Similarly plowing a hectare of land with a small 15cm mouldboard plow in light soils might involve work of 33 MJ (a 500 N force through 66,000 m, the distance a 15 cm implement has to travel to cover a hectare). In theory, plowing with a double mouldboard plow adjusted to the same depth would involve the same amount of work as the draft force would be doubled ($2 \times 500 \text{ N}$) but the distance moved would be halved (33,000 m). Plowing a hectare of similar soil slightly deeper with 25cm single (or double plow) might involve 40 J (a 1000 N force through 40,000 m or a 2000N force through 20,000 m).

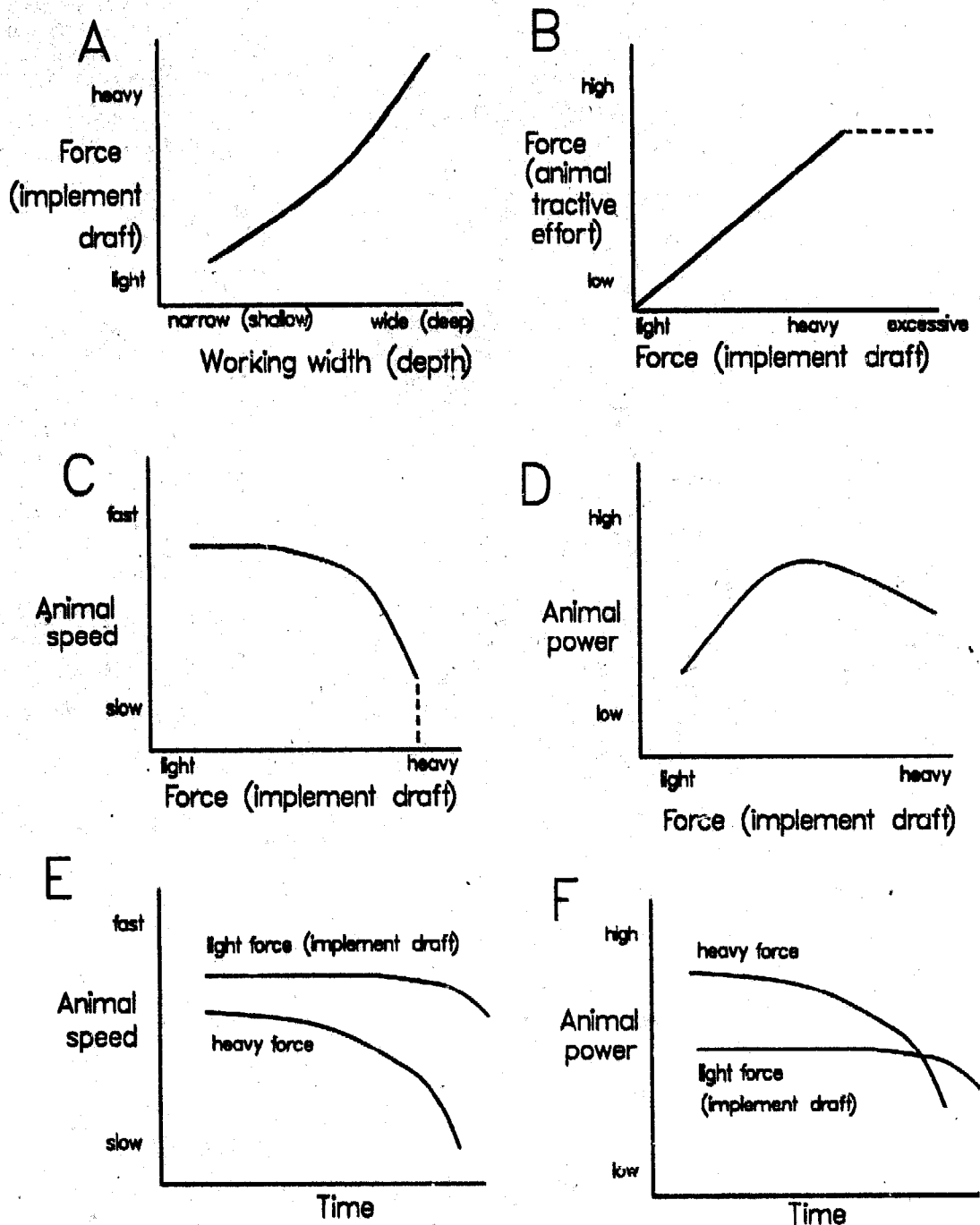
Power is the *rate* of doing work, and therefore unlike work, power is a function of time. Historically power was assessed in terms of what a draft animal might perform, and was measured in units called *horsepower* (hp), units that are still quoted today in some countries. The "imperial" horsepower unit was suggested by James Watt who timed a horse and also his new steam engine as they pulled weights up a well shaft: he concluded that a

horse could work at a rate equivalent to lifting a 550 pound weight through one foot in one second. A metric *horsepower*, or *cv* in French, was very slightly less, being the equivalent to lifting 75 kg through one metre in one second ($1 \text{ cv} = 0.986 \text{ hp}$). (In passing it may be noted that despite the implications of the word "horsepower", horses in Africa seldom perform sustained work at a rate of more than about 0.6 hp, although during bursts of rapid work they may produce very high power peaks of 6-7 hp).

Horsepower units have been replaced by the international standard unit of power, the watt and its multiple, the kilowatt. A watt is a unit of power is equivalent to one joule of work per second. Lifting one newton by one metre in one second requires a power of 1 watt (W). Similarly lifting one kilogram (i.e. 10 N) one metre (i.e. 10 joules of work) in one second requires a power of 10 watts. A kilowatt (kW) is 1000 W and $1 \text{ kW} = 1.34 \text{ hp} = 1.32 \text{ cv}$. For illustrative purposes, a pair of oxen walking quickly at one metre per second (1 m/s or 1 m s^{-1}) and pulling a load of 1000N, produce a *joint* work output of 1000 W or 1 kW. A single donkey pulling a 200 N draft seeder at a rate of 1 m s^{-1} works at the rate of 200 W.

For any particular force or amount of work, it is *speed* that determines power output. Pulling an implement that has a draft of 800 N at a speed of 0.8 m s^{-1} requires a power of 640 W, while to pull the same implement at 0.3 m s^{-1} requires only 240 W. Animals therefore tend to adjust their speed in reaction to the draft load and the reduction in speed is particularly noticeable with cattle.

It should be noted that while many of the terms such as force, draft, work and power have specific scientific definitions, they are also used in a more general and loose sense by agriculturalists and farmers. Subjectivity and context can bring to these words a wide variety of meanings. For example, oxen are often said to be more "powerful" than horses.



Important note: these graphs are included only for the purpose of illustrating some general points, as described in the captions and discussed in the text. Their exact shape is not significant. These graphs should not be interpreted as demonstrating exact relationships between the variables involved.

Fig. 2-4a: Some highly simplified, illustrative relationships between force, speed, power and time.

A: The draft of an implement increases with working width or working depth.

B: As implement draft (resistance force) increases, an animal has to exert an equal force in order to pull the implement at a steady speed. When the resistance is greater than the maximum pull of the animal, the animal may exert a force by straining at the implement, but it will not be able to move it.

C: As the draft of an implement increases beyond a certain point, an animal slows down and eventually stops.

D: As the draft of an implement increases, an animal increases its power output (power = force × speed), until a point when the increase in the force it exerts is more than offset by its decline in speed.

E: An animal with a light load maintains its normal walking speed for some time, although speed may eventually decline. An animal pulling a heavy load starts at a slower speed, and noticeably slows with time.

F: With a light load an animal maintains its (low) power output for some time, but with a heavy load its (higher) power falls off rapidly when it tires and slows. The cross-over of the graphs illustrates that the power output of an animal may be greater when a light load is pulled fast, than when a heavy load is pulled slowly.

Important note: these graphs are included only for the purpose of illustrating some general points, as described in the captions and discussed in the text. Their exact shape is not significant. These graphs should not be interpreted as demonstrating exact relationships between the variables involved.

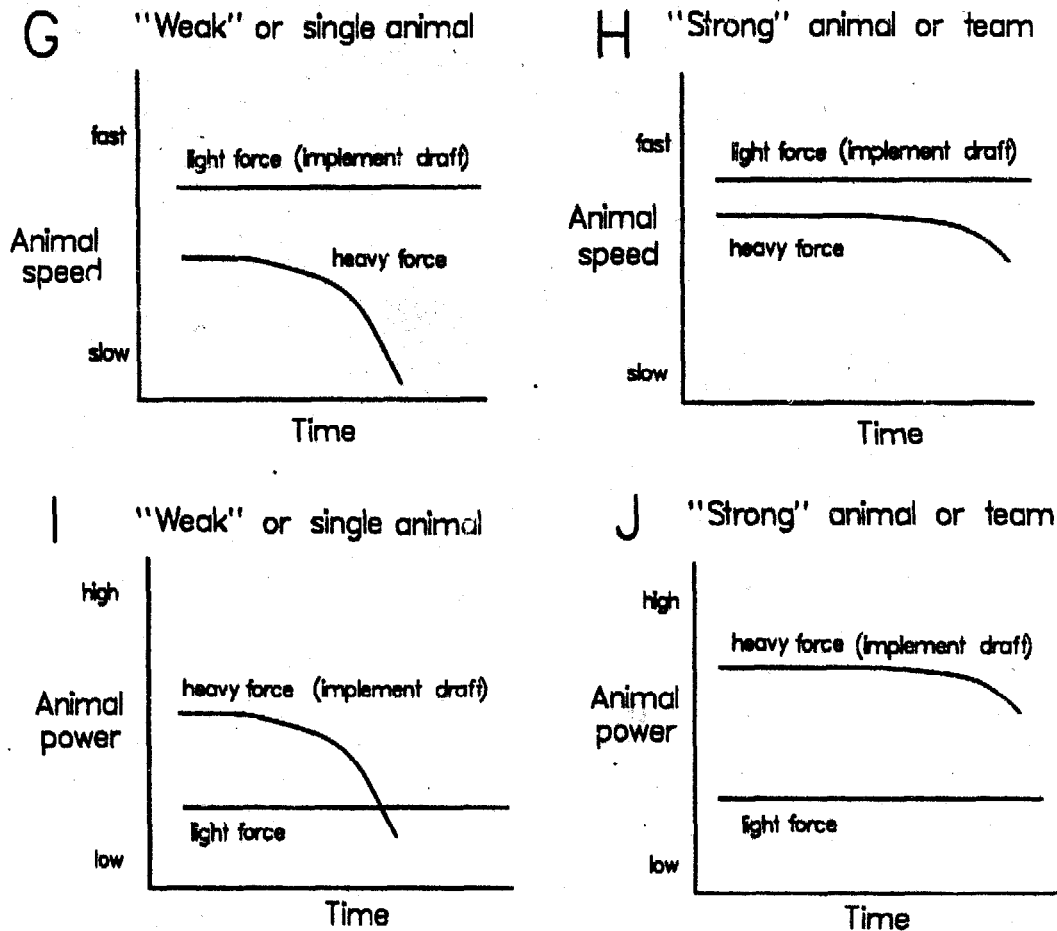


Fig. 2-4b: Some highly simplified, illustrative relationships between force, speed, power and time, showing some differences between "weak" and "strong" animals, or between single animals and teams.

G: With a light draft force (low-draft implement), the "weak" or single animal is able to walk fast and maintain its walking speed, but with the heavier load it starts at a slower speed and soon slows down significantly.

H: With a light load, the "strong" animal or team consistently walks at a fast speed (but no faster than the "weak" or single animal). With the heavier load the animal or team starts off at a slightly slower speed than when pulling only a light load, and maintains the speed well although it does decline after some time. The "stronger" animal or team invariably walks faster than the "weaker" or single when pulling the heavy draft.

I: The "weak" or single animal maintains its low power output with a light load, and since walking speed and implement draft are the same as those of the "strong" animal or team, its power output is equal to that of the "strong" animal or team (graph J). With the heavier load the animal initially provides power at a much greater level than with the light draft, but this rapidly falls off as the animal tires and slows down.

J: Although the animal or team is "strong", it cannot apply any more power than the "weak" animal or single when it pulls the same light-draft implement at the same speed (graph I). However with the heavier draft, the "strong" animal or team can maintain a high power output, which only drops off as the animal(s) tire and slow.

Sources consulted in compiling these illustrative graphs included: Vaugh, 1945; Hussain et al, 1980; Ayre, 1981; Varshney et al, 1982; Crossley and Kilgour, 1983; Lawrence and Pearson, 1985; Kebede and Pathak, 1987; Betker and Klaij, 1988; Bansal et al, 1989; Lawrence, 1989; Pearson et al, 1989.

What is usually meant by this is that oxen may be better at sustaining a heavy draft force for a longer period than a horse. However because of their higher speed, horses can generally develop more actual "power" than oxen.

In any given situation, a very large number of different, interacting parameters relating to the animal(s), the implement, the harnessing, the environment and the human operators will determine the amount of work that can

be achieved. Some of these are illustrated in Fig. 2-3 and further discussed in Chapter 10. However it may be helpful to remember the following highly simplified summary. It is the implement (its size, weight, width, depth, etc.) and the environment (soil conditions, obstructions, etc.) that together determine the draft force. These can be effected by the operator (settings for depth and width of work, working condition of implement, etc.). Since the draft is determined by the implement and the environment, this will be broadly the same whether it is pulled by one animal or many animals, and whether it is pulled quickly or slowly. What is determined by the animal(s), is the speed at which the implement is moved. The achieved speed (and therefore the power output) will depend on the draft of the implement, the power and condition of the animals, environmental conditions and the behaviour of the operator. In response to high draft forces or fatigue, animals slow their walking pace and take more rests, so reducing the work they do in a given time. Some of these relationships are illustrated in a simplified way in Fig. 2-4.

Harnesses link animals to implements; while they do not alter the actual draft of the implement, they can influence how the draft is partitioned between vertical and horizontal vectors. Harnesses do vary slightly in their efficiency as transmission systems, so that greater or lesser amounts of energy are dissipated in the harnessing system itself or in unproductive work. Harnesses do *not* affect the intrinsic power of an animal, which is determined largely by its species, size, weight and past history. However through ergonomic aspects of design, notably those relating to comfort, harnesses may influence an animal's ability and/or willingness to use its power. This is discussed further in Chapter 5.

2.4 Levers

Much to do with equipment design and adjustment can be explained by reference to

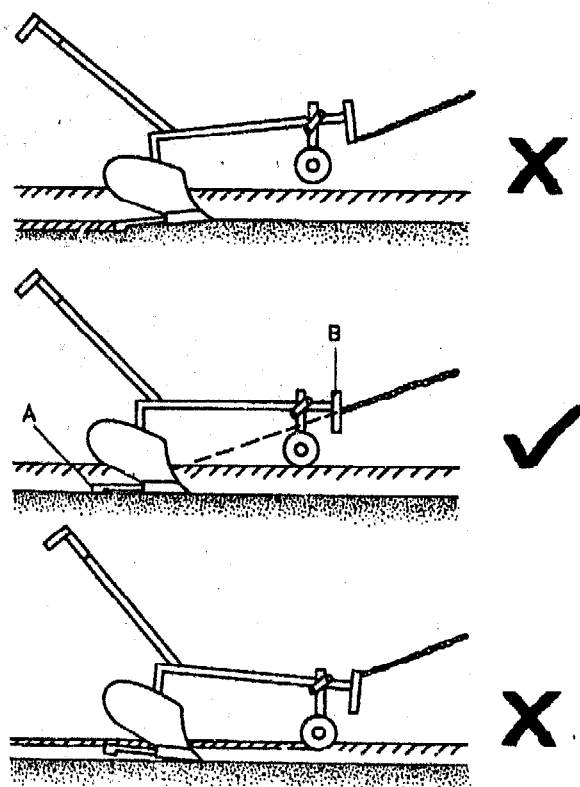


Fig. 2-5: Pitch adjustment of a plow (exaggerated).

A. Heel or end of the landside.

B. Hake or vertical regulator.

Top: Incorrect adjustment: wheel lifts off the ground and heel digs in too deeply. (Problem: too much leverage low down on regulator; solution raise the chain attachment. A similar problem is caused if the chain is too short).

Middle: Correct adjustment.

Bottom: Incorrect adjustment: wheel digs into soil and heel lifts out of furrow. (Problem: too much leverage high on regulator; solution lower the chain attachment. A similar problem is caused if the chain is too long).

principles of levers. The "eveners" used in the harnessing of multiple teams are simple levers, as are yokes. In either case if the position of attachment of the hitching is moved from a central position, levers of unequal length are created. The weaker animal requires a longer lever to help it, while the stronger can make do with the shorter one. Pressing down on the handle(s) of a plow can be thought of as a lever action. The rear of the plow-body acts as a fulcrum (pivoting

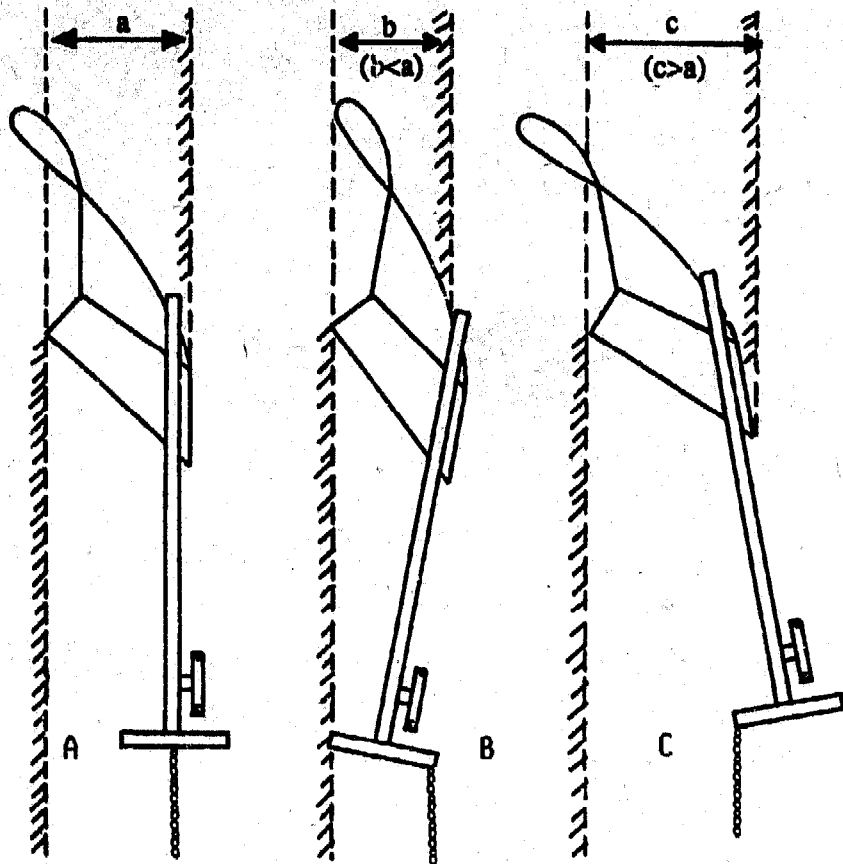


Fig. 2-6: Horizontal adjustment of a plow (exaggerated).

A). Chain attached to central position. Plow cuts furrow equal in width to share size.

B). Chain attached towards unplowed land. Lever effect of the regulator causes slight pivoting around central position which causes share to cut a narrower furrow.

C). Chain attached towards furrow. Lever effect of the regulator causes slight pivoting around central position which makes the plow body move through the soil slightly "crabwise" so that the share cuts a wider furrow.

Source: after Starkey, 1981

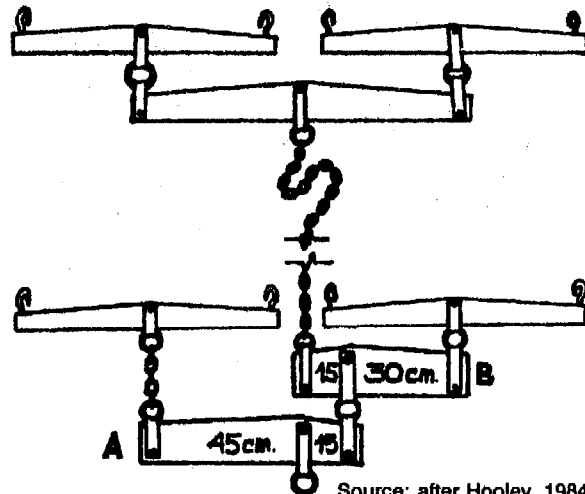
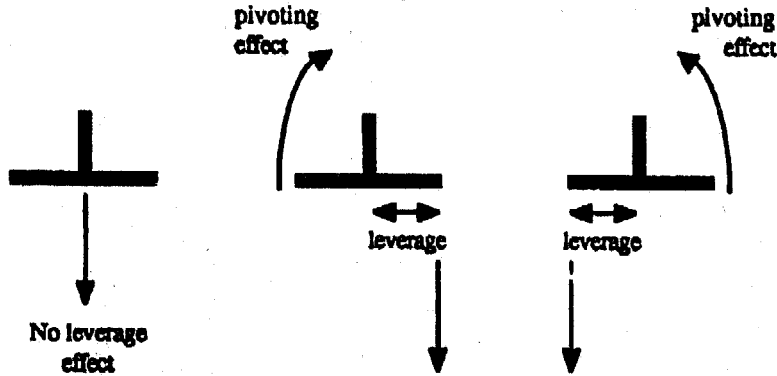


Fig. 2-7 (right): Eveners for a four-horse team.

The front (top) evener is symmetrical as the two front animals are assumed to be of equal strength. Evener B has a short lever of 15 cm to take the force of the front two animals, and a longer lever (2 x 15 = 30 cm) to allow rear right-hand animal to match this. Evener A provides a short lever for the three animals attached to it and a long lever (3 x 15 = 45 cm) to allow the rear left-hand animal to provide equivalent and balancing leverage.

Source: after Hooley, 1984

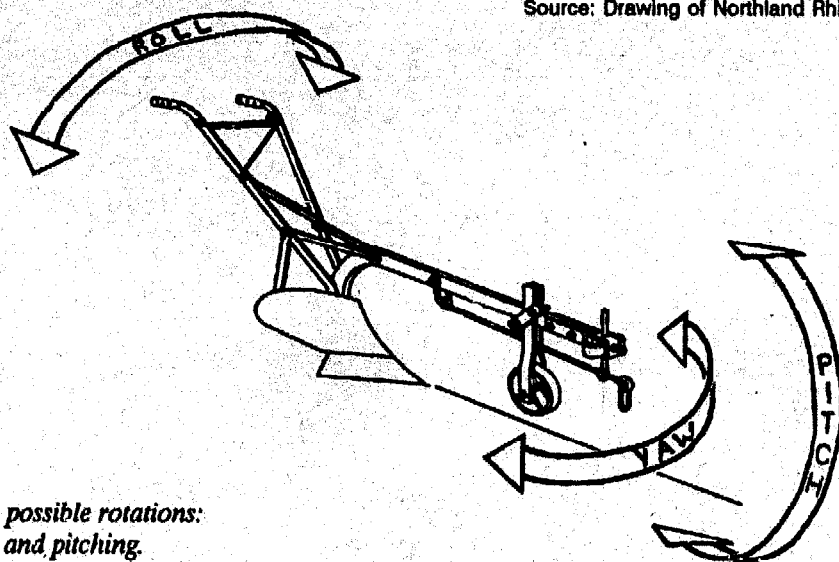


Fig. 2-8: Three possible rotations: rolling, yawing, and pitching.

point) so that downward leverage on the handle(s) causes the share to move upwards to a shallower depth. (Such a movement is one of the many reflex responses associated with plowing; it is most obvious when plowing at a reasonable speed in light soils; in heavier soils and at low speeds the plow is unlikely to be sufficiently in equilibrium to allow the operator to distinguish between the different leverage effects).

The width and pitch adjustments of a plow can also be understood in terms of levers. Moving the chain attachment or adjustment from a central position will cause a slight leverage effect, pivoting around that central attachment point. Moving the chain in either horizontal direction will cause the plow beam to pivot round a little, and the plow body will move through the soil slightly crabwise, as shown (exaggerated) in Fig. 2-6. If the movement is towards the unplowed land, the share will be skewed so that it is even more angled to the direction of movement, and thus it will cut a smaller slice of soil. If the traction chain movement is in the direction of the plowed land, the share will be pulled round so that it cuts a wider furrow. The pitch adjustment on the hake can be viewed in a similar way, as shown in exaggerated form in Fig. 2-5. Moving the chain upward causes the plow to pivot so that the heel rises and the share points

downwards. Moving the chain down causes the heel to press down and the share to point upwards.

Finally, in practical situations it is rare for all the forces acting on a body to be even and constant, so that any object in motion (be it a boat, aeroplane or plow) has a tendency to move in orientation in one or more planes. For convenience these are described in terms of three major planes at right angles to each other. The complex movements of an implement in use can be systematically analysed with reference to these three planes, and instability can be described in terms of pitching, rolling and yawing as illustrated in Fig. 2-8.

A simple swing plow is relatively unstable and thus requires considerable human effort to counteract all the tendencies to move out of equilibrium. *Pitching* (that is when the front moves up or down relative to the back, consequently changing working depth) can be minimized by using a land wheel (or skid) and a long landside with heel. *Rolling* (tipping over sideways) can be reduced with the use of a second wheel parallel to the depth wheel. *Yawing* (moving out of line, moving out of parallel with the direction of movement) can be reduced if the unbalanced side forces causing these "crablike" movements are absorbed by a landside and a furrow wheel or coulter.

3. Common harnessing systems

3.1 Harnesses and yokes: clarification of definitions

In both English and French, the word harness (*harnais*) has been predominantly used in the relatively narrow sense of the straps and fittings used for hitching and controlling horses or donkeys, and dictionaries in both languages generally define harness with reference to horses. For working oxen, the hitching together has generally involved a rigid yoke ("joug" in French), and historically the word "yoke" could also be used to describe a team of oxen. The French word "attelage" has no single word equivalent in current English usage but refers to the system of hitching animals together whether it be the yoking of oxen or the harnessing of horses. (*La culture attelée* is often used in the same sense as the English phrase *draft animal power*.) As with the word yoke, "attelage" can also be applied to the teams of animals themselves.

In three influential books published by FAO the word *harnessing* was used in a more general sense to cover the yoking of oxen as well as the harnessing of horses and donkeys (Hopfen and Biesalski, 1953; Hopfen, 1969; FAO/CEEMAT, 1972). This more general use of the word harnessing to cover all the elements involved in the "transmission" system linking the animals to their working implements (plows, carts etc.) was maintained in the reviews of Barwell and Ayre (1982) and Viebig (1982). The main CEEMAT publication on animal traction in Africa (CEEMAT, 1971) used the French word "*harnais*" in the restricted sense; however in his comprehensive monograph on the subject Duchenne

(1984) opted for the broader definition. These recent precedents will be followed and in this section harnessing will also be used in the broad sense of systems for linking animals to their workloads and, where applicable, to the person controlling them.

The introductory definition and etymological discussion is not merely to clarify some obvious confusions arising from evolution in the meaning of words. It also illustrates an important generalization. For several hundred years most English and French words relating to the "transmission systems" of animal power in both agriculture and transport have clearly differentiated between the bovine (ox) and the equine (horse, mule and donkey) types. In general bovines are hitched with yokes while equines are harnessed with collars or straps. The distinction is not absolute, for there are examples of equines being yoked and bovines being worked with collars, but if one takes either an historical or a geographical perspective, it is clear that the generalization apparent in the etymology is almost a universal rule. Thus in this section the standard harnessing/yoking systems will be described first, and the exceptions will be discussed under non-conventional usages.

The wide range of yoking types falls into two main categories, those tied to the horns of the animal and those taking power mainly from the *withers*. The "withers" of an animal refers to the part of the back that is over the shoulders, directly above the first thoracic vertebra. In Zebu (*Bos indicus*) cattle the withers are immediately in front of the hump.

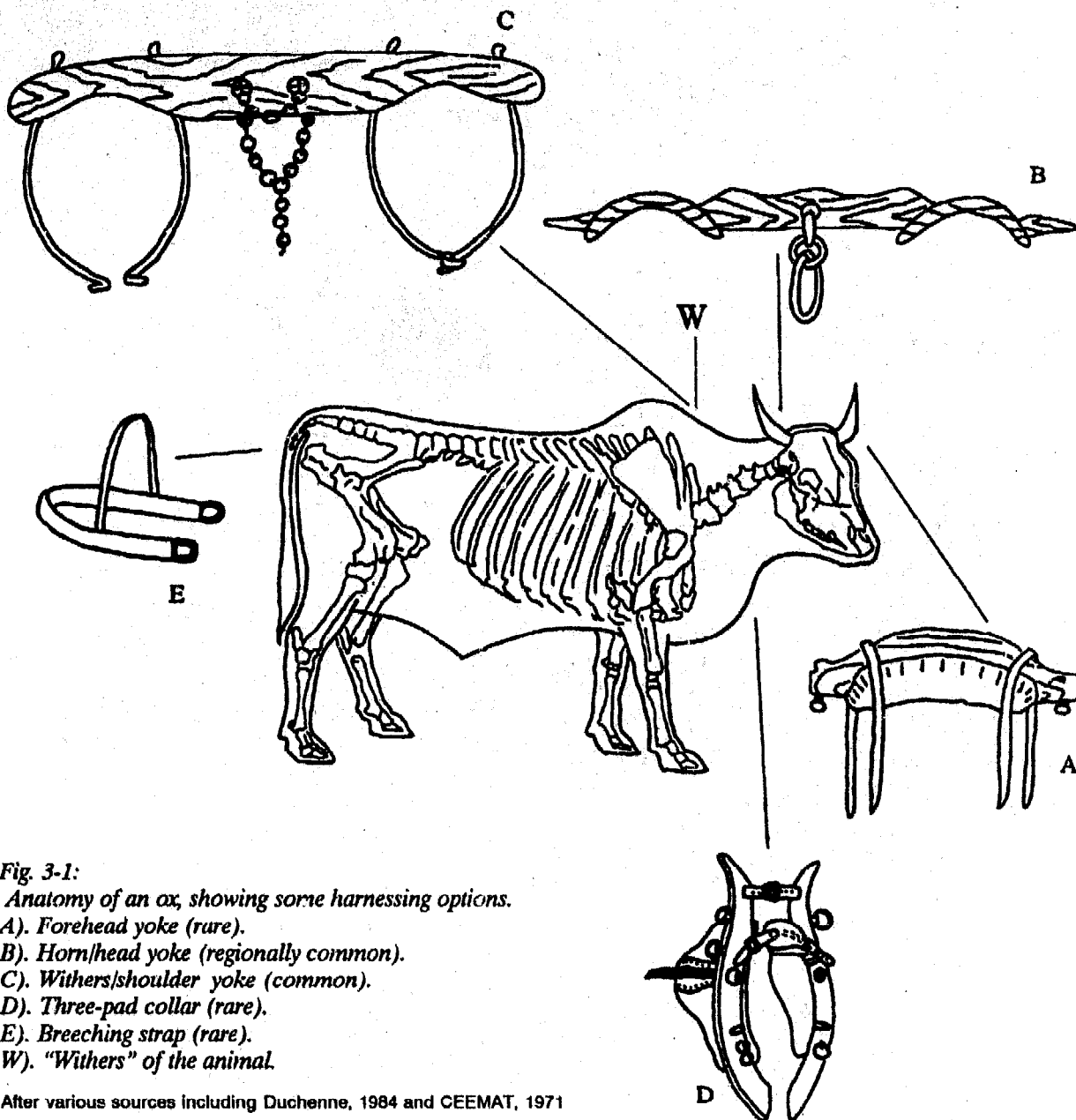


Fig. 3-1:
 Anatomy of an ox, showing some harnessing options.
 A). Forehead yoke (rare).
 B). Horn/head yoke (regionally common).
 C). Withers/shoulder yoke (common).
 D). Three-pad collar (rare).
 E). Breeching strap (rare).
 W). "Withers" of the animal.

After various sources including Duchenne, 1984 and CEEMAT, 1971

In English historical studies on yoking types the terms "horn yoke" and "head yoke" have been used synonymously, as have the terms withers and shoulder yokes (Fenton, 1973). Technically the shoulders are below the withers, and there are good arguments for dropping the term shoulder yoke, as it misleadingly implies that the power is applied from the shoulders. However the actual meaning of *withers* is not widely understood so that the term shoulder yoke can be quite useful in distinguishing between different yoke types. In

French the term *joug de garrot* is equivalent to withers yokes while *joug de corne* and *joug de tête* have both been used for horn/head yokes (Delamarre, 1969; Duchenne, 1984).

Horn/head yokes are occasionally used in front of the horns, where they are described as forehead yokes (*joug frontal*). More commonly they are fitted behind the horns, and in this position they have sometimes been called "neck yokes" (*joug de nuque*). However the use of the word "neck" has been the source of

considerable confusion in the international literature. Hopfen (1960; 1969) classified yokes tied to the horns as head yokes and described yokes taking power from the withers as "neck yokes". Ramaswamy (1981) followed a similar convention. In contrast FAO/CEEMAT (1972) classified the yokes tied to the horns as "neck yokes", and those resting on the withers as shoulder yokes. Viebig (1982) used a similar classification, although he preferred the term withers yoke to shoulder yoke. Two recent specialist texts on yoking systems have followed the Hopfen definitions and used the term neck yoke to describe the withers/shoulder yoke (Devnani, 1981; Barwell and Ayre, 1982).

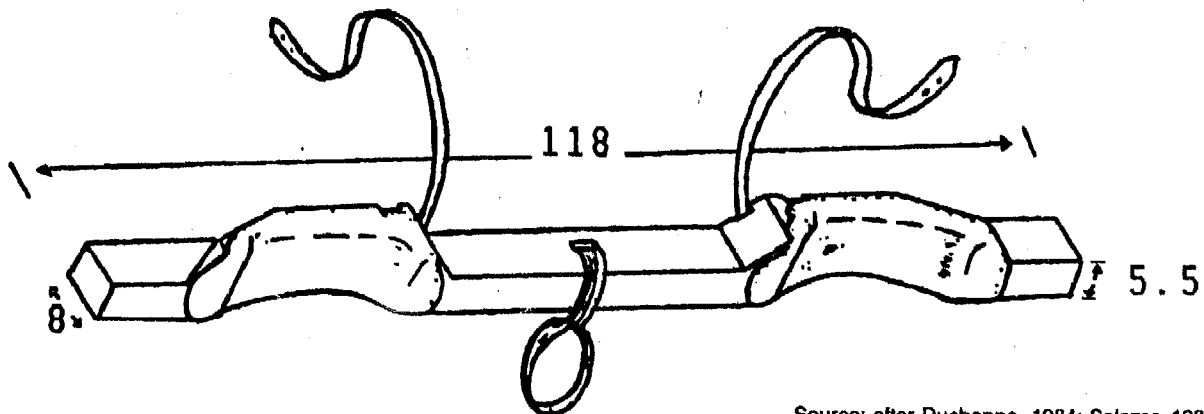
Thus although all texts agree that there are two very distinct categories of yoke, depending on the context and source, the words "neck yoke" can refer to either of these different types! Since the neck is defined as the part of the body between the head and the thoracic vertebrae, both yoke types can indeed be claimed to rest at one or other extreme of the neck. Of the two uses, the FAO/CEEMAT definition of neck yoke is to be preferred since it is a reasonable translation of *joug de nuque*, and there does not seem to be the same confusion in the French language. One of the authors responsible for revitalizing the "neck yoke = withers yoke" definition subsequently used the clearer and less controversial terms head yoke and shoulder

yoke (Barwell and Hathway, 1986). This may imply that the withers application of the term neck yoke may be decreasing. However it is recommended that to avoid further confusion over conflicting definitions, the use of the term "neck yoke" should be avoided. Thus the major yoke types will be classified here as *horn/head yokes (joug de corne/tête)* for those tied to the horns, and *withers/shoulder yokes (joug de garrot)* for those taking power from the withers.

3.2 Horn/head yokes

There have been examples in Europe, Latin America and Africa of forehead yokes (*joug frontal*), tied in front of the horns. While single forehead harnesses (Fig. 3-1) have been used effectively in Germany, the use of double forehead yokes (Fig. 3-2) is very uncommon. In one controlled study in Bolivia, using a circular, experimental track, forehead yokes were found to allow greater maximal force and greater overall power over a six hour period than head yokes tied behind the horns, withers yokes or even three-pad collars (Salazar, 1981). It seems agreed that forehead yokes require more careful fitting and padding than other forms of head yoke, and that there may be greater risk of injury to the head if they are not correctly fitted. Most of the other characteristics of forehead yokes are similar to the more widespread designs of horn/head yokes which will be discussed in greater detail.

Fig. 3-2: Double forehead yoke of a design evaluated by researchers in Bolivia (dimensions in cm).



Source: after Duchenne, 1984; Salazar, 1981

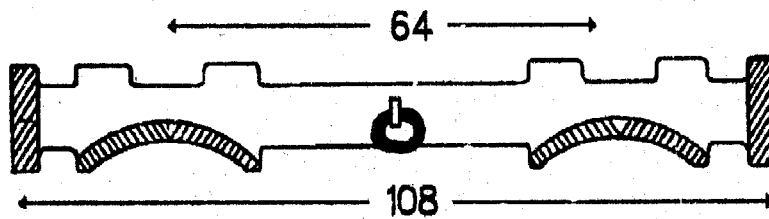
Most head yokes are tied behind the horns (*joug de nuque*). Such yokes are commonly employed in West Africa, Latin America and Southern Europe, where they are used mainly on humpless (taurine) cattle. Simple uncarved wooden poles can be used as head yokes (Fig. 3-3), but these tend to rotate and slip and cannot be recommended. It is therefore usual to carve the yokes in such a way that they both fit the heads and also have grooves and protrusions to allow easy and firm attachment of the ropes or straps (Fig. 3-4). A wide variety of shapes is used and the carving of yokes has become part of the folk art in some countries (de Oliveira, Galhano and Pereira, 1973). There appears to be no evidence that the different designs of head yoke have a significant impact on working efficiency, provided they are properly secured. An example of a securing system for a horn yoke is shown in Fig. 3-5. Ropes or leather straps can be used for securing the head yokes, depending on local availability. Some light padding may be desirable, although a well fitting yoke of smooth wood may itself be less abrasive than rough material such as sacking.

A head yoke must be strong, but it should also be light for maximum comfort to the animals. In countries where such yokes are tradi-

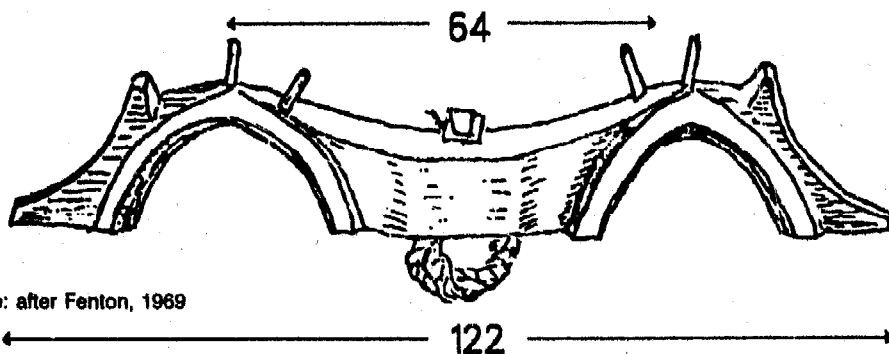


Photo: Paul Starkey

Fig. 3-3: Head yoke in The Gambia.
Simple uncarved head yokes such as this one are difficult to secure firmly and have a tendency to slip. Note also the nose rein system.



Source: after Starkey, 1981



Source: after Fenton, 1969

Fig. 3-4:

Drawings of head yokes (dimensions in centimetres).

Top: Head yoke used by Sierra Leone Work Oxen Programme.

Below: English head yoke of 18th century

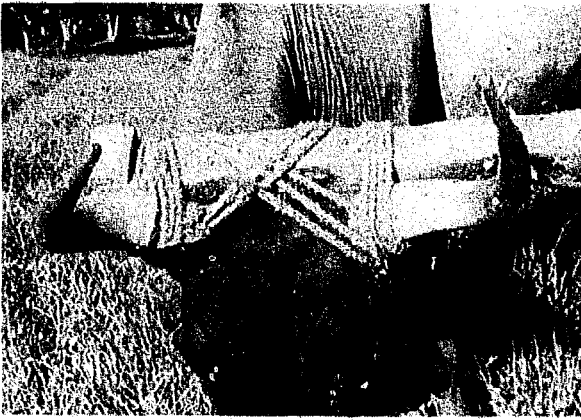


Photo: Paul Starkey

Fig. 3-5: Method of attaching head yoke to horns in Sierra Leone.

tional, there are favoured woods known to combine these features, and in countries where head yokes are being evaluated, local knowledge of tree species should be sought to identify suitable woods.

Horn/head yokes are most suitable on cattle with relatively short and strong necks. They require the presence of good horns to securely attach the yoke, and fixing the yoke is easier if the horns sweep forward and upward, rather than backwards or downwards. Since most draft animals come from cattle breeds with horns that are naturally long, the use of head yokes should not greatly affect the choice of animals, although polled (hornless) cattle or

individuals with broken or weak horns will be unsuitable. Once a head yoke has been firmly tied to a pair of animals, they are less free to toss their heads and horns. This is often seen as an advantage, for it provides greater safety and confidence to inexperienced users, particularly if the animals are only partially trained. Similarly once the yoke is fitted, the animals cannot damage each other with their horns. However the loss of movement restricts the ability of the animals to ward off flies by tossing their heads, and some people consider the loss of free head movement causes the animal significant discomfort.

As head yokes are firmly attached to the horns, the yoke can be used to apply forces in several directions. For example, in forestry operations animals can lift the ends of logs by raising their heads, and they can apply powerful braking forces to restrain a tree trunk moving too quickly down a hill (Fig. 3-6). When implements and carts are pulled by a rigid drawbar rather than a traction chain, head yokes that are securely fastened to the animals can facilitate braking and reversing. In similar circumstances, withers yokes that are not rigidly attached to the animals may ride forward onto the heads of the animals (this can be prevented by transferring such forces to the rear of the animals through

Fig. 3-6: Oxen with head yoke logging in Malawi. Head yokes can be used for lifting, pulling and braking logs.

Photo: Paul Starkey





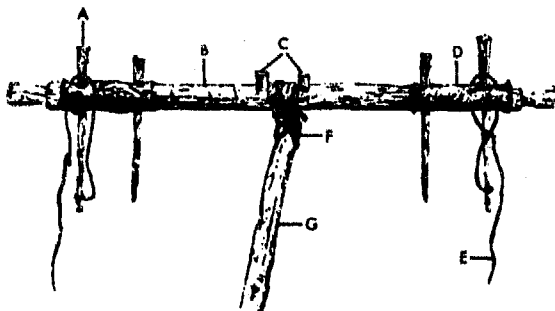
Photo: Paul Starkey

Fig. 3-7: Example of poorly fitted head yoke on small, inexperienced animals in Sierra Leone.

breaching straps or by suitable bars fitted to a cart).

A well secured head yoke should not cause skin abrasions, since there should be little scope for movement and rubbing. However the vibrations of work are transmitted directly to the head, which may be a source of discomfort. In addition the lack of movement may mean that the neck or head is held in a twisted or otherwise uncomfortable position (Fig. 3-7). Nevertheless there seems no objective evidence to suggest that head yokes differ significantly from withers yokes in overall comfort, and suggestions of cruelty probably relate to occasions when yokes have been incorrectly fitted or used.

Fig. 3-8: Withers yoke used in Ethiopia
A - wooden peg; B - yoke beam; C - wooden, centre pegs; D - padding; E - leather neck strap; F - leather, thong for tying plow beam (G).



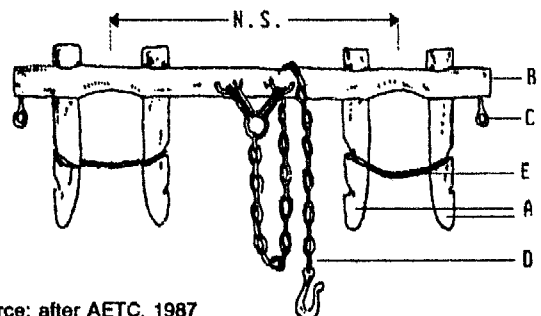
Source: Goe, 1987

Head yokes have been successfully used in many parts of the world on both humped (zebu) animals and humpless (taurine) cattle. Although they have mainly been used with humpless cattle, they should not be regarded as limited to these animals.

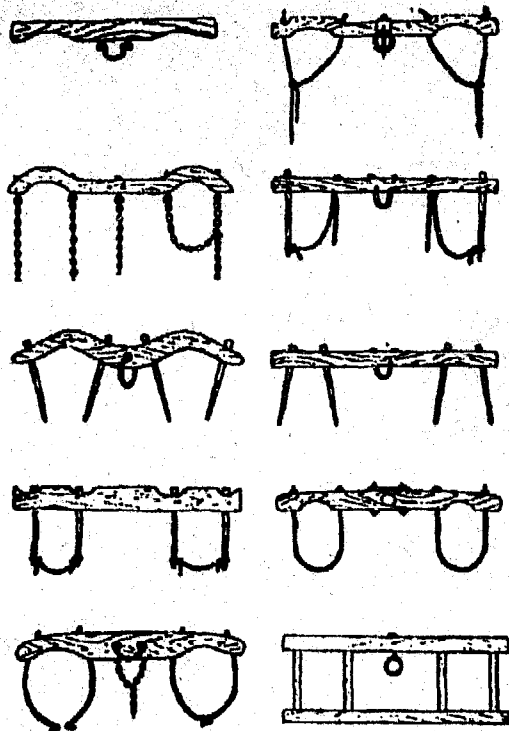
3.3 Withers/shoulder yokes

Withers yokes are numerically the most important system of harnessing in the world. They are almost universally used in Asia and Ethiopia, and are widely used in parts of western, eastern and southern Africa and areas of Europe and the Americas. They are almost always made of wood, although a few projects in Africa and Asia have made yokes from steel pipe. In their simplest form they are just wooden poles with small descending pegs (sticks) to restrict lateral movement. These pegs, also known as staves or skeis, may be joined by a loose rope, chain or strip of hide, but this has no draft function and does not (or should not) pull against the windpipe (Fig. 5-5). The wooden yokes may be shaped into double bows to more closely match the shape of the withers, thus giving a greater surface area of contact (Fig. 3-13). Such simple shaping may well be the simplest and most cost-effective means of increasing the comfort and therefore the effectiveness of a wooden yoke.

Fig. 3-9: Withers yoke used in Zimbabwe.
A - wooden pegs "skeis"; B - yoke beam; C - eyes for steering ropes; D - trek chain; E - leather thongs "strops". N.S. - Nominal size.



Source: after AETC, 1987

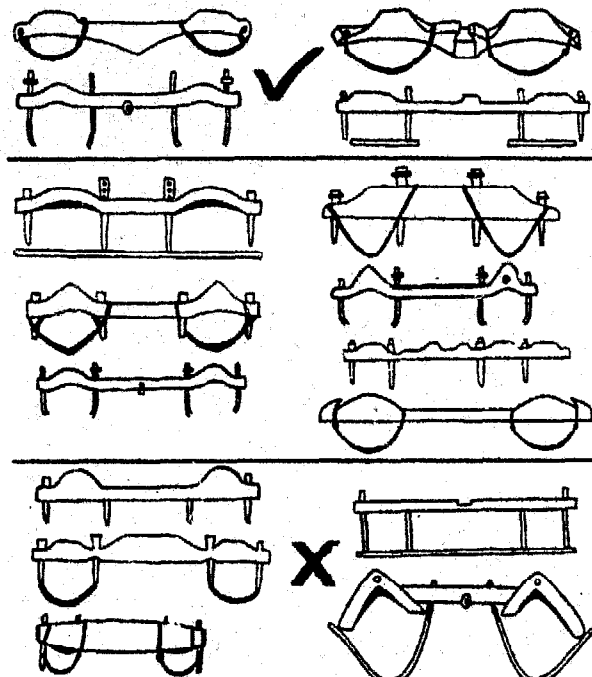


Source: after Viebig, 1982; Casse et al., 1965

Fig. 3-10:
Examples of withers yokes used in Africa.

Withers yokes can be lightly padded, and in Ethiopia the traditional yoke is padded with sheepskin or cloth covered with cowhide. Some designs of withers yokes can be seen in Figs 3-8 to 3-13. The ornamental carving or painting of withers yokes has developed into an artform in some countries.

The descending rods may be made of metal, and may join together and in some yokes they are in the form of a U that rises into the yoke beam during fitting. These are functionally equivalent to some traditional European and North-American yokes which had ascending bows made from wooden poles specially bent into the shape of a U. More rarely the descending rods are joined by a second horizontal pole to form a frame (Figs 3-10 and 3-11). The yokes that fully surround the neck with a frame or with U- or double-J-rods provide a greater sense of security for the operator, but are more difficult to remove quickly should one animal fall. It has been claimed that large



Source: after Vaughn, 1947

Fig. 3-11: Withers yokes from different locations in India tested in 1944. Oxen gave significantly higher average dynamometer readings with the top four designs than the bottom five designs, although this was not clearly correlated with contact surface area, shape or weight. The yoke that performed worst in the test was the bottom right "improved" yoke.

bows, staves or rods may provide useful, additional surface area against which the shoulders of an animal can push (Kivikko and Rosenberg 1987). However while the main beam of a withers yoke is in more-or-less permanent contact with the animal, the movement of the shoulders means that the staves are only in contact some of the time so that they cannot be used like a yoke for sustained effort. In general, yoke staves are neither spaced nor shaped for work application. To attempt to develop them for such use and at the same time avoid rubbing is likely to lead to a variation of the three-pad or collar-type harnessing systems which, as will be discussed, have both advantages and disadvantages.

Withers yokes can be very simple and easily manufactured with little carving. Thus they can be cheap although this is not a simple rule as some designs in use are quite expens-



Photo: Paul Starkey

Fig. 3-12: Uncurved pole withers yoke in Tanzania with wooden descending rods,

ive and complicated to fit. They allow the animals to move their heads freely, and because they do not require horns, they can be used with polled cattle or even equines. As withers yokes are not attached securely they can move relative to the skin; unpleasant abrasions or yoke galls can develop when such movement is prolonged or excessive. Withers yokes are designed to transmit forces during forward motion only and they cannot easily be used for braking carts, or for reversing, unless a back *breaching* strap (or rope) is used to prevent the yoke moving forward. Such straps are seldom used, and the problem is partially overcome on carts in India by the fitting of a bar on the cart immediately behind the animals. When descending a hill, braking or reversing, this bar contacts the animals and takes the forces before the yoke is pushed onto the animals' heads.

3.4 The length of yokes

The length of yoke can be important in ensuring the efficient management of draft animals, although it should not affect the actual draft power. The more widely spaced are the animals, the greater the potential leverage of one animal on the other, and the greater the risk of accidental damage due to yokes. Farmers in



Photo: FAO archives

Fig. 3-13: Curved withers yoke in Mali. There are no descending bars, the yoke being held in place by its curvature and loose rope ties.

the central Ethiopian highlands prefer using a short yoke when plowing heavy soils as they believe it concentrates the forward pulling force of the team. Longer yokes are preferred on rough terrain because wider spacing between the oxen improves both animal stability and the ability of the farmer to manoeuvre the ard plow (Goe, 1987). In general for both plowing and transport it is recommended that animals be close together but without actually touching each other or the traction chain or shaft. The actual dimensions of a yoke should

Fig. 3-14: Selection of head yokes used at a university farm in Sierra Leone.

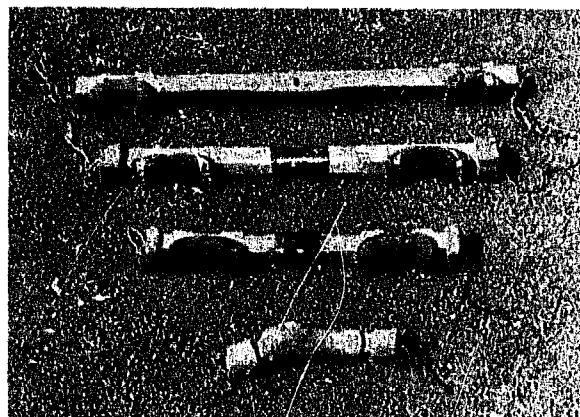
Top: Weeding yoke (nominal size 132 cm);

Middle: Ridging yoke (N.S. 90 cm);

Plowing yoke (N.S. 64 cm);

Bottom: Single yoke.

Photo: Paul Starkey



Source: after Starkey, 1981

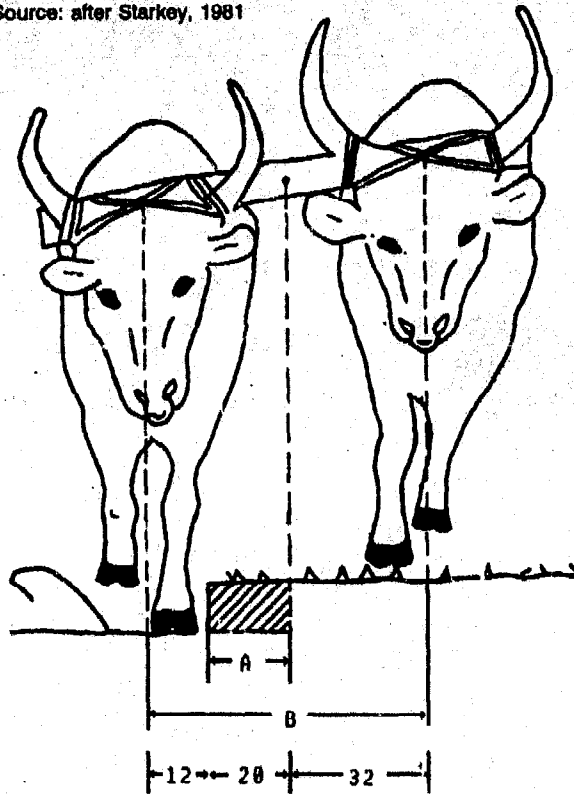


Fig. 3-15: Illustration of relationship between yoke size, share size and line of draft.

A - Nominal size of plow share.

B - Nominal size of yoke.

Figures (in centimetres) illustrate a 20 cm share being used with a 64 cm yoke. If other share sizes were used with this yoke, the horizontal regulator could be used to achieve the appropriate line of draft.

be determined by the breed/species of the animal and the operations to be performed. The nominal size of a yoke refers to the distance between the centres of each animal position (Fig. 3-9). For weeding, the nominal size must be a multiple of the row spacing. Thus for weeding 66 cm rows a yoke with an nominal size of 132 cm (2×66) is required and for weeding 90 cm rows a 180 cm yoke would be used.

For plowing, it is best if the length of the yoke ensures that with one animal walking in the furrow, there is a direct line of draft to the plow (Fig. 3-15). Typical nominal sizes for plowing yokes are 64 cm for a head yoke for N'Dama in Sierra Leone, 75 cm for a withers

yoke in Niger, 85 cm for a forehead yoke in Bolivia and 90 cm for a withers yoke in Zimbabwe. If one uses a plowing yoke for ridging, to obtain a direct line of draft the furrow animal must walk on the previous ridge. This can be avoided by using a longer yoke with a nominal size of twice the inter-ridge spacing to allow the furrow ox to walk in the inter-ridge furrow.

For transport use it may be advantageous if the nominal size of the yoke is equal to the wheel-track of the cart. This will mean that the animals walk directly in front of the wheels, and are therefore likely to avoid objects that might obstruct or puncture a tyre (AETC, 1986).

It was noted in Chapter 2, that a yoke can be considered as a lever, pivoting about the point of attachment of the chain or pole. With animals of similar strength the levers should be of equal length. However should one animal be significantly stronger than another, this can be compensated for by adjusting the relative lengths of the levers, by changing the point at which the chain or pole attaches to the yoke. Some North American yokes have special slide rings, to allow the driver to make small, rapid and precise changes in length of each lever (Conroy, 1988). Improvisation is more common, for example the draft chain may be wound round the yoke once, to the left or right of the central attachment position (although this may also cause the yoke to rotate). The weaker animal needs more leverage, and so is provided with a longer lever by moving the chain towards the stronger animal.

3.5 Single yokes

Both head yokes and withers yokes can be used with single cattle, but since *cattle* are seldom used singly for field operations, single yokes are relatively uncommon. In parts of China and southeast Asia single buffaloes are commonly worked with withers yokes in the form of an inverted V. In these same areas

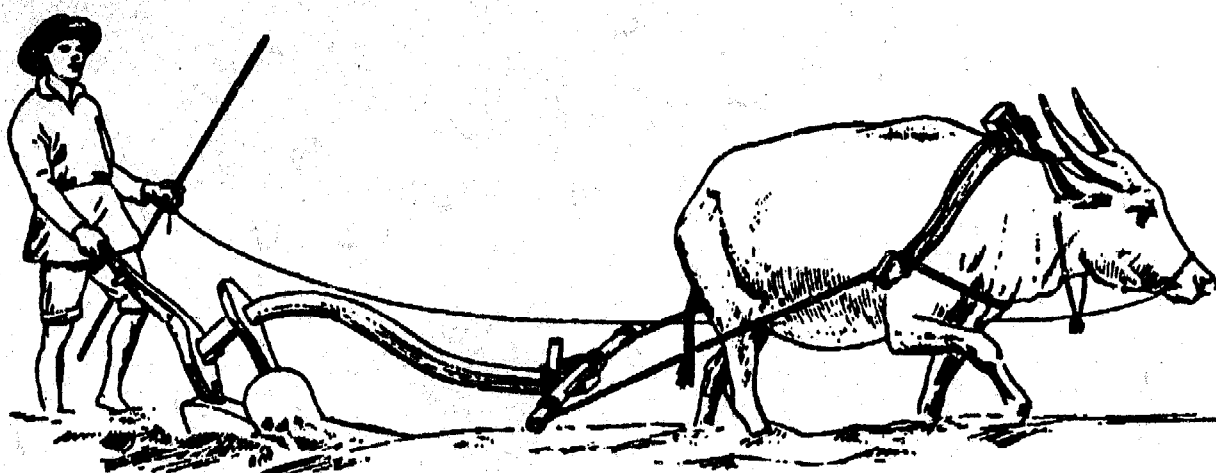


Fig. 3-16: Use of single withers yoke with water buffalo in China.
The plow is attached directly to the swingle tree.

Source: Hopfen, 1969

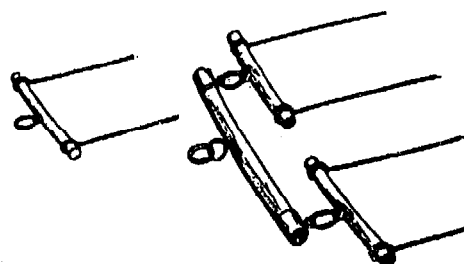
cattle are usually worked in pairs, although in parts of China single oxen may be worked with yokes similar to those used with buffaloes. It is not uncommon for single cattle to be yoked for transport, and a withers yoke may be permanently attached to the shafts of cart (Fig. 3-21). Single yokes are generally employed with relatively large animals.

While with double yokes the implement is attached to the centre of the yoke, with single yokes one attachment point is impractical. The force of the single animal must be transmitted from the yoke to traces or shafts attached to either end of the yoke and which pass back on either side of the animal. For transport purposes the shafts can attach directly to the frame of the cart and the yoke may even be permanently fixed to the shafts (Fig. 3-20). For crop cultivation the two traces are generally attached to either end of a small pole known as a *swingle tree*, and the work load is applied to the centre of this pole (Figs 3-16 and 3-17). One possible technical advantage of single yokes is that the attachment points of the shafts or traces are often (but not always) lower than they are on double yokes. Lower attachments should allow a lower angle of pull, so that less of the animal's power is used in "lifting" forces. However a single yoking system with side traces and swingle trees is generally more

complicated to set up and work with than operations employing a double yoke. The two traces and swingle tree seem more liable to become caught up under the animal's feet during turning at the end of a row than one traction chain or beam. When using a single animal, the mutually reinforcing effect of two animals is lost.

A single animal can often achieve, in any one day, more than half of that which would have been achieved by a pair. This does not necessarily imply greater efficiency of the yoking system; if the animal achieves more it is because it is working harder. For very light operations (such as single-row seeding in light soil) yoked pairs do not have to work hard, so that if a single animal works twice as hard as a comparable animal in a pair, it can actually equal the work of a pair. The implications of such a situation for speed, draft and power output were discussed in Chapter 2, and illus-

Fig. 3-17: Swingle trees and evener for joining two swingle trees.



Source: Hopfen, 1969

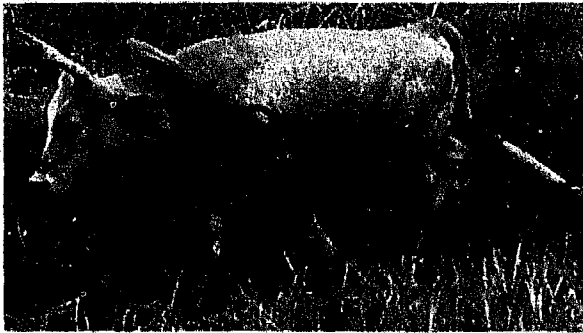


Photo: Paul Starkey

Fig. 3-18: Single withers yoke of Chinese design being tested in Sierra Leone. Note: in this test, the rope was tending to constrict the windpipe.

trated in a simplified way in Fig. 2-4b. However it must be stressed that a single animal can only approach or match the daily performance of a pair for a few, light operations.

The extra work that a single animal has to perform, compared with one in a pair, is not "free", for it will require more energy from feed than when it is worked as part of a pair. A working single animal will not normally by itself require as much feed as two animals, and since there is only one basic maintenance requirement, that "marginal extra" amount of work can appear quite efficient in terms of energy. However the limitations imposed by both grazing time and the physical bulk of a poor roughage makes it difficult for a single animal to eat enough during normal grazing to make up for the extra work. For a short time this may not matter (the animal will simply lose weight), but if animals are to be regularly worked as singles, the extra feed needed for the extra work may have to be supplied in a more concentrated form as a supplementary feed. The "marginal extra" feed can therefore be quite costly since concentrated feeds are more expensive than rough grazing. If supplements are required it may well cost more in monetary terms to feed a single animal than it does to feed a full working pair existing on grazing only. Naturally circumstances vary greatly, and there will be situations in which it is more appropriate or cost-effective to use single animals, and others when pairs will be

preferable. It is however totally misleading to imply (as some people have done) that simply by using a single yoke, one animal can actually replace two animals.

In many African countries research and development workers have advocated the use of single oxen, particularly for light operations, such as sowing and weeding, but this has seldom been adopted (Matthews and Pullen, 1976; Starkey, 1981; Viebig, 1982). In the last few years research on the yoking or harnessing of single oxen (*"monobeouf"* in francophone countries) has increased substantially and in 1988 there were few countries in Africa without one or more programme investigating or advocating the use of single animals. Nevertheless this fashion has yet to be widely adopted by farmers.

Some of the enthusiasm for single yokes was stimulated by the International Livestock Centre for Africa (ILCA) which in 1983 reported "ILCA has found that a farmer does not need to have two oxen for cultivation" (ILCA, 1983a) for "the assumption that two oxen are needed for cultivation has hindered progress for centuries" (ILCA, 1983b). These

Fig. 3-19: Single ox with head yoke weeding on a university farm in Sierra Leone.

Photo: Paul Starkey





Photo: Paul Starkey

Fig. 3-20: Demonstration of a single withers yoke, swingle tree and modified maresha plow being used with a large ox at an ILCA Research Station in Ethiopia. In the background is an earth-moving scoop.

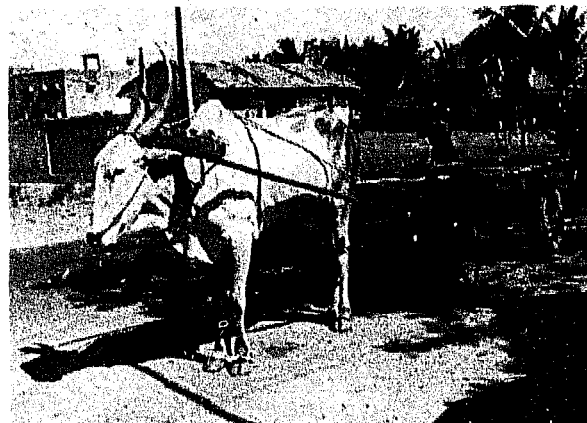
statements referred to research on the use of single withers yokes and shortened *maresha* ards for plowing in the Ethiopian highlands. The research itself was entirely valid but these quotations have been cited to illustrate that some of the resulting publicity was disproportionate. Although the research itself clearly referred to the highlands of Ethiopia, the subsequent simplification of the research results into generalized news items which diffused widely led to quite rampant misconceptions that ILCA was advocating a general use of single animals in Africa. In fact, ILCA scientists had simply been investigating one technology option for Ethiopian farmers who had only one animal! (Gryseels *et al.*, 1984).

Much of the early optimism reported by ILCA staff had been based primarily on the initial on-station studies. However when ILCA scientists conducted larger scale on-farm "verification" studies, they identified several important disadvantages that tended to offset the well-publicized advantages. The traditional long-beamed *maresha* is normally attached directly to the double yoke, and this provides the Ethiopian farmers (who work their animals single-handedly) with good

handling characteristics, and allows them to easily lift the plow when encountering a stone, or when turning. In contrast when a single yoke is used, the shortened *maresha* has to be attached to a trailed swingle tree and this arrangement, with much less rigidity, does not provide such stability and manoeuvrability (Jutzi and Goe, 1987). Moreover farmers found that with the single yoke, the mutually supporting effect of the two animals was lost. These reasons, together with cultural influences, and the structural problems encountered when replacing a long beam with a short

Fig. 3-21: Single withers yoke permanently attached to the shafts of a trailer in southern India.

Photo: Paul Starkey

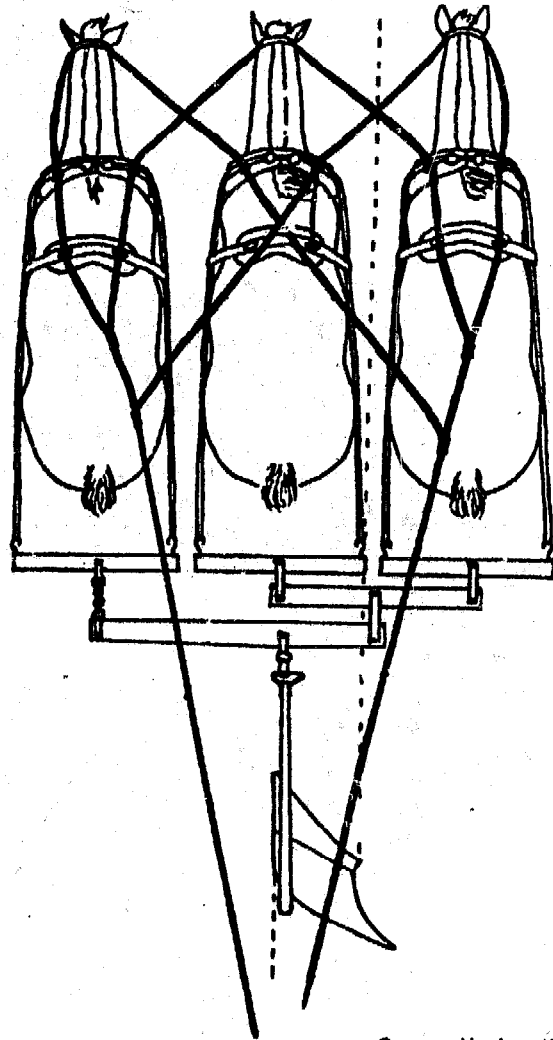


beam and skid, led the majority of farmers involved in the "verification" trials to revert to using double yokes. Indeed almost all the 1200 farmers participating in the trials yoked their one ox together with an ox of another farmer for the primary and secondary plowing, believing the power of two oxen was required for such tillage. While a few farmers used the single-yokes for subsequent lighter tillage, these represented fewer than 5% of the cooperating farmers. As a result it was concluded that while the single-ox plow might have some applications for secondary tillage under favourable conditions, it was unlikely to replace the use of paired oxen in primary land cultivation (Jutzi and Goe, 1987). Thus the traditional double yoke is likely to remain the harnessing system of choice in the Ethiopian highlands in the foreseeable future.

In conclusion, for many years development workers have felt that distinct benefits could be obtained from the selective use of single oxen. However few farmers in Africa have adopted these recommendations. In general the more widespread use of single animals is only likely to occur where standards of animal training are high, where single animals are sufficiently strong to perform the work easily and without the need for much encouragement and where there are strong economic or social reasons why teams of animals are impracticable or undesirable.

3.6 Multiple Hitching

Multiple hitching can be abreast or in tandem (one behind another). Animals harnessed with collars or breastbands are frequently hitched abreast, with their two swingle trees joined by an *evener* (Fig. 3-22). With equally matched animals the work can be applied to the centre of the evener, but the evener can be used to "even up" the work of animals of different strengths. The attachment point is moved away from the weaker animal to give it a longer lever on which to pull. With large teams of independently harnessed animals



Source: Hooley, 1984

Fig. 3-22: A suggested (but seldom practised) system for using three horses with two eveners in Bolivia.

several eveners can be used in a hierarchical pattern, but this is very uncommon in tropical countries. Through the use of eveners, young animals can assist with work during training and different breeds or species can be hitched together. However although intrinsically very simple, eveners contribute to the overall complexity of harnessing, and increase the time required to hitch up the harnesses and the potential for having the harness tangled or caught on an obstruction. When independently harnessed animals are joined with eveners, it is also usual to loosely link their heads or shoulders with *couplings*, cords run-



Photo: Paul Starkey

Fig. 3-23: Team of eight male and female animals being trained in Botswana. The withers pole yokes are linked with chains.

ning between their collars or bridles to ensure they move forward in a parallel manner.

The hitching of pairs or even single animals in tandem has been a common practice for both agriculture and transport in many regions. For multiple hitching of oxen, chains pass from yoke to yoke to link the animals, while with hitching of horses, donkeys or mules traces of the leading pair pass back to additional swingle trees in front of the second and subsequent pairs (Fig. 3-23). In Europe the employment of multiple teams of oxen became a standard practice in some areas. In Asia the use of pairs of animals for crop cultivation is the norm but farmers in the heavy black cotton soil (Vertisol) areas of India frequently hitch two or three pairs of oxen to a single mouldboard plow to achieve penetration in

hard soils (Fig. 3-24). In Botswana the use of teams of at least three pairs of cattle is the normal practice, and teams can have as many as sixteen animals in eight pairs. In such large teams it is usual to include all available adult animals - oxen, bulls, cows and heifers. Interestingly farmers with fewer than six available animals consider plowing impracticable, yet there has been little acceptance of the "lower draft" farming techniques developed by researchers between 1970 and 1986. Elsewhere in southern and eastern Africa, including parts of Angola, Kenya, Mozambique, South Africa, Swaziland, Tanzania, Zambia and Zimbabwe there are certain areas where it is normal for four or six animals to be yoked for plowing. In other localities in the same countries it is usual to work only two animals at a

Fig. 3-24: Two pairs of oxen pulling a reversible plow in India.

Photo: Paul Starkey



Source: after FMDU-ATIP, 1987

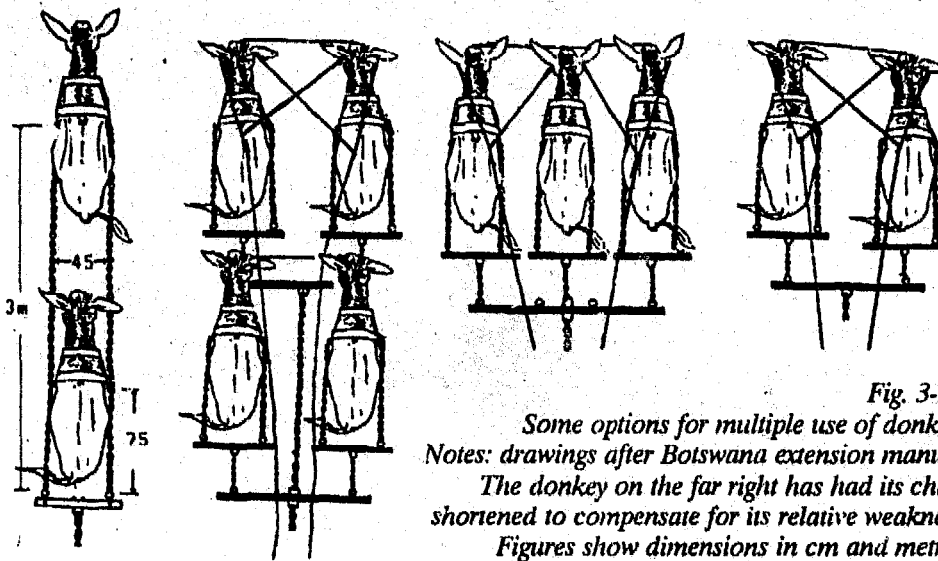


Fig. 3-25:
Some options for multiple use of donkeys
Notes: drawings after Botswana extension manual.
The donkey on the far right has had its chain
shortened to compensate for its relative weakness.
Figures show dimensions in cm and metres.

als are used with *independent hitching* there is considerable scope for reins and traces to become tangled.

Multiple hitching can be used by relatively wealthy farmers owning many animals or it may be organized on a community basis, with individuals

time. The use of multiple teams in northern and western Africa is uncommon.

A less common practice is to work yoked pairs side by side by hitching both pairs to the same implement, usually a wide harrow or leveller. If the traction chains are attached to each end of the implement, eveners may not be necessary (Fig. 3-25). Such a system requires large fields if turning is not to be a major inconvenience.

Multiple hitching with *yokes* does not normally require much extra training, since the animals have fewer options for movement, and there is some mutual training between the animals themselves. If poorly trained ani-

contributing their own pairs. One obvious advantage is an increase in available power. This may allow the use of larger implements or deeper plowing. For example in Botswana, where large teams are worked, very broad 37 cm plows and some double mouldboard plows are often employed. Where animals plow in pairs, as in most of West Africa, 15-22 cm plows are more common. Multiple teams are only suitable for large fields, as the time and the space required to turn a big team is considerable. Inevitably with large numbers of animals, operations involving great precision are difficult.

Multiple teams with larger implements allow increased output per worker and per plow. Since teams of six to eight animals are typically controlled by two or three people, larger teams can lead to a lower ratio of workers to animals, which may be particularly advantageous in areas where animals are plentiful. Where soil conditions are not ex-



Fig. 3-26:
Use of two pairs of oxen abreast
for field levelling in India.
Photo: Paul Starkey

treme and where human labour is not in short supply, the same number of animals could be yoked in pairs entirely independently, each pair drawing its own small implement. Similarly a given number of animals can either be hitched to one large cart or several small carts. The use of many small teams leads to greater manoeuvrability and organizational flexibility, but implies more workers and more equipment. Comparable arguments apply to the relative merits of using a few large animals or many smaller animals. The merits of these various options will depend mainly on whether one large, combined unit of power is actually necessary and whether animals are plentiful relative to humans.

It has been widely assumed that hitching animals in large teams leads to a decrease in overall efficiency, perhaps of the order of 7-10% per additional animal (CEEMAT, 1971; FAO/CEEMAT, 1972). Goe and McDowell (1980) quoted figures from the United States illustrating that achieved work rates with teams of 4-12 horses were not directly proportional to the numbers of horses used, and often the same amount of work could be achieved with five horses as with six. The relationship between animal numbers and work is discussed in Chapter 10.

In conclusion, the use of multiple teams of animals may be appropriate in areas with



Photo: Henk Dibbits

Fig. 3-27: A research-extension project in Kenya demonstrates the possibility of plowing with a team of donkeys.

large fields where operations require high draft power and where animals are plentiful relative to labour and equipment.

3.7 Harnessing for donkeys and horses

In a few areas of southern Africa, including parts of Malawi, Mozambique and Zimbabwe, donkeys are used with withers yokes, similar to those used for cattle (Fig. 3-28). Yoked donkeys, horses or mules are also sometimes used with padded withers yokes in North Africa, Ethiopia, Portugal and the Middle East (Fig. 3-29). One reason for yoking equines is simply for convenience and simplicity where withers yokes for oxen are already available, and where equine harnesses are not easily ob-

Fig. 3-28: Donkeys fitted with withers yoke for transport in Malawi. Yoking donkeys is rare.

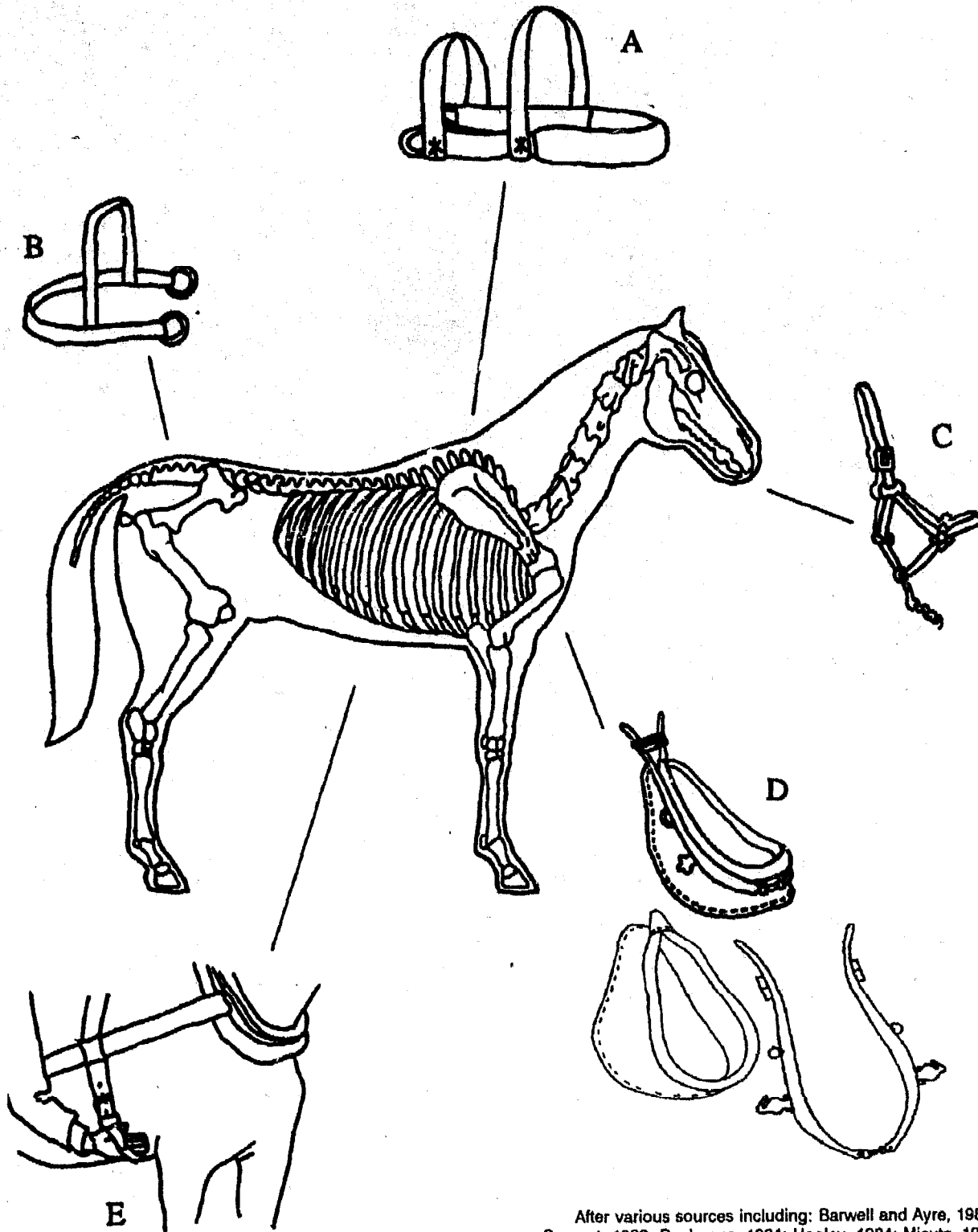
Photo: Paul Starkey



Fig. 3-29: Horses fitted with withers yoke for plowing in Ethiopia. Yoking horses is rare.

Photo: Michael Goe





After various sources including: Barwell and Ayre, 1982; Pousset, 1982; DuChenne, 1984; Hooley, 1984; Micuta, 1965

Fig. 3-30: Anatomy of a horse showing some harnessing options.

- A). Breastband harness (very commonly used for agriculture and transport).
- B). Breeching strap (uncommon, but useful for slowing down equipment).
- C). Bridle and bit (useful but not essential).
- D). Full collar harness, showing its component collar and hames (rarely used in Africa).
- E). Back strap and belly strap (useful if animal supporting weight of cart or if breeching strap fitted).

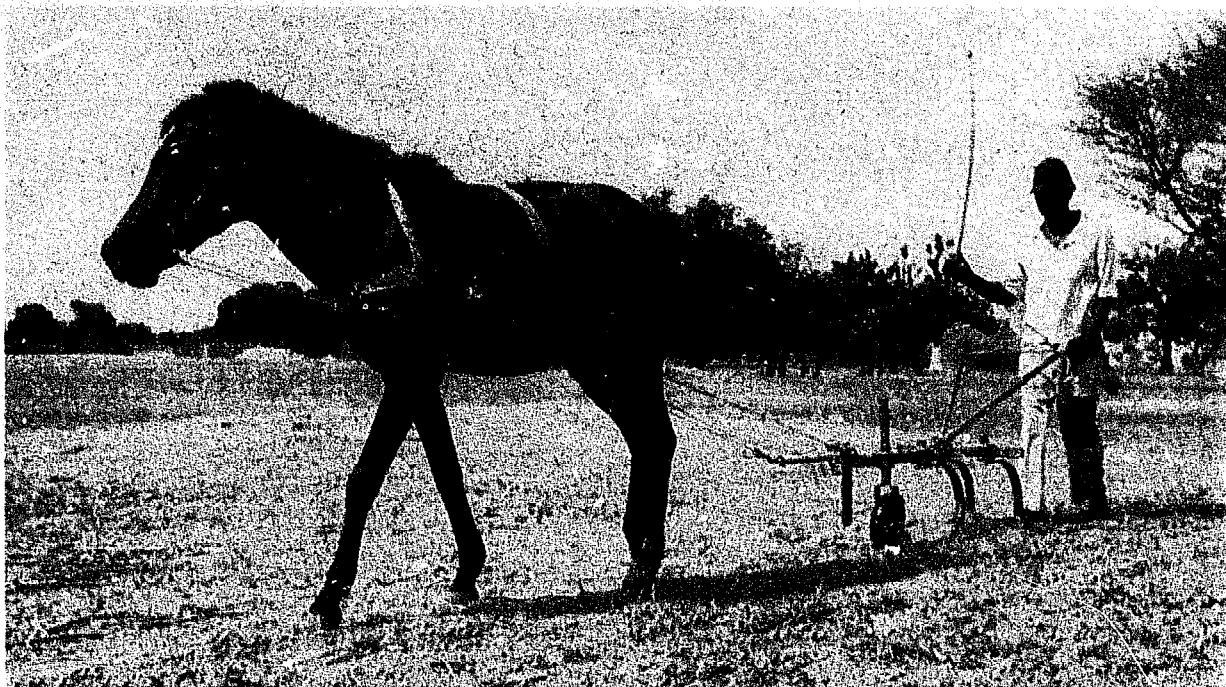


Photo: Paul Starkey

Fig. 3-31: Horse fitted with breastband harness, bridle and bit being used for tilling in Senegal.

tainable. In Europe there was a tendency to use head yokes in areas where cattle were predominantly used for work, breastbands and collars where horses were dominant, and interchangeable withers yokes in areas where both bovines and equines were used (Delamarre, 1969). A comparison of the anatomy of equines and cattle (Figs. 3-1 and 3-30) shows that equines are not as well suited to withers yokes as cattle. Equines, particularly horses, have relatively strong chests but they do not

have pronounced withers to take the strain of a yoke. For this reason, when equines are yoked the descending bars become increasingly important for taking the strain, and there are examples of equine yokes fitted with collar-like structures to increase the comfort and efficiency of power transmission. Indeed it is speculated that independent equine collars were actually developed from the gradual augmentation of withers yokes. However it is generally agreed that yoking of equines is not

Fig. 3-32: Donkey fitted with collar made from a padded moped chain in Mali.

Photo: Paul Starkey



Fig. 3-33: Donkey fitted with breastband made from a synthetic sack in Senegal.

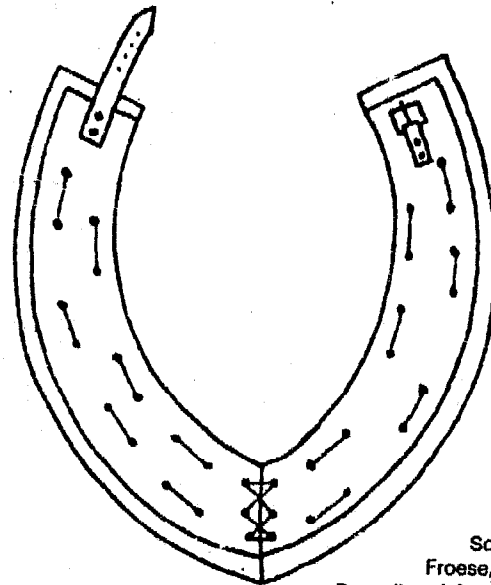
(A skin abrasion from a previous harness is visible).

Photo: Paul Starkey



an efficient harnessing strategy, and breastbands or collars are the harnessing systems of choice for horses, mules and donkeys.

The breastband is the simpler and cheaper system for donkeys, mules and horses. The work force is primarily taken from a broad band of leather, rubber or strong canvas material across the animal's chest. Attached to either end of the breast band are the traces (ropes or chains) or shafts which pass back to the implement or swingle tree. The breast band is held in position by one or more straps. Usually there is a neck strap crossing the withers and a back strap across the middle of the back (Fig. 3-31). These straps not only maintain the position of the breast band, they also transmit the vertical component of the work, and they are often padded on the back and referred to as "saddles". The back straps may be adjustable or made to size. While leather is the traditional material for breastband and straps, rubber carefully cut from old lorry tyres is increasingly used and pieces are sewn together with wire. A study of several donkey harnesses in Botswana concluded that carefully made and padded breast harnesses made from either tyre rubber or from webbing could be both cheap and effective (Froese, 1980). The use of breastband harnesses made from padded rope has also been reported



Sources:
Froese, 1980;
Barwell and Ayre, 1982

Fig. 3.34: Tyre collar harness. Developed in Botswana, the harness was found suitable only for donkeys undertaking light work. Lining material is stitched onto the old tyre walls.

(Barwell and Ayre, 1982) and in Senegal some breastbands are made from nylon rope surrounded by cloth, contained within an old inner tube.

Breastband harnesses are relatively simple to make, but are often of limited durability. There are examples of projects developing low cost harnesses, but later reverting to more expensive materials after frustration with breakages (McCutcheon, 1985). The skin of equines is sensitive to rubbing, and relatively soft materials or padding are advisable. Padding is particularly important if wire is used to join synthetic rubber or if abrasive ropes might rub against the skin.

Horse collars have been widely used in Europe and

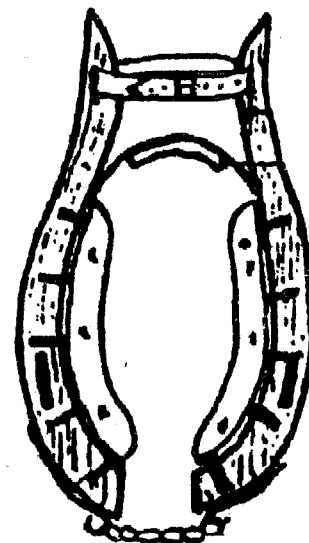


Fig. 3-35: Full collar being used with horse on GRDR training farm in France.

Photo: Paul Starkey



Photo: Paul Starkey



Source: after Dibblits, 1985

Fig. 3-36: Prototype "Swiss-collar" harness at the University of Nairobi, Kenya.
 Left: Donkeys fitted with harnesses give an on-station demonstration. Right: Drawing of collar harness

North America, particularly with larger animals. Horse collars are generally made of leather, supported by a wooden or metal frame usually in two pieces known as *hames*. The traditional European collar comprises two metal hames articulating at the bottom to form a U fitting over the leather collar and soft padding made to the size and shape of an individual horse. The load is applied to traces that pass back from rings attached to the hames. For certain operations such as harrowing there is no need for other harnessing, although a single back strap and saddle are often used in conjunction with a collar to take the vertical forces. For carting, or operations where braking is important a breeching strap is fitted around the rear of the animal and one or two saddles are used to support the vertical load on the shafts. In Europe horse harnessing was not only a highly skilled operation, it became a folk art.

Full collars based on the European style are seldom used in tropical countries. While collars are employed for heavy transport in North Africa, they are seen only rarely in Sahelian countries. In most African countries horses and donkeys are harnessed with breast-

bands for both transport and agriculture. There have been reports of collars made from the walls of cross-ply (*not radial*) car or motorcycle tyres (Fig. 3-34). While there have been some reports of such designs being appreciated by farmers (Froese, 1980, Lawrence, 1987) there does not seem to have been appreciable uptake of such collars for equines. One reported problem is that tyre harnesses distort as soon as a significant work load is applied and this together with broken wires from the tyre or the stitching can cause damaging skin abrasions (Barwell and Ayre, 1982).

Donkey collars made from two padded wooden hames linked with a leather hame strap and a chain have been developed, but these tend to be difficult to make (and therefore expensive) and are often more complicated to use than the simple breastband. It has been argued that the slanting breast of a donkey makes breastband harnesses only suitable for light work, and that to benefit from the strength of a donkey, power should be taken mainly from the shoulders. For this reason prototype "improved" donkey harnessing systems have been evaluated and promoted in

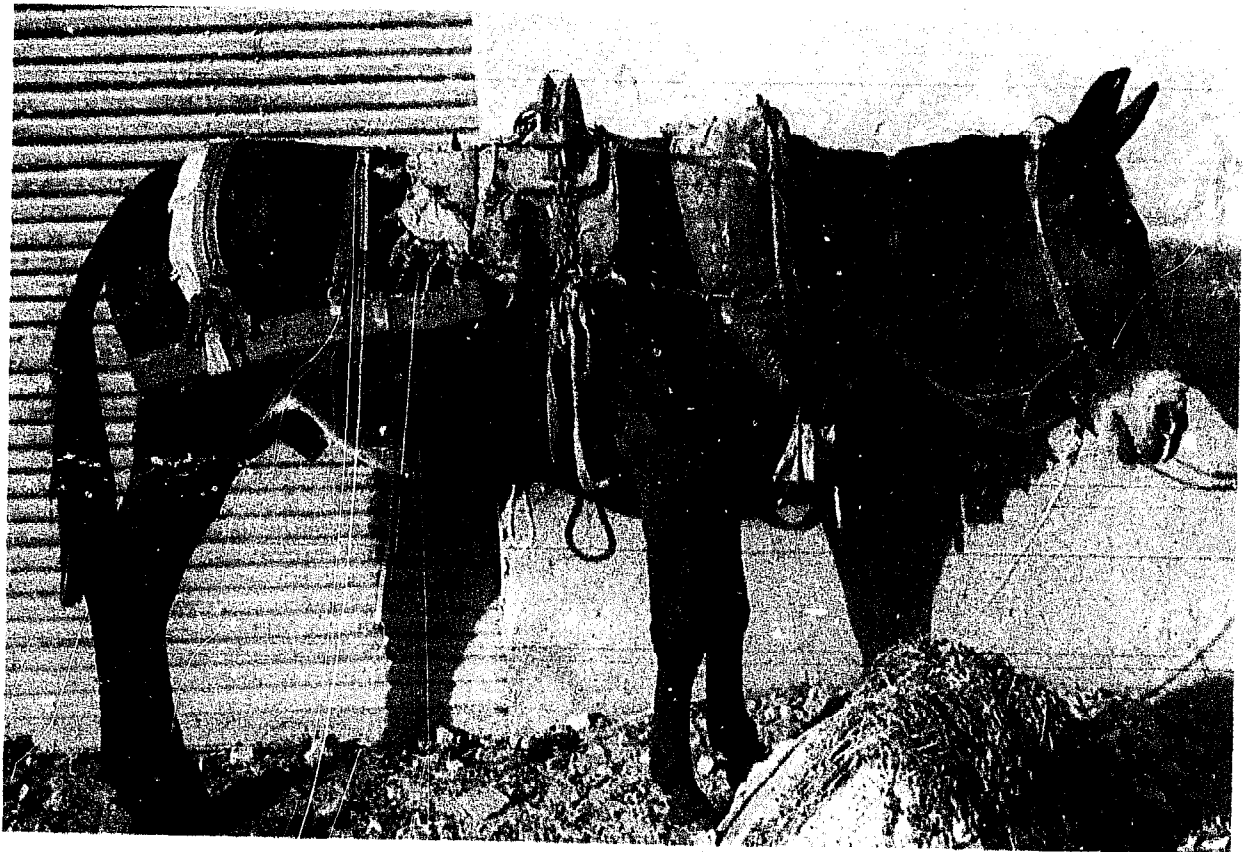
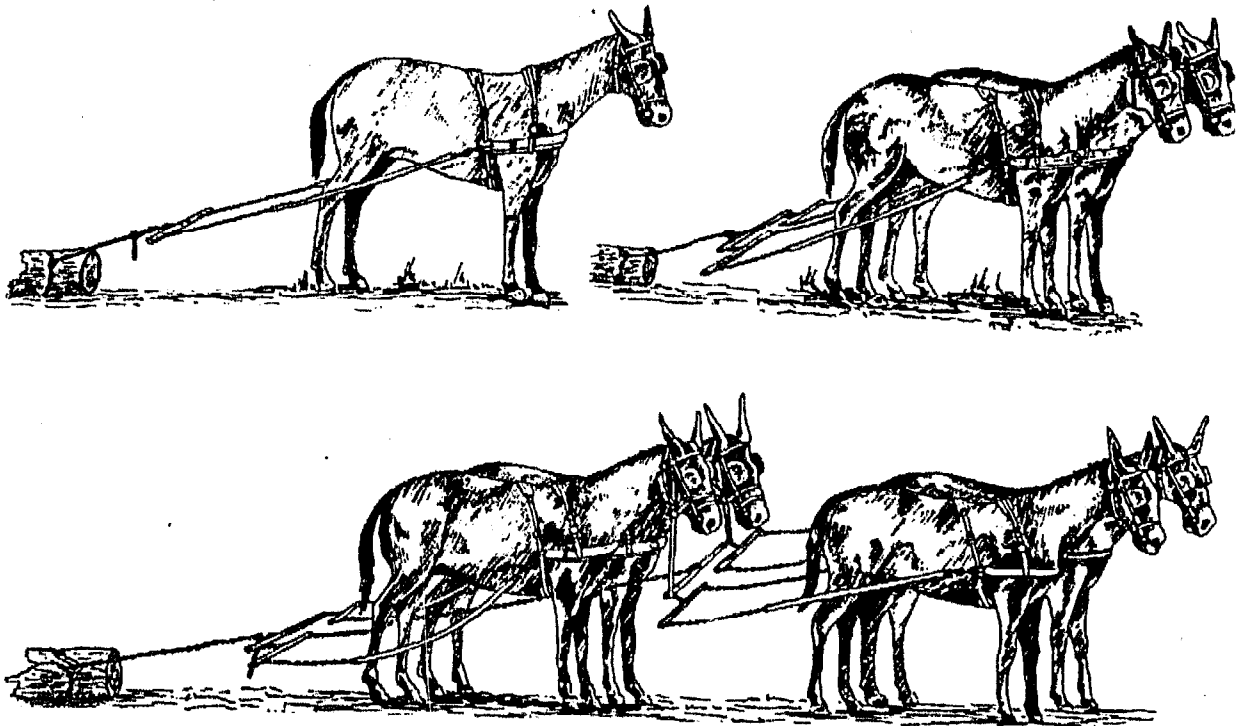


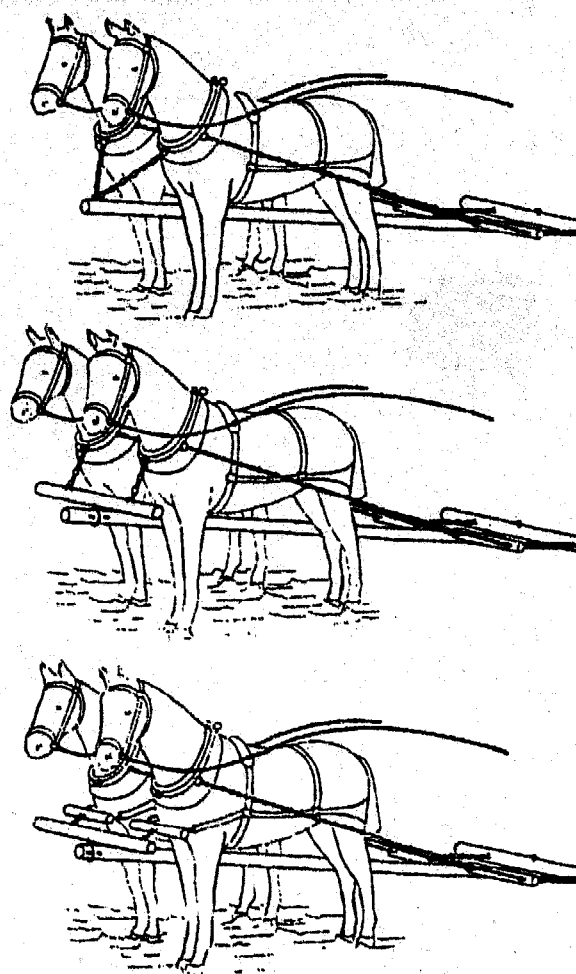
Photo: Paul Starkey

Fig. 3-37: Mule with full collar harness, breeching strap and cart saddle employed for transport in Egypt.

Source: after Zaremba, 1979

Fig. 3-37: Mule harnesses for logging.





Source: Barwell and Arye, 1982

Fig. 3-38: Some harnessing options for horse-drawn carts involving (bottom) the use of front swingle trees.

Kenya and Zambia (Dibbits, 1984, 1985, 1986; Fig. 3-36). Several artisans in Kenya and Zambia have been trained to make these harnesses but initial adoption rates by farmers have been slow, despite considerable publicity efforts. At the time of writing, these harnesses had not yet passed the test of long-term farmer acceptance and while it is too early to say whether significant numbers of farmers will go on to adopt these designs, it would seem prudent at this early stage to balance the reported optimism with a degree of caution.

Donkeys and horses are the pack animals of choice in many parts of the world. Traditional

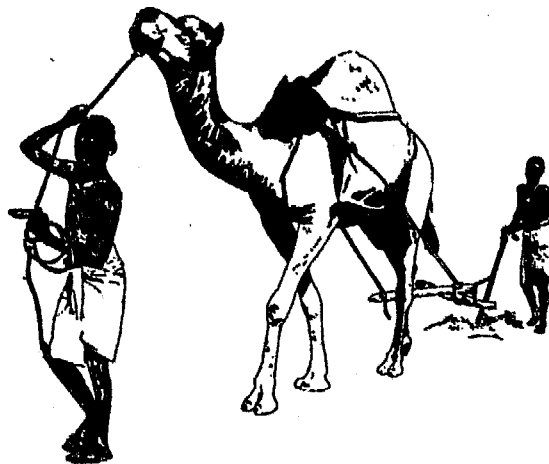
saddles and panniers can be made of a variety of local materials, but generally incorporate a simple wooden frame to protect the spinal processes. This is secured by one or more girth straps, a breast band and a breeching strap or tail rope. Pack saddles and other transport issues are covered in Chapter 8.

3.8 Harnesses for camels

Camels are widely used for pack transport in arid areas and sometimes they are used to pull carts and power irrigation systems or grinding mills. The fact that camels have a high value for transport operations generally restricts their employment for agricultural operations. The long legs of camels allow them to cover ground quickly, but this height poses some problems for effective harnessing. Unless the traces of a camel harness are long (making turning difficult), the angle of pull is quite large, giving a significantly higher ratio of "lift" to "pull" than with less tall animals (see Chapter 2). Nevertheless it is not uncommon for camels to be used for crop cultivation in parts of North Africa, the Middle East, Pakistan and Rajasthan in India. In Sub-Saharan Africa the number of camels used for crop cultivation is very low, but it is reported that camels are being increasingly used for plowing

Fig. 3-39: Camel harnessed with withers harness made of leather being used to plow in Ethiopia.

Drawing: Alan Foulds



After photo by D. Gérard in Mukasa-Mugerwa, 1985



Photo: Jean-Louis Arrachart

Fig. 3-40: Camel pulling Arara plow in Niger. Note large angle of pull.

in parts of Sudan, Ethiopia, Mali, Niger and Nigeria. Although collars can be used with camels, simpler and cheaper systems are usual. A photograph and description of camel collars in Niger were provided by Fort (1973). These had padded wooden hames and were held in place by back and belly straps, but it was found that withers yokes were actually more appropriate for cultivation work. The single camel withers yokes used in Niger were made from old lorry springs, well padded and fitted with large rings at each end to take the traces. They were held in place by a belly band and also small saddle and neck bands (Fort, 1973).

In other countries, including Ethiopia, a broad piece of padded leather or webbing can act as a single withers yoke, with traces running from this harness to the implement or swingle tree. The harness may be held in place by a breast band and also by a strap or cord passing behind the hump (Mukasa-Mugerwa, 1985). Pathak (1984) provided a drawing of an Indian plowing harness made of rope passing over three pads to the front of the hump, under the chest and at the withers (Fig. 3-42). This apparently provides a large surface area of contact, but appears also to constrict the chest. Rathore (1986) provided a drawing of a plowing harness with traces attached directly to a saddle, itself held in place by a single

Fig. 3-41: Withers harnesses for camels.

Source: Duchenne, 1984
(after Ringlemann, 1905)

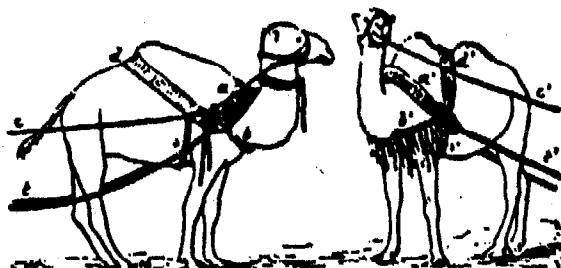


Fig. 3-42: Camel harness made of cord, as used in India.

Source:
Pathak, 1984

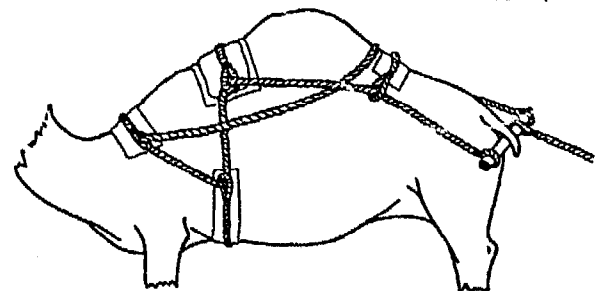




Fig. 3-43 a and b: Prototype hump harness based on traditional design and made by artisans in Niger.

Photos: Jean-Louis Arrachart

steel that fits over the camel's hump is shown in Fig. 3-43. The main disadvantage of back yokes on camels is that the attachment points for the traces are high on the animal, giving a large angle of draft.

Camels are used much more widely for transport than for pulling implements. Several illustrations of traditional pack saddles for camels were reproduced in the books of Wilson (1984) and Mukasa-Mugerwa (1985). For cart transport, a broad, padded withers harness is often used to provide the forward movement while a saddle over the hump takes much of the vertical load by supporting one or more straps, cords or even chains attached to the shafts.



breastband. A similar system is used in Sudan (Wilson, 1984), and parts of Niger (Arrachart, 1988), and in both countries a child may ride the camel as the farmer plows (Fig. 3-40). One design of padded plowing saddle (or back yoke) from Niger that is made from old spring

3.9 Reining systems

While traces are used to take the work load, reins are used to control the animals. Reins are not universal, and both bovines and equines can be trained to respond to voice commands. Steering reins are seldom used in conjunction with long-beam implements which can provide relatively direct contact between the operator and the animals. For reins

Fig. 3-44: Simple leather halter recommended for use in Zimbabwe.

Source: AETC, 1986

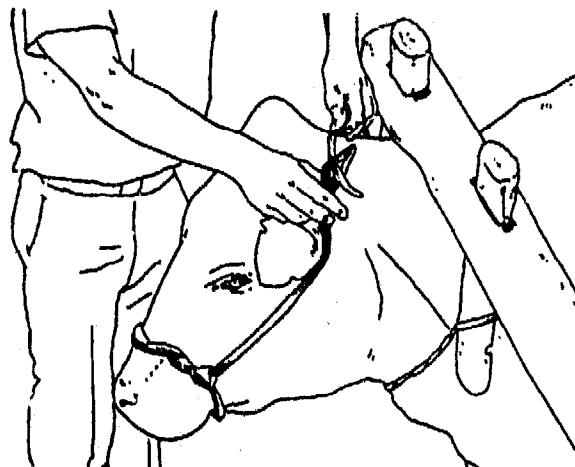
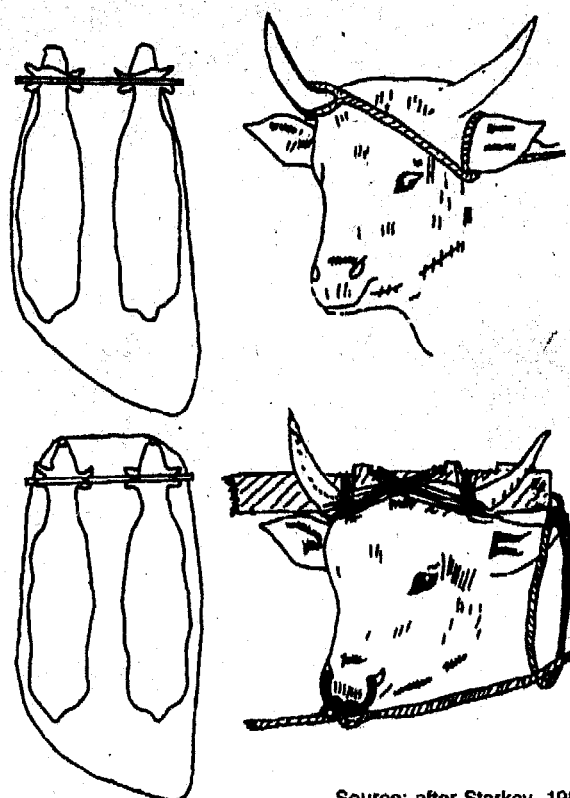


Fig. 3-45: Two rein attachment options for equines. Left: halter (no mouth bit). Right: bridle with mouth bit and blinkers.



Source: after Zarembo, 1976



Source: after Starkey, 1981

Fig. 3-46: Two reining options suggested for use in Sierra Leone.

to be effective they must be secured around the head of the animal. In cattle the attachment can be a nose ring, a nose rope or a rope around the horns. Nose rings lead to excellent control and are particularly useful for giving confidence to handlers unfamiliar with working animals. However they are relatively expensive, difficult to obtain and involve the piercing of the nasal septum. A cheaper system that also involves puncturing the septum uses rope in the form of a ring, or in a form of a halter running from horn to horn through the nose. A nose peg attached to a rope has a similar function. Unfortunately ropes made of natural fibre tend to rot, while synthetic ropes tend to slip. Ropes left on the head can become entangled in shrubs during grazing. Reins tied to the horns avoid some of these problems and risks but do not give such sensitive control.

For equines and sometimes for cattle a halter made of leather straps, ropes or rubber strips

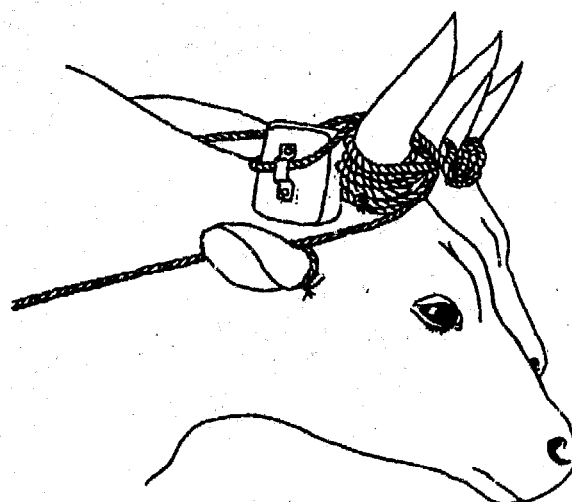


Fig. 3-47: A system of tying rein around ear.

that fits around the head of the animal can be used (Fig. 3-44). The use of a leather bridle that holds a metal bit behind the teeth of a horse, mule or donkey leads to particularly good control, but this is not always considered necessary (Fig. 3-45).

All animals may be led from the front by reins, but this is generally regarded as both unnecessary and undesirable for well-trained animals. Nevertheless in most African countries other than Ethiopia it is a common practice for one person to lead working animals, while a second person controls the implement. A third person often has the duty of encouraging the animals, making work with draft animals very labour intensive. Since it is an established fact that well-trained animals can be controlled by a single person, there would seem to be great potential savings if farmers were to invest in suitable reining systems and animal training. Indeed, investment in such training during a slack period of the farming year should release labour during the critical labour-bottlenecks during the cultivation season. If reining and training could achieve such benefits, it would seem to be a useful area for extension emphasis and therefore many programmes in Africa place much emphasis on "improved" systems of training

and reining (Starkey, 1981; AETC, 1986; Mungroop, 1988). Nevertheless such obvious solutions are seldom as simple as they appear: firstly farmers argue that the animals are usually guided by children and youths, for whom the opportunity cost for alternative farm work may be low; secondly some farmers warn that well-trained animals represent a greater risk, since they are more easily stolen by strangers than are less docile animals; thirdly, some farmers argue, the animals are only used for a short period each year, and may be sold for meat after just a few seasons, making it difficult to justify the time needed to train animals and keep them in training.

Reining systems recommended by extension programmes involve reins passing backwards from nose rings, halters or bridles to the operator. They are used, in conjunction with verbal commands, for steering and for stopping the animals. (Figs 3-48, 3-49) When two animals are used, one rope or strap joins the two nose rings or halters and one rein passes from the outer side of each animal. For improved control reins can loop round the ears of the animals (perhaps with some padding) (Fig. 3-47). It is evident that for the welfare of the animals, care should be taken when tugging at reins looped round ears or attached to nose rings.

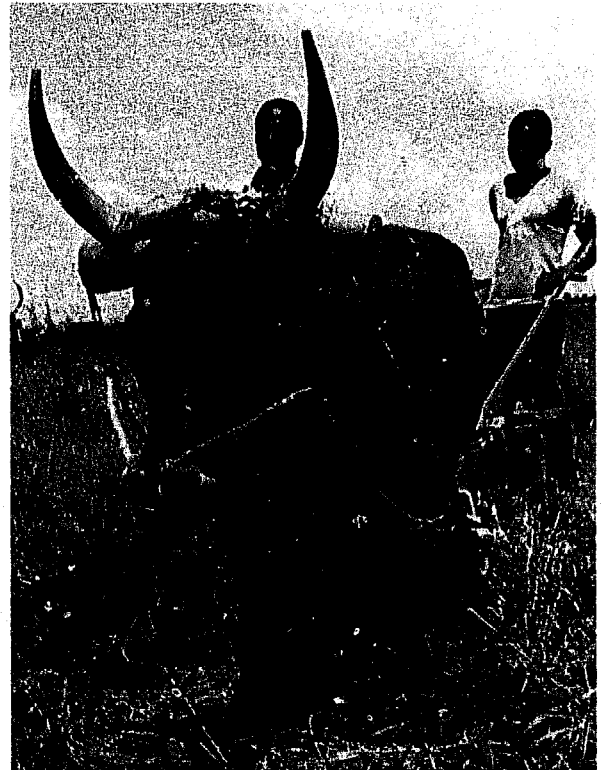
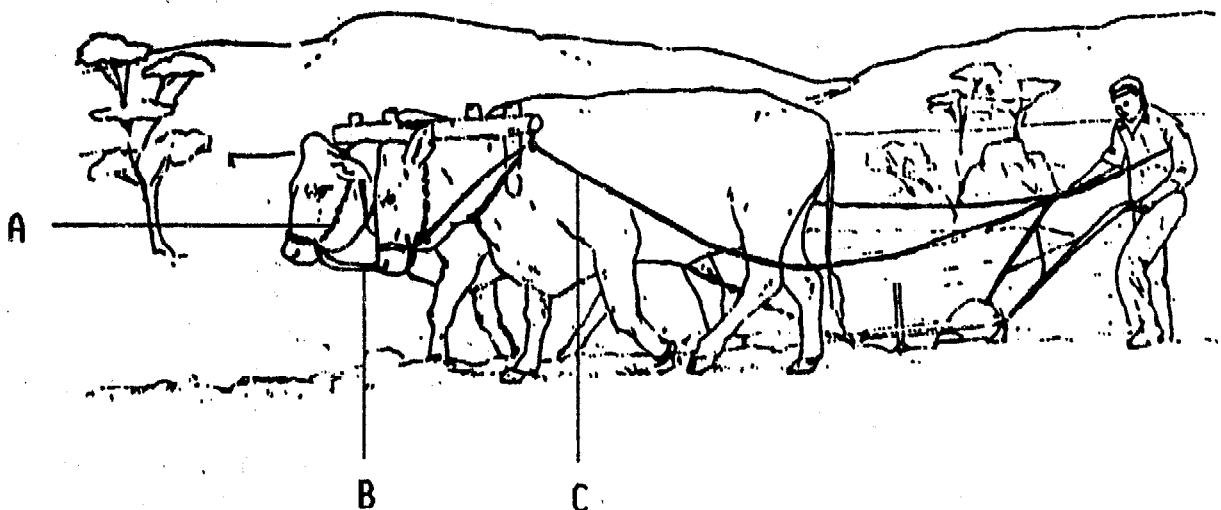


Photo: Paul Starkey

Fig. 3-48: Nose-ring reining system for single ox, being used on-station in Sierra Leone.

Reins are useful in the early stages of working with draft animals, but they can often be dispensed with when animals are well trained, for they represent one more item to fit and one more possibility for entanglement.

Fig. 3-49: System of reins recommended for use in Zimbabwe.
A - Halter; B - Coupling; C - Steering rope.



Source: after AETC, 1986

4. Less common harnessing systems

4.1 Full-collars and three-pad harnesses for cattle

Although it is common, perhaps almost conventional, for people to *advocate* that cattle should be harnessed with collars, harnessing collars are seldom actually *used* in Africa (outside the confines of research stations or small, charitable development projects). For this reason they are discussed here as *non-conventional* harnessing systems, in order to stress that, to date, they have not been widely adopted. In Europe, collars for horses spread rapidly after the eleventh century, and for several hundred years in Europe horses were har-

nessed with full collars for heavy work and with breast-bands for lighter work. As the horse collar spread, so collars were developed for use with oxen. Ox collars were adopted in some localities in Europe (Steinmetz, 1936), but they were never employed to the same extent that horse collars were used. In Europe head yokes, withers yokes, ox-collars and flexible harnesses coexisted for centuries without one clearly dominant oxen harnessing system emerging. More recently ox-yokes and collars coexisted in North America.

While wooden yokes for oxen appear to have had worldwide dominance on farms for cen-

Fig. 4-1: Full collar harness on a British ox. Collars and yokes co-existed in Britain for many years.

Photo: Archives of Institute of Agricultural History, Reading

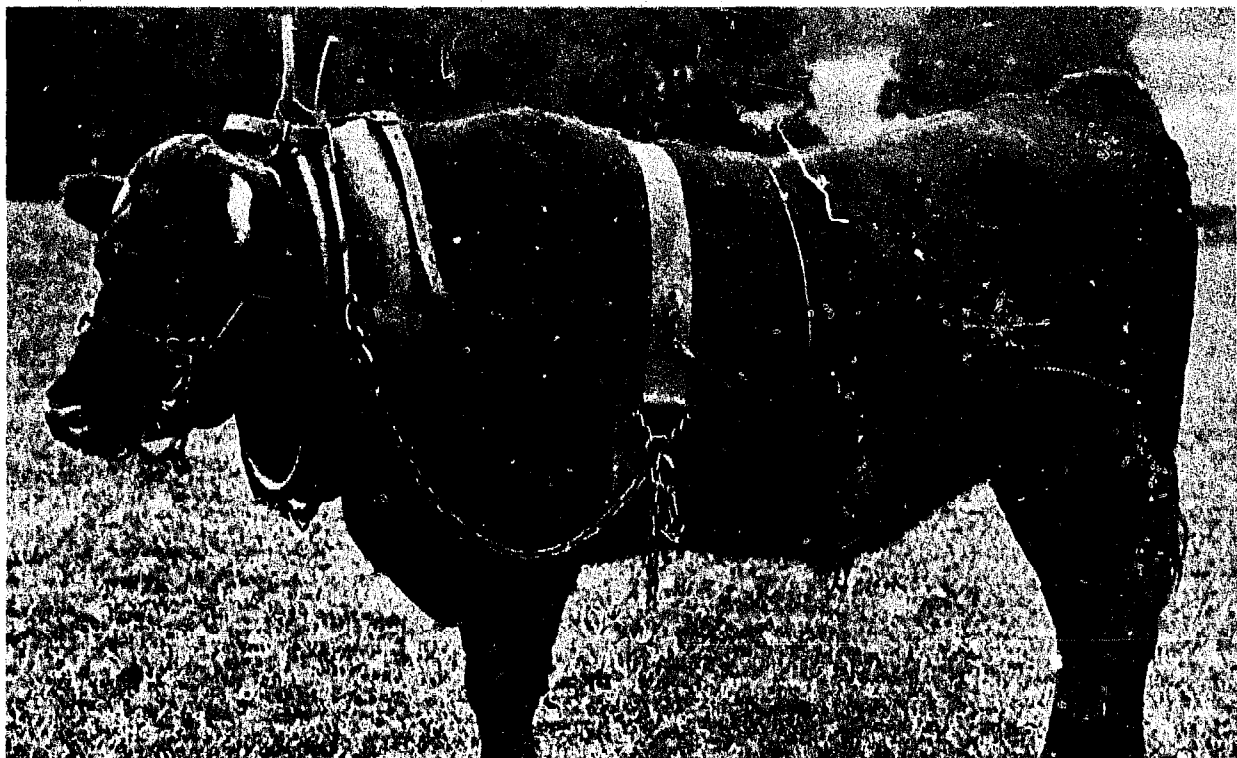




Photo:UEA/David Gibbon

Fig. 4-2: Three-pad collar harness being used at the University of East Anglia, UK.

turies, innovative farmers and researchers have repeatedly tried to develop more efficient and comfortable harnessing systems, and have several times developed different forms of bovine collar. The three-pad collar harness for oxen was one such innovation, developed in Europe this century. In response to a shortage of draft horses prior to and during the Second World War, farmers in Switzerland had to harness cattle for work.

The full "Berne" ox-collar (Fig. 4-3c) was expensive and complicated to make, and a simpler

derivative, the 3-pad collar was developed by the Fédération suisse d'élevage de la race tachetée rouge (FSERT) (Wenger, 1938; FSERT, undated; Micuta, 1985). The three-pad harness was apparently well received, spread quite rapidly in certain areas, and is still used to a very limited extent in parts of Switzerland and Germany. The harness comprises two wooden hames, hinged by leather straps at the top, and joined by a removable chain at the bottom (Fig. 4-3a). The hames are shaped to exactly match the contours of the animal. The shoulders of the animal are protected from direct contact with the hames

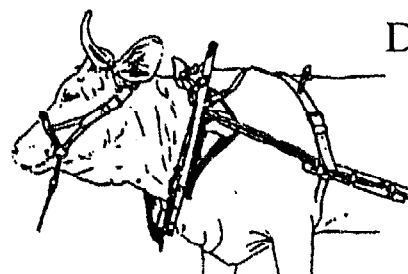
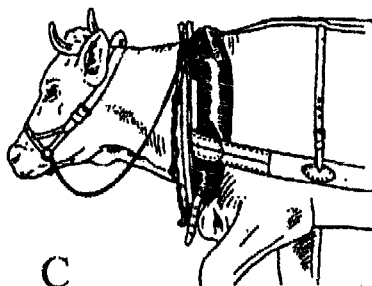
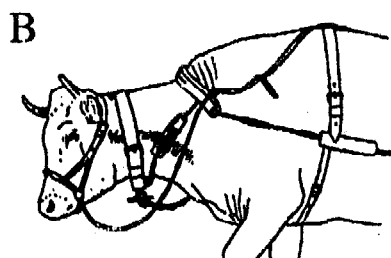
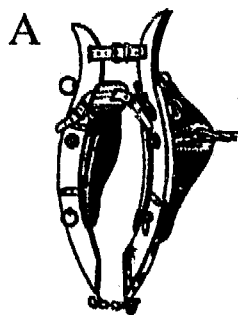


Fig. 4-3: Swiss independent harnessing systems for cattle.
A - 3-point collar; B - Single withers yoke; C - Berne collar; D - 3-point collar.

Source: Fédération suisse d'élevage de la race tachetée rouge, c. 1941

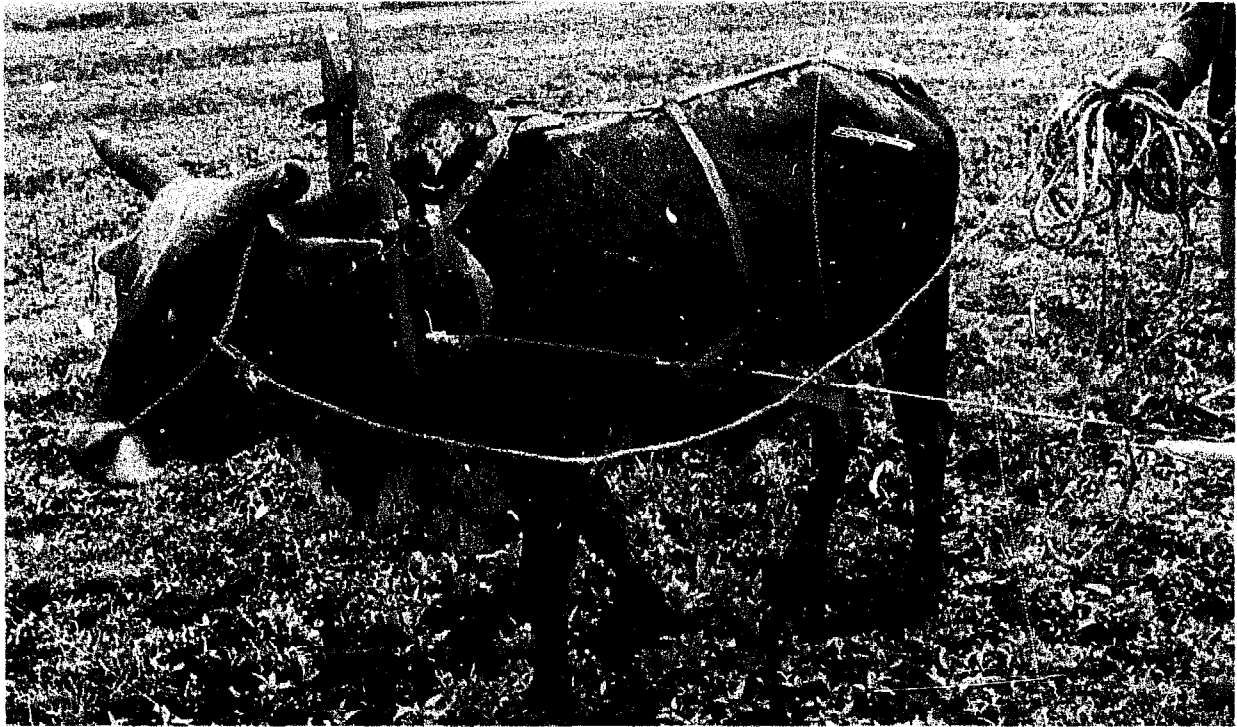


Photo: Paul Starkey

Fig. 4-4: Three-pad collar harness being demonstrated at the University of Nairobi, Kenya.

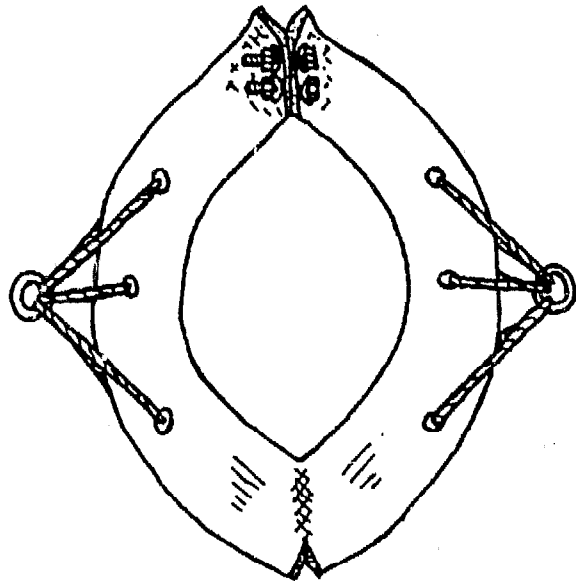
by two pads, traditionally made of leather stuffed with animal hair, but more recently made from canvas or sack cloth. The third pad is attached to the upper strap which rests on the withers.

Many authors have highlighted the advantages of the three pad harness in increasing the surface area of contact, lowering the angle of pull and increasing the comfort of the animal (Hopfen, 1969; Barton *et al.*, 1982; Micuta, 1985; Dibbits, 1986). However three-pad harnesses are much more expensive to make than yokes, and are more complicated to fit and use. Collars and three-pad harnesses have been assessed in many African countries, but have not been adopted by farmers to any significant extent. Recent artisanal training schemes in Kenya and Zambia have shown that it is feasible to make such harnesses at village level (Dibbits, 1985). However such initiatives have not yet demonstrated that the technology can be sustained by farmers purchasing the harnesses from the artisans.

4.2 Tyre collars and flexible harnesses

Full collars and three-pad harnesses are expensive to make, but collars for cattle and buffalo can also be made from old car or motorcycle tyres. These have been evaluated in Botswana (Froese, 1980), Scotland (Lawrence,

Fig. 4-5: Prototype tyre collar tested at CTVM, Edinburgh.



Source: Lawrence, 1987



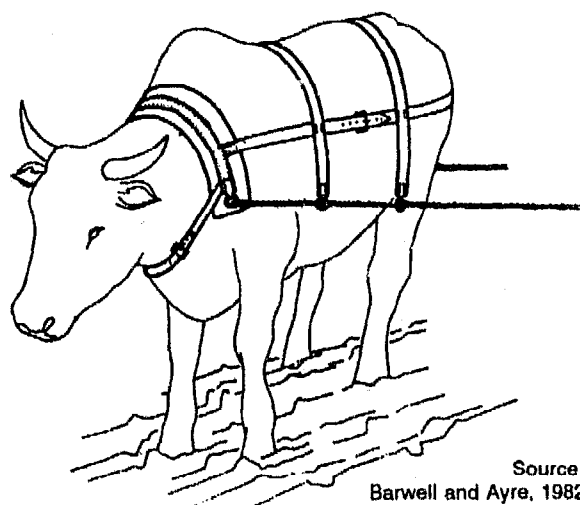
Photo: Bob Munro/CTVM

Fig. 4-6: Tyre collar harness being tested on ergometer track at the Centre for Tropical Veterinary Medicine, University of Edinburgh.

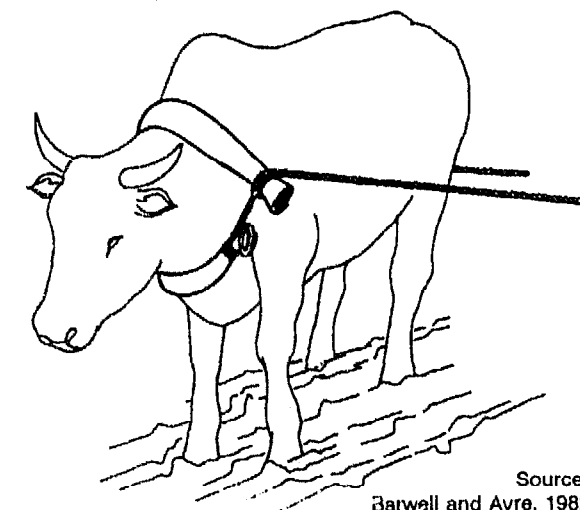
1983), Malaysia (Kehoe and Chan, 1987) and Thailand (Van Koeverden, 1987). Tyre-collars have some of the advantages of more conventional collars (low hitch point, large surface area for applying work) while being substantially cheaper. However since they have no wooden hames, they distort more easily than three-pad harnesses, causing the effective surface area to be reduced when the collar is under strain. There are also reports of discomfort caused by the attachment ropes and

the materials used to join the tyre sections (wire or bolts). Kehoe and Chan (1987) found that tyre collars became uncomfortable to buffaloes if they became hot, and so they recommended they only be used in shaded conditions, such as beneath oilpalm trees. Although tyre collars have been found acceptable in on-station trials, there has been little adoption by farmers, and so, as with all non-conventional systems, the technology should be treated with some caution.

Fig. 4-7: European design of flexible withers yoke/harness made from leather. In operation it was similar to the Swiss withers yoke (Fig. 4-3).



Source: Barwell and Ayre, 1982



Source: Barwell and Ayre, 1982

Another system designed for single, or independently hitched animals is the flexible harness. In its simplest form this operates like a single withers yoke made of flexible material such as leather, tyre rubber, sacking or webbing, to which the traces are attached. In order to prevent slippage and allow forces to be spread, a breast band may be attached, as may be a series of back straps and girth straps. Flexible harnesses held in place by a series of leather straps were used with cattle in Europe, and have been experimentally evaluated in Zimbabwe (Barwell and Ayre, 1982) and Malaysia (Kehoe and Chan, 1987). The flexible harness has some of the advantages of collars (low hitch point, large surface area) and also some of the disadvantages (more complicated to fit and use than a yoke). To date there has been no significant farmer adoption of such harnesses in Africa.

4.3 Collar-type yokes

In some Mediterranean countries equines have been yoked together with a traditional design of withers yoke that has padded descending processes, designed to allow the animals to push from their shoulders as well as their withers. Comparable collar-yokes designed for oxen have been developed in India (Vaugh, 1945, Varshney *et al*, 1982) and Bangladesh (Hussain *et al*, 1980) and many similar designs have been tested in Africa (Fig. 4-9). A similar concept was used in the development of the "Allahabad" yoke in India, which is not unlike a pair of three-pad harnesses linked with a metal yoke (Swami Rao, 1964; Ayre, 1982). Collar-type yokes combine some

Fig. 4-9: Prototype collar-type yoke being tested by a mission in Zambia. Photo: Paul Starkey

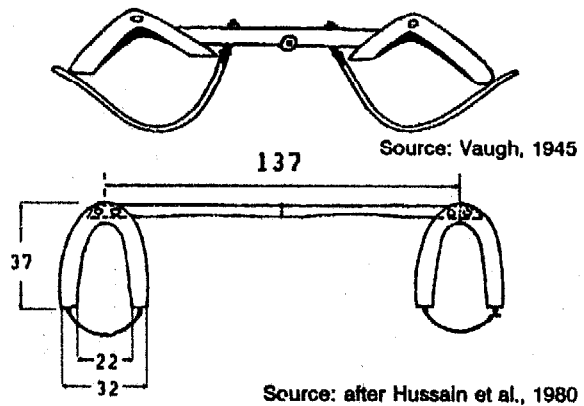
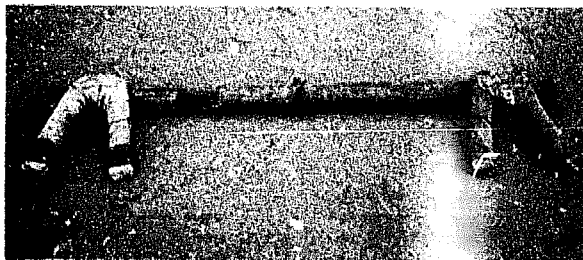


Fig. 4-10: Prototype collar-type yokes.

Top: Design tested on-station in India and found to be significantly inferior to traditional designs.
Below: Design tested on-station in Bangladesh and found to be comparable to, or slightly better than, traditional yokes. Dimensions in centimetres.

of the advantages and disadvantages of collars and yokes. Collar-yokes do not require independent hitching arrangements, which can be both beneficial (no need for traces and swingle trees) and disadvantageous (the rigidity of yokes is sometimes criticised for causing discomfort and restricting free movement). The hitching height of collar yokes is often intermediate between that of a traditional withers yoke and a full collar or three-pad harness.

Simple collar yokes appear to offer increased comfort through larger contact area and padding without a great increase in cost or complexity (although it should be noted that the Allahabad yoke was significantly more expensive and complicated than a traditional yoke). Some prototypes have performed very favourably in on-station trials, although it should be mentioned that in trials in India in the 1940s, an "improved" collar-type yoke performed significantly worse than all traditional yoking designs evaluated (Vaugh, 1945). Nevertheless recent farmer adoption of collar yokes has been minimal. Indeed some designs that were initially hailed as important breakthroughs in harnessing research (such as the Allahabad yoke) are actually no longer used even on the research stations where they were developed.

4.4 The merits and demerits of collars for oxen

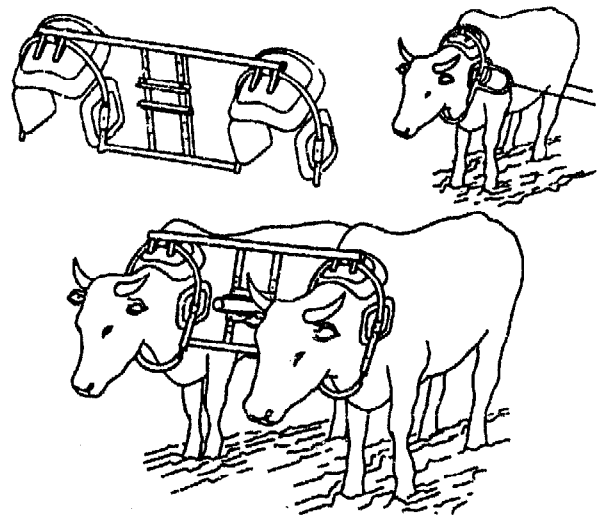
Most of the criticisms of collars for oxen relate to their relative cost and complexity compared with simple yokes rather than their technical efficiency. However one ox team driver from the United States has recently argued (on the basis of observation and opinion rather than measurement) that collars are not technically appropriate for oxen (Conroy, 1988). Conroy (who by voice alone can encourage a yoked pair of oxen to pull over twice its weight on a flat sledge) argues that a well-fitted yoke is more effective, since collars tend to interfere with the animals' mobile and relatively pointed shoulders and slide out of position when the oxen lower their heads during work. The key words here may be "well-fitted", for any poorly fitted harnessing system is likely to be inferior to a well-fitted one.

Most of the arguments in favour of collars relate to claims that collars improve the power, work output or efficiency (seldom defined) of working cattle. In formulating recommendations for Botswana, Orev (1977) claimed "The horse collar harness has been found to increase the draught power 4-5 times, as compared with a yoke, therefore short of actual trials it is safe to assume that the 3-pad harness can double the draught power available in the country". Micuta (1985) observed "The significant advantages of using a collar harness rather than a yoke are universally recognised. In 1920 Ringlemann established that an ox equipped with a collar could accomplish the same amount of work as two oxen attached to a yoke". While this latter statement could be true for light work it is most unlikely to apply to heavy work. Such comparisons of yoked pairs and single harnesses tend to confuse the effects of single *versus* double harnessing with those of collar *versus* yoke.

Claims that collars *per se* increase power or efficiency by 48-70% compared with yokes should be treated with great caution and close

attention to definitions. For example "Garner showed that the horsepower increased 70 per cent when he replaced the yoke with a breast strap harness" (Vietmeyer, 1982) and "Garner demonstrated that a collar harness increased pulling force of buffaloes by 50%" (Micuta, 1985). These and several other authors have implied that the work of Jean Garner (1957) in Thailand had effectively proven the greater efficiency of bovine collars. Through citations such as those quoted, Garner's unpublished tests have acquired a totally unwarranted mystique of conclusive experimentation. In fact Garner had simply run a few tests in which a few buffaloes were harnessed with yokes, collars and breastbands and measurements were taken of the maximum sledge weight they would pull and the time required to pull a 340kg sledge along a 500m track. In the limited tests, the breastband performed best, followed by the collar and the yoke. No statistical analysis was performed, but percentage differences were presented. Based on the time required to pull the sledge, the computed power output was 390W with a single withers yoke, 580W with a collar and 660W with a breastband, representing *relative* percentage increases of 48% and 70% for the collar and

Fig. 4-11: These prototype "Allahabad" single and double harnesses performed well in some research studies, but they were not adopted by farmers.



Source: Ayre, 1981; Barwell and Ayre, 1982

breastband respectively. Although Garner was an enthusiastic advocate of bovine harnesses, immediately after presenting his data (in the very next sentence), he himself noted that his statistically unreplicated tests were "not assumed to be conclusive due to the limited trials", and he considered "more work should be done under actual field conditions". Unfortunately other writers have tended to ignore Garner's caution and have simply quoted percentages, giving them a spurious authority.

While Micuta (1985) referred to the original trials of Garner as evidence for the claims, some other authors have simply referred to Micuta's work. This is despite the fact that Micuta himself did not claim to have carried out objective experimental work. For example, de Vries (1986) stated "Dr. Micuta has tested the [Swiss] collar in Switzerland and Kenya. It can be adapted for use with oxen, donkeys and horses. Not only does it increase pulling power by 50-100%, but it also lengthens the useful working life of animals". Such reports in newsletters and magazines have given many people who do not have access to the primary sources the impression that the dramatic efficiency claims for bovine collars have been proven. However such objective experimental evidence as has been obtained is less convincing.

Swamy-Rao (1964) undertook more replicated research on harnessing on a research station in India. His trials involved the taking of 50,000 dynamometer readings and during the tests the pair of bullocks covered a total of 1,400 km under a variety of work schedules (Ayre, 1981 and 1982). Detailed comparisons were made of single or double bovine collars of the innovative but expensive "Allahabad" design (Fig. 4-10) with single back harnesses (Fig. 4-14) and traditional double withers yokes. During sledge-pulling and plowing trials, oxen harnessed with withers yokes worked at a rate of 570-1030W while similar oxen with the collar-type yoke had a power output of 670-1310W. Oxen harnessed with

the back saddle had an output of 450-960W in comparison with 540-960W for the single collar-type yoke. Since the mean draft (implement resistance) was not constant within trials, it is difficult to make direct comparisons between these figures, but the higher work output was related to higher average walking speed. In some trials the back yoke out-performed the single collar-type yoke, but in all trials between the double-yoke systems the collar-type yoke appeared to give better results, and it was concluded that the "Allahabad" collar-type yoke resulted in 14% more power and allowed animals to work 30% longer without major power loss. Its estimated cost of about three times the price of the traditional yoke should have been recovered through increased farm income in two years on a holding of about 3.5 hectares (Ayre, 1981 and 1982). In more recent on-station trials, the "Allahabad" yoke was found to be inferior to two traditional yokes, and superior to two others. The basis for this selection was the degree of physiological stress (rise in temperature, pulse and respiration) suffered by the animals (Varshney *et al.*, 1982). However from the data presented, such "stress" may well have been associated with quicker walking speeds and faster rates of work.

In replicated experiments in a controlled but unnatural environment in Edinburgh, an ergometer and gas analyser were used to determine the ratio of work accomplished to energy expended for some buffaloes and Brahman cattle fitted with different harnessing systems (Lawrence, 1983). Buffaloes with withers yokes worked at 35.4% (± 1.03) net efficiency, while those with collars worked at 38.8% (± 1.30). Under similar conditions Brahman cattle with withers yokes worked at 28.9% (± 0.68) efficiency, while those with collars worked at 31.1% (± 0.89). This indicated that collars improved the net efficiency of work by about 3%, a figure that was just statistically significant ($p \approx 0.05$), (Lawrence, 1983). Clearly this figure of a 3% improvement in recorded net efficiency is well below

claims of high percentage improvements in efficiency made by authors working under less controlled conditions. One reason is that Lawrence's percentages refer to the calculated efficiencies of each yoking system (work done relative to actual energy expended over that normally dissipated when walking without a load). The 3% increase in the recorded net efficiency of the collars in comparison with withers yokes represented a 7-9% *relative* improvement of collars over yokes.

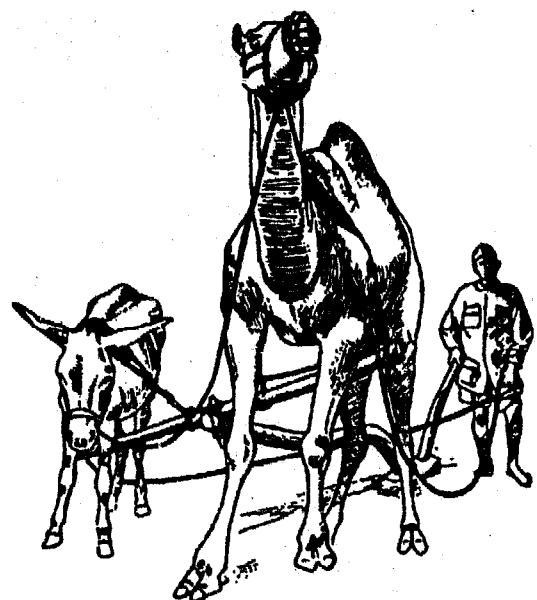
In field trials in Burundi comparable statistically significant increases in net efficiency of 1-2% were recorded (Barton, 1985). However Barton, who had previously advocated the use of three-pad harnesses (Barton *et al.*, 1982) concluded that bovine collars were unlikely to be adopted in developing countries as such modest increases were unlikely to justify their cost and complexity compared with yokes.

The experimental and anecdotal evidence does then suggest that bovine collars may well be intrinsically more efficient than head yokes, withers yokes and back yokes. However there seems no hard evidence to support the very dramatic claims often made for them. Bovine collars can be used singly or doubly but this should not be allowed to confuse the argument as both shoulder and withers yokes can be used singly and can also be used in independent hitching arrangements. If correctly matched and fitted, bovine collars may be more comfortable to the animal, but it is arguable that a poorly made collar is at least as uncomfortable as a poor yoke. While enthusiasts have developed bovine collars at research stations and in small projects in many countries in Africa, Asia and Latin America in the past thirty years (Garner, 1957; Barton, 1985; Dibbitts, 1985; Heifer, 1985; Pragasam, 1987; Kehoe and Chan, 1987), there seem to be no reports of sustained farmer adoption following demonstrations. Perhaps farmers consider that the cost and complexity of collars for cattle outweigh their apparent advantages.

4.5 Harnesses for mixed teams

One interesting picture (Fig. 4-12) taken in Morocco of a camel hitched to a donkey using a double belly yoke has been reproduced in at least three publications (Hopfen, 1960; Goe, 1983; Duchenne, 1984). The belly yoke pole does not contact the bodies, but it is suspended under the animals by traces attached to single withers harnesses. The animals look uncomfortable and Hopfen described the yoke as inefficient and painful and capable of causing severe injury to the animals. This belly yoke appears to have arisen as a local solution to the technical problem of how to use animals of different sizes with a traditional long-beam plow. It is also designed to combine the inherent strength of the camel with the stability of a donkey, for a single camel appears less able to walk in a straight line than a donkey or mule. In several north African countries, it is not particularly uncommon to see different species worked together, whether they be donkeys, mules, oxen or camels. A photograph of a young

Fig. 4-12: Mixed camel and donkey harnessed with belly yoke. This seemingly inefficient and uncomfortable harness is still used on a small scale, perhaps because it allows the power of a camel, the discipline of a donkey and the simplicity of a traditional ard to be combined.



Source: Hopfen, 1969

camel and a bullock yoked together (apparently uncomfortably) with a withers yoke for plowing in Egypt was reproduced in the book of Wilson (1984) and although this combination is quite rare, it is not unusual for buffalo and cattle to be yoked together in Egypt. In Sub-Saharan Africa there is unlikely to be a significant demand for harnessing different species together, although systems for hitching large and small animals of the same species together may have wider application. In either case, the use of independent hitching is advised, together with swingle trees and one or more eveners. With such a system the harnesses of the individual animals can be different (withers yokes, breastbands, camel harnesses etc.). However the advantages of being able to use different animals in this way are partially offset by increased complexity and the fact that long-beamed implements may need to be shortened. Research in Morocco has suggested that some animals may suffer additional stress if teamed with animals of a different species or markedly different size due to differences in normal walking speed and stepping rates (Bansal *et al.*, 1989).

4.6 Load saddles for oxen

Simple saddles can be padded wooden frames, broad straps or ropes over an animal's back which help bear vertical loads. These are widely used with horses, donkeys and camels that pull carts. Ramaswamy (1985) recommended that similar saddles should be used with bovines, to reduce the load on the necks. However, while agreeing with the principle, Barwell and Hathway (1986) suggested that many bovines will not accept a back load. Research at the University of Edinburgh demonstrated that the positioning of pack saddles on zebu cattle and buffaloes was critical. If the saddle was forward, over the shoulders, the animals accepted it more readily, and it required less energy to carry loads than if it was

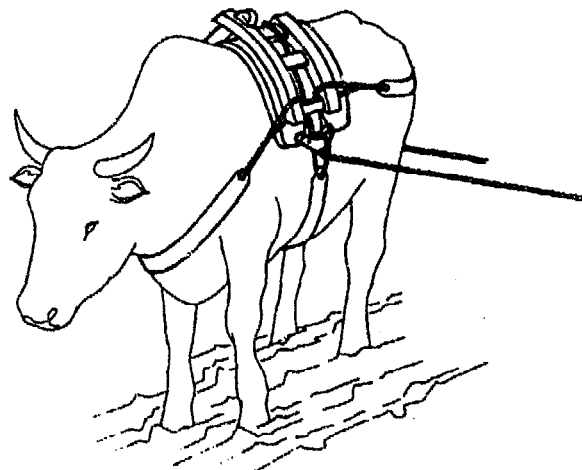


Fig. 4-13: Riding an ox in Mali. Photo: Paul Starkey

more central on the back (Stibbards, 1980). A saddle harness was widely used in Japan for cultivation and transport and in the 1960s it was found to be more efficient than withers yokes during on-station trials in India (Fig. 4-14; Barwell and Hathway, 1986).

Since the desirability of loading the backs of bovines seems somewhat controversial, it is interesting to note that while cattle can be successfully used for riding and pack purposes, there are few parts of the world where this is actually practised. Yaks are used as pack animals in some mountainous parts of Asia. Asian water buffaloes are occasionally

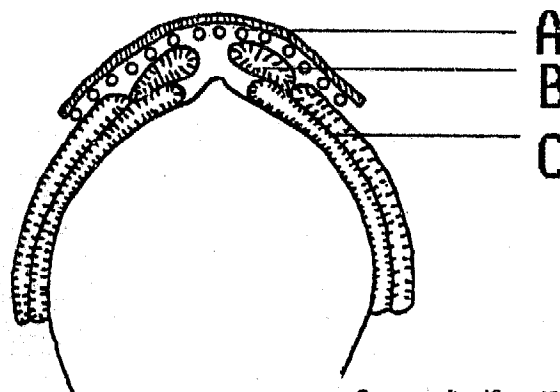
Fig. 4-14: Back harness that has been used in Japan.



Source: Barwell and Ayre, 1982

used to carry produce to and from the fields. In parts of Mali and Chad, farmers and children ride oxen without fitting saddles (Fig. 4-13). In several regions of Africa, including the Sahel and the rangelands of eastern Africa, pastoralists use simple basketwork panniers to enable cattle to carry household belongings when moving between sites (Fig. 4-15).

In the humid and semi-humid areas of Africa, disease generally prevents donkeys being used as pack animals and luxuriant vegetation and watercourses restrict the use of animal-drawn carts. In such circumstances farm produce and materials are generally head-loaded by women and men, and there would seem to be scope for using pack animals (Spencer, 1988). However such areas are generally those where cattle populations are low, people are unfamiliar with cattle husbandry and the presence of tree stumps makes it difficult to use draft animals for crop cultivation. Moreover the effort required to train, saddle, load and drive a pack ox, may well be greater than the transport value of relatively small quantities of materials. There have been several small-scale attempts to introduce the use of pack oxen. One systematic attempt in Tanzania was described by King (1940) who provided details of how to manufacture pack saddles and pannier baskets of a design similar to those used by pastoralists in northeast Africa. King considered that ox pack transport was "an essential prerequisite to the extension of mixed farming on account of the increased movement of crop residues, grass roughage and manure". However despite the apparent technical success of the panniers, the ex-



Source: after King, 1940

Fig. 4-16:

Ox-saddle based on traditional Sudanese design. This pack saddle was developed for use in Tanzania, but was not adopted by farmers. A - Wooden slats tied with baobab string; B - Bolsters for protecting spine, made from sacking densely packed with grass; C - Lightly stuffed sack.

tension efforts and initial adoption by a few farmers, the technology does not appear to have spread. Other, smaller projects have had similar experiences. Thus it would seem that the use of bovine pack saddles is only likely to be worth investigating if transport is clearly a critical constraint and if it is impossible to use ox carts or pack donkeys.

Fig. 4-15: Pack saddle used by pastoralists in Somalia.

Photo: GTZ archives



5. Harnessing: issues and resources

5.1 The manufacture of yokes and harnesses

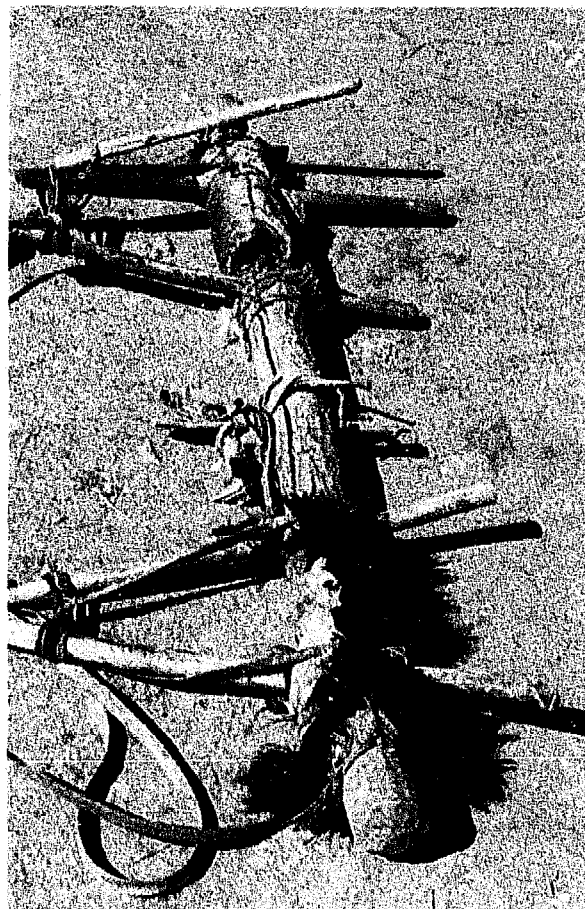
Harnesses are generally made by local artisans. This is important in ensuring that they are readily available, they can be speedily repaired and their design specifications can be rapidly adapted in the light of farmer feedback. Yokes can be easily and rapidly carved from strong but light wood and local artisans are generally aware of trees that have appropriate combinations of weight and strength. Particular attention should be paid to the final smoothing of the wood. If padding is required, animal hair is durable, and a soft but strong felt-like material if available may be suitable. Sheepskin or soft leather is effective but tends to harden if not treated. Coarse sacking is not ideal, since it tends to be very abrasive (Matthews, 1986). For fixing the implement or chain, a steel ring attached to a bolt can be easily made by a local blacksmith and inserted into the centre of the yoke. In Ethiopia farmers generally make their own yokes using wood that they may have buried for several months to prevent cracking. Six holes are made with a chisel and simple wooden pegs are placed in them (Goe, 1987). Padding is made of leather and sheep skin and straps of hide are used both to attach the plow beam to the yoke and to loop round the necks of the oxen (Fig. 5-1).

Although wood is by far the most common and appropriate material for the manufacture of yokes, steel yokes are not unknown. Some single withers yokes used in Europe, such as the Swiss harness (Fig. 4-3b), have been made from leather and steel. A prototype steel col-

lar-type yoke was designed in India in the 1960s (Ayre, 1982) but was not adopted. In the 1980s a workshop in Lesotho, supported by a United Nations project, started manufacturing steel withers yokes (Lesotho Steel, undated), although these were technically inferior to local wooden yokes. There are also reports of externally-funded projects importing steel yokes manufactured in Europe into countries such as Sudan and Somalia. While

Fig. 5-1: Yoke made by farmers in Ethiopia. (Note the sheepskin padding. The leather thong at the bottom left is part of a traditional hide whip).

Photo: Paul Starkey



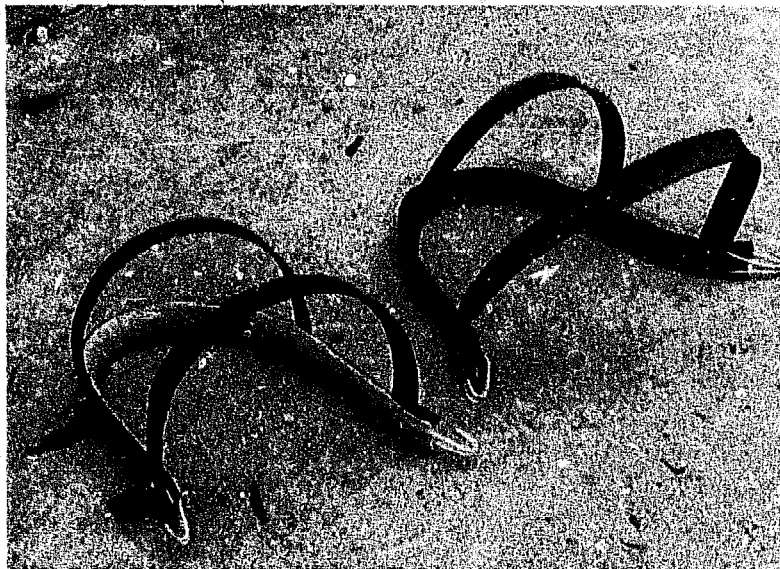


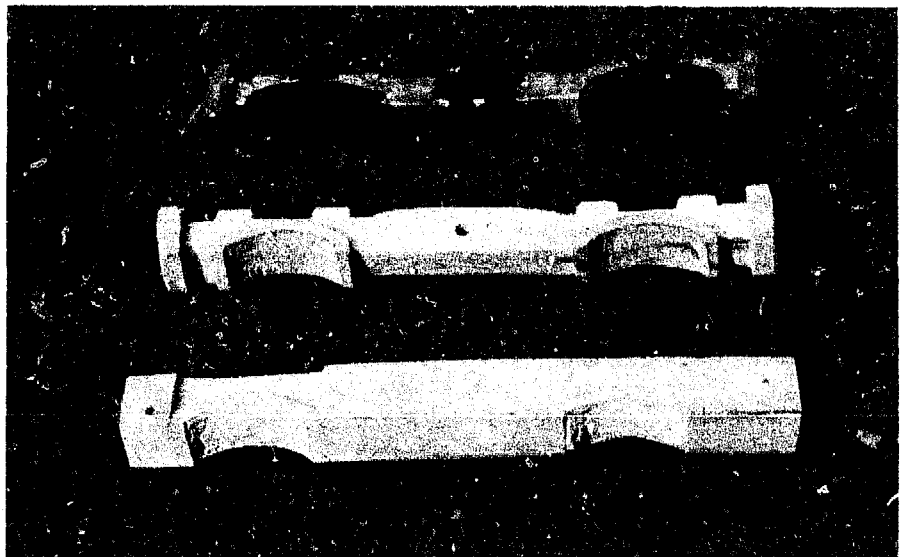
Photo: Paul Starkey

Fig. 5-2: Lined (left) and unlined (right) donkey harnesses made from tyre rubber by Mochudi Farmers Brigade, Botswana.

the order of such yokes may have been temporarily expedient in areas where wood was scarce and there was no tradition of animal traction, long-term objectives would probably have been more rapidly achieved had cooperating farmers or artisans been assisted to make wooden yokes themselves. Whereas many types of wood have appropriate combinations of weight, strength, elasticity and price, tubular steel is generally heavy, expensive and relatively difficult to pad effectively. While tubular aluminium yokes would have a better ratio of strength to weight than steel, they are expensive, easily distorted and require primary materials seldom found in villages. For these reasons the use of wood for making yokes is strongly recommended.

Fig. 5-3: Three stages of carving a horn yoke in Sierra Leone.

Photo: Paul Starkey



Schemes to develop the use of equine collar harnesses have often failed due to problems of local manufacture. It is estimated that in France a leather collar made by a well-equipped artisan takes at least 22 hours of highly skilled work (Duchenne, 1984). Transferring such skills into a new area is quite possible given time, available materials, good feedback from farmers and a realistic market. However there have been numerous attempts during the past 100 years to transfer traditional skills in the manufacturing of collars, but few have succeeded. An initial constraint has been difficulty in obtaining high grades of leather,

but the major long-term problem has been lack of market demand. In Botswana a project to use donkeys for road construction found that the local harnesses made of rubber from tyres quickly broke and were unsuitable for sustained heavy use. Imported leather harnesses were found satisfactory but the price of one harness was twice that of a donkey, and the harness for a team was 60% of the cost of a tipping cart (McCutcheon, 1985). For the project, concerned more with timeliness than

capital outlay, the expensive harnesses were considered more cost-effective than the cheaper alternatives. Local manufacture would have been feasible but equipping and training of artisans would have had to have been followed by sustained demand, and it appeared questionable whether individuals would opt for the high-quality, high-price alternative.

In another initiative in Botswana, the Mochudi Farmers Brigade tested a large number of harnessing systems, and eventually promoted the local manufacture of a simple breast band harness for donkeys. This was made of car-tyre rubber, but the load bearing bands were lined with soft material (Fig. 5-2). The long-term success of recent artisanal training schemes in Kenya and Zambia based on the production of three-pad collars for donkeys

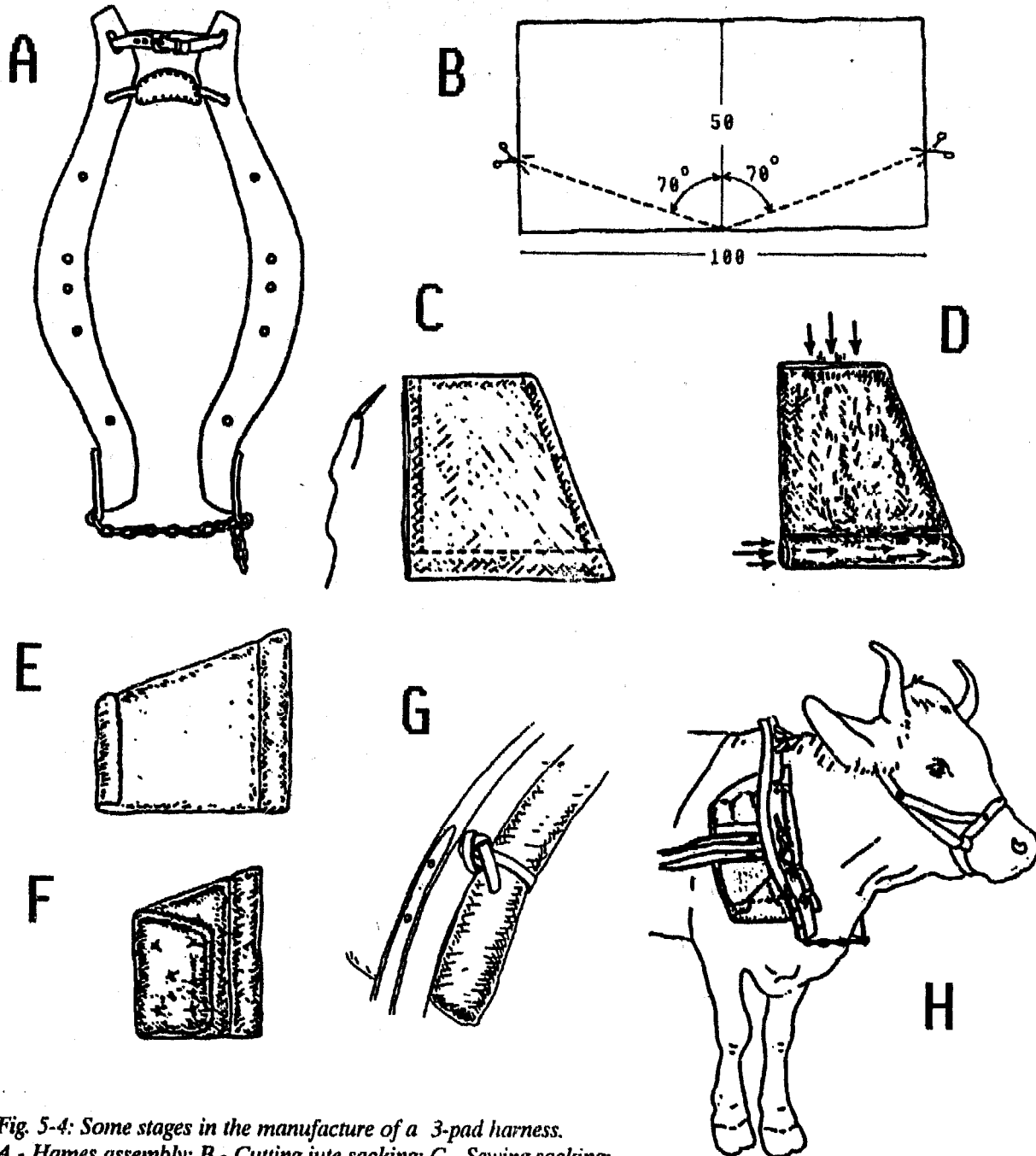


Fig. 5-4: Some stages in the manufacture of a 3-pad harness. A - Harness assembly; B - Cutting jute sacking; C - Sewing sacking; D - Stuffing pads; E, F - Folding pads; G - Tying pad to harness; H - Final harness.

Source: after Micuta, 1984

and cattle (Dibbits, 1985a, 1985b; Micuta, 1985) will depend on sustained demand at prices economically acceptable to both producer and consumer.

In industrialized countries where animals are now mainly harnessed for recreational use, synthetic webbing harnesses are beginning to replace traditional leather straps. These are strong, light, rot-proof and washable and cheaper than leather. Such purpose-made materials are not yet readily available in rural areas in developing countries, but farmers/artisans have already been seen to experiment with synthetic materials used for fertilizer or grain sacks (Fig. 3-33). Furthermore in towns where draft animals are used, it is not uncommon to see other innovative materials derived from imported goods being used for harnesses. Such experimentation may well eventually lead to the discovery of appropriate new harnessing materials and techniques, and researchers should be aware that such informal evaluation may well be taking place near them.

5.2 Some practical problems with harnessing systems

Many of the problems associated with any harnessing system are not attributable to defects in the basic design, but are due to poor finishing or incorrect positioning or adjustment. Many sores and abrasions are caused by rough wood, by joints or stitching that are not smoothed or covered, or by the failure to use soft padding. Further discomfort can be caused if the yoke or harness is unnecessarily heavy for its required tasks. Breastbands and collars need to be particularly smooth and well fitting. Problems are commonly due to the use of rough materials, stitching irritating the animals' skin or to straps being too long or short for an ideal line of pull.

Head yokes should be attached firmly to the horns. If one watches animals with loose fitting head yokes, one can see the discomfort

caused to the animals as the yoke vibrates against the head, or when the movement of one animal causes the yoke, acting as a lever, to twist against the head of its partner. Such discomfort may lead to "protest" head movements designed to loosen the yoke which actually exacerbates the problem until the yoke is re-tied. The central yoke ring, or other system for attaching the beam or traction chain should be so positioned as to allow a straight pull from the centre of the yoke to the implement. If the attachment is raised or lowered, it will tend to act as a lever and cause the neck yoke to rotate, putting extra strain on the attachment ropes and causing discomfort.

Withers yokes do not need to be tightly attached, but problems are often experienced by poor fitting of the descending bars and/or leather strap. These should be smooth to prevent damage to the skin of the animals during fitting and use. If they are to be used primarily as spacers, they do not need to be strong, but if they are designed to take some of the load, then greater strength is required. Whether or not the descending bars take load will depend on their spacing and the point of attachment of the traction chain or beam. If the point of attachment is below the yoke (as in many traditional European yokes), then the distance between the centre of the yoke and the attachment point will act as a small lever. This will mean that during work, the yoke will tend to rotate, and if the descending arms are relatively close together, they will come into contact with the animals' shoulders. In such circumstances smooth broad descending bars are required (in Europe and North America, broad poles shaped into a U-form were often used). If the bars are spaced far apart and/or the thong is tight, then the rotation of the yoke may cause the thong to start pressing against the neck of the animal. This can cause considerable discomfort. If the point of attachment is higher than the centre of the yoke, the yoke will tend to rotate in the opposite direction, the bars moving forward until the leather thong presses against the throat of

the animal (Fig. 5-5). This is also uncomfortable and inefficient, and can be remedied by attaching the beam or traction chain below the centre of the yoke.

In any locality there are likely to be examples of well-finished and correctly fitted harnesses, and others that cause discomfort. The potential for improvement is therefore enormous, although claims should not be exaggerated. Some authors have argued that their favourite yoking system could halve

the number of animals needed for a particular operation; this (it has been suggested) would have the same impact as either increasing the number of working cattle by 20-50% or of releasing large quantities of additional animal feed. Such claims are almost certainly spurious, being based on extrapolating *ad absurdum* the results of simple trials. Controlled experimental work at the University of Edinburgh demonstrated that while there was not a great difference between the technical efficiency of various designs of yokes and collars, animals were certainly more willing to work if the harnessing system was comfortable (Lawrence, 1983). The implication is that while the metabolic energy required to perform an operation is broadly comparable whichever harnessing system is employed, the "nervous energy" required from both animal and human may be much greater with an uncomfortable yoke. Animals need more encourage-



Photo: Paul Starkey

Fig. 5-5: Example of a harnessing system causing an animal discomfort as the rotation of the withers yoke makes the cord press against the animal's throat.

ment and goading if their harness is uncomfortable, and the discomfort of the animal can be matched by the frustration of the farmer.

It is clearly in the interests of the animals themselves and of the farmers that harnessing systems are made and fitted comfortably. In all countries where animals are used for work, there is probably great scope for improving overall harness comfort, and thereby the productivity of both animals and farmers, by very simple and inexpensive modifications or adjustments to the systems already in use.

5.3 Research and development on harnessing systems

In recent years there have been a great many calls for more systematic research on harnessing systems (Smith, 1981; Goe, 1983; Copland, 1985; Matthews, 1986; Bordet *et al*,

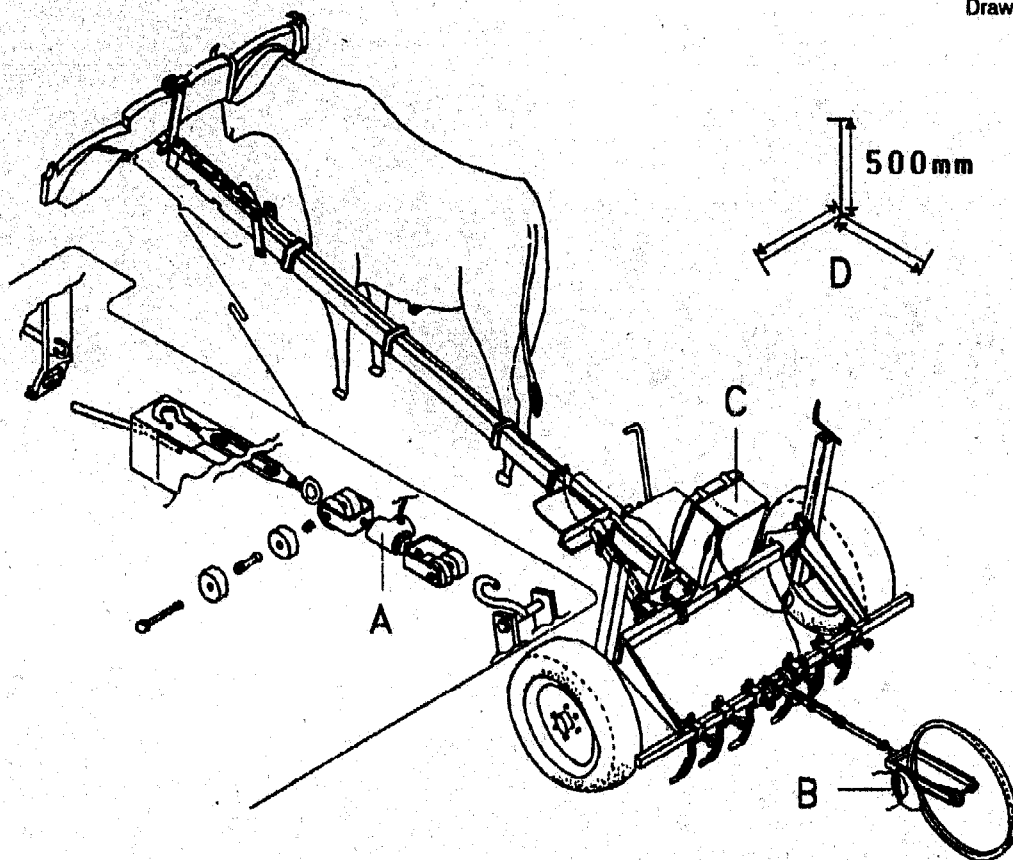


Fig. 5-6: Wheeled toolcarrier adapted as an "ergometer" for data logging by the CTVM, Edinburgh. A: Loadcell (measures force). B: Odometer (measures distance). C: Microprocessor (computes work). D: Isometric scale for the drawing.

1988; Starkey and Faye, 1988). However before launching new research initiatives, it is wise to be aware of the methodology and results of previous studies.

Some research studies on yoking systems in Europe have been descriptive and have reviewed the different harnessing systems in use in an area, and obtained farmer opinions on the relative merits of different systems (Delamarre, 1969; de Oliveira *et al.*, 1973). Similar studies in developing countries could be valuable in providing a geographical or historical perspective, and be helpful in inhibiting unreasonable optimism over supposedly "new" harnessing systems.

Other workers have concentrated on comparing two or more harnessing systems. A few of these should be dismissed from the point of view of research as well-meaning, but spuri-

ous, being designed in the form of demonstrations to *prove* that a "new" or "improved" design was better than an existing design. Commonly these have confused two or more parameters but have nevertheless tried to present their results in a semi-scientific form. Unless there has been some form of replication, randomization, control and objective measurements, then *results presented as percentage improvements in efficiency should be treated with great caution*. Nevertheless provided they are acknowledged as such, evaluation trials based primarily on subjective judgements rather than measurements can be extremely useful as a means for assessing options (e.g. Froese, 1980). Demonstrations can encourage innovative farmers to experiment with different designs, but it should always be remembered that draft animals may require time to become used to changes in their harnessing system.

Replicated trials involving the measurement of force (dynamometer readings), time, distance travelled, speed and work achieved have been reported from: India by Vaugh (1945), Swamy-Rao (1964) and Varshney *et al.* (1982), Bangladesh by Hussain *et al.* (1980) and Barton (1988), Bolivia by Salazar (1981), Burundi by Barton (1985), Costa Rica by Lawrence and Pearson (1985), Thailand by Garner (1957), the United Kingdom by Barton (1985) and the United States (Kivikko, 1987). In addition, trials involving the detailed recording of animals' physiological responses to different yokes have been recorded for buffaloes and Brahman oxen walking on treadmills (Lawrence, 1983; Islam, 1985). Some of the findings of these various trials have been discussed by Duchenne (1984), Matthews (1986) and in Chapters 3 and 4 of this book.

There is not space for a detailed review of the various research results here, but five main observations seem noteworthy.

- Firstly the various "improved" forms of padded yokes and collars do seem to have allowed greater work relative to *some* traditional designs. This may be because comfortable harnesses make animals more willing to walk faster and/or pull harder.
 - Secondly some quite high apparent benefits in technical efficiency did not generally lead to major differences in achieved on-farm work, such as the area cultivated in a week.
 - Thirdly when a large range of yokes has been tested there have generally been examples of *alternative* traditional designs that have been much cheaper than the "improved" designs, and which have been of comparable efficiency (in some trials - such as those of Vaugh, 1945, Hussain *et al.*, 1980, and Varshney *et al.*, 1982 - some traditional harnesses have out-performed "improved" designs).
 - Fourthly most "improved" yokes appear to have been significantly more expensive or more complicated than traditional yokes.
- Finally despite a detailed review of the literature and personal communications with many of the authors referred to in this section, it appears that there are *no known reports* of cases where the various "improved" designs mentioned have been widely adopted by farmers.

Recent advances in electronics have made it possible to collect large quantities of data and to process it rapidly using computers. Lawrence and Pearson (1985) described a wheeled toolcarrier adapted to collect data on force, time and distance in the field (Fig. 5-6). The instrumentation used for these earlier studies has since been developed at the Centre for Tropical Veterinary Medicine, UK, into a portable ergometer capable of accurately measuring draft force, animal power output, work done and distance travelled for periods of time that can range from a few seconds to a full working day (Lawrence, 1987). Another system of data capture developed by AFRC-Engineering, UK, has been described by Matthews and Kemp (1985), O'Neill *et al.* (1987) and Kemp (1987). This system involves almost constant measurement of physiological parameters (temperature, heart rate, respiration rate), walking characteristics (speed, walking rhythm, distance), work loads (forces, angles) and the external weather conditions (sun, temperature, wind). Using small sensors linked to a portable computer, farmers' animals can be used in on-farm trials, and by correlating the information obtained with simultaneous video-camera recording, comprehensive overall pictures can be obtained. Such data collection should be able to provide detailed comparisons of different yoking types and if combined with appropriate analyses (and farmer opinion!) may be able to assist in the identification of low-cost and simple means of increasing the efficiency of yokes. Several institutions including AFRC-Engineering (England), CTVM (Scotland), CEE-MAT (France), CIAE (India) and ILCA (Ethiopia) are cooperating in this high-technology approach to animal traction research,



Photo: AFRC-Engineering archives

Fig. 5-7: Prototype data-logging instruments developed by AFRC-Engineering being used in Botswana. The wires from the load-cells and sensors attached to the animals pass through an "umbilical cord" to a battery-powered computer, held by a research worker.

and in 1987/88 field trials were held in India, Botswana, Burkina Faso, Morocco and Nepal. Matthews (1986) suggested that the development returns from small scale, *ad hoc* harnessing research programmes are likely to be minimal. It could be added that returns to any harnessing programme may depend more on its relevance to the needs of particular farmers than the technology employed.

In conclusion development workers contemplating research on harnessing systems should:

- Consider whether harnessing is actually a limiting factor.
- Review the subject from a historical and geographical perspective, and identify popular designs used successfully by farmers in the region, or elsewhere.
- Define the harnessing criteria to be studied, clearly distinguishing between those separate elements that are often confused (single, double or multiple animals; rigid or flexible linkages; combined or independent hitching systems).
- Note that socioeconomic aspects of harnesses (convenience, cost, fashion, status) seem to be at least as important as technical specifications, so that it may be more valuable to ask farmers to test harnessing systems themselves, under their own conditions, rather than undertaking replicated trials to measure technical efficiency.
- Consider whether objective measurements (as opposed to farmer assessment) are actually essential; if they are, then cooperation with an institution capable of mass data collection and analysis might be sensible.
- Remember with humility that, while there have been historical examples of farmer-initiated innovations, there seems little evidence that any *experimental research*, whether using simple mechanical dynamometers or computers, has yet had any significant impact on harnessing at farm level.

5.4 Choice of harnessing systems

For hundreds of years harnessing systems in many parts of the world have been strongly influenced by fashion, prejudice and tradition and their present form often strongly reflects local artisanal skills and interests. Archaeological evidence suggests that head yokes originated in ancient Egypt, withers yokes in ancient Mesopotamia and collars may have first been developed from modified withers yokes in China (Duchenne, 1984). All main types of harnessing system have been used in Europe since the eleventh century and there are written records spanning over six hundred years debating the relative advantages and disadvantages of horn yokes, withers yokes, breast bands and collars (Delamarre, 1969; Fenton, 1969). The pattern of debate and evolution is fascinating, with wars and grain prices discouraging the use of horses and collars and innovators in each generation trying out the yokes others regarded scornfully as "foreign" to their region. However the pattern of evolution is not technically conclusive for while collars became almost universal for heavy work with horses, for cattle head yokes, withers yokes and collars all had their advocates and their regions of sustained use.

In Africa, Senegal and The Gambia (Senegambia) provide a particularly interesting example of harnessing diversity for during the past eighty years farmers have used double head yokes, double withers yokes, single yokes, breast bands and collars. Senegambia has over half a million working animals including large numbers of horses, donkeys, Zebu cattle and taurine cattle (Havard, 1985). Its farmers have a proven record of rapid diffusion of innovations, with donkey technology and breastbands rapidly spreading through informal farmer channels in an area previously dominated by oxen and head yokes (Starkey, 1987). All harnessing types still exist, but bovines are almost never used singly or with collars. There is a tendency for N'Dama taurines to be harnessed with double head yokes, and

Zebus to be used with withers yokes, but this is not absolute. Equines are seldom yoked; equine breastbands are widespread but collars are rare. Thus Senegalese farmers seem to prefer double yokes for bovines and breastbands for equines.

Fashion and prejudice are not confined to farmers. Some recent reviews have been forceful in their condemnation of traditional yokes and promotion of favoured "improved" styles. Viemeyer (1982) stated "a classic of bad design is the traditional yoke used for oxen and water buffalo - the straight beam on which the animal pushes with its forehead or neck". He went on to cite claims of 70 percent improvements in efficiency using bovine collars and concluded that yoking with a rigid bar should always be replaced with independent hitching. The suggestion that traditional bovine yokes can be inefficient and cruel has been made by many people including Smith (1981), Micuta (1985), Ramaswamy (1985) and Barwell and Hathway (1986). However a less dismissive stance was taken by Goe (1983). While admitting traditional yokes were not optimal, he suggested that before attempting to introduce new types of yokes, it would be worthwhile to assess the merits of the traditional types used in a particular area, and select the best for modification. In the light of the lack of rapid diffusion of technically efficient "improved" yokes designed by researchers, this seems a more positive approach.

To illustrate the complex interaction of ergonomic design, fashion and local adaptations one can take, by way of analogy, an example from a different area of development. Traditional methods of transporting water between remote sites can involve carrying containers in the hands, using two containers balanced on a pole or shoulder yoke, by head-load or by back and head-strap. The use of wheeled water containers has often failed to catch on due to expense, inappropriateness to the terrain or local preferences. Clearly jagged edges on any container are potentially injuri-

ous and dangerous and if the surface of the container or carrying pole is rough, padding may be used. The absolute weight of water a person *can* carry by any method is related more to the person's strength than to the design of the container. The weight *actually* carried may be greatly influenced by design. Buckets with round, broad handles have a larger contact area and are less painful to hold when full, so that one may be more willing to carry a heavier weight of water if the bucket has a broad handle. Nevertheless broad bucket handles are by no means universal, and narrower handles with some rags as padding may be as effective. Improving the handle of an existing bucket may improve comfort and possibly reduce the number of rests needed, but if the limiting factor is actually the small size of the bucket or the availability of water at source, there will be no dramatic changes observed by improving the handle. It is not intended to digress further on the ergonomics of water transportation, but the parallels with yoking systems should be clear and seeing similar problems in another context may help to clarify the key issues under consideration here.

In conclusion, any technology is likely to be a compromise between economic cost and technical excellence. In addition the importance of social considerations (including fashion) should never be underestimated. While it appears that independently hitched collar type harnesses may be the most technically efficient, they are also generally the most expensive and complicated to use. Differences in efficiency between a well-padded and a poorly padded local yoke or a well fitted and a badly fitted harness may well be as great as differences between the harnessing systems themselves. It is likely that the main harnessing types will continue to be the double or single withers yoke, the double head yoke and the breastband. In the short term the most likely improvements will be very simple changes in contouring and padding. In many areas improvements in overall harnessing efficiency

are more likely to come from encouraging the correct use of farmer-proven designs from within a region rather than from promoting innovations.

5.5 Further reading and information sources

Clear, well-illustrated reviews of the subject have been prepared by Duchenne (1984) and Poitrineau (1990). Advice of a practical nature can be found in Watson (1981). Illustrations of modern attempts at "improved" yokes together with a general discussion of issues and merits are provided in Barwell and Ayre (1982). Drawings of yoke types currently used in Africa and discussions of advantages and disadvantages can be found in CEEMAT (1971), FAO/CEEMAT (1972), Hopfen (1969) and Viebig (1982). An illustrated review of technical principles is provided by Devnani (1981) and a general discussion of issues is given by Matthews (1986). Details of harnessing arrangements used for carting can be found in Barwell and Hathway (1986). Many interesting articles but of more limited scope or relating to specific research projects have been cited in Chapters 3, 4 and 5 and details of these references are given in Chapter 12. Among institutions involved in this area are ACIAR-DAP, AFRC-Engineering, Bellerive RT, CEEMAT, CIAE, CTVM, GRDR, GRET, ILCA, IT-Transport and Tillers International and the full names and addresses of these organizations are given in the Appendix. African countries with organizations undertaking trials on different harnessing systems in 1988 included: Botswana (ATIP), Ethiopia (ILCA, AIRIC), The Gambia (GARD), Kenya (University of Nairobi), Mali (DRSPR), Morocco (INRA-MIAC), Niger (Projet FAO, ISC), Sudan (JMRDP), Togo (PROPTA), Zambia (MoA-ADP Project) and Zimbabwe (IAE) and further details of these and other relevant organizations can be found in the GATE Animal Traction Directory: Africa (Starkey, 1988).

6. The selection of equipment

6.1 Equipment evolution and development

It may appear self-evident that animal traction equipment must be appropriate to the local farming systems. Yet in most developing countries there have been examples of the promotion of equipment that (with the expertise of hindsight) was clearly not adapted to local conditions. Graveyards of abandoned or unused implements tell their own tales.

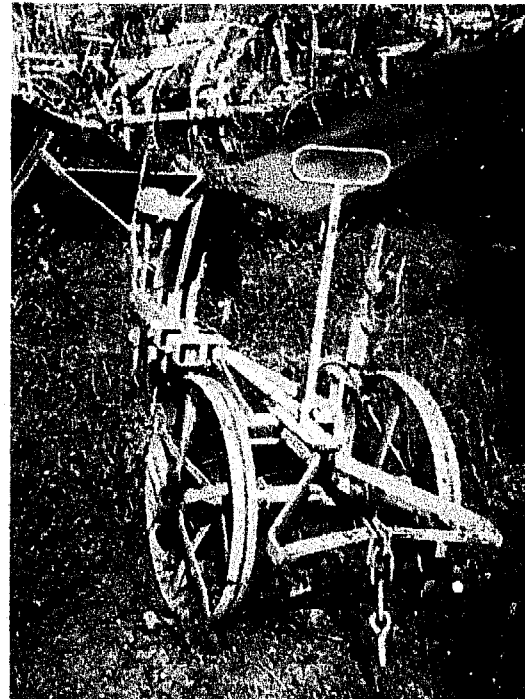
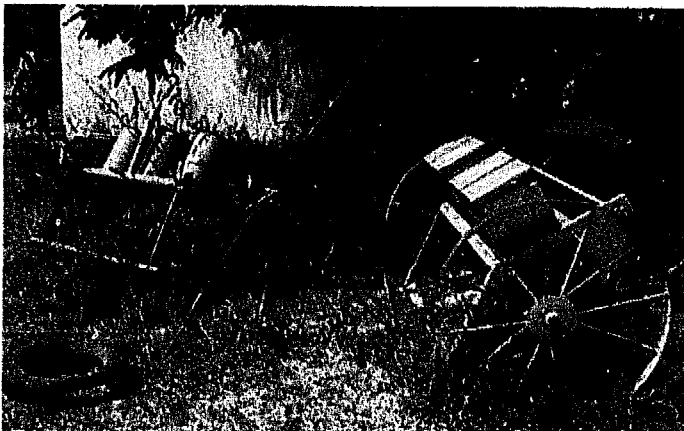
Farming systems are dynamic and constantly evolving. The continued development and adaptation of any equipment used within a farming system is ensured by two major processes: variation and selection. The analogy of evolution (or artificial breeding) is quite apt, for the refinement of organisms or equipment is based on the natural or artificial selection

of the preferred options. If either variation or choice are lacking, there can be no scope for improvement. Successful breeding (or equipment) programmes involve the multiplication of the chosen and the culling of the inferior options. Selection must involve rejection. (The implication is that small equipment graveyards are an inevitable result of evolutionary pressures, but this should not justify the active promotion of dinosaurs!)

Historically, large or small changes in equipment have been made by innovative farmers themselves, often working with village artisans or local manufacturers. The choice of whether to use the old or new design has been taken by the farmers and their neighbours. This process is actively continuing all the time, in all communities. This system of evolutionary progress has led to the development of most agri-

Fig. 6-1 and 6-2: Small equipment graveyards (such as the one below in Mali), are an inevitable consequence of the process of testing, selecting and rejecting animal-drawn implements. Larger stockpiles of unwanted implements (such as the consignment of heavy reversible plows seen in Togo, right) could be prevented if more attention was paid to the initial selection criteria.

Photos: Paul Starkey



cultural equipment in use today. The process is intrinsically efficient in the long term, but very slow by the standards and aspirations of modern governments and development projects. The process can therefore be speeded up by providing more variation and a greater degree of selection.

There are great advantages in creating the variation within the environment, by encouraging artisans and manufacturers to modify (and thereby possibly improve) existing equipment, or experiment with new designs. Nevertheless numerous and varied designs of animal traction equipment have already been created so that it is unrealistic and inefficient to try to develop new designs entirely in isolation. Unfortunately many projects have attempted to do just this, and have often succeeded only in "re-inventing the wheel", by developing designs of harnesses, seeders, toolcarriers or other implements similar to those already in existence. It is most important to benefit from existing knowledge and the experience of others elsewhere. In general, broad selection should be based on existing designs, while further modification, selection, rejection and evolutionary development may be best carried out within the local farming systems.

Fig. 6-3: Plowing a field in eastern Zaire: the soils have tree stumps and strong rhizomes, access from the distant village is by narrow path, and the animals are disease-prone. All these factors should be considered when selecting implements for this farming system.

Photo: Paul Starkey



6.2 Definition of requirements

In recent years many animal traction programmes have neglected the important stage of definition. Before equipment is purchased or developed it is useful to write down, in as much detail as possible, precisely *why* it is needed, *what* it is required to do and *in what context* and *with what resources* it will be used. Only after the actual requirements have been clearly defined, should the detailed technical specifications be listed.

The definition of requirements must be derived from the farming systems in which the equipment will be used. Thus if farmers' fields have tree roots in them, any cultivation implement intended for that farming system should be able to cultivate in the presence of roots. Naturally farming systems are constantly changing so that the addition of a new item of equipment leads to some change (large or small) in the whole system. Thus the availability of an implement that can only work in root-free conditions *may* cause farmers to remove the stumps from their fields. It may, on the other hand, lead to the rejection of such an implement as inappropriate to the actual conditions. Thus a clear distinction must

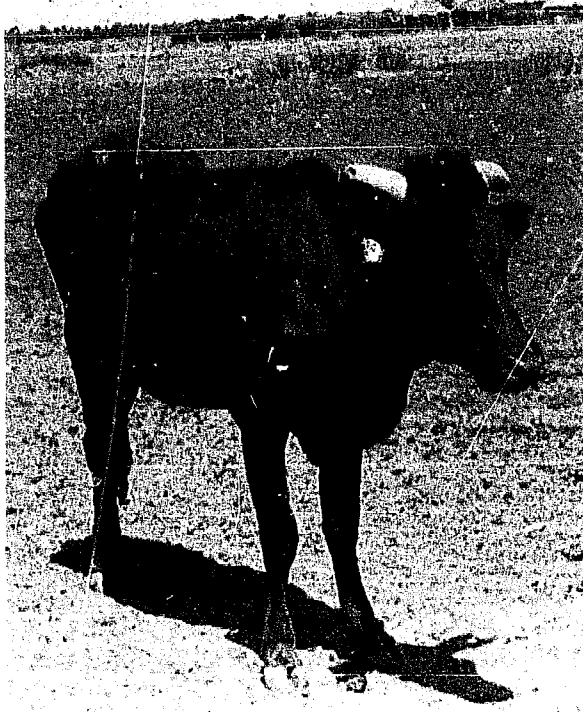


Photo: Paul Starkey

Fig. 6-4: At the end of the dry season in Botswana cattle are often emaciated, but still expected to work. Unless dramatic changes in nutrition are realistically envisaged, equipment has to be designed for use by such animals.

be made at the stage of definition between the *realities* of existing farming systems and any *assumptions* relating to prerequisite future changes that have been made. Common assumptions relating to animal traction equipment use have included:

- changes in the timing and duration of operations;
- increases in yields and profitability;
- improvements in the availability of technical services (such as repair and maintenance).

The disappointments of many animal traction programmes that made such presumptions should be taken as a warning. In general, optimistic assumptions should be avoided or kept to a minimum: wherever possible equipment requirements should be defined in such a way that the equipment can be used within the *actual conditions prevailing*. This may mean that in rapidly evolving farming systems,

equipment needs may change frequently. Animal traction programmes may find it more beneficial to anticipate small but progressive changes in farmer demands for equipment rather than to promote technological leaps.

Realism is also required in assessing the available power of the animals. One of the most common mistakes made by animal traction programmes in recent years has been to seriously overestimate (or overlook) the draft capabilities of the farmers' animals. Many equipment designs produced by engineers on research stations have been rejected by farmers as too heavy for their animals. *If animals are normally in poor condition* at the time an operation is required then it should seem quite evident that *equipment must be capable of being pulled by animals in poor condition*. It seems quite pointless promoting heavy equipment developed and tested with large and well fed animals, if such beasts do not exist in the local farming systems!

The realistic approach being advocated here certainly does not preclude trying to improve the condition of the animals at the same time as equipment is being promoted. What is essential however is to carefully distinguish between present realities and optimistic assumptions. A "package deal" may well be envisaged in which the use of heavy equipment is directly linked to improved animal nutrition, *provided* it is understood by all concerned that such equipment is *not* designed for the existing farming system. In such a case the very ambitious nature of the objectives should be clearly understood since any "stronger animals" policy will have a very much wider scope than normal equipment-package credit-programmes. The promotion of "heavy" equipment necessitates successfully tackling one of the most difficult animal traction problems, that of finding a *realistic* and *economically acceptable* way of improving animal condition in normal village circumstances. Until proven, realistic and acceptable methods of improving draft power are available, animal

traction equipment should be suited to the strength of existing animals.

In the early stage of definition environmental issues must be carefully assessed. In most farming systems there are techniques that conserve soil and water and others that degrade the environment. For example there may be certain ecosystems, including some in arid or mountainous areas, in which mouldboard plows, tines or disc harrows may tend to accelerate erosion, particularly if used without reference to prevailing slopes. There might be ecological implications in encouraging the use of wooden animal-drawn implements in the Sahel, where other pressures on timber resources have caused major deforestation. The impact on local cattle populations and grazing resources on a change from heavy draft cattle plows to lightweight donkey tines could be considerable.

It is also essential to thoroughly consider socioeconomic criteria. When assessing the requirements for any piece of equipment it is necessary to know how the farmers, together with their families and communities, judge the value of the operation performed by the implement. This may involve knowing who undertakes that operation (farmer/labourer; child/man/woman), the time taken to perform

the operation and whether it is undertaken at a time when labour is plentiful or scarce. If the objective is to use animal power to replace human power, it is important to determine whether there would be a beneficial or detrimental shift in the category of labour or the time of operation. With an assessment of the value of the operation, it should be possible to gauge an affordable cost. Again realism is essential and optimistic assumptions should be avoided: far too many programmes that ended as disappointments had judged that farmers could have afforded high cost implements *assuming* that cultivated areas and yields had increase dramatically.

The importance of risk in determining farmer decision-making is often neglected. Subsistence farmers have been seen to select an option that minimizes risk and increases security, over an alternative that may be intrinsically more profitable, but which increases risk. For example some farmers in The Gambia opted for donkey powered equipment over ox-drawn alternatives largely because they considered that donkeys were less likely to be stolen. Farmers may prefer several single purpose implements to one multipurpose toolbar if they perceive that the risk of the one implement being damaged and leaving them without any usable tools is too great.



Fig. 6-5: On-farm evaluation of equipment by farmers is crucial to ensure the size, weight and technical characteristics of implements are to be appropriate for the animals, the people, and the farm conditions in which they are to be used. Here a mouldboard plow is tested by women farmers in Sierra Leone.

Photo: Paul Starkey

It must be remembered that, in reality, *there is no such thing as an average year*. Most years are exceptional in some ways, being particularly: dry, wet, late, early, hot, cold, calm, stormy, or with greater/fewer than normal weeds, insects, fires, social obligations or political upheavals. If this should seem self evident, it can be very illuminating to read the annual reports of the numerous research and development programmes working with animal traction. It has been frequently concluded that some piece of animal traction equipment or technique on trial was basically excellent, but unfortunately it did not do well *that year* because of exceptional circumstances! Seldom were such constraints major, once-in-a-generation catastrophes, and most were the normal "exceptional conditions" that a farmer must survive each year. It is clear that reliability under a wide range of conditions is often high in priority when farmers select appropriate equipment.

Finally, lest it be implied that farmers are infallible in their selection criteria, it must be remembered that they too are influenced by fashion, and that the prestige gained from the ownership of any piece of equipment may be more significant than technical characteristics. Some farmers will buy equipment mainly because it is new and innovative, while others will reject it for precisely the same reason. Even paint colour can have a decisive influence on whether one type of animal traction equipment is accepted or rejected.

6.3 Review of available production models

Having clearly defined the specifications in terms of the operational requirements, the available draft power, the economic resources and the physical, social and technological environment, it is sensible to review what proven technology exists that meets these requirements. A useful directory of information sources on agricultural implements is available from UNIDO (1982). Bordet *et al.* (1988)

compiled publicity sheets from many manufacturers supplying animal-drawn implements to West Africa. A valuable guide for intending purchasers that provides illustrations of many different products together with manufacturers' addresses was prepared by ITDG (1985). Anyone using the ITDG publication should remember that it was based on manufacturers' publicity sheets available at the time of preparation. Some of the designs illustrated have been used by farmers in tens of thousands while others were actually very early production models that were subsequently rejected by farmers. Few manufacturers would admit this if they thought a new order might be forthcoming and so information should be obtained from people working closely with farmers in comparable environments. One source of addresses of potential contacts for such information (Ministries, projects, non-governmental organizations) is the GATE Animal Traction Directory: Africa (Starkey, 1988).

6.4 Review of previous adaptation work

In the past fifty years there have been literally *thousands* of person-years spent on animal traction equipment development and adaptation. While many of the experiences gained were never adequately recorded, a great deal of information is available to those prepared to seek for it. In many countries old annual reports (even those dating back to the colonial era) provide a useful starting point, and where formal reports are not easily available, it may be well worth posing some questions to long-established or retired agricultural officers or instructors.

Agricultural magazines and journals are rich sources of information, and examples of useful titles can be found in the bibliography of this book. Further animal traction bibliographies have been produced by Goe and Hailu (1983), Bartlett and Gibbon (1984), Marti, Allafort and Bigot (1985), Marti and Second

(1988), CTA-CEEMAT (1989) and Goe, Starkey and Sirak Teklu (1989).

Even more information can be obtained by personally contacting colleagues in other organizations. Particularly valuable information can come from personal correspondence and from unpublished reports supplied by colleagues. A recent detailed study of design and adaptation work on animal-drawn wheeled toolcarriers during the past 30 years illustrates how illuminating details may be found when published reports are followed up with personal correspondence (Starkey, 1988). This example of equipment that was "Perfected yet Rejected" showed just how much unnecessary duplication of effort can take place when people fail to examine and build on previous experiences. Similar studies on many aspects of animal traction (for example animal-powered gear systems, yoking designs or animal-drawn seeders) would undoubtedly demonstrate similar repetition of work.

While a review of previous experience should be regarded as an essential part of any equipment selection and development programme, caution is required in interpreting published reports and personal communications. People inevitably prefer to portray their work as highly successful and generally emphasize their triumphs rather than their disappointments. Although many of the most useful lessons come from apparent "failures", in practice few people are prepared to discuss or publish details of farmer rejection. In contrast very many rush into print when they have had an innovative idea, and describe their prototypes in glowing terms. Such optimistic communications are indeed most valuable, *provided* they are presented by their authors as interesting but unproven ideas, and provided they are understood merely to be this by their readers. Far too often equipment designs have been misleadingly presented, or wrongly interpreted, as being highly successful, even when they had not passed any tests relating to farmer adoption.

In many cases a few weeks or months spent tracking down relevant reports and communicating with colleagues in the same country, and in other countries, can save months or years of unproductive design or evaluation work.

6.5 Research and development

A summary of the stages involved in practical research and development work on animal traction equipment was drawn up by a discussion group at the Networkshop "Animal Power in Farming Systems" (Starkey and Ndiamé, 1988). The stages listed were:

1. Identification of needs: study of the farming system in which equipment will be used, and context of work for which it will be selected or developed.
2. Operational requirements: definition of exactly what the equipment is required to do.
3. Specifications: clear listing of weight, draft, size, working width (requirements, limits), affordable costs, technical level of users, maintenance requirements, working life.
4. Study of options: review of available equipment (locally or from other countries) that meets specified requirements.
5. Selection of design. If none available development of new prototype or adaptation of existing equipment.
6. On-station testing and evaluation of selected design.
7. On-farm testing and evaluation with farmers.
8. Standardization of appropriate design, with formal drawings.
9. Small batch production and distribution to farmers.
10. Further on-farm evaluation with farmers to establish durability and suitability.
11. Economic studies and assessment.
12. Large scale production and extension.

This list should not be taken as definitive (for example socioeconomic determinants such as risk have not been cited) but it is helpful for identifying a desirable methodological sequence. Although the list implies a series of logical processes, each dependent on the success of previous stage, this should be treated with caution. Economic studies could usefully be included as several stages of the development process, and there will be circumstances when technology can be tested by farmers without first having completed on-station evaluation. However the sequential concept can be helpful when identifying the areas in which individuals and organizations should concentrate their time and resources.

It is clear that stages 1-3 (identification, definition, specification) are highly specific to particular localities and farming systems. These will have to be carried out to a greater or lesser extent by each national or area programme, although there is much scope for building on the experience of previous work in nearby or similar ecosystems. Stage 4 (overview of options) is particularly important as this provides much scope for selection from

existing variation, so building on existing knowledge.

Unfortunately, in recent times national agricultural engineering departments, projects, universities and international research centres have often started at the phase of prototype development in areas of particular interest to staff members. They have often neglected the earlier methodological steps (1-4) and omitted to precisely define priorities and actual requirements. It is often both arrogant and unrealistic to suppose that a new design is required and that it can be quickly and easily produced by a small organization (project, department or manufacturer). Actual experience in recent years has shown clearly that most animal traction equipment prototypes have been very expensive in terms of human time, and largely ineffectual in terms of farmer acceptance. Undoubtedly there must be room for imaginative invention and innovative experimentation in order to produce completely new designs for farmer evaluation and possible overall progress. Nevertheless with so much previous work in this field, those involved in development programmes with limited resources should understand that the creative adaptation of proven designs,

Fig. 6-6: On-station testing of a "Strad" cultivator in Nigeria. The animals, people, soil conditions and technological environment of a research station are seldom representative of the local farming systems.

Photo: Enoch Gwani



achieved by engineers working closely with farmers, is much more likely to bring beneficial results than are attempts to produce entirely new designs.

Adaptation work or prototype development should generally be undertaken in close cooperation with farmers, local manufacturers and village artisans. The importance of involving blacksmiths in equipment development is discussed further in Chapter 11. It is also most important that the testing and modification of equipment are carried out in conditions representative of those in which the equipment will be used. While there is a role for on-station trials in the screening of new designs, this stage should be kept to the minimum. Wherever possible from the very first year there should be replications of trials on farmers' fields. Where this is not possible, farmers' advice should still be sought, and they should be actively involved as participants or external consultants in planning, executing and evaluating research programmes.

The common image of farmers as always conservative can be quite misleading when it comes to research and the evaluation of new equipment designs. It is quite natural that farmers should be reluctant to risk their livelihoods and scarce resources on the wholesale adoption of unproven techniques. Had they been so gullible, many a farming family would have suffered badly as a result of the misplaced confidence, enthusiasm and persuasion of research and extension workers. Farmer realism in the face of unproven equipment designs should not be misinterpreted as indicating total resistance to change. In almost all circumstances there are farmers willing to *try out* new implements and techniques; indeed farmers are often ahead of researchers in this respect (Richards, 1985; Starkey, 1987). If farmers are asked to devote more than a small proportion of their land or labour to testing a new idea, there may well be a need for some form of insurance/compensation should the innovation prove disastrous. Should no far-

mers be willing to evaluate an implement with such guarantees, then it is probably more realistic to doubt the relevance of the innovation, rather than to cite farmer conservatism.

Should it be thought that the importance of farmer involvement is being belaboured, a review of animal traction equipment research programmes in almost any country would demonstrate what a vast amount of time has been wasted in recent years because of failure to involve farmers. The persistent recurrence of researchers developing equipment that is too heavy, too expensive, too complicated, too delicate, and/or too difficult to manoeuvre adds up to a frighteningly high waste of human and financial resources. To cite but one example during the past decade: a large team of ICRISAT scientists tried to develop a major "improved" system of farming based on new designs of animal-drawn equipment. The technology was developed, tested and "perfected" for several years on the research station before it was presented to farmers. Subsequent farmer adoption of the package was most disappointing. The research team then realised that only at a late stage in their programme, *when the farmers themselves had been confronted with the technology*, had many of the real constraints in the farming system been identified (von Oppen *et al.*, 1985).

The conclusions of the West African Networkshop on "Animal Power in Farming Systems" (Starkey and Ndiame, 1988) seem apposite. Research and development relating to animal-drawn equipment should have a multi-disciplinary and farming systems approach. More emphasis should be placed on social and economic criteria than has been common in the past. To prevent technically excellent but inappropriate equipment being developed, from the very first year of a research programme there should be replicates of on-station trials on farmers' fields. Finally farmers should be closely involved in planning and evaluation at all stages of a research programme.

7. Implements commonly used for crop production

7.1 Ards

Ards (*araire* in French) are sometimes known as "breaking plows" or "scratch plows". Different types of ard have been in use for thousands of years and numerically they are the most important animal-drawn implements in the world. Their development over the centuries and the different designs currently in use in different regions of the world have been well reviewed by Haudricourt and Delamarre (1955) and Hopfen (1969).

An ard plow is symmetrical on either side of its line of draft. As the share and plow body pass through the ground, the soil is fractured and disturbed equally on either side. Unlike a mouldboard plow, soil is not systematically inverted. Typically the ard comprises a long wooden beam that connects with the yoke. The plow body is made of wood to which an

iron share is fitted. Many ards have a single wooden handle and the symmetry of design makes it easy to control the implement with one hand (Fig. 7-1, 7-2). Some ards, including those widely used in Egypt, have dual handles although one-hand control is common when soil conditions are favourable.

Some ard plows (including the Ethiopian *maresha* beam ard) till a narrow width at a shallow depth (hence the description scratch plow), leaving small and irregular ridges and furrows. Weed control and seedbed preparation are achieved through a series of cultivations (usually at least three) each at an angle to the others. By repeated cultivations most of the soil in a field becomes disturbed, with the later passes achieving a similar effect to that of a harrow. Weeds are not covered but are generally uprooted and remain with stones

Fig. 7-1: *Maresha* ard in use in Ethiopia

Photo: Paul Starkey

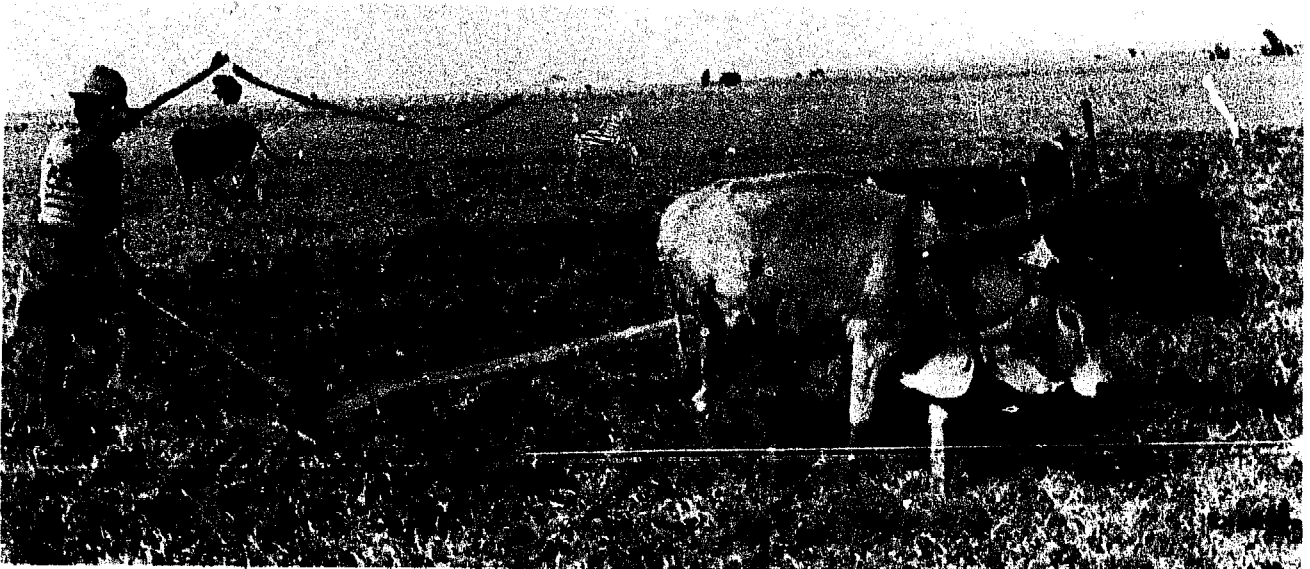




Photo: Paul Starkey

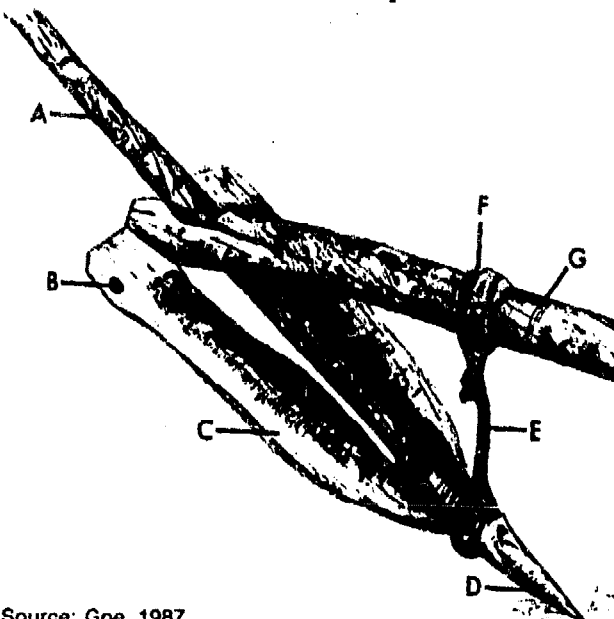
Fig. 7-2: Plowing with an ard in Egypt; in this case only one of the two handles is being used to control the plow.

and other trash at the surface, and in semi-arid areas this may result in quite effective weed control.

Other ard plows (including some body ards and sole ards in use in India and north Africa) have quite large wooden plow bodies (Fig. 7-5). These follow the steel share through the earth, breaking up relatively wide tracts of the

soil (hence the description breaking plows). Although such ards do not fully invert the soil, they can often be used to systematically plow fields in a single pass, leaving most of the soil cultivated and weeds uprooted, buried or disturbed. This allows an appropriate seedbed to be rapidly achieved through subsequent harrowing using, for example, a blade harrow or ride-on levelling board.

Fig. 7-3: Ethiopian maresha and its parts. A - Stilt; B - Sheath; C - Sole; D - Share; E - Sheath; F - Leather strap; G - Beam.



Source: Goe, 1987

It has been argued that the symmetrical design of ard plows makes them unsuitable for use with soil and water conservation techniques that require soil to be thrown to one side, such as contour bunding and bed formation. In order to overcome such limitations, conventional ards have been fitted with wings or mouldboards. One recent research initiative involving such modifications in Ethiopia has been described by Jutzi, Anderson and Abiye Astatke (1986, 1988).

The *maresha* ard (Figs. 7-1, 7-3) is the main animal-drawn cultivation implement currently in use in Ethiopia, with around three million employed. The *maresha* has recently been studied in detail by ILCA scientists (Gryseels *et al.*, 1984; Goe, 1987). Ethiopian farmers

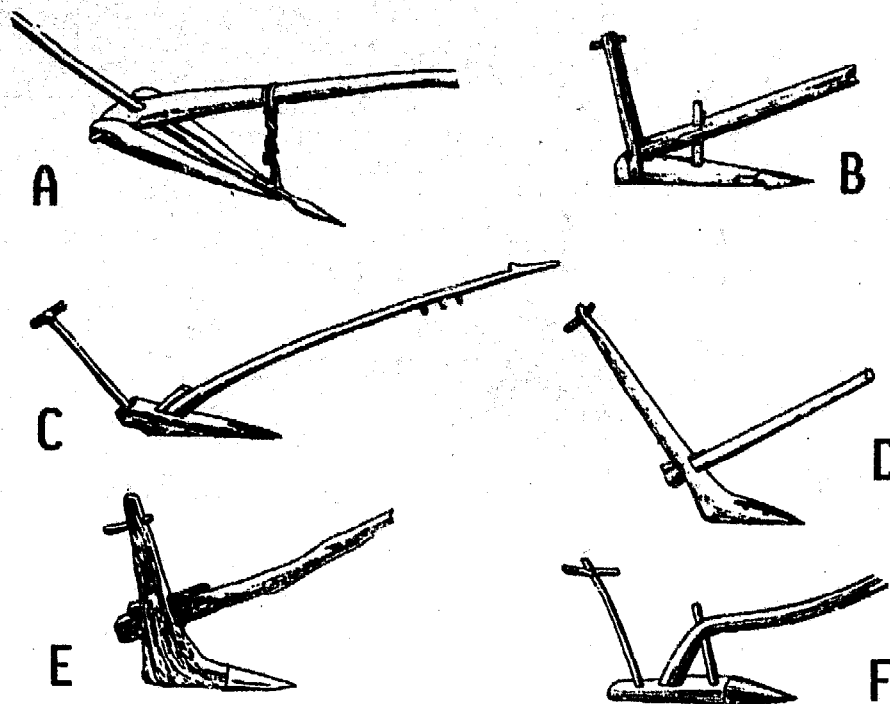


Fig. 7-4: Some ardra designs
 A - Ethiopian maresha;
 B - Egyptian balady plow;
 C - Nepal sole ardra;
 D - Indian body ardra;
 E - Afghanistan body ardra;
 F - Cyprus sole ardra.

Source: after Hopfen, 1969

have included higher cost, heavier weight, limited durability and difficulties in obtaining spares and repair services from village artisans (Goe, 1987).

Ards are still commonly used for cultivation in north Africa, even in countries such as Morocco and Tunisia where

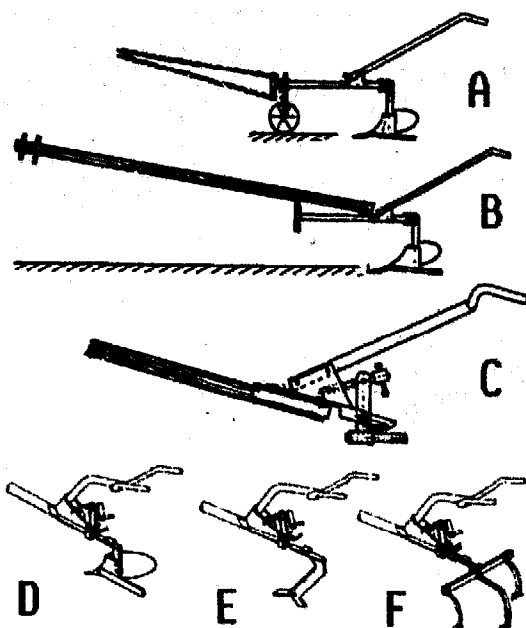
generally make their own implements from local timber and leather, but purchase their shares from local blacksmiths. For initial cultivations a share of 5 cm width is employed. Under typical farm conditions in the Ethiopian highlands a pair of indigenous oxen each weighing around 290 kg is used to plow at a depth of 9-15 cm with a draft force of about 1.0 kN. During the first four cultivations, a tillage rate of about 210 m² per hour can be achieved, representing 48 hours per hectare for each cultivation (Goe, 1987). Experimental trials have suggested that overall cultivation times could be reduced by 50% through the use of mouldboard plows (Abiye Astatke and Matthews, 1982, 1983, 1984). Nevertheless most attempts to introduce mouldboard plows at the smallholder level in Ethiopia have failed. Reasons for farmer rejection

animal-drawn steel mouldboard plows are widely available. In Morocco, ards can last for very many years, and can be passed down from one generation to another (Elbatnane, 1983).



Fig. 7-5: An ardra in central India. There are 30 million ards of many different designs in use in India.

Photo: Paul Starkey



Source: after Nolle, 1986

Fig. 7-6: Evolution of the Kanol

A Houe Sine toolbar (A) was combined with the long pole of an ard (B) to form a prototype long-pole toolbar (C). A double handle was fitted and it was developed to take plow bodies (D), subsoiling sweeps (E), weeding tines (F) and other attachments. Although the Kanol has been widely evaluated it has not been widely adopted.

In recent years the government of Egypt has been advocating (and subsidizing) the promotion of motor-powered farm equipment, yet local artisans continue to make traditional ards to meet the significant demand from small farmers, the majority of whom use animal-drawn ards.

It is evident that, despite its antiquity, the ard should not be written off as a topic only for archaeologists and historians. The use of ard plows on a large scale has persisted in Asia, Africa and Latin America despite the promotion and spread of mouldboard plows. Ards are clearly well adapted to many present day farming systems. Their continued importance is well illustrated by the present situation in India. Western style mouldboard plows of good quality have been manufactured in India for several decades and are widely available at reasonable prices. Nevertheless their uptake has been quite slow. Between the years 1951

and 1972 the number of mouldboard plows increased from one to five million (Shanmugham, 1982). While this may appear to be a very significant expansion, it has to be seen in the context of an increase in traditional ards (from 32 to 39 million) and a major uptake of seed-drills and sowing devices (from less than one million to four million in this period).

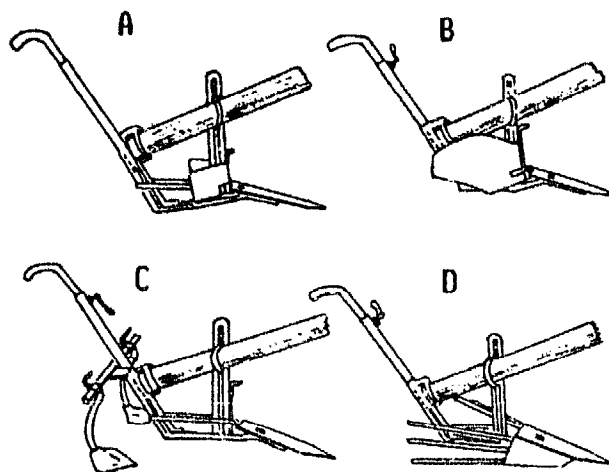
Many aspects of ard design have evolved over centuries and have been proven by use by millions of farmers. Among the design features commonly found are:

- the use of a single, symmetrical share set at a fixed angle to the ground;
- use of a long beam (as opposed to a flexible chain) between the body of the implement and the yoke;
- provision of a single handle for control;
- use of materials and construction techniques that allow fabrication by village artisans.

It is clear from the great success of the ard, that when combined, these (and other) characteristics can result in very practical implements. However it is less clear which features are particularly critical, which might be changed, and which could be incorporated into other types of animal traction implement.

Fig. 7-7: Prototype toolbar based on traditional Peruvian ard.

A - Standard ard body; B - Earthing up body; C - Weeder; D - Potato lifter.



Source: after Herrandina, 1987

Source: ILCA, 1983

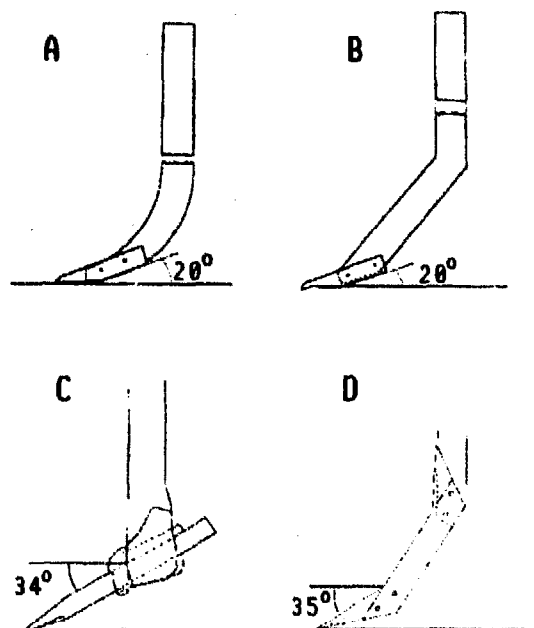


Fig. 7-8: A modified maresha ard.
It was developed in Ethiopia by the International Livestock Centre for Africa (ILCA) to allow use by a single animal. The beam was shortened and a skid and swingle tree were fitted. On-station trials were encouraging, but farmer uptake has been low.

Some recent and on-going research may eventually help to clarify these points.

Research being undertaken by CEEMAT involves the use of single symmetrical, angled tines for tillage in semi-arid conditions (Fig. 7-8). These have not been mounted on wooden beams (as is the case with ards), but onto steel beams or toolbars, as commonly used in sub-Saharan Africa. It is too early to know whether these tines will prove to be successful for primary cultivation, but the initial research reports of field trials seemed encouraging (Le Thiec and Bordet, 1989).

Fig. 7-9: Prototype single tines for primary cultivation tested by CEEMAT. Design D, ("RR"- réversible à ressort) made in abrasion-resistant manganese-silica steel performed best in trials.



Source: after Le Thiec and Bordet, 1989

In Peru, research is being carried out on combining many of the design features of traditional ards with the concept of multipurpose toolbars that can accept different steel attachments to assist ridging, weeding, potato lifting and inversion plowing (Fig. 7-7). While most of the principles of use remain the same, the complexity of manufacture, assembly and adjustment of the ard have been increased significantly. This ard has recently started to be marketed in Peru (Herrandina, 1987), and is being field tested in Niger (Projet Productivité de Niamey) but it has yet to pass the test of widespread adoption.

In 1974 the agricultural engineer Jean Nolle developed a multipurpose long-beamed toolbar in Nicaragua by combining the principles of the local ard with the successful "Houe Sine" toolbar (Fig. 7-6). This implement was subsequently developed and marketed as the "Kanol" (Nolle, 1986). As it developed it lost all links with the ard except for the continued use of the long beam. It is a relatively sophisticated steel implement, guided by two (not one) steel handles, and a wide range of steel tools can be attached to it. In comparison to an ard it is (like other steel toolbars) complicated, expensive and difficult to manufacture. Although the Kanol has been tested in numerous countries, it has never achieved the same popular success as the traditional ard or the Houe Sine.

In Ethiopia, the International Livestock Centre for Africa (ILCA) modified the local *maresha* ard for use with a single animal (ILCA, 1983b). This involved replacing the traditional long beam with a shorter beam and skid, that connected to a swingle tree and traces. To date farmer acceptance has been negligible. Since the various changes (ard, single animal, different yoke design and use of traces) have all been brought together in one package (and so statistically confounded), it is difficult, at this stage, to judge whether it was the change in the beam length of the *maresha*, or some other factor(s), that were critical.

While the ard has been introduced by many migrants and settlers in historical times, leading to a worldwide diffusion, there seems little evidence of ards being introduced successfully in recent years. For at least fifty years, visits to Asia by officers responsible for animal traction programmes in sub-Saharan Africa have led to specific recommendations to evaluate traditional Asian wooden equipment in Africa. Only some of these suggestions were acted on, and to a very limited extent, but none led to significant adoption. The apparent lack of success of such initiatives may have been related either to perceived technical disadvantages relative to steel mouldboard plows, or to the difficulties experienced in training local artisans to fabricate wooden ards. At a national or project level the ordering of factory-manufactured steel implements may well have been administratively convenient and perhaps commercially expedient. However such influences should not have prevented smaller non-governmental organizations from developing the use of ard plows in Africa. While advocates for the use of ards argue that the absence of the ard south of the Sahara is simply due to lack of promotion, other people consider that lack of diffusion and farmer adoption is because the ards that have been tried have been rejected.

Thus while it is evident that ard plows can be highly effective in farming systems where they

Fig. 7-10: Chinese single-handled, wooden "swing" plow with symmetrical cast-iron share.

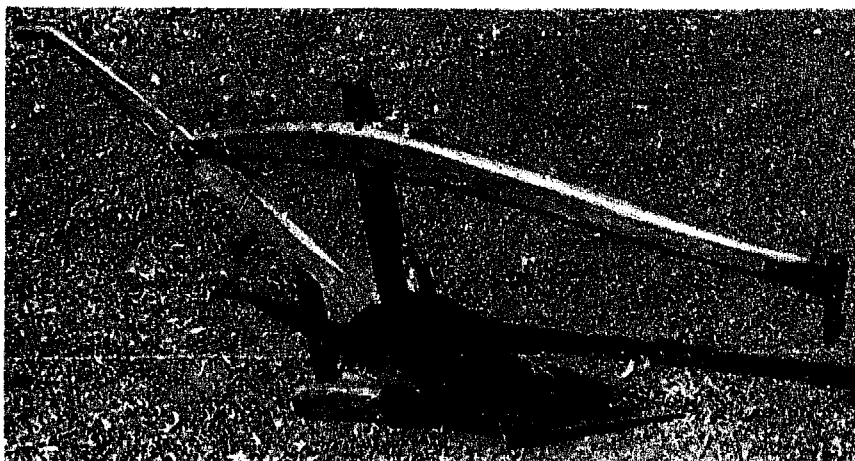


Photo: Paul Starkey

have been traditionally used, including North Africa and Ethiopia, it is not at all clear whether ards could prove to have an increasing role elsewhere in Africa. In conclusion:

- Ards should certainly not be dismissed merely because of their simplicity and their antiquity.
- Design features that have contributed to the widespread success of ards might well be incorporated into designs of other animal traction implements.

7.2 Mouldboard plows

Mouldboard plows are asymmetrical around their line of draft. They lift and turn the soil to one side, inverting it. The degree of inversion depends on the cohesion of the soil and the shape of the mouldboard. As it moves soil to one side, the mouldboard plow clears a distinct furrow. By continually turning soil into each previous furrow a farmer can systematically cultivate a field in one operation, covering both weeds and surface trash.

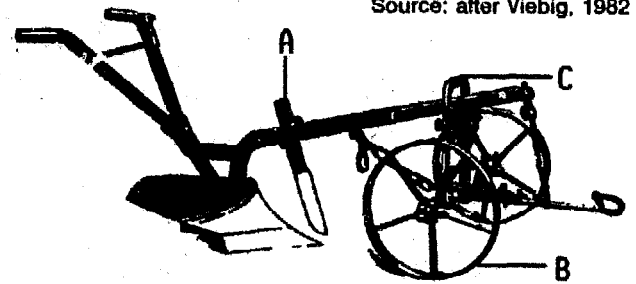
Historically mouldboard plows were developed mainly for swamp-rice production in humid climates and for rainfed crops in temperate climates. In these circumstances they provide quite rapid tillage that is combined with effective weed control and the incorporation of organic matter. Advantages of inversion in temperate climates are said to include improved aeration and drainage and the exposure of soil to the weather elements to accelerate the breakdown of soil into a fine tilth.

In the tropics, and in particular in semi-arid areas, such soil inversion may not be desirable as it may increase the rates at which soil moisture is lost and humus is decomposed; in the tropics a fine tilth may be dangerously susceptible to both wind erosion and heavy rainstorms.

Single handled, mouldboard plows without any wheels have been used widely for more than two millennia in China, Japan and south-east Asia, mainly for rice production. Some modern plows from these countries are similar to very old designs, comprising a simple wooden or steel frame with one handle onto which fit symmetrical, cast-iron shares and mouldboards (Fig. 7-10).

In Europe mouldboard plows have been used for about two thousand years. Early designs were made mainly of wood and had flat wooden mouldboards with a two-wheeled forecarriage to support the plow beam. Over many centuries wood persisted as the main construction material, although iron components became increasingly used. It was only about a hundred years ago that steel of a suitable quality became available at an appropriate price to allow it to replace wood as the major component of the western plow. Steel mouldboard plows became standard tillage equipment in Europe, North America and temperate climates around the world. During the present century they have often become increasingly important in countries using traditional ard plows. Various designs of mouldboard plow have been introduced into the countries of sub-Saharan Africa, and often they have become the main implement for animal-drawn cultivation.

A wide range of mouldboard plow types has been evaluated in Africa this century, and from the numerous designs selected in different countries, a clear pattern has emerged. Most plow bodies comprise a shaped central element, or *frog*, to which are attached a *share* which cuts soil, a *mouldboard* which turns the soil and a trailing *landside* which provides stability against yawing and pitching. The end of the landside is known as the *heel*. The heel assists in controlling the depth and the pitching of the plow

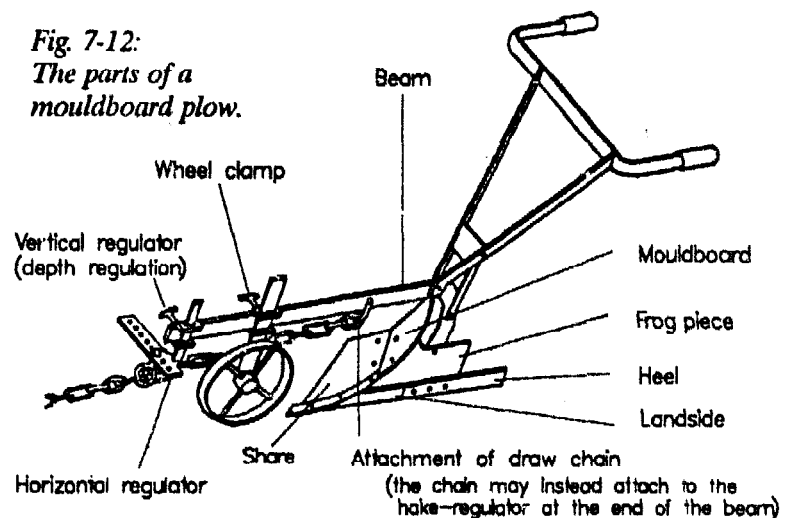


Source: after Viebig, 1982

Fig. 7-11: Mouldboard plow of design used in Europe, but seldom seen in Africa. A - Knife coulter; B - Furrow wheel; C - Forecarriage.

and since it can be subject to rapid wear, it may be detachable to allow it to be replaced independently of the landside. The use of countersunk bolts has become standard to reduce wear and friction; these have square shanks to allow them to be tightened and slackened in the absence of a hexagonal head, and this means that spare parts such as shares must have square, countersunk holes of similar size. (Incidentally, this feature causes problems for village blacksmiths and small-scale workshops, since punching a square hole is much more difficult than drilling a round one). The central frog is bolted to the main beam, usually a strong, J-shaped piece of steel of rectangular or "I" cross-section. The beam is usually about one metre in length, which is short compared with the old European plows. The attachment point of the traction chain may be along the length of the beam or at a terminal *hake*; in either case there is provision at the end of the beam for lateral and vertical

Fig. 7-12: The parts of a mouldboard plow.



Source: after Dibbitts, 1987

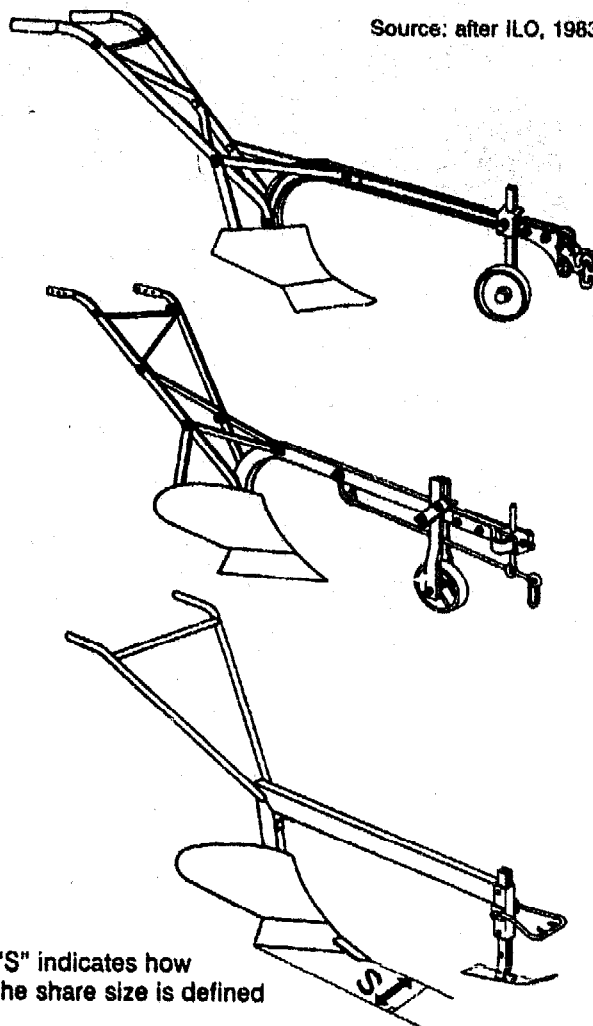
Fig. 7-13: Mouldboard plows from southern and eastern Africa.

Top: plow with chain attaching directly to hake manufactured on a large scale by UFI, Tanzania.

Middle: plow with draft rod manufactured on a medium scale by Northland, Zambia.

Bottom: Prototype plow with skid from Kenya.

Source: after ILO, 1983g



"S" indicates how the share size is defined

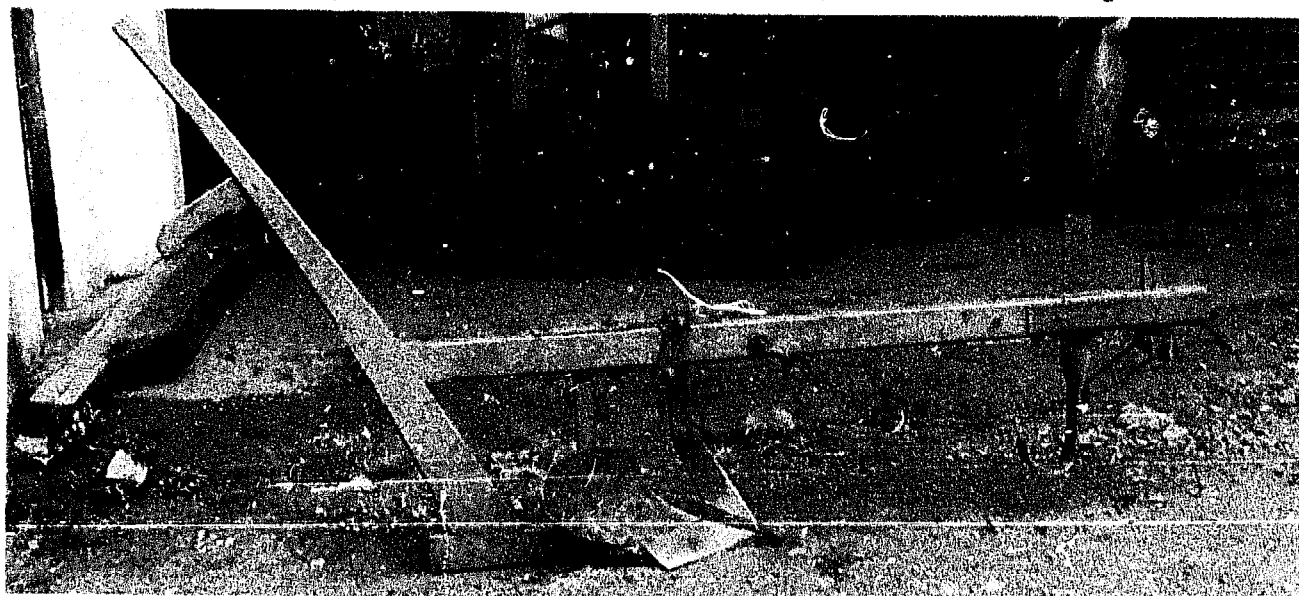
Photo: Paul Starkey

adjustment of the chain position. An adjustable *depth wheel* is attached towards the front of the beam, and this is used to restrict the depth of plowing and reduce pitching. Most steel plows in use in Africa have double handles. (Fig. 7-13).

These standard implements have arisen from the evaluation of a large range of possible plow designs. Such plows have evolved as an acceptable compromise between the requirements of low cost, simplicity, low weight and convenience, with those of technical excellence during work. Several features that have been valued in Europe, such as coulters, furrow wheels and reversible bodies have not been widely adopted. In most cases the rejected refinements had increased cost, complexity and draft requirements more than they increased efficiency.

Coulters were widely used on European plows and were considered particularly useful for plowing grassy land. In Africa they have seldom been used outside research stations. Knife coulters or disc coulters attach to a plow beam in front of the plow body and as-

Fig. 7-14 (below): Prototype plow developed by an NGO project in Zaïre, and subsequently made by village artisans. The plow has a wooden beam, coulters and skid. Coulters are seldom used in Africa, but this one was being evaluated for plowing farmland infested with rhizomatous grasses.



sist in obtaining a clean cut through vegetation and the soil. They also help in maintaining stability and straight furrows but they increase the draft of the implement and add to the price, weight and the number of adjustments. Disc coulters impose less draft than knife coulters, but are more expensive and in hard soils they tend to ride up, reducing penetration.

Although introduced and tested on many occasions, the carriage type of plow with a second and larger *furrow wheel* (Fig. 7-11) that was widely used in Europe has seldom been adopted in developing countries. A furrow wheel, as its name implies, runs in the furrow, increasing stability by reducing yawing and rolling. Adaptations of furrow wheel principles can be seen in intermediate toolframes, such as the *Ariana*, that have been adopted on a limited scale in certain countries. The second wheel makes it easier to hold the plow upright during work and the great stability of such implements can be convincingly illustrated during "hands off" plowing demonstrations (Fig. 7-15). Despite the advantages of the additional wheel, they have not been widely used in Africa, perhaps because farmers have found their increased cost, weight, draft and complexity too great to justify.

In contrast another plow refinement, the land wheel, has been almost universally adopted for the cultivation of rainfed crops. Land

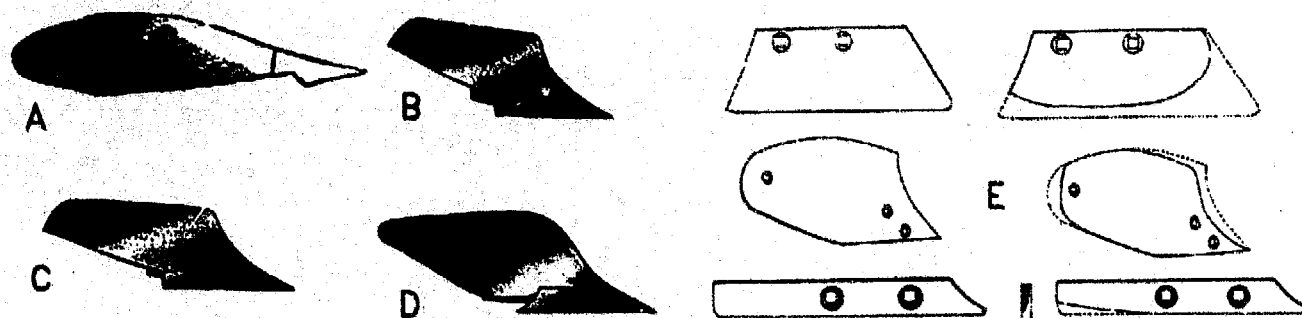
wheels are not essential and can be positively disadvantageous for swamp cultivation. Traditional Chinese and Japanese plows have not used land wheels. However a *swing plow*, one without a wheel, requires much more effort to control the working depth and the pitching tendency of the implement, particularly when the animals surge forward or slow down. A simple skid (Figs. 7-13, 7-14) made of wood or metal has the same effect as a wheel in providing stability and preventing the plow from digging too deeply. In very muddy conditions, or where there is much surface vegetation, a skid has less tendency to clog than does a wheel. Skids are easier and cheaper to make than wheels and require much less maintenance. An indication of the problems of wheel maintenance can be gathered by the number of times one sees (or hears!) wobbling depth wheels that have had their bearings, axles and even wheel centres worn away to almost nothing. Nevertheless a skid usually imposes more resistance than a wheel and is less convenient for the farmer during transport to the field and in turning at the ends of rows; consequently skids are not widely used.

The length and shape of the mouldboard has a great influence on the quality of work. Under one, largely outdated, system of plow classification in Europe a *general purpose* or *common* plow body was one with a long, gently curving mouldboard that kept cohesive soil intact in long continuous seams that were often inverted through 135° to lie at an angle of about 45° to the horizontal. Such plow bodies are seldom found in developing countries al-



Fig. 7-15: *Ariana* toolframe fitted with two wheels and a mouldboard plow being used in a "hands-off" plowing demonstration in Lesotho. (The designer of the *Ariana*, Jean Nolle, is walking beside the plow).

Photo: Peter Munzinger



Sources: after: LCC, 1984; Viebig, 1982; AETC, 1986

Fig. 7-16: Mouldboard plow bodies and wearing parts.

- A. European style "common" or "general purpose" body, rarely seen in Africa.
 B. "Continental" body. C. "General purpose" body. D. "Semi-digger" body.
 E. Slip share, mouldboard and landside showing typical patterns of wear.

though some training manuals appear to have been based on the assumption that such implements were in common use. A *digger* body has a shorter mouldboard that causes the soil seam to break as it turns, and most plow types in use in Africa are of this *digger* or *semi-digger* type (Fig. 7-13). Semi-digger plows can have *cylindrical* or *semi-helicoidal* shaped mouldboards (Fig. 7-16), and these different shapes can make a major difference to the quality of land preparation. The choice of a suitable design depends not only on soil type but also on the time between plowing and sowing. For rapid cultivation in relatively light and sandy soils the action of a short, cylindrical mouldboard (which is particularly easy to manufacture) can assist the rapid breaking and loosening of soil for immediate light harrowing or direct planting. A semi-helicoidal shape produces a more gradual inversion which is suited to areas of high weed infestation in more humid climates, where complete burial of the weeds is important. Semi-helicoidal mouldboards are generally preferred for areas with cohesive soils and are often combined with the practice of thorough harrowing. If farmers have not had an opportunity to assess different plow bodies within their farming systems, providing them a chance to do so might well prove a valuable exercise.

The length and angle of a plowshare determines the width that the plow cuts. The quoted size does not actually refer to the

dimensions of the share itself, but to the width it will cut (Fig. 7-13). Despite the widespread use of metric units, share sizes are often still expressed in inches (*pouces*), even in francophone countries. Small shares require less draft power but as each plow furrow is small it takes longer to cultivate each hectare. With a 6" (150mm) plowshare, the plow (and farmer) has to travel about 66 km to cultivate each hectare. With a 10" (250mm) share the distance is 40 km. Most mouldboard plows in use in Africa have shares of 7-9" (180-230mm) although in Botswana some plows have large 15" (380mm) shares which require the strength of several animals. Plowshares are usually of the slip share type (Fig. 7-16) and, as wearing parts, they are designed to be regularly sharpened, reworked or replaced. In abrasive soils a share may last for only 2-4 hectares, while in other soils a share can last for several seasons. A worn plowshare cuts a smaller furrow and can eventually lead to the plow body itself becoming worn which is much more difficult to repair. Lightly worn plowshares can be reworked into an acceptable condition by village blacksmiths and new ones can often be made from the leaf springs of old vehicles.

In addition to plowshares, the heels and landsides are wearing parts that need regular attention and repair or replacement. Although neither is essential (some Chinese or Japanese plows lack them) both greatly im-



Photo: Paul Starkey

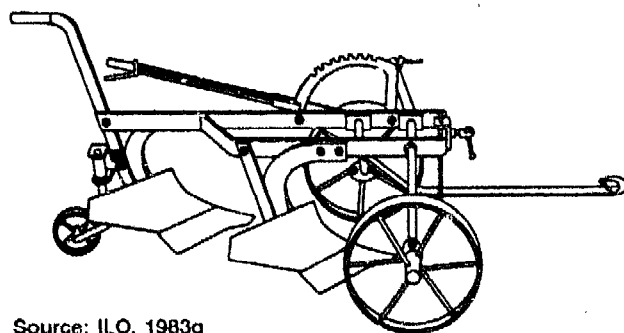
Fig. 7-17: Double furrow plow in Botswana. While this double plow (with a drawbar instead of a traction chain) is an experimental prototype, there are about 9000 double furrow plows with similar plow bodies in Botswana. They are pulled by teams of 8-16 animals.

prove the handling characteristics of plows. A long landside which trails along the bottom of the furrow wall helps to absorb the lateral (yawing) forces associated with the asymmetrical shape of mouldboard plows, making it easier to plow a straight furrow. The heel assists in depth control by lightly scraping the bottom of the furrow, so reducing any tendency of the plow to pitch. If heels and landsides are not maintained, the ease of handling gradually deteriorates, and eventually the frog-piece starts to wear. Land wheels often wear rapidly as abrasive soil particles enter the wheel bearing. Preventive maintenance, notably regular cleaning, may preserve the life of a wheel but there is controversy as to whether greasing the axle of a wheel is desirable. Greasing reduces friction, but if a seal is absent, or worn, abrasive particles combine with the grease to form a grinding paste, which can actually accelerate wear. In such

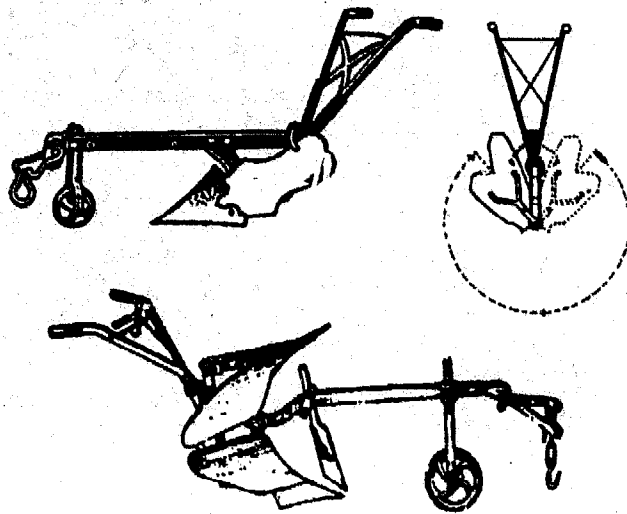
circumstances it may be better to keep unsealed bearings dry so that abrasive particles leave as easily as they enter. Although village blacksmiths can do remarkable repairs, it has frequently been observed that farmers find it particularly difficult to maintain wheels in good condition.

Double-furrow mouldboard plows may be used where draft animals are readily available but where time and human labour are in short supply. Inevitably the second plow body increases the draft requirement substantially compared with a single plow and this normally necessitates large teams of animals pulling the one implement. Large teams are less manoeuvrable than small teams and so more time is lost in turning. The main advantage of large teams is that a small number of people can control many animals. Double and even triple plows were widely used in North America in the first half of this century, and they were often used by one or two workers controlling teams of 4-12 large horses. Where labour is available, plowing may be achieved more quickly and more simply by harnessing the extra animals to a second single mouldboard plow. Investment in two single plows allows a farmer greater overall flexibility in resource management than does the purchase of a double mouldboard plow. Double plows are sometimes used in Botswana with teams

Fig. 7-18: Prototype double furrow plow built by CAMERTEC in Tanzania. In some parts of Tanzania farmers use teams of oxen, but few double-furrow plows are in use.



Source: ILO, 1983g



Sources: after: Hopfen, 1969; CEEMAT, 1971

Fig. 7-19: Reversible plows.

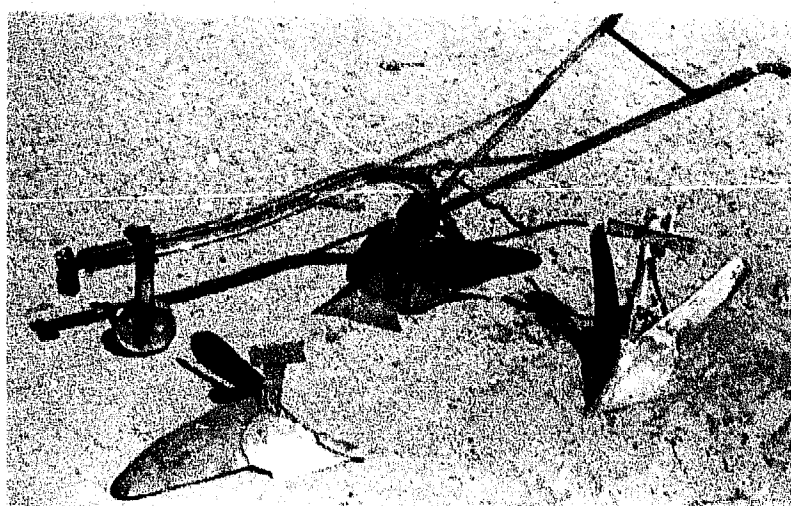
Top: Inexpensive reversible design that is quite widely used in India, showing the method of rotating the mouldboard to the other side at the end of a row. Bottom: A more expensive design of plow with two bodies that are alternately swung into place. Designs such as this have been tested in several African countries, but have generally been found too heavy and expensive for use in the local farming systems.

of eight or more animals, but they are seldom seen elsewhere in Africa.

Reversible plows, sometimes known as *one-way* or *turn-wrest* (wrest = mouldboard) turn soil to the left or right depending on the setting. The standard mouldboard plow always turns the soil to the right, so that plowing is usually done by progressively moving around fields or parts of fields, with furrows facing opposite directions on either side of the plowed areas. This inevitably leads to some unfilled furrows or ridges wherever the two directions of plowing meet, although such effects can be minimized by technical

Fig. 7-20:
 "Em'ot" ridging plow in The Gambia. Beside it are ridging bodies designed to fit the Unibar/Pecotool (left) and the Houe Sine (right) multipurpose toolbars. The Houe Sine ridging body with high wings is designed for earthing up, rather than primary ridging.

Photo: AFRC-Engineering archives



skill. With a reversible plow a farmer can steadily move across a field, creating the seams and furrows in just one direction. This may be particularly useful for contour plowing in hilly areas or for maintaining the uniformity of level in irrigated or terraced land. In most circumstances, farmers feel the advantages do not sufficiently compensate for the additional weight and complexity. In the simpler forms of reversible plow the share is symmetrical (like that of an ard) and only the mouldboard is moved. In more expensive and heavier models a second plow body can be brought into use on alternate rows (Fig. 7-19, bottom). Significant numbers of simple reversible plows have been adopted in India (Fig. 7-19, top). In Angola about 45% of the estimated 150,000 plows in use are reported to be of a simple reversible design. Elsewhere in Africa, reversible plows are seldom seen outside research stations, although the use of heavy reversible plows pulled by teams of four to eight animals has been reported from certain rice cultivating areas of Madagascar (FAO/CEEMAT, 1972).

7.3 Ridging plows

Ridging plows are symmetrical around their line of draft and the two mouldboards turn soil to both sides (Fig. 7-22). In each pass through the soil a ridger makes one furrow and two small ridges. In normal use the furrows are so spaced that two small ridges are

Source: Bulawayo Steel, 1983

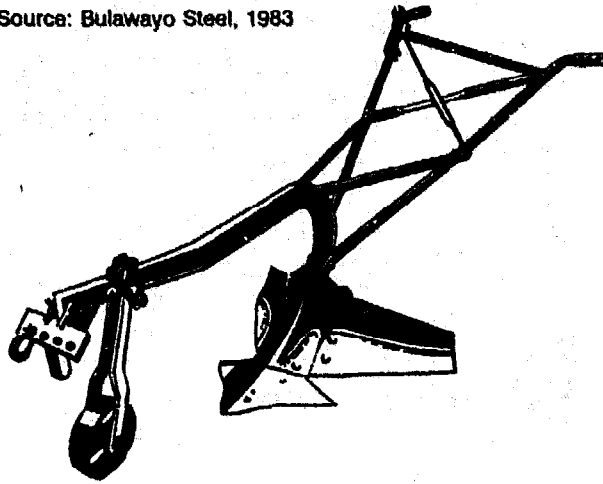


Fig. 7-21: "Inkanki" high wing ridger, manufactured in Zimbabwe.

combined to make one larger one. Thus on every pass the ridger completes one ridge and forms one half of the next one. Because of their wide working width ridgers have a high draft. In light soils or with heavy animals it is possible to form ridges on seasonally fallow land, but in other conditions soil may have to be broken with tines or a mouldboard plow to make it light enough to ridge. Ridgers may have mouldboards (wings) that adjust in elevation or in the angle between the wings. This permits ridges to be made of different shapes and heights.

Ridging can be quite a fast system of soil cultivation. This is due both to the wide working width, and the fact that not all the land is tilled. The land under the ridges is not disturbed, and if ridges are spaced at 90 cm the ridger only travels 11 km per hectare (in comparison to 43 km/ha for a 9"/23 cm mouldboard plow). Permanent ridges may

lead to the development of hard layers of soil difficult for roots to penetrate. This leads to the practice of ridge splitting which, if carried out in dry conditions, imposes a very heavy work load on animals (Stokes, 1963).

Ridging as a method of cultivation developed in many African countries before animal traction was introduced. Cropping on ridges is common in several areas including the savannah regions of Nigeria, in the west of The Gambia and in parts of Malawi and Zimbabwe. In certain climatic zones ridging may be valuable as a means of soil and water conservation, and some of the benefits may be attributable to the labour-intensive operation of ridge-tying (discussed in section 9.5). Planting using animal power is more difficult on the ridge than on the flat, and while animal-drawn ridge seeders have been developed in several countries, they have usually been less effective than seeders designed for level ground. Hand weeding with hoes along ridges is more time-consuming than within-row weeding on the flat, but inter-row weeding and re-ridging with a ridger can be effective and ridges are more easily followed than rows. In certain areas, notably northern Nigeria, the ridger is often the only animal traction implement, being used for primary cultivation, weeding and earthing up.



Fig. 7-22: Ridging in Nigeria.

Photo: Enoch Gwani

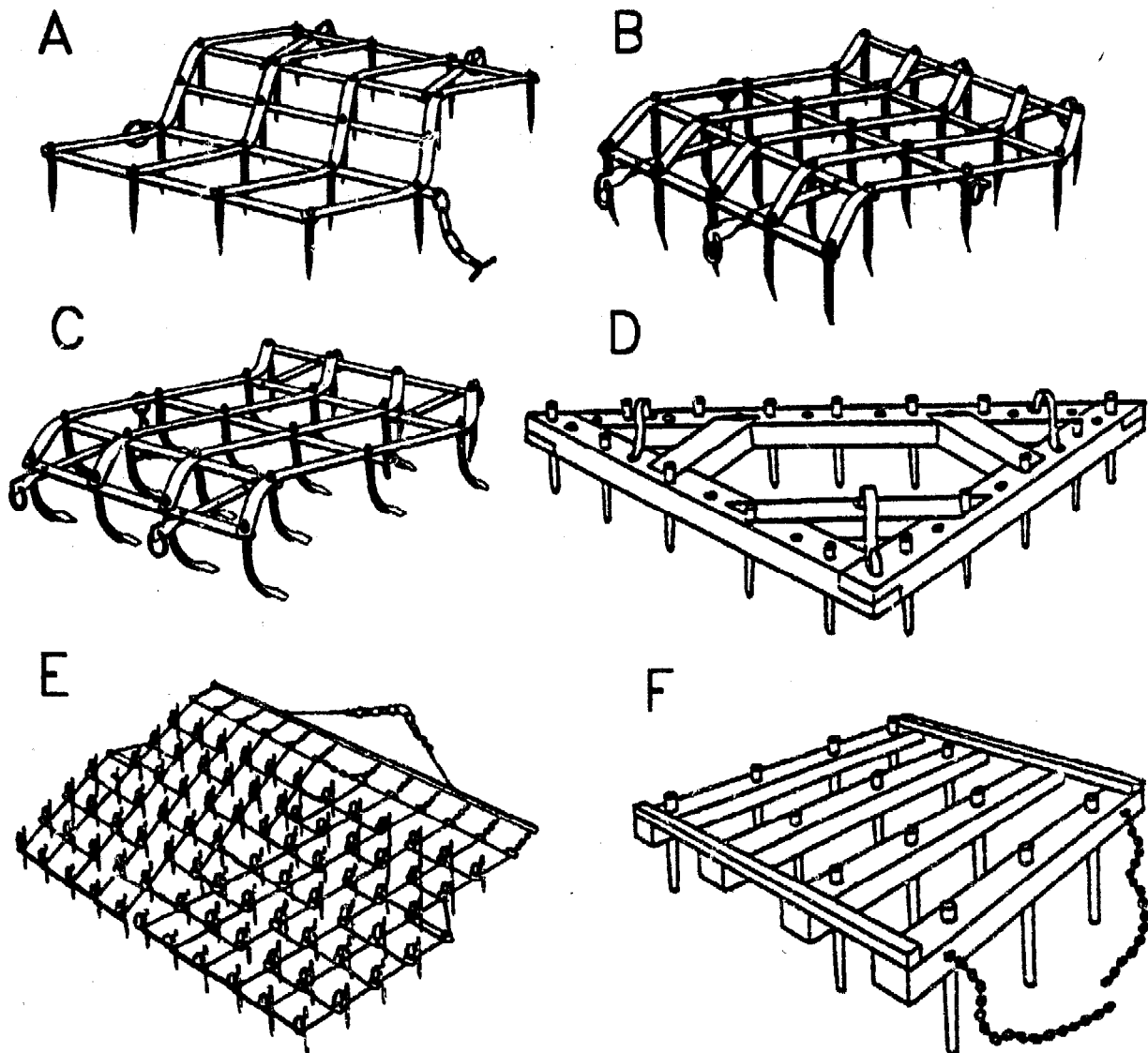
Ridging plows are seldom used for primary cultivation in francophone West Africa but "earthing-up" ridging implements may be used for weeding crops such as cotton and maize. Such earthing-up ridgers (*butteuses*) are designed primarily as secondary cultivation implements, and are often attached to a multipurpose toolbar. The shape, strength and wearing characteristics of such earthing-up ridging bodies have been designed for inter-row weeding and earthing-up, and so such implements are unlikely to be found ideal if used as ridging plows for primary cultivation.

7.4 Harrows

Harrows are mainly used to crush clods and to level a seedbed after plowing. They are also used to control weeds and to cover seed or fertilizer that has been broadcast. In temperate climates they are used to aerate pastures.

Tine harrows are characterised by a wide working width and many small cultivating points, generally made of steel. *Disc* harrows usually comprise two gangs of steel discs which pulverise clods into a fine tilth. Because of their rolling design, animal-drawn disc har-

Fig. 7-23: *Tine harrows*
A and B. Steel zigzag harrows ("seed harrows"). C. Chisel-tine harrow.
D. Triangular wooden harrow with steel tines. E. Chain harrow (rarely used in Africa).
F. Wooden rectangular peg-tooth harrow with rigid construction.



Sources: Viebig, 1982; ITDG, undated.

Source: ITP, 1965

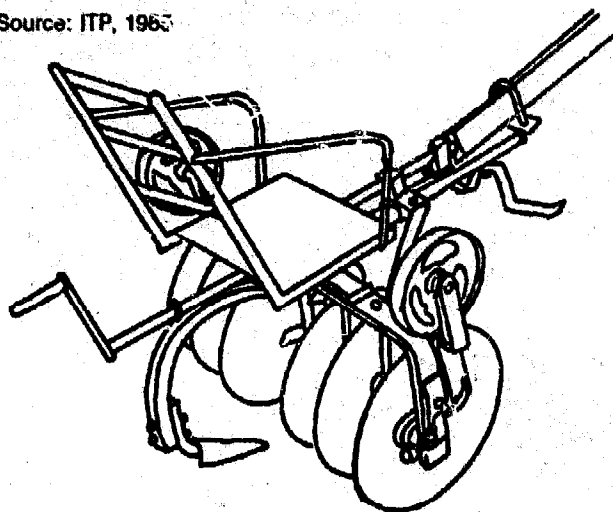
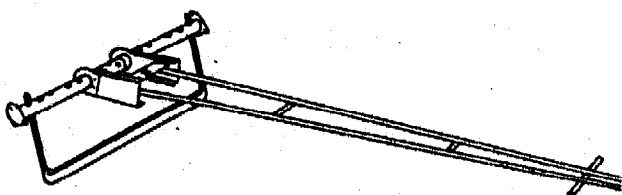


Fig. 7-24: Ride-on disc harrow
Such implements are commonly employed in India,
but seldom used in Africa.

rows are often ride-on implements, with the weight of the operator increasing the effectiveness of work (Fig. 7-24). Although animal-drawn disc harrows are quite widely used in India, they are rarely seen in Africa. They are expensive, heavy to transport to a field and their high working draft requires strong animals. Some rotary implements may be used for rice production (see section 7.9).

Tine harrows may have rigid or flexible frames and the cultivating points may be rigid *peg teeth* or *spring tines*. Rigid harrows often have a triangular or rectangular wooden frame and 15-30 steel tines (Fig. 7-23D, F). These can be easily manufactured by village artisans (MacPherson, 1975; Starkey, 1981). Wooden pegs can be used instead of steel tines, but these are less durable. Peg-tooth harrows are quite heavy and one reason for their limited adoption in Africa is the difficulty of transporting them to a field in the absence of carts. A sec-

Fig. 7-25: A prototype multipurpose tool developed in India that is designed to function in the same way as the traditional blade harrow.



Source: Basant, 1987

ond disadvantage can be the speed at which normal timber can rot or become infested with insects, so causing the tines to loosen or the wooden frame to break during work. The use of local varieties of very hard, resistant timber reduces this problem, but at the cost of greater manufacturing difficulty.

Steel zigzag or *diamond* harrows (Fig. 7-23A-C) are more widely used and last longer than wooden harrows. These are generally manufactured in small factories and are more expensive than wooden framed harrows. The draft of peg-tooth harrows depends on soil conditions, the weight of the harrow (and any logs added to increase penetration) and the number, angle and sharpness of the tines. Tines angled towards the direction of travel increase both penetration and draft. In general terms, a 15-20 tine peg-tooth harrow is likely to have a comparable draft requirement to that of a 9"/230mm mouldboard plow.

One disadvantage of a harrow with a large, rigid frame is that the implement is not capable of responding to minor undulations in the surface of a field. This problem can be reduced if two, or more, smaller harrows in parallel replace one large harrow, or through the use of a *flexible* or a *chain harrow*. Animal drawn chain harrows pulled by teams of large horses were widely used for pasture management in temperate climates. Such harrows usually have more than 60 points and the draft is excessive for normal tropical applications. With an assumed draft resistance of 10-60 N per tine, harrows designed to be pulled by pairs of oxen should not normally exceed 15-30 points (CEEMAT, 1968).

In India *blade harrows* are very widely used, particularly in semi-arid areas. The sharp metal blades about 400-600mm long are attached to a wooden frame, and are pulled through the soil about 50mm below the surface (Fig. 7-26). They loosen the soil and cut roots without disturbing the trash on the soil surface. By not turning or mixing the soil surface



Photo: Paul Starkoy

Fig. 7-26: Blade harrow being used in India.

they cause less moisture loss than a tine harrow. There appear few records of simple blade harrows being used in Africa. However wide sweeps fitted to toolbars and wheeled toolcarriers that may have been functionally comparable to blade harrows have been tested in several countries. These have seldom been found satisfactory, with problems of trash clogging the implements, very high draft, and disappointing weed control for the work involved (EFSaip, 1984).

Animal-drawn *rollers* were commonly used to crush soil clods in temperate agriculture, but they have not been adopted in the tropics; this seems largely attributable to their heavy weight, high draft requirement and cost.

Cultivators may be used to achieve the same effect as harrowing and these are discussed in section 7.6.

7.5 Seeders and planters

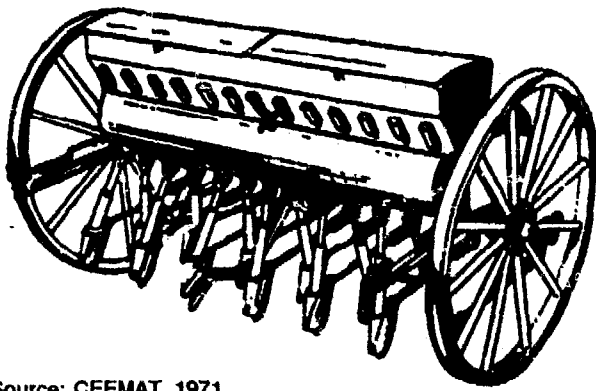
With the notable exception of Senegal and Mali in West Africa, animal-drawn seeders

have seldom had the same degree of success as have plows and cultivators. This is because seeding can often be done quickly and effectively by hand while mechanical sowing devices are usually expensive and often require ideal working conditions.

The objective of sowing is to place seeds at an appropriate depth in the soil with an optimal spacing between seeds. It has repeatedly been shown by comparative trials that accurate planting produces higher and more reliable average yields than random seed placement. The object of a seeder is to obtain such *accurate* and *reliable* seed placement *conveniently* and at an *acceptable cost*. In the past twenty years many organizations and projects in developing countries have invested time and money in trying to achieve these goals. Most initiatives have failed. In some cases the mechanism was simply not effective; in others the implements worked perfectly on research stations, but could not cope with the variable seed size and soil conditions of real farms; finally there were those that met all the technical requirements, but which were not cost-effective in the prevailing farming systems.

The main manual techniques for sowing are broadcasting, dibbling and drilling. Broadcasting involves the scattering of seeds over the soil surface followed by some mixing of the topsoil. Dibbling necessitates the making of a small hole into which are dropped one or more seeds. Drilling is the process of making a narrow furrow into which seeds are placed at regular intervals after which the furrow is covered with top soil and loosely compressed. The various manual processes may be either combined with, or replaced by, animal traction techniques.

Broadcasting has historically been the major method of seeding grasses and small cereals such as wheat, teff and rice. When broadcasting is combined with animal traction, soil is generally plowed several times to obtain a satisfactory seedbed, or plowed once and then

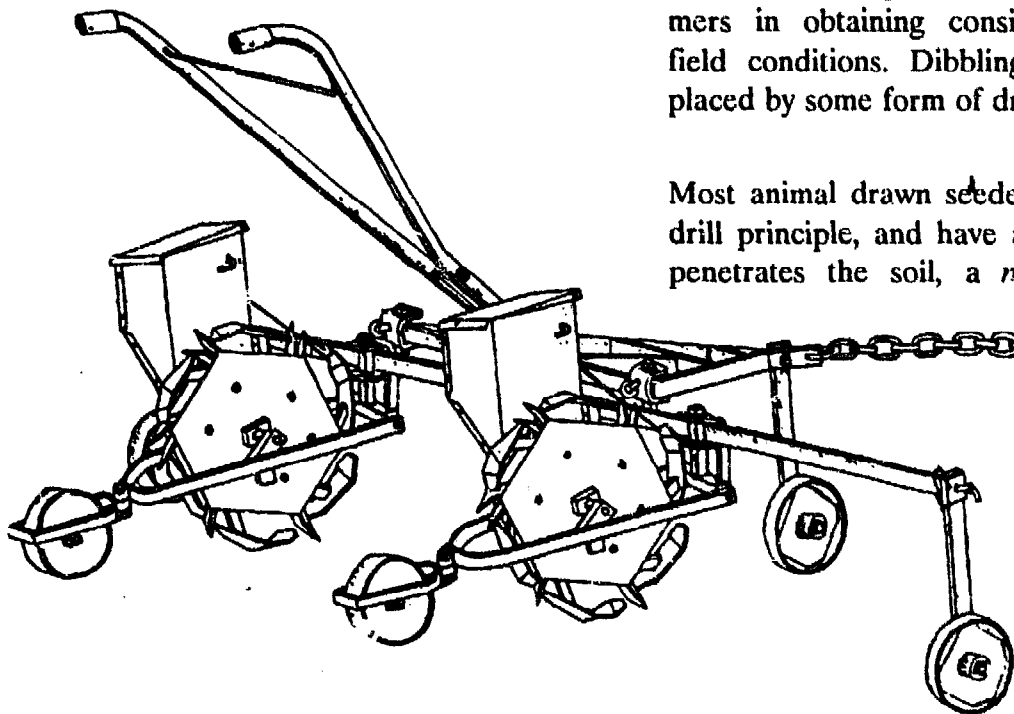


Source: CEEMAT, 1971

Fig. 7-27: Multi-row cereal seeder.

harrowed. The seed is scattered by hand and then a light *seed harrowing* (or seed plowing with an ard) ensures that seed is incorporated into the topsoil. Once seed is distributed in this way, further animal traction operations are virtually impossible without damaging the crop. Very light harrowing as a means of early weeding is technically possible but seldom practised in the tropics. The broadcasting of wheat and rice may be replaced by animal-drawn single-row seeders or multi-row seed drills. The narrow inter-row spacing favours multi-row seeders, and designs of these are commercially available (Fig. 7-27). Dibbling

has traditionally involved the use of a simple hoe or stick to make holes into which seeds are dropped, the holes are then covered with soil using a foot. Although the work is tedious, fast rates can be achieved. Further, while seeders are designed for uniform areas, farmers' fields are highly variable, and with dibbling a skilled farmer can adjust population density very accurately to the micro-relief or fertility patterns of a field. Hand dibbling can be on ridges or on the flat, can be in rows or evenly spaced and can involve single seeds or groups of seeds (hill planting). Dibbling is therefore a very flexible system of planting that is difficult to mechanize effectively. Rolling injection planters, such as those developed by IITA in Nigeria and widely evaluated elsewhere, are based on the dibbling principle. These seeders can be made as multi-row units to be pulled by animals, and prototype animal-drawn rolling injection planters have been built by appropriate technology organizations in several countries. Small numbers have been manufactured by the UPRONA factory in Togo (UPROMA, 1984 & 1986; Fig. 7-28). To date the uptake of these has been minimal and reasons for this may be associated with the high cost of these implements and the problems experienced by farmers in obtaining consistent results under field conditions. Dibbling can often be replaced by some form of drilling.



Source: UPRONA, 1986

Most animal drawn seeders are based on the drill principle, and have a *furrow opener* that penetrates the soil, a *metering* mechanism,

Fig. 7-28: Prototype animal-drawn rolling injection planter. Planters such as this, based on seeder units developed by IITA, have been evaluated in several countries, but have yet to be widely adopted.

Sources:
Gite and Patra, 1981
Silsoe, 1988
Hopfen, 1969

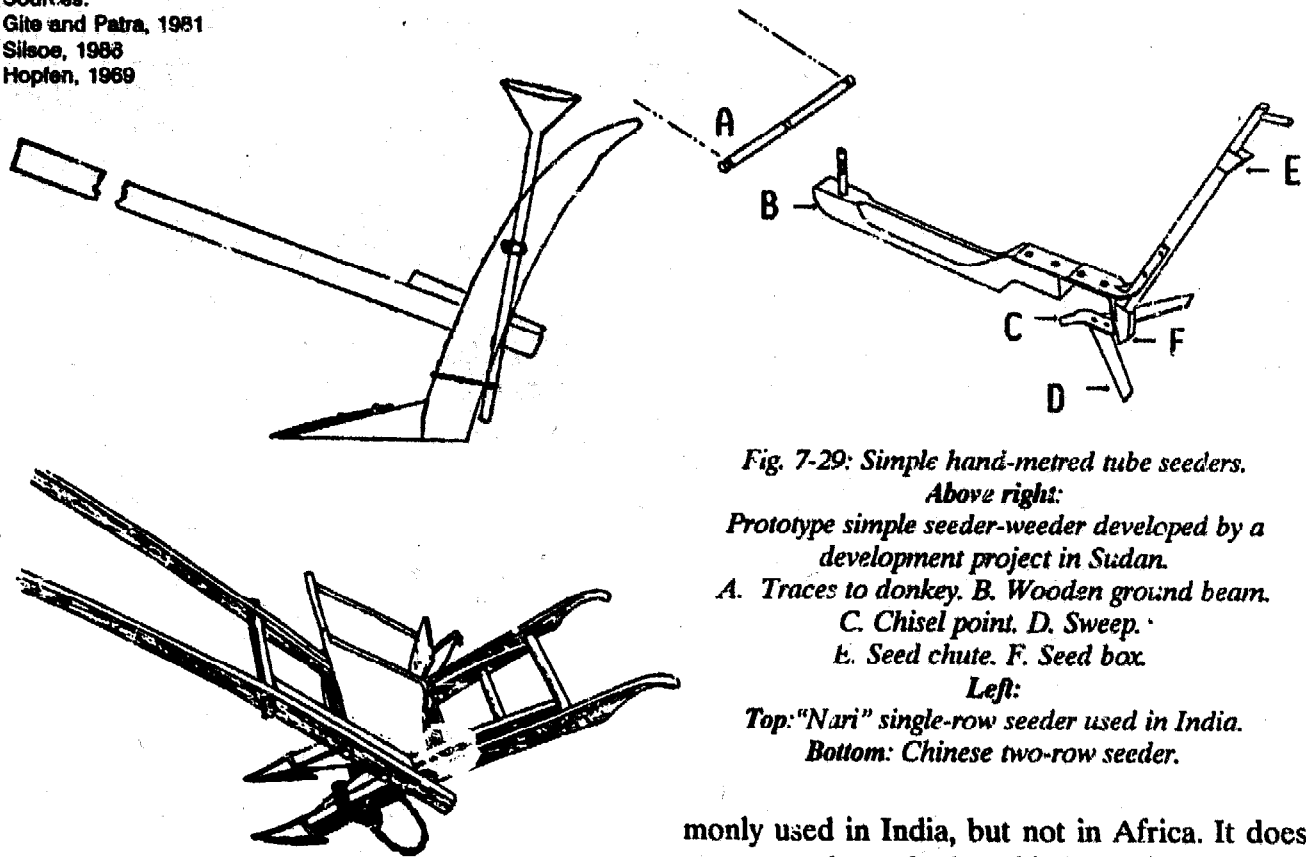


Fig. 7-29: Simple hand-metred tube seeders.

Above right:

Prototype simple seeder-weeder developed by a development project in Sudan.

A. Traces to donkey. B. Wooden ground beam.

C. Chisel point. D. Sweep.

E. Seed chute. F. Seed box.

Left:

Top: "Nari" single-row seeder used in India.

Bottom: Chinese two-row seeder.

that determines seed rate, and some form of seed tube that transports the seed to the furrow. There is generally some system for covering the seeds in the furrow and lightly compacting the soil.

The simplest systems do not require separate implements. Row seeding can be achieved using a plow (ard or mouldboard) as a furrow opener and hand-metering by dropping the seeds into the furrow. If furrow depth is not constant there will be seed wastage, but with no capital outlay, this may be acceptable. The problem of accurately aiming the dropped seeds can be overcome by the provision of a plastic seed tube that drops the seed behind the plow (Fig. 7-29). This elegantly simple design can be adapted into a two, three or four row planter. The seeds are hand-metered into a small wooden bowl and pass down plastic tubes to simple furrow openers. A second bowl and series of tubes can be used to make the implement into a combined seeder and fertilizer distributor. Such seeders are com-

monly used in India, but not in Africa. It does not seem clear whether this lack of uptake has been because of inherent problems with these implements or because they have been overlooked. Certainly the majority of research and development workers involved with the testing and adaptation of seeders in Africa have concentrated on precision seeders.

Precision seeders use the forward movement of a ground wheel to drive some mechanism that causes seeds to drop behind the furrow opener. Covering is ensured by a simple device such as a loop of chain dragging the surface or the action of two tines mounted in parallel behind the seed placement position. Compaction is often achieved by a small trailing roller. The simplest mechanisms involve a wooden roller driven directly by a ground wheel. As the implement moves forward, the roller rotates and seeds drop into holes or slots and are transferred to the seed tube. Seed rate may be determined by the size of an adjustable aperture at the bottom of the seed hopper and spacing depends on the shape of the roller. Different rollers are used for different crops. More complex seeders involve

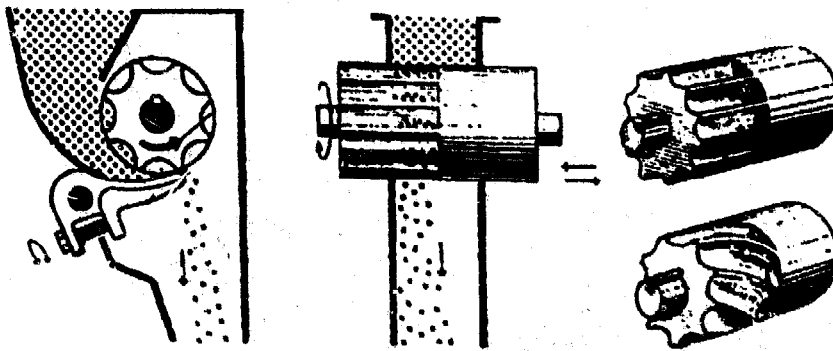


Fig. 7-30: Basic roller seeder mechanism, used in multi-row cereal seeders. Metering can be controlled by regulating the orifice (far left) and moving the roller in or out to determine how much of the fluted (seed-metering) portion is actually in operation (centre). The fluted rollers (right) can be straight or spiral.

Source: CEEMAT, 1971

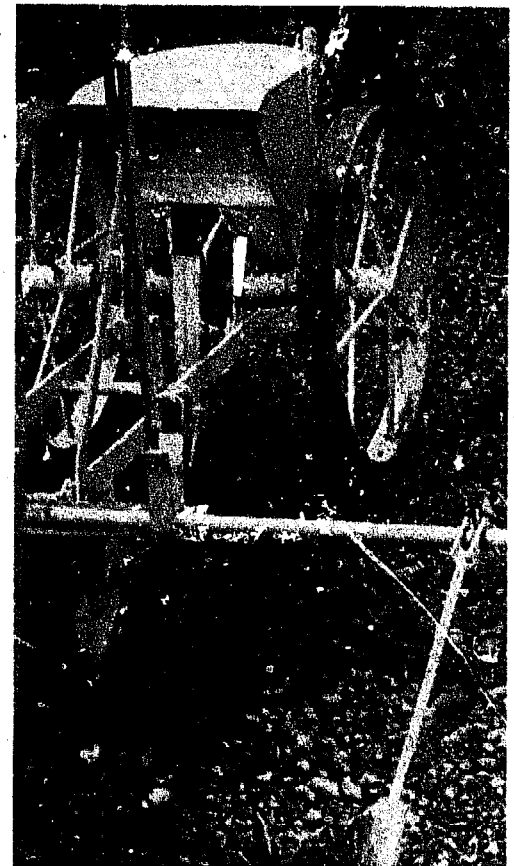
some form of cog or chain gearing mechanism that indirectly takes power from the axle of the ground wheel(s) and drives metering wheels or plates. The "Super Eco" type of seeder (probably the most successful in Africa to date) uses a sealed gear mechanism to drive seed wheels at an inclined plane. The number of holes in a wheel determines inter-plant spacing and seed wheels with different sizes and patterns of holes are available for maize, sorghum, millet, groundnuts, cowpeas and rice. A separate hopper and seeding mechanism are required for cotton seed that has not been delinted. A clear and well illus-

trated description of the use of *Super Eco* seeders may be found in a manual prepared for use in The Gambia by Matthews and Pullen (1976).

A simple but important aspect of seeder design is the "next-furrow" marker. This is a bar with an adjustable tine that draws a line on the ground parallel to the furrow being created. This mark is then followed to ensure the next and subsequent rows have constant inter-row spacing. This is particularly important to allow effective animal-drawn inter-row cultivation. Two (or more) separate seeder bodies

Fig. 7-31: Super Eco seeder. Below: Seeder with various distribution plates and next-row marker extended. Right: Seeder in action showing back of distribution plate and seeds falling into seed tube. The furrow opener, press wheel and row marker are just distinguishable. The ground wheels turn a sealed gear mechanism that drives the distribution plate.

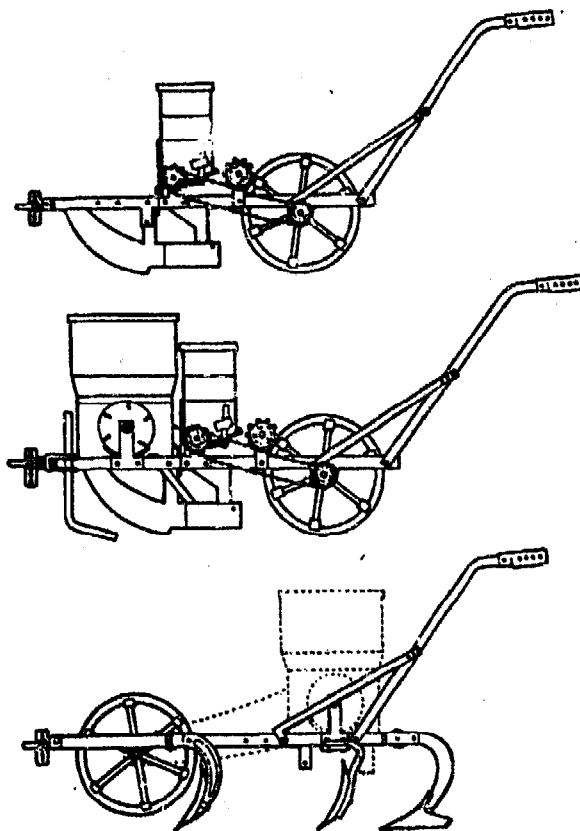
Photos: Paul Starkey





Photo, Paul Starkey

Fig. 7-33: Horses are commonly used to pull Super Eco seeders for planting groundnuts in Senegal.



Source: after ILO, 1983g

Fig. 7-32: A precision seeder developed experimentally in Botswana from a general design quite widely used in Southern Africa. The ground wheel turns a chain that drives the metering mechanism comprising an agitator over a fixed, gravity-fed metering plate. It was intended that the chassis could be used as a simple seeder (top), fertilizer-planter (middle) or cultivator (bottom).

may be used together, for example on an intermediate toolframe. However despite many attempts to encourage multi-row seeding using two or more precision seeder bodies, farmers in West Africa have shown a clear preference for single-row seeding (Bordet, 1987).

Well-adjusted seeders operating in good conditions can save working time. They can also save seed by sowing at the depth and spacing considered optimal for germination and survival. On the other hand poorly-designed or badly-adjusted seeders working uneven seedbeds can waste time, waste seed and result in irregular and low plant populations. Surface trash or sticky soil can clog seeders; metering wheels may slip, thereby changing seed spacing; planting depth will not be constant on uneven ground; metering mechanisms may physically damage seeds, thereby reducing the proportion that germinate; seeds of unusual shapes may become stuck in seed-holes and require removing (it is actually quite difficult to detect during seeding that seed-holes have become blocked, but it shows clearly at germination time!). Seeding on ridges generally has

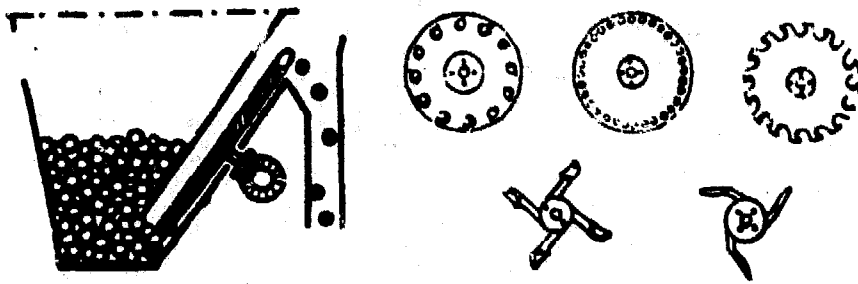


Fig. 7-34: Basic mechanism of the inclined-plate seeder, widely used in West Africa for groundnuts. The ground wheel drives the plate, which carries seed up to fall into the seed tube. Metering depends on the size and number of holes in the plates.

Source: CEEMAT, 1971

additional problems due to inevitable variations in their height and surface. Many an agricultural engineer can testify to the frustrations of trying to obtain optimal seed rates with seeders on the excellent seedbeds of research stations, while many a farmer can further amplify the problems of use under normal field conditions. In southern Mali, some farmers who own and use animal-drawn seeders still opt to hand-plant *some* of their fields and crops. They use long cords with knots in them to ensure straight rows and constant plant spacing. They argue that although cord-planting is slower, the resulting rows are more parallel, the plant population is more uniform, and the efficiency of weeding is improved.

Problems of cost, complexity and unreliability have restricted the spread of seeders in Africa. In most Sub-Saharan countries in Africa the number of animal-drawn seeders in use is below 5000. The main exception to this generalization is Senegal where there are about 145,000 *Super-Eco* seeders in use (Havard, 1985). In neighbouring Mali another 45,000 similar seeders are employed. The *Super Eco* was first introduced in Senegal in the 1930s, and has been locally manufactured since 1963. The diffusion of seeders in Senegal has been well reviewed by Havard (1986) and Bordet (1987). Several other seeder designs have been tested and sold, but none had the same combination of efficiency, durability, adaptability and availability. The single-row seeders were successful in the semi-arid areas where the number of days a year suitable for planting are few, and time is of the essence. In such conditions there may be no time for conven-

tional seedbed preparation and in very light soils, seeders such as the *Super Eco* can be used for direct planting. Thus in parts of Senegal and The Gambia some farmers have purchased seeders (to be pulled by a single donkey or a horse) even when they did not own plows or cultivators, and the seeder is second only to the multipurpose cultivator (*Houe Sine*) in terms of number of animal-drawn implements in service.

The *Super Eco* and similar seeders use a system of interchangeable discs to determine spacing (Fig. 7-34). This metering system is well adapted to the single planting of relatively large seeds that are more or less spherical in shape, such as groundnuts, maize, cowpeas, soya beans and delinted cotton. It is less suitable for smaller or less spherical seeds such as sorghum, millet, rice or raw cotton. Although there have been attempts to modify the *Super Eco* (and other seeders) for ridge cultivation in Senegambia, these have not led to adoption. Problems with seeding on ridges include the positioning of the operator and animal (a single animal pulling a ridge seeder would walk on the ridge) and the stability of the seeder on the ridges.

The success of the *Super Eco* can be usefully contrasted with the failure of some other seeders in Senegal. There have been several attempts to introduce dual-row and multi-row seeders. These were not adopted by farmers, mainly because the increases in cost and weight and decrease in manoeuvrability were not considered to be justified. While a single-row seeder could be pulled speedily by a single horse, the dual- and multi-row seeders

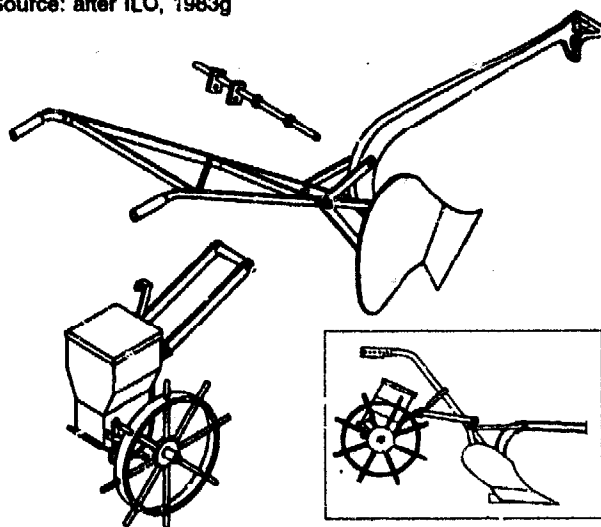
required extra draft, and were normally pulled by a pair of oxen, which walk more slowly than horses (Havard, 1986; Bordet, 1987).

Seeders seem most likely to be adopted in semi-arid areas where planting time is particularly critical. As already noted, one means of achieving very rapid seeding is to plant manually at the same time as plowing. Alternatively a precision planter can be attached to the plow (Fig. 7-35). The advantages of such rapid, direct seeding systems may be offset by heavy weeding requirements, but in very marginal areas the fact that a crop even reaches the weeding stage may be an achievement in itself. Plow planters have been developed in several southern African countries, including Botswana (EFSAIP, 1984; Horspool, 1987).

One of the main benefits of seeders is the ease of producing parallel rows and the resulting time-savings achieved with animal-drawn inter-row weeders. However as noted earlier, some farmers in southern Malawi have found planting using a long cord can be more efficient than planting with a seeder. In other situations where the disadvantages of seeders outweigh their advantages, simple parallel row

Fig. 7-35: A simple plow planter developed experimentally in Botswana. The unit attaches to the standard plow. The ground wheel drives the metering mechanism comprising a "wavy edge" disc agitator over a fixed, gravity-fed metering plate. Different seed plates can be fitted for various crop and seed size combinations.

Source: after ILO, 1983g



Source: JPROMA, 1986

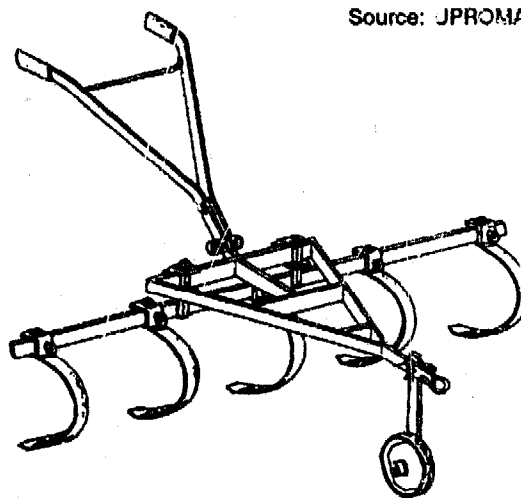
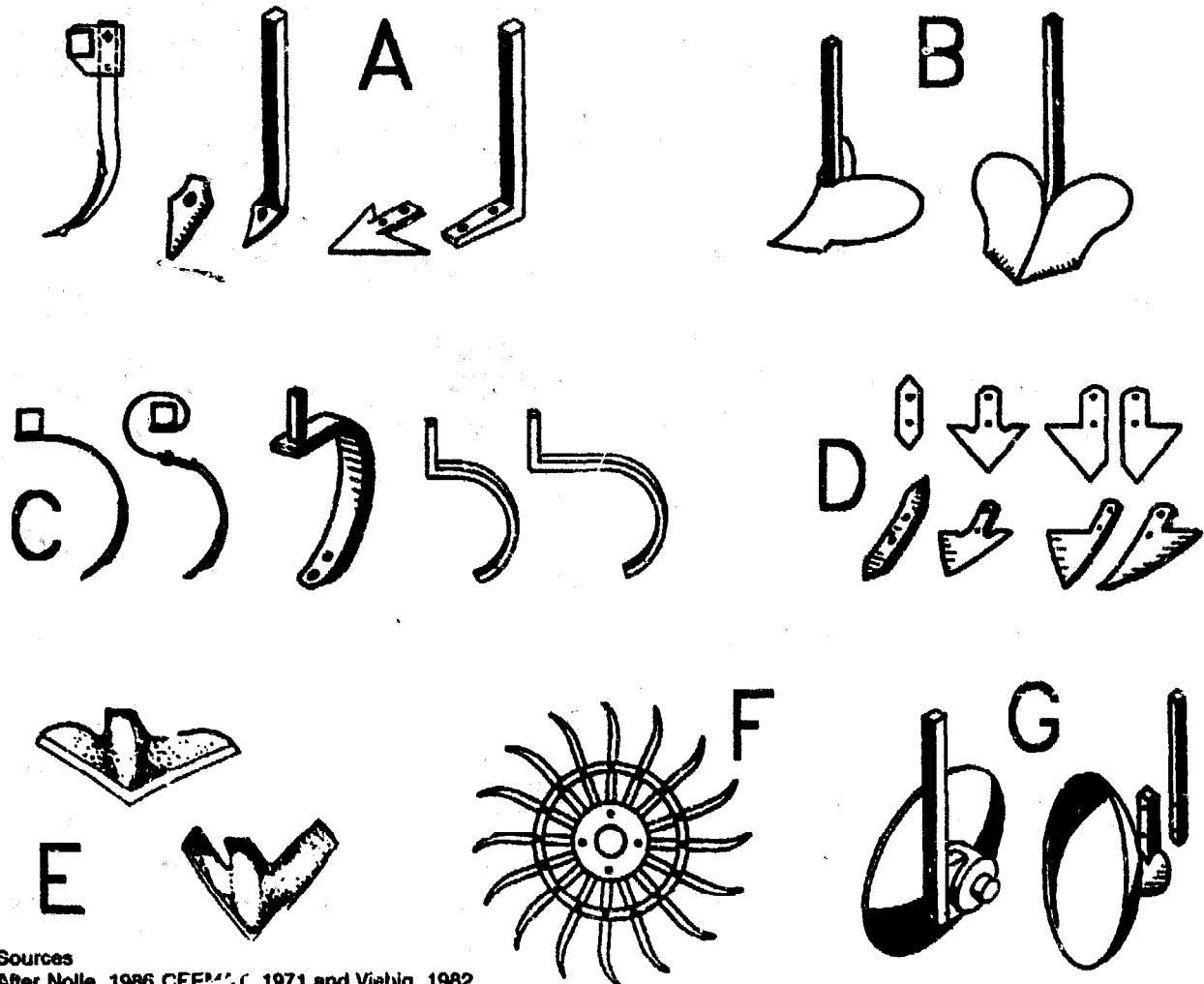


Fig. 7-36: An adjustable row marking device using standard cultivation tines (reversed, mounted on a triangular multipurpose toolbar in Togo.

markers (*rayonneurs*) may be used to identify clear rows for hand-placement of seed (Fig. 7-36). Such systems may allow the very significant benefits of inter-row weeding to be obtained without the technical and financial problems sometimes associated with seeders. While row-markers are intrinsically very simple, they are certainly not without their problems, for while they are very effective on flat, clear surfaces, they cannot cope effectively with surface trash or with mounds and depressions. The wider they are, the more difficult they are to use under normal farm conditions, and few farmers actually make use of them.

7.6 Cultivation tines

Cultivation tines may be used for primary land preparation, secondary cultivation (harrowing) and weeding. In present times, as well as in previous centuries, cultivators have often been designed as multipurpose implements, capable of being used in various configurations and with a range of different tines. For weeding purposes large triangular sweeps up to 500mm wide may be used, which have a similar effect to an Indian blade harrow. More common are intermediate triangular *duckfoot* points which are about 150 mm wide. For primary tillage and harrowing, as well as some



Sources
After Nolle, 1986 CEE/FAO, 1971 and Vielbig, 1982

Fig. 7-37: Some cultivation tine options.

A. Rigid tines with points or duckfoot shares. B. Earthing-up (ridging) cultivation tines.
C. Spring tines (favoured for weeding). D. Cultivation shares: reversible, duckfoot and half-duckfoot.
E. Wide sweeps. F. Rotary tines. G. Disc tines.

weeding operations, narrower 50 mm points are more usual (Fig. 7-36). Such points are often designed to be reversed when worn, to allow further usage. For primary tillage the effect of each point is similar to that of a small ard plow, although the working width and depth are much smaller.

The tines on a cultivator may be rigid or flexible. Rigid tines act at a constant depth relative to the cultivator frame and wide sweeps are always mounted on rigid stalks. *Spring tines* are designed to bend backwards and spring forward, so varying the depth and increasing the pulverisation of the soil. The speed at which oxen walk is seldom sufficient to obtain the intense shattering effect of vi-

bration seen on tractor-mounted spring-tine cultivators. Very springy tines are seldom used with draft animals, but most are designed to have some flexibility. This is particularly useful for reducing damage to the animals and implement should the cultivating tine meet an obstruction.

Inter-row cultivators should be capable of adjustment for different row widths. Angular expansion cultivators are sometimes used in India, Latin America and some countries in Southern Africa. These have an adjustment handle that varies the angle at which the lateral bars hinge onto the central frame, so changing the effective working width (Fig. 7-38). This allows quick and accurate adjust-

Sources: after ILC 1983g
and UPRONA, 1986

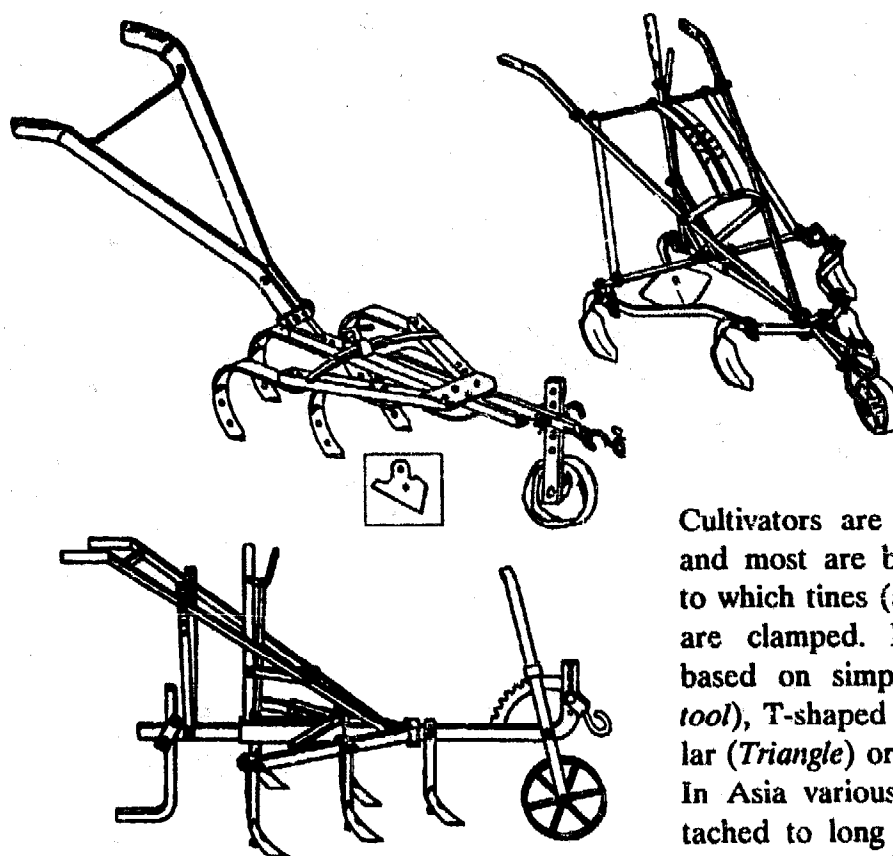


Fig. 7-38: Expandable cultivators.
Top left: "Houe Manga" manufactured by UPRONA, Togo.
Top right: "Rhino" cultivator manufactured by Northland Engineering, Zambia.
Lower left: Interrow cultivator developed by CAMERTEC, Tanzania

Cultivators are widely used in West Africa, and most are based on multipurpose frames to which tines (and sometimes extension bars) are clamped. Different designs have been based on simple longitudinal (*Arara; Peco-tool*), T-shaped (*Houe Sine; Ciwara*), triangular (*Triangle*) or rectangular (*Ariana*) toolbars. In Asia various cultivating tools may be attached to long poles in a manner similar to that of the traditional ard plows. Such cultivators may be multipoint implements or 200-400mm blade harrows.

ment in the field, but adds to the implement cost. In Burkina Faso the Houe-Manga operates on a similar principle, but being designed for use with a donkey, it is significantly smaller than the cultivators of southern Africa which are usually pulled by large oxen.

The effectiveness of cultivation depends on the adjustment of the cultivator for depth and width. Weeding should normally be shallow

Fig. 7-39: Tine tillage in dry conditions in Togo, using a "Triangle" toolbar fitted with rigid tines and points.

Photo: Paul Starkey

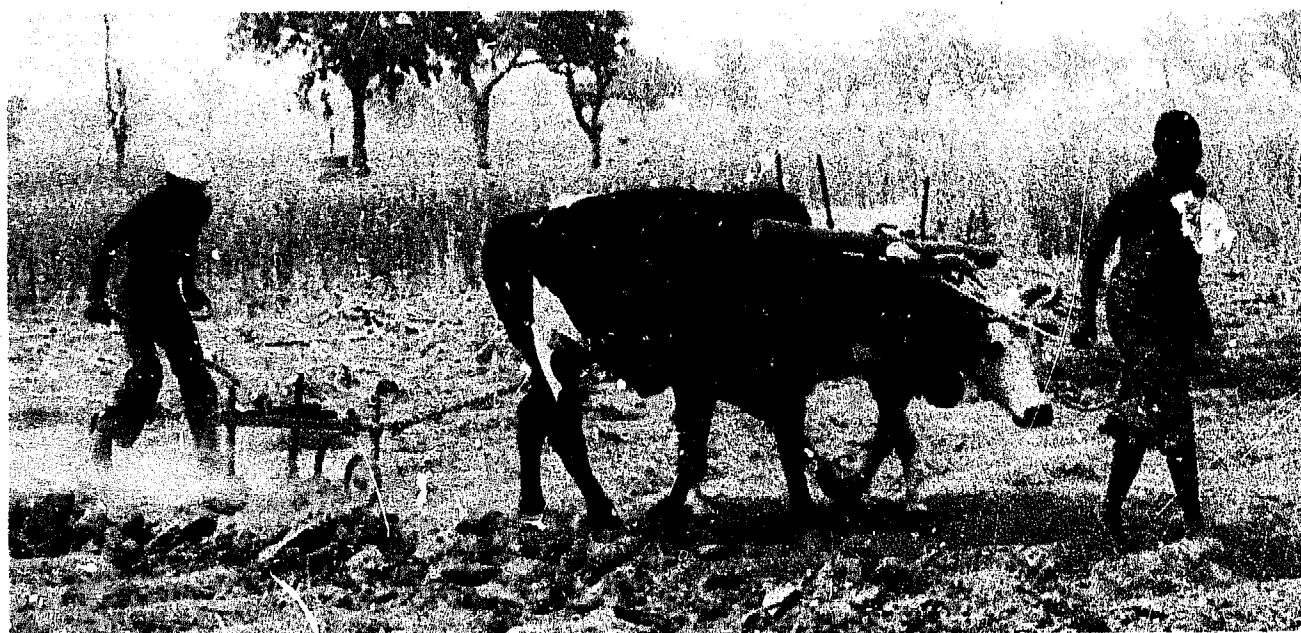




Photo: Paul Starkey

Fig. 7-40: Very early weeding (between seeding and crop emergence) with *Houe Occidentale* fitted with duckfoot tines in Senegal.

(50mm). Depth control is often obtained both by a depth wheel on the toolframe and clamps on individual tines. In the horizontal plane, it is usual for adjacent weeding tines to be spatially offset, but for their paths to overlap. Duckfoot tines should overlap by about 25-50mm (Fig. 7-41).

Naturally the draft of cultivators will depend on soil characteristics and the depth and width of working. Nevertheless the work load

can be high, and a three tine cultivator may have a similar draft to that of a 8" (200mm) mouldboard plow. Unless soil conditions are very light, cultivators fitted with five duckfoot tines are likely to prove too heavy for donkeys or pairs of light oxen.

Inter-row cultivators are best suited to crops grown on the flat with inter-row spacings of about 450-650mm. With significantly larger inter-row spacings, the number of duckfoot

tines required to weed becomes excessive in terms of draft and convenience in use. Smaller spacings make it difficult for the animals and operator to walk between the rows without damaging the plants. Inter-row weeding of rainfed rice or wheat at 300mm spacing using an animal-drawn sweep or blade harrow is possible but seldom practised. Cultivating tines tend to break down ridges rapidly, so that weeding of crops grown on ridges generally

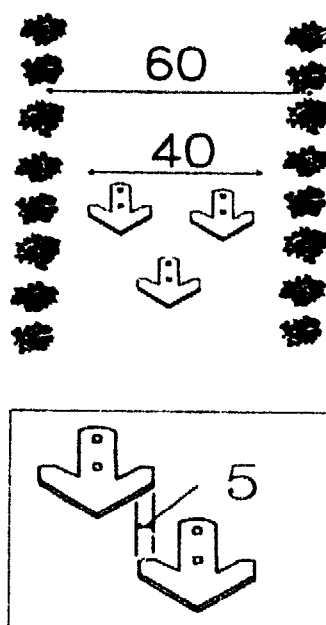
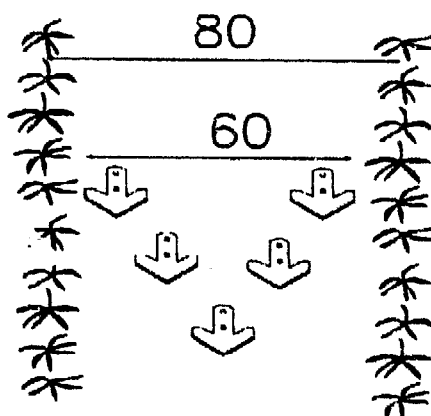


Fig. 7-41: Examples of recommended spacing of duckfoot tines for weeding groundnuts (left) and maize (below) (dimensions in cm).

Source: after FAO, 1983



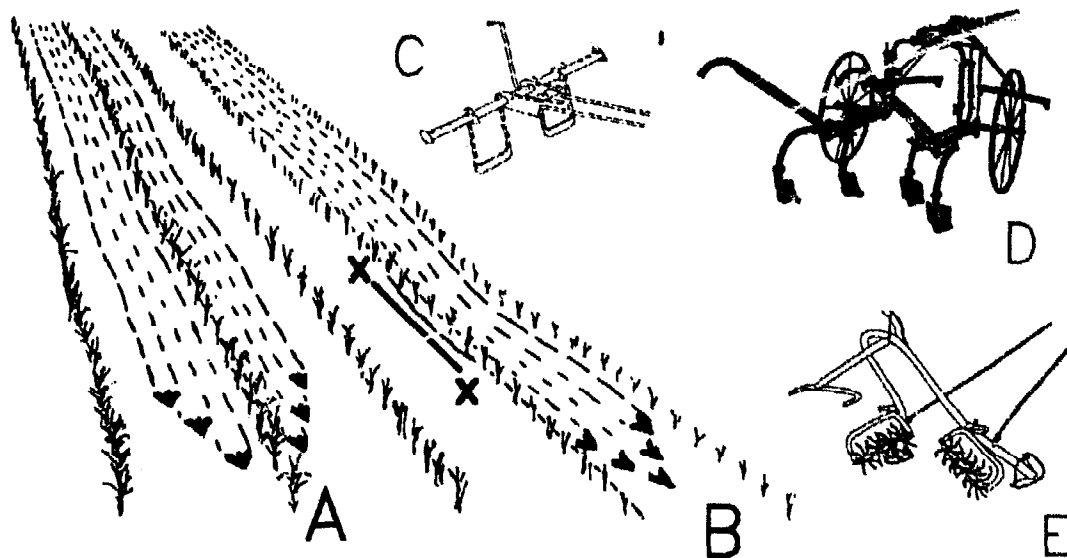
involves an earthing-up ridger.

Multi-row cultivators that weed two or more interlines were widely used in Europe and North America. Multi-row cultivators have been designed or evaluated in many countries in Africa and in recent years several have been based on wheeled toolcarriers or intermediate toolframes. Multi-row cultivators have been shown to be effective on research stations, yet their adoption by farmers has been minimal. The problems centre on manoeuvrability and crop damage. While single-row weeders can be lifted easily by the operator in cases of field obstruction or temporarily converging crop-rows, multi-row weeders are much more difficult to lift and manoeuvre. Consequently in the uneven fields of most African farms, crops are much more likely to be ripped out of the ground by a multi-row cultivator than by a single-row weeder. However Roosenberg (1987) argued that damage could actually be reduced through the use of single-line over-the-row weeders that weed either side of a single row, weeding only half of each of the two adjacent inter-rows. He argued that low adoption of weeders was associated with the fear of crop damage and that this is almost inevitable using weeders which are set to weed almost

all (80%) of the inter-row space. Variation in row spacing and operator error when having to judge implement proximity to two rows simultaneously are likely to bring the weeder into contact with the crops quite frequently. To avoid this there is the time-consuming, but otherwise inexpensive, option of setting the weeder to half the interline, and passing down each row twice. Alternatively the farmer could use a single over-the-row implement. In both cases the farmer only has to concentrate on a single row at a time, but using an over-the-row cultivator the equivalent of a complete interline is weeded in each pass. Single-line, over-the-row weeders enable animals to be yoked closely, they do not require exactly parallel rows and, because they cultivate close to each side of a row, they can throw up soil to inhibit the weeds within the rows (Roosenberg, 1987). Unfortunately it is difficult to design an efficient yet affordable single-row over-the-row weeder. They tend to have high centres of gravity (associated with the clearance needed to avoid damage to growing crops) and the operator either has to straddle the crop or to control the implement from only one side. Such problems can be solved by wheeled ride-on implements, but these have

Fig. 7-42: Over-the-row weeding.

While single-row over-the-row weeders do not depend on crop rows being exactly parallel (A), normal inter-row weeders (B) may remove plants (X-X) when the rows converge.



Some implement options:

C. Prototype, all-steel version of the traditional and simple Indian double-blade hoe.

D. An old North American design of over-the-row weeder: expensive.

E. Prototype straddle cultivator from Nigeria: expensive and difficult to manoeuvre.

Sources: after Roosenberg, 1987; Basant, 1987; ITDG, undated

the major disadvantages of higher cost and weight and reduced manoeuvrability.

The "Strad" over-the-row rolling weeder (Fig. 7-42) developed and marketed in Nigeria proved technically effective in experimental prototypes (ITDG, undated; Gwani, 1989). The Strad is a heavy walk-beside or ride-on cultivator with two or four gangs of tines that rotate as the implement moves forward. The rotating tines are effective for weeding crops grown on ridges, but the adoption of the Strad has been low, perhaps because of its high cost. Prototype animal-drawn weeders using steel discs as tines have been developed. The angled discs rotate as the implement moves forward, and they can be used with great precision close to plants. However weeding discs and suitable bearings are expensive to manufacture or buy, and implements fitted with discs have generally been heavier than alternative implements. Their diffusion has been very limited.

7.7 Simple multipurpose toolbars

Cultivators (*houes* in French) have long been multipurpose implements and during the last

thirty years multipurpose toolbars have become quite widely used in West Africa. One of the most successful designs has been the *Houe Sine* developed by the French engineer Jean Nolle in Senegal in the late 1950s. This comprised a T-frame with depth wheel, onto which clamped a variety of cultivating implements, including duckfoot tines, groundnut lifters, earthing-up bodies and plows (Fig. 7-43). The design has proved very popular, and its derivatives have included the *Ciwara* in Mali and the *Policultor 300* in Brazil. The lighter *Houe Occidentale*, that can be pulled by a single donkey, has also been popular in Senegal, and might have spread more if subsidies had not made the *Houe Sine* better value for money (Havard, 1986; Bordet, 1987). The heavier *Unibar* (Fig. 9-11) with a Y-shaped frame and straight-beam toolbars such as the *Anglebar*, *Arara* and *Pecotool* and their derivatives (Fig. 7-44, 7-47) have also been used in several countries in Africa and elsewhere but have not caught on to the same extent. These have tended to be promoted in regions where plowing and/or ridging is important (such as cotton-growing zones), and in contrast to the *Houes*, the cultivation tines on

Fig. 7-43: The *Houe Sine* multipurpose toolbar and its derivatives have been widely manufactured in many countries. This example was made in Senegal and shows the toolbar fitted with three duckfoot tines. Beside it are a groundnut lifter, an earthing-up ridger and a mouldboard plow body.

Photo: Paul Starkey



these toolbars have often been of secondary importance.

In Burkina Faso and Togo the multipurpose *Triangle* cultivator with a single depth wheel is used in conjunction with conventional plows and ridgers.

Heavier, rectangular toolframes such as the *Ariana* and its derivatives have been developed from Jean Nolle's *Houe Saloum*, designed in Senegal in the late 1950s. These intermediate toolframes generally have two depth wheels, one on either side of the frame which gives great stability. For single-row weeding one wheel can be used in a central, forward position. The rectangular design of toolframes provides more space for additional implements, and thus a greater potential working width. However since the limiting factor on small farms is often animal draft power, additional implements cannot be easily pulled, and the potential for the extra working width is seldom used. These intermediate toolframes are about twice the weight and cost of simple toolbars and their weight

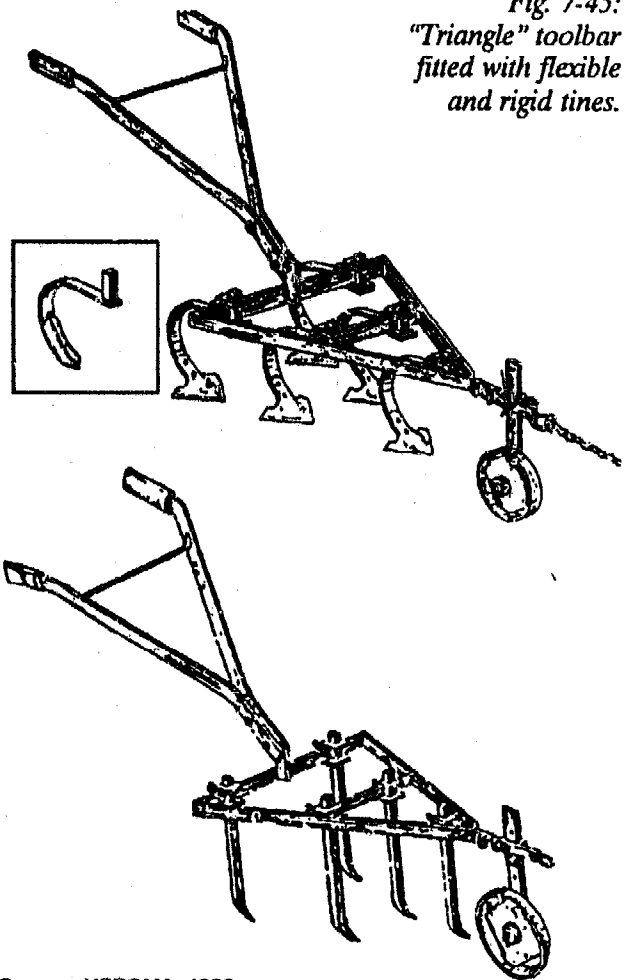
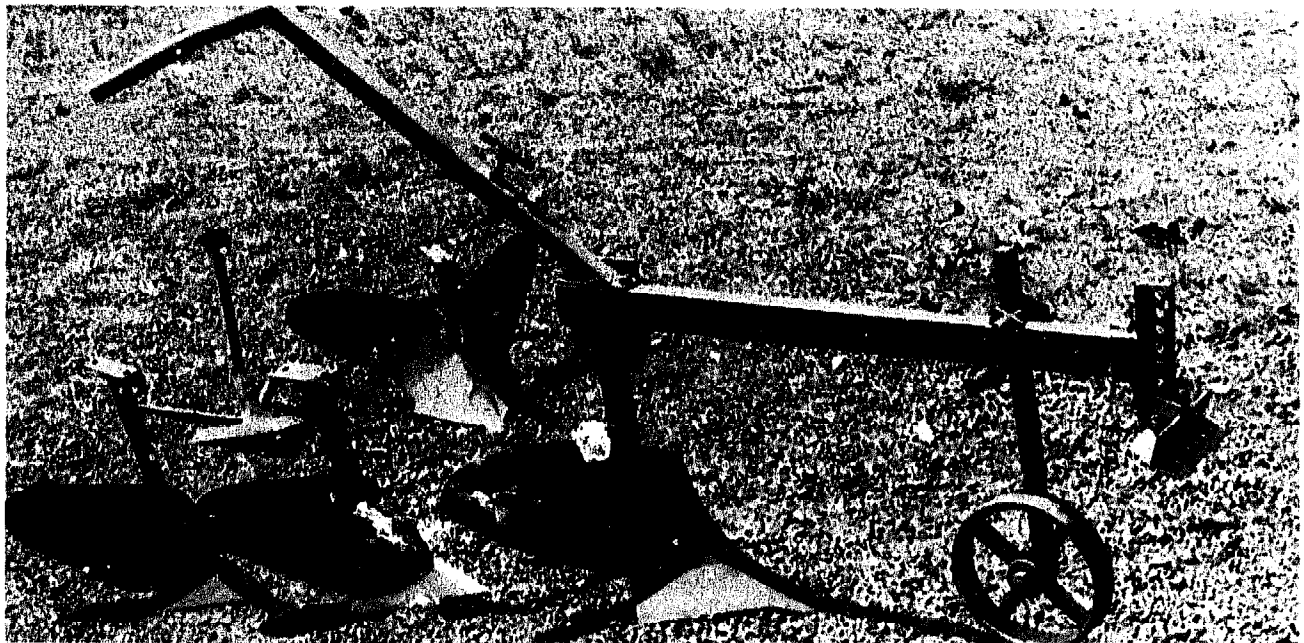


Fig. 7-45:
"Triangle" toolbar
fitted with flexible
and rigid tines.

Source: UPRONA, 1986

Fig. 7-44: Pecotool multipurpose toolbar, showing three sizes of plow body, groundnut lifter and ridger. Small numbers of Pecotools (and similar Anglebars/Multibarras and Unibars) have been made in several countries including Sierra Leone and Tanzania.

Photo: Paul Starkey



makes them less easy to transport or manoeuvre. Although they have received much acclaim when evaluated on research stations, they have never been adopted on the scale of simple toolbars. For example in Senegal, where they have been available for twenty-five years, sales in the period 1958-80 were about 8500 (the majority being sold during one scheme in the early 1960s). This represents less than 3% of the 340,000 simple toolbars (*Houes*) sold in the same period (Havard, 1985).

The larger wheeled toolcarriers first developed in Senegal at the same time have never enjoyed sustained farmer adoption, and reasons for their rejection are discussed in section 9.2.

Although undoubtedly successful in some areas, toolbars should not be seen as panaceas

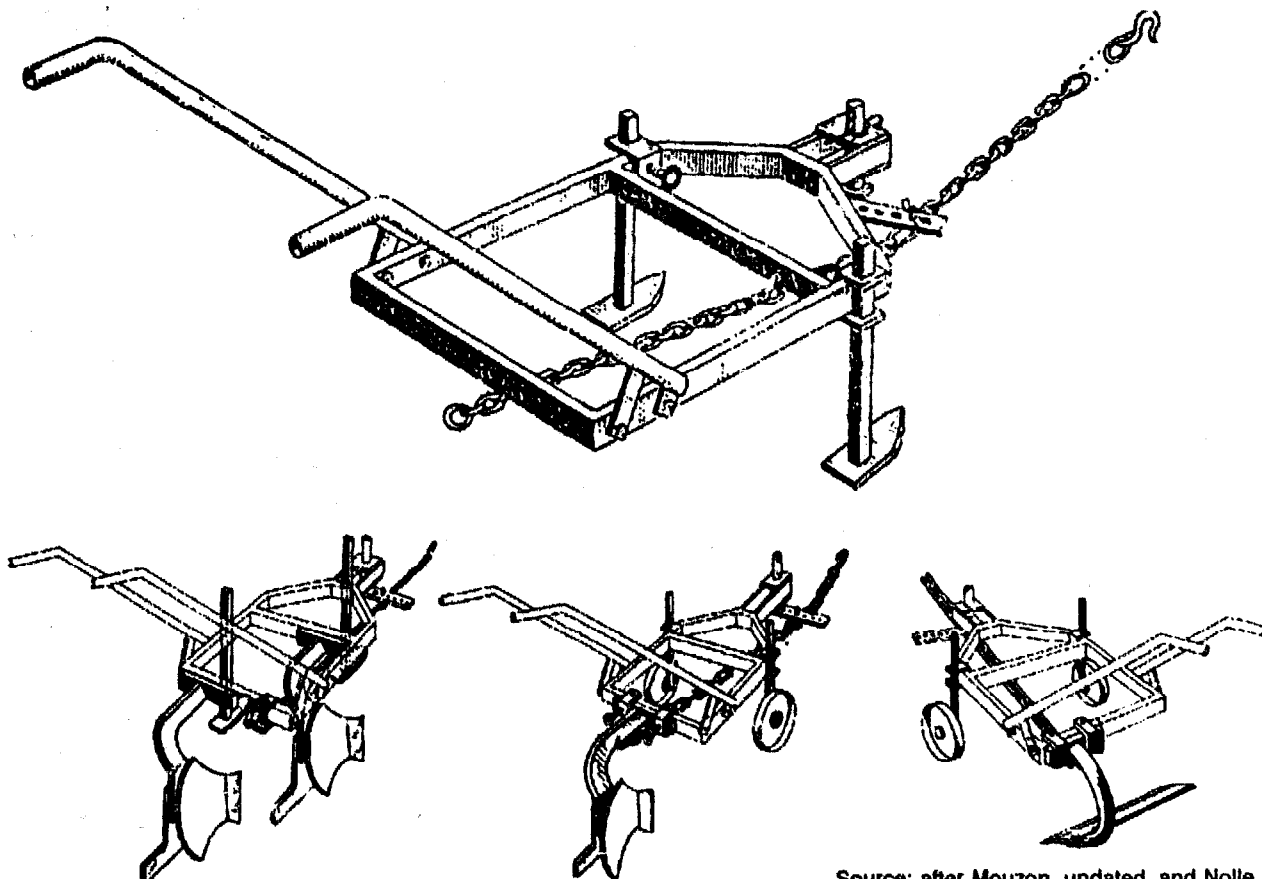
of universal application. Even in Senegal and Mali where they are most popular, they have not completely replaced single purpose implements such as plows. While Jean Nolle has developed the concept of multipurpose use into an effective design philosophy (Nolle, 1986), there are limits to its application. As has been made clear in previous sections, most equipment design involves compromise between incompatible features, and the more different uses an implement has, the greater will be the number and extent of the compromises.

The main advantage of multipurpose design is to reduce overall material requirements and thus costs by using common elements for several purposes. Other possible advantages such as reduced storage space are seldom of great importance in rural locations. However the requirement to change between the different

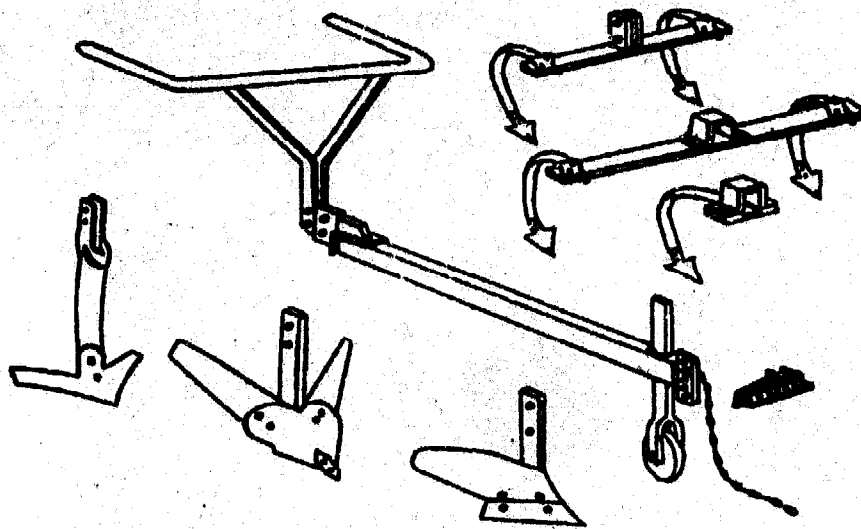
Fig. 7-46: Ariana "intermediate" toolframe. The Ariana and its derivatives have been evaluated in numerous countries, and manufactured in several of these, but they have not achieved the same success as the Houe Sine.

Top: basic frame fitted with two skids.

Bottom: frames fitted with double furrow plow, single plow and groundnut lifter.



Source: after Mouzon, undated, and Nolle, 1986



Source: Mignolet et al., 1987

Fig. 7-47: The Arara toolbar has been manufactured in several West African countries including Niger, Benin and Senegal. The package illustrated contains a groundnut lifter, earthing-up ridger, plow and cultivation tines.

modes leads to increased costs as removable clamps are more expensive than permanent welds or semi-permanent nuts and bolts. In addition the common elements (such as the frame) must always be designed for the most demanding of all the various applications. Thus a multipurpose implement is always likely to be more expensive than any one single-purpose tool. For similar reasons total cost savings over a full range of single-purpose tools are more modest than might be expected since the additional work involved in forming standard mountings and clamps partially offsets the savings of using a common frame and handles. In addition, a multipurpose tool inevitably involves some loss in convenience in changing between modes and readjusting the tools, in comparison with single-purpose implements that can often be left ready for use in an appropriate setting. Finally a multipurpose tool maximises risk. As all tool options depend on the common elements it is an illustration of the expression "all the eggs in one basket". To take a common example: if a bolt of a plow clamp breaks inside the clamp, the toolbar is unusable for all operations until it can be removed and repaired. A single-purpose plow would be less likely to break as it does not have such

clamps, but should it do so, the farmer's other equipment (cultivator, ridger etc.) would not be affected.

Where multipurpose toolbars have been successful, it has been in countries where they have been mainly used as *cultivators*. In Senegal the *Houe Sine* is used more often for fine-tillage, weeding, groundnut-lifting and earthing-up than for plowing. Where mouldboard plowing or ridging are major characteristics of the farming systems, it is quite likely that the combination

of single-purpose plows/ridgers and a *multipurpose cultivator* may be found preferable to trying to combine all implements into one tool. This may explain the noticeable lack of uptake of toolbars in Eastern and Southern Africa (Ahmed and Kinsey, 1984). Some development workers have advocated the promotion of multipurpose toolbars as one means to encourage and facilitate row-cropping techniques in the longer term (Mettrick, 1978; Starkey, 1981). However in such circumstances farmers may well be encouraged to purchase implements that are unnecessarily expensive for their short-term requirements. There has been a similar tendency to promote (through credit) comprehensive toolbar packages with a wide range of attachments, when only one or two of these proved to be of real value to the farmers. Finally many of the undoubted benefits of toolbars have arisen not only from the *multipurpose* characteristics of the designs, but from the simultaneous application of another of Jean Nolle's design philosophies: standardization and interchangeability. These characteristics have been elegantly combined in designs such as the *Houe Sine* and they could also be usefully applied to ranges of single-purpose implements.

Sources: after CEEMAT, 1971, Mouzon, undated and ITDG undated

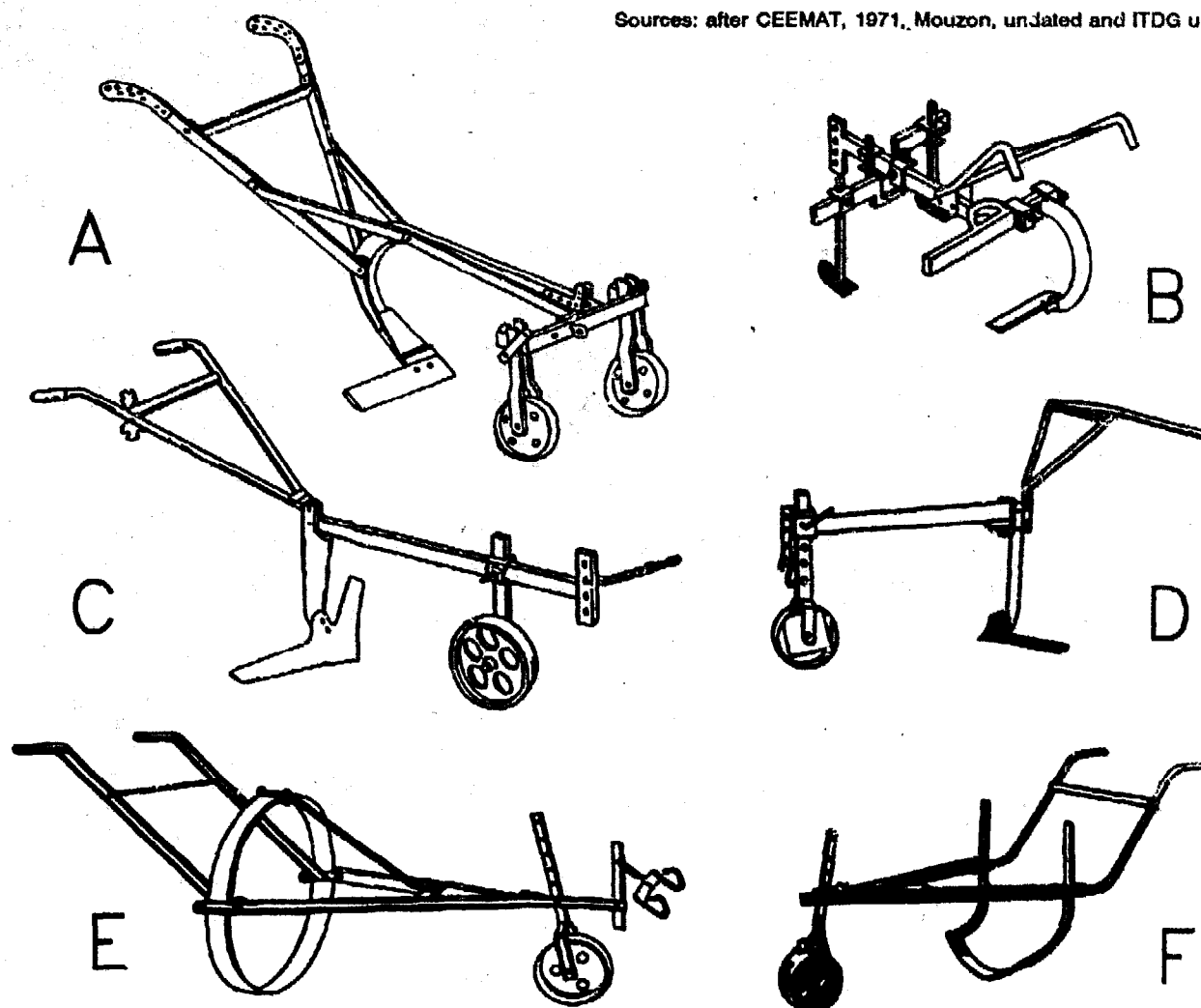


Fig. 7-48: Some designs of groundnut lifter.

A. Sidesweep lifting share fitted to Emcot ridger frame. B. Houe Sine fitted with sidesweep lifter.
C and D. V-sweep lifters attached to toolbars. E. Hoop lifter. F. Curved blade lifter.

In conclusion multipurpose toolbars have proved very effective and popular in some countries, while in others uptake has been minimal. They have tended to be fashionable within development circles so that alternative equipment combinations have sometimes been overlooked. The advantages and disadvantages of multipurpose toolbars should be carefully considered, alongside other options.

7.8 Groundnut lifters

Animal-drawn harvesting implements are not common, but groundnut lifters have had some success. Lifters are quite simple implements based on one wide sweep blade. This passes through the soil at a depth of 50-100mm severing the deeper roots and leaving the

plants, to which the groundnuts are still attached, lying on the soil surface from where they can be easily collected and piled. The implement share may be:

- a V-shaped sweep attached centrally to a rigid stalk;
- a long, broad, straight share supported at one end;
- a steel arc supported at either end (like a curved blade harrow);
- a complete hoop, the lower part of which acts like an arc-share.

The stalks supporting the shares are often rounded in order that they can pass easily through the groundnut foliage without frequent blockages. Rising rods may be added to



Photo: Paul Starkey

Fig. 7-49: Triangular harrow being used for swamp rice production in Sierra Leone.

aid the turning of the groundnut plants. Turning aids rapid drying, and therefore reduces the risk of poisonous aflatoxins building up in the plants. Groundnut lifters can be single-purpose implements, but are more commonly attachments on multipurpose cultivators or standard plowbeams. Implements designed for other operations may make quite satisfactory improvisations; for example ridger bodies with the wings removed have been used in northern Nigeria. Single weeding sweeps may be effective, but multiple sweeps rapidly become clogged with haulms and weeds. Various design options have been reviewed in detail by FAO/CEEMAT (1972) and the results of some comparative trials in The Gambia were provided by Matthews and Pullen (1974).

Groundnut lifters are generally simple implements and relatively easy to use. Their effectiveness is largely determined by soil conditions and the extent to which plants impede progress. If the soil becomes too hard before harvesting, the effort required to pull the large share can be high and plant breakage will lead to a higher proportion of the crop being left in the soil. Because of their highly

specialized application they are only common in areas where groundnuts are widely grown; in Senegal numbers of groundnut lifters in use increased from less than 1000 in 1960 to 70,000 in 1983 (Havard, 1985).

7.9 Equipment for irrigated rice cultivation

For the cultivation of rainfed (upland) rice, equipment requirements are similar to other



Fig. 7-50: Cultivating a flooded swamp with Chinese plow. Although the design was well proven in China, it was not considered suitable for use with N'Dama work oxen in Sierra Leone.

Photo: Paul Starkey

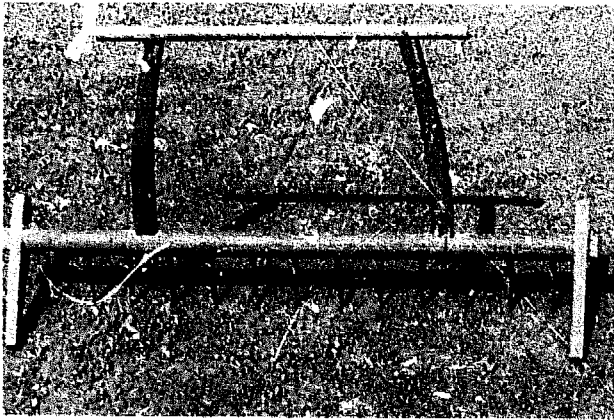


Photo: Paul Starkey

Fig. 7-51: Chinese comb harrow.

crops. However swamp rice cultivation often involves more specialized equipment. Many equipment designs originated in those parts of Asia where draft animals are widely used for swamp rice production. Where paddy fields have not been developed, major bunding and levelling may be required, and the use of scoops and bund-formers is discussed in section 9.7.

Working in flooded swamps is not pleasant for either humans or animals. For this reason the preferred system of swamp rice cultivation involves the initial plowing of the land without superficial water. In this case the tillage implements discussed earlier in this chapter (ards, plows and harrows) are generally used

perhaps in association with specialized land-levelling tools (section 9.7). Nevertheless when water cannot be controlled (as in natural swamps) plowing in flooded fields may be necessary to obtain a second (or third) crop. "Standard" plows, whether ards or mould-board plows, can be used for plowing in either dry or flooded swamps. Plowing in dry swamps is little different from upland plowing although the eventual requirement for level fields makes the use of reversible plows more attractive. In flooded swamps a depth wheel becomes easily clogged and causes unnecessary resistance and a simple, narrow skid may achieve the required depth control with less draft requirement. The shorter and lighter Japanese and Chinese type of plows (Fig. 7-50, 7-10) have been developed mainly for swamp rice production. Some have simple reversible mouldboards and some slatted mouldboards to reduce draft and obtain greater mixing. Without any wheel, skid or long landside the tendency to pitch can only be counteracted by pressures on the handle, and considerable practise is required to obtain accurate depth control. In unskilled hands such plows often alternate between very deep and very shallow plowing, causing discomfort to both animals and farmer (Starkey, 1981). This may partly explain why such plows have not been widely adopted even in the rice

Fig. 7-52: Evaluation of Chinese comb harrow for swamp rice production in Sierra Leone.

Photo: Paul Starkey





Photo: Paul Starkey

Fig. 7-53: Evaluation of an IRRI conical puddler at the large ARPON rice development project in Mali.

growing areas of Africa; farmers have generally preferred mouldboard plows with depth wheels (or skids) that can more easily be used for the favoured practice of plowing dry swamps, as well as for the cultivation of upland crops.

Following plowing, swamps are *puddled* and *levelled*, operations designed to create a smooth and level environment for transplanting the rice. While initial harrowing and levelling may be carried out prior to flooding, final puddling and levelling must be carried out with surface water present. The cheapest and most common system used in flooded fields involves several passes of wide comb harrows (Fig. 7-52) or levelling boards (which may, or may not, have handles such as those in Fig 7-51). These are made mainly of wood,

although the harrow tines may be made of metal. They are commonly used in Asia, but less so in Africa. Their width makes them effective but quite difficult to control and manoeuvre. Similar results may be achieved from wooden triangular spike-tooth harrows (Fig. 7-43) and from Spanish harrows that have corrugated tines rather than points (Fig. 7-55). All these implements can be made and maintained locally.

Equipment with rolling discs, tines or blades can be particularly effective for achieving satisfactory soil mix in rice swamps. In dry swamps disc harrows provide useful pulverisation, while in flooded swamps long-toothed rolling puddlers (similar to those of power-tillers) can achieve good results, particularly if the animals can manage to walk quickly while

Fig. 7-54: Prototype conical puddler for rice production developed by IRRI, Philippines.

Photo: Paul Starkey

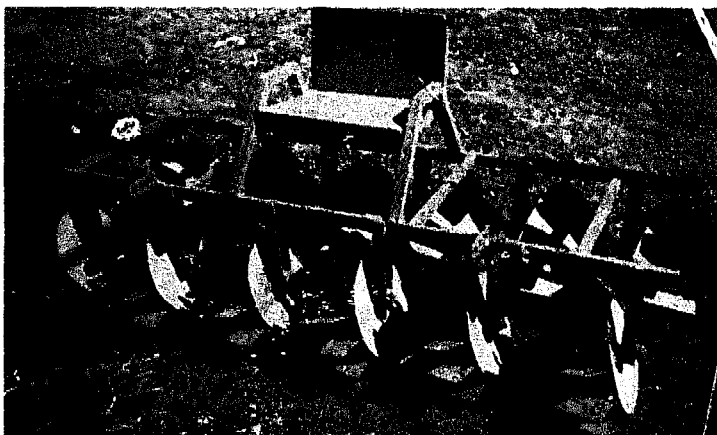
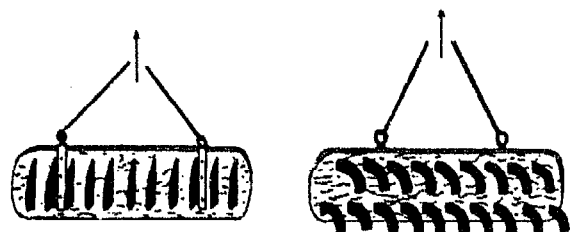


Fig. 7-55: "Spanish" harrows/levellers comprise boards mounted with a series flat steel teeth/shares which are used for swamp preparation in Asia and southern Europe.



Source: CEEMAT, 1971

Sources: Hopfen, 1969 and CEEMAT, 1971

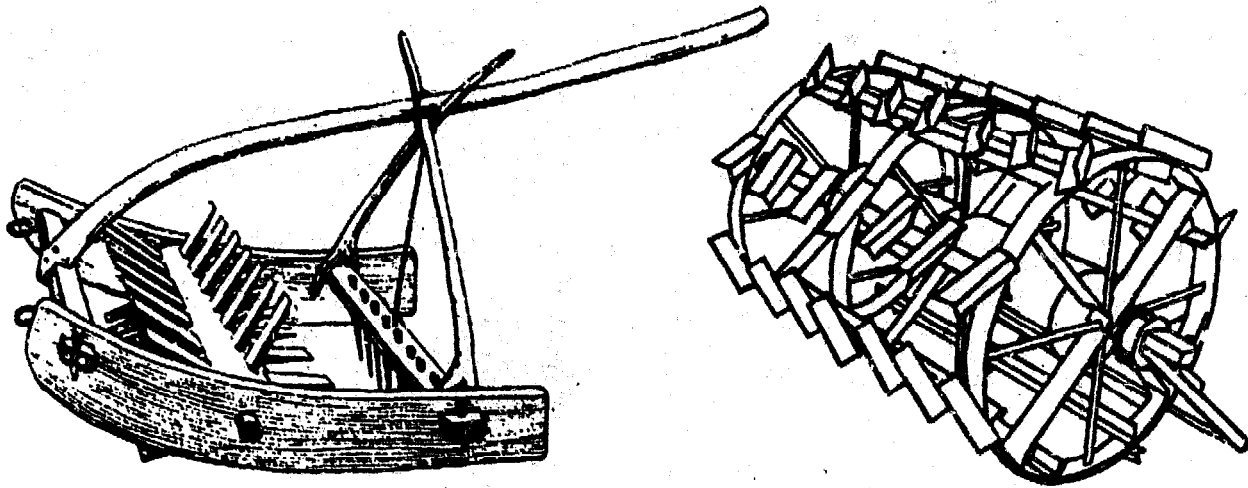


Fig. 7-56: Swamp puddling devices.

Left: a traditional design of wooden rotary puddler used in Asia.

Right: a very large rotary puddler made of steel weighed down with concrete that was developed as an alternative to the traditional method of puddling using herds of cattle in Madagascar.

pulling them. The major problems with such implements are their high draft requirements and their expense. In Madagascar large cattle herds have traditionally been used to trample round and round rice swamps to obtain a puddling effect. This system is effective but requires considerable effort from the cattle and those encouraging them (van Nhieu, 1982). As an alternative to this, large and heavy (160kg) rolling puddling wheels made of angle-iron have been developed (CEEMAT, 1984). These have proved technically effective but quite expensive and awkward to manoeuvre. More recently the International Rice Research Institute in the Philippines has developed an animal-drawn conical puddler (IRRI, 1986), but it is too early to say whether this will be regarded by farmers as cost-effective.

In both Asia and Africa, rice transplanting is normally performed by hand. Hand-pulled transplanters and motorized implements have been developed but, despite research efforts, there have not yet been any successful designs of animal-drawn rice transplanters (Biswas, 1981). In flooded swamps weeding may not be necessary, and the narrow inter-row spacing precludes the effective use of animals for such purposes. Harvesting of rice is performed ma-

nually or with motorized equipment, and there are few, if any, examples of animal power being used for rice harvesting.

7.10 Further sources of information

The reference works of Hopfen (1969), CEEMAT (1974), CEEMAT/FAO (1972), Munzinger (1982) and Poitrineau (1990) contain much helpful information on the range of animal-drawn crop production implements and their use. Useful training material on the adjustment and operation of conventional crop production equipment used with draft animals has been produced in Burkina Faso (FAO, 1983), The Gambia (Matthews and Pullen, 1974), Niger (Mignolet et al., 1987), Sierra Leone (Starkey, 1981), Swaziland (Seubert, 1986), Zambia (Dibbits, 1987), and Zimbabwe (AETC, 1986a, 1986b, 1987). Case history studies on the adoption of different types of animal-drawn crop production equipment in Africa have been written by Bordet (1987, 1989), Bordet, Lhoste, Le Moigne and Le Thiec (1988), Havard (1985, 1986, 1987), Kinsey (1984 a-d), Kline, Green, Donahue and Stout (1969), Le Moigne (1980), Robinson (1987) and Uzureau (1984).

Anyone intending to test, design or develop different or "improved" animal-drawn crop

production implements would be wise to start by reviewing previous experiences. The brochures of manufacturers can be a useful starting point, although these should be treated with caution for they will not be objective publications. Just because designs are offered by commercial manufacturers does not guarantee they have *ever* been proven in farmers' fields or are appropriate. Bearing this in mind the ITDG book on agricultural implements (ITP, 1985) gives a good idea of the range of available equipment and some of the suppliers. Very many papers have been written describing implement prototypes and adaptations, and some of these have been published in journals such as *Agricultural Mechanization in Asia, Africa and Latin America, Appropriate Technology, GATE Questions-Answers-Information, Machinisme Agricole Tropical* and *RNAM Newsletter*. Not surprisingly the great majority of these articles are very optimistic, and readers should naturally treat their conclusions with caution and if possible attempt to trace a "second opinion" from someone else working in the same area. The work of Jean Nolle (1986) provides many ideas on design considerations for animal-drawn crop production implements.

Many organizations in Africa working on the development of "conventional" animal trac-

tion implements including plows, cultivators and seeders are mentioned in the GATE Animal Traction Directory: Africa (Starkey, 1988). These include: FMDU, Botswana; CNEA, Burkina Faso; CMDT-DRSPR, Mali; Projet FAO and Projet Productivité Niamey, Niger; ISRA and SISMAR, Senegal; WOP, Sierra Leone; WSDC, Sudan; Mbeya Oxenization/ZZK, Tanzania; UPRONA, Togo; Animal Draft Project and AMRDU, Zambia; and IAE and Bulwayo Steel, Zimbabwe. Other organizations with significant interest and experience in this field in Africa include CEE-MAT, France; Agricultural Services Division (AGS) of FAO, Rome and AFRC-Engineering, UK.

A great deal of information on Indian designs of crop production equipment is available at the Central Institute of Agricultural Engineering (CIAE), Bhopal, India. IRRI, in the Philippines, has information on the use of draft animals for swamp rice production, derived from its own Agricultural Engineering Department, and also from its coordination of the Rice Farming Systems Network. Further information on Asian experience is available from the Draught Animal Power Project, coordinated from Townsville, Australia.

8. Equipment for transport

8.1. Pack animals

Donkeys and mules are the main pack animals in most regions of the world. Mules are produced by crossing a female horse with a male donkey. Mules are larger and stronger than donkeys, but donkeys are cheaper to buy and to maintain. The reliability of donkeys is legendary. Once trained, donkeys can follow particular routes with minimal supervision; they will wait patiently for several hours and they can often be trusted to return "home" unattended. Horses can be fast and efficient pack animals, although they are not as hardy as donkeys. Being more expensive to purchase and maintain than donkeys, horses are used mainly for high-value or strategic operations. Camels are excellent pack animals, unrivalled in their ability to cope with severe desert conditions, but they also are more costly than donkeys. Llamas and yaks are locally used in the foothills of the Andes and Himalayas. It is rare for cattle to be used as pack animals.

Donkeys are maintained as pack animals in many African countries, particularly in north Africa, the Sahel, Ethiopia and parts of eastern Africa. Their employment has often been a long-standing tradition. When donkeys are used for pack work, it is normal to place some form of protective padding over their backs. This may be sheepskin, sacking or discarded cloth. Soft loads such as sand, fertilizers, canvas water containers and straw are placed symmetrically over the back and held in place by one (or more) leather or rubber straps around the girth or belly, and under the base of the tail. Hard loads such as firewood, stones or rigid containers are generally supported on simple wooden symmetrical saddle frames sitting on light padding and held in place with tail and girth straps. Simple pannier baskets may also be used (Fig. 8-3). Pannier baskets with opening bottoms that allow loads to be shed easily have been used in Western Samoa (FAO, 1986). In Ethiopia,

Fig. 8-1: Donkeys in Ethiopia are widely used for transporting firewood.

Photo: Michael Goe



Fig. 8-2: A donkey in Ethiopia with wooden saddle for transporting stones.

Photo: Paul Starkey



Sources: Hopfen, 1969; Viebig, 1982; ITDG, 1972

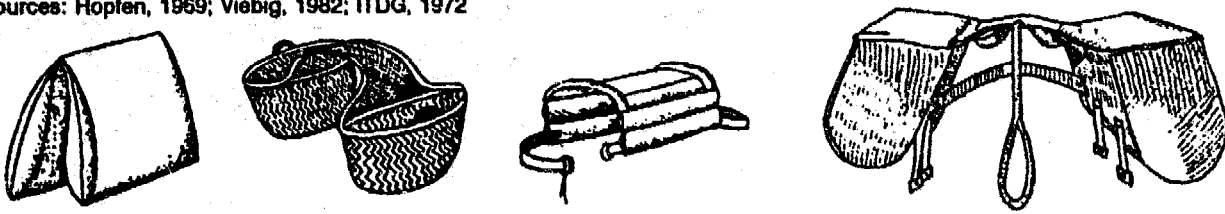


Fig. 8-3: Some pack saddle designs.

donkeys are widely used as pack animals and animals averaging 100-110 kg bodyweight regularly carry loads of 25-50 kg over distances of up to 20 km (Goe, 1987).

The distribution of donkeys in Africa is restricted by several ecological factors, notably the disease trypanosomiasis. With cattle being much more readily available, there has been some interest in the potential of cattle as pack animals (Smith, 1981; Spencer, 1988). While cattle do not readily take loads on their back, they can certainly be trained to do so. In parts of Mali and Chad cattle may be ridden for personal transport by farmers (Fig. 4-13), and some pastoralists in Sudan and Somalia use cattle to transport their effects when moving

Fig. 8-4: Donkey with basket-work panniers used for carrying manure to fields in Egypt.

Photo: Paul Starkey

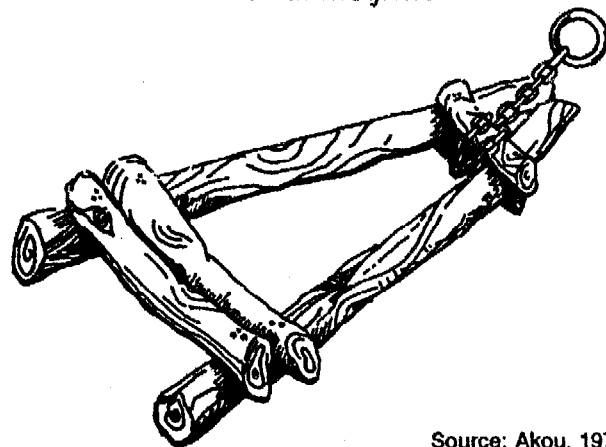


between sites (as was illustrated in Fig. 4-15). Bovine pack saddles were developed in Tanzania (King, 1940), but were not adopted (see section 4.6). As animals can pull greater loads than they can carry, in most areas work relating to ox-carts will probably be more productive than trying to develop systems of using cattle as pack animals. Where narrow paths restrict the use of conventional carts, it has been suggested that transport of goods could be on sledges (Ramaswamy, 1981) or very narrow carts (Hinz, 1985).

8.2. Sledges

Wooden sledges are quite widely used in certain areas of eastern and southern Africa, Madagascar and parts of Asia and Latin America. In southern Africa simple sledges are made by joining two wooden beams in the form of a V, or by selecting a naturally occurring fork in the branch or trunk of a tree, perhaps 150 mm in diameter (Kjærby, 1983; Müller, 1987). A traction chain is attached to the single end of the "V" or "Y" (Fig. 8-5). The load is supported by the two arms onto which a simple

Fig. 8-5: Simple wooden sledge as used in Uganda and southern Africa.



Source: Akou, 1975

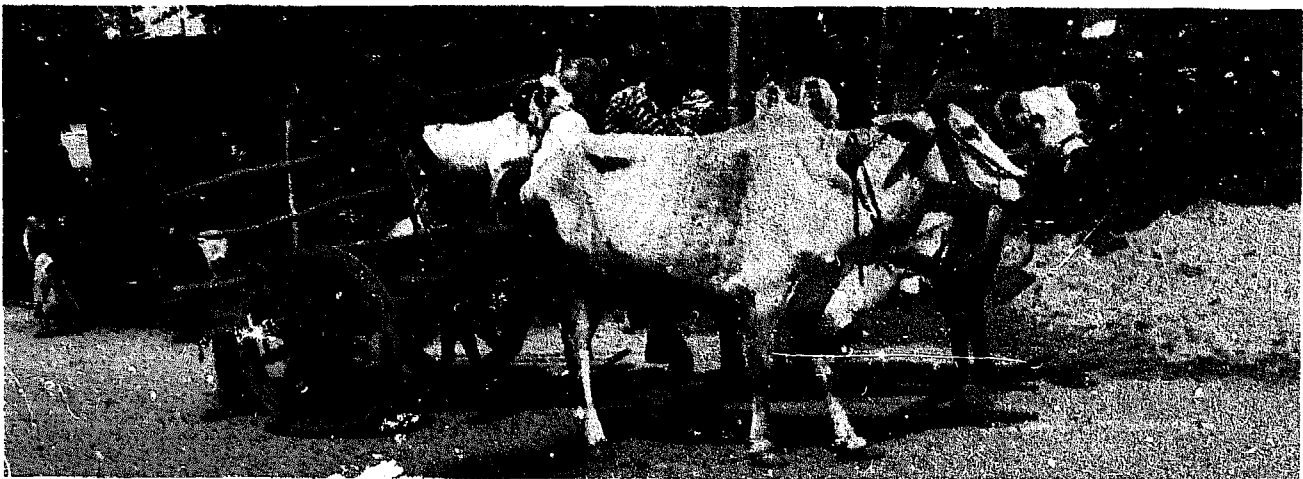


Photo: Paul Starkey

Fig. 8-6: Traditional ox cart with wooden wheels in India.

platform can be built, and sides can be fitted if required. More expensive sledges can be made using separate wooden or steel runners, onto which can be mounted a variety of bodies. Such refined sledges have been evaluated for transport work on oil palm plantations in Malaysia (Kehoe and Chan, 1987).

The advantages of sledges are that they are cheap and simple to make and maintain. They have a low centre of gravity and they are narrow, enabling them to be used on tracks too narrow or steep for carts. They can often be used in sandy, muddy or rutted conditions where a cart might become stuck. However these advantages are offset by many disadvantages. In most conditions they require more effort to pull than does a cart. They have limited clearance and can be stopped dead by projecting stumps. Most importantly they

tend to accelerate erosion by leaving rutted tracks, often only passable by other sledges, which become water courses during heavy rains. In several areas of southern Africa, including Lesotho and Zimbabwe, the dangers caused to the environment by sledges have led them to be officially discouraged and even banned.

8.3 Carts with two wheels

Carts pulled by animals are widely used for rural transport; there may be 40 million in operation worldwide, the majority in Asia. Many carts are constructed in a way that combines artisanal skill with traditional folk arts. Most carts employed in the world are made mainly of wood, and use traditional designs of wooden-spoked wheels (Fig. 8-6, 8-8). However carts with steel frames and pneumatic tyres are becoming increasingly common.

Two-wheeled animal-drawn carts are much more common than four-wheel carts due to their lower cost, lighter weight, lower complexity and greater manoeuvrability.

About 700,000 animal-drawn carts are in use in Africa. Near

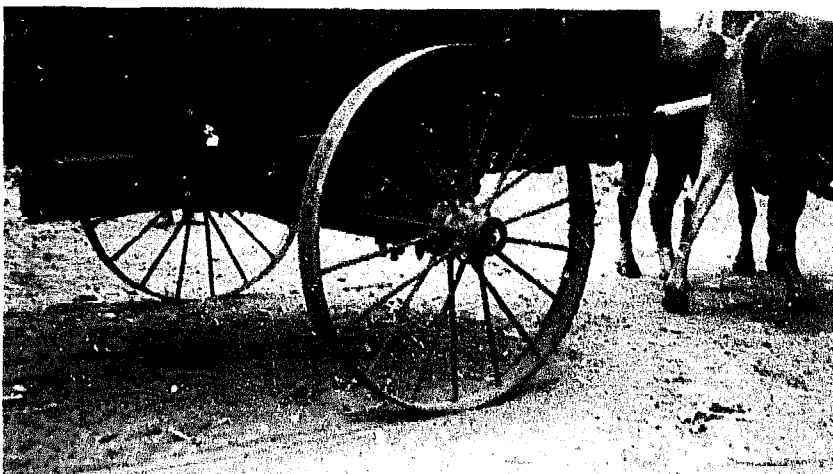
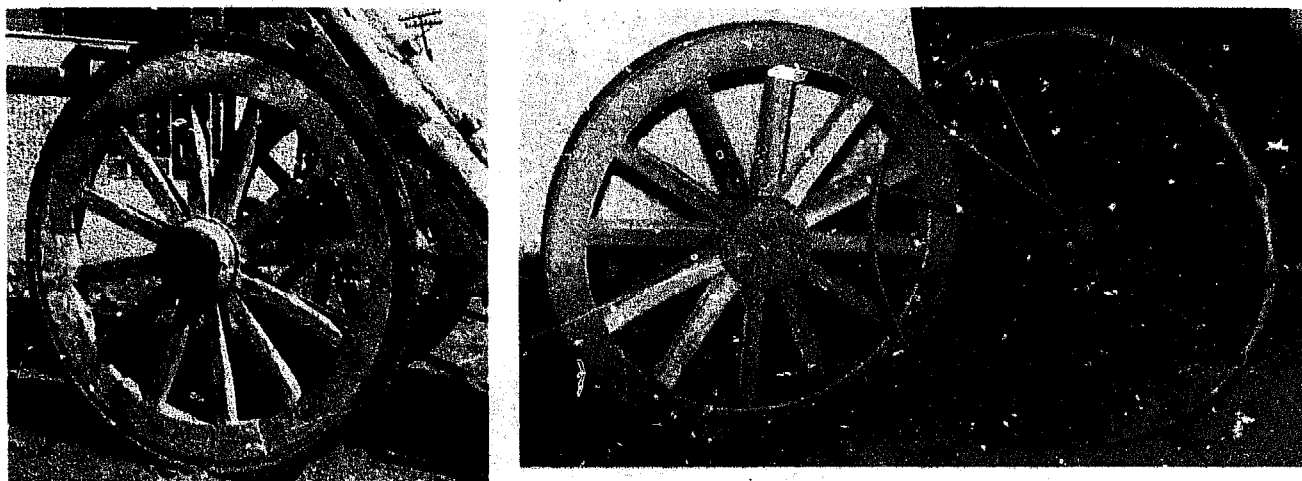
*Fig. 8-7: Large steel cart wheels used in Mozambique.*

Photo: Paul Starkey



Photos: Paul Starkey

Figs. 8-8, 8-9: Left: Wooden wheel on cart in Egypt. Centre and Right: Wooden and steel wheels fabricated in a small workshop in Zaïre. The production of wooden-spoked wheels has since stopped.

cities and market towns, carts may be operated full-time on a hire basis by transport entrepreneurs. Only about ten percent of African farmers who own draft animals have a cart, but the importance of carts to the agricultural sector is much greater than the simple numbers imply. While other implements are used for a small number of days each year, carts are generally used throughout the year. Thus in terms of overall implement usage in Africa, the total number of cart-days each year would be second only to the number of plow-days.

In some African countries, such as Senegal, animals were used for pulling carts around ports and towns long before they were employed in agriculture. In other countries animal draft power was first introduced for cultivation, and animal-drawn transport came later. Once a suitable and affordable cart design becomes available, the adoption of carts can be quite rapid and even eclipse the agricultural usages of draft animals. Examples can be cited of farmers who managed to buy carts for their work oxen and then found it more profitable to hire-out the cart and hire-in manual labour, than to continue to plow with the oxen. Interesting parallels may be drawn with tractor usage in Africa, where employment for transport has often exceeded use for cultivation (Bjnswanger, 1984).

All major types of draft animal can be used for pulling carts. Cattle are strong but slow, and particularly suited for short but heavy transport work around fields and on rough tracks. In India, long-legged breeds of cattle are also used for hauling goods over long distances. Donkeys are light, but will readily trot along roads, and are particularly useful for taking light loads to and from markets. Horses are strong and fast and are generally used for carrying high value loads, including people and traded goods. In general, the designs of carts for cattle, horses and donkeys are similar, although donkey carts may be lighter and less strong. Parallel shafts are commonly used for single animals and central drawbars for pairs of animals.

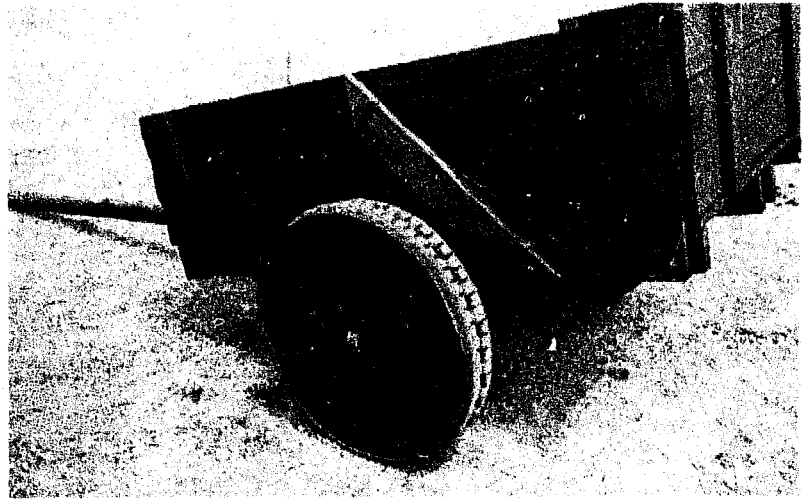
8.4 Wheel options for carts

Large wooden wheels with wooden spokes were standard in most parts of the world before the development of pneumatic tyres and such designs are still widely used in Asia and Latin America. Wooden-spoked wheels have for many years been made and used in Egypt, North Africa and the islands of Madagascar and Mauritius but although there have been many attempts to introduce comparable artisanal manufacture in Sub-Saharan Africa, such wheels have not been widely adopted by small farmers. One recent project initiative in

Fig. 8-10: Wooden-wheeled cart nicknamed "Flintstones" in Zambia.

Photo: Paul Starkey

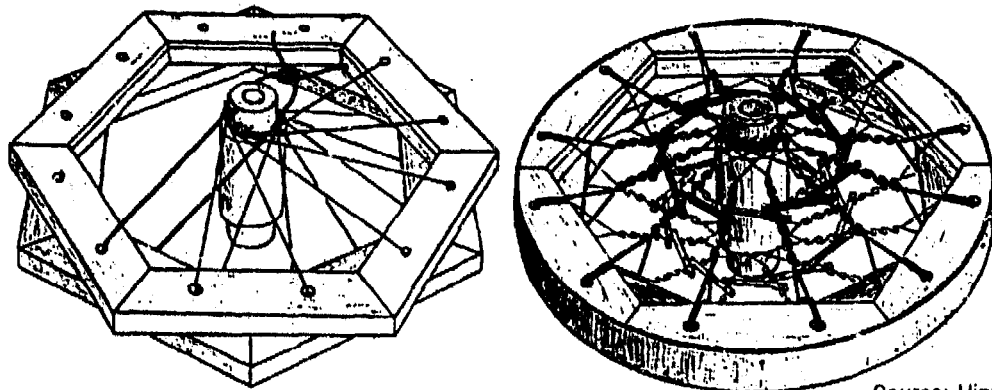
Zaire, where timber is plentiful, found that each wooden-spoked wheel required well-seasoned wood and about one month's skilled labour. With large fluctuations in the ambient humidity between seasons, any inferior work or poorly seasoned timber quickly became apparent as wheels buckled and disintegrated. It was concluded that steel wheels of similar diameter might be more durable.



Wheels can be constructed from wood even if the technical refinement and complexity of spokes is neglected. In several parts of Asia and Latin America long-standing designs of such "solid" wooden wheels are to be seen, but they are much less common than wheels with spokes. Solid wheels are heavier, relative to their strength, than spoked wheels, and so large-diameter solid wheels are rare. In Africa several designs of "solid" wooden wheel have been evaluated. Some designs are made by cutting a circle from parallel timbers, glued or nailed into position. These are then supported by other timbers or by a second circle made from boards aligned in a different direction. The wheels are usually given a rubber tread cut from an old tyre. One design developed in Zambia, involves bolting together two wooden circles, between which are clamped the walls of two halves of a split lorry or Landrover tyre, so positioned that the original tread becomes the tread of the new wheel, albeit arranged "sides to middle" (Fig. 8-10).

Prototype wheels using taut sisal string for spokes have been developed (Hinz, 1988). Rims have been constructed from two wooden hexagons, that have been offset to provide a twelve-pointed figure that has subsequently been shaped into a circle and covered with tyre rubber (Fig. 8-11). Sisal threads, that have been tightened by twisting and held in place by small batons, support the wooden hubs. Preliminary field trials using a narrow animal-drawn cart have been carried out in Tanzania (Hinz, 1985). In principle such designs could offer cart wheels that could be made in villages from locally available materials. However until the problems of maintaining such wheels under field conditions can be adequately solved, the technology will not be able to progress beyond the stage of experimental prototypes.

Fig. 8-11:
Prototype wooden wheels using string spokes. Field tests have indicated that there are still several practical problems to resolve.



Source: Hinz, 1988

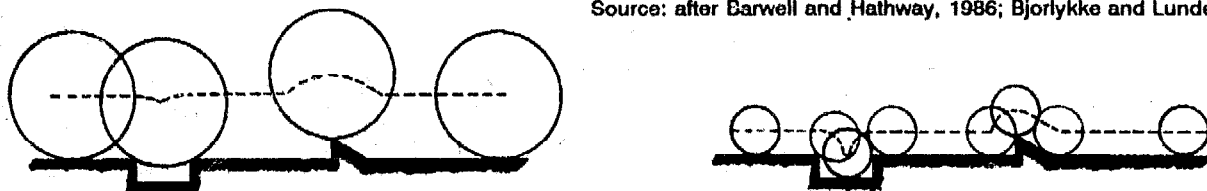


Fig. 8-12: Diagram illustrating how large-diameter wheels (left) are better able to negotiate ruts and holes than small-diameter wheels (right). The ability of a wheel to accept poor conditions is dependent not only on wheel diameter, but also on the width and type of tread and the strength, weight and elasticity of the tyres or wheel rims.

One problem with such a design is that mud can enter between the two halves, tending to separate them. The main advantage of such wheels is that they do not puncture and can be made mainly from local materials by village artisans. However they are heavy and they are not considered fashionable or prestigious (in one country they have earned the name "Flintstone" carts, after the famous "stone-age" cartoon characters).

Steel-spoked wheels are generally lighter than solid wooden wheels, and they are easier to manufacture and maintain than wooden-spoked wheels. They are usually of larger diameter than wheels fitted with pneumatic tyres and thus may be preferred for use on rough tracks where their larger diameter is advantageous for negotiating ruts and holes. However steel wheels are much less resilient than wheels fitted with pneumatic tyres and so

they tend to transmit unabsorbed shock loads to the wheel bearings, cart body, passengers and animals. Their lack of resilience also makes steel wheels more likely to damage roads and tracks. In Mozambique and Angola, large-diameter steel-spoked wheels have become quite widespread while elsewhere in southern and eastern Africa several projects have tried to promote smaller diameter wheels. Steel wheels are relatively cheap to make and easy to maintain. One problem is that shock loads and stresses imposed on steel-spoked wheels can cause fatigue in the welds joining the spokes and the rim; if weld failures are not noticed and repaired, the whole wheel may distort or even collapse. However farmers adopting carts with steel wheels are much more likely to have problems with the wheel bearing than with the wheels themselves.

Fig. 8-13: Ox cart with pneumatic tyres, Burkina Faso.

Photo: Paul Starkey



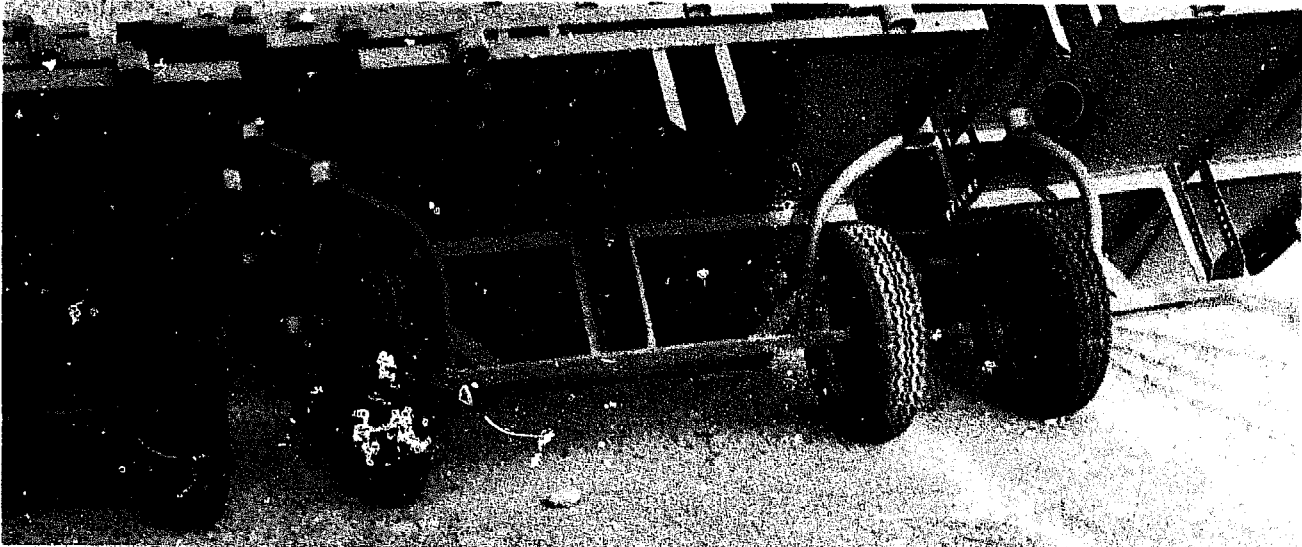


Fig. 8-14: Steel-based two-wheel carts made at the UPROMA workshop in Togo using imported roller bearings and factory-reject car tyres.

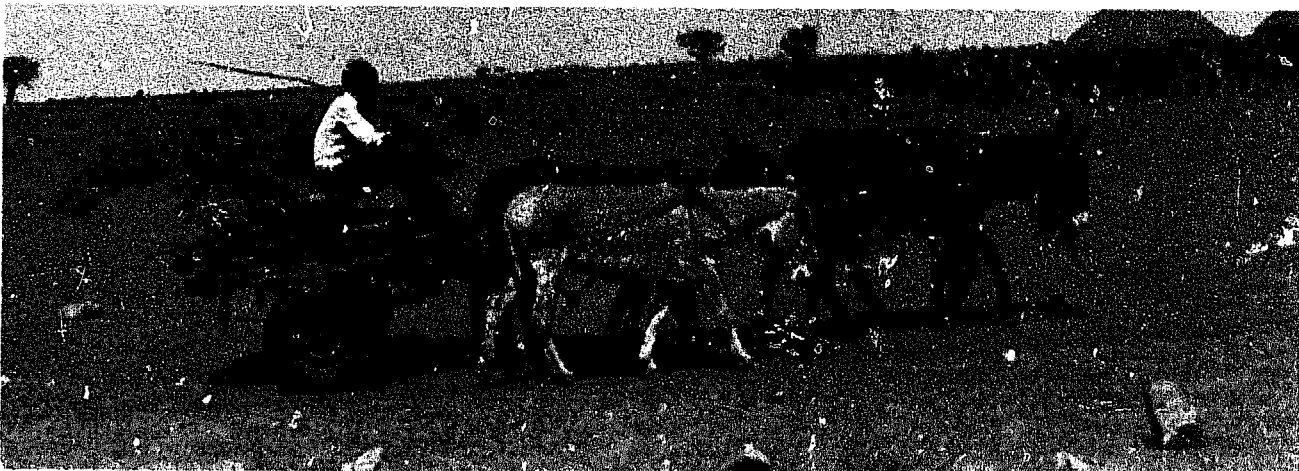
Photo: Paul Starkey

In recent years small wheels fitted with pneumatic tyres have become the accepted standard for animal-drawn carts in many African countries. The adoption of common automobile tyre sizes on carts allows farmers the option of making use of old vehicle tyres. In practice, farmers have often found that the problems caused by punctures make worn-out tyres a false economy. Since the specifications of new car tyres are unnecessarily high for slow moving carts, special lower-cost animal-drawn vehicle tyres have been produced in India. However the development of these large diameter tyres was based on the poten-

tially enormous Indian domestic market (with around 15 million carts) and similar investment in special cart tyres seems unlikely in African countries. An alternative approach, widely used in West Africa, is to purchase at considerable discount the reject tyres from large factories. Low grade, reject tyres are dangerous if put on cars but they can be safely used with animal-drawn carts. In a few countries the use of standard car tyres on carts may be seen as a disadvantage, for during shortages of car spares, compatible cart tyres become targets for theft.

Fig. 8-15: Cart based on old vehicle axle being pulled by team of donkeys in Botswana.

Photo: Paul Starkey



The use of small wheels (400-600mm diameter) allows cart platforms to extend over the wheels in a manner that is impracticable with large wheels (800-1800mm). Such a design provides a wide, but not too high, loading area and easy access from the sides, and thus greater convenience. Nevertheless small wheels are more likely to be obstructed by potholes and ruts than large wheels (Fig. 8-12).

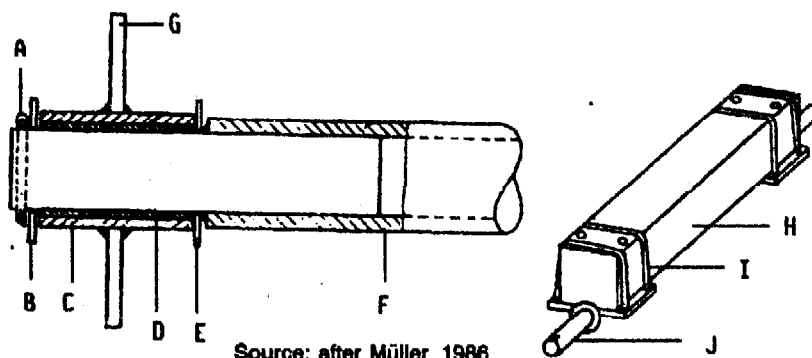
In many countries, a proportion of carts in use has been made from old car axles or from the entire rear section of light pick-up trucks. These are generally heavier than carts with purpose-built axles, but where the necessary scrap vehicles and skills are available, such carts can be very effective. The increasing popularity of front-wheel-drive cars means that lightweight differential-type axles are rare, but some pick-ups have suitable axles. The independent stub axles from the front or rear of a car can be welded onto a steel beam or attached to a wooden frame, but the necessary dismantling, refitting and correct alignment is not easy. There has been at least one example of a development project receiving container loads of assorted scrap axles from industrialized countries (Scheinman, 1986). If such importation is paid for by aid organizations, it may be considered an expedient temporary measure. However the real cost of such importation is likely to be high in comparison to the value of the product. Such funds might be better spent on developing more sustainable systems that would encourage some standardization of tyre and bearing sizes to facilitate the long-term provision of spare parts. In general the construction of

carts based on old axles can be regarded as useful, small-scale initiatives for entrepreneurs or small organizations. For larger organizations, particularly those in areas of high demand for carts, the restricted availability of scrap parts, their heavier weight and the quite modest cost savings, suggest that car axles and pick-up bodies should be regarded as supplementary rather than primary sources of animal-drawn carts.

8.5 Cart axles and bearings

Simple bush bearings made of cylinders of cast iron, hard wood or steel tube can be very effective, provided they are well prepared, appropriately lubricated and regularly maintained. The majority of the world's carts still use simple bush bearings. Many traditional wooden carts are based on a large wooden hub, rotating around a greased steel axle. In the centre of the hub may be inserted a replaceable bush bearing, with cast iron often being preferred to hard wood or steel tube. Such bearings are commonly associated with large-diameter wheels on which the hub rotates relatively slowly. Furthermore traditional wooden wheels have big hubs, allowing long bearings with a large surface area which, if well made and maintained, can last a long time (even if they do impose significant frictional loads). Such large-diameter wooden wheels with simple bush bearings are widely used in Asia and Latin America, and to a limited extent in North Africa and Madagascar, but are very rare in Sub-Saharan Africa.

Many metal wheels are also designed to rotate around a fixed steel axle, and the search for



Source: after Müller, 1986

Fig. 8-16:
Fixed axle with bush bearing
tested in Zambia.
A - Split pin; B - Washer;
C - Wheel hub;
D - Bearing (bronze, nylon or PVC);
E - Washer;
F - Stub axle; G - Spoke;
H - Wooden beam;
I - U-bolts; J - Stub axle.



Fig. 8-17: "Live" (i.e. rotating) stub axle with oil-soaked wooden bearings being evaluated in Zambia.

Photo: Paul Starkey

suitable bush-bearing materials has occupied the staff of many projects in Africa. Metal wheels are often of medium diameter so that the speed of rotation of the hub is faster than that of large, traditional cartwheels, and consequently the rate of wear of bearings is greater. In Tanzania some projects, such as that at Iringa, have tried to use oil-soaked wooden bushes as replaceable bearings. It was assumed that wooden bushes would be cheap and very easy to replace. In practice in the early years both new and replacement bushes rapidly disintegrated leaving very wobbly wheels. Furthermore the wooden bushes were not sufficiently uniform to be fitted easily into the wheel hubs. As a consequence farmers tended to tolerate worn bushes longer than they should, until the steel hubs of the wobbling wheels started wearing themselves. In Zambia comparable problems with locally produced hardwood bushes led to experimentation with other materials. PVC bushes were evaluated, but these were expensive and wore rapidly. Bronze bearings (made from locally mined copper) have also been tried in Zambia, and these have been found more durable than hardwood or PVC bearings.

It is a matter for debate as to whether bushes should be lubricated or left dry. If they are greased, sand and grit may mix with the grease to form a highly abrasive grinding paste. If left dry, there may be more noise and friction, but abrasive particles can escape as easily as they enter. Some woods, metals and synthetic ma-

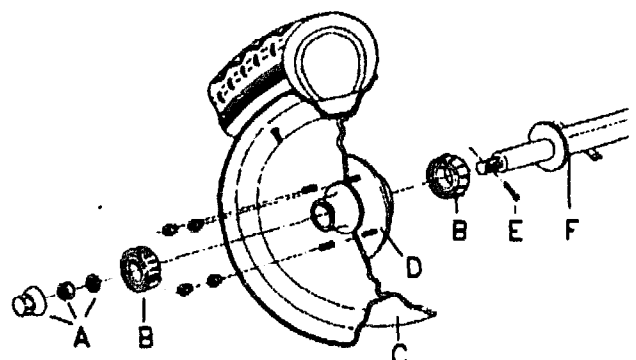
terials are "self-lubricating", slowly releasing natural or artificial lubricants as they wear. Mild steel does not have very good bearing characteristics, but it is readily available and easy to work. Although bush-bearings are a major source of frustration to projects and farmers,

with regular repair and maintenance they can be kept going for many years: in Ethiopia horse-pulled light carts dating back several decades are still in regular use, even though the original bearings have long-since been replaced by wheel centres made from steel pipes and bushes (where present) made from a range of local materials including rags.

A different approach to bearings, that has also been tried in Tanzania, Zambia and elsewhere, is the use of "live" (rotating) stub axles made of water pipe or old half-shafts from pick-ups and lorries. The axles are held in place by two bearings, each made of two oil-soaked blocks of wood, hollowed out to the shape of the axle and bolted together (ITDG, undated). Thrust washers are welded onto the axle, to restrict lateral movement. The bearing blocks are bolted onto the wooden chassis.

Fig. 8-18: Wheel and axle unit with roller bearing and pneumatic tyres, as widely used in West Africa.

- A. Dust cap, lock nut and washer.
- B. Tapered roller bearing. C. Wheel rim.
- D. Wheel hub. E. Split pin. F. Axle shaft.

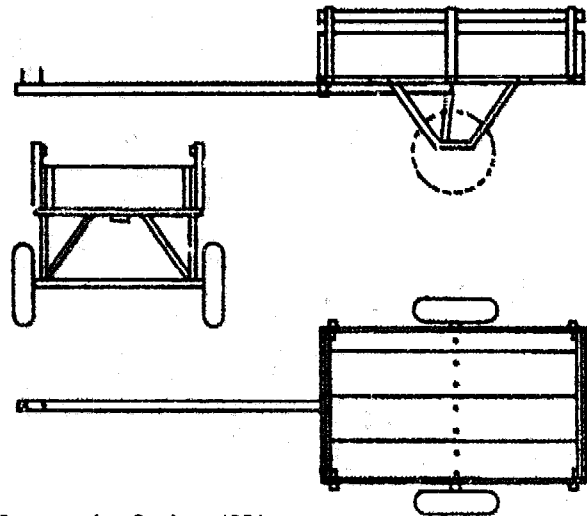


Source: after Matthews and Pullen, 1976

Carts with wooden block bearings are generally heavier to pull than other designs, due to the inherent friction and the weight of the cart. Bearing blocks have to be kept tightly clamped together and the relative simplicity of the design should not disguise the fact that axles will only run freely and truly if the bearing tolerances are correct. Carts with oil-soaked wooden bearing blocks have been introduced on a small scale by projects in many parts of Africa, but the carts are commonly criticised for their heavy weight.

Where the use of specially fabricated animal-drawn carts is common in Africa (Senegal and Mali each have over 100,000 in use), the preferred designs have been based on straight steel axles with machined ends to which are fitted wheel hubs with sealed rolling-element bearings. A simple steel cart frame is bolted onto the axle and a wooden or steel platform is fitted into this (Fig. 8-19). While such designs are not particularly cheap, they are usually long-lasting, with the only regular problem being tyre punctures. Roller bearings are also used in carts made from old car axles.

In conclusion development projects are often faced with the choice between expensive, high technology roller bearings, or various "appropriate technology" options. Many projects have spent a great deal of time and endured much frustration trying to perfect the simpler technology, but long-term maintenance prob-



Source: after Starkey, 1981

Fig. 8-19: Cart design of the type widely used in West Africa, being based on fixed solid steel axle, roller bearings and imported wheels and tyres.

lems have often been serious and adoption rates disappointing. Since transport is often very profitable, the higher cost of roller bearings that allow carts to be used very frequently, yet with little maintenance, may well be justified in the long term. With the benefit of hindsight it is apparent that several projects in Africa might have had more impact if they had provided credit to allow farmers to purchase higher-cost products, rather than employing people to try to develop low-cost alternatives.

8.6 Tyre punctures

Punctures are a major problem with animal-drawn carts with pneumatic tyres, and these have sometimes led to the total abandonment of an otherwise unspoiled cart. There seems no simple solution to this problem, which has recently been reviewed by Ayre and Smith (1987). Several

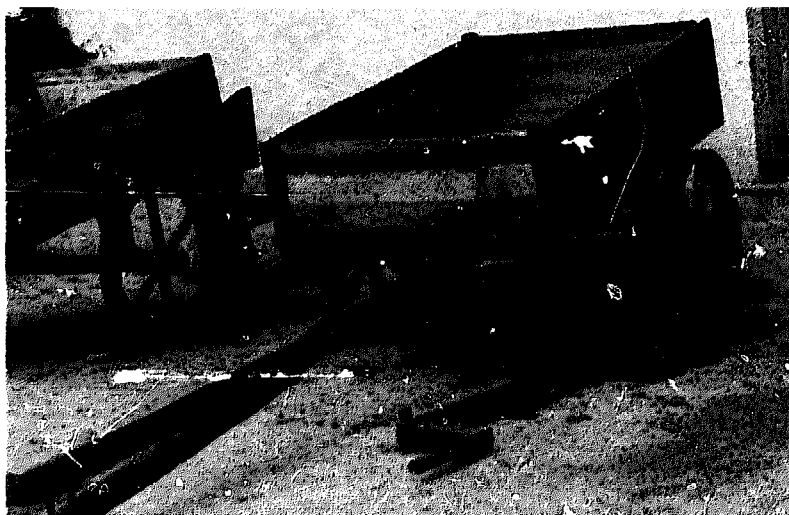


Fig. 8-20: Ox carts with steel wheels fabricated in the workshop of a development project in Tanzania. In foreground is an example of an arched axle assembly. Great difficulties were experienced with the bearings, oil-soaked wooden sleeves that fitted between the wheel hub and the stub axles.

Photo: Paul Starkey

years were spent on testing the efficiency of sawdust-filled tyres in Kenya (SFMP, 1984). In a standard car rim three extra holes were drilled, equally spaced in relation to the valve hole. A tyre, without an inner tube, was fitted to the rim and sawdust was inserted into the tyres through the four holes and compressed with a metal rod. Filling each tyre with sawdust took two people about four hours. The rim was sealed by hammering wooden pegs into the holes. Subsequently a local manufacturer developed purpose-built split-rims which made the filling process easier (Ayre and Smith, 1987). Although sawdust-filled tyres have been officially promoted, farmer adoption has been low. Sawdust-filled tyres are heavy, (particularly if water enters the tyre after immersion in a puddle), the sawdust rots if it becomes damp and the rolling resistance of the tyre is quite high.

Although puncture repair is often cited as a major constraint, it has also been widely ob-



Photo: Paul Starkey

Fig. 8-22: Low-cost axle unit developed in Kenya. The axle which comprised a split-rim wheel, sawdust-filled tyre, water-pipe axle and steel-washer thrust bearings intended for use with oil-soaked wooden bearings, has yet to be widely used.

Fig. 8-21: Two-wheel donkey cart in Mali. This type of cart is very common in West Africa. Provided the load is well balanced, donkeys can pull impressive loads along flat roads, but care has to be taken when mounting or descending road embankments.

Photo: Paul Starkey



served that once a reasonable number of pneumatic tyres (carts, bicycles, motorcycles or pick-ups) are in use in an area, entrepreneurial puncture repair services spring up in even quite small villages. Thus in areas of introduction, development projects might find it more productive to facilitate the adoption of "critical" numbers that justify local services in specific areas, rather than trying to spread their efforts thinly over a wide area.

8.7 Brakes, loads and assembly

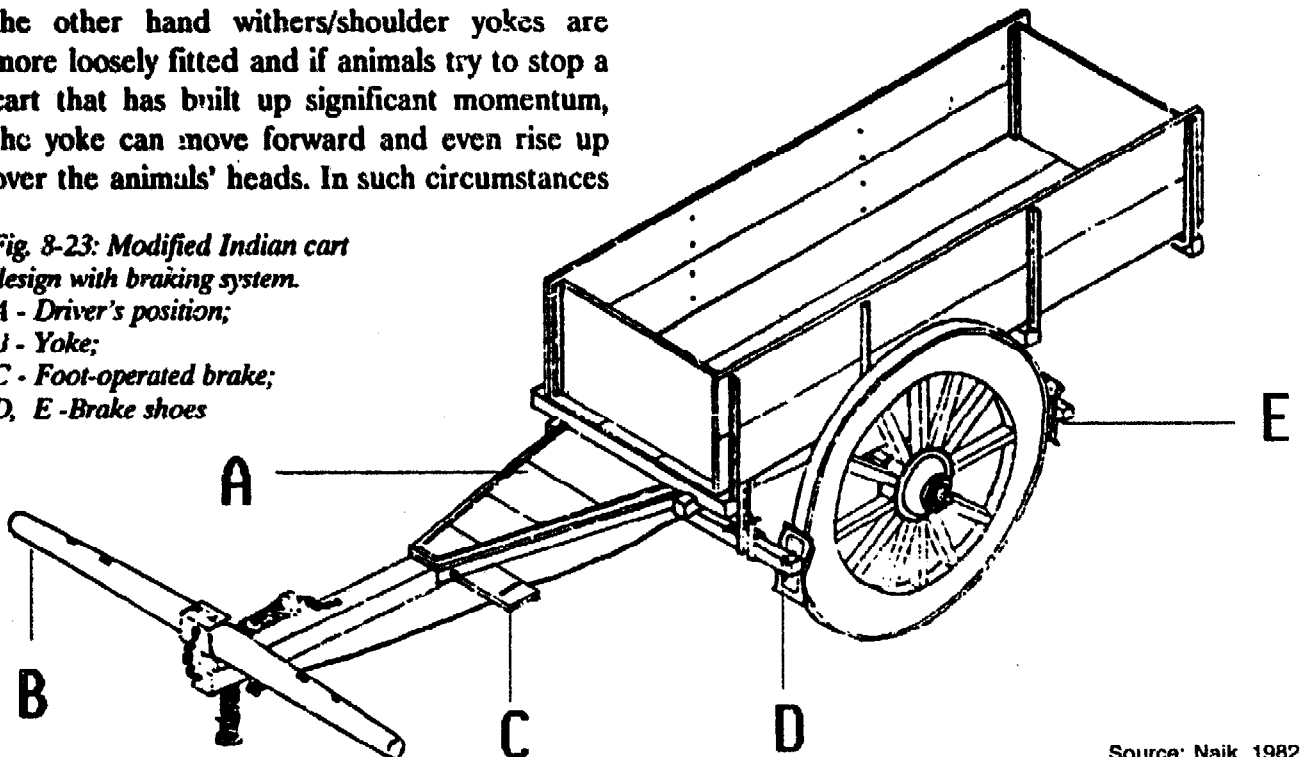
The fitting of brakes on carts is not common in flat areas, but may be desirable. Brakes are important to save the animals from discomfort where steep slopes are encountered. Such slopes may be major hills or simply the steep sides of a road embankment. Even on flat ground, a loaded cart pulled at normal speed has a considerable momentum, and absorbing this through the harnessing system on a downward slope can be very uncomfortable for the animals. The choice of harnessing system (chapter 3) can influence the efficiency with which animals can brake carts with their own bodies. Horn/head yokes are firmly attached to the animals and so facilitate braking. On the other hand withers/shoulder yokes are more loosely fitted and if animals try to stop a cart that has built up significant momentum, the yoke can move forward and even rise up over the animals' heads. In such circumstances

a breeching strap attached to the harness or drawbar is useful for transferring the braking load to the rear of the animal and away from the vulnerable neck or head. A bar fitted to the cart immediately behind the animals can have a comparable effect to a breeching strap, and such bars are commonly fitted to carts in India. Basic wheel brakes can be made from concave wooden blocks (or even just logs) that are pushed against the wheel or tyre surface. In the simplest case no fixings are necessary, although a lever mechanism can be arranged. Some manufactured wheels for carts come with internal brake shoes. Old car brakes can be quite easily adapted if mechanical parking-brake linkages (not simply hydraulic mechanisms) are available.

Most carts are designed to withstand loads of up to one tonne. The ability of animals to pull such loads will depend on the road surfaces and the inclines. An easy load to pull on a tarred road surface may be impossible to pull on a track with steeply sided holes or muddy ruts. Single donkeys can generally pull loads of 500kg, single horses can pull 700-1000kg, while pairs of oxen can pull one tonne, or more. Pairs of oxen of large Indian draft

Fig. 8-23: Modified Indian cart design with braking system.

*A - Driver's position;
B - Yoke;
C - Foot-operated brake;
D, E - Brake shoes*



Source: Naik, 1982

breeds are reported to be able to pull 1.5 tonne loads over 60km of rough roads in a day (Williamson and Payne, 1959). Balancing the load on two wheeled carts is important, as any imbalance will cause upward or downward forces on the animals' harnessing systems. A heavy load shifting backwards during use can cause a donkey to be literally lifted off its feet, with disastrous consequences.

Assembled carts are very expensive to transport over long distances, due to their great volume. For this reason, and to facilitate local construction and repair services, carts should be made, or assembled, as close to the point of use as practicable. Several African countries, including Burkina Faso, Mozambique and Togo, have adopted the system of supplying basic cart kits to rural centres. Simple kits may comprise two wheels, an axle and the struts that fix this axle to a wooden platform. Others may contain a complete steel frame in component form and even a steel drawbar. Some components may have to be imported (several countries import complete axle and wheel assemblies), while others may have been made in local workshops. Artisans, traders and/or small workshops assemble the kits and build on wooden platforms, and perhaps removable sides, for sale to the end-users.

8.8 Wheeled toolcarriers and four-wheel trailers

Wheeled toolcarriers have often been designed to be converted into carts, and many ended up being used only in the cart mode. However wheeled toolcarriers fitted with a cart platform have generally had high centres of gravity, making them liable to topple when encountering ruts. As noted in Chapter 9, farmers have found it more convenient to use purpose-built carts and separate cultivating implements. Such a combination can generally be obtained for the same price as a multipurpose wheeled toolcarrier (Starkey, 1988).

Four-wheeled carts, or trailers, are used for urban transport in many towns in Asia, and some in Africa and Latin America. They are also used on some estates and plantations. The four wheels support the whole load, so that animal power is only needed for forward movement. This allows heavy loads to be pulled, particularly if the road surface is smooth. Four-wheeled trailers can be left with loads in place even when the animals are not present (two-wheeled carts tip-up when left, although it is a useful practice to always carry pieces of wood to support the front and rear of the cart to prevent such tipping). While two-wheeled carts can pivot around the wheels during sharp turns, four-wheeled

*Fig. 8-24:
A cart-body on a
"Nikart" wheeled
toolcarrier in Mali.
The farmer found
his normal cart
more satisfactory
and stopped using
the toolcarrier
altogether.
Although
toolcarriers have
been used as carts,
they have seldom
been as good as
purpose-built carts.
Photo: Paul Starkey*



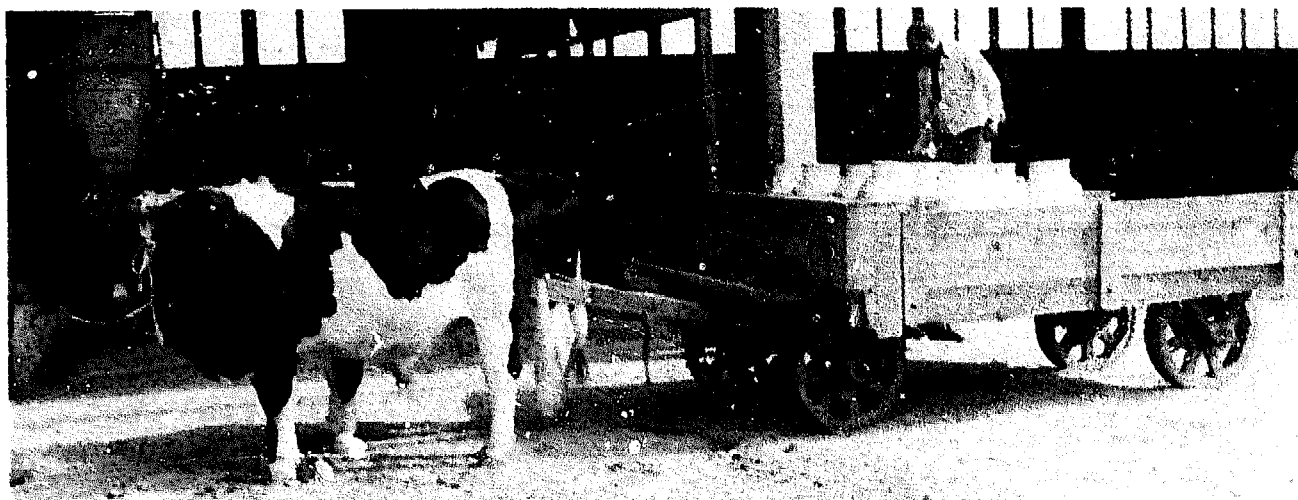


Photo: Paul Starkey

Fig. 8-25: A four-wheel trailer with wooden wheels being used with Friesian oxen at an agricultural research and training centre in Tanzania.

trailers need some form of articulation to ensure manoeuvrability, which makes the design of trailers significantly more complex than just adding a set of wheels to a two-wheeled cart. While two-wheeled carts are likely to increase rapidly in rural Africa, it is unlikely that four-wheeled trailers will become common.

8.9 Further sources of information

A useful illustrated discussion of the issues involved in the design and manufacture of animal-drawn carts has been produced by ILO and Intermediate Technology Publications (Barwell and Hathway, 1986). Filmstrips and booklets providing simple extension advice relating to the operation and maintenance of pneumatic-tyred carts are available from FAO (1983). An interesting review of attempts to develop animal-drawn carts in Zambia has been provided by Müller (1987). The GATE journal issue 1/89 of March 1989 had the theme of low-cost transport and contained articles relating to animal-drawn transport.

There is much information available on traditional and more recent designs of animal-drawn carts in India. The subject was dis-

cussed by Ramaswamy (1979) who subsequently produced a detailed, illustrated publication recording many of the traditional cart designs in use in India (Ramaswamy, 1985). An annotated bibliography, containing over 300 citations relating to animal-drawn vehicles drawn from both Indian and international publications was prepared by Deshpande and Ojha (1983). The same authors have prepared an illustrated monograph on traditional and improved bullock carts (Deshpande and Ojha, 1984).

Staff of CTVM at Edinburgh University have a research interest in the employment of donkeys, mules and horses in developing countries, and an initial brief report on the use of donkeys for pack transport was provided by Fielding (1988). The existence of an American Pack Animal Study group was mentioned by Iversen (1987).

Many projects in Africa have activities relating to animal-drawn carts and some of these are listed in GATE Animal Traction Directory: Africa (Starkey, 1988). Organizations outside Africa working on animal-drawn cart technology include Intermediate Technology Transport in UK.

9. Less conventional equipment

9.1 Introduction

This chapter deals with animal-drawn equipment that is not commonly used by small farmers. The restricted use may be because:

- the application is highly specialized;
- the technology is quite new and has not yet had a chance to diffuse;
- the equipment is economically, socially or technically inappropriate for small farms.

Some other books have included examples of such equipment within the context of a general presentation. This has some merit in illustrating a broad continuum of equipment applications and designs, but has unfortunately also given an unjustified impression of widespread acceptance or use. In this book it is intended that these less common technologies be thought of separately, with the clear understanding that such equipment may pose particular problems if introduced without careful planning. In the following pages the

technologies themselves will be discussed quite briefly, but sources of further information will be cited. In this way it is hoped to sound a note of caution, while allowing people interested in developing such technologies to constructively build on previous experiences.

9.2 Wheeled toolcarriers

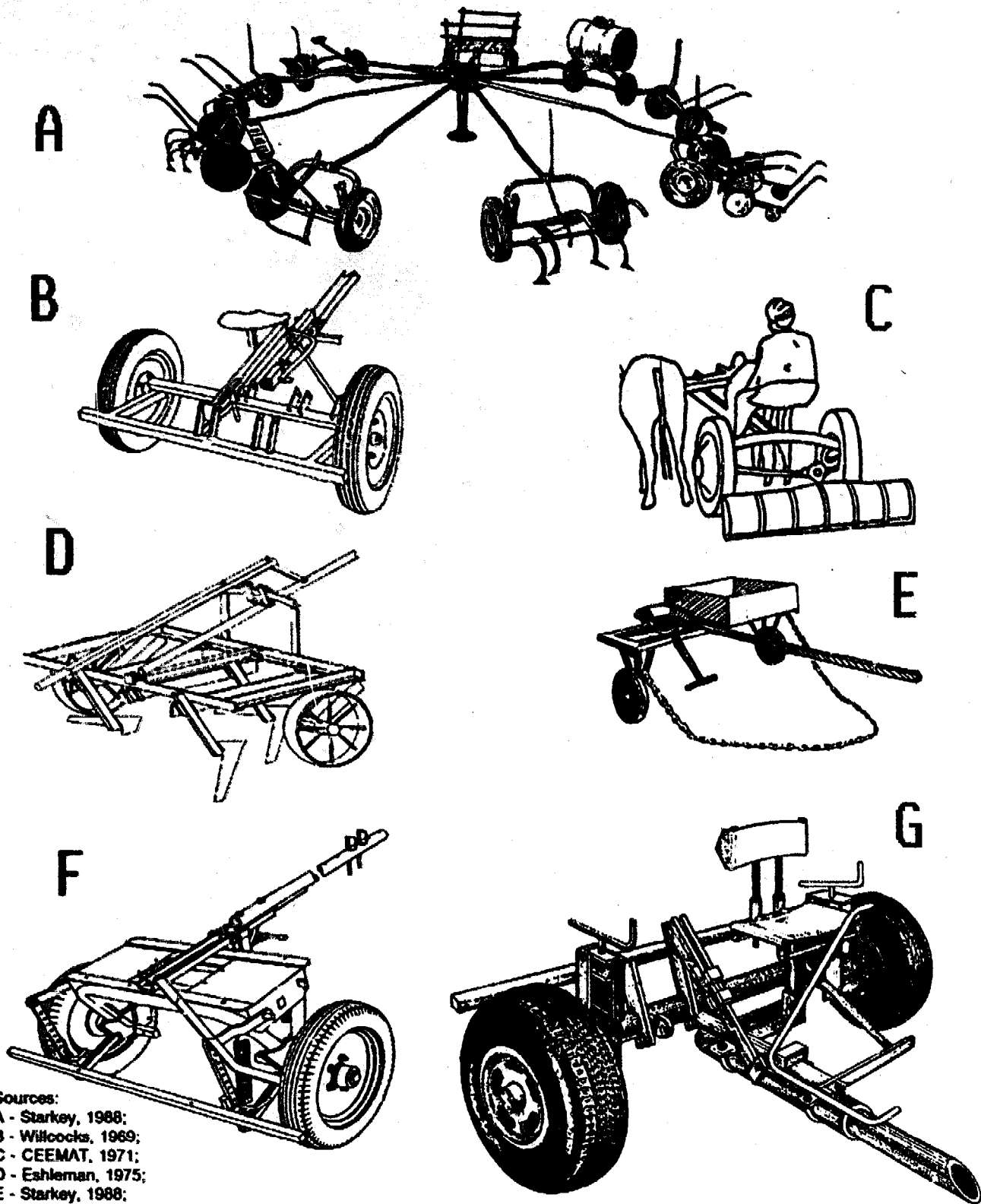
Animal-drawn wheeled toolcarriers are multi-purpose implements that can be used for plowing, seeding, weeding and transport. They are usually ride-on implements, and are often thought of as "bullock-tractors". This image makes them very attractive to politicians and donor agencies. At least fifty designs of wheeled toolcarrier of varying degrees of complexity were developed in various countries from 1955 to 1987.

Most wheeled toolcarriers comprise a steel chassis and drawbar mounted on two wheels,

Fig. 9-1: "Nikari" type wheeled toolcarrier with double furrow plow being evaluated by a farmer in Mali in 1986. The farmer saw advantages in the toolcarrier, but the following year it was left unused.

Photo: Bart de Steenhuisen Piters





- Sources:
 A - Starkey, 1988;
 B - Willcocks, 1969;
 C - CEEMAT, 1971;
 D - Eshleman, 1975;
 E - Starkey, 1988;
 F - ICRISAT, 1985;
 G - Sims et al, 1985.

Fig. 9-2: Some wheeled toolcarriers.

A - Polyculteur, developed by Jean Nolle in Senegal 1955-60 (a display of nine with different attachments); B - National Institute of Agricultural Engineering (NIAE) animal-drawn toolbar, developed in UK, 1959-68; C - Nair toolcarrier, developed in India, 1960-63; D - Mochudi toolcarrier, developed in Botswana, 1973-79; E - Lioness toolcarrier, developed in UK, 1982-83; F - Tropicultor, developed by Jean Nolle in Madagascar and France, 1962, and at ICRISAT in India, 1975-87; G - Yunicultor, based on Nikart design developed in India by ICRISAT and AFRC-Engineering, 1978-1986, and further developed in Mexico, 1982-1987.

often with pneumatic tyres from cars. The chassis supports a toolbar which can be raised and lowered. Onto the toolbar clamp a wide range of implements, such as plows, harrowing tines or ridging bodies. There is generally an operator's seat, and most have a detachable cart body.

A pioneering design was developed in Senegal by the French agricultural engineer Jean Nolle in 1955 (Nolle, 1986). Nolle's most famous designs were the *Polyculteur* and the *Tropicultor* which have been tested in at least 25 countries. In 1960 the British National Institute of Agricultural Engineering (NIAE) in UK tested its own prototype design in East Africa, and derivatives of these were sent to at least 20 countries (Willcocks, 1969). More recently from 1974 to 1986 the International Crops Research Institute for the Semi-Arid Tropics (ICRISAT) started a major programme of research involving the use of wheeled toolcarriers in a crop cultivation system based on broadbeds. This resulted in the enhancement of the *Tropicultor* and also the development of a new design of wheeled toolcarrier, known in India as the *Nikart* (Bansal and Thierstein, 1982; ICRISAT, 1983; Kemp, 1983 and 1987).

The history of wheeled toolcarrier development has recently been reviewed in detail by Starkey (1988). He concluded that while about 10,000 toolcarriers had been manufactured between 1956 and 1986, the number that were ever used by farmers as multipurpose implements for several years was *negligible*. The majority were either abandoned or used as very expensive carts which, because of multipurpose design constraints, were actually less efficient than purpose-built carts. Wheeled toolcarriers have been rejected because of their high cost, heavy weight, lack of manoeuvrability, inconvenience in operation, complication of adjustment and difficulty in changing between modes. By combining many operations into one machine they have increased risk and reduced flexibility compared

with a range of single-purpose implements. Their design has been a compromise between the many different requirements. In many cases for a similar (or lower) cost farmers could use single-purpose plows, seeders, multipurpose cultivators and carts to achieve similar (or better) results with greater convenience and with less risk.

Starkey (1988) argued that farmer rejection had been apparent since the early 1960s, yet as recently as 1986 most people working in aid agencies, international centres and national agricultural programmes were under the *impression* that wheeled toolcarriers had been widely adopted in some countries. These impressions derived from the circulation of numerous encouraging and highly optimistic reports. All wheeled toolcarriers developed have been proven competent and often very effective, providing excellent precision in operations under the optimal conditions of research stations. Most published reports derive from such experience. Published economic models have shown that the use of such implements is theoretically profitable, given many optimal assumptions relating to farm size and utilization patterns. In contrast there have been virtually no publications available describing the actual problems experienced by farmers under conditions of environmental and economic reality.

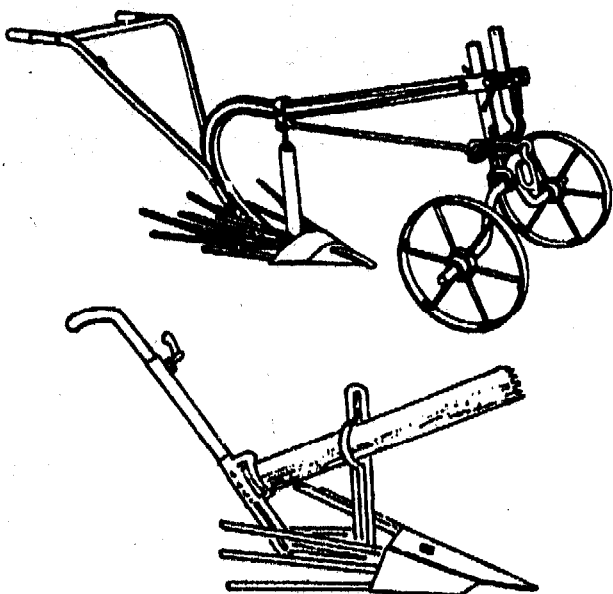
The concept of wheeled toolcarriers is clearly attractive and several technically competent designs are available. Nevertheless Starkey (1988) concluded that prospects for such implements within existing farming systems in Africa, Asia and Latin America seem poor. Organizations wishing to evaluate or redesign wheeled toolcarriers would do well to review in some detail the experience of previous schemes. Details of many of these are provided in the book on the subject by Starkey (1988) and the addresses of some organizations in Africa that have evaluated this technology can be found in the GATE Animal Traction Directory: Africa (Starkey, 1988).

9.3 Harvesting equipment

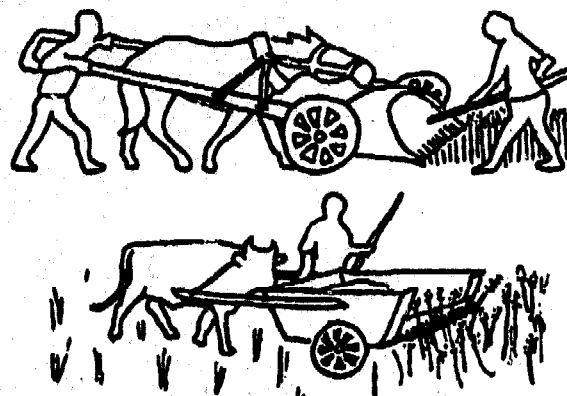
Animal-drawn groundnut lifters were discussed in an earlier chapter (section 7.8). Such implements are quite widely used, some being single-purpose tools, while others are attachments to simple multipurpose toolbars.

Root lifters are not common in the tropics. Cassava is not well adapted to lifting with animal power since it is a woody and deep-rooted crop that is often harvested when the soil is hard. The draft requirement for a lifting blade to pass under the roots in such circumstances would be very high. The cutting back of the plant to allow animal lifting would reduce the potential to make use of the long stems for manual raising of stubborn roots. Yams are usually grown in areas where few draft animals are used. Trials have been undertaken in Côte d'Ivoire on growing small varieties of yams in ridges and lifting yams using animal power, but problems were experienced in combining effective crop cultivation practices, socially acceptable varieties and ease of lifting (Bigot *et al.*, 1983). Potatoes grown on ridges are more amenable to lifting equipment and

Fig. 9-3: Potato lifters.
Top: Long-standing European design.
Bottom: Prototype developed for Peru.



Sources: CEEMAT, 1971; Herrandina, 1987



Source: Gill, 1977

Fig. 9-4: Ancient designs of animal-pushed reapers.

several commercially produced designs of animal-drawn lifters are available from China, India, Morocco, Poland, and UK (JTP, 1985).

Animal-powered equipment for harvesting cereals has been available for a long time. There are reports of "Gallo-Roman" reaping machines which were animal-pushed, two-wheeled carts, with an adjustable comb and blade at the front. As the reaper was pushed through the grain field, the heads of the crop would be broken off, and fall into the cart, leaving much of the straw standing in the field. Since no examples of this technology remain in existence, it is difficult to judge the problems of clogging and wastage that would have occurred with such an implement (Smith, 1979; Gill, 1977). Derivatives of such designs were used in the UK in the eighteenth century but were considered only suited to flat areas where there was excess straw (Smith, 1979). More complicated animal-drawn grass mowers and reapers for small-strawed cereals, such as wheat and barley, were developed to a high degree in Europe and North America between about 1840 and 1930. They required both high draft power and reasonable speed, and so were generally used with strong horses rather than oxen (Binswanger, 1984). During much of this time motorized harvesting was not a realistic option.

Some illustrations and details of horse-drawn harvesting machinery were provided by

Sources: after
Viebig, 1982,
Devnani, 1980
Nolle, 1986

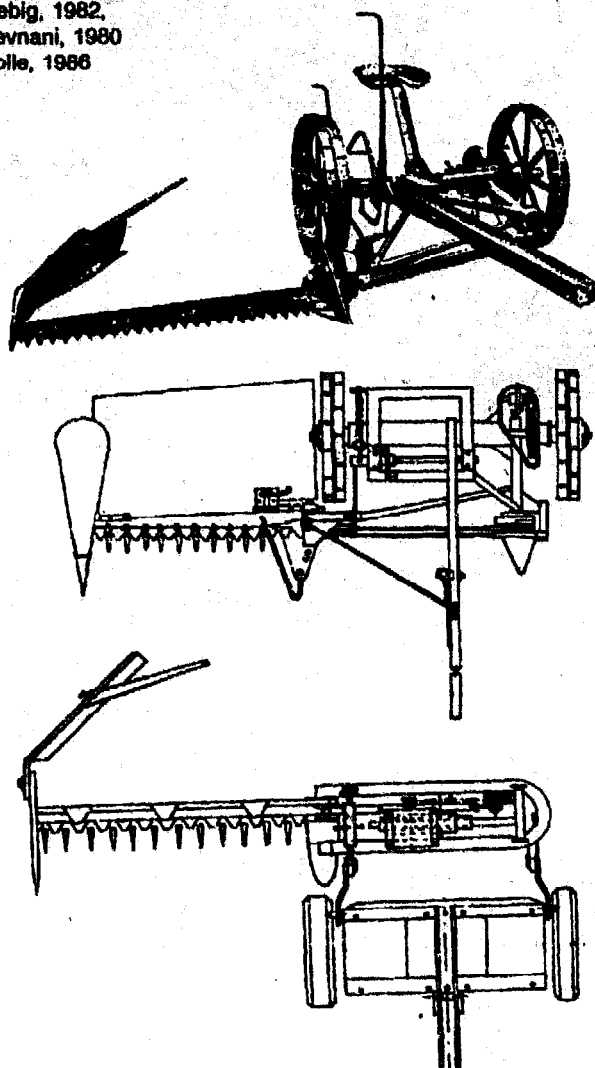


Fig. 9-5: Animal-drawn mowers.

Top: Long-standing European design.

Middle: Prototype designed in Punjab, India.

Below: Mower developed for use with a Tropicultor wheeled toolcarrier: the mower blades are driven by a small petrol engine mounted behind the toolcarrier.

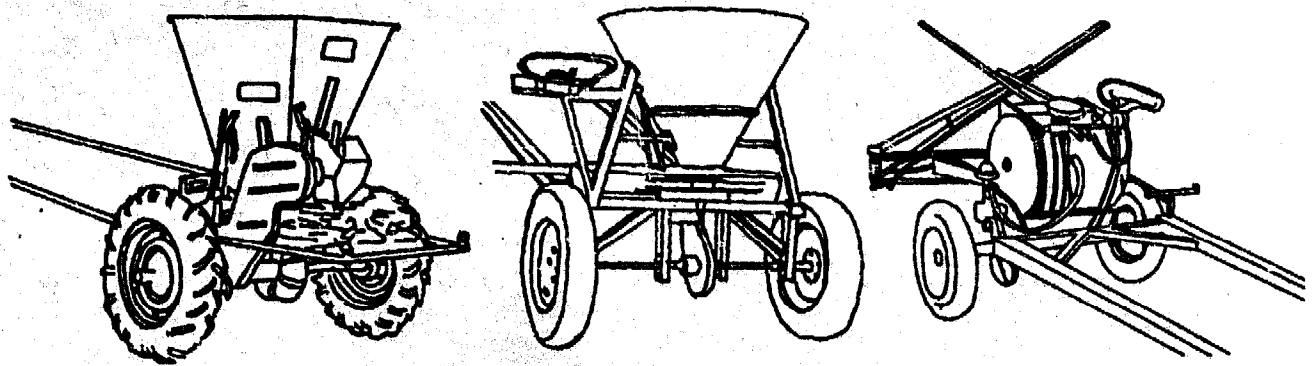
CEEMAT (1971), FAO/CEEMAT (1972) and Viebig (1982). However despite some trials with such equipment in the tropics, there are virtually no records of their use in developing countries, where cattle provide most of the farm power and many rainfed cereals (sorghum, maize, millet) have large stems. The main reasons for their lack of acceptability appear to be:

- their high cost, which is unlikely to be justified from the profits of one small farm,

- their complexity which necessitates considerable investment in training time,
- the fact that they are easily damaged by stumps and ground obstructions, making them only suitable for use in well cleared land,
- their heavy weight and requirement for both power and speed.

Those conditions that might be favourable for animal-drawn harvesting equipment (for example where farm income is high, technical knowledge is available and land is well cleared) may also be suitable for motorized harvesting equipment. Similarly those circumstances that might favour communal ownership or entrepreneurial hiring of animal-drawn harvesting equipment, are also likely to favour motorized alternatives. This should not be taken to imply that no animal-drawn harvesting equipment will ever be appropriate in developing countries, but enthusiasts for European or North American horse-drawn implements should not expect to be able to easily transpose such designs into the small-holder farming systems of Africa.

There have been cases of animal drawn carts or toolcarriers fitted with motorized mowers (Nolle, 1986). These have had the advantage of requiring only a small motor for the mower as the power for transport was provided by the animals. The relative cost of small petrol engines has been falling in recent years, but the problems of developing countries obtaining foreign exchange to purchase them have increased. More significantly mowing is not a common operation in the tropics, where hay and silage production is difficult and where many pastures have thick grasses. To date the use of such equipment appears to have been confined to research stations where they may simplify experimental work on forage production. While there is little hard information for or against such implements at farm level, they may well represent another example of a research idea that has not been found appropriate to the needs of small farmers.



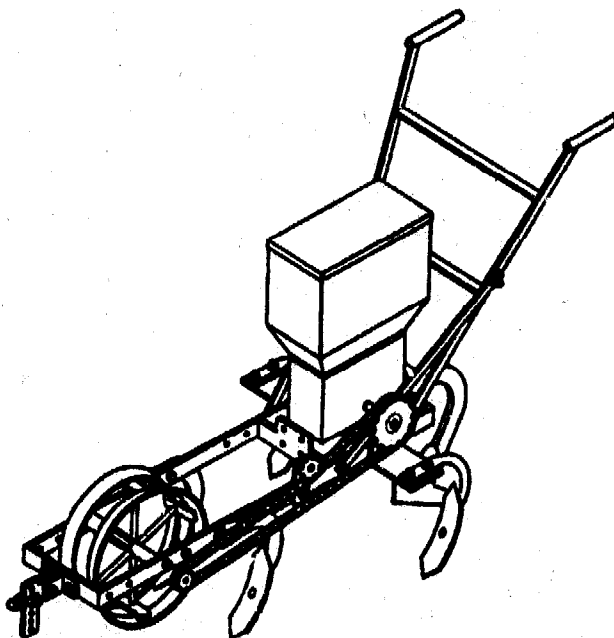
Source: ITP, 1985

Fig. 9-6: Commercially available animal-drawn fertilizer applicators and a crop sprayer: a large area of crops would have to be treated to justify the investment in such implements.

9.4 Fertilizer applicators

Most chemical fertilizers on small farms in the tropics are applied by hand (Hopfen, 1969). Single-purpose animal-drawn fertilizer applicators are not common, although they are commercially available and were used in Europe and North America earlier in this century (ITDG, 1985). Reasons for their limited use in developing countries include low levels of chemical fertilizer application

Fig. 9-7. A combined top-dressing fertilizer applicator and weeder developed experimentally in Botswana. Based on the chassis of a seeder, the fertilizer unit can also be mounted with the seeder unit to make a combined planter-fertilizer applicator.



Source: ILO, 1983g

and the relative ease of broadcasting fertilizer by hand. It is also likely to be associated with the limited adoption of precision planting to facilitate accurate fertilizer placement in rows, and also the economies of fertilizer use that can be obtained through application to individual plants or stands.

Quite complex dual-purpose combined seeders and fertilizer applicators have been developed in many countries but adoption rates have been low (Munzinger, 1985). This may be associated with their high cost and complexity and the relative ease of performing operations by hand. On-station trials have usually demonstrated the benefits of such implements under optimal conditions. Farmers have often had problems in maintaining correct seed and fertilizer placement under the less uniform and more rigorous conditions of their own fields. One problem relates to the hygroscopic nature of many fertilizers. This causes the granules to become sticky as they absorb water from the atmosphere, making metering mechanisms inefficient. Related to this is the very rapid corrosion of metal implements used for fertilizer distribution.

In contrast to the expensive precision implements, some very simple units have been developed in India, comprising small wooden bowls with PVC tubes that connect to simple share openers. The seeds or fertilizers are hand metered by dropping appropriate quan-



Photo: ICRISAT archives

Fig. 9-8: A Tropicultor wheeled toolcarrier being used for combined weeding and fertilizer application on the ICRISAT research station. The fertilizer is hand-metered and passes down plastic tubes to hollow tines.

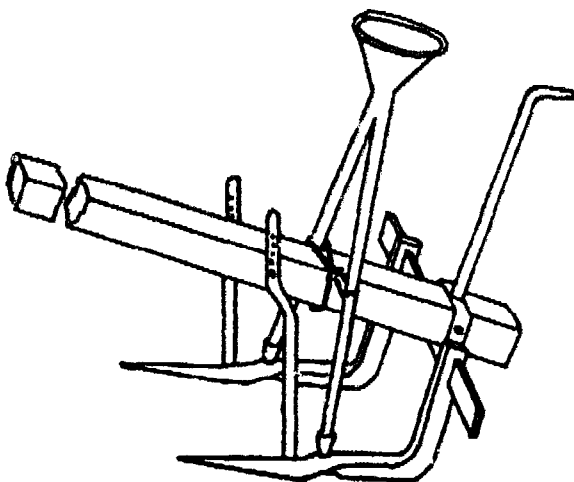


Fig. 9-9: Simple hand-metered tube distribution mechanism on an Indian 2-row "Duphan" seeder which can be adapted for fertilizer placement.

Source: Gite and Patra, 1981

ties into the bowl. Such units may be connected to existing plows for combined seeding and fertilizer placement, or to weeders for fertilizer placement during weeding (Fig. 9-8).

It is not the intention to discourage work relating to animal-drawn implements for fertilizer placement, for the benefits of accurate and timely fertilizer placement are well known. Nevertheless enthusiastic agricultural engineers in at least 20 different African states and many more countries worldwide have already invested much time in developing their own prototype seeder-fertilizer applicators, with minimal uptake of their labours. This repetition of similar experiences is wasteful of resources and suggests that *ad hoc* work on implement design itself is not sufficient to make an impact in this particular area.



Photo: AFRC-Engineering archives

Fig. 9-10: Ridge-tying on a research station in The Gambia.

9.5 Ridge-tiers

Joining ridges to form a grid of mounds and hollows can assist in soil and water conservation particularly in those semi-arid regions that have 400-700 mm of annual rainfall. Large yield effects attributable to tied-ridging have been demonstrated on research stations.

Several designs of animal-drawn ridge-tiers have been developed, but to date there seems little evidence of farmer adoption. Simple designs developed and tested in Nigeria in the 1960s (Stokes, 1963: ITDG, undated) and The Gambia in the 1970s (Matthews and Pullen, 1974) scraped the hollows between ridges and had to be lifted every few metres over the accumulated soil to obtain the ridge-tie. This was hard work for the farmer and animals, and few farmers appeared convinced that the benefits justified this effort. More recently two prototype animal-drawn



Fig. 9-11: An operator lifts a ridge-tying implement and so forms a ridge-tie. The "Unibar" multipurpose toolbar fitted with the ridge-tier was being tested on a research station in The Gambia.

Photo: AFRC-Engineering archives

Source: Wright and Rodriguez, 1986

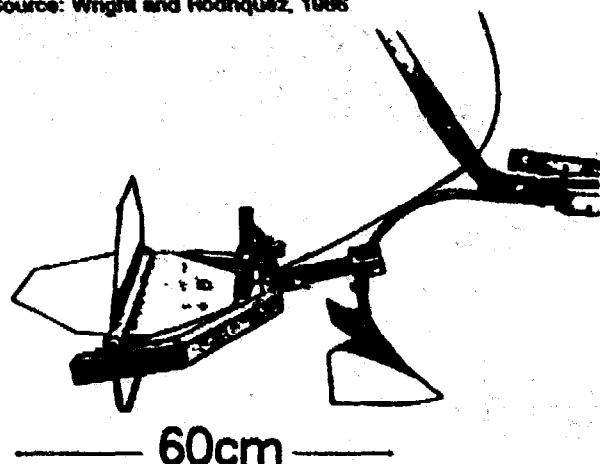


Fig. 9-12: Prototype ridge-tying attachment developed by SAFGRAD/IITA in Burkina Faso. A cycle cable is used to trip the ridge-tier to enable it to rotate.

ridge-tiers have been developed in Burkina Faso. One developed by ICRISAT researchers is based on a ridger with a large eccentric ground wheel that changes the working depth cyclically and so creates very gradual ties; the other developed by researchers from IITA and SAFGRAD has four blades arranged at right angles, and the operator trips the blade to allow it to rotate by 90° , so depositing the soil and forming a ridge (Wright and Rodriguez, 1986). A ridge-tier has also been developed by CPATSA, EMPRAPA and CEEMAT in Brazil, as an option for the CEMAG Policultor wheeled toolcarrier (Duret *et al.*, 1986).

It should be stressed that while researchers are optimistic about animal-drawn ridge-tiers, no implement design has yet passed the test of farmer adoption. Further information on current research can be obtained from ICRISAT and SAFGRAD in Burkina Faso.

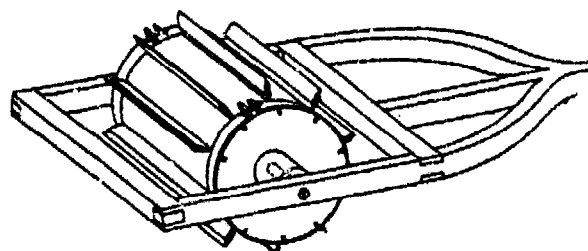
9.6 Weeder rollers

The use of large, heavy rollers fitted with cutting blades has been tested by GTZ-supported projects in Tanzania and Cameroon (Becker, 1987; IAD, 1987). The rollers are 60-100 cm wide and are fitted with rotating steel frames supporting 6-12 knives (Fig 9.13). As the rollers are pulled along the rotating knives cut up

grasses, small shrubs and surface trash leaving a mulch of chopped vegetation. Weight estimates for the implements range from a low 80 kg, reported for an eight-blade model in Cameroon (IAD, 1987) to a high 450 kg for a 10-blade prototype in Tanzania (Becker, 1987). In preliminary trials in Cameroon and Tanzania such rollers were used for clearing stover and weeds from fields prior to cultivation. Reported work rates are in the region of 5-6 team-days per hectare (based on a 4-5 hour working day), while to achieve similar clearance would require 27-30 person-days. The weeders have been found particularly useful for weed suppression within orchards and under tree plantations and there are suggestions that the rollers might be usefully employed in alley cropping systems.

In early 1989 these implements were still at an early stage of development, although small-scale production had started in Cameroon. It is too early to say whether weeder rollers will be adopted but one can conjecture possible constraints to eventual farmer adoption. High implement cost combined with limited annual use may well make it difficult for small farmers to justify buying such equipment. Alternatives to individual purchases, such as entrepreneurial hire schemes or group ownership, have often been suggested as means of disseminating expensive animal traction implements, but in practice few such schemes have ever developed. Farmers may be discouraged by the implements' heavy weight, poor manoeuvrability within their fields and plantations and the difficulties in transporting

Fig. 9-13: Prototype weeder-roller with wooden frame (concept).



Source: Becker, 1987

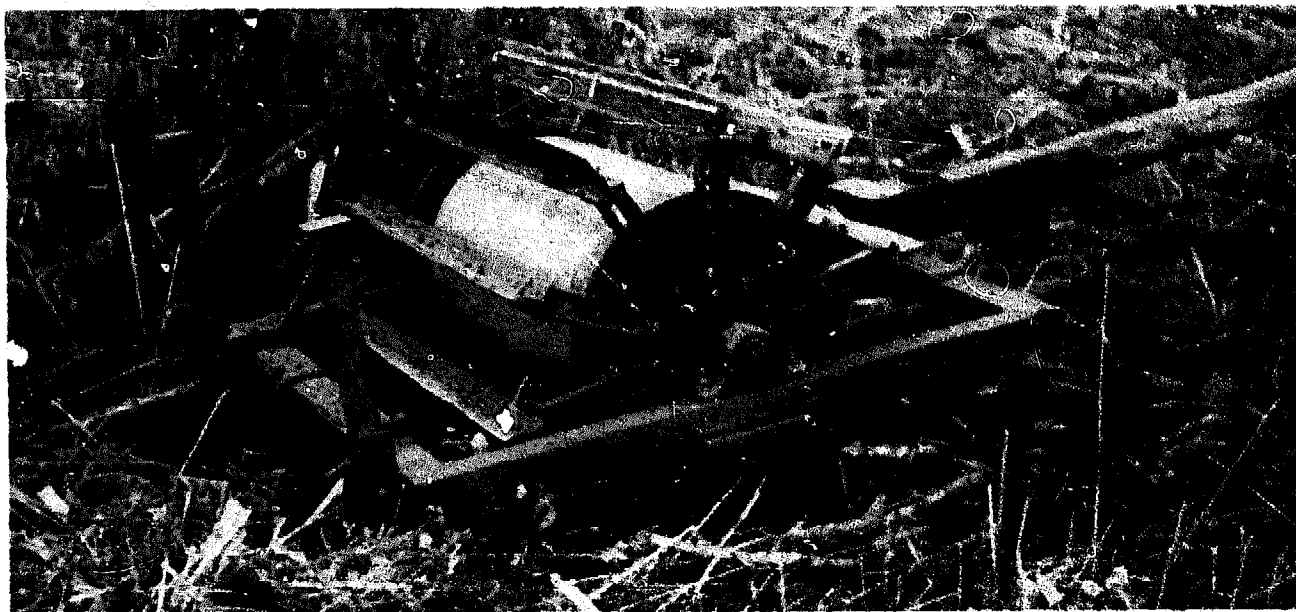


Photo: Henner Becker

Fig. 9-14: Prototype weeder roller with steel frame developed in Tanzania.

such units between different fields. Their use for control of thick grass and light bush could pose a threat to the health of the animals that have to walk through the brush ahead of the roller since lignified grass stalks and shrubs could puncture the animals' skin or eyes. In normal use the frame surrounding the rolling blades should prevent human feet from accidentally being cut, although caution would be always be required during manoeuvring.

Reports of initial trials have expressed considerable optimism for the potential for these weeding rollers, which are to be further evaluated in Brazil, Cameroon, Ghana and Tanzania in conjunction with GTZ and the University of Giessen. However at the time of writing this equipment had not been proved by farmer adoption, and persons interested in

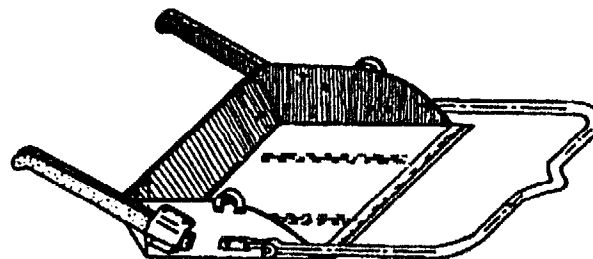
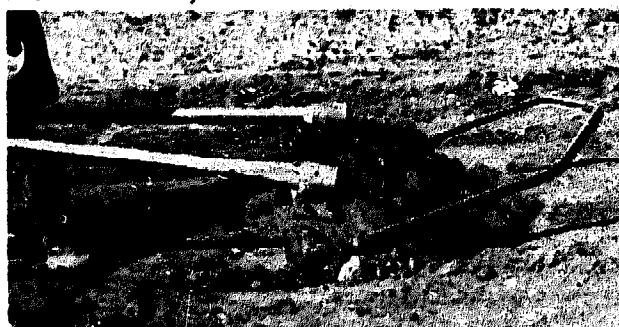
this technology should obtain updated information before following up these ideas. It will be particularly important to learn whether farmers perceive such implements to be technically appropriate and economically affordable in their specific farming systems. Further information can be obtained from GTZ, Germany, TIRDEP, Tanzania and PAFSAT, Cameroon (for addresses see Appendix and GATE Animal Traction Directory).

9.7 Land formation equipment

Animal-drawn scoops for levelling fields or for "water harvesting" have been used in Africa and elsewhere for many years (Hopfen, 1960). Scoops are made from sheet steel to which are attached two steering handles and a movable U-shaped steel drawbar (Fig. 9-15).

Fig. 9-15: Earth-moving scoops used for land formation, pond construction and water harvesting. Left: Scoop used by ILCA, Ethiopia. Right: Scoop from India.

Photo: Paul Starkey



Source: Pathak, 1984

Source: Pathak, 1984

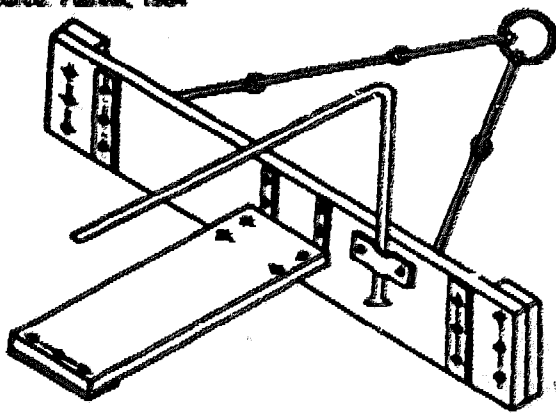


Fig. 9-16: Ride-on levelling board or "buck scraper".

Unless the soil is very light and sandy, it has to be first loosened by plowing or tine cultivation. Recently such scoops have been used with donkeys in Kenya for waterharvesting (ITDG, 1985) and in Ethiopia for pond excavation using oxen. In Ethiopia ox-teams can remove about 8-10 m³ per day (Abiye Asatke, Bunning and Anderson, 1986). Although scoops are robust, they are relatively expensive and require considerable draft

Source: after GEEMAT, 1971

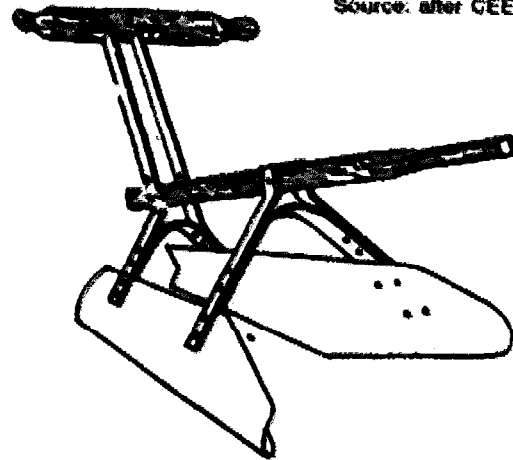


Fig. 9-17: Wooden bund former.

power. For this reason they are often used in communal schemes.

Simple ride-on boards or logs are widely used for levelling fields between plowing and planting, particularly fields that are to be irrigated. Animal-drawn bund forming implements have long been used in Asia to prepare small contour ridges in irrigated fields (Hopfen, 1969). Models based on two boards in the shape of a

Fig. 9-18: Levelling with a wooden earth-moving scoop in Egypt.

Photo: Paul Starkey





Photo: ILCA Highlands Programme

Fig. 9-19: A GOM wheeled toolcarrier ("Nikart" type) with ridgers and levelling board being evaluated on an ILCA research station in Ethiopia. It was considered too expensive for forming broad-beds in local farming systems, and so emphasis was placed on modifying the maresha ard to form comparable broad-beds.

"V" have been tested in Africa, but are not widely used except in Madagascar. Lack of uptake may be associated with limited use of draft animals for irrigated crop production in Africa, the heavy draft of the implements, and the fact that ridges made with bund-formers have little persistence in storms.

A combination of conventional mouldboard plows, ridgers, harrows and levellers can be used for terrace formation, bund-formation and other types of land shaping for soil and water conservation. Research by ICRI-SAT in India and ILCA in Ethiopia has indicated that large flat ridges (broad-beds) can greatly improve the drainage of heavy black soils (Vertisols), providing higher and/or more reliable yields in on-farm trials. ICRI-SAT developed sys-

tems of broad-bed cultivation using wheeled toolcarriers, but although experimental results were encouraging (Ryan and von Oppen, 1983), farmer adoption was minimal (Starkey, 1988). In Ethiopia, ILCA briefly evaluated wheeled toolcarriers but decided to modify existing local implements for land-forming operations. Jutzi, Anderson and Astatke

Fig. 9-20: Mouldboard added experimentally to a traditional Ethiopian maresha ard to allow the formation of terraces and broad-beds.

Photo: Paul Starkey



Source: ILCA, 1988

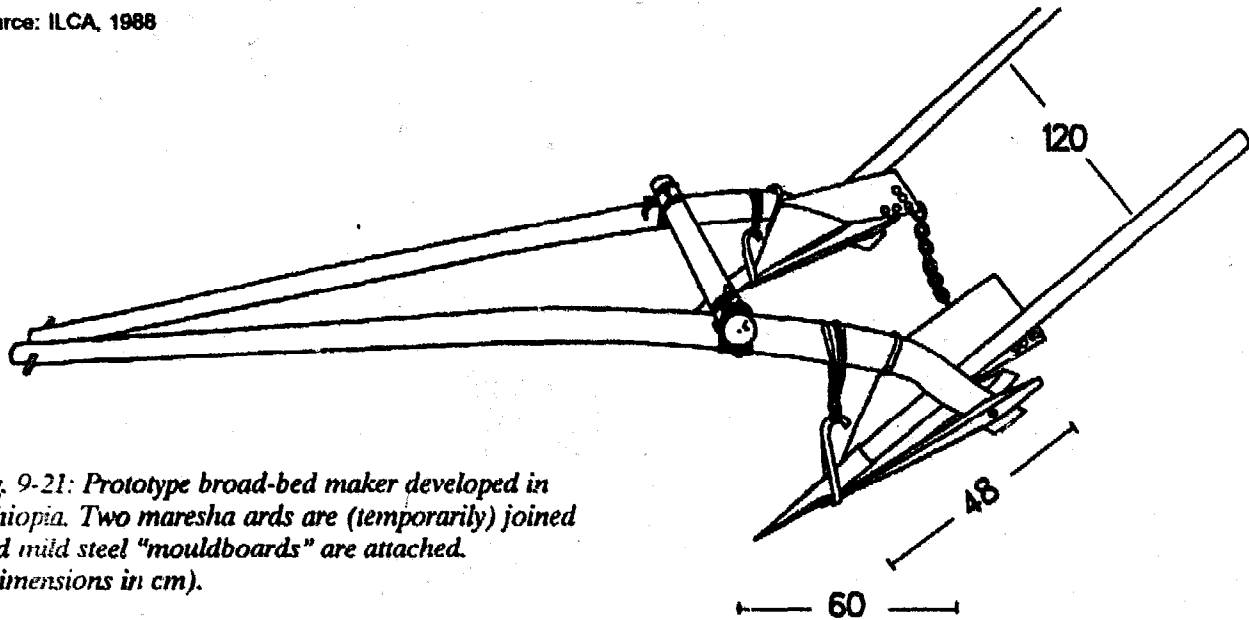


Fig. 9-21: Prototype broad-bed maker developed in Ethiopia. Two maresha ards are (temporarily) joined and mild steel "mouldboards" are attached. (Dimensions in cm).

(1986, 1988) described the development of modified *maresha* ards in Ethiopia for use in terrace construction and broad-bed formation. Initially two ards were used to construct a new broad-bed former, but this was difficult to transport and the ards used to make a broad-bed former could not then be used for normal plowing. A new design was therefore developed in which two ards are only temporarily joined to form a single implement (ILCA, 1988; Fig. 9-21). Simple steel mould-

boards are attached to the ards to facilitate the formation of bunds and broad-beds. The work, which is being carried out by ILCA, the Ethiopian Ministry of Agriculture and local farmers is still at an early stage, and it is too early to judge whether the technology will become widely adopted. On the positive side the broad-bed maker requires only local materials and existing skills. Initial agronomic results are favourable and suggest that even with minimal inputs, the broad-bed and fur-

Fig. 9-22: Levelling a plowed field in Egypt prior to irrigation and planting. The simple ride-on leveller is made from a log of wood.

Photo: Paul Starkey





Photo: Paul Starkey

Fig. 9-23: A cow turns a sakia water wheel to irrigate crops in Egypt. Many thousands of such devices are used to raise water from shallow wells and irrigation canals.

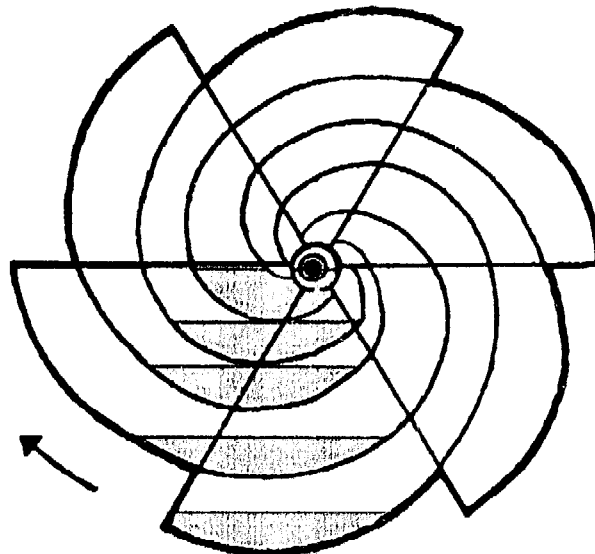
row technique provides more reliable harvests than traditional systems. On the negative side, the broad-bed maker requires more time to set up and has a greater draft during operation than the unmodified *maresha* and is less manoeuvrable on the field. Some research is being undertaken on simple seeders, blade-weeders and fertilizer distributors that can be fitted to the broad-bed makers. However in early 1989 such designs were still at a prototype stage, and it is by no means certain that the *maresha* broad-bed maker will be developed into a multipurpose implement analogous to the wheeled toolcarrier. Further information on the modified *maresha* and the broad-bed maker can be obtained from ILCA, Addis Ababa.

9.8 Water-raising equipment

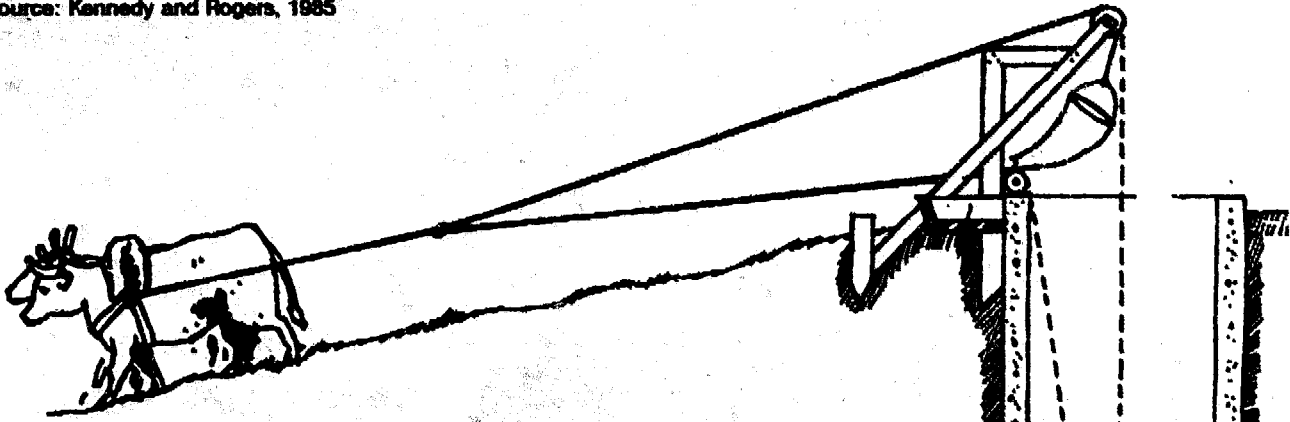
Traditional designs of animal-powered water wheels and other devices that provide relatively continuous delivery of irrigation water have been employed in North Africa and Asia for centuries (Löwe, 1986; Kennedy and Rogers, 1985; Inter Tropiques, 1985). Such systems make use of available materials and local energy sources, and can be made and maintained by local artisans. Among the well proven designs are the "Persian wheel" and

the Egyptian "sakia". The Persian wheel comprises a continuous loop of containers that scoop into the water, rise up, and empty out the water just after reaching the top of the wheel. The loop of pots can be quite long, so extraction from depths of 5-20 m is possible. For raising water to irrigation ditches from shallow wells the sakia is more efficient. This is because unlike many other irrigation devices, water is not "over-lifted". Water is scooped up in a series of spirals, and discharged into the irrigation ditch from the cen-

Fig. 9-24: The wheel of a sakia. As the wheel rotates, water is continually scooped into the compartments of the spiral, and released by the central hub. In this way water is not lifted higher than necessary.



Source: Kennedy and Rogers, 1985



tral hub of the wheel (Fig. 9-24). The distance water can be lifted is limited by the radius of the wheel, and is generally less than 2 m. This limits the use of sakias to quite specific conditions such as flat areas close to rivers, lakes or irrigation channels or other areas with a reliably high water table. The output of such sakias is generally $50-80 \text{ m}^3 \text{ h}^{-1}$ with a 1 m lift, and in Egypt one sakia commonly irrigates 6-10 ha of crops (Löwe, 1983; W. Boie, personal communication, 1989).

In some regions where traditional designs of water-raising systems are used, development projects and appropriate technology organizations have tried to improve those traditional designs and in some cases have produced entirely new prototype systems (Tainsh and Bursley, 1985; Kennedy and Rogers, 1985; Baqui, 1986). However in some developing countries, including India and Egypt, electric or diesel

Fig. 9-25: Simple mote water-raising system, showing slope for animals to walk down, and self-emptying bag for use with small irrigation canal.

pumpsets are quite rapidly replacing the widely used traditional animal-powered water-raising systems. Some such moves away from animal-powered systems have been encouraged and subsidized by government agencies.

In most of Sub-Saharan Africa, animal-powered water raising systems are absent or rare, yet in several countries there have been serious problems in affording or maintaining irrigation schemes relying on diesel or electric pumps. Suggestions have therefore been made that animal-powered systems could provide an appropriate solution, particularly as animal power is considered to be one of the cheapest methods of raising water at low lifts (Halcrow, 1983). While this is a sensible option to consider,

it is one that needs to be approached with caution. If the required "traditional" skills are not readily available, the installation of "traditional" designs may necessitate spe-

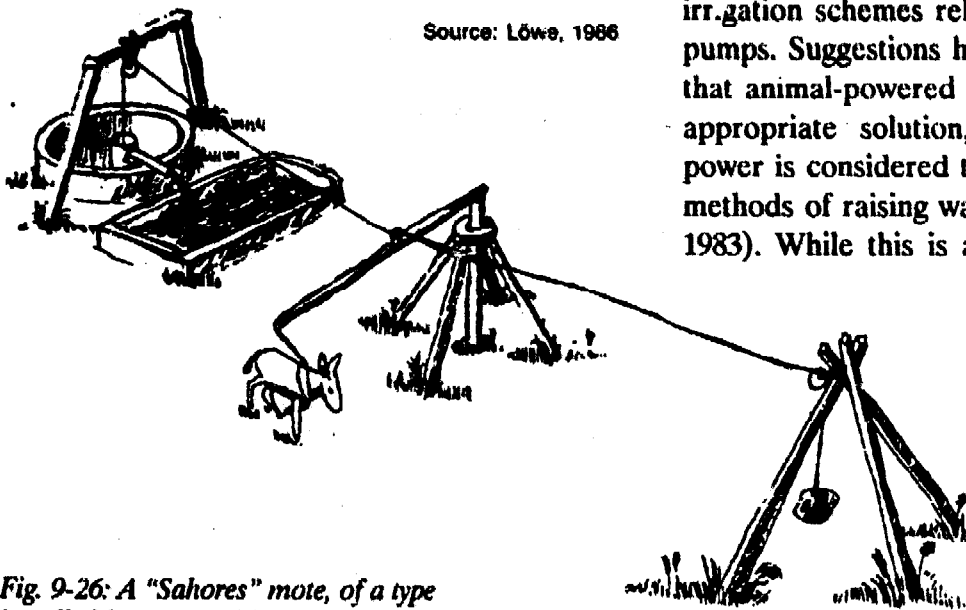


Fig. 9-26: A "Sahores" mote, of a type installed in several villages in Senegal.



Photo: Paul Starkey

Fig. 9-27: A simple and cheap animal-powered water-lifting system in Niger. The animals walk about 80m (the depth of the well) pulling a rope to which is attached a 25 litre bag. When the bag reaches the top of the well it is manually emptied, and dropped down the well again as the animals return for the next lift.

Fig. 9-28: Raising water from a deep well in Senegal using a "Guérouti" system of gantries and overhead lines installed by ENDA. The animals walk about 80m (the depth of the well) pulling up one 50 litre steel container, and then pull up a second 50 litre container on the return to the well.

Photo: Paul Starkey



cial training and supervision. No mechanical water-raising system is maintenance-free, and the introduction of animal-powered irrigation techniques may require significant training for local artisans to ensure the systems are maintained in working order (Löwe, 1986). One FAO project designed to overcome these problems involved Moroccan artisans training their counterparts in Mauritania to make and maintain traditional Moroccan designs of water-raising equipment (Bourarach, 1987).

While there are several aid projects in Sahelian countries interested in the potential for using animal power for irrigation, there is, as yet, not enough positive evidence to suggest that such techniques can be effectively introduced in present social and economic circumstances. Thus while it is an interesting option, any organization contemplating such a scheme would be advised to contact the relevant projects and information sources for an up-to-date assessment of this specialized area.

For domestic requirements, for providing water for animals and for small vegetable gardens, the raising of water from wells using animals to pull on ropes is a well proven and quite simple technology (Fig. 9-27). Such a

Source: Löwe, 1986

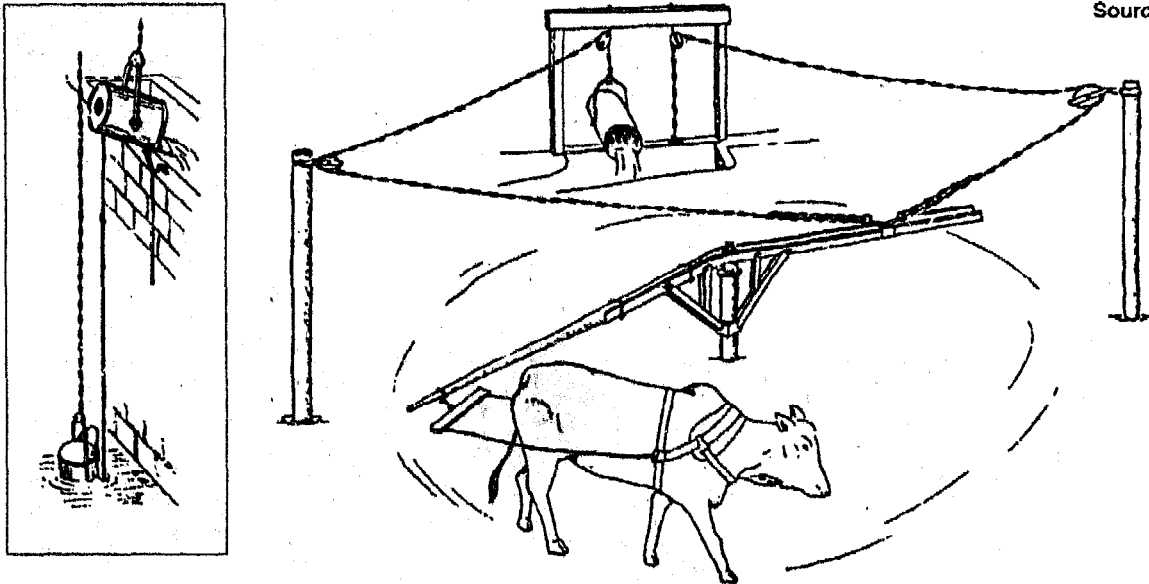


Fig. 9-29: "Stoney's mote". Similar designs of water raising systems are installed in many villages in Sri Lanka. As the animal walks round, the two buckets continually (and alternately) rise and fall. The buckets are designed to fill and empty themselves without supervision.

system can be used with wells of any depth, but it is most useful for very deep wells for which pumping systems can be difficult and for which manual raising is extremely tedious. In several Sahelian countries pairs of oxen may be seen walking away from wells pulling ropes 80-100 metres long. When the container reaches the top, the animals turn and walk

back in order to start the working part of the cycle again. Although such a system may appear laborious and slow, it illustrates how animal power can be utilized very simply to allow essential water to be raised. In a traditional system known as a *Delou* (or *mote* in India) the pulling of the water container is made more efficient by making the animal(s) walk down a slope (Fig. 9-25; Kennedy and Rogers, 1985; Löwe, 1986). The need for the animals to walk to and fro is reduced in the *Guérout* version of the *Delou* developed by ISRA and ENDA in Senegal (Goubert, 1982; Jacobi and Löwe, 1984; Deshayes, 1988). This has ropes or wires mounted above the animals, so that they can walk in a large oval, continuing to supply useful energy on the return journey as well as the outward one (Fig. 9-28). Extraction rates with a *Guérout* can be up to 4 m³ per hour at 40 metres, dropping to 2 m³ per hour at 80 metres (Löwe, 1986). In circular motes or "Stoney's mote" (Fig. 9-29), as used in Sri Lanka, one or more animal walks in a circular path, and a beam attached to overhead lines acts as a crank, converting circular movement into the vertical lift and fall of two

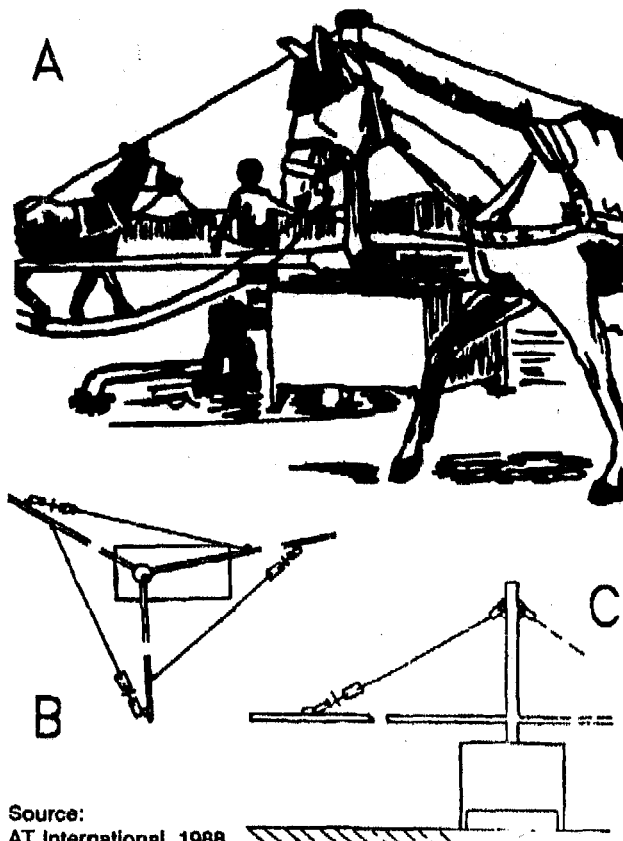


Fig. 9-30: Prototype animal-powered piston pump in Botswana. It uses the power of up to nine donkeys to pump water from deep wells.

A. General impression. B. Plan. C. Elevation.

Source:
AT International, 1988

water containers (Löwe, 1986). A recent adaptation of this principle is seen in the *Manège Sahores* developed in Senegal. An animal (usually a donkey) pulls a beam round in a circular path causing an overhead, counterbalanced rope to operate a simple piston pump. Extraction rates can be 6 m^3 per hour at 6 metres dropping to $1.8 \text{ m}^3 \text{ h}^{-1}$ at 20 metres.

Animal power has been used to drive adaptations of commercially available pumps. In one test in Botswana eight donkeys pumped 5.3 m^3 in an hour over a head of 38 metres using a British "Monopump" (Maseng and Jacobs, 1985). Using a commercial pump and a multipurpose gear, two small oxen were capable of pumping $2 \text{ m}^3 \text{ h}^{-1}$ through a head of 16 m in Sierra Leone (Koroma and Boie, 1988). In India, two heavy water buffaloes were reported to be capable of pumping $20 \text{ m}^3 \text{ h}^{-1}$ through an 8 m lift using a Danish "Bünger" pump (Burton, 1987).

Animal-powered water raising systems may be used for small scale irrigation, for example for vegetable production. Unfortunately in many of the rural areas where animal-power might be usefully employed for irrigation, marketing can be a major constraint and local produce prices may not be sufficient to economically justify the investment in any type of irrigation equipment. Although animal-powered systems are relatively simple, there are significant costs in time and materials to erect and maintain overhead lines and the circular sweeps. For domestic use, one unit can serve a small village, but this requires considerable cooperation for it is impracticable for each person to bring their own animal to draw water. The implications for communities that such systems may have on the partition of labour and responsibilities by sex, age and social group need to be carefully considered (Jacobi, 1985).

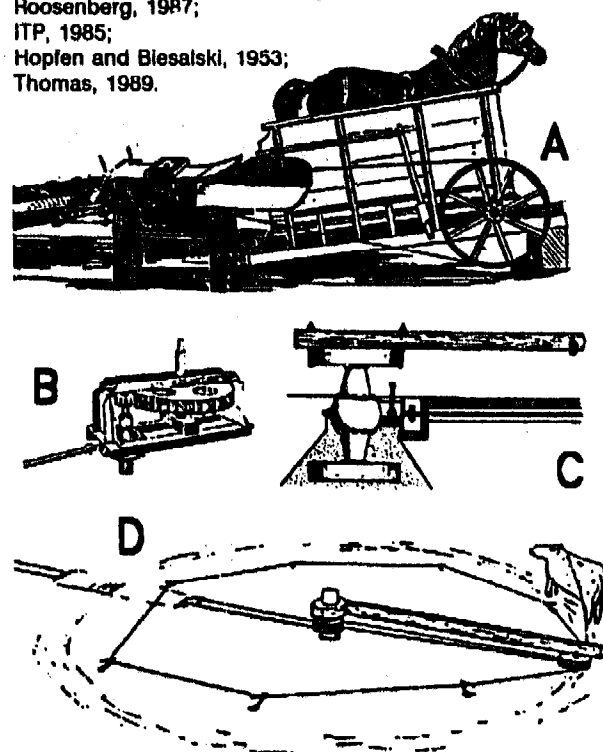
In several African countries prototype animal-powered water-raising systems have been built, but examples of recent, successful introduction are quite few. In some cases the prob-

lem has been the technical failure or the inefficiency of the prototype systems installed. In other cases systems have appeared to work satisfactorily, but diffusion of the technology has still not been widespread. For example in Senegal some systems have been operating in villages for over ten years, but the total number in use is still low. In some cases the water-raising systems may improve the quality-of-life of people but not alter their incomes and this may well have implications for the way such installations are funded in impoverished communities. Animal-powered water-raising is not as simple as it may seem at first sight, and there is much to be gained from the careful study of previous experiences. Sources of relevant information include ENDA (Senegal), GATE (Germany), IAE (Zimbabwe), IT-Dello (France), ITDG (UK) and RIIC (Botswana). The addresses of these organizations are provided in the Appendix and the GATE Animal Traction Directory: Africa.

Fig. 9-31:

- Some mechanisms for linking animals to machines.*
 A. Treadmill. B. Commercially available gear system.
 C. Gear system based on vehicle differential.
 D. Rope engine (concept).

Sources: after
 Roosenberg, 1987;
 ITP, 1985;
 Hopfen and Blesalski, 1953;
 Thomas, 1989.



Source: ITDG, undated

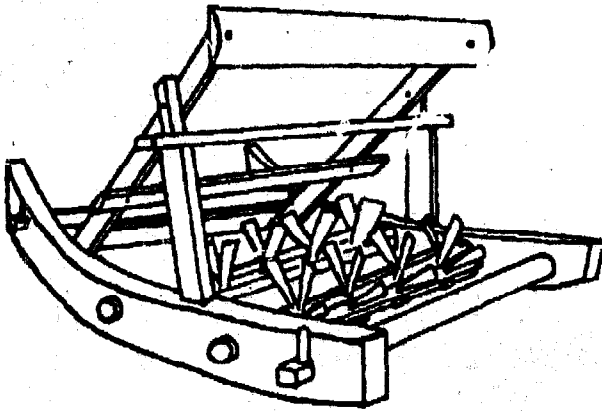


Fig. 9-32: Animal-pulled threshing sled.

9.9 Animal-powered gears and post-harvest operations

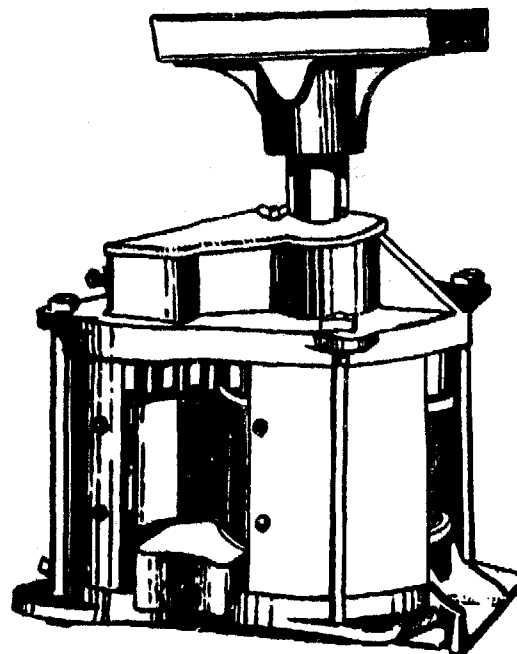
For centuries animal power has been usefully employed for crop processing. Some cereal crops can be threshed without any special equipment, merely by the trampling of animals. However basic threshing can be more efficient with the use of animal-pulled threshers similar in appearance to rotary puddlers or disk harrows; such implements can be found in several north African countries. Simple traditional mills requiring slow speed but high torque are well suited to being turned by animals. In northeast Africa camels are employed to turn uncomplicated mills based on a large wooden pestle and mortar designed to press oil-seeds such as sesame. Animal-powered sugarcane crushers, which also require only low speeds and high torque, are widely used in parts of Asia and Latin America and are commercially available in India (ITP, 1985). They were adopted to a limited extent in Madagascar (CEEMAT, 1971) and have been commercially produced in Kenya (ITP, 1985).

Animals can also be used to power a wide variety of more complex grinding mills and various types of crop processing machinery that require high speed rotation and relatively low torque. The mechanisms for harnessing the power of the animals sometimes involve treadmills (Fig. 9-31) but more commonly

they are based on long, animal-turned drives or sweeps (*manèges* in French). As the animal(s) walk round in circles, power is transmitted through a system of gears or belts to the output machine. A useful review of this subject was provided by Löwe (1986), who discussed historical precedents and modern applications. Other publications giving details of long-standing designs of animal-powered systems include Partridge (1974), Major (1985) and CEEMAT (1971).

Complete purpose-built gear units were sold for many years in North America and Europe, and in recent years have been available in Pakistan (ITP, 1985) and Poland (United Nations, 1975). There continues to be interest in designing single- or multi-purpose gear systems for use in developing countries. Many systems designed during the past fifty years have involved animals walking in circles around the differentials of axles from old vehicles which have provided the basis for the gearing system (Hopfen and Biesalski, 1953; Hopfen, 1969; Finn, 1986; Symington, 1986; Roosenberg, 1987; Mueller, 1987). One unit developed by AFRC-Engineering was based on the gears of a cement mixer. A different

Fig. 9-33: Animal-turned sugarcane press.



Source: CEEMAT, 1971

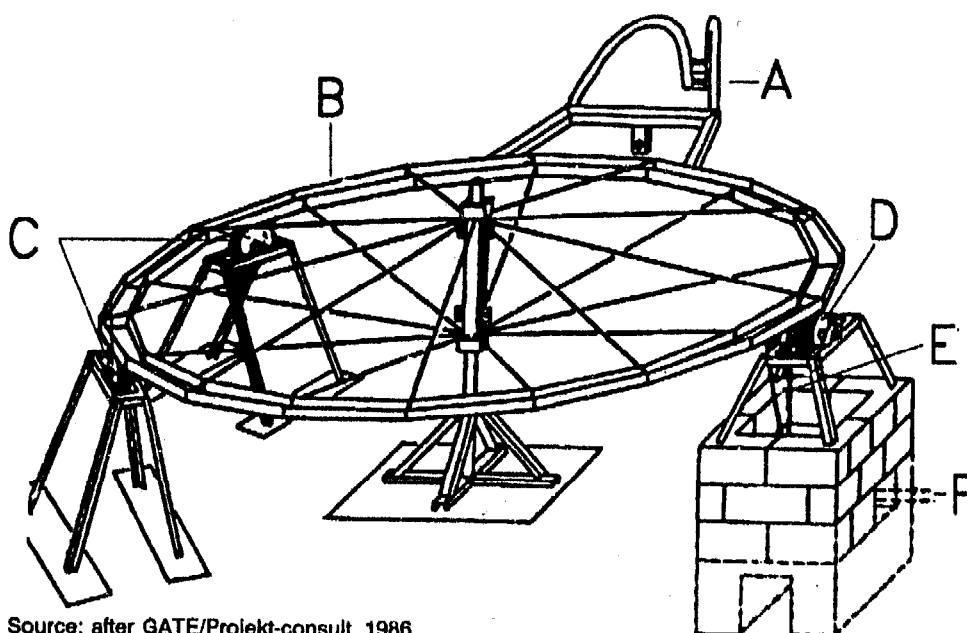


Photo: Paul Starkey

Fig. 9-34: A prototype animal-powered multipurpose gear system installed at the Rolako Work Oxen Centre in Sierra Leone. The horizontal wheel has been weighed down to increase friction with the offtake supporting wheel (centre of photo). The output shaft runs below the fore-ground of the photo.

approach has been taken by the Development Technology Unit of the University of Warwick which has been trying to develop animal-powered rope engines. In these the animal walks round a circle of rope, pulling a beam on which is a pulley. As the pulley runs round the rope, the rotational movement of the pulley is transmitted to a second rope, and so to the final output (Thomas, 1989). A key problem faced by such systems is dealing with the expansion characteristics of long ropes.

In the early 1980s, GATE undertook a pilot project that involved installing animal-powered systems for raising water or grinding cereals in about twenty locations in West Africa (Busquets, 1986). While some units were designed for specific applications (pumping or milling) one system was a multipurpose drive that could power a range of pumping, hulling and grinding equipment (Fig. 9-34, 35). The requirement to perform several different functions made the multipurpose unit the most



Source: after GATE/Projekt-consult, 1986

Fig. 9-35: A multipurpose gear system developed by the GATE project. The animal(s) (A) turn a large horizontal wheel (B) of 4 m diameter which is supported by two neutral supporting wheels (C). As the horizontal wheel rotates its weight causes the third supporting wheel (D) to turn. This drives a chain (E) connected to the final output shaft (F) which may be situated below ground level to allow the animals to step over it easily.



Photo: Paul Starkey

Fig. 9-36: A prototype animal-powered mill installed in a village in Senegal following collaboration between the villagers, ENDA, GATE and a local blacksmith.

expensive of these gear systems. One multi-purpose unit is being evaluated in Sierra Leone where it pumps water for an animal-traction station and also hulls rice. A prototype cassava grater is being developed for this gear system (Koroma and Boie, 1988).

A completely different type of animal-powered equipment was also developed by the GATE project: this was a *single-purpose* grinding mill, mounted on a rotating beam (Fig. 9-37). Power for the mill is supplied by a short chain driven from a ground wheel running on a low circular wall of 5-6 metres diameter.

The wheel rotates at about ten times the rotational speed of the sweep as the animal walks round in circles (Bielenberg, 1988). Using a single donkey, this unit fitted with grinding stones is capable of grinding about 5-15 kg of millet per hour into relatively fine, food-quality flour (Boie, 1989). With horses or oxen rates of up to 20 kg per hour of relatively coarse maize flour can be ground. In

Sources: after ENDA, 1986 and Bielenberg, 1988

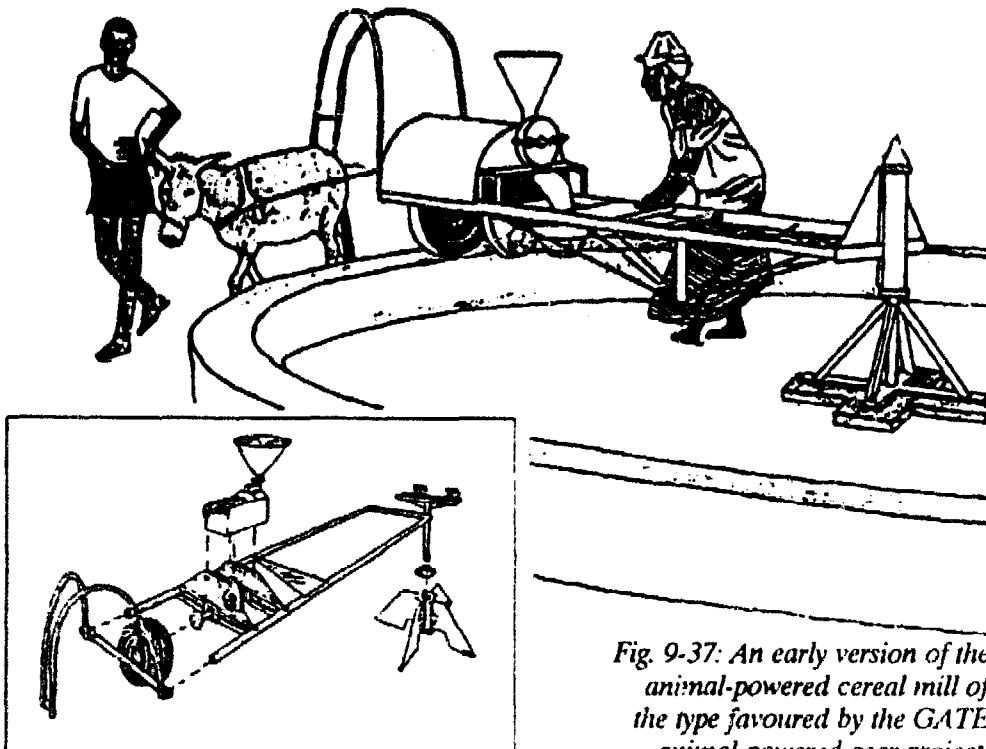
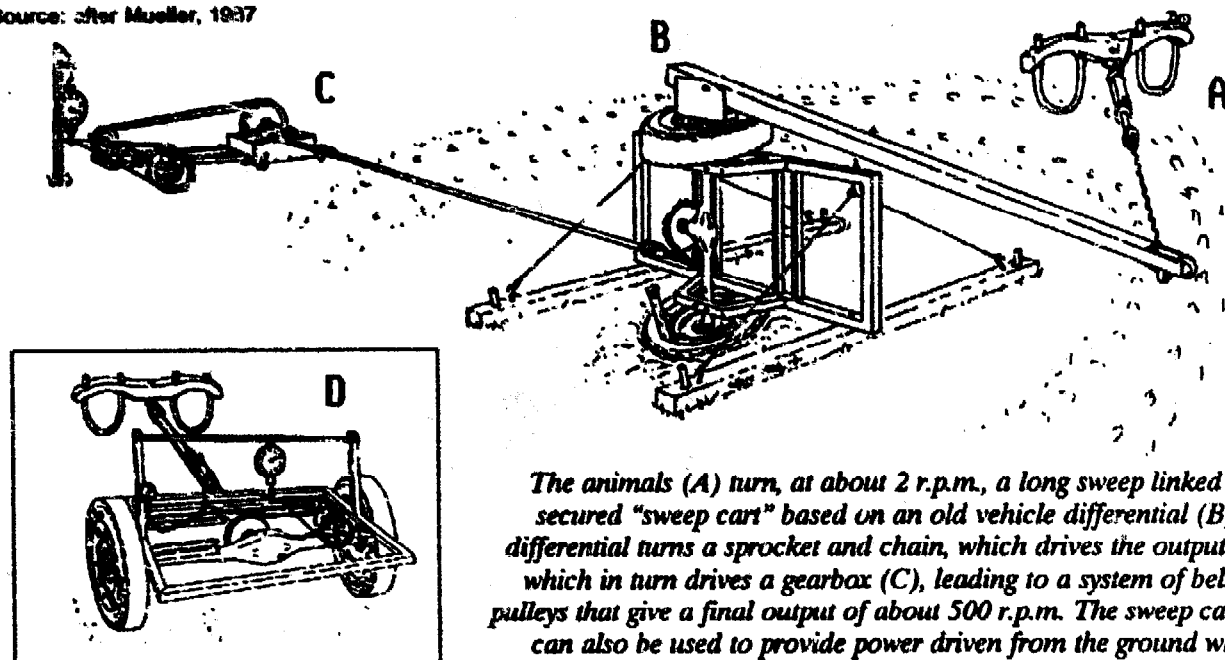


Fig. 9-37: An early version of the animal-powered cereal mill of the type favoured by the GATE animal-powered gear project.

Source: after Mueller, 1937



The animals (A) turn, at about 2 r.p.m., a long sweep linked to the secured "sweep cart" based on an old vehicle differential (B). The differential turns a sprocket and chain, which drives the output shaft, which in turn drives a gearbox (C), leading to a system of belts and pulleys that give a final output of about 500 r.p.m. The sweep cart (D) can also be used to provide power driven from the ground wheels.

Fig. 9-38: An example of a prototype animal-powered gear system based on a vehicle differential. This particular prototype was developed at the Tillers Small Farm Program, USA, and comparable prototype systems have been developed in several countries.

one village in Senegal the installed mill (Fig. 9-36) worked for about 6 hours per day, and women brought their own donkeys or horses to provide the power to grind their own millet (Busquets, 1986; Boie, 1989). It was found that grain milled using animal power had to be dry (drier than for pounding or diesel-powered mills). This required a change in the daily schedule of women to allow grain to dry overnight, but the dried grain or flour could be stored. It was a matter of debate whether pounding, animal power or motor power produced the better flour, and overall judgements involved both objective and subjective opinions. The early prototype animal-powered mills tended to produce coarse flour but subsequent designs have attempted to rectify this. There were some social and organizational problems relating to the communal nature of the mill: for example obtaining the use of the mill and an animal at a convenient time. However the women felt that the mill saved them the considerable drudgery involved either in pounding or in travelling to the nearest power mill (Starkey and Faye, 1988). The animal-powered mill has been designed for local construction, and about 20 units

have been made and installed by local artisans in Senegal (ENDA, 1987). Initially all grinding units were imported, but some complete mills have been locally produced in Senegal (Boie, 1989). In socioeconomic feasibility studies it was suggested that the widespread use of such systems in rural areas in West Africa could have a marked impact on the quality of life while saving fossil fuel and foreign exchange compared with motorized alternatives. However it has yet to be demonstrated that such systems can be constructed and operated independently of development agencies. Further details of the design and operation of these animal-powered mills are provided in the book of Boie (1989).

In several publications and project proposals it has been claimed that animal-powered gears, treadmills, sweeps, rope engines or other mechanisms could be introduced into African countries to drive crop processing equipment (grinders, threshers and driers), workshop equipment (lathes, grinders and saws) and even refrigeration or electricity generation units. Although there have been several different initiatives and various de-

signs of equipment and techniques developed, there is insufficient evidence to judge whether such schemes could have any long-term impact in developing countries. No programme has yet managed to demonstrate that stationary animal-powered gear systems can be adopted to a significant extent in Africa. The difficulties are both technical and socio-economic. Animals walk around gears and sweeps at the rate of about 2-3 revolutions per minute, and yet many machines require axes rotating at 200-1000 r.p.m. or more. Thus high gearing is necessary with inevitable frictional losses and this makes animal-powered gear systems relatively inefficient. Low-friction gearing and bearing systems are usually expensive. Work animals are powerful and heavy and it has proved particularly difficult to devise efficient and low-cost gearing systems that are strong enough to withstand the very large, sudden and asymmetrical forces that even docile animals can apply to a gear system. Furthermore it can be difficult to obtain output devices (mills, hullers, pumps etc.) suitable for use with animal power, for most modern mass-produced machines have been designed for consistent, high rotational speeds. Where it has proved technically possible to solve these problems, this has been quite costly, and most gear units are still relatively expensive to install.

Animal-powered gear systems were once widely operated in Europe and North America, and some units are still in use today. However although the technology has been historically proven, most animal-powered systems were developed in the absence of realistic alternatives such as small stationary engines. Today small petrol and diesel engines and electric motors are becoming increasingly available throughout the world, although their price is often high relative to rural incomes. In many parts of Asia, villages have electricity and electric motors can be used for crop processing, pumping and workshop applications. Even in rural areas in Africa, where electrification is uncommon, small motors of various

types are increasingly being used, sometimes as a result of development initiatives supported by aid agencies. Motors may be difficult and expensive to acquire and maintain, but it is apparent from the success of "bush-taxis" and private motorcycles that the technical and economic constraints to running engines in remote areas can be overcome if there are sufficient incentives. Small motors can often achieve in a relatively short time the work that would take an animal (and its supervisor) several hours. In such circumstances farmers, or entrepreneurs, are unlikely to favour the animal-powered option unless it is *significantly* cheaper to purchase, operate and maintain. Certainly, once installed, the daily running costs of animal-powered gear systems may be low compared with systems using fossil fuel, but it should not be assumed that the animal-energy is "free". Even where there are no direct economic costs to animal use, the various social costs and benefits of animal management and supervision have to be compared with the costs and benefits of alternative manual or motor systems.

Some of the arguments for and against animal-power gears are identical to those for and against animal power for tillage, and in many African countries animal-power for tillage is proving to be a chosen option. However there are major differences between the operational requirements for low-speed tillage (for which animals are generally well suited) and stationary applications requiring high speed rotation. As a result of such differences, and their effects on price, efficiency and convenience the overall comparative advantage of animal power over motor power tends to be lower for stationary applications. Historically some of the first operations to move from animal power to motorized power have been water pumps and grinding equipment. This has been observed in Europe and North America, and it can be seen by present patterns of adoption of motorized pumps and mills in animal-using parts of Asia and north Africa (Binswanger, 1984). In these situations well-proven and

long-accepted animal-powered machines already installed in villages have been abandoned and replaced by motorized alternatives (in some recent cases in Asia and Egypt these changes have been encouraged through the provision of credit and subsidies). In most of sub-Saharan Africa the population densities and the infrastructure differ markedly from the regions where animal power systems have been widely used, and so direct comparisons are problematic. Nevertheless it is clear that considerable financial costs and training effort would be needed to install animal-powered gears in villages and this would have to be done in the face of increasing competition from engine-powered alternatives, which may themselves be subsidized by aid agencies. In addition to the potential technical and economic constraints, Löwe (1986) warned that as concern for animal welfare grows in donor countries, the idea of animals having to walk on treadmills or repeatedly turn in a circle is beginning to cause unease (even though the animal may be saving much human drudgery). For national and international agencies dependent on public support in developed countries, this point could prove increasingly important.

In conclusion, animal-powered gears can be effective and they have been widely used in some countries. There are few recent examples of such systems being adopted on a significant scale. While systems differ considerably in their costs, work efficiencies and maintenance requirements, they are quite expensive to install and like all machines, they can fail if they are not correctly maintained. They are generally suited for use by a number of people, either through community ownership or through the initiative of a private entrepreneur, and this may have important social implications. In recent years many designs have been tested in Europe, Asia, Africa and the Americas, and organizations considering the use of such systems should investigate not just the technical aspects of these, but their survi-

val rates under village conditions after installation.

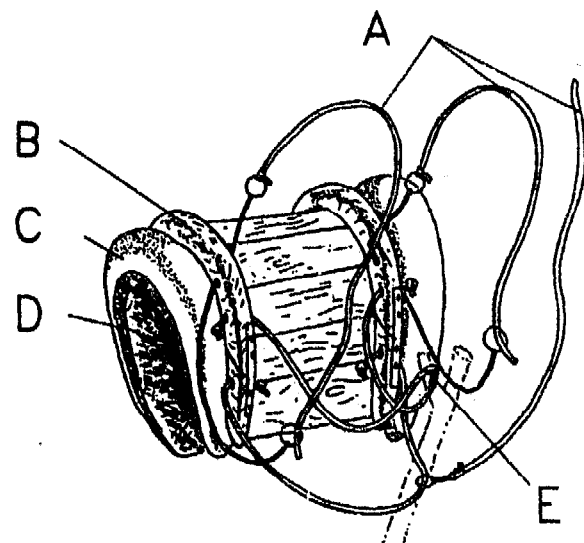
Further information on animal-powered gears and their applications can be obtained through GATE (Germany), GRDR/GRET (France) and ENDA (Senegal), Tillers International (USA) and University of Warwick (UK). Addresses of several organizations in Africa that have evaluated animal-powered devices are provided in the Animal Traction Directory: Africa (Starkey, 1988).

9.10 Forestry and road-building

One specialized but effective use of animal power is for the extraction of timber from forests. Even where motorized alternatives are available, animal power may be both efficient and cost-effective for moving tree trunks from felling sites to forest roads. Indeed the use of horses and/or mules for logging in parts of Scandinavia and the United States (Potter, 1986) appears to be economically attractive. In some parts of Asia elephants are employed for logging (Kerr, 1986) and in several parts of Europe horses work in forests (Chivers, 1988; Vis, 1989). In Latin America techniques for using oxen for logging have been discussed

Fig. 9-39:

Saddle used for logging with mules in Italy.
 A. Load fastening straps. B. Wooden frame.
 C. Straw padding. D. Felt padding. E. Loading strap.



Source: Spinelli and Baldini, 1987

Source: after Nolle, 1986

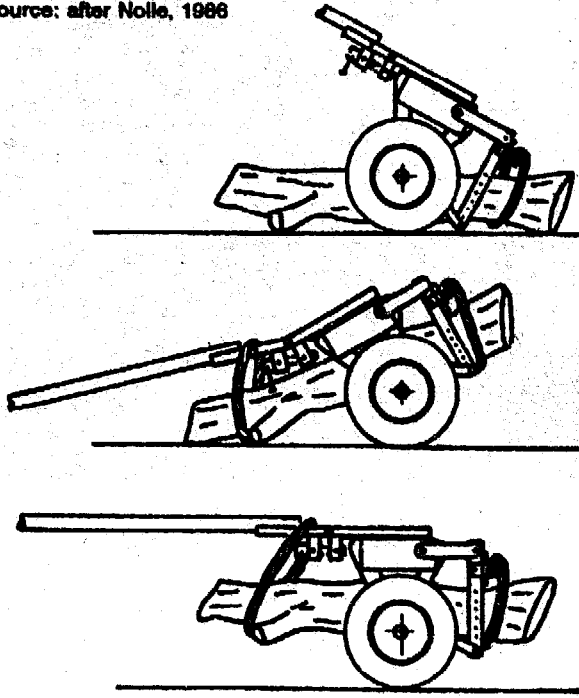
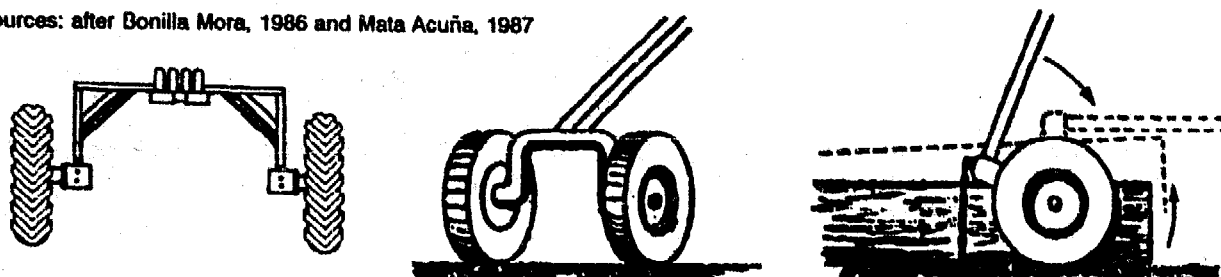


Fig. 9-40: Illustration of the potential to use a Tropicultor wheeled toolcarrier as a logging sulky.

in detail by Rodriguez (1984), Cordero (1985, 1986, 1988), Bonilla Mora (1986) and Mata Acuña (1987): The use of animals for pulling logs out of dense forest requires little specialized equipment other than comfortable harnessing, chains and hooks (Fig. 9-41). Simple animal-drawn wheeled "sulkies" can be employed to move large logs along tracks, and in well-cleared areas they can also be used to assist primary extraction. Sulkies are simple bars, frames or cranked axles which are supported by two wheels and pulled by means of a drawbar (Fig. 9-42). Provided they have high clearance, wheeled toolcarriers can be used as sulkies, although such applications are rarely observed (Fig. 9-40).

Fig. 9-42: Simple forestry sulkies for moving large logs with oxen in Cost Rica.

Sources: after Bonilla Mora, 1986 and Mata Acuña, 1987



Source: after Zaremba, 1976

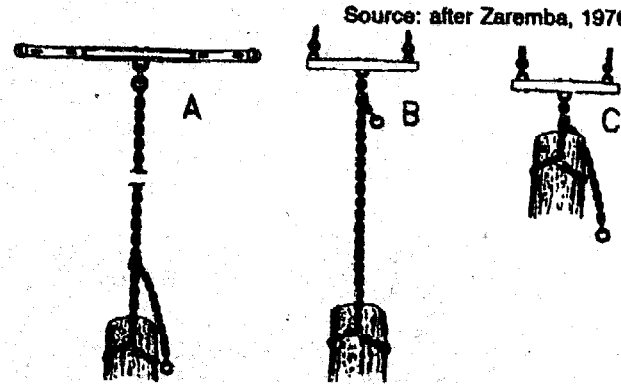


Fig. 9-41: Skidding logs with chains.
A. Long-chain skidding with a yoked pair.
B. Long-chain skidding with a single animal.
C. Short-chain skidding with a single animal.

In parts of Italy mules are employed to carry small logs on their backs using special pack saddles (Fig. 9-39). Larger logs can be attached to the saddles and dragged. A well-illustrated description of the mule-logging techniques currently employed in Italy was written by Marquart (1988) and further details were provided by Spinelli and Baldini (1987).

There has been some very well documented work on the use of mules for logging in southern Africa (Zaremba, 1976). At the Usutu Pulp Company in Swaziland a mule and two labourers can extract and stack about 160 logs (20 tonnes) per day over distances of 80-150 metres. In this case the logs are quite small being 1.5-2.4 metres, with a maximum diameter of 45 cm. In Malawi pairs of oxen controlled by one person can extract seven cubic metres (7 m^3) of larger logs a day over distances of 100-300 metres, although rates of $5 \text{ m}^3/\text{day}$ are more common. The animals used are often crossbreds of Malawi Zebu and



Photo: Paul Starkey

Fig. 9-43: Logging with a pair of oxen in Malawi.

larger exotic breeds, such as Friesian, although pure indigenous and pure exotic animals are also used (Fig. 9-43). Details on the employment of oxen for logging in Malawi were provided by Cornelius and Broadley (1974) and Solberg and Skaar (1987). Trials on the use of oxen for logging in northern Nigeria were described by Allen (1972).

Another specialized application of animal power is for rural road construction for which bovines, equines and camels can be employed. Comfortable harnesses are essential and carts capable of tipping their loads easily may be desirable. In countries with a long tradition of animal power use, including those of North Africa and Asia, traditional haulage techniques may have already been adapted to road construction. In other countries where those involved in planning assume capital-intensive machinery is a prerequisite for rural road construction, justification trials using animal-drawn equipment may be necessary. Recent trials in this field have been carried out in Botswana (McCutcheon, 1985) and Honduras (Kliver, 1987).

9.11 Further information

The technologies covered in this section are either unusual or still at research stage. Some key references have been cited in context, and these may be useful starting points for obtaining further background details. However to obtain a more up-to-date picture, people seriously contemplating work in one of these fields are recommended to contact some of the organizations or individuals presently working on these technologies. Where practicable the names of relevant organizations have been provided and further sources of information and addresses are provided in the Appendix and in the GATE Animal Traction Directory: Africa (Starkey, 1988). Finally, it is sensible to bear in mind that those enthusiastically working in an area of specialization may be excellent at providing specific details, but they may find it difficult to provide an unbiased perspective. Therefore crosschecking optimistic impressions given by protagonists with the realism and experience of farmers or hardened fieldworkers could well be useful.

10. Draft assessment and work rates

10.1 Implement draft

The resistance an implement provides to forward movement will determine the draft force animals have to apply to achieve the required work. Draft forces can be measured with various types of *dynamometer* which are commonly based on expanding springs, hydraulic pistons or loadcells (Figs. 10-1, 10-2, 10-3). In section 5.3 it was mentioned that there is now great potential for combining modern loadcells with computers. With such systems draft measurements can be recorded in the field many times each second, and mean values calculated over specific distances or periods of time (Lawrence and Pearson, 1985).

The draft of an implement will be determined by many factors related to its specific design, including:

- overall weight;
- overall shape;
- shape of its components, including the sharpness of any cutting elements;
- angle(s) at which components meet the soil or working surface;
- position and angle(s) of attachment of traction chain or drawpole;
- material of which the implement and its components are made;
- adhesion properties of working surfaces;
- working width;
- working depth;
- friction within any rotating or articulating parts;
- elasticity/rigidity of different members.

As many of these details (e.g. working depth and width) can be adjusted, the draft will de-

pend on particular settings and therefore on the operator. The operator may also vary working width, depth or angle of work as an implement is used, and such on-the-move adjustments through variations in pressure on the handles can be subtle or very significant.

There are also numerous external factors that influence the draft requirement of implements. These are specific to the particular environment and the precise conditions under which equipment is used. They include:

- type and composition of the soil;
- soil moisture;
- previous tillage history;
- quantity and type of living plants growing in the soil;
- quantity and type of crop residues and trash;
- presence of roots, stones or stumps;
- slope of the land.

The draft of an implement may increase with the speed at which it is pulled, although at normal animal walking speeds, this source of variation will be slight. The implement speed will itself depend on many factors relating to the type and condition of the animals.

A diagram illustrating how some of the factors determining draft are interrelated was provided in Chapter 2 (Fig. 2-3) and the international unit of force, the newton (N), was also explained in Chapter 2. For more technical details on the dynamics of soil tillage, readers are referred to texts such as that of Kepner, Bainer and Barger (1978), although these authors noted that tillage is still far from being an exact science.

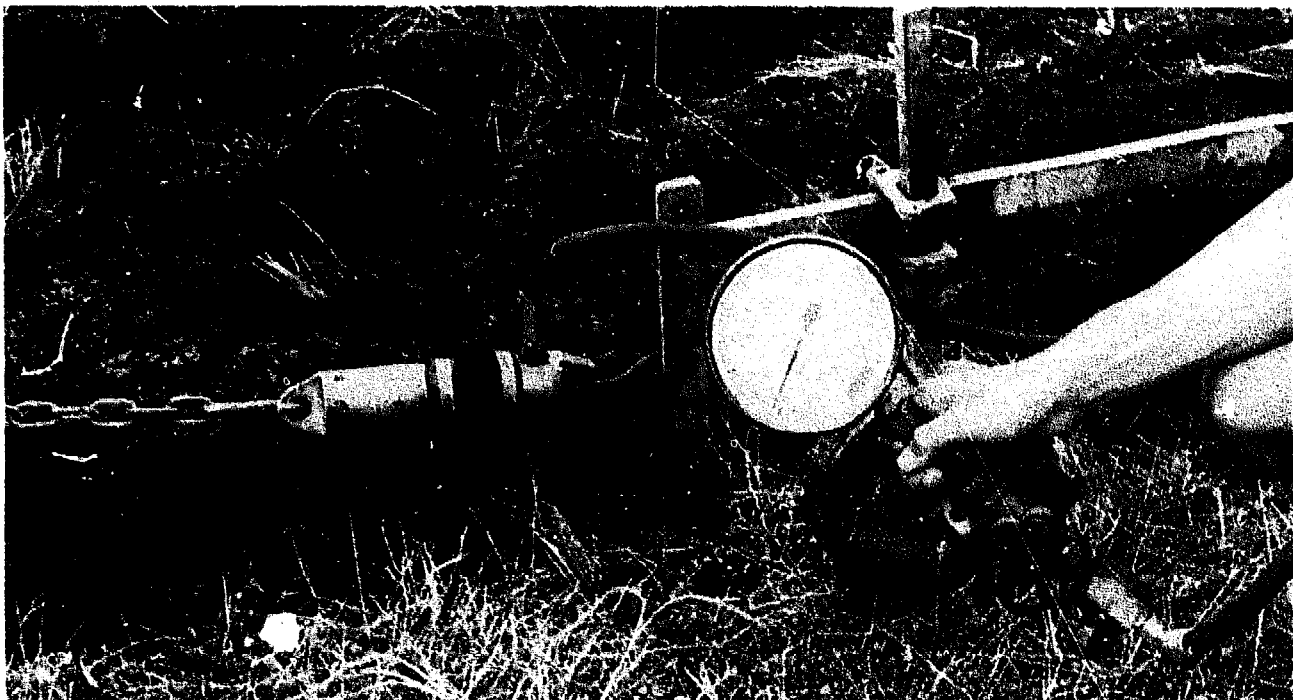


Photo: Paul Starkey

Fig. 10-1: A hydraulic dynamometer used for measuring draft forces.

Fig. 10-2: The use of a hydraulic dynamometer to assess the draft of a Houe Sine plow in specific environmental conditions in Sierra Leone.

Photo: Paul Starkey

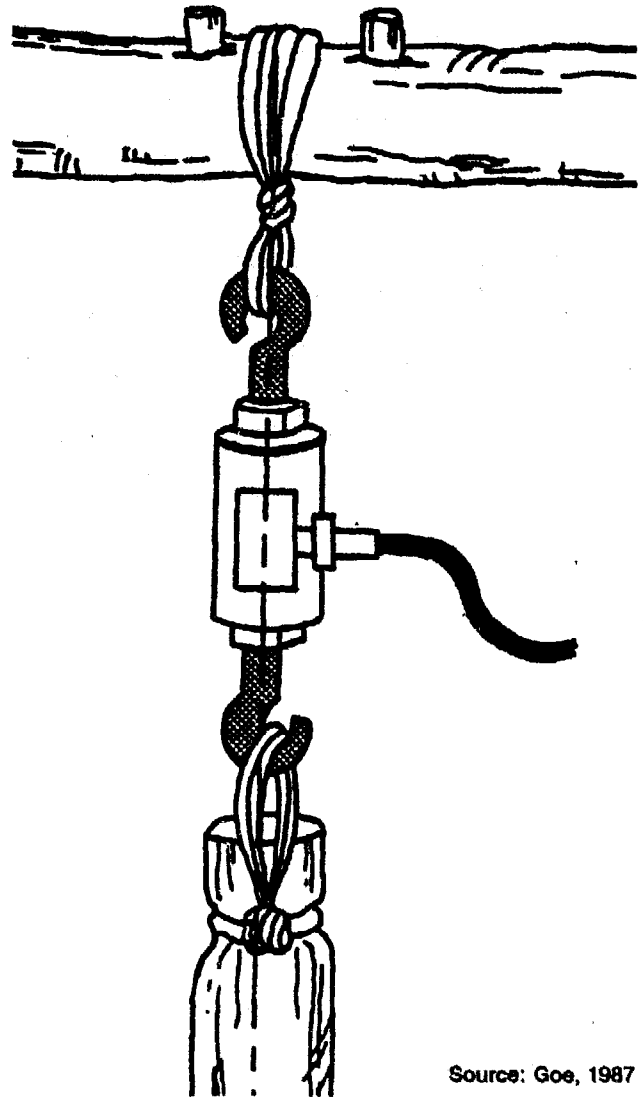


In practice the draft force that animals exert to draw an implement constantly changes due to numerous interacting variations attributable to the animals, the operator, the soil and the orientation of the implements. Lawrence and Pearson (1985) reported that in one experiment the actual draft measurements ranged from 589 to 2160 N for the same plow in the same field in the same two week period at the end of a rainy season. If this degree of variation can exist in one field within the same climatic season, the potential for differences between different soil types and between seasons is quite staggering. O'Neill and Kemp (1988) gave examples of the great variation in draft forces associated with soil conditions and previous tillage history. In trials in India the mean horizontal draft forces of a blade harrow (bakhar) pulled by a pair of oxen ranged from 239 N in a soil that was dry but which had been previously plowed, to 1227 N in moist soil with many weeds. It should be stressed that this fivefold difference was in overall *mean* draft in nominally "steady-state" conditions (the mean was itself derived from a whole series of 15-second means, each one obtained from 450 force

measurements). The range between maximum and minimum instantaneous draft forces would have been far greater than this. Furthermore the trials were undertaken under what were considered "normal" and representative cultivation conditions, and so even this very wide range does not indicate the extremes of draft force that might be recorded for such implements under different conditions in India.

It is therefore evident that to simply state that one particular design of mouldboard plow has a draft of (say) 700 N has little meaning by itself. That plow might be used with the depth wheel set just above the level of the share (for very shallow plowing), in light, moist soil with the traction chain attached to the unplowed side of the hake. The same implement could also be used with the wheel raised for deep plowing, in a dry, sunbaked Vertisol (black cotton soil) with the traction chain towards the furrow. In the first instance the draft could be managed by a single donkey, in the latter it could be hard-going for a team of six oxen. Thus absolute figures relate only to the highly specific conditions of use at any one time.

If the draft of different implements is to be measured, the readings should be obtained from comparable settings of the various implements pulled by the same animals operating in the same external conditions. Useful comparisons of draft requirements can also be made if each implement is used in a number of different settings in the same conditions. In such circumstances the environmental variables are *relatively* constant. Where possible trials should be replicated and randomized both to facilitate analysis and to reduce the risk of unintentionally linking the performance of one implement or setting with one environmental, animal or human variable. Not all of the possible sources of variation are obvious. For example Pearson *et al.* (1989) provided figures illustrating how much effect individual operators can have on the draft of



Source: Gos, 1987

Fig. 10-3: Diagram showing how an electronic loadcell (strain gauge) dynamometer was used to join the beams of a maresha ards to withers yokes during research studies in Ethiopia.

an implement, even one with fixed settings; in one particular trial plowing terraces with a traditional ards in Nepal, a plow had a mean draft of 704N with one plowman, and 492N with another. In this case the animals, soil, environmental conditions and apparent working practices were the same, so that the differences in draft could only be ascribed to the way the two operators used the plows. One plowman preferred the animals to walk faster than the other, and it appears that to facilitate this he must have consciously or subconsciously varied the working depth and/or orientation of the plow, so reducing its draft.

Table 10-1: A selection of assessments of force, speed and power reported in the literature.

Important note: These figures were collected under diverse environmental conditions and encompass very different standards of accuracy, repetition and scientific rigour. The information is provided for illustrative purposes only, and detailed comparisons between the various frames without reference to the original sources is not advised. Some figures have been recalculated from different units or data forms used in the sources.

(WTC = wheeled tractor)

Country	Animals	Conditions	Implement	Force (N)	Speed (m s ⁻¹)	Power (W)	Reference
Botswana	400-600kg oxen (team of four oxen)	On-station; loose sandy-loam soil, after first rains	30 cm plow	2318	1.08	2498	Bordet, 1987; AFRC-Engineering, 1987
			25cm plow	1776	1.02	1802	
			5-tine cultivator	1220	1.17	1417	
			rolling cultivator	852	1.31	1086	
			FMDU ripper	2039	0.75	1533	
			CEEMAT tine	962	1.12	1086	
Burkina Faso	400kg W. African Zebu (pair)	On-station; dry sandy-clay soils	Prototype tine cultivator - RR	800	0.8	640	Le Thiec and Bordet, 1988
Ethiopia	250-320kg Ethiopian Zebu oxen (pair)	Farmers' fields after: long fallow short fallow	Maresha ard plow	1195	0.35	424	Goe, 1987
				928	0.55	510	
Ethiopia	Single oxen: Ethiop'n Zebu 309 kg 302 kg Boran × Zebu 372 kg 465 kg	Farmers' fields. Nutrition levels: Normal Underfed Normal Underfed	Maresha ard plow depth: 13.9cm	590	0.5	300	Abiye Astatke, Reed and Butterworth, 1986
			13.9cm	600	0.5	310	
			14.6cm	660	0.5	330	
			14.6cm	710	0.5	360	
Ethiopia	400 kg Ethiopian Zebu oxen (pair)	Experimental station	Loading cart	422	0.6	220	Kebede and Pathak, 1987
				775	0.5	380	
				1060	0.4	400	
				1373	0.3	360	
Morocco	270kg horse 460kg mule 420kg camel	On-station; level vertisols, winter rains	20cm plow	795	1.23	978	Bansal, El Gharras, and Hamilton, 1989
				923	1.06	978	
				569	1.04	591	
	270kg horse harnessed with 175kg donkey		20cm plow	790	0.9	711	
			636	1.16	738		
			729	1.13	824		
	420kg camel harnessed with 175kg donkey		20cm plow	795	1.04	827	
			550	0.92	506		
Niger	140kg donkey	On-station; indicative figures only	Loading sledge	220	1.1	240	Betker and Klaij, 1988
			Braking device	400	1.0	400	
	300kg horse		Loading sledge	700	1.3	910	
			Braking device	3700	1.5	5600	

Country	Animals	Conditions	Implement	Force (N)	Speed (m s ⁻¹)	Power (W)	Reference
Costa Rica	475kg Rojo Criollo oxen (pair)	On-station; heavy soil, fairly dry	WTC plow	1131	0.59	670	Lawrence, 1989
			WTC mower	634	0.59	368	
			WTC cart	214	1.0	211	
China	300kg yellow cattle (single)	Not stated	Plow	650	0.7	550	Feng Yang-lian, 1984
			Cart	420	0.9	378	
India	530kg Malvi oxen (pair)	On-station; heavy black soils	15cm plow	550	0.73	380	Rautaray, 1987
			90cm disc harrow	500	0.76	402	
			45 cm blade harrow	600	0.64	373	
			WTC with: 15cm plow	700	0.77	530	
			25cm plow	1200	0.53	604	
	740kg Red Dane/Sahiwal crossbred oxen (pair)		2 × 15cm plows	1500	0.49	709	
			2 × 25cm plows	1950	nil	nil	
			WTC with: 15cm plow	700	0.79	552	
			25cm plow	1200	0.65	746	
			2 × 15cm plows	1500	0.51	880	
India	435kg (mean) oxen (pairs)	On-station; experimental track	Loading sledge:				Premi and Singh, 1987
			First hour	840	0.96	798	
India	Oxen (pair), (weight not stated)	On-station	Load sledge pulled with:				Ayre, 1981 after Swamy-Rao, 1964
			pole yoke	2830	0.28	790	
	collar-yoke		2820	0.33	900		
	Single ox (weight not stated)		15cm plow pulled with:				
back harness collar-yoke		620	0.75	450			
Nepal	250kg oxen (pair)	Hill terraces, after main rains; Plowman K Plowman R	Ard plow (traditional)	704	0.33	232	Pearson, Lawrence and Ghimire, 1989
				492	0.49	241	
Nepal	Pairs of: 280kg buffaloes 390kg oxen	Terai rough roads and farm tracks	Wooden carts				Pearson, 1989
			380kg load	300	1.0	300	
			587kg load	336	1.0	336	
Thailand	Buffalo (nos and weights not stated)	On-station	340kg sledge pulled with:				Garner, 1957
			single yoke	1480	0.27	400	
			collar	1480	0.40	592	
			breast band	1480	0.45	666	



Photo: AFRC-Engineering archives

Fig. 10-4: Use of AFRC-Engineering computer-based data-logger during trials in Ethiopia.

In most other cases the different effects of implement and environment on the draft measurements are very difficult to distinguish. For this reason Lawrence and Pearson (1985) cautioned against ascribing "typical" values to draft forces unless the numerous environmental variables had been rigidly defined.

Table 10-1 provides some examples of implement force, speed and power found in the literature. From the foregoing discussion it should be clear that these should be considered as "illustrative" figures and, since they are cited here away from their original context, they should be viewed with great caution. The data presented were collected in diverse environmental conditions, over various periods of time, with very different levels of precision and statistical analysis (if any). Some of the data refer to short-term tests in which animals were expected to work very hard, while others are derived from average figures over working periods in excess of five hours. For these reasons it would be most unwise to make specific comparisons between the different sources. It is more acceptable to make

general and superficial comparisons between the different variables that were assessed by the same source, for example the effects of different implements, animals, harnesses, management systems and people. However it must again be stressed that these figures have been extracted from their original context in which the experimental designs or levels of statistical significance (if any) were explained and so readers are strongly urged to refer to the original publications before quoting such figures or drawing any conclusions.

10.2 Working rates

It was noted in Chapter 2 that work is a product of the force applied (approximately equivalent to implement draft) and the distance moved. The rate of work (power output) depends on the quantity of work (draft x distance) and the time in which this is achieved, which is determined by the average speed at which the animals move. Some of the numerous factors that interact and influence working rate were illustrated in Fig. 2-3.

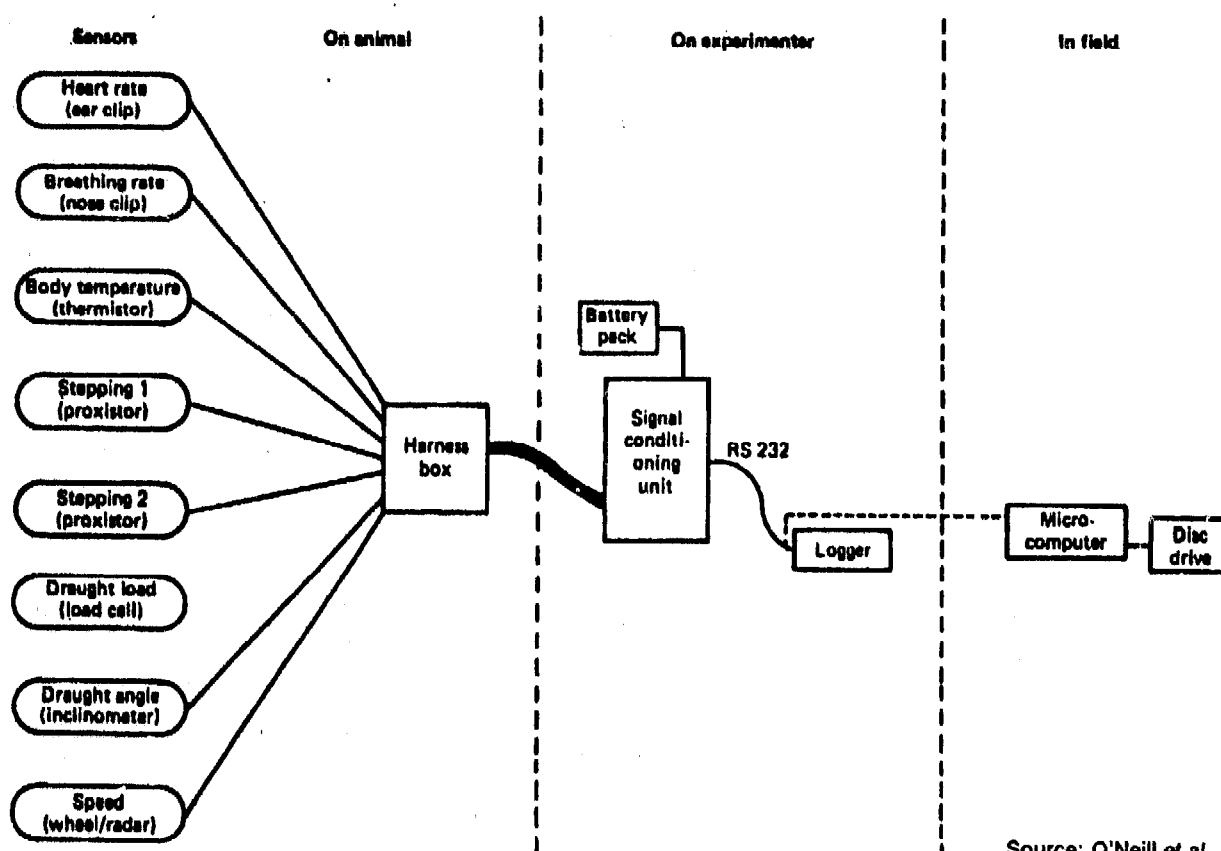
Implement draft force depends on many things (briefly discussed in the previous section) including implement size, shape, weight, width of work, depth of setting; soil type, moisture content, tillage history; vegetation quantity and quality; environmental obstacles, stones, stumps and roots; land slope.

The distance and speed moved depends greatly on the characteristics of the animals used: their species (different species have characteristic walking rates), their weight, size, strength, condition and their standard of training. The power output of an animal may be influenced by its past history (nutrition, disease, body condition, training, recent work experience) and its immediate environment (temperature, relative humidity, sunshine, ground surface). Different species and individuals may react to the environment in diverse ways. Some animals are better able (or willing) to withstand disease challenges or environmental extremes such as high air temperatures, bright sunshine or deep mud than

others. Humped cattle (*Bos indicus*), with very effective temperature regulation systems, are often able to work longer in hot conditions than humpless cattle (*Bos taurus*). Water buffaloes have relatively inefficient temperature regulation systems so that "over-heating" during prolonged heavy work is a problem, one traditionally solved when animals are allowed to wallow in water (Bakrie, Murray, Hogan and Kennedy, 1987; Pietersen and Ffoulkes, 1988; Pearson, 1989).

Farmers and research scientists have frequently observed tremendous differences in the apparent working abilities of animals of the same size and same species carrying out the same operation under similar conditions. (To put this in perspective: the animals might well draw the same conclusion about humans!). Some animals may rush and tire, some may be "slow starters" reaching peak work late in the day, and others seem to plod at the same rate whatever the time of day or environmental conditions. While farmers (and researchers)

Fig. 10-5: Diagram illustrating AFRC-Engineering computer-based data-logger system.



Source: O'Neill et al., 1987



Fig. 10-6: Measuring draft and work output in Nepal using a CTVM ergometer. The wheel trailed by the ard plow measured distance travelled. Wires from the loadcell and body sensors passed to a micro-processor (carried in a traditional head-basket in this case). Among other things, this study highlighted how different plowmen affected draft, speed and work rates.

Photo:
Anne Pearson

may well describe such animal work characteristics with varying degrees of admiration, contempt and colourful language, there are few objective ways of assessing differences in temperaments and mood. Such differences between working animals may be the result of complex physiological and/or psychological interactions between the animal and its environment over many years, including influences of previous training, disease, nutrition, work history and human company.

An interesting example of the influence of animal psychology on work rates is the observation that animals walk faster and have a higher work output when they are walking in the general direction of their "home" than when they are walking away from it; thus irrespective of field orientation and slope, plowing may well involve alternate "slow" furrows as the animals face away from the farm, and "fast" furrows as they move towards it. Pearson (1989) reported a similar effect during long-distance carting trials in Nepal when all animals slowed down before, and speeded-up after, the turning that marked the most distant part of the five-hour, 16 km route. Such

behavioural patterns can either be reinforced or counteracted by the operator, depending on human temperament or prevailing mood. Some animals, including some N'Dama oxen, seem to be able to set their own very clear working limit. After this apparent limit has been reached it has been observed that neither coaxing and persuasion nor shouting and beating seem to stimulate significant additional work (Starkey, 1981). Other animals, notably long-suffering donkeys, seem to be able to carry on working even when clearly exhausted, an attribute all-too-frequently exploited by humans.

The effect of acute forms of disease is obvious: an animal that is sick is unlikely to work well, and farmers know that working an animal that is unwell may exacerbate the illness. Milder or sub-clinical conditions that are not apparent from visual inspection, may also have a significant effect on work rates. An example of such a case was provided by Pearson (1989) who found that two apparently similar and healthy pairs of buffaloes in Nepal had different work performances. On investigation it transpired that the animals

that were less able to work, and which eventually had to be laid-off for some days of rest, were anaemic. There were no visible disease symptoms, but there was apparently some parasite (perhaps liver fluke) or condition that was causing anaemia and reducing work potential. In Africa, working animals may be challenged by numerous intestinal and blood parasites, including (in some areas) trypanosomiasis and tick-borne diseases. Little reliable data exists on the occurrence of sub-clinical diseases in working animals, nor on the effects these may have on work, but it seems reasonable to assume that such conditions may have a significant influence on the ability or willingness of individual animals to maintain a particular rate of work.

Human skills play a major role in establishing the rate at which work is achieved, by determining the effective draft of the implement, and by greatly influencing the walking speed of the animals and the number and length of rests and stoppages. As was mentioned in the previous section, Pearson *et al* (1989) found that during trials involving the plowing of terraces with traditional ards in Nepal, different plowmen tended to work the same animals at different speeds even when the environmental conditions were identical. Human practices may range from the single farmer effectively using only voice commands to encourage animals to walk at a brisk speed or pull a heavy load, to the violence and intimidation evident when up to four people attempt to beat animals into working faster.

Changing the working depth or width of an implement can have both simple and complex effects on work rates. Increases in working *depth* increase implement draft, and this causes animals to slow down and tire more quickly. This slows the overall speed of operation (and also changes the *quality* of work). Changes in the working *width* of an implement are more complex since they can affect working rates in two different and opposite ways. Increasing the working width means that

fewer passes are needed to cover each square metre or hectare of land; thus *at constant speed* increasing the working width also *increases* the rate of work. However as the effective width of an implement increases, so does its draft, and this may cause animals to slow down, particularly if the work is already quite hard. In extreme circumstances increasing the working width may cause work to stop altogether as animals become unable or unwilling to pull the implement further. Clearly in any one location, the optimal working width to maximize work output will change with different environmental conditions and the status of the animals.

While there is a positive correlation between the number of animals employed and the rate of work, the relationship is not always simple. As was noted in Chapter 2, at very low implement drafts, a single animal can work at the same rate as a team, simply by pulling the implement at normal speed. In such circumstances doubling or quadrupling the number of animals will make no significant difference to working rate, at least for the first few hours. However at higher implement draft, the single animal will slow down, while a team will be able to walk at normal speed and so work at a faster rate. If one pair can cope with a draft at normal walking speed, coupling an extra team will have no effect in the short term. However an extra team should allow an implement with even higher draft to be pulled at normal walking speed. The use of more animals per implement should allow working speeds to be maintained for longer periods each day or each week. Multiple hitching was discussed in Chapter 3 (section 3.6), where it was pointed out that in small fields two teams of two may be more efficient than one team of four, due to the greater manoeuvrability of small teams.

A large number of other factors may also affect working rates, including the way in which animals are harnessed, the field shape, contours and obstacles, the weather, the time of day and the way in which these influence the

Table 10-2: A selection of assessments of draft force, work-rates and force as a percentage of bodyweight reported in the literature. (WTC = wheeled toolcarrier; BBF = broad-bed and furrow)

Important note: These figures were collected under diverse environmental conditions and encompass very different standards of accuracy, repetition and scientific rigour. The information is provided for illustrative purposes only, and direct comparisons between the various frames without reference to the original sources is not advised. Some figures have been recalculated from different units or data forms used in the sources.

Country	Animals	Conditions	Implement	Force (N)	Work (m ² h ⁻¹)	Work (m ² d ⁻¹)	Force/weight	Source
Burkina Faso	400kg West African Zebu oxen (pair)	On-station; sandy-clay, early rains	25 cm plow 5-tine tillage		588 1250	2352 5000		Herblot, 1982
Ethiopia	250-320kg Ethiopian Zebu oxen (pair)	Farmers' fields after: long fallow: short fallow	Maresha ard plow	1195 928	199 222	424 510	23% 17%	Goe, 1987
Ethiopia	Single oxen: Ethiop'n Zebu 300 kg Boran x Zebu 372-465 kg	Farmers' fields	Maresha ard plow depth: 13.9cm 14.6cm	595 685	220 242	920 998	20% 24%	Abiye Astatke, et al., 1986
Kenya	310kg zebu oxen (pair). 385kg Friesian x Sahiwai oxen (pr)	On-station; rainy season	Mouldboard plow/weeder (averages)	968 885	720 730	2860 2910	16% 11%	Tessema & Emo-jong 1984
Madagascar	325kg Zebu oxen (pair)	On-station	Plow	811	0.69	560	12.5%	Scherrer, 1966
Morocco	270kg horse 460kg mule 420kg camel	On-station, level vertisols, winter rains	20cm plow	795 923 569			30% 20% 14%	Bansal, et al, 1989
Senegal	400 kg W. African Zebu oxen (pair)	On-station; "General" values	WTC with: Seeder (2 row) 120 cm weeder G'nut lifter (1) G'nut lifter (2)	450 600 450 750	1428 1250 770 1111		6% 8% 6% 9%	Nour rissat, 1965: Monnier, 1965
Sierra Leone	260kg N'Dama oxen (pair) 290kg single ox	Flooded swamp On-station, gravelly soil, rainy season	20 cm plow 17 tine harrow 20 cm plow 3-tine weeder	700 850 650 600	300 500 400 1100	900 1500 2000 2200	14% 16% 13% 21%	Starkey, 1981
Thailand	270kg swamp buffalo (single): No supplement Feed supplement	On-station, rainy season, rice fields	Local wooden beam, mould-board plow		972 1215	3900 4900		Konanta et al, 1986

Country	Animals	Conditions	Implement	Force (N)	Work (m ² h ⁻¹)	Work (m ² d ⁻¹)	Force/weight	Source
Bangladesh	250kg oxen (pair) 245kg single ox	On-station	Ard at 12cm	343	680		7%	Barton, 1988
			Ard at 10.6cm	231	660		9%	
India	530kg Malvi oxen (pair)	On-station; heavy black soils	15cm plow	550	309	2165	10%	Rautaray, 1987
			90cm disc harrow	500	1814	12710	9.5%	
			45 cm blade harrow	600	731	5120	11%	
			WTC with: 15cm plow	700	365	2550	13%	
			25cm plow	1200	392	2745	23%	
			2 × 15cm plows 2 × 25cm plows	1500 1950	496 nil	1490 nil	28% 37%	
India	450kg Hallikar zebu oxen (pair)	Vertisols; on-station BBF system; plowing & ridging after previous harvest; other operations during rains	Tropicultor					Bansal and Srivastava, 1981
			WTC with: 22cm plows (2)	2300	4000		25%	
			Ridgers (2)	1830	4000		20%	
			Harrow tines	1600	2272		18%	
			Bed former	1850	3030		21%	
			Planter	1020	3333		11%	
Weeding tines	1120	2500		12%				
UK	885kg Hereford/Friesian oxen (pair)	On-station	180cm harrow	2000	4633		11%	Barton, 1985

prevailing moods of the people and the animals. In practice the work rate at any particular time and place will depend on a unique set of variables. This clearly makes comparisons of rates for different operations, implements, animals, soils, seasons or locations very problematic.

A further problem of comparing work rates is the variable interpretation of what actually constitutes work time. The rate at which an operation is actually being performed can be calculated quite easily if animals are timed, and output assessed (e.g. area covered = distance × working width). Such "actual working time" calculations have the advantage of ignoring time lost by apparently spurious local factors (such as negotiating obstacles, untangling caught traces or even major implement breakages). Nevertheless figures which ignore

such wasted time are very unrealistic, since numerous "spurious" factors do occur, and do affect the work of a farmer. Realistic work times should include the *idle* times due to clogging, resetting and breakages. They should also include the *incidental* times of end of row turning, which are affected by many factors including the manoeuvrability of the implement, the shape of the plot and the number and proficiency of animals and people.

On-field *rest* times for people and animals can also be considered a component of realistic work rates; the number and length of rests may directly influence the rate at which work is carried out between rests. Data have been collected that support the idea that short rests, perhaps of only a few seconds such as those at the end of a row, are actually crucial in allowing animals to work steadily and keep

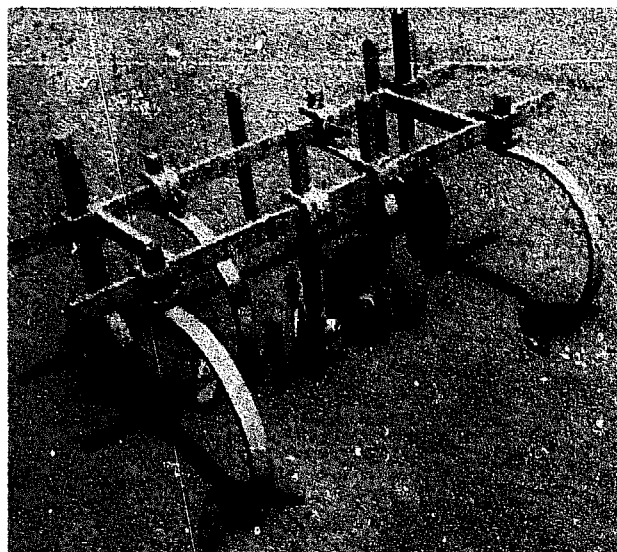


Photo: Paul Starkey

Fig. 10-7: Prototype intermediate toolframe that was developed for maize cultivation in The Gambia. While quality of work appeared good, factors affecting work rates (in comparison to the alternative, lighterweight, simpler Houe Sine toolbar) included: wide working width (faster); heavy draft (slower speed, more rests); low manoeuvrability and heavier weight (slower, longer time at turns, longer transport time from village to field); more complicated adjustments (slower, longer set-up time). In general the design was considered by farmers as "too heavy" and it did not develop past the stage of multi-locational on-farm testing.

their metabolic processes below stress levels (Kemp, 1989). Pearson (1989) noted that although buffaloes and cattle could walk at the same rate when carting over distances of 16 km, with loads of 500 kg, buffaloes had to rest and wallow every few hours to bring down their body temperature, which could rise markedly during work. Since the cattle did not need to rest during the work, their effective work rate was higher, and they were to be preferred in cases where time was of the essence. During trials in Costa Rica it was found that oxen performing "heavy work" (plowing with 1100N draft) only worked 77% of the "working time", while they worked 90% of the time when performing medium work (mowing with 600N draft) and 96% of the time when undertaking light work (carting with 214N draft). (Lawrence, 1989).

The time required for *preparation*, including the harnessing of animals and the *setting-up* and adjusting of equipment may also be considered part of the actual work. This is particularly important if the work rates of simple and complicated implements or harnessing systems are being compared, for time-savings on the field may require longer preparation times, and thus lower overall savings in time. Low adoption by farmers of three-pad harnesses for cattle, wheeled toolcarriers or precision seeders may be partially explained by longer preparation times. Finally it may be appropriate to include *travelling* time as part of the work. Naturally this will depend largely on the distance between farmers' homes or animal enclosure, and their fields as well as the nature of the path and terrain. However it will also be related to the ease of transport of the implement, and the nature and training of the team. The importance of travelling time may become particularly apparent when lightweight and heavy implements are compared in areas where field paths are narrow.

Agricultural engineers sometimes use the concept of *field efficiency* to compare different implements and working practices. Field efficiency is calculated as actual rate of work (also known as *effective field capacity*) as a proportion of theoretical rate of work (or theoretical field capacity). The theoretical rate assumes non-stop work, with no time at all lost in turns, rests or adjustments. The idea of field efficiency can be useful for comparing two implements, harnesses or working practices operating in identical conditions, for it highlights the importance of "time losses", that occur during manoeuvring or clogging. However while a theoretical, constant work-speed over several hours is not beyond belief for tractors that never tire, a similar concept for working animals begins to become absurd. Since the work rates of animals are so context-specific and the interpretation of "work time" so variable, field efficiency figures relating to draft animals can only be realistically compared if they derive from the same source.

It is apparent that realistic assessment of working rates requires information based on actual farmer experience, and this may be obtained with the help of enumerators, or simply by asking the farmers. In a detailed study in the Ethiopian highlands Goe (1987) cross-checked work actually timed by enumerators with estimates made by farmers who did not own watches. Farmers' estimates were generally slightly greater than the chronological records, but were within the standard deviation of the recorded times.

Having recorded the area worked and the overall time taken, one can obtain a figure for the work rate in terms of area per unit of time (e.g. square metres per hour), or in time per unit of area (e.g. hours per hectare). However a further complication is that farmers and animals may only be prepared to work a limited number of hours per day, and days per week. Thus an effective rate of 24 hours per hectare does not mean that one hectare could be cultivated in three 8-hour working days. In one farm survey, Ethiopian farmers often plowed for 7 hours a day, but they did not work with their animals for more than three consecutive days or more than four days a week (Goe, 1987). Elsewhere farmers may only work their animals three to four hours a day, with a day (or two) off every third or fourth day. Under such regimes, 24 hours of work might well take up to two weeks to complete. This has particular implications for operations in which timeliness is crucial. For example, where manual labour is readily available, operations using hand implements may well be completed *earlier* than if animal-powered equipment is used, even though the animal-powered work rate is much *faster* than the manual rate. Another factor to consider is that work rates seldom specify the *quality* of work achieved, although this is vital in assessing the comparative advantages and disadvantages of equipment and techniques.

It should be apparent that working rates determined entirely on research stations are

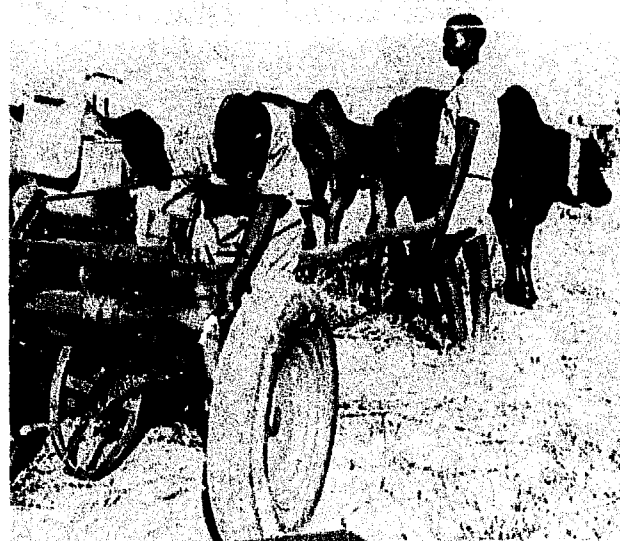


Photo: J. Rauch

Fig. 10-8: Adjusting a locally made wheeled toolcarrier in Zambia. Adjustment and repair times are an integral part of normal work, and these should not simply be ignored during research trials.

likely to be very different from those achieved by farmers. The effects of preparation, travelling and turning times are proportionately greater in small fields and small farms than they are when large areas can be worked at one time. Whether or not a farmer eventually selects a particular piece of equipment will depend not on optimal figures but on the working rates achieved in reality. This may explain why some useful equipment, apparently capable of improved work-rates, has been rejected by farmers.

One useful application of information on work rates is for preselecting equipment types for possible farmer evaluation. By comparing the working rates of different designs with each other, or with manual alternatives, an early impression may be gained as to whether an implement is likely to be cost-effective. In assessing published figures, it is essential to understand that they will have been obtained in unique circumstances, and it is important to clarify in one's mind the prevailing conditions (animals, soils, people, equipment, etc.). It is also crucial to be aware of what particular definition of work rate was being applied, with what degree of accuracy it was being



Photo: Peter Lawrence

Fig. 10-9: Measuring the force, distance, and work output of oxen during trials in Costa Rica

measured and over what period of time. In Table 10-2 some examples of work rates extracted from a range of publications are presented. The figures cited differ greatly in the circumstances under which they were obtained, the definition of "work time", the precision of measurement and the degree of replication, randomization and statistical analysis (if any). Thus the table as a single entity should be treated with great caution. While figures from the same source may be broadly comparable, it would not be wise to compare data from different sources without referring to the original publications for comprehensive details of the location, duration and conditions of the trials.

In conclusion, the concept of agricultural "work rates" should, as far as possible, refer to the combined actions of the whole working team (human-implement-animal). Although specific research studies may require concentration on individual elements and short-term measures of components, these should be *interpreted* from a farmer's perspective. Farmers' work rates have to be appropriate to their specific farming systems, including their animals, field conditions, cropping patterns,

economic and labour resources and their social aspirations. When undertaking a field operation a farmer usually has to walk at the same speed and for the same distance as the animals, and there may be occasions when a long but easy walk is preferable to a slow, hard slog; the need of animals for specific rests may coincide with similar desires in farmers. For some farmers in certain situations speed of operation and timeliness is crucial, and rapid operations can greatly affect final harvest. In other circumstances factors such as operator convenience and even outward "appearances" may be more important to the farmer. Even where speed is critical for the farmer, it is likely that the *overall* rate of work that can be achieved per day, per week, per season, per animal or per field will be more important than apparent "hourly rates".

10.3 "Light" and "heavy" work

Farmers and research workers are well aware of the obvious differences between work that is "light" or "heavy" but while such terms can be useful descriptors, there is a risk if these terms are used to oversimplify situations that are actually very complex. In particular there

are potential dangers if simple assessments of draft force or short-term power output are used to estimate whether the actual work that animals perform in a day is "light" or "heavy". Some people have attempted to estimate work output and energy expenditure from draft force figures alone, and for simplicity have assumed constant speed irrespective of draft and time. More commonly power output has been assessed by multiplying walking speed and draft force, with work being computed as a product of power and time. Such calculations alone may not give a true picture if they do not take account of significant variations in animal speed, rest periods and the distance that the animals move.

It has for many years been generally assumed that animals pulling heavy loads inevitably use more energy in a day than those pulling light loads, and this had led to detailed recommendations as to different levels of daily nutrition required for "light work" and "heavy work" (CEEMAT, 1971; CEEMAT/FAO, 1972; Reh, 1982). However in trials in Costa Rica it was found that, during the course of a 5.5 hour working day, animals performing light (carting with 200N draft), medium (mowing with 600N draft) and heavy (plowing with 1100N draft) operations actually used very similar amounts of energy, as calculated from work done, distance travelled and height ascended while working (Lawrence, 1989). This rather surprising result was explained as follows. Although the animals "working hard" were pulling a draft *five times* greater than when they had light work, they walked more slowly, at only 0.6 m s^{-1} , compared with 1.0 m s^{-1} when they pulled a light load. As a result their mean power output during actual "heavy" work was *three times* (not five times) that of the light work. Oxen took more rests while working hard and only actually worked 77% of the time, compared with 96% of the time when performing light work. Furthermore the animals performing heavy work walked 8.9 km during the 5.5 hour working day, while those undertaking light work

walked 19 km. The energy required for this walking was very significant: at the end of the standard working period the oxen that had pulled little but walked far, had often used up *more* energy than those that had worked hard over a shorter distance. Consequently, in this instance, the animals that had undertaken "light" work would have required at least as much food as those doing "heavy" work just to replace the energy used (Lawrence, 1989).

The energy the animal uses in walking has not generally been included in comparisons of work output for farm operations and would not be apparent from standard measurements of power output. Nevertheless it is clearly important, since it has a significant effect on the nutritional requirements of an animal, perhaps accounting for about one third of all energy expenditure during medium plowing and two thirds during carting along roads (Lawrence, 1985). In very muddy conditions, an even greater proportion of animal energy may be used simply in walking, for the energy cost of walking in 300 mm of mud may be almost double that in normal conditions (Lawrence, 1987).

As a result of their research in Costa Rica, Nepal and at CTVM, Lawrence and Pearson (1990) argued that actual work output of animals is limited by the overall rate at which animals are able, or willing, to expend energy for *all purposes*; that is not only for tractive pulling but also for walking, carrying and ascending slopes. According to Lawrence and Pearson, the energy that an ox can expend in a given period is dependent on its weight and the duration of work and ranges from 0.9 MJ per 100 kg bodyweight per hour for a 800 kg animal working eight hours to 1.7 MJ per 100 kg bodyweight per hour for a 200 kg animal working only one hour. These authors provided a table that allows such estimated energy availability to be read-off easily. They also provided an equation that could make use of this "energy availability" information to predict the distance an ox could reasonably be

expected to walk in a given time (and therefore the work it could perform), assuming the "average" draft force was known. The equation was:

$$d = \frac{300E}{F + 0.6M}$$

where d = distance travelled (km), E = energy available for work (MJ), F = average draft force (N) and M = weight of the ox (kg).

The authors note that when using such an equation, many variables have to be assumed to be constant, and that should the condition of the animal(s) or environment be less than ideal, predictions can be out by over 40%. Lawrence and Pearson readily admit that while their equation may be one of the most accurate means that *scientists* have at present for predicting work output, an experienced *farmer* might well be more accurate at assessing actual work, not in megajoules, but in farmers' own terms ("That pair of animals could plow that field in these conditions in three and a half hours").

The whole subject of draft animals, their energy utilization, working abilities and nutritional requirements is due to be covered in another book in this series, and so will not be discussed here. It is accepted that it is rather unsatisfactory to consider the different aspects of animal-implement combinations in separate volumes, particularly as an integrated approach to animal-implement-farmer combinations is being encouraged. However the separation of "animals" and "implements" has allowed the individual volumes in this series to be more manageable in size, and it is to be hoped that the books will be used together. In the context of the present discussion then the conclusion is simply that it can be dangerous to concentrate on work rates expressed only in terms of the implement interacting with the environment, for this may neglect essential information about the animals themselves, the total work they are doing and what they can realistically achieve in a given period of time.

10.4 "Average" power and "reasonable" work rates

Hopfen (1960; 1969) provided tables entitled "Normal draught power of various animals" and "Draught requirements of some farm implements for operations on medium loam soils". These figures have subsequently been quoted in other publications, although the weights of the animals (500-900kg for oxen and 400-700kg for "light" horses) are different from those commonly found in the tropics. A summary of the research trial results of Scherrer (1966) in Madagascar and West Africa were quoted in CEEMAT (1968, 1971); the CEEMAT publication was translated and published by FAO (CEEMAT/FAO, 1972); the results have since been widely quoted and considered authoritative, with expressions such as "according to FAO" being used to introduce the figures. Goe and McDowell (1980) provided a table with estimates of the draft capacity of different species drawing "implements" at high or low speeds, based on figures obtained from a wide literature review.

General tables, such as those mentioned above, have been useful at giving people "order of magnitude" estimates of working capacities. Nevertheless from the foregoing sections and chapters, it should be clear that local animals, implements, environments and people vary immensely. Thus concepts of "average draft" or "reasonable work rates" have little meaning in a book such as this. What is "reasonable" in the farming systems of one country or area, might be totally unrealistic in another location. Thus no prescriptive or suggested rates will be presented here, and the "illustrations" of the locally obtained results that have been presented in Tables 10-1 and 10-2 should be treated with appropriate caution. Anyone in need of more specific figures might be best advised to consult local sources of information (farmers or researchers) or those in neighbouring countries (making sure the specific conditions to which any figures refer are clearly understood). Fur-



Photo: Bob Munro

Fig. 10-10: Buffalo walking in mud during experimental trials at CTVM, Edinburgh, on the effects of environmental conditions on draft animal power. The mask (modified bucket) over the mouth allows expired air to be pumped away and analysed. This allows oxygen consumption and carbon dioxide production to be measured, so that the energy used during walking and working can be calculated.

ther sources of more detailed information are mentioned below.

"Reasonable" animal draft has sometimes been expressed as "sustainable" or "maximum" draft force as a proportion of body weight. This overcomes the problem of widely differing weights of animals and draft loads. Thus Hopfen considered normal pulling power to be one tenth (10%) of body weight for most animals, and 15% for horses. CEEMAT (1971) and CEEMAT/FAO (1972) reported that oxen could be expected to produce an average effort of one tenth of body weight on rough ground and 1/8th (12.5%) of body weight when plowing well-worked ground. CEEMAT estimated the sustainable force of donkeys to be 17-25% of body weight. CEEMAT (1971) and CEEMAT/FAO (1972) also suggested there would be a loss of 7.5% draft force per animal as a result of multiple hitching.

Watson (1981) put forward recommendations in line with those of CEEMAT/FAO, of 12%

for oxen and 20% for donkeys, less 7.5% per animal if multiple hitching was used. Reh (1982) quoted the CEEMAT/FAO figures but provided a table suggesting significantly lower sustained traction capacities, equivalent to 4% of body weight for oxen and horses and 16% of body weight for donkeys, with losses of 10-28% per animal attributable to multiple hitching. Goe and McDowell put the general figure at 10-14% of body weight for most animals walking at between 0.66 and 1.1 m s⁻¹, with more specific guidelines equivalent to 10-12% body weight for horses, 10-14% for oxen, buffaloes and camels and 10-16% for donkeys. These authors also accepted the CEEMAT figure of 7.5% reduction per animal as a result of multiple hitching.

Pathak (1984) considered that the earlier estimates of 15-20% of ox body weight of Vaughn (1945) had been too optimistic. Pathak advised that draft exceeding 8-10% of ox body weight might put an excessive strain on the animals if it were sustained for several hours.

Subsequently Kebede and Pathak (1987) reported endurance trials in which Ethiopian Zebu oxen had to pull draft loads of 5%, 10%, 15% and 20% of body weight for six hours per day for five days. Power and work output were higher at 10% and 15% than at 20% but Kebede and Pathak concluded that the animals were indeed capable of pulling 20% of their body weight on a sustained basis. Other figures from Ethiopia suggest that normal plowing (carried on for up to four days per week) involved pulling a draft of 17-23% of body weight for six hours per day, (Goe, 1987). Following a programme measuring tillage operations in India, Kemp (1987) suggested that "rule of thumb" approximations of 10% of body weight being applied for tillage tended to overestimate normal workloads actually being applied on a sustained basis.

For illustrative purposes, some examples of draft forces expressed as a percentage of animal or team body weight have been cited in Table 10-2. Some of these were calculated by the authors, but many were computed from overall mean figures contained in the publications. Research reports based on measurements over several hours have reported sustained work output when draft loads of 5-25% of body weight were apparently applied. When measurements were of shorter duration, percentage draft load appears to have been between 10 and 40% of animal body weight. No recommended values will be given here, since to state that an animal of a particular species or breed is capable of pulling a force of 10-15% of its body weight, still begs too much information on how that force is assessed and on hourly, daily or weekly working regimes.

Designers of implements and harnesses have to be aware not only of the normal working forces that animals apply to implements, but also of the high instantaneous forces that can occur in animal-implement combinations. Severe shock loads, that can be 5-10 times greater (and even more) than normal "steady-

state" draft, can occur when a moving implement suddenly hits a rock or stump. Animals that are startled, or which panic, may suddenly exert strong forces in unusual, unforeseen directions. Such shock loads can bend weak implements, break unsound harnesses or damage the animal(s) themselves. Designers have to allow significant safety margins of strength if implements and harnesses are to withstand shock loads. Instantaneous forces equivalent to at least 100% of animal or team body weight for oxen may be allowed for; even more if implements are pulled by horses.

10.5 High technology or simple assessment

Before microchips opened up the vast potential of data logging, much research on draft forces was based on readings from spring or hydraulic dynamometers. One of the more comprehensive studies was carried out in the 1960s in several countries in Africa by CEEMAT (Scherrer, 1966) and summarized in CEEMAT, 1971 and CEEMAT/FAO, 1972. Data from studies in many parts of the world were quoted and discussed by Goe and McDowell, 1980, who also provided some guide figures on the draft capabilities of different working animals.

It is interesting that technological progress in instrumentation does not appear to have invalidated these earlier studies, and it must be stressed that useful research can still be carried out using similar techniques. With all the sources of variation discussed in previous sections, it should be clear that in most circumstances the *interpretation* of data is more important than the "accuracy" of its measurement. There have been many cases where researchers developing implements have recorded very precisely the draft of an implement during on-station trials, only to find that the farmers subsequently rejected that implement as being "too heavy". In such cases many months of work might have been saved if the researchers had decided to put aside the dyna-

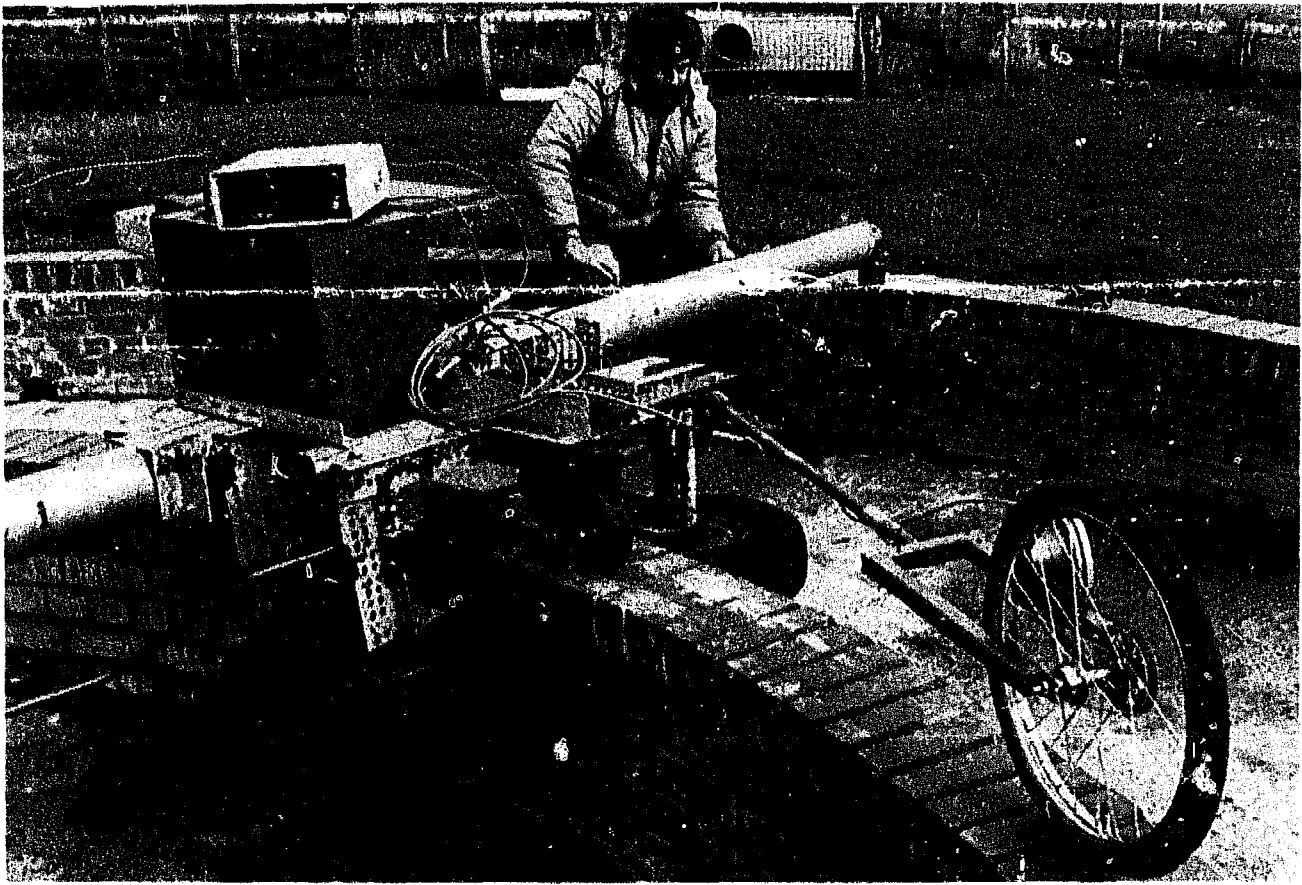


Photo: Bob Munro

Fig. 10-11: Detail of the ergometer used for draft animal research at CTVM, Edinburgh. Work load can be varied through the friction wheels that run round the inner wall, and distance is recorded by the bicycle wheel.

mometer and simply ask some local farmers to test the prototype with their own animals and on their own farms and give their "impressions" of whether the draft was likely to be acceptable or excessive. This should not be taken to imply that there is never any value in precise measurement and replicated experimental designs, for there are times when this is indeed important. However there are also times when people become so bogged down with data collection they cannot see the farmers for the figures!

This chapter has talked about "assessment" in terms of scientific measurements: newtons, metres per second, watts and square-metres-per-hour. Such units are important for permitting the exchange of information between scientists and professional agriculturalists but they mean nothing to the majority of farmers. Yet farmer "assessment" is crucial. All readers who hope that their own work will in-

fluence (directly or indirectly, in the long-term or short-term) the design, selection, production, provision or utilization of harnessing and implements must know that actual progress depends ultimately on the farmers and farmers' perceptions. For this reason researchers and development workers should try to incorporate farmer assessment as early as possible in any research-development initiative. Farmers will not use dynamometers, data loggers and calculators in their own assessments, and so it should be possible to develop local performance criteria with minimal equipment. "Farm area cultivated per average team per work day" may not seem scientific, precise or repeatable, but it may be much more relevant than the "knowledge" that an implement has "a mean draft of 857.8N".

For those whose research necessitates very accurate recording of draft force, power and work, computer-based systems of rapid data

collection and processing appear to offer great potential. They permit the precise and rapid recording of many of the parameters influencing draft and work rate but it must again be stressed that they are certainly not essential for research in this area. Computer-based systems are not cheap to buy and most importantly their use may well involve a huge investment in professional time and scarce expertise in order that the instruments and equipment are employed effectively and the large quantities of data produced are analysed. Small research-development projects may well decide that such time and money would be more profitably employed if estimates of draft and power are made with simpler instruments so allowing more time to be spent on studying the constraints in the local farming systems. A parallel may be drawn between socio-economic surveys, where "rapid rural appraisals" may yield *relevant* information more quickly and more cheaply than detailed surveys that involve mass data collection and analysis.

Notwithstanding the various cautions given, it is clear that data logging can be an extremely powerful research tool. It would therefore seem appropriate for programmes contemplating *detailed* research studies relating to draft and work rates to contact one or more of the organizations with experience in this very specialized field. This would allow both the technological options and possible research protocols to be discussed. Several of the organizations working in this field would warmly welcome cooperation, and some may have access to resources to allow collaborative research programmes to be undertaken.

10.6 Further sources of information

AFRC-Engineering, UK, has spent much time developing systems for recording draft and work rates. Their system (illustrated in Figs. 10-4 and 10-5) has been described in many articles, including Kemp (1985), O'Neill, Howell, Paice and Kemp (1987), O'Neill and

Kemp (1988), Howell and Paice (1988), and Kemp (1989). Field trials involving the use of AFRC-Engineering data loggers have been carried out by ILCA, Ethiopia; CEEMAT, France; CIAE, India and CTVM, Scotland. All these organizations have built up considerable experience in the application of this relatively new technology.

CTVM, Scotland, has developed its own system of data-logging "ergometer" for the measurement of work, draft force, distance travelled and actual working time. This has been employed in trials in Bangladesh, Costa Rica (Fig. 10-9) and Ethiopia. It has also been used in the research of the ACIAR Draught Animal Power Project, Australia. A more complicated system has been developed to allow three additional parameters (body temperature, breathing rate and stepping rate) to be recorded with the work output data. This has proved of value during trials in Nepal (Fig. 10-6; Pearson *et al.*, 1989). At CTVM itself treadmills and circular tracks have been fitted with gas-analysis equipment to allow detailed measurements of energy consumption for working and non-working animals (Fig. 10-10 and 10-11).

The University of Hohenheim in Germany has been collaborating with the ICRISAT Sahelian Centre in Niger in a study of draft animal power capabilities. Work has included the use of a test track and loading sledge to measure both average and maximal power outputs of single and paired oxen, horses and donkeys (Betker and Klaij, 1988).

Organizations in Africa undertaking research relating to the assessment of draft and work include FMDU, Botswana, ILCA and IAR (Nazareth) in Ethiopia, INRA-MIAC Projet Aridoculture in Morocco, the ICRISAT Sahelian Centre and Projet FAO in Niger and AD-PRDP in Zambia. The addresses of these and other organizations working in this field are given in the GATE Animal Traction Directory: Africa (Starkey, 1988).

11. The supply and manufacture of animal traction equipment

11.1 Existing facilities

Many countries in Asia, Latin America and in north and northeast Africa have had a long tradition of animal traction usage. In such countries equipment designs made of locally available materials have been developed over the centuries and equipment has usually been fabricated in villages and small market towns. In recent years some larger urban-based manufacturing enterprises have also been established. As a result, village artisans have often developed new repair and maintenance services for the factory-produced equipment, sometimes in addition to their traditional fabrication work.

In most Sub-Saharan African countries, animal traction has only been introduced this century and has been based largely on factory-produced steel implements. In the colonial era, most animal traction implements were imported from Europe. However a long-term objective of many governments in Sub-Saharan Africa has been the creation of local sources of animal traction equipment and the infrastructure to maintain such equipment at village level. As a result many countries have established workshops to fabricate animal-drawn implements. The addresses of many such workshops in Africa are provided in the Appendix, and further details can be found in the GATE Animal Traction Directory: Africa (Starkey, 1988).

In some cases, including Burkina Faso, Ghana, Guinea, Tanzania and Togo, factories have been established through government

development initiatives, backed by external aid donors. In other countries including Kenya, Malawi, Nigeria, Senegal and Zimbabwe the initiatives have been largely those of the private sector. There have also been workshops established with capital derived both from the public sector and the private sector (for example workshops in Mali, Lesotho and Tanzania). Some production has been in large factories (the SISCOMA/SISMAR company in Senegal; the UFI parastatal factory in Tanzania). Some other countries have been able to meet their national demands by small workshops (the government-established UPRONA enterprise in Togo; the private Agrimal workshop in Malawi). In Benin production has been organized through a cooperative (COBEMAG) established with government backing. In this system much of the component manufacture is delegated to village-based members of the cooperative, while final assembly and those operations requiring expensive equipment take place in a central workshop. In Burkina Faso equipment production was arranged through the governmental CNEA, Burkina Faso (Centre Nationale d'Equipelement Agricole) network which initially comprised two large and nine small workshops. The large workshops were capable of manufacturing most components including mouldboards and plowshares but only assembled sufficient equipment to meet the requirements of their localities. They supplied basic components to the scattered small workshops that undertook only basic welding, grinding and assembly work. For various organiza-

tional and economic reasons, the network was subsequently reduced in size and scope.

Most animal traction equipment workshops in Africa have surplus capacity and most could expand production if market demand increased and if the necessary inputs could be made available. Despite this situation, a high proportion of animal traction equipment being sold to farmers in Africa is either totally or partially manufactured overseas, often in industrialized countries.

There is probably no animal traction equipment factory or workshop in Africa, whether in the public or private sector, that has not faced major problems. These have included problems in the actual manufacturing and selling of suitable animal traction equipment, in establishing a balance between overproduction and underproduction, and ensuring economic independence and long-term viability. It is ironical that while the majority of animal traction equipment workshops in Africa were established with the assistance of one or more aid agency, some of the present problems are also linked to donor assistance.

11.2 Donor influences

In most Sub-Saharan African countries the supply of animal traction equipment is strongly influenced by development projects. Due to their abilities to purchase equipment in bulk, transport it to rural centres and provide credit for its purchase, development projects generally dominate the "marketing" end of equipment provision. Donor-assisted projects sometimes control manufacturing facilities and frequently monopolize importations. This inevitably distorts supply and demand patterns, and whether this distortion is beneficial or detrimental depends on local policies. All donor assisted development projects are answerable to the national governments and any decisions relating to the importation of equipment by a project must ultimately be the responsibility of the host government. In practice, governments, donor organizations and development workers know that the influence of bilateral and multilateral aid agencies in determining large and small decisions is very great.

It is well known, for example, that most donor countries state that equipment purchased with

Fig. 11-1: Stockpile of equipment at the SISCOMA factory in Senegal. When the national agricultural credit programme was suspended, sales of animal traction implements plummeted and SISCOMA became insolvent. The factory was acquired by SISMAR, committed to product diversification.

Photo: Paul Starkey

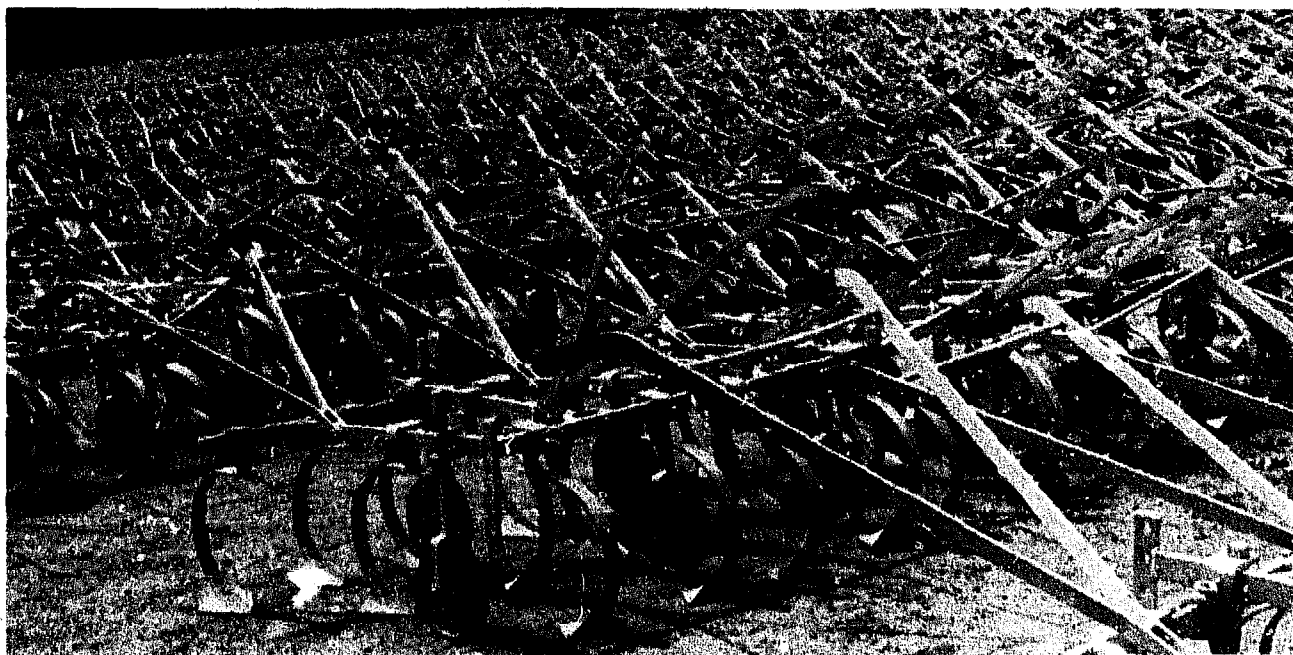




Photo: Paul Starkey

Fig. 11-2: At the UPROMA workshop in Togo, steel bars to make plow beams are heated in charcoal prior to being bent into shape manually.

their financial assistance should come from their own country, unless a waiver is agreed. As a result of such understandings, agricultural development projects supported by The Netherlands have generally ordered Dutch plows or materials, French-supported projects have made use of French designs, British-assisted projects have bought British equipment and when Italian funds have been channelled through a multilateral agency such as FAO, Italian implements have generally been ordered. In several cases bilateral or multilateral projects have imported whole implements, or components that could be made locally, *despite* the existence of local workshops with spare capacity. For example, importations have occurred recently in Burkina Faso, Guinea, Mali, Mozambique, Nigeria, Tanzania and Zambia. Admittedly such importation may have been because the local workshop was suffering from major technical, managerial, financial or supply problems. However in such circumstances projects and their supporting aid agencies have often found it easier, or simply more expedient, to bypass the constraint rather than to confront the root problems.

It must also be recognized that corruption (on several sides) may have sometimes distorted the supply of animal traction equipment, since generous "commissions" may have been available from the manufacturers or suppliers of implements or components.

Since the constraints experienced by workshops in developing countries directly or indirectly affect development projects, field staff and the farmers, some of the problems will be briefly reviewed.

11.3 Problems of local workshops

One basic problem, with which workshops making animal traction equipment have to contend, is the suitability of their implement designs. Few manufacturers can afford their own research and development departments, and where they exist they are naturally staffed by engineers, not agriculturalists. Manufacturers therefore depend largely on three main sources: prototypes or drawings produced by the agricultural engineers of local ministries and universities; the copying of samples from other countries; licensing agreements with foreign manufacturers holding patents on es-



*Fig. 11-3:
Simple workshop in
Burkina Faso made
from shipping containers
(on right of photo) and
roofing material. It was
designed to assemble
animal traction
implements
from components made
in larger workshops.*

Photo: Paul Starkey

established designs. The main problem with all three sources is the same: the manufacturer has to go to considerable expense to produce the necessary assembly jigs without being sure that the implement will sell. Seldom can workshop engineers judge the market for such specialized items; they generally rely on the advice of their sources. Many workshops have found out to their cost that their professional advisers were not fully aware of what the farmers wanted or could afford. Some workshops have had to seek second opinions on actual market demand after the management had been embittered by the failure of an expensive production run to sell. Some interesting material is available relating to the difficulties Tanzanian manufacturers and agricultural engineers experienced in identifying suitable designs and on possible national policies to prevent the recurrence of such problems (Kjærby, 1983; ILO, 1987c).

Economic distortions

In several countries, including Angola, Mozambique, Nigeria, Sierra Leone, Tanzania and Zambia, exchange rates fixed below those considered acceptable by the commercial sector have seriously affected the economics of local production. In circumstances where there is a major difference between the official exchange rates and the parallel (black market) exchange rate there can be very severe distortion of local manufacturing costs. Implements purchased and imported at official (low) rates of exchange often appear

cheap compared with those manufactured locally. It may even be significantly cheaper (at official rates) to import equipment than to make it locally. This is frequently the case even when primary raw materials such as steel are imported at official exchange rates, for local manufacture inevitably requires some expenditure within the local commercial sector (for example for purchasing welding electrodes, bottled gas, hacksaw blades or even "gratuities" to obtain scarce resources). In countries that have "parallel" rates of exchange, such local purchases will normally involve paying the prevailing commercial prices that have been inflated by black-marketeering. In such circumstances some workshops may opt for keeping production going by buying expensive and possibly illegal goods and services from the commercial sector. Other workshops may insist on obtaining goods and services at lower prices, even if it involves very slow, official channels and even if the resulting delays result in total cessation of production for days, weeks or months. Neither alternative is desirable, and both effectively increase the actual costs of implement production.

In many countries, including Nigeria and Zambia, there have been preferential customs tariffs for complete agricultural implements, while the importation of steel and welding rods for the local manufacture of similar implements was subject to customs duties. In some countries including Senegal, workshops

have had to add Value Added Tax to locally produced implements, whereas imported implements may have been exempt from this tax. Furthermore whatever the local customs tariff structures, most aid donors make it a specific condition of aid agreements that project supplies should be admitted duty-free. This is administratively simple for consignments of ready-manufactured equipment, but it is difficult or impossible to recover duty already paid on materials purchased within the country for the local fabrication of implements. The result is that projects can often make implements available to farmers more cheaply through importation than through local manufacture; low implement prices for farmers may seem an irresistible, short-term argument in favour of importation, even though a broader view might well indicate that an importation policy would be detrimental to the long-term goal of sustainable local production.

Limited capital and associated cash-flow problems can be particularly serious for agricultural manufacturers. Ordering specialized steels in small quantities is disproportionately expensive, while bulk orders require a long commitment of tied capital.

Production runs

For efficient workshop management regular monthly production is desirable, yet animal traction equipment sales are highly seasonal. Poor weather, poor harvests or simply a change in policy of an agricultural credit bank can cause anticipated sales to drop drastically. Few local manufacturers can afford to maintain large stocks of manufactured equipment or raw materials, yet the administrators of development projects expect to be able to order, receive and pay for consignments of equipment in a short space of time. The short contract periods of donor projects tend to favour the foreign manufacturers with more rapid access to raw materials and working capital. The ability of manufacturers in industrialized countries to meet tight production schedules,

usually more than compensates for the delays attributable to shipping, and so overseas manufacturers can often meet contract deadlines more rapidly than local manufacturers.

Workshop location

Workshops designed to produce animal traction equipment have often been established in rural areas. This may have eased the cost of distributing the manufactured equipment, but increased the difficulty in obtaining reliable supplies. Many rural workshops in Africa have been severely disrupted by unreliable electricity or fuel supplies. Such problems may be common to many other local industries, but not to foreign manufacturers.

Quality control can be a problem in any workshop, but in developing countries salary structures often accentuate this. The low cost of unskilled and semiskilled labour and the high cost of imported equipment limits the adoption of automated processes that might standardize the cutting, punching, bending and welding of components. The high availability of semiskilled labour tends to restrict the potential salaries of very skilled welders in established workshops, and this leads to a high staff turnover as skilled workers seek more remunerative employment. The cost of management time is high compared with labour (particularly so if expatriates are involved) so that for financial reasons quality control procedures are often neglected. The rural location of many workshops also restricts supervision since management staff often spend time in urban centres arranging supplies or negotiating with government departments. The overall effect can be the fabrication of very variable products; this increases pressures on development projects to import ready-made implements which are generally assumed to be of higher quality. (This assumption that imported implements are automatically of high quality is dangerous, since implements imported from industrialized countries can range from excellent to abysmal).

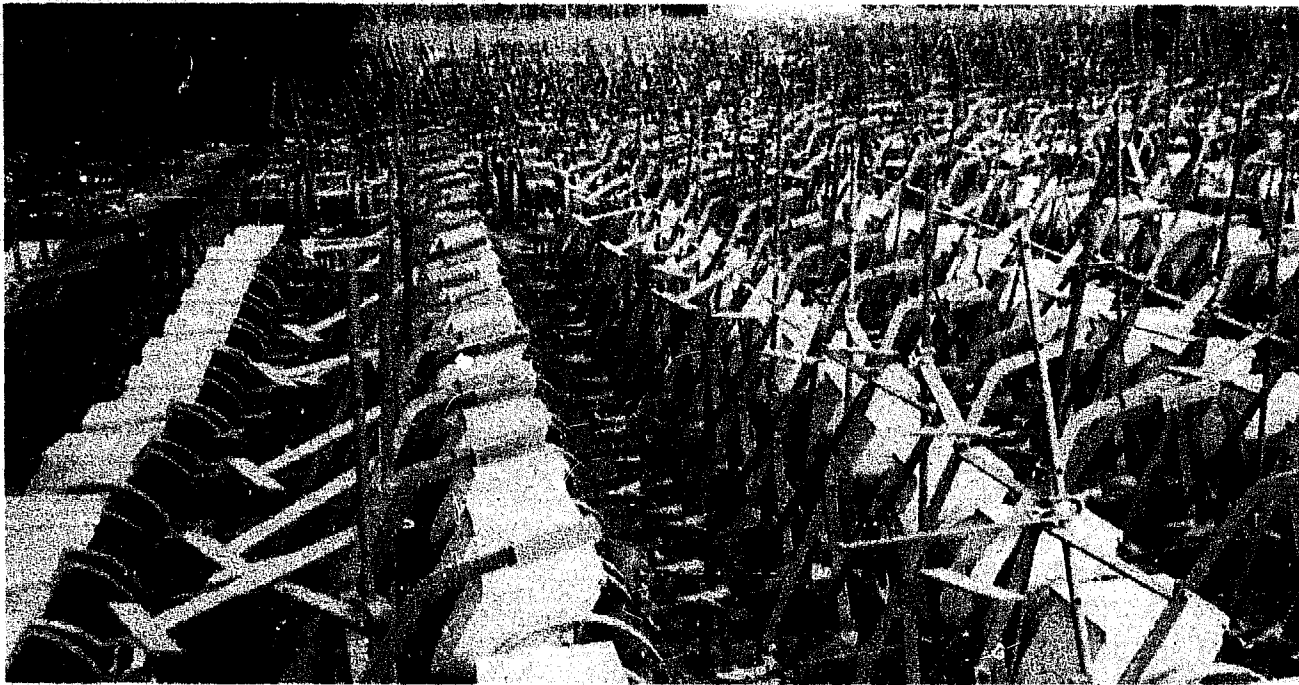


Photo: Paul Starkey

Fig. 11-4: Stockpile of imported seeders in Mali. Since they were supplied by tender, who is now responsible for modifying them to meet the needs of local farmers?

Bureaucracy

Public sector workshops may have particular problems in dealing with, or being part of, government bureaucracy. While small private workshops and traders usually respond quite rapidly to changes in demand, and do not continue to produce equipment that is not selling, government and parastatal workshops often work to targets determined more by their annual budgets than by market forces. There have been many examples of parastatal factories unable to meet genuine market demands for their products simply because their fixed budgets have not been sufficient to meet the requirements for materials. There have also been cases of the overproduction of unwanted equipment for which funds had been budgeted.

Donor-financed imports

The more a local manufacturer has problems, the more donor-assisted projects will tend to import foreign equipment, so exacerbating the situation. During the early 1980s several West African manufacturers, established with varying degrees of government support, found themselves trapped in the descending spiral of

limited capital and low sales as donor-supported projects financed the importations of implements. Private manufacturers and others free to develop their workshops have generally diversified into other manufacturing activities: few independent manufacturers would want to return to the problems of plow production having enjoyed the cash-flow advantages of manufacturing steel windows and burglar bars, items with regular and sustained demand, minimal administrative procedures, private sector funding and low demand for special steels.

With all the problems to contend with, it hardly seems surprising that few local workshops in Africa have managed to produce, on a regular and sustained basis, reasonable quality animal traction equipment at a low price.

11.4 Policy implications

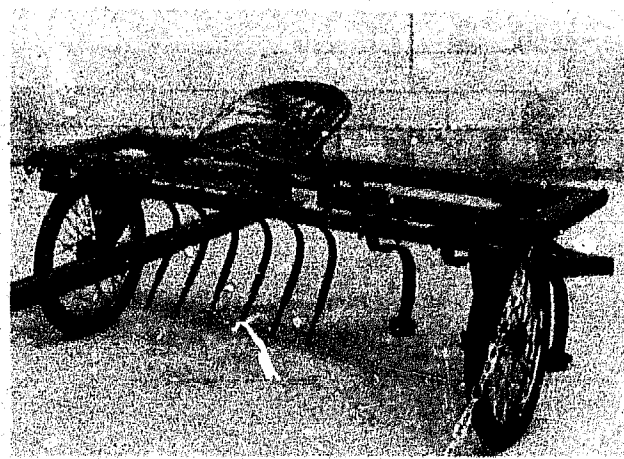
Local manufacture is a universal and natural aspiration of all countries. Nevertheless it is not necessarily cheaper than importation. Since few African countries are likely to have

steel manufacturing facilities in the foreseeable future, implements will continue to have a significant foreign exchange component whether they are imported or locally produced. While local manufacture provides employment, if workshops are underutilized the social and economic benefits of this may be offset by high overhead and recurrent costs. Such costs may be greater than value added to the basic steel by full manufacture overseas. Thus in only a few cases is the main advantage of local production *financial*. Nor can the main advantage be self-sufficiency when local production is highly dependent on imported steel. The most important policy justification for local manufacture should be the potential for *rapid feedback* between the end-users and the manufacturer. As has been noted, this valuable advantage has often been neglected.

Appropriate designs

If public sector organizations (governments and projects) continue to be heavily involved in the supply of equipment to farmers, policy decisions ensuring that the equipment is of *appropriate design* may be more important than those relating to *source of supply*. There have been many recent examples of project administrators ordering (locally and internationally) implements that were very unsuitable. Often it took months or even years for the lessons to be learned, since the lack of uptake was blamed on farmer conservatism and poor extension effort, rather than on inadequate equipment selection.

A few examples will illustrate the problem of projects ordering by tender. For several years in Northern Nigeria, the standard tender documents of a major multilateral agency specified that animal traction equipment packages should include mouldboard plows. To date most of these remain unused, since farmers in the area habitually use ridging plows. In one tender contract in Zambia plow beams were received with small mild steel plates welded on, simply to make the relatively light beams



Source: Archives of Ministry of Agriculture, Mozambique

Fig. 11-5: Following an international tender, significant numbers of these Lioness wheeled toolcarriers were selected for importation into Mozambique. As may be apparent from this picture, they had not been selected in consultation with the farmers of Mozambique or by those with a detailed knowledge of the local farming systems. Several years later, most had never even been assembled.

meet the weight specified in the tender documents. In Mozambique several aid agencies financed the importation of wheeled toolcarriers. Although no wheeled toolcarrier design has ever had long-term success at farm-level in Africa (Starkey, 1988), one large and expensive consignment of toolcarriers imported into Mozambique proved to be particularly inappropriate. The implements had bicycle wheels that were weak, narrow and puncture-prone and clearly unsuitable for farmers' fields (Fig 11-5). Their "500 kg cart" was minuscule and off-centre, and to prepare a toolcarrier for weeding required changing at least twelve different nuts and bolts. To anyone aware of field conditions in Mozambique, the implements (that had been designed and manufactured in Europe) were inappropriate. Nevertheless they apparently conformed to the letter of the tender specifications of the international agency that funded the purchase. Most implements from that very expensive importation remain unused. Near them, in Maputo, are stocks of plows imported from Brazil by another aid agency, in an attempt to promote "South-

South" cooperation. These plows have shares and mouldboards of the specified dimensions, but these and the landside are all *welded* onto the frog piece. With no provision for *bolting on* spare parts, these implements are effectively, one-piece, disposable plows! Many projects and organizations in Africa could cite similar examples of time and money being wasted through tendering procedures that failed to specify what the farmers really needed.

It is therefore very clear that whether policies favour the importation of equipment, the use of large local factories, or the establishment of small rural workshops, procedures should be clearly defined to ensure that those responsible for ordering or manufacturing the implements are reliably informed of farmer needs and farmer reactions.

Standardization

Another major problem with the purchasing of equipment on international tender is that equipment from different suppliers will vary, making the subsequent supply of spare parts

difficult. Standardization of designs and components can assist manufacturers, distributors and users. The agricultural engineer Jean Nolle, designer of the *Houe Sine multicultureur* toolbar that has become widely used in West Africa, considered standardization and interchangeability of components between implements to be a major design objective (Nolle, 1986). He developed ranges of equipment with some standard specifications so that clamps or even plow bodies could be used on different implements. Standardization has to be carefully balanced with other design criteria, but in general it is desirable. Standardization can allow manufacturers to stock smaller ranges of steel sections, use fewer jigs and allow suppliers to stock smaller numbers of spare parts. With so many small workshops in Africa, some of which have to import specialized steel sections or even manufactured components, there is much scope for regional cooperation and standardization.

Small workshops

Despite the large over-capacity for plow pro-

Fig. 11-6: Stockpile of plows imported into Mozambique by a donor-assisted project. The plows have numerous technical defects: for example the mouldboards and shares have no bolts but have been welded into place, making replacement in a small village almost impossible.

Photo: Paul Starkey



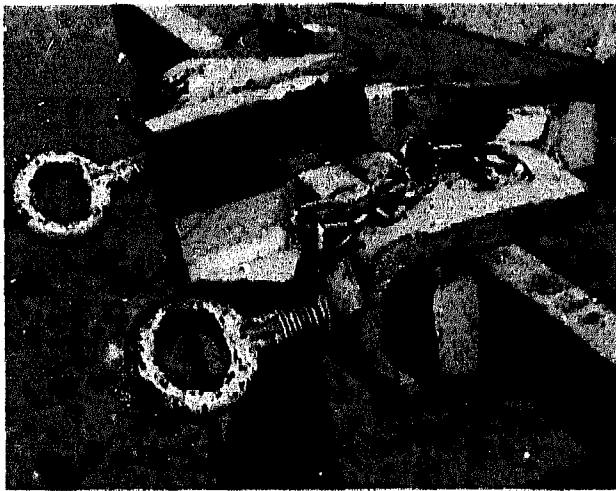


Photo: Paul Starkey

Fig. 11-7: *Clamp from Houe Sine toolbar. As part of Jean Nolle's philosophy of standardization a similar clamp is used on several implements. Should the thread strip, it is relatively easy to repair/replace in a remote village.*

duction in Africa, new workshops are still being established, generally through aid projects. Increasingly these are small enterprises in rural areas using bought-in (often imported) components. One advantage of such small workshops is that they are generally near the end-users, making it easier for farmer feedback to reach the manufacturers. They should also assist in the provision of spare parts. The main disadvantage is that the small workshops themselves may not be viable (unless they divert their efforts into assured products such as windows and burglar bars!). Moreover while they are in the initial, highly-subsidized, aid-project stage, they may marginalize still further any existing factories or workshops in the country, particularly if these are already in difficulties.

11.5 Project options for the supply and manufacture of equipment

There are few countries in Africa where animal traction equipment is manufactured and distributed on a truly "free-market" basis. Exceptions include Ethiopia, where small-scale artisanal manufacture predominates, and Zimbabwe, a steel-producing country. In the majority of other countries in Africa, the distribution and manufacture of animal traction

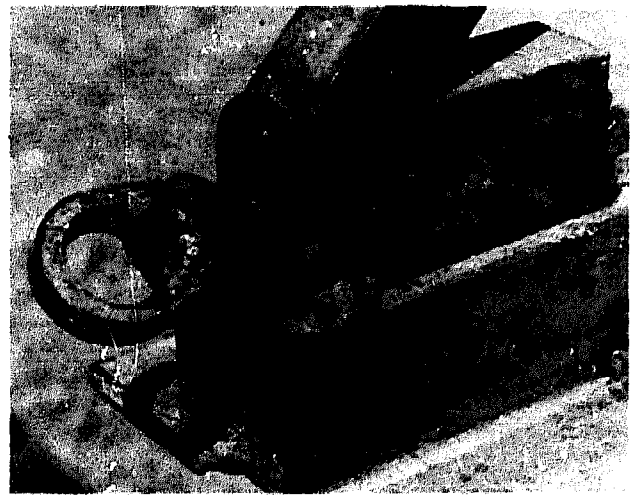


Photo: Paul Starkey

Fig. 11-8: *Clamp on an early Anglebar toolbar. When the thread stripped or broke, the whole frame needed to be taken for repair. This problem was identified only when the implement was tested in a remote village without a modern blacksmith.*

equipment is heavily dependent on the prevailing policies of governments and assisting aid agencies. The market for animal traction equipment is often precarious, due to the limited purchasing power of small scale farmers and the vagaries of the climate. Perceived short-term shortages of implements have often been "solved" by the importation of large quantities of manufactured equipment, or components for local assembly. Such importations have usually been subsidized and have marginalized still further the local suppliers, who have often turned to ventures that are less prone to risk. The subsequent (often unofficial) diffusion of imported equipment to different areas of the country and even across state boundaries has often distorted market structures well outside the intended target area.

In general, the interests of small-scale farmers would be best served by *assured access* to *well-adapted* equipment that is *modestly* priced. If local manufacturers are to meet this, they require a good understanding of actual farmer needs. They require information exchange systems to ensure that they can receive feedback directly from the end-users. Without the views of farmers, field workers or committed sales agents manufacturers cannot assess the relia-

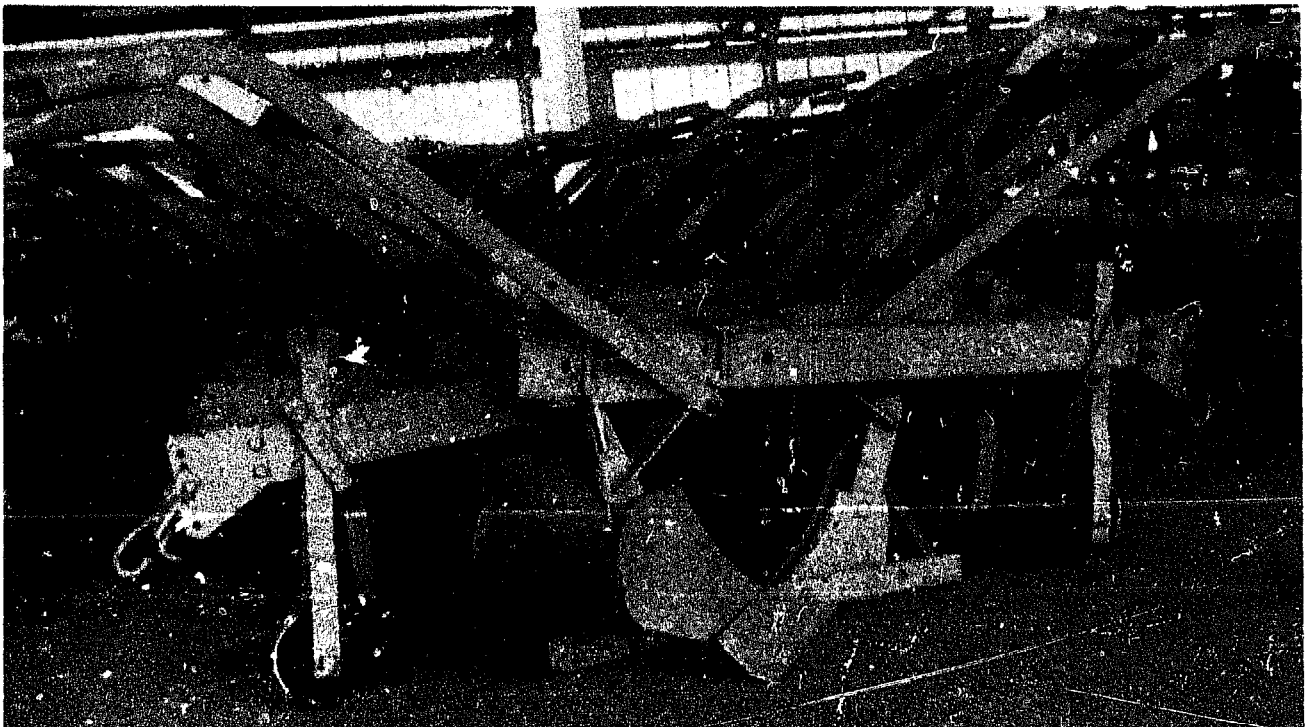
bility of the opinions of the many local or expatriate "experts" willing to offer advice and/or designs. In only a few circumstances is the pattern of animal traction equipment sales in African countries likely to support sustained production or commercially justify the opportunity cost of the manufacturing capability. This implies that public sector funds will be required to support local production, by providing working capital or assured markets.

Existing international tendering systems favour external producers. Newly industrialized "South" countries such as India and Brazil are increasingly capable of undercutting established firms in the "North" on price. It remains a matter of opinion as to whether there are significant quality differences between "North" and "South" manufacturers. However the experience of many African countries illustrates that there is no assurance that equipment ordered by international tender will prove to be of suitable quality or design.

In most countries, the weakest link in the whole equipment manufacture and supply process has been that between the suppliers of equipment (manufacturers or distributing organizations) and the end-users. Liaison at this level is essential in order to ensure that equipment designs are appropriate. Past neglect of such linkages has often resulted in workshops or projects manufacturing or importing unsuitable implements. The proliferation of donor-assisted aid projects in Africa has meant that indigenous and foreign implement manufacturers have learnt the sad truth that for them the actual market for the sale of their production is not the farmer, but the donor-assisted projects. In most cases it has been project staff, not farmers, that have defined specifications and requirements. It has been projects that have been able to order in bulk. It has been projects that have decided whether implement quality has been acceptable and paid the manufacturer. The provision of subsidies and credit combined with a lack of alternative implements (projects often have effective monopolies in equipment sup-

Fig. 11-9: Wooden beam plows stockpiled in Zana Zu Kilimo factory, Tanzania. Large-scale production had started before farmer acceptance had been ascertained.

Photo: Paul Starkey



plies) has allowed donor-assisted projects to unload stocks of relatively poor equipment on local farmers. Only when equipment has been exceptionally bad has it remained in project stores. This has meant that neither African nor overseas manufacturers of animal-traction implements have had much financial incentive to ensure their implements have met the needs of local farmers. For the manufacturers, the best short-term strategy has been to sell their production to individual projects. Their best longer-term strategy has simply been to find other donor-assisted projects. There has been almost no incentive to establish communication channels between manufacturers and the ultimate end-users of the equipment. As a result of this sad situation, there are now few places in Africa where feedback from farmers can rapidly affect the specifications of implements available for them to buy.

For the farmers, the ultimate *source* of implement supply is of less importance than its design and quality, assuming spare parts are available locally. In general, farmers have no influence on the source of available implements, this being determined by governments and donor-assisted projects. In the past such decisions have often been taken on the basis of short-term expediency, perhaps in response to a specific offer from an aid-donor or to relieve a temporary national shortage of implements. The lack of long-term planning has sometimes led to initiatives for the supply or manufacture of implements being prejudiced by subsequent national planning decisions. There have even been examples of both private sector manufacturers and government-backed projects being detrimentally affected by parallel initiatives (supported by different donor organizations) that have been attempting to increase equipment supplies in other ways. While the importation of different types of equipment can provide farmers with valuable choice and manufacturers with more competition, it can also wreck the slim prospects of local manufacturers already experiencing difficulties. Unless countries define, and

adhere to, clear policies relating to the supply of animal traction equipment, further well-meaning attempts by projects or aid agencies to manufacture or supply implements may well risk being undermined by other, uncoordinated development initiatives.

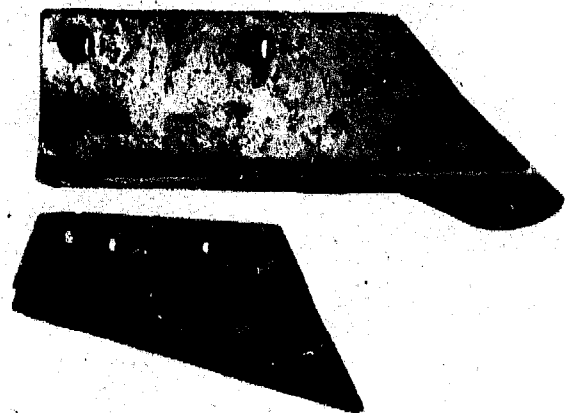
11.6 Spare part provision

One of the most commonly reported constraints to the efficient utilization of animal traction equipment is the lack of spare parts. Difficulty in obtaining spare parts is a major cause of abandoning good implements well before the end of their useful lives. It is also a cited excuse for giving up the use of equipment that was never particularly favoured. Where equipment is really useful, farmers in conjunction with local artisans will go to great lengths to obtain or make spares. To take examples from Sierra Leone: farmers and blacksmiths in some areas kept plows in regular use for over 30 years despite the absence of spare parts; yet in other areas plowing with animals ceased altogether when the plows first needed replacement parts.

The speed at which parts need to be replaced will depend on the conditions of use. Soil type and condition at the time of use together with the quality of the steel will determine how

Fig. 11-10: Plowshares used for just two weeks in abrasive soils, shown resting on top of new shares. In such conditions, farmers may require at least two new shares per season.

Photo: Paul Starkey



quickly plowshares, landsides and cultivator points will wear. Shares and cultivating points may well require re-working or replacement every season. Wheel bearings wear quickly when abrasive soil enters between the axle and wheel hub; many land wheels presently in use wobble eccentrically or squeak irritatingly, and some have had to be abandoned, so reducing the ease of obtaining good quality cultivation. Traction chains, clamps, mouldboards and countersunk bolts do not need to be replaced frequently, but when they do, they are specialized items that may be difficult to improvise if they are not readily available.

The care that farmers take of their implements will also determine the need for spare

parts. The regular oiling and greasing of bolts and moving parts may extend the lives of such parts markedly. Protected storage, combined with cleaning, greasing and oiling, should both facilitate the ease of adjustment and reduce the need for subsequent repairs. Regular replacement or reworking of plowshares will prevent wear to the frog piece and plow body. Restrained application of manual force when tightening ring bolts with a tommy bar will reduce the stripping of threads and the damage to implements. The use of pliers, or spanners, of the wrong size may result in rounded nuts and bolt heads that will then require workshop equipment to remove.

In areas where animal traction is being introduced, farmers may well require specific information relating to the care and maintenance of equipment. Initially farmers are often unaware of the limited strength of steel implements, for example the ease with which a plowbeam can bend if misused as a lever. Even after careful instruction, many people have to learn from bitter experience the delicate balance that exists between a bolt that is too loose and an over-tightened thread that is stripped and needs to be cut off or drilled out.

In general, national systems for the supply and distribution of animal traction

Fig. 11-11: Trader selling spare parts at small market in Mali. Some are imported components, some have been made in a local factory, some have been made by blacksmiths and some are second-hand.

Photo: Paul Starkey



spare parts have proved difficult to maintain. It often seems that only when demand is sufficiently assured for local artisans and small traders to find it profitable to specialize in this area, that problems become reduced. For example in parts of Senegal and Mali the level of animal traction has allowed private traders in the informal sector to specialize in spare parts provision. In these countries, traders are present in all local markets selling a wide range of parts derived from national-level factories, blacksmiths and second-hand equipment.

Perhaps the biggest problems with national systems relate to the maintenance of stocks. Manufacturers, importers, retailers, traders and even projects do not like to have large quantities of capital tied up in stocks of slow-moving spare parts. Demand is highly seasonal and weather dependent, yet decisions on stocks have to be taken long before the actual demand can be assessed. Another problem is knowing the relative needs for spares, particularly on new lines of equipment. In some cases, the equipment may not prove to be useful, and any stocks of spares will be totally wasted. In other cases a national or local requirement pattern will be rapidly established, so that it will be clear that for every 1000 implements in use, there will be an *average* demand for specific quantities of shares, points, frames, bolts, handles etc. However while such a pattern may be statistically valid for a large area, few local depots will experience the ideal "average" demand. In practice local depots have the choice of overstocking to ensure all needs will be met, or accepting lower stocking rates, knowing that some items are likely to sell out and become unavailable. Large numbers of small depots throughout a country will be most efficient in terms of having accessible



Photo: Paul Starkey

Fig. 11-12: Cart bodies made by carpenters in small town in Mali.

sources of supply close to farmers. Yet the greater the number of depots, the greater the overall national stock that has to be maintained if each depot is to be able to meet average demand in its own area. In theory the ideal situation would be based on large national or provincial depots, with very efficient systems for rapidly supplying parts to many small outlets. Problems of communications and management make such systems difficult to establish, particularly since such an efficient system is unlikely to be justified on economic grounds.

An example of the decisions that have to be taken when arranging a national system of spare parts may be seen from the experience of Malawi during the period 1974-1984. In this country, the supply of animal traction equipment and spare parts has been largely the responsibility of the private sector or commercially orientated parastatal organizations. National distribution was for several years assured through the network of depots of the national marketing board (ADMARC) which sold equipment nationwide at a fixed price which provided minimal profit. The marketing board was charged with being commercially viable, and it eventually decided it was not cost-effective to maintain this service unless the manufacturer was prepared to sup-

ply the stocks on credit, being paid for only when sold to the farmer. The manufacturer (Agrimal) wanted to benefit from the high level of sales that the comprehensive national distribution system of the marketing board could ensure, but it could not commercially justify so much of its working capital being tied up in slow-moving stocks of spare parts in different parts of the country. Thus the marketing board stopped supplying equipment and spare parts, and private chains of retailing hardware stores undertook the supply. These were also faced with slow-moving

Fig. 11-13: An artisan specializing in making and repairing carts in Egypt. While he increasingly uses wheels obtained from old motor vehicles, he still makes and repairs wooden-spoked wheels and in his hand is a cast iron bearing from a wooden hub.

Photo: Paul Starkey



items that took up storage space and management time for relatively little annual profit. The retail chains therefore decided to stock only the most needed items, such as plow shares. As a result farmers and extension workers still complained that they could not obtain all the necessary spare parts.

In some other countries, similar difficulties were experienced at local level, so that externally assisted development projects decided to meet local demand for both equipment and spares themselves. In so doing they bypassed and effectively eliminated commercial attempts to meet the demand, so achieving short-term benefits at the expense of long-term structures.

While the provision of implements such as plows has a certain appeal to aid donors, the supply of spare parts is less attractive, and has often been neglected. Although spare parts require considerable working capital, they are often classified as recurrent items and so are entered in different sections of national and donor budgets. There have been examples of absurd situations in which national governments have found it easier to request completely new implements from aid donors, than to obtain the provision of spare parts.

11.7 Artisanal manufacture, modification and maintenance

A clear distinction can be made between artisanal production and the medium to large workshops referred to earlier in this chapter. While the large workshops are usually orientated towards meeting national or provincial markets, artisanal production is usually aimed at a more local market, perhaps one large village or the area surrounding a small town. Artisans may range from farmers who are also part-time traditional blacksmiths, to small workshops employing several people and some modern equipment. Such artisans generally have low levels of stock and capital equipment, and often operate in the informal sec-

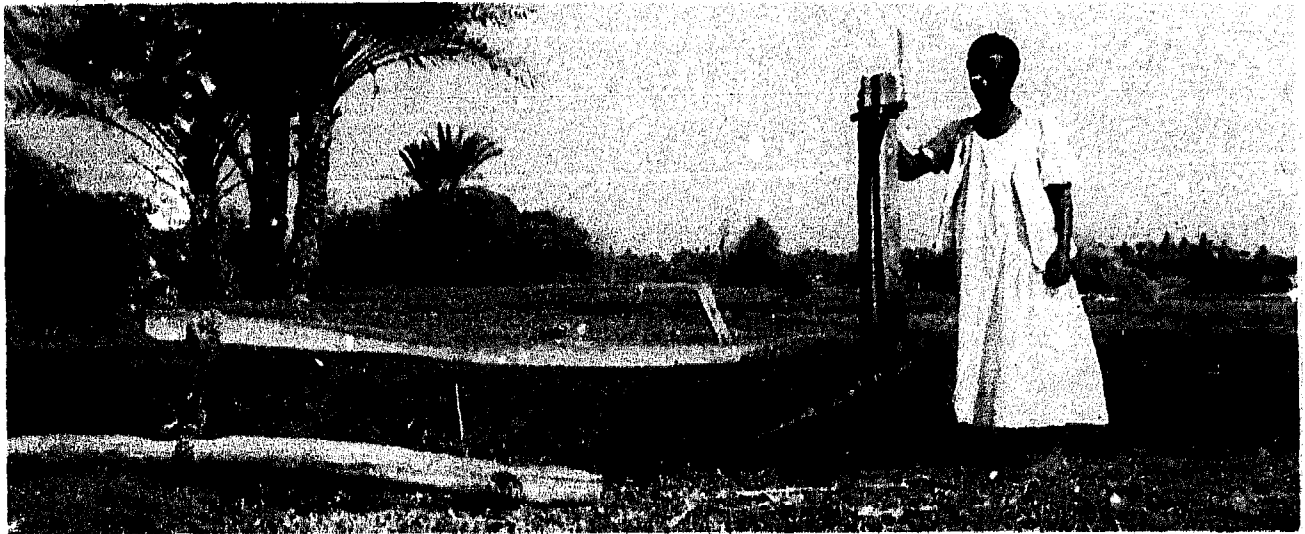


Photo: Paul Starkey

Fig. 11-14: Egyptian farmer with a new ard plow bought in 1988 from the local village artisan for US\$25.

tor. UNIDO (1983) defined three categories of such artisans:

- **Traditional blacksmiths** who generally only use traditional tools and a charcoal fire and who usually work at ground level;
- **Modern blacksmiths** who generally operate from a standing position and use some non-traditional equipment such as shears, grinders, vices, steel anvils and gas or arc welding sets;
- **Modern rural mechanics** who specialize in the repair and maintenance of bicycles, motorcycles, pneumatic tyres, or motor vehicles, and perhaps factory-made animal-traction implements.

In Europe, until quite recent times, village blacksmiths, wheelwrights, leather workers and carpenters were extremely important in manufacturing, adapting and developing harnesses and implements for draft animals. It is difficult to see how many rural communities would have survived without the skills and services of a village blacksmith. Many famous large-scale manufacturers of agricultural equipment in Europe and North America today started business as blacksmiths in the nineteenth century. In developing countries where animal traction use has been practised for centuries, the technology is largely sus-

tained by traditional artisans. Some artisans make and repair ards and wooden-wheeled carts using traditional skills and materials. Other artisans, or "rural mechanics", have specialized in providing tyre repair services or in the repair and rehabilitation of factory manufactured implements. People within countries that have a comprehensive infrastructure of artisanal repair services, may find it difficult to understand the very real problems faced by projects in many parts of Africa. Numerous projects have tried to introduce animal traction without the benefit of appropriate artisanal supporting services. Consequently farmers have had severe problems maintaining and repairing implements, obtaining spare parts and keeping carts in working condition. It has not been unusual for valuable equipment to have been abandoned because of minor problems.

It is both convenient and efficient if village blacksmiths, carpenters and rural mechanics provide services for the *repair and maintenance* of animal traction equipment. The desirability of village artisans *manufacturing* whole implements and modifying existing designs is less accepted by development planners. It is widely felt that village-level fabrication of equipment cannot produce the same standards, quality,

uniformity and consequential operational efficiency that may be obtained from implements made in an urban workshop. Nevertheless village artisans have one critical advantage: they are usually in excellent positions to respond rapidly to feedback from farmers. This may be crucially important for, as has been repeatedly observed, appropriateness of design is generally more important than implement quality (although both are most desirable).

Whether artisans are to be involved in manufacture or simply in repair and maintenance, it would seem evident that schemes to promote the use of animal traction equipment should be very closely linked to the development of artisanal services. Yet in the past this has been neglected, with attention being paid to the construction of large workshops, with associated spare part distribution being arranged through the formal governmental or retail sectors. In more recent years there have been several schemes to facilitate village artisans to manufacture and/or maintain animal-drawn implements.

Coopérative Béninoise de Matériel Agricole
One such scheme was started in Benin. The Coopérative Béninoise de Matériel Agricole (COBEMAG) was established with UNDP support in 1974 and became operational in 1977. Organized as a cooperative of over 100 artisans, it purchases steel centrally and undertakes some cutting and welding at its central workshop. However it delegates much of its practical fabrication work to blacksmiths in different villages, first distributing and then collecting the various components for Arara multipurpose toolbars. Final assembly, quality control and sales have been organized by the central workshop. The biggest problem faced by the COBEMAG cooperative has been lack of capital to maintain stocks of steel and components. The organization of the distribution and collection of components together with the attempts to create a product of uniform quality have almost inevitably imposed a strain on the cooperative management. Since the village blacksmiths make components not complete implements, there has been little scope for creativity, or for blacksmiths to

Fig. 11-15: Workshop of a village blacksmith participating in CMDT-blacksmith scheme. Through the CMDT programme, this blacksmith had received a credit package enabling him to purchase an electricity generator. In 1988, besides providing a local equipment repair service, he fabricated over 200 plows from components imported by CMDT and also experimented with his own implement designs.

Photo: Paul Starkey



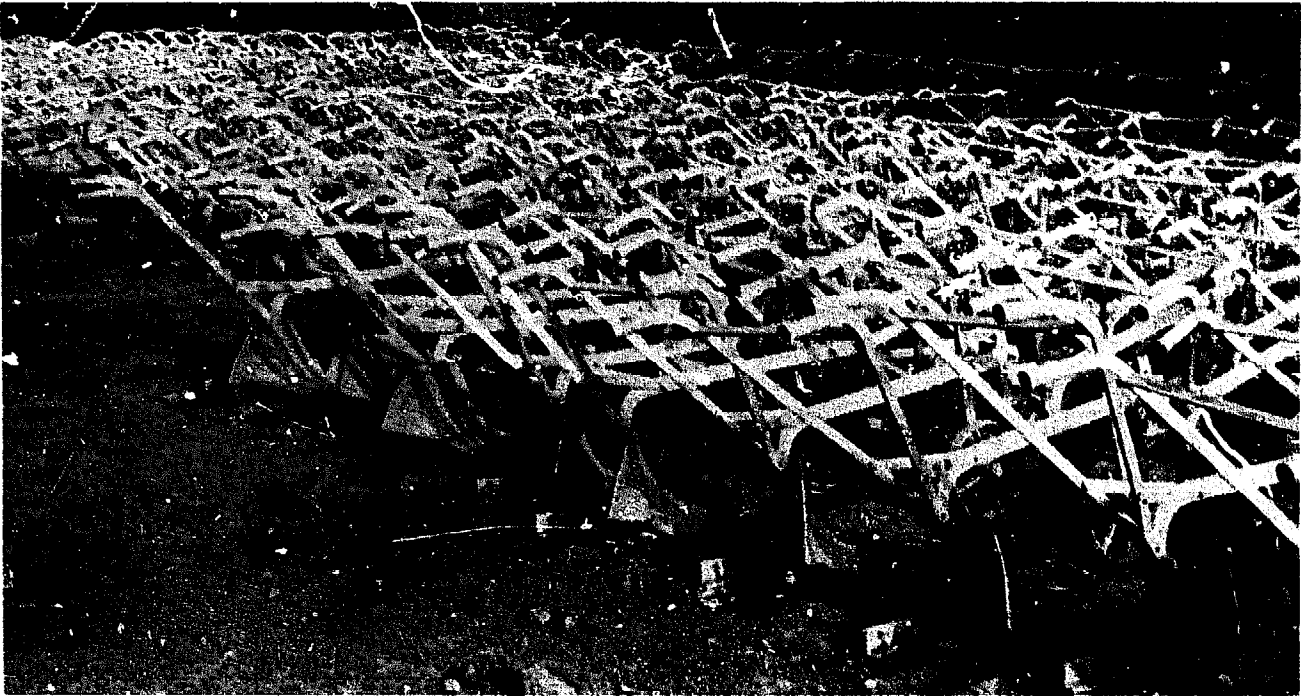


Photo: Paul Starkey

Fig. 11-16: Plows made in workshop of a village blacksmith participating in CMDT-blacksmith scheme.

modify the basic implement design as a result of farmer comments.

CMDT-blacksmith programme

A much bigger scheme has recently been organized and financed in Mali by the parastatal cotton company CMDT (Compagnie Malienne pour le Développement des Textiles), with assistance from several sources including The Netherlands. The aim of the CMDT-blacksmith programme is to ensure that affordable animal-drawn equipment of appropriate design and quality is available throughout southern Mali on a long-term basis. Apparently the financial and organizational problems of the large SMECMA workshop in the capital city had prevented it from meeting the demand for animal-traction equipment in the CMDT zone. CMDT is therefore in the process of providing credit to equip up to 200 village blacksmiths with a range of modern tools. Some blacksmiths are being equipped with simple, hand-operated tools, but others have been supplied with electrical generators allowing the use of drills, grinders and arc welders. Under the present system of blacksmith involvement, CMDT provides the raw materials for 50-200 plows, toolbars or

seeders. The blacksmith assembles the implements, and the CMDT collects them for centralized distribution to farmers. In 1988 the CMDT purchased many implements in kit form from The Netherlands, but CMDT plans to establish a central workshop to allow raw steel to be made into components suitable for distributing to blacksmiths.

It is too early to evaluate the long-term effectiveness of the schemes in Mali, since they are still in an early phase with a great deal of external support. One of the biggest dangers of the scheme as presently planned is its centralization. Like the COBEMAG factory in Benin, materials are purchased centrally and equipment fabrication is devolved. It is significant that unlike COBEMAG, in the CMDT scheme blacksmiths assemble complete implements. However following blacksmith fabrication, subsequent distribution and sales are centralized again. This effectively eliminates the possibility of rapid farmer-blacksmith feedback, since farmers do not know which blacksmith actually made the particular implements bought from the central depot. One suggestion has been to encourage each blacksmith to put his name or logo on the equip-

ment he produces (Starkey, 1988). This would allow each blacksmith to develop his own reputation for implement quality and performance. If blacksmiths were to identify their products in this way and if farmers could be allowed to exercise choice, the resulting competition between blacksmiths might be most valuable in stimulating the rapid evolution of the individual blacksmith enterprises and equipment quality and design. As noted in Chapter 6, variation in equipment design combined with farmer selection and rejection, would seem to offer the best prospects for the rapid evolution of harnessing, implements and, eventually, entire farming systems.

It remains to be seen whether the blacksmith schemes will be allowed to develop with rapid farmer-blacksmith feedback and allow farmers the prospect of implement modifications and design variation not available from centralized workshops. Despite the very imaginative blacksmith-network being developed, innovation and progress could easily be smothered by centralized organization or the imposition of equipment designs selected by central

workshop management. However the mere fact that some blacksmiths have been provided with tools and steel may stimulate the development of animal-drawn implements. Some blacksmiths in southern Mali have already shown themselves to be highly innovative: one developed a double-furrow mould-board plow, while another experimented with a Super-Eco seeder and an old moped/mobylette to obtain a self-propelled seeder. While neither of these innovations succeeded at the first attempt (and may never do so), they represent a most encouraging example of experimentation that could eventually lead to the development of new and improved equipment, designed specifically for local farming systems.

Other artisanal schemes

In another area of Mali, the Opération Haute Vallée (OHV), supported by USAID, has used a different approach to achieve a similar objective to the CMDT-blacksmith programme. OHV has provided credit to allow a small, private, urban-based workshop to manufacture implements from imported kits.

Fig. 11-17: Village carpenters in Zaïre were trained to make carts and wooden-beamed plows as part of a small scheme to introduce animal traction into a new area.

Photo: Paul Starkey





Photo: Paul Starkey

Fig. 11-18: Wooden-beamed plow, fitted with skid, in village in Zaïre. When the plow beam broke, the farmer rapidly made a new one from locally available timber (albeit not straight).

At the same time blacksmiths are being supported to develop repair and maintenance services (Sidibé, 1989).

On a much smaller scale, some non-governmental organizations have tried to combine the introduction of animal traction with village-level implement production. For example one small NGO programme in Zaïre linked the introduction of animal traction with the training of village carpenters and blacksmiths to make and repair plows and carts and other implements (Starkey, 1984; Huybens *et al.*, 1987; Fig. 11-17). The initial results of the project in terms of animal traction adoption and the ability of artisans to make and repair implements seemed most encouraging but the real test of such programmes will be their persistence and growth in the absence of external support.

Blacksmith requirements

Learning to make new implements or spare parts involves considerable investment in time. Village artisans are unlikely to make the necessary efforts to develop new skills and provide efficient maintenance and repair services unless there appears to be a reasonable market for their products. For this reason projects may well find it worthwhile to cluster

extension efforts around villages or small towns that have suitable artisans. It may be that in such villages, the use of particular implements or techniques will be able to develop with mutually sustainable artisanal support, and from such established usage, diffuse out more widely. An alternative strategy of spreading extension effort widely in the first instance could fail everywhere through lack of "critical mass" of demand in any one area to warrant special artisanal services.

In several parts of Africa where animal traction has become widespread only in the last thirty years (for example Sine Saloum, Senegal and southern Mali), a critical mass of consumer demand has obviously been reached, local markets are full of spares made by blacksmiths and comprehensive artisanal repair services are readily available. In ideal circumstances, the farmers should be able to afford fair prices for artisanal services that not only cover the costs of raw materials and workmanship, but also allow the artisans to invest in further materials, equipment and designs. Such an equilibrium is naturally dependent on profitable farming systems, and the artisanal sector can be badly affected by poor harvests. It can also be seriously disrupted by cheap "food-aid" products depressing market prices and reducing farm profits. The informal, artisanal sector is particularly vulnerable to well-meaning animal-traction initiatives of "development projects". The release of new, subsidized implements or imported spare parts into a project area can suddenly undermine artisanal services. In contrast, the provision in market towns of stocks of primary steel or suitable scrap, may actually stimulate village artisans, no longer constrained by the time-consuming search for raw materials.

Village blacksmiths are often not only constrained by problems in obtaining raw materials, but also by lack of tools. Some excellent blacksmith training programmes in Botswana, Niger, Senegal and elsewhere have started with the trainees making their own tools from readily available scrap materials. In some areas it may be useful to provide blacksmiths with practical or financial mechanisms, such as access to transport, stock depots or credit, to assist the purchase of both tools and materials. In the long term providing credit to blacksmiths could be at least as important as giving farmers credit for implement purchases. However the same materials and skills required to make animal traction equipment can also be used to make other commodities. It is unreasonable to expect blacksmiths to invest their time and money making plows and plowshares if it is not profitable, or if a significantly greater return to their investment can be achieved by making window grills or repairing "bush taxis".

11.8 Further reading and information sources

Some examples of artisanal programmes from francophone Africa were described by CEE-MAT (1971), FAO/CEEMAT (1972) and Le Thiec (1985). An illustrated manual and film-strip giving information on techniques for repairing animal traction equipment have been produced in Burkina Faso (FAO, 1983). A more comprehensive handbook is being prepared by CEEMAT (1989). Policy issues relating to the supply and manufacture of animal traction equipment have been discussed in general terms by Inns (1980), UNIDO (1983), Uzureau (1984), Imboden (1984), DLG (1987) and Gifford (1988). Case histories discussing the local fabrication options for particular countries or areas have been prepared by ILO (1983 a-g), Muchiri (1983), de Coninck, Duncan and Winter (1984), Silsoe (1986), ILO (1987a-d), Harouna and Imboden (1988), Dibbits and Sindazi (1989), Kanu (1989) and Fall (1989). Further references on

the subject are given in CTA-CEEMAT (1989).

A list of some of the workshops manufacturing animal traction implements in Africa is given in the Appendix. Research-development organizations working closely with some of these medium-scale equipment manufacturers include: FMDU, Botswana; Projet-FAO, Niger; Mbeya Oxenization Project, Tanzania; PROPTA, Togo; and Animal Draft Programme, Zambia.

There have been numerous schemes in Africa to develop and complement artisanal services. Several large-scale initiatives to develop blacksmith equipment production have been undertaken in Mali. These have been briefly described by Starkey (1988), Gueguen (1989) and Sidibé (1989). More detailed information can be obtained from organizations in Mali including CMDT, DRSPR, OHV and Projet Arpon. Other organizations in Africa working closely with blacksmiths include: COBEMAG, Benin; RIIC, Botswana; Université Hassan II, Morocco; Projet FAO, Niger; ENDA, Senegal; WSDC/JMRDP/Nuba Mountains, Sudan; Projet Rural, Zaire.

The addresses of the organizations cited in this chapter are provided in an Appendix. Further details about manufacturers of animal traction implements in Africa, as well as programmes involving blacksmith training/support, are provided in the GATE Animal Traction Directory: Africa (Starkey, 1988).

The manufacture of animal traction equipment in workshops is an area of specialist interest of UNIDO, Austria. Blacksmith training and support in relation to animal traction are subjects of significant interest to: CEE-MAT, France; the Agricultural Services Division of FAO, Italy; Dutch Technical Cooperation, The Netherlands; the International Labour Organisation (ILO), Switzerland; Swiss-contact, Switzerland; and ITDG, UK. The addresses of these organizations are provided in an Appendix.

12. References

- Abiye Astatke, Bunning, S. and Anderson, F. 1986. Building ponds with animal power in the Ethiopian highlands: a manual. International Livestock Centre for Africa (ILCA), Addis Ababa, Ethiopia. 38p. (E).
- Abiye Astatke and Matthews, M. D. P. 1982. 1981 progress report of the cultivation trials and related cultivation work at Debre Zeit and Debre Berhan. Highlands Programme Working Document, International Livestock Centre for Africa (ILCA), Addis Ababa, Ethiopia. (E).
- Abiye Astatke and Matthews, M. D. P. 1983. 1982 progress report of the cultivation trials and related cultivation work at Debre Zeit and Debre Berhan. Highlands Programme Working Document, International Livestock Centre for Africa (ILCA), Addis Ababa, Ethiopia. (E).
- Abiye Astatke and Matthews, M. D. P. 1984. Cultivation research in the Highlands Programme. International Livestock Centre for Africa (ILCA), Addis Ababa, Ethiopia. (E).
- Abiye Astatke, Reed, J.D. and Butterworth, M.H. 1986. Effect of diet restriction on work performance and weight loss of local Zebu and Friesian x Boran crossbred oxen. ILCA Bulletin 23: 11-14, International Livestock Centre for Africa (ILCA), Addis Ababa, Ethiopia. (E,F).
- AETC 1986. Selection, care and training of draft cattle for agricultural extension workers and extension supervisors. AP1. Agricultural Engineering Training Centre, Harare, Zimbabwe. 161p. (E).
- AETC 1986. Ploughing with draft animals: course for agricultural extension workers and extension supervisors. AP2. Agricultural Engineering Training Centre, Harare, Zimbabwe. c. 100p. (E).
- AETC 1987. Crop establishment using draft animals: course for agricultural extension staff. AP3. Agricultural Engineering Training Centre, Harare, Zimbabwe. 100p. (E).
- AFRC-Engineering 1987. Improvement of the efficiency of draught animals by performance analysis and innovative development of implements. Interim Progress Report: December 1986 - August 1987. AFRC-Engineering, Silsoe, UK. (Limited distribution). 86p. (E).
- Ahmed, I. and Kinsey B. H. (eds) 1984. Farm equipment innovations in Eastern and Central Southern Africa. Gower Publishing, Aldershot, UK. 345p. (E).
- Akou, A. F. 1975. Oxen are never written off. Department of Agriculture, Ministry of Agriculture and Animal Resources, Entebbe, Uganda. 26p. (E).
- Allen, T. G. 1972. Trial use of bullocks for cultivation in the establishment of small-scale plantations or woodlots in Nigerian savanna areas. Paper presented at the third annual conference of the Forestry Association of Nigeria, held Benin, Nigeria, November 1982. 12p. (E). (unpublished).
- Arrachart, J.-L. 1988. Personal communication with Technical Cooperation Officer, Projet OPEN/BIT, Office de Promotion de l'Entreprise Nigérienne, BP 129 Dosso, Niger.
- AT International 1988. Memorandum on congressional request for sustainable transportation demonstration projects. AT International, Washington, USA. 10p. (E). (unpublished).
- Ayre, M. 1981. Bullock harness research project: a synopsis. Intermediate Technology Transport, Ardington, UK. 18p. (E).
- Ayre, M. 1982. The Allahabad collar harness. *Appropriate Technology* 9 (1): 26-28. (F).
- Ayre, M. and Smith, A. 1987. Puncture prevention techniques for low-cost vehicles. Intermediate Technology Publications, London. 40p. (E).
- Bailey, J. 1977. The village wheelwright and carpenter. *Shire Album* 11, Shire Publications, Princes Risborough, UK. 32p. (E).
- Bakrie, B., Murray, R.M., Hogañ, J.P. and Kennedy, P.M. 1987. Body temperature regulation in working buffalo and cattle. DAP Project News (ACIAR Draught Animal Power Project, James Cook University, Townsville, Australia) No. 1: 9-10. (E).
- Bansal, R. K., El Gharras, O. and Hamilton, J. H. 1989. Performance of draft animals at work in Morocco: draftability and work output. Centre Régional de la Recherche Agronomique, Settat, Morocco. (Limited distribution). 18p. (E).
- Bansal, R. K. and Srivastava, K. L. 1981. Improved animal-drawn implements for farming in the

- semi-arid tropics. *Agricultural Mechanization in Asia, Africa and Latin America*. Spring 1981: 33-38.
- Bansal, R. K. and Thierstein, G. E. 1982. Animal drawn multi-purpose tool carriers. *Agricultural Mechanization in Asia, Africa and Latin America*. Autumn 1982: 27-36. (E).
- Baqi, M. A. 1986. Animal-driven pump in Bangladesh. *RNAM Newsletter (Regional Network for Agricultural Machinery, Philippines)* 25: 12. (E).
- Bartlett, J. and Gibbon, D. 1984. *Animal draught technology: an annotated bibliography*. University of East Anglia Overseas Development Group and Intermediate Technology Publications, London. 90p. (E).
- Barton, D. 1985. Yokes or collars? Harnessing techniques for draught cattle. *Draught Animal News (Centre for Tropical Veterinary Medicine, Edinburgh)* No. 4: 1-5. (E).
- Barton, D. 1988. Draught animal harnessing in Bangladesh. *DAP Project Bulletin (ACIAR Draught Animal Power Project, James Cook University, Townsville, Australia)* No. 7: 16-24. (E).
- Barton, D., Jeanrenaud, J. P. and Gibbon, D. 1982. An animal drawn toolcarrier for small farm systems. Discussion Paper 110, School of Development Studies, University of East Anglia, Norwich, UK. 24p. (E).
- Barwell, I. and Ayre, M. 1982. The harnessing of draught animals. *Intermediate Technology Publications, London*. 92p. (E).
- Barwell, I. and Hathway, G. 1986. The design and manufacture of animal-drawn carts. Technical memorandum prepared for ILO/HABITAT. *Intermediate Technology Publications, London*. 72p. (E).
- Basant, R. 1987. The development of animal-drawn implements by artisans in Gujarat. *Appropriate Technology* 14, 3: 22-24. (E).
- Becker, H. 1987. Development and testing of a weed roller. Final report prepared for Tanga Integrated Rural Development Project, Tanzania and GTZ, Eschborn, Federal Republic of Germany. 48p. (E). (unpublished).
- Betker J. and Klaij, M. 1988. Personal communication with researchers from University of Hohenheim, Germany and ISC, Niger (see list of addresses). As noted in the table, the figures mentioned are only indicative, order-of-magnitude values as discussed at the Third West African Animal Traction Workshop held 7-12 July 1988 at Saly, Senegal. (A provisional paper "The impact of draft animals species choice on work potential" by Betker, J., Klaij, M. and Serafini, P. was circulated but not submitted for publication in the proceedings). For the actual measurements and further information, readers are referred to the full reports of the trials (these were not finalized at the time this book was prepared, but are due to be published by the scientists named and their respective organizations).
- Bielenberg, C. 1988. The development of an animal traction grinding mill for villages in Senegal. *Tillers Report* 8,1 (Spring 1988): 10-12. (Tillers Small Farm Program, Kalamazoo, Michigan, USA). (E).
- Bigot, Y., Monnier, J., Landais, E., and Mandjoba, C. 1983. La culture attelée en Côte d'Ivoire de la croissance cotonnière au développement agricole des régions d'élevage bovin. *Ministère de l'Agriculture, Abidjan, Côte d'Ivoire*. 120p. (F).
- Binswanger, H. P. 1984. *Agricultural mechanization: a comparative historical perspective*. Staff Working Paper 673, World Bank, Washington DC, USA. 80p. (E).
- Biswas, H. S. 1980. Weeding tools and implements of India. *Technical Bulletin CIAE 78/3, Central Institute of Agricultural Engineering (CIAE), Bhopal, India*. 87p. (E).
- Biswas, H. S. 1981. A review on rice transplanters and pre-germinated paddy seeders. *Technical Bulletin CIAE 81/21, Central Institute of Agricultural Engineering (CIAE), Bhopal, India*. 70p. (E).
- Bjorlykke and Lunde, 1983. *The craft of the wheelwright*. Windsor Profile Books, UK. (cited by Barwell and Hathway, 1986).
- Boie, W. 1989. Introduction of animal-powered cereal mills: a guideline. *German Appropriate Technology Exchange (GATE), GTZ, Eschborn, Federal Republic of Germany*. (E,F). (in press).
- Bonilla Mora, X. A. 1986. Diseño, construcción y evaluación de dos aditamentos para la extracción de madera con bueyes. *Informe Ingeniero Forestal. Instituto Tecnológico, Cartago, Costa Rica*. 68p. (S).
- Bordet, D. 1987. Inventaire des matériels de culture attelée essayés, mis au point et diffusés au Sénégal depuis 40 ans: réussites, échecs et lacunes des expériences de diffusion. Document de travail, Centre d'Etudes et d'Expérimentation du Machinisme Agricole Tropical (CEEMAT), Antony, France. 64p. (F). (unpublished).
- Bordet, D. 1988. From research on animal-drawn implements to farmers' appropriation: successes and failures of development experience in Senegal. *AG ENG 88 Paper 88.384 prepared for Agricultural Engineering International Conference, held 2-5 March 1988, Paris, France*. Reproduced by Centre d'Etudes et d'Expérimentation du Machinisme Agricole Tropical (CEEMAT), Antony, France. 26p. (E).
- Bordet, D. 1989. La traction animale dans les systèmes de production: effets dynamiques. In: P. Starkey, M. Goe and A. Faye (eds), *Animal*

- traction for agricultural development. Proceedings of workshop held 7-12 July 1988, Saly, Senegal. International Livestock Centre for Africa (ILCA), Addis Ababa, Ethiopia. (E). (in preparation).
- Bordet, D., Lhoste, P., Le Moigne, M. and Le Thiec, G. 1988. La traction animale en Afrique francophone: état de l'art. Report prepared for Food and Agriculture Organization (FAO), Rome, by Centre d'Etudes et d'Expérimentation du Machinisme Agricole Tropical (CEEMAT), Antony, France. 195p. (F). (unpublished).
- Bourarach E. H. 1987. Personal communication with member of staff of Département de Machinisme Agricole, Institut Agronomique et Vétérinaire Hassan II, B.P. 6202, Rabat Institutes, Rabat, Morocco.
- BRT 1986. Bellerive rural technology: animal draught power. Bellerive Rural Technology, Geneva, Switzerland. 4p. (E).
- Bulawayo Steel 1983. "Inkunzi" brand of agricultural implements and spare parts. Bulawayo Steel, Bulawayo, Zimbabwe. 21p. (E).
- Burton, J. D. 1987. Water provision and water lifting technologies using livestock in semi-arid areas. Paper prepared for Forum on Equipping Poor Farmers, held 19-20 June 1987, Rugby. Intermediate Technology Development Group, Rugby, UK. 3p. (E). (unpublished).
- Busquets, E. 1986. The power gear makes it worthwhile to keep draught animals. GATE Questions, Answers, Information (GTZ) 4/86: 13-16. (E).
- Casse, M., Dumas, R. et Garin, M. 1985. Bilan des expériences de culture attelée en Afrique occidentale d'expression française, Guinée exceptée. Tome I, II et III, BDPA, IEMVT et Ministère de la Coopération, Paris, France. (F).
- CEEMAT 1968. Manuel de la culture avec traction animale: techniques rurales en Afrique. Centre d'Etudes et d'Expérimentation du Machinisme Agricole Tropical (CEEMAT) et Ministère de la Coopération, Paris, France. 336p. (F).
- CEEMAT 1971. Manuel de la culture avec traction animale: techniques rurales en Afrique. Centre d'Etudes et d'Expérimentation du Machinisme Agricole Tropical (CEEMAT) et Ministère de la Coopération, Paris, France. 336p. (F).
- CEEMAT 1974. Aide-mémoire du moniteur de culture attelée. Centre d'Etudes et d'Expérimentation du Machinisme Agricole Tropical (CEEMAT) et Ministère de la Coopération, Paris, France. 147p. (texte) and 50p. (schémas). (F).
- CEEMAT 1984. Le rouleau piétineur à traction animale dans la préparation de rizières à Madagascar. Machinisme Agricole Tropical 88: 3-10. (F).
- CEEMAT 1989. Manuel de constructions mécaniques rurales. Collection: Techniques rurales en Afrique. Secrétariat d'Etat aux Affaires Etrangères chargé de la Coopération et Centre d'Etudes et d'Expérimentation du Machinisme Agricole Tropical (CEEMAT), Antony, France. (F). (in preparation).
- CEEMAT/FAO 1972. The employment of draught animals in agriculture. Food and Agriculture Organization of the United Nations (FAO), Rome, Italy. 249p. (E).
- Chivers, K. 1988. History with a future: harnessing the heavy horse for the 21st century. Shire Horse Society, Peterborough, UK. 234p. (E).
- Coninck, J. D. de, Duncan, A. and Winter, P. E. 1984. Agricultural equipment and innovation in Southern Sudan. pp. 253-270 in Ahmed, I. and Kinsey B. H. (eds): Farm equipment innovations in Eastern and Central Southern Africa. Gower Publishing, Aldershot, UK. 345p. (E).
- Conroy, D. 1988. The traditional ox team and its yoke. Tillers Report 8, 1: 1-5. (Spring 1988). (Tillers Small Farm Program, Kalamazoo, Michigan, USA). (E).
- Copland, J. W. (ed) 1985. Draught animal power for production. Proceedings of an international workshop held at James Cook University, Townsville, Qld, Australia, 10-16 July 1985. ACIAR Proceedings Series 10, Australian Centre for International Agricultural Research, Canberra. 170p. (E).
- Cordero, W. 1985. Directrices par la extracción forestal con bueyes. Instituto Tecnológico, Cartago, Costa Rica. 35p. (S).
- Cordero, W. 1986. The role of animal traction in the harvesting of rain forests. pp. 69-78 in proceedings of meeting on Cultivation and Exploitation of Forests, held Zagreb, 4-6 Dec 1985. Institute for Developing Countries, Zagreb, Yugoslavia. (E).
- Cordero, W. 1986. The use of animal traction in forestry operations. Draught Animal News (Centre for Tropical Veterinary Medicine, Edinburgh) No. 5: 4-7. (E).
- Cordero, W. 1988. Ox-logging: traditional methods used in Costa Rica. Small Scale Forestry 1/88 12-16. (University of Agricultural Sciences, Garpenberg, Sweden). (E).
- Cordero, W. 1988. Utilización del sulky en extracción de madera con bueyes. Serie Informativa Tecnología Apropriada No. 18, Instituto Tecnológico, Cartago, Costa Rica. 69p. (S).
- Cornelius, D. W. and Broadley, J. 1974. Consideration for the use of oxen for the main extraction of pulpwood from the Viphya Project Forests. Oxen use feasibility study visit to Chile. Ministry of Agriculture and Natural Resources, Lilongwe, Malawi. 67p. (E). (unpublished).
- Crossley, P. and Kilgour, J. 1983. Small farm mechanization for developing countries. John Wiley and Sons, Chichester, UK. 253p. (E).

- CTA-CEEMAT 1989. Traction animale et développement agricole des régions chaudes: bibliographie annotée 2, les outils: fabrication, conduite et entretien. Centre technique de coopération agricole et rurale (CTA), CIRAD Département CEEMAT (Centre d'Etudes et d'Expérimentation du Machinisme Agricole Tropical) et Centre d'Information et de Documentation en Agronomie des Régions Chaudes (CIDARC), Montpellier, France. (in press). (F).
- Delamarre, M. J-B. 1969. Géographie et ethnologie de l'attelage au joug en France du XVIIe siècle à nos jours. Vydalo Slovacké Museum Uherské Hradiste, Czechoslovakia. 132p. (F,Czech).
- Deshayes, P. 1988. Une expérience d'exhaure à traction animale dans le boundou: le Guéroult simplifié bois. E.T. 154, ENDA, Dakar, Sénégal. 13p. (F).
- Deshpande, S. D. and Ojha, T. P. 1983. Annotated bibliography on improvisation of animal drawn vehicle transport in India and abroad. Technical Bulletin CIAE/83/40. Central Institute of Agricultural Engineering, Bhopal, India. 165p. (E).
- Deshpande, S. D. and Ojha, T. P. 1984. Monograph on traditional and improved bullock carts of India. Technical Monograph CIAE/84/44. Central Institute of Agricultural Engineering, Bhopal, India. 157p. (E).
- Devrani, R. S. 1980. Harvesting equipment developed in India. Technical Bulletin CIAE 78/4, Central Institute of Agricultural Engineering (CIAE), Bhopal, India. 74p. (E).
- Devnali, R. S. 1981. Design considerations for harnesses and yokes for draught animals. Central Institute of Agricultural Engineering, Bhopal, India. 67p. (E).
- Dibbits, H. J. 1984. Proper harnessing: key to better use of draught animals. Kenya Farmer (November) 6-9. (E).
- Dibbits, H. J. 1985. UNIDIB donkey harness. Draught Animal News (Centre for Tropical Veterinary Medicine, Edinburgh) No. 5: 16-17. (E).
- Dibbits, H. J. 1985. Animal draft power development project: progress report no. 1. Department of Agricultural Engineering, University of Nairobi, Kenya. 36p. (E). (unpublished).
- Dibbits, H. J. 1985. The donkeys' formidable role in agriculture. Kenya Farmer (February) 31-32 (E).
- Dibbits, H. J. 1986. Use of human and animal power on small farms in Africa. pp. 577-582 in: Small farm equipment for developing countries. Proceedings of conference held 2-6 September 1985, Manila. International Rice Research Institute (IRRI), Manila, Philippines. (E).
- Dibbits, H. J. 1987. Animal-drawn mouldboard ploughs: parts, designs, adjustments and draught requirements. Agricultural Engineering Section, Ministry of Agriculture and Water Development, Lusaka, Zambia. (photocopy). 14p. (E).
- Dibbits, H. J. and Sindazi, M. 1989. Historical and present constraints to the use of animal traction in Zambia. In: P. Starkey, M. Goe and A. Faye (eds), Animal traction for agricultural development. Proceedings of workshop held 7-12 July 1988, Saly, Senegal. International Livestock Centre for Africa (ILCA), Addis Ababa, Ethiopia. (E). (in preparation).
- DLG 1987. North-South cooperation of manufacturers of agricultural machinery. Summary of international symposium on mechanization held 19-23 November 1987, Frankfurt, FRG. Deutsche Landwirtschafts-Gesellschaft (DLG), Frankfurt, Federal Republic of Germany. 6p. (E,F). (mimeo).
- Duchenne, T. 1984. Le point sur les harnais pour la traction animale. Dossier No. 5. Groupe de recherches et d'échanges technologiques (GRET), Paris, France. 132p. (F).
- Duret, T., Baron, V. and Barbosa dos Anjos, J. 1986. "Systemes de culture" expérimentés dans le Nordeste du Brésil. Machinisme Agricole Tropical 94: 62-74. (F).
- EFSaip 1984. Final report No. 8, 1976-1984. Evaluation of Farming Systems and Agricultural Implements Project (EFSaip), Ministry of Agriculture, Gaborone, Botswana. 116p. and 403p. (E).
- Elbatnane, A. 1983. Etude mécanique de l'araire au Maroc. Mémoire de fin d'études, Département de Machinisme Agricole, Institut Agronomique et Vétérinaire Hassan II, Rabat, Morocco. (cited by Elhimdy and Chiche, 1989). (F). (unpublished).
- Elhimdy, A. and Chiche, J. 1989. Traction animale au Maroc: approche à la rentabilité dans les petites exploitations (cas du Tadla). In: P. Starkey, M. Goe and A. Faye (eds), Animal traction for agricultural development. Proceedings of workshop held 7-12 July 1988, Saly, Senegal. International Livestock Centre for Africa (ILCA), Addis Ababa, Ethiopia. (E). (in preparation).
- ENDA 1986. Le moulin à traction animale. E.T. 127, ENDA, Dakar, Sénégal. 13p. (F).
- ENDA 1987. Ouvrage maçonnerie du moulin à traction animale. E.T. 129, ENDA, Dakar, Sénégal. 13p. (F).
- Eshleman, R. 1975. The Mochudi Toolbar. Ministry of Agriculture, Gaborone, Botswana. 17p. (E).
- Fall, A. 1989. Rôles actuels et potentiels des forgerons traditionnels dans la maintenance du matériel agricole en Basse-Casamance. In: P. Starkey, M. Goe and A. Faye (eds), Animal traction for agricultural development. Proceedings of workshop held 7-12 July 1988, Saly, Senegal.

- International Livestock Centre for Africa (ILCA), Addis Ababa, Ethiopia. (E). (in preparation).
- FAO 1972. Harnessing methods according to species and breed. pp. 60-71 in: CEE-MAT/FAO 1972. The employment of draught animals in agriculture. Food and Agriculture Organization of the United Nations (FAO), Rome, Italy. 249p. (E).
- FAO 1983. Animal traction in Upper Volta. (Booklet and film strip). Food and Agriculture Organization of the United Nations (FAO), Rome, Italy. 60p. (E,F).
- FAO 1983. Carts for draught animals. (Booklet and film strip). Food and Agriculture Organization of the United Nations (FAO), Rome, Italy. 28p. (E,F).
- FAO 1983. Le matériel aratoire: la charrue et son entretien; la houe et son entretien; le butteur et son entretien; le travail du forgeron. (Booklet and film strip). Food and Agriculture Organization of the United Nations (FAO), Rome, Italy. 64p. (F).
- FAO 1986. Donkeys as pack animals for small-scale farmers, Western Samoa. World Animal Review (FAO, Rome) 57: 49-50. (E,F,S).
- FAO/CEEMAT 1972. The employment of draught animals in agriculture. Food and Agriculture Organization of the United Nations (FAO), Rome, Italy. 249p. (E).
- Fenton, A. 1969. Draught oxen in Britain. pp. 17-51 in W. Jacobeit and J. Kramarik (eds). Rindranschirung. Naodopisny Vestnik Ceskoslovensky (Bulletin d'Ethnographie Tchécoslovaque) 3-4. (E).
- Fenton, A. 1973. Early yoke types in Britain. pp. 69-75. in I. Wellmann (ed): Proceedings of the Hungarian Agricultural Museum, Budapest, Hungary. (E).
- Fielding, D. 1988. Pack transport with donkeys. *Appropriate Technology* 15, 3: 11-13. (E).
- Finn, S. 1986. An ox-powered sweep for stationary power. pp. 4 & 10 in: Tillers Report (Winter 1986), Tillers Small Farm Program, Kalamazoo, Michigan, USA. 12p. (E).
- FMDU/ATIP 1987. Using donkeys for draught power. Part 1: Principles of animal draught. Part 2: Donkey management. Part 3: Harnesses for donkeys. Part 4: Hitches for donkeys. *Agri-facts B/28/1-4*, Agricultural Information Services, Gaborone, Botswana. 4, 3, 14, and 4p. (E).
- Fort, J. 1973. Mécanisation des pratiques agricoles traditionnelles en zone sahélienne du nord. *Machinisme Agricole Tropical* 41: 34-39. (F).
- Froese, C. 1980. Harness project report. Mochudi Farmers Brigade, Kgatleng Development Board, Botswana. 39p. (E).
- FSERT undated. Guide de l'attelage du bétail bovin. Fédération suisse d'élevage de la race tachetée rouge, Berne, Switzerland. 8p. (F).
- Garner, J. K. 1957. Increasing the work efficiency of the water buffalo in drawing the plow and other implements through the use of improved harness. United States Operations Mission, Thailand. 11p. (E). (unpublished).
- GATE/Projekt-consult 1986. Animal power technology: a program from GTZ/GATE in West Africa. German Appropriate Technology Exchange (GATE), Eschborn, Federal Republic of Germany. 25p. (E).
- Gifford, R. C. 1988. The selection and use of animal draft technology. pp. 116-118 in: P. Starkey and F. Ndiame (eds), *Animal power in farming systems*. Proceedings of workshop held 19-26 Sept 1986, Freetown, Sierra Leone. German Appropriate Technology Exchange (GATE), GTZ, Eschborn, Federal Republic of Germany. 363p. (E/F).
- Gill, G. J. 1977. A simple reaping machine. *Appropriate Technology* 4 (2): 23-24. (E).
- Gite, L.P. and Patra, S.K. 1981. Sowing and fertilizer application equipment of India. Technical Bulletin CIAE/81/22, Central Institute of Agricultural Engineering, Bhopal, India. 109p. (E).
- Goe, M. R. 1983. Current status of research on animal traction. *FAO World Animal Review* 45: 2-17. (E,F,S).
- Goe, M. R. 1987. Animal traction on smallholder farms in the Ethiopian highlands. Ph.D. Thesis (Cornell University), UMI Dissertation Information Service, Ann Arbor, Michigan, USA. 408p. (E).
- Goe, M. R. and Hailu, M. 1983. Animal traction: a selected bibliography. International Livestock Centre for Africa (ILCA), Addis Ababa, Ethiopia. 42p. (E).
- Goe, M. R. and McDowell, R. E. 1980. Animal traction: guidelines for utilization. International Agricultural Development Mimeograph 81, Cornell University, Ithaca, NY, USA. 84p. (E).
- Goe, M. R., Starkey, P. H. and Sirak Teklu 1989. Animal traction: a selected annotated bibliography. International Livestock Centre for Africa (ILCA), Addis Ababa, Ethiopia. (in preparation). (E).
- Goubert, D. 1982. Exhaure à traction animale au Sénégal. ENDA, Dakar, Sénégal. 18p. (F).
- Gryseels, G., Abiye Astatke, Anderson, F. M. and Getachew Assemenew 1984. The use of single oxen for crop cultivation in Ethiopia. *ILCA Bulletin* 18: 20-25. (E,F).
- Gueguen, R. 1989. Fabrication locale et maintenance du matériel agricole en zone Mali-Sud. In: Raymond, G. (ed), *Actes du séminaire d'économie rurale: Economie de la mécanisation en*

- région chaude, 12-16 Sept 1988, Montpellier, France. CIRAD, Montpellier, France. (F). (in preparation).
- Günthart, B. L. 1938. Die erziehung des rindes zum jüge. *Landwirtschaftliche Zeitschrift* 6 (11 Feb 1938): 137-147. (G).
- Gwani, E. S. 1989. Animal power usage for agricultural production in Nigeria. In: P. Starkey, M. Goe and A. Faye (eds), *Animal traction for agricultural development. Proceedings of workshop held 7-12 July 1988, Saly, Senegal. International Livestock Centre for Africa (ILCA), Addis Ababa, Ethiopia.* (E). (in preparation).
- Halcrow 1983. Small-scale solar-powered pumping systems: the technology, its economics and advancement. Section 8. Report of UNDP Project GLO/80/003, executed by Sir William Halcrow and Partners in association with Intermediate Technology Power Ltd. World Bank, Washington DC. (E). (unpublished).
- Harouna, S. A. S. and Imboden, R. 1988. Développement et adaptation de l'équipement de traction animale aux conditions locales du Département de Niamey, Niger. pp. 151-160 in: P. Starkey and F. Ndiame (eds), *Animal power in farming systems. Proceedings of workshop held 19-26 Sept 1986, Freetown, Sierra Leone. German Appropriate Technology Exchange (GATE), GTZ, Eschborn, Federal Republic of Germany.* 363p. (E/F).
- Haudricourt, A. G. and Delamarre, M. J. 1955. *L'homme et la charrue à travers le monde. Géographie Humaine No. 25, Gallimard, Paris, France.* 506p. (F).
- Havard, M. 1985. Principales caractéristiques et contraintes de gestion du parc de matériels de culture attelée au Sénégal. *Machinisme Agricole Tropical* 91, 19-23. (F).
- Havard, M. 1986. Les conclusions des expérimentations (1950-1985) sur les semis en culture attelée des principales espèces cultivées. Document de Travail 1986:10. Département Systèmes et Transfert, ISRA, Dakar, Sénégal. 116p. (F).
- Havard, M. 1987. Le parc de matériels de culture attelée et des possibilités de sa maintenance dans le département de Nioro: résultats d'enquêtes. Document de Travail 1987:3. Département Systèmes et Transfert, ISRA, Dakar, Sénégal. 45p. (F).
- Heifer 1985. Single-ox yoke. p. 2 in: *The Heifer Project Exchange No. 25. Heifer Project International, Little Rock, Arkansas, USA.* (E).
- Herblot, G. 1982. Une expérimentation "travail du sol en sec" en Haute-Volta. *Machinisme Agricole Tropical* 85:3-41. (F).
- Herrandina 1987. Herrandina. Proyecto de Herramientas e Implementos Agrícolas Andinos, Cusco, Peru. 28p. (S). (unpublished).
- Hinz, H.-J. 1985. A single traction bamboo-cart, specially designed for off-road transport. GATE (German Appropriate Technology Exchange) Questions, Answers, Information 4/85: 31-32. (E).
- Hinz, H.-J. 1988. String-spoked wooden wheels. GATE (German Appropriate Technology Exchange) Questions, Answers, Information 2/88: 24-26. (E).
- Hofkes, E. H. 1985. Water lifting pp 93-99 in: *Tools for agriculture: a buyer's guide to appropriate equipment. Intermediate Technology Publications, London.* 264p. (E).
- Hooley, R. 1984. *Manual de tracción animal. Comité Central Menonita, Santa Cruz, Bolivia.* 155p. (S).
- Hopfen, H. J. 1960. *Farm implements for arid and tropical regions. (First edition). Agricultural Development Paper 91, Food and Agricultural Organization of the United Nations (FAO), Rome, Italy.* 159p. (E).
- Hopfen, H. J. 1969. *Farm implements for arid and tropical regions. (Revised edition). Agricultural Development Paper 91, Food and Agricultural Organization of the United Nations (FAO), Rome, Italy.* 159p. (E).
- Hopfen, H. J. and Biesalski, E. 1953. *Small farm implements. Agricultural Development Paper 32, Food and Agricultural Organization of the United Nations (FAO), Rome, Italy.* 83p. (E).
- Horspool, G. D. 1987. A review of EFSaip machinery development 1977-84, with relation to appropriate farm equipment innovation for Botswana. pp. 31-39 in: *Initiatives for farm equipment programmes in Botswana: improving coordination. International Labour Organisation (ILO), Geneva, Switzerland.* 113p. (E).
- Howell, P. J. L. and Paice, M. E. R. 1988. An adaptive data logging system for animal power studies. AG ENG 88 Paper 88.141 prepared for Agricultural Engineering International Conference, held 2-5 March 1988, Paris, France. Reproduced by AFRC-Engineering, Silsoe, UK. 12p. (E).
- Hussain, A. A. M., Hussain, M. A. and Hossain, M. M. 1980. Design and development of neck harness for cattle in Bangladesh. *Agricultural Mechanization in Asia, Africa and Latin America*, 11 (1): 85-89. (E).
- Huybens, E., Keijzer, N., van Esbroeck, D. and Vannoppen, J. 1987. L'introduction de la traction bovine dans la région de Mbuji Mayi, Zaire. *South Research, Heverlee, Belgium.* 212p. (F).
- IAD 1987. Grass clearing: organic farming aided by animal-drawn cutter. *International Agricultural Development, March/April 1987:* 17. (E).
- ICRISAT 1983. *The animal-drawn wheeled toolcarrier. Revised edition. Information Bulletin No. 8, International Crops Research Institute for the Semi-Arid Tropics (ICRISAT), Patancheru, India.* 12p. (E,F,S).

- ICRISAT 1985. The Tropicutor operator's manual: field operations. International Crops Research Institute for the Semi-Arid Tropics (ICRISAT), Patancheru, India. 62p. (E).
- ILCA 1983 (a). ILCA annual report 1983: improving livestock and crop-livestock systems in Africa, International Livestock Centre for Africa (ILCA), Addis Ababa, Ethiopia. 79p. (E,F).
- ILCA 1983 (b). The single ox: an innovation for the small farmer. ILCA Newsletter 2, 2: 1-2, 6. International Livestock Centre for Africa (ILCA), Addis Ababa, Ethiopia. (E,F).
- ILCA 1988. Making technology appropriate. ILCA Newsletter 7, 2: 1, 4-6. International Livestock Centre for Africa (ILCA), Addis Ababa, Ethiopia. (E,F).
- ILO 1983a-f. Appropriate farm equipment technology for the small-scale traditional sector. The case of Botswana (102p); The case of Kenya (74p); The case of Sudan (64p); The case of Tanzania (123p); The case of Zambia (106p). Synthesis report (279p). International Labour Organisation (ILO), Geneva, Switzerland. (E).
- ILO 1983g. Tools and equipment manual for labour intensive farming: a sub-regional manual for Botswana, Kenya, Sudan, Tanzania and Zambia. Regional project on farm tool and equipment technology: basic needs and employment. International Labour Organisation (ILO), Geneva, Switzerland. 111p. (E).
- ILO 1987a. Excess manufacturing capacity and farm equipment needs in Kenya. Proceedings of a workshop on farm tools and equipment technology, held 15-18 October 1985 in Nairobi. International Labour Organisation (ILO), Geneva, Switzerland. 117p. (E).
- ILO 1987b. Initiatives for farm equipment programmes in Botswana: improving coordination. Proceedings of workshop held 3-5 December 1985 in Gaborone. International Labour Organisation, Geneva, Switzerland. 113p. (E).
- ILO 1987c. In quest of agricultural mechanization policy and strategy in the United Republic of Tanzania. Proceedings of a workshop on farm tools and equipment technology, held 8-10 October 1985 in Dar es Salaam. International Labour Organisation, Geneva, Switzerland. 69p. (E).
- ILO 1987d. Structural readjustments and Zambia's self-reliance in farm equipment. Proceedings of workshop held 26-28 November 1985 in Lusaka. International Labour Organisation, Geneva, Switzerland. 135p. (E).
- Imboden, R. 1984. Adaptation de l'équipement pour la traction animale aux conditions locales. pp. 98-107 in: Animal energy in agriculture in Africa and Asia. Animal Production and Health Paper 42, FAO, Rome, Italy. 143p. (E/F).
- Inns, F. M. 1980. Agricultural machinery manufacture in developing countries: the potential contribution to agricultural and industrial development. Agricultural Engineer, Winter 1980: 100-103. (E).
- Inter Tropiques 1985. Sortir l'eau du puits: des atelages pour utiliser la traction animale. Inter Tropiques Agricultures 11 (juin): 30-31. (F).
- IRRI 1986. Animal-drawn cono-puddler. Agricultural Engineering Department, International Rice Research Institute, Manila, Philippines. 2p. (E). (mimeo).
- Islam, M. N. 1985. An assessment of harnessing techniques for draught animals with particular reference to Bangladesh. M.Sc. Dissertation, Centre for Tropical Veterinary Medicine, University of Edinburgh, Scotland. (E). (unpublished).
- ITDG undated. Agricultural Green Leaflets: 4. Kabanyolo toolbar; 5. Chitedze Ridgemaster toolbar; 7. Cultivators; IT Expandable cultivator and five-tine sweeper; 10. Two designs for clod crushers; 12. IDC weeding attachment for Lincot plough; 13. Adjustable width V-drag ditcher/bund former; 14. Sled-type corrugator/irrigation-furrow former; 15. Single-row and three-row rice seeders; 17. Multi-action paddy-field puddling tool (Japan); 29. IDC-Bornu groundnut lifter and IT groundnut lifter; 33. IT high-clearance rotary hoe; 36. The weeder mulcher; Oil soaked wood bearings; Ox-drawn tie-ridger/weeder implement; The Rasulia bladed roller thresher; Carts: ox-cart using old car wheels, the Wananchi ox-cart and cart for one draught animal; Weeder mulcher; Prototype multi-purpose ox-drawn tool; Harrows: triangular spike-tooth, high clearance peg tooth, flexible peg tooth and Japanese harrow; Prototype multipurpose ox-drawn tool). Agricultural equipment and tools for farmers designed for local construction. Intermediate Technology Publications, London, UK. 3-5p (per pamphlet). (E).
- ITDG 1972. The "Murrells" pack saddle. Technical drawings of pack saddle derived from the Veterinary Department, Tanzania in 1958, and re-traced for ITDG, 1972. Intermediate Technology Publications, London, UK. 1p. (E).
- ITDG 1985. Kenya appropriate water harvesting methods gain ground. Intermediate Technology News (December 1985). (E).
- ITDG 1985. Tools for agriculture: a buyer's guide to appropriate equipment. Intermediate Technology Publications, London, UK. 264p. (E).
- ITP 1985. Tools for agriculture: a buyer's guide to appropriate equipment. Intermediate Technology Publications, London, UK. 264p. (E).
- Iversen E. H. 1987. Animal-based transportation for drought relief. World Animal Review (FAO, Rome) 61: 44-47. (E,F,S).

- Jacobi, C. 1985. Raising water with the Guéroult creates conflicts. GATE (German Appropriate Technology Exchange) Questions, Answers, Information 2/85: 40-42. (E).
- Jacobi, C. and Löwe, P. 1984. Quelques techniques d'exhaure de l'eau au Sahel. E.T. 120, ENDA, Dakar, Sénégal. 8p. (F).
- Jacobi, C. and Löwe, P. 1984. Pomper l'eau avec le guéroult au village. E.T. 122, ENDA, Dakar, Sénégal. 13p. (F).
- Jutzi, S., Anderson, F. M. and Abiye Astatke 1986. Low cost modifications of the traditional Ethiopian tine plough for land shaping and surface drainage on heavy clay soils: preliminary results from on-farm verification trials. ILCA Bulletin 27: 28-31 (E,F).
- Jutzi, S., Anderson, F. M. and Abiye Astatke 1988. Low-cost modifications of the traditional Ethiopian tine plow for land-shaping and surface drainage on heavy clay soils: preliminary results from on-farm verification. pp. 127-138 in: P. Starkey and F. Ndiame (eds), Animal power in farming systems. Proceedings of workshop held 19-26 Sept 1986, Freetown, Sierra Leone. German Appropriate Technology Exchange (GATE), GTZ, Eschborn, Federal Republic of Germany. 363p. (E,F).
- Jutzi, S. and Goe, M. R. 1987. Draught animal technologies to intensify smallholder crop-livestock farming in the Ethiopian Highlands. Paper prepared for FAO World Animal Review. International Livestock Centre for Africa (ILCA), Addis Ababa, Ethiopia. (E). (unpublished).
- Kanu, B. H. 1989. Village level engineering: activities of the blacksmith to promote production in the rural areas. In: P. Starkey, M. Goe and A. Faye (eds), Animal traction for agricultural development. Proceedings of workshop held 7-12 July 1988, Saly, Senegal. International Livestock Centre for Africa (ILCA), Addis Ababa, Ethiopia. (E). (in preparation).
- Kebede, A. and Pathak, B. S. 1987. Draught characteristics of Ethiopian oxen. Draught Animal News (Centre for Tropical Veterinary Medicine, Edinburgh, UK) No. 8: 12-13. (E).
- Kehoe, M. M. and Chan, L. C. 1987. Buffalo draught power on oil palm estates. Incorporated Society of Planters, Kuala Lumpur, Malaysia. 113p. (E).
- Kemp, D. C. 1983. The NIKART: a new animal-drawn implement for cultivation and transport. Appropriate Technology 10, 1, 11-13 (E).
- Kemp, D. C. 1985. Performance measurement for ox and implement combinations. Proceedings Indian Society of Agricultural Engineers Silver Jubilee Convention held Oct 29-31 1985. Vol. 1: 16-21. (E).
- Kemp, D. C. 1987. Draught animal power: some recent and current work. FAO World Animal Review 63: 7-14. (E,F,S).
- Kemp D. C. 1989. Workload constraints: the measurement and interpretation of mechanical factors. In: P. Starkey, M. Goe and A. Faye (eds), Animal traction for agricultural development. Proceedings of workshop held 7-12 July 1988, Saly, Senegal. International Livestock Centre for Africa (ILCA), Addis Ababa, Ethiopia. (E). (in preparation).
- Kennedy, W. K. and Rogers, T. A. 1985. Human and animal-powered water-lifting devices: a state-of-the-art survey. Intermediate Technology Publications, London, UK. 111p. (E).
- Kepner, R. A., Bainer, R. and Barger, E. L. 1978. Principles of farm machinery. AVI Publishing, Westport, Connecticut, USA. (E).
- Kerr, G. 1986. Uses of elephants in forestry work in Kerala, India. Draught Animal News (Centre for Tropical Veterinary Medicine, Edinburgh, UK) No. 5: 8-11. (E).
- King, J. G. M. 1940. Ox pack transport in Sukuma, Tanganyika Territory. East African Agricultural Journal 5: 306-311. (E).
- Kinsey, B. H. 1984 (a). Equipment innovations, agricultural growth and employment in Zambia. pp. 129-178 in: Ahmed, I. and Kinsey B. H. (eds). Farm equipment innovations in Eastern and Central Southern Africa. Gower Publishing, Aldershot, UK. 345p. (E).
- Kinsey, B. H. 1984 (b). Agricultural equipment innovations and rural transformation in Tanzania. pp. 179-208 in: Ahmed, I. and Kinsey B. H. (eds). Farm equipment innovations in Eastern and Central Southern Africa. Gower Publishing, Aldershot, UK. 345p. (E).
- Kinsey, B. H. 1984 (c). Equipment innovations in cotton-millet farming systems in Uganda. pp. 209-252 in: Ahmed, I. and Kinsey B. H. (eds). Farm equipment innovations in Eastern and Central Southern Africa. Gower Publishing, Aldershot, UK. 345p. (E).
- Kinsey, B. H. 1984 (d). The potential for farm equipment innovations in Malawi. pp. 273-304 in: Ahmed, I. and Kinsey B. H. (eds). Farm equipment innovations in Eastern and Central Southern Africa. Gower Publishing, Aldershot, UK. 345p. (E).
- Kivikko, R. 1987. Preliminary tests for single animal harness systems. Tillers Report, Spring 1987: 8-9. (Tillers Small Farm Program, Kalamazoo, Michigan, USA). (E).
- Kivikko, R. and Roosenberg, R. 1987. Designing ox yokes for more effective power. Tillers Report, Spring 1987: 5-7. (Tillers Small Farm Program, Kalamazoo, Michigan, USA). (E).
- Kjærby, F. 1983. Problems and contradictions in the development of ox-cultivation in Tanzania. Research report 66, Scandinavian Institute of African Studies, Uppsala, Sweden. 164p. (E).
- Kline, C.K., Green, D.A.G., Danahue, R.L. and Stout, B.A. 1969. Agricultural mechanization in

- equatorial Africa. Research Report 6, Institute of International Agriculture, Michigan State University, Michigan, USA. 593p. (E).
- Kliver, N. 1987. The use of ox-carts in road construction in Honduras. Kreditanstalt für Wiederaufbau/GTZ, Eschborn, Federal Republic of Germany. 2p. (E). (unpublished).
- Konanta, C., Limakul, A., Treephan, V., Srisan, Y., Onwan, N. and Konanta, S. 1986. Working capacity of Murrah x swamp crossbred and Thai swamp buffaloes. Buffalo Bulletin 5, 4: 75-79. (International Buffalo Information Centre, Bangkok, Thailand). (E).
- Koroma, J. and Boie, W. 1988. Demonstration of animal-power gear at Rolako Ox Plow Centre. pp. 43-45 in: P. Starkey and F. Ndiame (eds), Animal power in farming systems. Proceedings of workshop held 19-26 Sept 1986, Freetown, Sierra Leone. German Appropriate Technology Exchange (GATE), GTZ, Eschborn, Federal Republic of Germany. 363p. (E/F).
- Lawrence, P. R. 1983. The energy costs of pulling loads. Draught Animal News 1: 4-5. Centre for Tropical Veterinary Medicine, University of Edinburgh, UK. (E).
- Lawrence P. R. 1985. A review of the nutrient requirements of draught oxen. pp 59-63 in J. W. Copland (ed): Draught animal power for production. Proceedings of an international workshop held at James Cook University, Townsville, Qld, Australia, 10-16 July 1985. ACIAR Proceedings Series 10, Australian Centre for International Agricultural Research, Canberra. 170p. (E).
- Lawrence, P. R. 1987. Mud, mud glorious mud. Draught Animal News (Centre for Tropical Veterinary Medicine, University of Edinburgh, UK) 7: 1-2. Centre for Tropical Veterinary Medicine, University of Edinburgh, UK. (E).
- Lawrence, P. R. 1987. A collar for an ox or buffalo made from a worn out car or lorry tyre. Draught Animal News (Centre for Tropical Veterinary Medicine, University of Edinburgh, UK) 7: 19-20. (E).
- Lawrence, P. R. 1987. Draught animal research at the Centre for Tropical Veterinary Medicine of Edinburgh University, Scotland. In: Proceedings of workshop on Animal Traction and Agricultural Mechanization Research held 10-14 Aug. 1987, Maputo, Mozambique. SACCAR, Sebele, Botswana. (E).
- Lawrence, P. R. 1989. The work output, distance travelled, elapsed working time and calculated energy expenditure of oxen working in the field. Animal production (in press). (E).
- Lawrence, P. R. and Pearson, R. A. 1985. Factors affecting the measurement of draught force, work output and power of oxen. J. agric. Sci. Camb. 105: 703-714. (E).
- Lawrence, P. R. and Pearson, R. A. 1990. Draft animals. Macmillan Publishers, London, on behalf of CTA (Technical Centre for Agricultural and Rural Cooperation), Wageningen, The Netherlands. (E). (in preparation).
- LCC 1984. Ploughs up to date: 1891 catalogue of ploughs manufactured by R. Hornsby & Sons, Grantham, England (facsimile edition). Museums Service, Lincolnshire County Council (LCC), Lincoln, UK. 66p. (E).
- Lesotho Steel. (undated). Matlama agricultural implements. Publicity brochure for Lesotho Steel Products (Pty) Ltd., Maseru, Lesotho. 6p. (E).
- Löwe, P. 1983. At the heart of Egyptian agriculture: the sakkia. GATE (German Appropriate Technology Exchange) Questions, Answers, Information 4/83: 28-31. (E).
- Löwe, P. 1986. Animal powered systems: an alternative approach to agricultural mechanization. Vieweg, for German Appropriate Technology Exchange (GATE), GTZ, Eschborn, Federal Republic of Germany. 60p. (E,F,G).
- Löwe, P. 1986. Without village artisans the power gear stands idle. GATE (German Appropriate Technology Exchange) Questions, Answers, Information 2/86: 30-32. (E).
- MacPherson, G. A. 1975. First steps in village mechanization. Tanzania Publishing House, Dar es Salaam, Tanzania. (E).
- Major, J. K. 1985. Animal-powered machines. Shire Album 128, Shire Publications, Princes Risborough, UK. 32p. (E).
- Marquart, J. J. 1988. En Italie de 1988, les mulattieri. ARTAP Bulletin de liaison (Association de Recherche sur la Traction Animale et le Portage, Trondes, France) 19: 4-28. (F).
- Marti, A., Allafort, M. T. and Bigot, Y. 1985. La traction animale bibliographie. Mémoires et travaux de l'IRAT No. 10, Institut de Recherches Agronomiques Tropicales (IRAT), Nogent-sur-Marne, France. 194p. (F).
- Marti, A. and Second, C. 1988. Traction animale et développement agricole des régions chaudes: bibliographie annotée 1, expériences et bilan. Centre technique de coopération agricole et rurale (CTA), CIRAD Département IRAT (Institut de recherches agronomiques tropicales et des cultures vivrières) et Centre d'Information et de Documentation en Agronomie des Régions Chaudes (CIDARC), Montpellier, France. 254p. (F).
- Maseng, L. and Jacobs, G. 1985. Two days test of animal driven pump at Gamarotswana. Botswana Technology Centre Report RD9, Gaborone, Botswana. 16p. (E).
- Mata Acuña, D. 1987. Evaluación técnico-económica del sulky como aditamento para la extracción de madera con bueyes. Informe Ingeniero Forestal. Instituto Tecnológico, Cartago, Costa Rica. 100p. (S).

References

- Matthews, M. D. P. 1986. Harnesses for animal power. *FAO World Animal Review* 60: 45-48. (E,F,S).
- Matthews, M. D. P. 1987. Measuring draught animal power of carabaos crossed with exotic buffaloes. *FAO World Animal Review* 63: 15-19. (E,F,S).
- Matthews, M. D. P. and Kemp, D. C. 1985. Techniques proposée pour la mesure précise des performances des boeufs de trait au travail. *Machinisme Agricole Tropical* 91: 12-15 (F).
- Matthews, M. D. P. and Pullen, D. W. M. 1974. Groundnut cultivation trials with ox-drawn equipment: The Gambia 1973/74. Report Series, Overseas Department, National Institute of Agricultural Engineering, Silsoe, UK. 127p. (E).
- Matthews, M. D. P. and Pullen, D. W. M. 1976. Cultivation and ox-drawn implements. Technical Bulletin No 1, Department of Agriculture, Banjul, The Gambia. 42p. (E).
- McCutcheon, R. T. 1985. Donkey-drawn haulage in labour-intensive road construction. *Intermediate Technology* 11, 4: 28-30. (E).
- Mettrick, H. 1978. Oxenisation in The Gambia. Ministry of Overseas Development, London, UK. 68p. (E).
- Micuta, W. 1984. The "Swiss collar" for developing countries. Bellerive Foundation, Geneva, Switzerland. 21p. (E). (unpublished).
- Micuta, W. 1985. The Swiss collar: a harness for developing countries. *Agriculture International* July/August 1985. 37,4: 130-135. (E)
- Mignolet, B., Lécca, M., Ashburner, J. and Romero, G. 1987. Utilisation du matériel de culture attelée. Fiche technique No. 3, Projet Recherche, Formation et Production pour l'Utilisation de Matériel Agricole en Zone Sahélienne, Tahoua, Niger. 23p. (F).
- Moigne, M. Le 1980. Animal-draft cultivation in Francophone Africa. pp. 213-220 in: Socioeconomic constraints to development of semi-arid tropical agriculture. Proceedings of an international workshop held February 1979, Hyderabad, India. ICRISAT, Patancheru, India. 436p. (E).
- Moigne, M. Le 1980. Culture attelée en Afrique francophone. pp. 415-423 in: Socioeconomic constraints to development of semi-arid tropical agriculture. Proceedings of an international workshop held February 1979, Hyderabad, India. ICRISAT, Patancheru, India. 436p. (F).
- Monnier, J. 1965. Contribution à l'étude de la traction bovine au Sénégal. *Machinisme Agricole Tropical*, 10: 3-21 et 11: 15-27. (F).
- Mouzon undated. Ariana pour toutes cultures a plat or irriguées. Publicity leaflet. S. N. Mouzon, 60250 Mouy, France. (Reproduced in Bordet, Lhoste, Le Moigne and Le Thiec, 1988). 2p. (F).
- Muchiri, G. 1983. Production and use of agricultural machinery in Kenya. *Industry and Development* No. 9: 13-38. United Nations Industrial Development Organization (UNIDO), Vienna, Austria. (E).
- Mueller, P. 1987. Can oxen grind grain competitively: Tillers tests rotary power from animal muscle. Tillers Report, Winter 1987: 1-3, Tillers Small Farm Program, Kalamazoo, Michigan USA. (E).
- Mukasa-Mugerwa, E. 1985. Le chameau (*Camelus dromedarius*): étude bibliographique. CIPEA Monographie No. 5, Centre International pour l'Élevage en Afrique (CIPEA/ILCA), Addis Ababa, Ethiopia. 111p. (E,F).
- Müller, H. 1986. Oxpower in Zambian agriculture and rural transport. Edition Herodot Socioeconomic Studies in Rural Development No. 65, Rader Verlag, Aachen, Federal Republic of Germany. 151p. (E).
- Müller, H. 1987. The ox-drawn sledge. *Appropriate Technology* 14 (1): 20. (E).
- Mungroop, R. 1988. Guide pratique du dressage de jeunes bovins pour la culture attelée. DRSPR Volet Fonsébougou, Division de Recherches sur les Systèmes de Production Rurale (DRSPR), Sikasso, Mali. 30p. (F).
- Munzinger, P. 1982. (ed). Animal traction in Africa. GTZ, Eschborn, Federal Republic of Germany. 490p. (E,F,G).
- Munzinger, P. 1985. Sowing, planting and fertilizer distribution. pp. 57-60 in: Tools for agriculture: a buyer's guide to appropriate equipment. Intermediate Technology Publications, London, UK. 264p. (E).
- Naik, V. A. P. 1982. Utilization of animal energy and development of improved carts. *Invention Intelligence* (May 1982) 193-199. (E).
- Nolle, J. 1986. Machines modernes à traction animale. Harmattan, Paris, France. 478p. (F).
- Nourrissat, P. 1965. La traction bovine au Sénégal. *L'Agronomie Tropicale* 9: 823-853. (F).
- Núñez, D., Ladrón de Guevara, O. and Hermoza, R. 1986. Estudio comparativo de arados mejorados con arados tradicionales. pp. 25-43 in: Trabajos de investigación en herramientas e implementos agrícolas: volumen 1. Herrandina, Cusco, Peru. 99p. (S).
- Oliveira, E. V. de, Galhano F. and Pereira, E. B. 1973. Sistemas de atrelagem dos bois em Portugal. Instituto de Alta Cultura Centro de Estudos de Etnologia, Lisbon, Portugal. 124p. (P).
- O'Neill, D. H., Howell, P. J. L., Paice, M. E. R. and Kemp, D. C. 1987. An instrumentation system to measure the performance of draught animals at work. pp. 53-72 in N. S. I. Srivastava and T. P. Ojha (eds): Utilisation and economics of draught animal power. Proceedings of the national seminar on the status of animal energy utilization, held 24-25 September, Bhopal,

- India. Central Institute of Agricultural Engineering, Bhopal, India. (Paper also reproduced by AFRC-Engineering, Silsoe, UK). 22p. (E).
- O'Neill, D. H. and Kemp, D. C. 1988. A comparison of work outputs of draught oxen. AG ENG 88 Paper 88.139 prepared for Agricultural Engineering International Conference, held 2-5 March 1988, Paris, France. Reproduced by AFRC-Engineering, Silsoe, UK. 12p. (E).
- O'Neill, D. H. and Kemp, D. C. 1988. Research to improve the effectiveness of draught ox powered cultivation (Project R3906). Progress Report OD/83/13. AFRC-Engineering, Silsoe, UK. (Limited distribution). 86p. (E).
- Orev, Y. 1977. Improved farming system for Botswana. *Appropriate Technology* 4, 2: 26-28. (E).
- Partridge, M. 1974. *Farm tools*. New York Graphic Society, Boston, Massachusetts, USA. 235p. (E).
- Pathak B. S. 1984. The management and utilization of camels for work. Selection and application of draught animal equipment. pp. 46-51 and 67-81 in: *Animal energy in agriculture in Africa and Asia*. Animal Production and Health Paper 42, FAO, Rome, Italy. 143p. (E,F).
- Pathak, B. S. 1984. Selection and application of draught animal equipment. pp. 67-81 in: *Animal energy in agriculture in Africa and Asia*. Animal Production and Health Paper 42, FAO, Rome, Italy. 143p. (E/F).
- Pearson, R. A. 1989. A comparison of draught cattle (*Bos indicus*) and buffaloes (*Bubalus bubalis*) carting loads in hot conditions. Centre for Tropical Veterinary Medicine, Edinburgh, UK. (Paper submitted to Animal Production). (E).
- Pearson, R. A. 1989. Reduced work output of well fed buffaloes carting loads on the *terai* of east Nepal. *Tropical Animal Health and Production*. (in press). (E).
- Pearson, R. A., Lawrence P. R. and Ghimire, G. 1989. Factors influencing the work done by draught oxen: a study in the eastern hills of Nepal. Centre for Tropical Veterinary Medicine, Edinburgh, UK. (Paper submitted to Animal Production). (E).
- Pietersen, R. and Ffoulkes, D. 1988. Thermoregulator responses in working buffalo with and without covers of wet hessian sacking. DAP Project Bulletin (ACIAR Draught Animal Power Project, James Cook University, Townsville, Australia) No. 5: 23-28. (E).
- Poats, S., Lichte, J., Oxley, J. Russo, S. L. and Starkey, P. H. 1985. Animal traction in a farming systems perspective. Proceeding of Networkshop held March 1985, Kara, Togo. Network Report 1, Farming Systems Support Project, University of Florida, Gainesville, USA. 187p. (E,F).
- Poitreineau, E. 1990. Manuel traction animale. Illustrated extension document prepared by GRDR (Groupe de recherche et de réalisations pour le développement rural dans le tiers monde, Aubervilliers, France) for the Food and Agriculture Organization of the United Nations (FAO), Rome, Italy. (F). (in preparation).
- Potter, G. D. 1986. Logging with mules. *Draught Animal News* 6: 21-24. Centre for Tropical Veterinary Medicine, University of Edinburgh, UK. (E).
- Poussett, J. 1982. *Le cheval: énergie douce pour l'agriculture*. Editions de la Lanterne, Paris, France. 185p. (F).
- Pragasam, A. R. A. 1987. A three-point harness system for single-animal-drawn carts and implements. *World Animal Review* 63: 20-22. (E,F,S).
- Premi, S. C. L. and Singh, Gajendra. 1987. Performance of bullocks under varying conditions of load and climate. pp. 50-63 in N.S.L. Srivastava and T.P. Ojha (eds): *Utilisation and economics of draught animal power*. Proceedings of the national seminar on the status of animal energy utilization, held 24-25 September, Bhopal, India. Central Institute of Agricultural Engineering, Bhopal, India. (E).
- Ramaswamy, N. S. 1979. The management of animal energy resources and the modernization of the bullock-cart system. India Institute of Management, Bangalore, India. 145p. (E).
- Ramaswamy, N. S. 1981. Report on draught animal power prepared for the Food and Agriculture Organization of the United Nations. India Institute of Management, Bangalore, India. 173p. (E). (mimeo).
- Ramaswamy, N. S. 1985. India's animal-drawn vehicles. Department of Science and Technology, New Delhi, India. 200p. (E).
- Ramaswamy, N. S. 1985. Draught animal power: socioeconomic factors. pp. 20-25 in: Copland, J. W., (ed): *Draught animal power for production*. Proceedings of an international workshop held at James Cook University, Townsville, Qld, Australia, 10-16 July 1985. ACIAR Proceedings Series 10, Australian Centre for International Agricultural Research, Canberra. 170p. (E).
- Rathore, G. S. 1986. *Camels and their management*. Indian Council of Agricultural Research, New Delhi, India. 228p. (E).
- Rautaray, S. K. 1985. Output of a pair of bullock during tillage operations in the summer. Proceedings Indian Society of Agricultural Engineers Silver Jubilee Convention held Oct 29-31 1985. Vol. 1: 22-33. (E).
- Rautaray, S. K. 1987. Work output of bullocks during field operations on black soils. pp. 69-87 in N.S.L. Srivastava and T.P. Ojha (eds): *Utilisation and economics of draught animal power*. Proceedings of the national seminar on the

- status of animal energy utilization, held 24-25 September, Bhopal, India. Central Institute of Agricultural Engineering, Bhopal, India. (E).
- Reh, I. 1982. Animal husbandry and veterinary aspects. pp. 67-132 in: Munzinger, P. (ed). Animal traction in Africa. GTZ, Eschborn, Federal Republic of Germany. 490p. (E,F,G).
- Richards, P. 1985. Indigenous agricultural revolution: ecology and food production in West Africa. Hutchinson, London, UK. 192p. (E).
- Ringlemann, M. 1905. Génie rural aux colonies. Paris, France. (Cited by Duchenne, 1984). (F).
- Robinson, G. 1987. Animal traction in Angola. Consultancy report for project UNO/ANG/001/UNE. Food and Agriculture Organization of United Nations (FAO), Rome, Italy. 60p. (E). (unpublished).
- Rodríguez, E. O. 1984. Extracción de trozas mediante bueyes y tractores agrícolas. Montes 49, Food and Agriculture Organization of the United Nations (FAO), Rome, Italy. 104p. (S).
- Rosenberg, R. 1987. In search of a better animal-drawn weeding system. Tillers Report Summer 1987: 1-3. (Tillers Small Farm Program, Kalamazoo, Michigan, USA). (E).
- Rosenberg, R. 1987. Animal-driven shaft power revisited. Tillers Report Summer 1987: 6-8, 13-14. (Tillers Small Farm Program, Kalamazoo, Michigan, USA). (E).
- Ryan, J.G. and Von Oppen, M. 1983. Assessment of impact of deep Vertisol technology options. Economics Program Progress Report 59, International Crops Research Institute for the Semi-Arid Tropics (ICRISAT), Patancheru, India. 14p. (E).
- Salazar, E. A. C. 1981. Estudio comparativo de diferentes yogos y arneses como elementos para mejorar la tracción de los bovinos. CITA, INRA, Cochabamba, Bolivia. 147p. (S).
- Scheinman, D. 1986. Animal draft use in Tanga Region: a descriptive and analytical study assessing the implications of past, present and future Kilimo and TIRDEP involvement. GTZ, Eschborn, Federal Republic of Germany. 240p. (E). (unpublished).
- Scherrer, J. 1966. Traction animale: mesure de puissance des attelages. Compte-rendu de mission en Afrique et à Madagascar. Centre d'Etudes et d'Expérimentation du Machinisme Agricole Tropical (CEEMAT), Antony, France. 200p. (F). (unpublished).
- Seubert, C. 1986. Ox plough adjustment. Field Support Guide FSG 64, Ministry of Agriculture and Cooperatives, Mbabane, Swaziland. 8p. (E).
- SFMP 1984. The development of a locally manufactured wheel and axle unit for ox and donkey carts. Small Farm Mechanisation Programme, Land Development Division, Ministry of Agriculture, Nakuru, Kenya. 6p. (E). (mimeo).
- Shanmugham, C. R. 1982. Farm machinery and energy research in India. Technical Monograph 82/32, Central Institute of Agricultural Engineering, Bhopal, India. 588p. (E).
- Sidibé, C. 1989. Impact de la culture attelée dans la zone d'intervention de l'Opération Haute Vallée, Mali: cas des fermiers pilotes. In: P. Starkey, M. Goe and A. Faye (eds), Animal traction for agricultural development. Proceedings of workshop held 7-12 July 1988, Saly, Senegal. International Livestock Centre for Africa (ILCA), Addis Ababa, Ethiopia. (F/E). (in preparation).
- Silsoe 1986. Animal-drawn implements: a study to assess the feasibility of local manufacture in Sudan. Consultancy report for Ministry of Finance and Economic Planning, Sudan and European Development Fund, Belgium. Silsoe College, Silsoe, UK. 123p. (E). (unpublished).
- Sims, B. G., Moreno, D. R. and Albarran J. S. 1985. El Yunticultor equipo y uso. Folleto Misc. 1, Secretaria de Agricultura y Recursos Hidráulicos (SARH), Instituto Nacional de Investigaciones Agrícolas, Campo Cotaxtla, Veracruz, Mexico. 24p. (S).
- Smith, A. J. 1981. Draught animal research, a neglected subject. World Animal Review 40: 43-48. (E,F,S).
- Smith, D. J. 1979. Discovering horse-drawn farm machinery. Shire Publications, Princes Risborough, UK. 96p. (E).
- Solberg, B. and Skaar, R. 1987. A technical and socioeconomic study of logging in Malawi. Draught Animal News (Centre for Tropical Veterinary Medicine, Edinburgh, UK) No. 8: 4-11. (E).
- Spencer, D. 1988. Farming systems in West Africa from an animal traction perspective. pp. 91-96 in: P. Starkey and F. Ndiame (eds), Animal power in farming systems. Proceedings of workshop held 19-26 Sept 1986, Freetown, Sierra Leone. German Appropriate Technology Exchange (GATE), GTZ, Eschborn, Federal Republic of Germany. 363p. (E/F).
- Spinelli, R. and Baldini, S. 1987. Logging with mules in central Italy. Draught Animal News (Centre for Tropical Veterinary Medicine, Edinburgh, UK) No. 7: 3-7 and 12-13. (E).
- Starkey, P. H. 1981. A modified triangular spike tooth harrow. Appropriate Technology 8 (2): 8-9. (E).
- Starkey, P. H. 1981. Farming with work oxen in Sierra Leone. Ministry of Agriculture, Freetown, Sierra Leone. 88p. (E).
- Starkey, P. H. 1984. The use of draught animal power in the Kasai Occidental and Kasai Oriental regions of Zaïre. Sierra Leone Work Oxen Project, Freetown, Sierra Leone. 41p. (mimeo) (E,F).

- Starkey, P. H. 1986. Draught animal power in Africa: priorities for development, research and liaison. Networking Paper 14, Farming Systems Support Project (FSSP), University of Florida, Gainesville, USA. 40p. (E).
- Starkey, P. H. 1987. Brief donkey work. *Ceres* 20, 6: 37-40. (E,F,S).
- Starkey, P. H. 1987. Animal drawn wheeled toolcarriers: a case for caution. *Appropriate Technology* 14, 1: 10-12. (E).
- Starkey, P. H. 1988. Perfected yet rejected: animal-drawn wheeled toolcarriers. Vieweg/GATE, GTZ, Eschborn, Federal Republic of Germany. 161p. (E).
- Starkey, P. H. 1988. Animal traction directory: Africa. Vieweg/GATE, GTZ, Eschborn, Federal Republic of Germany. 151p. (E).
- Starkey, P. H. 1988. Animal traction research in Southern Mali. Consultancy report for Division de Recherche sur les Systèmes de Production Rurale (DRSPR), Sikasso, Mali. 30p. (E,F). (unpublished).
- Starkey, P. H. and Apetofia, K. 1986. Integrated livestock systems in Nepal and Indonesia: implications for animal traction programs in West Africa. Farming Systems Support Project (FSSP), University of Florida, Gainesville, USA. 64p. (E,F).
- Starkey, P. H. and Ndiame, F. (eds) 1988. Animal power in farming systems. Proceedings of networkshop held 17-26 September 1986 in Freetown, Sierra Leone. Vieweg for German Appropriate Technology Exchange, GTZ, Eschborn, Federal Republic of Germany. 363p. (E/F).
- Starkey, P. H. and Faye, A. 1988. Animal traction for agricultural development. Report of the Third West African Animal Traction Workshop held 7-12 July 1988 at Saly, Senegal. Distributed by GATE, GTZ, Eschborn, Federal Republic of Germany. 35p. (E,F).
- Starkey, P. H., Goe, M. R. and Faye, A. (eds) 1989. Animal traction for agricultural development. Proceedings of workshop held 7-12 July 1988, Saly, Senegal. International Livestock Centre for Africa (ILCA), Addis Ababa, Ethiopia. (F/E). (in preparation).
- Steinmetz, H. 1936. Kuhanspannung in Deutschland. *Arbeiten des Reichsnährstandes* Band 11, Berlin, Federal Republic of Germany. (D).
- Stibbards, R. J. 1980. The energy cost of carrying loads in pack animals. M.Sc. Thesis, Centre for Tropical Veterinary Medicine, University of Edinburgh, UK. (E). (unpublished).
- Stokes, A. R. 1963. Mechanisation and the peasant farmer. *World Crops*, (Dec.): 444-450. (E).
- Swamy-Rao, A. A. 1964. Report on the preliminary investigations, design and development, testing and economic analysis of the new single and double bullock harnesses at the Development Centre from May 1962 to April 1964. Allahabad Agriculture Institute, India. Summarized by Ayre, M. 1981, IT-Transport, Ardington, UK. (E).
- Symington, D. F. 1986. Appropriate Machinery (Lanark/CECI): Summary Report: Inception - October 31, 1986. Prepared for Centre Canadien d'Etudes et de Coopération Internationale (CECI) and International Development Research Centre (IDRC) by Lanark Highland Technology Ltd., Almonte, Canada. 10p. (unpublished).
- Tainsh, J.A.R., and Bursey E.C. 1985. The use of bullocks to raise irrigation water and increase production. *Draught Animal News* (Centre for Tropical Veterinary Medicine, Edinburgh, UK) No. 4: 10-13. (E).
- Tessema, S. and Emojong, E. E. 1984. Feeding of draught oxen for improved and more efficient power. in: *Dryland Farming Research, the Kenya experience*. E. Africa J. Agric. and For. 44: 400-407 (E).
- Thiec, G. Le 1985. Maintenance du matériel agricole et modernization des artisans villageois. *Machinisme Agricole Tropical* 91: 74-77. (F).
- Thiec, G. Le and Bordet, D. 1988. The performance of improved tillage implements for animal draught. AG ENG 88 Paper 88.176 prepared for Agricultural Engineering International Conference, held 2-5 March 1988, Paris, France. Reproduced by Centre d'Etudes et d'Expérimentation du Machinisme Agricole Tropical (CEEMAT), Antony, France 19p. (E).
- Thiec, G. Le and Bordet, D. 1989. Etude de deux outils de traction animale visant à réduire les contraintes de travail du sol en zones sèches. Seminar paper of Centre d'Etudes et d'Expérimentation du Machinisme Agricole Tropical (CEEMAT), Antony, France. In: P. Starkey, M. Goe and A. Faye (eds), *Animal traction for agricultural development*. Proceedings of workshop held 7-12 July 1988, Saly, Senegal. International Livestock Centre for Africa (ILCA), Addis Ababa, Ethiopia. (E). (in preparation).
- Thomas, T. 1989. Animal power production: mechanisms for linking animals to machines. 7p. in: P. Starkey, M. Goe and A. Faye (eds), *Animal traction for agricultural development*. Proceedings of workshop held 7-12 July 1988, Saly, Senegal. International Livestock Centre for Africa (ILCA), Addis Ababa, Ethiopia. (E). (in preparation).
- UNIDO 1982. Information sources on the agricultural implements and machinery industry. UNIDO guide to information sources No. 8, United Nations Industrial Development Organization (UNIDO), Vienna, Austria. 107p. (E).
- UNIDO 1983. The development of African capacities for the design and manufacture of basic agricultural equipment. Sectoral Working

- Paper Series 2, Division for Industrial Studies, United Nations Industrial Development Organization (UNIDO), Vienna, Austria. 58p. (E).
- United Nations, 1975. Animal-driven power gear. United Nations Division of Narcotic Drugs, Geneva, Switzerland. 30p. (E).
- UPROMA 1984. Catalogue et tarii 1 Sept 1984, Unité de Production de Matériel Agricole (UPROMA), Kara, Togo. 20p. (F).
- UPROMA 1986. Catalogue et tarif 1986, Unité de Production de Matériel Agricole (UPROMA), Kara, Togo. 23p. (F).
- Uzureau, C. 1984. La fabrication de matériel agricole à traction animale: des exemples Africains. pp. 82-87 in: Animal energy in agriculture in Africa and Asia. Animal Production and Health Paper 42, FAO, Rome, Italy. 143p. (E/F).
- van Koeverden, G. 1987. Motor tyre collar. Letter from CUSO Field Staff Officer, Bangkok, Thailand. Draught Animal News (Centre for Tropical Veterinary Medicine, Edinburgh, UK) No. 7: 21. (E).
- van Nhieu, J. T. 1982. Animal traction in Madagascar. pp. 427-449 in: Munzinger, P. (ed). Animal traction in Africa. GTZ, Eschborn, Federal Republic of Germany. 490p. (E,F,G).
- Varshney, B. P., Mishra, T. N., Kumar, A. and Singh, R. P. 1982. Performance of harnesses used for draught animals. Agricultural Mechanization in Asia, Africa and Latin America, 13 (3): 15-19. (E).
- Vaugh, M. 1945. Report on a detailed study of methods of yoking bullocks for agricultural work presented to the Imperial Council of Agricultural Research. Indian Journal of Veterinary Science and Animal Husbandry 15, 3, 186-198. (E).
- Viebig, U. 1982. Basic aspects of harnessing and the use of implements. pp. 135-221 in: Munzinger, P. (ed). Animal traction in Africa. GTZ, Eschborn, Federal Republic of Germany. 490p. (E,F,G).
- Vietmeyer, N. 1982. The untapped science of animal power. Ceres, July-August 1982: 42-45. (E,F,S).
- Vis, J. 1989. Notes on the use of horse traction in Dutch forests and the training of teamsters and the horses. 4p. In: P. Starkey, M. Goe and A. Faye (eds), Animal traction for agricultural development. Proceedings of workshop held 7-12 July 1988, Saly, Senegal. International Livestock Centre for Africa (ILCA), Addis Ababa, Ethiopia. (E). (in preparation).
- Von Oppen, M., Ghodake, R. D. Kshirsagar, K. G. and Singh, R. P. 1985. Socioeconomic aspects of transfer of Vertisol technology. Paper prepared for workshop on Management of Vertisols held Patancheru February 1985. Economics Program, International Crops Research Institute for the Semi-Arid Tropics (ICRISAT), Patancheru, India. 23p.
- Von Oppen, M., Ghodake, R. D. Kshirsagar, K. G. and Singh, R. P. 1985. Performance and transfer constraints of improved Vertisol technology. Entwicklung + landlicher raum, 19, 6/85: 11-14. (E).
- Vries, J. de 1986. The "Swiss collar" single-ox harness. p. 2 in: The Heifer Project Exchange No. 30. Heifer Project International, Little Rock, Arkansas, USA. (E).
- Watson, P. R. 1981. Farming with draft animals. Transcentury Press, Washington D.C., USA. 250p. (E).
- Wenger, B. H. 1938. Kummel oder jüge. Landwirtschaftliche Zeitschrift 6 (3 Jun 1938): 546-551. (G).
- Willcocks, T. J. 1969. Animal drawn toolbar. Overseas Liaison Unit Technical Bulletin 2, National Institute of Agricultural Engineering (NIAE), Silsoe, Bedford, UK. 16p. (E).
- Williamson, G. and Payne, W. J. A. 1959. An introduction to animal husbandry in the tropics. Longman, London, UK. 447p. (E).
- Wilson, R. T. 1984. The camel. Longmans, London, UK. 223p. (E).
- Wright, J. and Rodriguez, M. 1986. Projet de cloisonnement de billons par traction animale (TRAP). Newsletter de PC31 SAFRAD OUA 12: 8-11. (E,F).
- Yang-lian, Feng 1984. The use of draught cattle in China. pp. 21-29 in: Animal energy in agriculture in Africa and Asia. Animal Production and Health Paper 42, FAO, Rome, Italy. 143p. (E/F).
- Zaremba, W. 1976. Logging reference manual. (Illustrations by G. D. McCann). Volume 1: Timber preparation and skidding by animals and tractors. Volume 2: Logging roads. Volume 3. Logging accessories (including harnesses). Bulletin 52, Department of Forestry, Pretoria, South Africa. 377, 422, 421p. (E).

Abbreviations and acronyms

ACEMA	Association Euro-Africaine des Centres de Mécanisation Agricole, Cameroon and France	BRT	Bellerive Rural Technology, Switzerland
ACIAR	Australian Centre for International Agricultural Research, Australia	BTC	Botswana Technology Centre, Botswana
ACIAR-DAP	ACIAR Draught Animal Power Project, Townsville, Australia	CAMERTEC	Centre for Agricultural Mechanization and Rural Technology, Tanzania
ACREMA	Atelier de Construction et de Réparations de Matériel Agricole, Niger	CATMI	Camerounian Agricultural Tools Manufacturing Industry, Cameroon
ADMARC	Agricultural Development and Marketing Corporation, Malawi	CDARMA	Centre de Développement Artisanat Rural et Machinisme Agricole, Niger
ADP	Animal Draft Power Programme, Ministry of Agriculture, Zambia	CEEMA	Centre d'Etudes et d'Essais de Machinisme Agricole, Madagascar
ADPRDP	Animal Draft Power Research and Development Project, Magoye, Zambia	CEEMAT	Centre d'Etudes et d'Expérimentation du Machinisme Agricole Tropical, France
AETC	Agricultural Engineering Training Centre, Zimbabwe	CEMAG	Ceara Maquinas Agricolas S/A, Fortaleza, CE, Brazil
AFMA	Atelier de Fabrication de Matériel Agricole, Niger	CIAE	Central Institute of Agricultural Engineering, Bhopal, India
AFRC	Agriculture and Food Research Council, UK	CIMMYT	Centro Internacional de Mejoramiento de Maíz y Trigo, Mexico
AFRC-Engineering	AFRC Institute of Engineering Research (formerly NIAE), Silsoe, UK	CIPEA	Centre International pour l'Elevage en Afrique (ILCA), Ethiopia
AFVP	Association Française des Volontaires du Progrès, France	CMDT	Compagnie Malienne pour le Développement des Textiles, Mali
AGS	Agricultural Services Division of FAO, Italy	CNEA	Centre National d'Equipement Agricole, Burkina Faso
AIRIC	Agricultural Implement Research and Improvement Centre, Nazareth, Ethiopia	COBEMAG	Coopérative Béninoise de Matériel Agricole, Benin
AMRDU	Agricultural Machinery Research and Development Unit, Zambia	COMAG	Société Malgache des Constructions Métalliques et du Matériel Agricole, Madagascar
ARMA	Cellule de l'Artisanat Rural et Machinisme Agricole, Niger	CPATSA	Centro de Pesquisa Agropecuaria do Tropico Semi-Arido, Petrolina, Brazil
ARPON	Amélioration de la riziculture paysanne à l'Office du Niger, Mali	CTVM	Centre for Tropical Veterinary Medicine, Edinburgh, UK
AT	Appropriate Technology	cm	centimetre (unit of length)
ATIP	Agricultural Technology Improvement Project, Botswana	cu. ft	cubic foot (unit of volume, approximately equivalent to 28 litres)
BBF	Broad-bed and furrow (system of cultivation)	cv	cheval vapeur (horse power; unit of power approximately equivalent to 0.75 kW or 1 hp)
BDPA	Bureau pour le Développement de la Production Agricole, France	DAP	draft (or draught) animal power

Abbreviations and acronyms

DLG	Deutsche Landwirtschafts-Gesellschaft (German Agricultural Society), Frankfurt, Federal Republic of Germany)	IAE	Institute of Agricultural Engineering, Zimbabwe
DRSPR	Division de Recherches sur les Systèmes de Production Rurale, Mali	IAR	Institute of Agricultural Research, Ethiopia
d	day	ICRISAT	International Crops Research Institute for the Semi-Arid Tropics, India
dN	decanewton (unit of force approximately equivalent to 1 kg weight)	IEMVT	Institut d'Elevage et de Médecine Vétérinaire des Pays Tropicaux, France
E	English language publication	IITA	International Institute of Tropical Agriculture, Nigeria
E,F	Publication available in separate English and French editions	ILCA	International Livestock Centre for Africa, Ethiopia
E/F	Single publication, partly in English and partly in French	ILO	International Labour Organisation, Switzerland
EFSAIP	Evaluation of Farming Systems and Agricultural Implements Project, Gaborone, Botswana	INRA	Institut National de la Recherche Agronomique, Settat, Morocco
EMBRAPA	Empresa Brasileira de Pesquisa Agropecuária, Brasília, Brazil	IRRI	International Rice Research Institute, Manila, Philippines
ENDA	Environment and Development in the Third World, Senegal	ISC	ICRISAT Sahelian Centre, Niger
F	French language publication	ISRA	Institut Sénégalais de Recherches Agricoles, Senegal
FAO	Food and Agriculture Organization of the United Nations, Rome, Italy	IT	Intermediate Technology
FMDU	Farm Machinery Development Unit, Botswana	IT-Transport	Intermediate Technology Transport, UK
FRG	Federal Republic of Germany	ITDG	Intermediate Technology Development Group, UK
FSERT	Fédération suisse d'élevage de la race tachetée rouge, Switzerland	ITP	Intermediate Technology Publications, London
f	foot (measurement approximately equivalent to 30 cm)	imp	imperial (system of weights and measures once widely used in Britain and elsewhere)
G	German language publication	J	joule (unit of work or energy)
GARD	Gambian Agricultural Research and Diversification Project, The Gambia	JMRDP	Jebel Marra Rural Development Project, Sudan
GATE	German Appropriate Technology Exchange, GTZ, Germany (FRG)	kg	kilogram
GOM	Geest Overseas Mechanisation Ltd, UK	kgf	kilogram force (unit of force approx. equivalent to 1kg weight or 10N)
GRDR	Groupe de recherche et de réalisations pour le développement rural dans le tiers monde, France	kJ	kilojoule (unit of work or energy)
GRET	Groupe de Recherche et d'Echanges Technologiques, France	km	kilometre
GTZ	Deutsche Gesellschaft für Technische Zusammenarbeit GmbH, Federal Republic of Germany	kN	kilonewton (unit of force approximately equivalent to 100 kg f)
g	gram (unit of mass)	kph	kilometres per hour
h	hour	LENCO	Lusaka Engineering Company, Zambia
ha	hectare	l	litre
hp	horsepower	lb	pound (unit of mass approximately equivalent to 0.45kg)
IAD	International Agricultural Development	lbf	pound force (unit of force approximately equivalent to 0.45kg weight)
		MIAC	MidAmerica International Agricultural Consortium, USA

MJ	megajoule (unit of energy or work)	SISMAR	Société Industrielle Sahélienne de Mécaniques, de Matériels Agricoles et de Représentations, Senegal
MoA	Ministry of Agriculture	SMECMA	Société Malienne d'Etude et de Construction de Matériel Agricole, Mali
M.Sc.	Master of Science, university degree	s, or sec	second
m	metre	TAMTU	Tanzania Agricultural Machinery Testing Unit, Tanzania
mm	millimetre	TIRDEP	Tanga Integrated Rural Development Programme, Tanzania
mph	miles per hour	TROPIC	Société camerounaise de métallurgie, Cameroon
N	newton (unit of force approximately equivalent to 0.1 kg weight)	TUB	Technische Universität Berlin, FRG
NGO	Non-governmental organization	t	tonne
NIAE	National Institute of Agricultural Engineering, UK	UCOMA	Unité Construction Matériel Agricole, Niger
Nm	newton metre (unit of work or energy equivalent to 1 joule)	UFI	Ubango Farm Implements, Tanzania
OAU	Organization of African Unity	UK	United Kingdom
OHV	Opération Haute Vallée, Mali	UN	United Nations
P	Portuguese language publication	UNDP	United Nations Development Programme, USA
PAFSAT	Project for Promotion of Adapted Farming Systems based on Animal Traction, Cameroon	UNIDO	United Nations Industrial Development Organization, Austria
Ph.D.	Doctor of Philosophy degree	UPROMA	Unité de Production de Matériel Agricole, Togo
PP	Projet Productivité, Niger	USA	United States of America
PROPTA	Projet pour la Promotion de la Traction Animale, Togo	USAID	United States Agency for International Development, USA
PVC	polyvinyl chloride (synthetic material)	USOA	Usine des Outillages Agricoles, Guinea
RIIC	Rural Industries Innovation Centre, Botswana	VITA	Volunteers in Technical Assistance, USA
RNAM	Regional Network for Agricultural Machinery, Los Baños, Philippines	W	watt (unit of power)
RTDU	Rural Technology Development Unit, Kenya	W.	West
r.p.m	revolutions per minute	WADA	Wum Area Development Authority, Cameroon
SADCC	Southern Africa Development Coordination Conference	WOP	Work Oxen Programme, Sierra Leone
SAFGRAD	OAU Semi-Arid Food Grain Research and Development, Burkina Faso	WSDC	Western Savannah Development Corporation, Sudan
SFMP	Small Farm Mechanization Programme, Nakuru, Kenya	WTC	wheeled toolcarrier
SFP	Small Farm Program (Tillers Small Farm Program, Michigan, USA)	yd	yard (unit of length approximately equivalent to 0.9 metre)
SISCOMA	Société Industrielle Sénégalaise de Constructions Mécaniques et de Matériels Agricoles, Senegal	ZZK	Zana za Kilimo, Mbeya, Tanzania
		"	inch ("pouce" in French) measurement unit equivalent to about 25mm

Glossary

Anglebar	a multipurpose toolbar designed by Project Equipment, UK	collar	part of a harnessing system; a padded O or U-shaped device that fits around the neck of animal and rests around the "shoulders".
araire	ard plow (F).	coulter	knife- or disc-shaped attachment to a plow that cuts vertically into the soil and any vegetation immediately in front of plowshare.
Arara	a multipurpose toolbar manufactured in Benin, Niger, France (Société Arara) and elsewhere.	couplings	harnessing straps or ropes linking a pair of animals and preventing them moving apart.
ard	symmetrical plow without mouldboard, usually of traditional wooden design.	digger body	plow body with a short, upright mouldboard that breaks up the soil as it turns.
Ariana	multipurpose rectangular toolframe designed by Jean Nolle; intermediate between simple toolbar and wheeled toolcarrier.	dissel boom	long traction shaft of cart or pole-drawn implement
attelage	team of animals (F).	duckfoot share	broad, triangular share (often about 150mm wide) set almost horizontally for cultivating or weeding.
BBF system	broadbed and furrow system of cultivation on large flat ridges.	dynamometer	instrument for measuring force.
blade	secondary cultivation implement widely used in Asia; based on narrow horizontal blade (sweep) that passes through soil surface.	equine	relating to horses, donkeys and mules; sometimes used as collective noun for these species.
harrow		ergometer	instrument for measuring work (measures force and distance)
(bakhar)		evener	pieces of wood arranged at right angles to direction of movement between the harnessing traces and an implement; since the point of power offtake is not central, they can be used as levers to combine the efforts of two or more animals of dissimilar strength.
Bos indicus	a species of cattle, typified by presence of hump; includes most breeds from Asia and tropical Africa.	forecarriage	two wheels supporting the front of a plow; seldom used in Africa.
Bos taurus	a species of cattle, typified by absence of hump; including most "European" breeds.	forehead-yoke	an uncommon yoking system in which yoke is attached <i>in front</i> of the horns of an animal.
bovine	relating to cattle species; sometime used as a collective noun for these.	frog piece	shaped central element of mouldboard plow body, to which share, mouldboard, landside and beam are bolted.
breaking-plow	term sometimes used to refer to the stronger ard plows.		
breaching-strap	part of a harnessing system; a strap or cord that passes behind an animal, and prevents harness moving forward during braking.		
bridle	part of a harnessing system; straps or cords that pass around head of animal.		
broad-beds	large flat ridges		
bund	a ridge used to control water flow.		
butteuse	earthing-up ridger (F).		
Ciwara	a multipurpose toolbar manufactured in Mali, similar to Houe Sinc.		

furrow-wheel	a second wheel, usually larger than the landwheel, used in some plows to provide additional stability.		
hake	front part of plow to which draft chain may attach	landside	the part of a mouldboard plow body that runs in the furrow; it assists plow stability by reducing pitching and by offsetting the lateral forces associated with the asymmetrical inversion of the soil (to one side only).
halter	part of harnessing system; strap or rope tied around head of an animal to assist control.	manège	circular animal-powered device for driving stationary equipment [literally roundabout] (F).
hame	rigid vertical bars on either side of an animal to which traces are attached; the hames are separated from the animal by a collar or pads.	maresha	local name for the ard commonly used for plowing in the Ethiopian highlands.
harnais	harness (F).	metabolic energy	energy required or used to maintain normal cell or body functions.
head yoke	yoke fixed behind the head of an animal, tied to the horns; synonymous with horn yoke.	monobeouf	single ox (F).
heel	rear end of the landside of a plow, that assists stability and pitch control; a wearing part that may be detachable and replaceable.	mote	type of water raising system
houe	cultivator or weeder (F); some multipurpose toolbars were developed primarily as cultivators.	mouldboard	shaped piece of metal or wood designed to divert soil to one side of a share.
Houe-Occidentale	a design of small cultivator and multipurpose toolbar that can be used with donkeys and horses; manufactured and used in West Africa.	mouldboard plow	plow with a mouldboard fitted; the design is asymmetrical, as soil is diverted to one side only.
Houe-Saloum	a design of multipurpose toolframe, that preceded the Ariana.	N'Dama	breed of small, humpless cattle found in West Africa; relatively tolerant of the disease trypanosomiasis.
Houe-Sine	a design of multipurpose toolbar designed by Jean Nolle; widely used and manufactured in West Africa.	neck yoke	a confused term that should be dropped since some authors have used it to refer to head/horn yokes and others to refer to withers yokes.
Houe-Manga	a design of small cultivator/weeder with adjustable width settings manufactured in West Africa that can be used with single donkeys.	newton	unit of force, approximately equivalent to 0.1 kg weight
horn yoke	yoke fixed behind the head of an animal, tied to the horns; synonymous with head yoke.	Nikart	a design of wheeled toolcarrier, developed by ICRISAT and AFRC--Engineering.
horsepower	unit of power, approximately equivalent to 0.75 kW.	nominal size	yoking term; the distance between [the centres of] two yoked animals.
joug	yoke (F).	Pecotool	design of multipurpose toolbar manufactured on small scale in Sierra Leone and Tanzania.
joug de corne	horn or head yoke (F).	pitching	the rotation of a body in a vertical plane parallel to the direction of forward movement; "up and down" movement of an implement.
joug de garrot	withers yokes (F).	Policultor 300	design of multipurpose toolbar manufactured in Brazil; based on Houe Sine.
joug de nuque	horn or head yoke [literally neck yoke] (F).	Polyculteur	wheeled toolcarrier (F); specific designs of wheeled toolcarrier developed in Senegal in the 1950s and 1960s.
joug de tête	horn or head yoke (F).	pouce	inch (F).
joug frontal	forehead yoke (F).	power	the <i>rate</i> of doing work.
Kanol	a design of multipurpose toolbar developed by Jean Nolle that uses a		

Glossary

puddler	implement for breaking up and mixing (puddling) the top soil of a flooded rice ("paddy") field.	swingle tree	horizontal bar to which harnessing traces attach; the bar keeps the traces separated, and transmits the force to an evener or implement.
rayonneur	row marker (F).	taurine	<i>Bos taurus</i> type of cattle, including "European" breeds and some West African humpless breeds such as the N'Dama.
ripper	strong line used to break up heavy soil.	three pad collar	type of harnessing system using two shoulder pads attached to rigid hames and a top withers pad.
rolling	the rotation of a body in a vertical plane at right angles to the direction of forward movement; the "tipping over" movement of an implement.	tines	the soil-contacting descending bars of a cultivator or teeth of a harrow.
saddle	part of a harness lying over the back of an animal that supports a back load or strap.	traces	the traction ropes, straps or chains that pass either side of an animal and transmit the force from animal to implement.
Sahel	semi-arid zone to the south of the Sahara Desert.	Triangle	a design of multipurpose cultivator/weeder used in Burkina Faso and Togo.
sakia	traditional animal-powered water-raising device used in Egypt.	Tropicultor	one of Jean Nolle's designs of wheeled toolcarrier, further developed by ICRISAT.
scratch plow	a term sometimes applied to an ard plow.	turn-wrest plow	reversible mouldboard plow
semi-digger	plow body with a fairly short and upright mouldboard that tends to break up the soil as it turns.	Unibar	a prototype design of multipurpose toolbar developed by Project Equipment, UK, in the 1960s.
semi-hellicoidal	mouldboard shape that produces a more gradual soil inversion than a semi-digger.	vertisol	heavy black soil, "black cotton soil".
Senegambia	the combined territories of Senegal and The Gambia.	wheeled toolcarrier	multipurpose implement based on a transverse toolbar supported by two wheels; the toolbar accepts a variety of implements including (in many cases) a cart body.
share	the wearing blade of a plow or similar implement.	whippletree	swingle tree; horizontal bar to which harnessing traces attach; the bar keeps the traces separated, and transmits the force to an evener or implement.
shoulder yoke	yoke resting on the "withers" of an animal above the shoulders.	withers	that part of the back of an animal that is over the shoulders and directly above the first thoracic vertebrae.
skels	a term used in southern Africa for the vertical wooden pegs that form part of a yoke.	yawing	the rotation of a moving body in a horizontal plane; the "side to side" deflection of an implement moving forward.
skid	a supporting part of an implement designed to pass easily over the ground surface; an alternative to a wheel, which may be made of wood or curved steel.	yoke	strong bar, usually made of wood, which an animal can push against in order to pull an implement.
Super Eco	a design of seeder manufactured in Senegal and quite widely used in West Africa.	zebu	type of <i>Bos indicus</i> humped cattle.
Strad	an over-the-row weeder, designed for ridge cultivation in Nigeria, with two or more gangs of rotating tines.		
strops	term used in southern Africa for leather harnessing thongs.		
swing plow	mouldboard plow design without a furrow wheel or skid to support the beam.		

Note: (F) indicates a French word.

Addresses of some organizations cited

The following annotated address list contains the names and addresses of some of the "resource" organizations cited, some of the projects mentioned in the previous chapters and some of the manufacturers of animal traction implements in Africa. The mention of manufacturers here does not constitute an endorsement of any products. While the information is provided in good faith, changes are rapid in this field and the accuracy of the addresses and descriptions cannot be guaranteed. Further details of organizations in Africa, are to be found in the GATE Animal Traction Directory: Africa.

Australia

ACIAR-Draught Animal Power Project,
Graduate School of Tropical Veterinary Science,
James Cook University, Townsville 4811,
Queensland, Australia Telex 47009 UNITOWN AA

The Coordination Unit of the ACIAR-supported Draught Animal Power Project is based at James Cook University. Research topics include the nutrition of working buffaloes and small numbers of fistulated buffaloes have been trained for work. Other areas of research interest include health and reproduction and farming systems research relating to animal traction. The DAP Project liaises with draft animal programmes in several southeast Asian countries, and has particularly strong links with research programmes in Indonesia. It publishes the DAP Project Bulletin twice a year. It assisted the convening of the second ACIAR international workshop on draft animal power in Indonesia in 1989.

Austria

**United Nations Industrial Development
Organization (UNIDO),**
Vienna International Centre, P.O. Box 300,
A-1400 Vienna, Austria Telex: 135612

UNIDO is a UN agency with particular interest in developing local industries, including the manufacture of animal traction equipment at factory, workshop and village blacksmith level. It has supported networking in Asia (RNAM) and Southern Africa (SADCC countries). It has published directories of organizations concerned with the development and production of agricultural implements.

Belgium

**Commission of the European Communities
(EC, EDF, FED), 200 rue de la Loi,
B-1049 Brussels, Belgium Telex: 21877 COMEU B**

The European Community finances a large number of rural development projects in Africa, and elsewhere, many of which have draft animal components.

Benin

**Coopérative Béninoise de Matériel Agricole
(COBEMAG), B.P. 161, Parakou, Benin**

The parastatal COBEMAG, established with UNDP support, is the major manufacturer of animal-drawn equipment in Benin. Organized as a cooperative, it delegates much of its fabrication work to blacksmiths in different villages. In recent years it has received technical support from FAO, but lack of capital to purchase raw materials has restricted the production runs of the main items, Arara multipurpose toolbars and ox-carts.

Botswana

**Farm Machinery Development Unit,
Sebele Agricultural Research Station,
Private Bag 0033, Gaborone, Botswana
Telex: 2752 SACAR BD**

The Farm Machinery Development Unit (FMDU) and the earlier EFSAIP have tested and developed animal traction equipment. Several wheeled toolcarrier designs were evaluated during the period 1971-1983, but none was found appropriate for small-farm conditions. Tine-tillage techniques were tested for several years but it was concluded that deep mouldboard plowing and rapid planting were most appropriate. Therefore a com-

bined plow-planter, comprising a simple seeder attached to a conventional plow, was developed and is being promoted.

Agricultural Technology Improvement Project (ATIP), Department of Agricultural Research, Private Bag 0033, Gaborone, Botswana

Farming systems research project, supported by USAID, that includes work on cultivation strategies using draft animals and supplemental feeding.

Rural Industries Innovation Centre (RIIC), Private Bag 11, Kanye, Botswana Telex: 2435 BD

RIIC is an appropriate technology organization and part of Rural Industries Promotions, a non-profit development organization supported by government grants and aid agencies. Work includes blacksmith training and small-scale equipment research, development and manufacture. It has developed first and second generation prototypes of donkey-powered water pumps. It manufactures small numbers of seeders and plow-planters, and has been cooperating with a network of several small workshops in developing the production of these implements in several parts of the country.

Southern African Centre for Cooperation in Agricultural Research (SACCAR), Private Bag 00108, Gaborone, Botswana

Telex: 2752 SACAR BD

SACCAR facilitates liaison in agricultural research within the nine member states of SADCC. Animal traction is one of SACCAR's areas of interest. It sponsored a regional workshop on animal traction in 1987.

Brazil

CEMAG Ceara Maquinas Agricolas S/A, Av. Gaudioso de Carvalho, 217 Bairro Jardim Iracema, C.P. D79 CEP 60000, Fortaleza, CE, Brazil.

Telex: (085) 1533 CMGL BR

Manufacturer of agricultural equipment including a range of animal-drawn multipurpose toolbars and wheeled toolcarriers based on Jean Nolle's designs.

Empresa Brasileira de Pesquisa Agropecuaria (EMBRAPA), C.P. 04-0315, Brasilia-DF, Brazil

Centro de Pesquisa Agropecuaria do Tropico Semi-arido (CPATSA), CP 23, Petrolina, Pernambuco, Brazil

EMBRAPA is the national agricultural research organization of Brazil responsible for numerous specialized centres and research stations. CPATSA

is a regional research unit specializing in the semi-arid parts of the country where there is most potential for draft animals. Research with animal traction has included the development of wheeled toolcarriers, ridge-tying implements and injection seeders.

Burkina Faso

Centre Nationale d'Equipelement Agricole (CNEA), B.P. 7240, Ouagadougou, Burkina Faso

Manufacturer of animal traction equipment. Its network of two large and nine small workshops in several parts of the country has been reduced for financial and logistical reasons. Main products are simple plows and triangular cultivators, often still known by the previous acronym ARCOMA.

SAFGRAD, B.P. 1785, Ouagadougou, Burkina Faso Telex: 5381 SAFGRAD BF

The Semi-Arid Food Grain Research and Development (SAFGRAD) programme of the Organization of African Unity has a farming systems research team and has been working with animal traction in Burkina Faso. It has developed, in cooperation with IITA, a prototype animal-drawn ridge tying implement. SAFGRAD acts as host organization to a number of research networks in Africa, including the West African Farming Systems Research Network (WAFSRN/RESPAO). In 1989 SAFGRAD offered to act as host to the secretariat of the West Africa Animal Traction Network.

Cameroon

PAFSAT (Project for Promotion of Adapted Farming Systems based on Animal Traction in the N. W. Province of Cameroon), Northwest Development Authority (MIDENDO), B.P. 558, Bamenda, Cameroon

Animal traction project that has been working on farming systems development involving animal traction. Emphasis has been placed on contour farming, and women's groups have been encouraged to adopt animal traction. Activities have included farmer training, equipment evaluation and the development of an animal-drawn knife roller to clear small farms.

TROPIC, Societe camerounaise de metallurgie, B.P. 706, Douala, Cameroon Telex: 5316 KN

Manufacturer of a range of animal traction equipment including mouldboard plows, multipurpose toolbars and carts.

Cameroonian Agricultural Tools Manufacturing Industry (CATMI), Bamenda, Cameroon

Small manufacturer of implements including plows and prototype weeder rollers.

Ethiopia

Institute of Agricultural Research (IAR),
P.O. Box 2003, Addis Ababa, Ethiopia

IAR has many programmes and cooperating sub-centres and its work includes several collaborative animal traction research programmes with ILCA. The Agricultural Engineering Department has been carrying out research relating to animal traction for ten years and current topics of research include the evaluation and development of implements for secondary tillage, land levelling, and seeding. IAR has an Agricultural Implement Research and Improvement Centre at Nazareth, which receives technical support from FAO.

International Livestock Centre for Africa (ILCA),
P.O. Box 5689, Addis Ababa, Ethiopia

Telex: 976-21207 ILCA

ILCA is an international research centre, with its headquarters in Ethiopia. ILCA has a very strong interest in draft animals and has a specific animal traction research "thrust". Studies on draft animal nutrition, equipment and systems of utilization have been carried out in Ethiopia, Niger, Nigeria and Mali. ILCA's library contains numerous documents relating to draft animals which have been listed in its animal traction bibliographies and bibliographic databases. ILCA's information department may assist research scientists in Africa to obtain photocopies or microfiches of relevant documents. ILCA coordinates an Animal Traction Research Network which aims to stimulate collaboration between different national and international research programmes. The network started publishing a newsletter in 1988. ILCA has produced several publications relating to animal traction.

France

Centre de Recherches CIRAD,
Avenue du Val de Montferrand,
B.P. 5035-34032, Montpellier Cedex, France

The agricultural research organization CIRAD (Centre de Coopération Internationale en Recherche Agronomique pour le Développement) has several institutes working on animal traction topics. Its main "Agropolis" campus is in Montpellier, and most CIRAD organizations including Institut de Recherches Agronomiques Tropicales (IRAT) and CEEMAT will be based there in the future. The CIRAD has hosted several seminars relating to animal traction and its Service de Do-

cumentation has produced three animal traction bibliographies in conjunction with CTA and other CIRAD organizations (CEEMAT, IRAT, IEMVT).

**Centre d'Etudes et d'Expérimentation du
Machinisme Agricole Tropical (CEEMAT),**
Parc de Tourvoie, 92160 Antony, France

Telex: 201296 CEEMAT F

CEEMAT is an agricultural engineering research and training institute sponsored by the French government through CIRAD. CEEMAT has long been associated with the development of animal traction, most notably in francophone Africa, but also in several countries in Asia and Latin America. Work includes the design and testing of alternatives to mouldboard plows including animal-drawn tines and rolling cultivators, economic studies, an animal traction bibliography and guidelines for rural workshops. It produces the quarterly journal *Machinisme Agricole Tropical*. CEEMAT also provides the European Secretariat for the agricultural engineering network ACEMA (Association Euro-Africaine des Centres de Mécanisation Agricole). The African Secretariat of ACEMA is based in CENEEMA in Cameroun.

**Institut d'Élevage et de Médecine Vétérinaire des
Pays Tropicaux (IEMVT),** 10 rue Pierre-Curie,
94704 Maisons-Alfort Cedex, France

Telex: 262017 IEMVT F

IEMVT is a veterinary and animal production institution financed by the French government through CIRAD. IEMVT has undertaken studies relating to draft animals in several francophone countries.

**Groupe de Recherche et d'Echanges
Technologiques (GRET),** 213 rue La Fayette,
75010 Paris, France

Telex: 212890 F

GRET is a centre for information exchange relating to research and development on appropriate technologies, including animal traction. GRET has many network contacts in France and developing countries, and it publishes a networking newsletter *Recherche et Développement*. It has a documentation centre and produces books and technical pamphlets, which include publications on harnessing, animal powered pumps and animal traction equipment.

**Groupe de recherche et de réalisations pour le
développement rural dans le tiers monde (GRDR),**
8 rue Paul-Bert, 93300 Aubervilliers, France

GRDR is an NGO working in development research and training, both in France and in several

West African countries. Research activities in cooperation with GRET, IT-Dello, ENDA and other organizations include the development of animal-powered water pumps. It has produced animal traction publications in cooperation with GRET and FAO. Practical training with working animals and animal-powered pumps is given at its training farm in France.

Institut Technologique Dello (IT-Dello),
Le Moulin Rouge, 60410 Verberie, France

Appropriate technology organization that has been involved in the development of animal-powered pumps.

Association de Recherche sur la Traction Animal et le Portage (ARTAP), 54570 Trondes, France

ARTAP is an association of people interested in animal traction research and development and many of its members use working animals on their farms in France. Since 1983 it has produced a lively and informative quarterly bulletin dealing with many different aspects of animal traction, with most information based on French and European experiences.

Ste Nouvelle Mouzon, B. P. 26, 60250 Mouy
(Oise), France Telex: 150990 MOUZON F

EBRA-Överum, 28 rue du Maine, B.P. 404,
49004 Angers Cédex, France Telex: 720348 F

Bourguignon S.C.A.D., B.P. 37,
26301 Bourg-de-Péage Cédex, France
Telex: 345951 F

French manufacturers of animal traction equipment. All make plows and multi-purpose toolbars. Ebra-Överum is noted for its seeders, while Mouzon specializes in the Jean Nolle range of implements including the Ariana toolframe and Tropiculator wheeled toolcarrier.

Bureau pour le Développement de la Production Agricole (BDPA), 202 rue de la Croix Mivert,
75738 Paris Cedex 15, France

Compagnie Française pour le Développement des Fibres Textiles (CFDT),
13 rue Monceau, 75008 Paris, France

Broadly-based development organizations that have carried out research-development studies relating to animal traction and have provided technical assistance for draft animal extension programmes in Africa.

The Gambia

The Gambian Agricultural Research and Diversification Project (GARD),
Department of Agriculture, Cape St. Mary,
The Gambia Telex: 2229 AMEMB GV

A USAID-assisted development project that is supporting work on animal traction.

Germany (Federal Republic)

Deutsche Gesellschaft für Technische
Zusammenarbeit (GTZ), D - 6236 Eschborn 1,
Postfach 5180, Germany (FRG)

GTZ is financing several projects in Africa undertaking research and development on animal traction. GTZ and its specialized division German Appropriate Technology Exchange (GATE) has published several books on animal traction. GATE is currently supporting research and development on animal powered gears, mills and water-lifting devices in Africa, Asia and Latin America. GATE publishes a quarterly journal *GATE Questions-Answers-Information*.

Fachbereich 15 Internationale Agrarentwicklung,
Institut für Agrarbetriebs und Standortökonomie,
Technische Universität Berlin,
Im Dol 27-29, D-1000 Berlin 33, Germany (FRG)

Animal traction has been one of the research interests of the Technical University of Berlin for a number of years and staff have been involved in evaluating animal traction programmes in Bangladesh, Ethiopia, Togo, Zambia and West Africa. A questionnaire survey on the use of animal traction equipment and techniques in several parts of the world was carried out in 1988-89. Staff of the university took part in a research programme in Brazil designed to develop an animal-drawn seeder capable of planting through mulch.

Institut für Agrartechnik, Universität Hohenheim,
Garbenstraße 9, P.O. Box 700562, 7000 Stuttgart 70,
Germany (FRG) Telex: 7255202 ATHO D

Staff of the University of Hohenheim have been carrying out animal traction research in collaboration with the ICRISAT Sahelian Centre, Niger. Studies have concentrated on the working power of different draft animals, the draft forces imposed by tines, ridgers and plows, stationary animal-powered systems and animal-drawn carts.

Institut für Landtechnik, Universität Gießen,
Gießen 1, Germany (FRG)

The agricultural engineering department of the University of Giessen has been involved in the development of animal-drawn implements. One pro-

ject involved the design and testing of weeder-rollers, in conjunction with TIRDEP, Tanzania.

Deutsche Landwirtschafts-Gesellschaft (DLG),
Zimmerweg 16, D-6000 Frankfurt 1,
Germany (FRG)

DLG, the German Agricultural Society, has held various seminars relating to agricultural equipment, including one in 1987 on north-south co-operation in the manufacture of implements.

Ghana

Department of Agriculture Regional Office,
P.O. Box 171, Tamale, Ghana

The Department of Agriculture regional office at Tamale is responsible for a workshop, established with GTZ assistance, for the manufacture of ox plows, cultivators and carts.

Guinea

Usine des Outillages Agricoles (USOA),
Mamou, Guinea

Agricultural implement factory, build with Chinese technical assistance. It is responsible to the Ministry of Industries and manufactures lightweight mouldboard plows and harrows. Due to infrastructural problems it has not been working at capacity or meeting national requirements. Refurbishment with the backing of a Belgian company appears likely.

India

Central Institute of Agricultural Engineering
(CIAE), Nabi Bagh, Berasia Road,
Bhopal 462 018, India

The national CIAE has been undertaking research on animal-drawn implements for many years. It has published numerous research reports and papers on the subject. It has cooperated with AFRC-Engineering in field trials of computer-based data-logging equipment that measures a range of factors relating to force, power and work output of animal-implement combinations in the field.

International Crops Research Institute for the
Semi-Arid Tropics (ICRISAT), Patancheru P.O.,
Andra Pradesh 502 324, India

Telex 152 203 ICRI IN

ICRISAT is an international research centre with its headquarters in India. It is expanding its ICRISAT Sahelian Centre in Niger into an important secondary research station and base for many of its programmes in Africa. ICRISAT has been very closely involved in the development of draft ani-

mal power, particularly within its Resource Management Programme. Between 1974 and 1987 ICRISAT was closely involved with the development of wheeled toolcarriers. Most of its animal traction research and publications were centred on these implements. Other animal traction work has included economic studies (Burkina Faso) and the development of prototype rolling crust-breakers (India) and ridge-tiers (Burkina Faso).

Mekins Agro Products Pvt Ltd.,
6-3-866/A Begumpet, Greenlands,
Hyderabad AP 500 016, India Telex: 155-6372

Mekins is a company that manufactures and exports animal traction implements. It cooperated closely with ICRISAT in the development of wheeled toolcarriers.

Cossul and Co. Pvt. Ltd.,
123/367 Industrial Area, Fazalgunj, Kanpur-12,
Uttar Pradesh, India. Telex: 0325-309 COSL

Cossul is a manufacturer and exporter of relatively simple and cheap steel implements, including animal-drawn plows, harrows and ridgers.

Italy

Food and Agriculture Organization of the United
Nations (FAO), Via delle Terme di Caracalla,
00100, Rome, Italy Telex: 616022 FAO I

FAO is the major UN agency concerned with agricultural development. It sponsors, and/or provides technical assistance to, numerous agricultural research, development, extension and training projects some of which are directly or indirectly related to animal power utilization. The Agricultural Services Division (AGS) has chaired the FAO inter-departmental draft animal power liaison committee. FAO has published several books relating to animal traction. In 1988 FAO commissioned GRDR to prepare an animal traction extension manual, and CEEMAT and AFRC-Engineering to prepare "state of the art" reports on animal traction.

Kenya

Rural Technology Development Unit (RTDU),
P.O. Box 470, Nakuru, KENYA

The Land Development Division of the Ministry of Agriculture has responsibility for many animal traction activities in the country, including the RTDU. The RTDU has over the last ten years tested over 150 agricultural implements, and recommended four items of animal traction equipment: a lightweight mouldboard plow, a longbeam plow, a multipurpose toolbar and carts using saw-

Addresses

dust-packed tyres. These implements have yet to be widely adopted.

**University of Nairobi, Kabete Campus,
P.O. Box 30197, Nairobi, Kenya**

The Department of Agricultural Engineering has been working for several years on animal traction equipment including the use of toolbars fitted with Indian-style "Desi" plow-bodies, made of steel, for inter-row weeding. The Animal Draft Power Development Project has been carrying out research on use of three-pad harnesses for cattle and donkeys and the employment of donkeys for crop cultivation. It has organized training course for the local production of three-pad harnesses.

**Ideal Casements E.A. Ltd., P.O. Box 45319,
Nairobi, Kenya**

Steel Fasteners Ltd., P.O. Box, Nairobi, Kenya

Mamuki Industries, P.O. Box 88, Ruiru, Kenya

**Appropriate Implements Project, Lugari Extension
Programme, P.O. Box 125, Soy, Kenya**

Manufacturers of plows and cultivators.

Lesotho

**Northern Lesotho Steel and Diesel Engineering,
Maputsoe, Lesotho**

Manufacturer of scotch carts.

**Lesotho Steel Products, P.O. Box 1564,
Maseru, Lesotho** Telex 4235 LO

Manufacturer of agricultural implements that has been supported by UNIDO to develop animal drawn implements. Its multipurpose Matlama simple toolbar has attachments for plowing, cultivating, harrowing and seeding, although some of these attachments are still undergoing development. Steel yokes are also fabricated.

Madagascar

**Centre National de l'Artisanat Malagasy (CNAM),
B.P. 540 Antananarivo, Madagascar**

**SIDEMA (Société Industrielle pour le
Développement du Machinisme Agricole),
B.P.14, Antananarivo, Madagascar**

**Société Malgache des Constructions Métalliques et
du Matériel Agricole (COMAG),
Antananarivo, Madagascar**

Manufacturers of animal traction equipment.

Malawi

**Agrimal (Malawi) Ltd., P.O. Box 143,
Blantyre, Malawi** Telex: 4750 MI

Commercial manufacturer of basic plows, ridgers and toolbars. Some export sales.

**Petroleum Services Ltd.,
P.O. Box 1900, Blantyre, Malawi**
Manufacturer of animal drawn carts.

Mali

**Compagnie Malienne pour le Développement des
Textiles (CMDT), B.P. 487, Bamako, Mali**
Telex: 554 CIMATEX

CMDT has been the major organization promoting the use of animal traction in southern Mali. In cooperation with other organizations, it has provided a comprehensive range of services to the farmers including credit, the provision of equipment, animals and animal health requisites, extension and training services and support to village blacksmiths. It has carried out research on cotton/maize rotations using animal traction and on anti-erosion measures. CMDT has been responsible for implementing a World Bank-sponsored development project involving animal traction promotion. With Dutch finance and technical support from the Dutch firm "Rumpstad" it is starting to fabricate animal traction implements in small workshops.

**Projet ARPON (Amélioration de la riziculture
paysanne à l'Office du Niger), B.P. 1, Niono, Mali.**

Project ARPON, supported by Dutch technical cooperation, is promoting the use of animal traction for irrigated rice production. It has a workshop to fabricate plows and harrows and has been cooperating with the Dutch firm "Rumpstad".

**Division de Recherches sur les Systèmes de
Production Rurale (DRSPR), Institut d'Economie
Rurale (IER), B.P. 9030, Bamako, Mali**

**DRSPR Volet Fonsébougou,
B.P. 186, Sikasso, Mali**

DRSPR is its farming systems research section of IER, part of the Ministry of Agriculture. The Volet Fonsébougou based in Sikasso is carrying out research relating to animal traction including harnessing systems, cultivation techniques and implements. It is working closely with the CMDT blacksmith programme.

**Opération Haute Vallée (OHV),
B.P. 178, Bamako, Mali**

OHV, supported by USAID, has been promoting animal traction in the area surrounding Bamako. A blacksmith training programme has been developed for the fabrication of equipment and spare parts. A larger workshop for making animal traction implements has been established in conjunction with a private firm. Jigs and components

have been supplied by Rumpstad of The Netherlands.

Société Malienne d'Etude et de Construction de Matériel Agricole (SMECMA),
B.P. 1707, Bamako, Mali

Large-scale manufacturer that has supplied most of the animal traction equipment used in Mali. It has fabricated thousands of implements and its main range includes the simple TM plow, the Ciwara toolbar (a multiculteur similar to the Houe Sine), seeders, harrows and donkey carts. In the period 1985-1988 SMECMA was severely constrained by lack of capital, and was unable to meet the national demand for animal traction equipment.

Mexico

Centro Internacional de Mejoramiento de Maíz y Trigo (CIMMYT), A.P. 6-641, Londres 40, 06600 Mexico, D.F., Mexico Telex: 383-1772023 CIMTME

CIMMYT is the international maize and wheat improvement centre, with headquarters in Mexico. Its economics programme for eastern and southern Africa encouraged farming systems research on the constraints to draft animal power for maize production and it convened a workshop on this subject in Swaziland in 1983.

Morocco

Institut National de la Recherche Agronomique (INRA), B.P. 290, Settat, Morocco Telex: 28921 M

INRA, a national research institute, is involved in animal traction research through its INRA-MIAC arid lands project (Projet Aridoculture), supported by USAID. Equipment evaluated has included wheeled toolcarriers. Studies of animal power in agriculture have included assessments of the working characteristics of donkeys, camels, mules and oxen in various combinations. Measurement of power output has been carried out in cooperation with AFRC-Engineering, UK.

Institut Agronomique et Vétérinaire Hassan II, B.P. 6202, Rabat Institutes, Rabat, Morocco
Telex: 31873 AGROVET or 32089 M

The Département de Machinisme Agricole has operated in a wide range of animal traction projects. Research studies have included the mechanics of traditional ard plows, the use of animal power for pressing olives, the potential for animal traction in irrigated agriculture and the measurement of the work output of donkeys. One project financed by FAO, involved sending Moroccan arti-

sans to Mauritania to train local people to use animal power for water raising and crop production.

Agricola, 34 rue Beni Amar, Casablanca, Morocco
Manufacturer of plows, harrows and ridgers.

Mozambique

Agro-Alfa (Fabrica de Alfaias Agricolas), C.P. 1318, Maputo, Mozambique

Telex: 6405 AGRAL MO

Agricultural implement factory revitalized with supported from SIDA (Sweden). Technical support has been contracted to the Swedish implement manufacturer Överum. The range of equipment includes mouldboard plows, zig-zag harrows and kits comprising an axle and two large steel wheels for carts. The factory has surplus capacity and has met some export orders.

The Netherlands

Deventer College, Brinkgeversweg 69, P.O. Box 7, 7400 AA, Deventer, The Netherlands

The Department of International Agricultural Education of Deventer College organizes several courses relating to tropical agriculture including one course specifically relating to draft animal power and harnessing techniques.

Koninklijk Instituut voor Tropen (KIT), (Royal Tropical Institute, Institut Royal des Régions Tropicales), Mauritskade 63, 1092 Amsterdam, The Netherlands

Telex: 15080 KIT NL

Institute supporting a programme of animal traction research in Mali.

Rumpstad B.V., P.O. Box 1, 3243 ZG Stad aan't Haringvliet, The Netherlands

Rumpstad is a commercial manufacturer of agricultural equipment in The Netherlands. It has been working with several organizations in Africa to develop appropriate equipment designs that can be locally manufactured by blacksmiths or small workshops. It is prepared to send samples of its equipment free-of-charge to organizations willing to provide technical feedback.

Technical Centre for Agricultural and Rural Cooperation (CTA), De Rietkampen, Galvanistraat 9, Ede, Postbus 380, 6700 AJ Wageningen, The Netherlands

CTA financed by the EEC and based in The Netherlands is involved in gathering and disseminating information relating to rural development in tropical Africa and elsewhere. Animal traction is an area of interest of CTA and it is publishing ani-

mal traction books in cooperation with CIRAD, France and CTVM, UK.

Niger

Projet Recherche, Formation et Production pour l'Utilisation de Matériel Agricole en Zone Sahélienne ("Projet FAO"), B.P. 171, Tahoua, Niger
Telex: 5389 FOODAGRI NI

The project, supported by FAO, is testing and evaluating animal traction equipment and tillage practices for the cultivation of millet, sorghum and cowpeas. It is undertaking applied research and surveys relating to animal power utilization. Training activities include work with village blacksmiths and extension agents. It works closely with ACREMA both in the manufacture of prototypes and in the development of production runs of animal traction equipment. Publications include training manuals and training film-strips relating to animal traction.

Projet Productivité du Département de Niamey, B.P. 10231, Niamey, Niger

PP Niamey has a "Cellule de l'Artisanat Rural et Machinisme Agricole" (ARMA), which is undertaking animal traction equipment development work including prototype design and modification. Areas of interest include development of lighter weight plows than the predominant Arara toolbar and improved cart designs.

ICRISAT Centre Sahélien (ISC), International Crops Research Institute for the Semi-Arid Tropics (ICRISAT), B.P. 12404, Niamey, Niger

Telex: 5406 ICRISAT NI

The ICRISAT Sahelian Centre makes routine use of animal-drawn Nikart wheeled toolcarriers on its extensive research farm. On-station cropping systems trials have involved comparisons of different types of animal-drawn implements including plows, ridgers, Arara toolbars, seeders and wheeled toolcarriers. Off-station work in cooperation with ILCA has included nutritional studies relating to the feeding of draft animals. A four-year, multidisciplinary research programme on draft animal power has been initiated in cooperation with the University of Hohenheim, FRG. This will involve measuring the draft characteristics of local oxen, donkeys, horses and camels, the testing and evaluation of cultivation equipment and an animal-powered mill.

Atelier Coopératif Régional de Fabrication de Matériel Agricole (ACREMA)

Union Nigérienne de Crédit et de Coopération (UNCC), Niamey, Niger

Unité Construction Matériel Agricole, B.P. 296, Niamey, Niger

Workshops making animal traction equipment.

Nigeria

John Holt Agricultural Engineers Ltd., New Industrial Estate, P.O. Box 352, Zaria, Kaduna State, Nigeria
Telex: 75253

Manufacturer of animal traction equipment including mouldboard plows. It is particularly noted for its Holtag Emcot ridger widely used in northern Nigeria and which has been exported to other countries in the region. It also manufactures animal drawn weeding implements for ridges.

International Institute of Tropical Agriculture (IITA), P.M.B. 5320, Ibadan, Nigeria

Although not closely involved in animal traction IITA has been working with SAFGRAD in Burkina Faso on animal-drawn tied-ridging implements.

Peru

Proyecto de Herramientas e Implementos Agrícolas Andinos (Herrandina), Casilla 42, Cusco, Peru

Project that has evaluated traditional animal-drawn tillage implements and has developed a modified multipurpose ard plow.

Philippines

International Rice Research Institute (IRRI), P.O. Box 933, Manila, Philippines

Telex: 40890 RICE PM; 45365 RICE INST PM;

IRRI has an international mandate relating to rice production in the tropics. In 1986 the Agricultural Engineering Department developed the "Conopuddler" designed for use with a single buffalo. The Rice Farming Systems Program has organized a network of farming systems research organizations in 13 countries in southeast Asia and many of its members are actively working on aspects of animal traction.

Regional Network for Agricultural Machinery (RNAM), University of the Philippines, Los Baños, College, Laguna, Philippines

Telex: 3432 PTTLB PU

RNAM, whose sponsors include FAO and UNIDEP links agricultural engineering institutions in several Asian countries through information dissemination, meetings and exchanges. Details of forthcoming events, research activities and new implement designs, together with more general ar-

ticles are provided in the RNAM Newsletter, distributed free-of-charge three times a year.

Senegal

Institut Sénégalais de Recherches Agricoles (ISRA), B.P. 3120, Dakar, Senegal

Telex: 61117 ISRA SG

ISRA is a large research organization within the ministry of rural development. Its Bambey Centre was the base for many animal traction studies in the 1950s and 1960s. More recently the farming systems department of ISRA (Département Systèmes) has carried out research on animal traction in several parts of the country. Areas of research have included socio-economic aspects of animal power, tine tillage, draft cows, the use of animal traction for rice production, equipment distribution and maintenance and the role of blacksmiths in animal traction. Many detailed research reports have been produced. ISRA hosted an international workshop on animal traction in 1988.

SISMAR (Société Industrielle Sahélienne de Mécaniques, de Matériels Agricoles et de Représentations), B.P. 3214, Dakar, Senegal

SISMAR is one of the largest manufacturers of animal traction equipment in Africa. SISMAR was formed after the financial problems of the previous manufacturing company "SISCOMA", by which name much of its equipment is still known. Due to limited local demand it is still running well below its large capacity. It is most famous for the Nolle-designed multipurpose Houe Sine toolbar and the Super Eco seeder which have been widely sold both within Senegal and in neighbouring countries.

ENDA (Environment and Development in the Third World), B.P. 3370, Dakar, Senegal

ENDA is an internationally-financed non-governmental organization with its headquarters in Dakar. It publishes the journal African Environment in French and English. It has been cooperating with GATE (Germany), GRDR and IT Dello (France) and local blacksmiths in the development of animal powered systems for raising water and grinding food. It has published several pamphlets on these subjects.

Sierra Leone

Sierra Leone Work Oxen Programme,
Private Mail Bag 766, Freetown, Sierra Leone

Telex: 3418 PEMSU SL

The Work Oxen Programme is responsible for a workshop at Rolako which makes Pecotool tool-

bars, harrows and carts. The Programme is involved in research-development activities and is particularly interested in rice cultivation using draft animals, the social implications of animal traction adoption, work-disease interactions and the potential for making greater use of traditional animal husbandry techniques.

South Africa

FEDMECH, P.O. Box 677,

Vereeniging 1930, South Africa

Telex: 743058

Historically Southern African Farming Implements Manufacturers (SAFIM) was the major manufacturer of animal traction equipment in the region. The SAFIM designs of large plows, cultivators and seeders that have changed little in thirty years, are now manufactured by FEDMECH, although the implements are still commonly referred to by the well known SAFIM trade name. In addition to meeting the demand of the domestic market in South Africa, it exports to several neighbouring states.

Sudan

Western Savannah Development Corporation (WSDC), P.O. Box 190, Nyala, South Darfur, Sudan
(Khartoum Office: P.O. Box 9025 (KTI), Sudan)

Telex: 22523 WSDC SD

WSDC is a broadly based rural development project. The animal traction component of WSDC is promoting the use of donkeys and, to a lesser extent, oxen. Equipment evaluated and locally manufactured from scrap materials includes single mouldboard ox plows and donkey-drawn seeder/weeders. Research interests have included donkey-harnessing and water-raising systems.

Jebel Marra Rural Development Project (JMRDP),
P.O. Box 9010, Khartoum, Sudan

Large development project, supported by EEC, in the remote west of Sudan. In the project area donkeys are used for transport and packing, horses are used for riding and some cart pulling, and some camels are used for plowing. JMRDP has been promoting camel plows made by local artisans. It is now emphasizing the use of donkeys, as these are much cheaper, and it has been developing a lightweight donkey plow and weeder.

Nuba Mountains Rural Development Programme,
P.O. Box 143, Khartoum, Sudan

Large development project, supported by SATEC, with an animal traction component. Research relating to animal traction has included a study of the economics of ox carts.

Swaziland

**Usutu Pulp Company Limited, Private Bag,
P.O. Mbabane, Swaziland** Telex: 2003 WD

Forestry company with 25% of logging operations based on extraction by mules. 220 mules are maintained and work 200 days/year and extract 160 logs (20 tonnes) per mule per working day.

ISICO, P.O. Box 417, Mbabane, Swaziland
Telex: 2213 WD

Distributor of Agrilis animal-drawn equipment of SAFIM type, including plows, harrows, cultivators and seeders.

Sweden

AB Överum Bruk, S-590 96 Överum, Sweden
Telex: 3957 OVERUM S

A company manufacturing large-scale agricultural implements that has also been involved in rehabilitating facilities for local production of animal traction equipment in Mozambique and Angola. Following the formation of the Överum-Ebra company in France it is now associated with the Ebra range of animal-drawn seeders and other implements.

Switzerland

**International Labour Organisation (ILO), CH-1211
Geneva 22, Switzerland** Telex: 22271 BRT CH

ILO (the French acronym is BIT) is a UN agency with particular interest in developing activities and technologies which generate employment and improve working conditions. Animal traction, blacksmithing, village carpentry and animal-drawn transport fall within this mandate. The Technology and Employment Branch of ILO sponsored several national workshops relating to animal traction in eastern and southern Africa, and published the proceedings.

**Bellerive Foundation, P.O. Box 6, 1211 Geneva 3,
Switzerland** Telex: 429835 MURO CH

The Bellerive Foundation works on environmental issues, and has been involved in the development and local production of three-pad harnessing systems for Africa, based on Swiss designs.

**Swisscontact, Fondation suisse de coopération au
développement technique, Dölttschiweg 39,
CH-8055 Zurich, Switzerland** Telex: 814308

**Swiss Development Cooperation (DCA),
Département fédéral des affaires étrangères,
CH-3003, Bern, Switzerland** Telex: 911340 EDA CH

Swisscontact, supported by Swiss Development Cooperation (part of the Swiss foreign affairs min-

istry), is working with groups in Latin America to develop animal traction technologies. Among other activities, it has provided technical personnel to assist the Proyecto Herrandina in Peru.

Tanzania

**Ubango Farm Implements (UFI), P.O. Box 20126,
Dar es Salaam, Tanzania** Telex: 41206

The parastatal UFI factory is the largest manufacturer of agricultural implements in the country, with a capacity to manufacture 60 000 plows a year. When demand has exceeded production, UFI has imported plows.

**Zana Za Kilimo, P.O. Box 1186,
Mbeya, Tanzania** Telex: 51133

A parastatal factory in the southwest of the country manufacturing a range of animal traction equipment. Cooperating with the Mbeya Oxenization Project.

**Theml Farm Implement and Engineering
Company, P.O. Box 286, Arusha, Tanzania**

Small workshop producing some plows and carts.

**Centre for Agricultural Mechanization and Rural
Technology (CAMERTEC),
P.O. Box 764, Arusha, Tanzania.** Telex: 42126

Established in 1981 through the merger of TAMTU (Tanzania Agricultural Machinery Testing Unit) and the Arusha Appropriate Technology Project, CAMERTEC is charged (among other activities) with developing and testing animal traction implements and promoting national liaison in this field. It has workshops for producing prototypes and small production runs. Some of its initial designs included heavy double-mouldboard plows and harrows, and also ox carts.

**Tanga Integrated Rural Development Programme
(TIRDEP), Kilimo Tanga,
P.O. Box 5347, Tanga, Tanzania**

TIRDEP is a development project (with GTZ support) in the northeast of the country that has been trying to introduce animal traction into an area where previous schemes had been disappointing. In addition to extension and training, its activities have included equipment development and the design of a prototype rolling weeder/brush cutter. The high demand for carts has been partially met by importing old car axles from Germany.

**Mbeya Oxenization Project,
P.O. Box 723, Mbeya, Tanzania**

Development project, supported by CIDA, working with existing organizations to improve and increase the use of animal traction in the Mbeya re-

gion of the southwest. Specific objectives include work on inter-row cultivators and ox carts. The project is cooperating closely with the ZZK factory in the development and production of animal-drawn implements.

Togo

Projet pour la Promotion de la Traction Animale (PROPTA), B.P. 82, Atakpamé, Togo

PROPTA is a national ministry of rural development project assisted by USAID and EEC and is responsible for ensuring adequate liaison between the 20 different donor-assisted projects and financial institutions involved with animal traction in Togo. PROPTA promotes information exchange through the quarterly newsletter *Force Animale* and the circulation of documents. It has established standards for credit terms and has coordinated the supply of equipment and spares from the UPROMA factory.

Unité de Production de Matériel Agricole (UPROMA), B.P. 111, Kara, Togo

Workshop established with UNIDO/UNDP assistance that manufactures a range of animal traction implements notably simple mouldboard plows, triangular toolbars and ox-carts.

United Kingdom

Overseas Division, AFRC-Engineering, Wrest Park, Silsoe, Bedford MK45 4HS, UK

Telex: 825808 G

The Overseas Division of AFRC-Engineering (formerly NIAE) has been involved in animal traction implement development for many years. Recently it has been developing techniques and instrumentation for measuring and logging many of the mechanical and physiological parameters associated with animal draft. Field trials with draft animals are being undertaken in cooperation with national and international institutions in Africa and Asia. It is hoped to use the information obtained from the data loggers to develop a scoring system to facilitate the comparison of different animals and implements.

Centre for Tropical Veterinary Medicine (CTVM), Easter Bush, Roslin, Midlothian EH25 9RG, Scotland, UK

Telex: 727442 UNIVED G

The CTVM of the University of Edinburgh is carrying out research on the nutritional and physiological implications of draft work, using cattle, buffalo, horses and donkeys. Several interactions are being studied including nutrition-work, work-milk production and work-disease, and it is hoped

to establish criteria for selecting draft animals. CTVM has developed equipment and techniques to establish work output under both controlled and field conditions. CTVM publishes "Draught Animal News" twice a year. It runs courses on animal traction, in cooperation with Deventer College in The Netherlands.

Intermediate Technology Development Group (ITDG), Myson House, Railway Terrace, Rugby CV21 3HT, UK

Telex: 317466 ITDG G

IT Publications, 103-105 Southampton Row, London WC1B 4HH, UK

IT Transport, Old Power Station, Ardington, Oxon, OX12 8PH, UK

ITDG is a non-governmental appropriate technology organization that has been associated with the development of animal traction technologies in several countries. Its publications arm, ITP, has produced several books relating to animal traction and it publishes the quarterly journal *Appropriate Technology*. IT-Transport is the section of ITDG that concentrates on transport, including animal-drawn vehicles.

Development Technology Unit, University of Warwick, Coventry CV4 7AL, UK

Telex: 311904 UNIVWK

The Development Technology Unit of the University of Warwick (in collaboration with partner organizations in Africa and Asia) is carrying out research and development work on the use of animal power to drive stationary machinery for water-lifting and crop processing.

Commonwealth Secretariat, Marlborough House, Pall Mall, London SW1Y 5HX, UK

The Food Production and Rural Development Division of the Commonwealth Secretariat has supported the development of regional appropriate technology networks in Africa. It has published the proceedings of sub-regional meetings which have included aspects of animal traction.

Geest Overseas Mechanisation Ltd, White House Chambers, Spalding, Lincs PE11 2AL, UK

Telex: 32494 GSTGOM G

Manufacturer of agricultural equipment including wheeled toolcarriers.

Farmkart Ltd., St Andrews Industrial Estate, Bridport, Dorset, DT6 3DB, UK

Telex: 417232 PARAK G

Farmkart is a company specializing in animal-drawn carts. It sells complete kits and can collaborate in local production initiatives.

**Project Equipment Ltd, Industrial Estate,
Oswestry, Shropshire SY10 8HA, UK**

Telex: 35367 PROJEQ G

Project Equipment is a small firm that designs and manufactures animal traction equipment. It has assisted small workshops in Africa to establish the local fabrication of plows and toolbars. It runs basic, practical training courses in the design and production of animal-drawn implements.

**Shuttleworth Agricultural College, Old Warden
Park, Biggleswade, Beds SG18 9DX, UK**

Agricultural College that has held short-duration highly practical courses on animal traction and animal-drawn implements.

United States of America

**AT International, 1331 H Street NW,
Washington DC 20005, USA**

AT International is a non-profit trust working with appropriate technology organizations in several countries. Involvement with animal traction includes cooperation with RIIC, Botswana, and ENDA, Senegal, in the development of animal-powered water pumps and mills.

**Agency for International Development (USAID),
Washington DC 20523, USA**

USAID is the official US bilateral aid agency that funds numerous projects in developing countries, including many with draft animal components.

**TILLERS International, 1402 Hillcrest Avenue,
Kalamazoo, Michigan 49008, USA**

Tillers International, a non-profit corporation, works with both old and new animal-powered technologies on a small farm where horses and oxen are employed and prototypes constructed. Small numbers of interns are trained in animal traction techniques. Tillers publishes an illustrated, quarterly newsletter *The Tillers Report* which aims to stimulate discussion and debate on a wide range of issues relevant to animal traction utilization in developed and developing countries.

**Volunteers in Technical Assistance (VITA),
1815 N. Lynn Street, Suite 200,
Arlington, Virginia 22209-2079, USA**

VITA is a non-profit organization specializing in disseminating information on appropriate technologies, including animal traction. It has a comprehensive documentation centre, with a large range of documents relating to draft animals and animal-drawn implements. It publishes a quarterly newsletter *VITA News*.

Zaire

**Secrétariat des Organisations Non-Gouverne-
mentales pour la Traction Bovine (SOTRABO),
c/o Projet Rural, B.P. 1144, Mbuji-Mayi, ZAIRE**

SOTRABO was established to coordinate the animal traction programmes of several NGOs in Zaire. Projet Rural has worked closely with village blacksmiths and carpenters to encourage the village-level production and maintenance of equipment, including wooden-beam plows and wooden ox carts.

Zambia

**Animal Draft Power Programme,
Agricultural Engineering Section,
Ministry of Agriculture and Water Development,
P.O. Box 50291, Lusaka, Zambia**

Telex: 44370 AGRIMI ZA

The national animal draft power programme, with support from Dutch technical cooperation, is coordinating various activities relating to animal traction including training and research-development studies. Work has been undertaken on harnessing systems and the local production of suitable implements.

**Animal Draft Power Research and Development
Project, Agricultural Machinery Research and
Development Unit,
Magoye Regional Research Station,
P.O. Box 11, Magoye, Southern Province, Zambia**

Magoye Station of the Ministry of Agriculture has long been associated with animal traction. AD-PRDP, with Dutch support, is developing standardized testing procedures for equipment evaluation as well as studies on tillage techniques using animal power.

**Northland Engineering, P.O. Box 71640,
Ndola, Zambia** Telex: 33310 NORTHLAND ZA

**Lusaka Engineering Company (LENCO),
P.O. Box 33455, Lusaka, Zambia** Telex: 41720 ZA

SKF, P.O. Box 20133, Kitwe, Zambia

Telex: 51230 ZA

**MDM Engineering Contractors,
P.O. Box 21977, Kitwe, Zambia**

**Turning and Metal,
P.O. Box 31608, Lusaka, Zambia**

Manufacturers of animal drawn equipment. Northland has been the main producer of ox-plows, ridgers and cultivators, and also makes some carts. LENCO makes both ox-carts and plows. Turning and Metal make ox-carts; MDM

manufacture tines and spare parts; SKF makes stub axles for carts with roller bearings.

Zimbabwe

Institute of Agricultural Engineering,

P.O. Box BW 330, Borrowdale, Harare, Zimbabwe

Telex: 2455 AGRIC ZW

The Institute of Agricultural Engineering of the Ministry of Agriculture undertakes research, testing, development, training and extension in the field of agricultural engineering. The activities of its Research Centre are primarily aimed at the small-scale farming sector and include conservation tillage methods to reduce both soil erosion and the draft power requirements. Work also covers the development of animal-drawn implements, animal-powered water pumps and the standardization of testing procedures. The Agricultural Engineering Training Centre (AETC)

provides extension staff, farmers and teachers with training in animal power and the use and maintenance of implements and has produced some illustrated training manuals. Basic blacksmithing courses are designed to upgrade skills in the repair and manufacture of animal-drawn implements.

Bulawayo Steel Products, P.O. Box 1603,

Bulawayo, Zimbabwe

Telex: 3257 ZW

Zimplow Ltd., HIS Steelworks Road,

P.O. Box 1059, Bulawayo, Zimbabwe

Telex: 3372 PLOUGH ZW

Bain Manufacturing Company (Pvt) Ltd.,

P.O. Box 1180, Harare, Zimbabwe

Telex: 4696 ZW

Large manufacturers of animal traction equipment including plows, harrows, ridgers and cultivators.

Index

A

ACEMA, 215

ACIAR Draught Animal Power Project, 217

AETC

Acknowledgement, 11

AFRC-Engineering

Acknowledgement, 10

Address, 226

Animal-powered gear system, 149

Cooperation with CIAE, 221

Data logger development, 69

Data-logging techniques, 176

Full name (derivation of acronym), 211

Morocco, cooperation with, 223

Wheeled toolcarrier development, 133

See also **NIAE**

Agricultural Engineering

Asian network, 224

Botswana, 217

Cameroon, 218

Ethiopia, 219

India, 221

IRRI, 224

Kenya, 221

Zambia, 228

Zimbabwe, 229

Angola

Multiple teams, use of, 40

Reversible plows, 92

Steel cart wheels, 122

Animal draft

Principles, 24

In relation to bodyweight, 173

Animal power; tractive power

Principles, 24

Animal-powered gears, 148-149, 151, 153

See also **Mills, animal powered**,

Sugarcane crusher, Water lifting

Animal welfare, 153

Appropriate technology

Kenya, 221

Peru, 224

Role of Commonwealth Secretariat, 227

Senegal, 225

Tanzania, 226

UK, 227

USA, 228

VITA, 228

Arara, 81

Arara toolbar, 104, 192

Illustration, 110

Ariasa toolframe, 89, 108, 104

Illustration, 109

Artisanal manufacture, 190-191, 193, 195

Artisanal training

See also **Blacksmith support**

and **Blacksmith training**

Cooperation Morocco-Mauritania, 223

Water-raising systems, 146

Asia

Buffalo yokes, 35

Information sources, 116

Multiple teams, 40

Water-raising equipment, 144

Withers yokes, 32

Assumptions relating to implement design, 75

AT International, 228

B

Bangladesh

Collar-type yokes, 57

Trials with ergometer, 176

BDPA, 220

Bearings

Advantages and disadvantages, 126

Bronze, 125

See also **Carts**

Cast iron, 124

Friction effects, 18

Lubrication, 125

Oil soaked, 125

PVC, 125

Roller, 125

Steel bush, 124

- See also **Wheels for carts**
Wood blocks, 125
- Bellerive Foundation**, 226
- Benin**
COBEMAG, 192, 217
- Bibliographies**, 77
- Black soils**
 See **Vertisols**
- Blacksmith support**
CMDT Scheme, Mali, 193
Information sources, 196
Mali, 195, 222
Sudan, 225
Zaire, 228
- Blacksmith training**
Botswana, 196
Information sources, 196
Mali, 222
Manufacture of tools, 196
Niger, 196, 224
Requirements for, 195
- Blacksmiths**
Importance of, 191
 See also **Village blacksmiths**
- Blade harrow**, 95, 158
- Bolivia**
Yokes, research on, 29
Yoke sizes, 35
- Bos indicus***, 27
 See also **Zebu cattle**
- Botswana**
Manufacture of harnesses, 45
ATIP, 218
Blacksmith training, 196
Data logging trials, 70
Donkey harnesses, 64
Multiple teams, use of, 40
Plow planters, 102
Plow sizes, 90
RIIC, 218
Road construction, 156
Tyre collars, 55
Water-raising systems, 148
- Brakes on carts**, 128
- Brazil**
Cooperation with TUB, 220
Policultor 300 toolbar, 107
Ridge-tiers, 139
Weeder roller testing, 140
- Breaking plow**, 81
- Breeching strap**, 34, 46, 128
- Bridles**, 52
- British organizations**, 227-228
- Broad-bed and furrow system**, 142
- Buffaloes**
Carting in Nepal, 164
China, 35
Collar harnesses, 58
Draft force, 173
Harnessing, 35
Pack uses, 61
Puddling implement, 224
Temperature regulation and work, 163
Water-raising, 148
Work measurement, Edinburgh, 59
- Bund formers**, 141
- Burkina Faso**
CNEA, 218
Data logging trials, 70
Implement factory, Government-supported, 177
Tied ridges, 139
Training manuals, 115
Triangie toolbar, 108
- Burundi**
Three-pad collar harnesses, 60
- Butteuses**, 94
- C**
- Camels**
Advantages, 48
Disadvantages, 48
Draft force, 173
Harnesses for, 48
Mixed teams, 60
Pack animals, 117
Transport uses, 50
- Camels, Plowing**
Ethiopia, 49
Mali, 49
Niger, 49
Nigeria, 49
Sudan, 49, 224
- Cameroon**
PAFSAT, 218
TROPIC, 218
Weeder rollers, 139
- CAMERTEC**, 224
Double furrow plows, 91
- Carriage plow**, 89
- Carts**
Axles, 124-125
Bearings, 124-125
Bearings, advantages and disadvantages, 126
Braking systems, 128
Bush bearings, 124-125

- Car tyres, 123
- Distribution, 129
- Effect of rotational friction, 18
- Four-wheel, 129
- Information sources, 130
- Kenya, 221
- Loads, 128
- Made from old vehicles, 124
- Malawi, 222
- Manufacture, 129
- Mozambique, 223
- Niger, 223
- Numbers in use, 119
- Pneumatic tyres, 122
- Puncture problems, 126
- Road construction, 156
- Role of IT-Transport, 227
- Roller bearings, 125
- Sawdust-filled tyres, 126
- Sisal-spoked wheels, 121
- Split rim wheels, 127
- Steel-spoked wheels, 122
- Sudan, 225
- Tanzania, 226
- Togo, 227
- Two-wheeled carts, 119
- Utilization patterns, 120
- Wheel size, 122-123
- Wood block bearings, 125
- Wooden bearings, 125
- Wooden wheels without spokes, 121
- Wooden-spoked wheels, 120
- Work output trials, 164
- Yokes for, 35
- Zaire, 228
- Cassava grater (animal powered), 150**
- Cattle**
 - Cart pulling, 120
 - Pack animals, 118
- CEEMAT**
 - Acknowledgement, 10
 - Address, 221
 - Data-logging techniques, 69, 176
 - Research on single tine implement, 85
- CFDT, 220**
- Chad**
 - Riding cattle, 62
- Changes resulting from animal traction, 75**
- China**
 - Buffalo yokes, 35
 - Root-harvesting implements, 134
 - Single yokes, 35
- CIAE**
 - Address, 221
 - Data-logging techniques, 69, 176
- CIMMYT, 223**
- CIRAD, 219**
- CMDT-Blacksmith scheme, 193**
- CNEA, 220**
- COBEMAG, 177**
 - Address and details, 217
 - System of production, 192
- Collar-type yokes, 57**
- Commonwealth Secretariat, 227**
- Constraints**
 - Roots and stumps, 74
- Corruption, effect of, 179**
- Costa Rica**
 - Work output measurements, 168
- Côte d'Ivoire**
 - Yam harvesting trials, 134
- Cotton companies**
 - Mali, 222
- Cotton soils**
 - See Vertisols
- Coulter**
 - Function, 26
- Coulter of plow, 88**
- Credit schemes**
 - Mali, 220
 - Togo, 226
- CTA, 221**
- CTVM, 227**
 - Acknowledgement, 10
 - Data-logging techniques, 176
 - Ergometer development, 69
 - Research on harnessing systems, 59
- Cultivation tines, 102**
- Cultivators, 102**
 - Houe Manga, 104
 - Tine options, 103
 - Triangle, 104

D

- Data logging techniques, 69**
- Delou, 147**
- Design**
 - See Implement design
- Deventer College, 223**
- Disease constraints**
 - Research, 227
- DLG, 221**

Donkey Carts

- Kenya, 221
- Mali, 220

Donkeys

- Cart pulling, 120, 128
- Draft force, 173
- Harnessed with camels, 60
- Harnessing systems for, 45-46
- Pack animals, 117
- Pack uses, 48
- Plowing, 221, 225
- Powering mills, 151
- Scoop pulling, 141
- Transport uses, 130
- Water-raising, 147-148
- Weeding implements, 107
- Work output assessment, 224
- Yokes for, 42

Donkeys, Plowing

- Sudan, 225

Donkeys, Work Output

- Morocco, 221

Donor influences

- On equipment production, 178

Double-furrow plows, 91**Dutch organizations, 223****Dynamometer, 157****E****Eastern Africa**

- Lack of toolbar uptake, 110
- Pack donkeys, 117
- Withers yokes, 32

Economic constraints

- Black market distortions, 180
- Blacksmith services, 195
- Capital limitation, 181
- Food-aid, 195
- Harvesting implements, 135
- Local tax and tax exemption, 181
- Mills and gears, 153
- Seasonal variations in demand, 181
- Water-raising systems, 146, 148
- Wheeled toolcarriers, 133

Economic studies

- ICRISAT, 221
- Senegal, 224
- Sudan, 225
- Wheeled toolcarriers, 133

Efficiency

- Field, 168

Egypt

- Cart wheel manufacture, 120
- Illustration of ard plow, 82
- Mixed teams, 61
- Use of ard plows, 84
- Water-raising systems, 144

ENDA, 225

- Water-raising systems, 147

Energy availability for work, 171**Equipment manufacturers**

- Agricola, Morocco, 223
- Agrimal, Malawi, 222
- Agro-Aifa, Mozambique, 223
- Benin, 217
- Botswana, 218
- Brazil, 218
- Burkina Faso, 218
- Cameroon, 218
- CAMERTEC, 104
- Carts, Malawi, 222
- CMDT, Mali, 222
- CNEA, 177
- COBEMAG, Benin, 177, 192, 217
- Ethiopia, 221
- France, 220
- Ghana, 221
- Guinea, 221
- Holt, Nigeria, 224
- India, 221
- Information sources, 116
- Kenya, 222
- Lesotho, 221
- Madagascar, 222
- Niger, 224
- Northland Engineering, 104, 228
- Överum, Sweden, 226
- Production problems, 178
- Project Equipment, 228
- Project ARPON, Mali, 222
- Rumptstad, 222-223
- SAFIM, 225
- Sierra Leone, 225
- SISMAR, 177, 224
- SMECMA, Mali, 223
- Sources of information, 196
- Surplus capacity, 178
- Tanzania, 226
- UFI, Tanzania, 177, 226
- UK, 227
- UPROMA, 97, 104, 177, 227
- Zambia, 228
- Zimbabwe, 229

Ergometer, 59, 69, 176

Erosion control measures

- Broad-bed maker, 143
- Bund formers, 142
- Cameroon, 218
- Mali, 222
- Scoops, 140
- Zimbabwe, 228

Ethiopia

- Artisanal manufacture, 185
- Broad-bed and furrow system, 142
- Camel harness, 49
- Camel plowing, 49
- Horse yokes, 42
- IAR, 221
- Making of yokes, 63
- Maresha ard construction, 83
- On-farm work assessment, 169
- Pack donkeys, 117
- Scoops, 141
- Single oxen, 38
- Withers yokes, 33
- Work patterns, 169

Europe

- Animal-powered gear systems, 145
- Collars for cattle, 53
- Forestry uses for horses, 155
- Harnessing for equines, 43-44
- Head yokes, 30
- Horse collars, 45
- Mouldboard plow designs, 87
- Mowers and reapers, 134
- Role of blacksmiths, 191
- Use of forehead yokes, 29
- Withers yokes, 32

European Community, 217

Eveners,

- Illustrations, 35, 39
- Principles of use, 24, 39

F

FAO

- Acknowledgement, 11
- Address, 221

Farmer assessment

- Work output, 172

Farming Systems Research

- Burkina Faso, 218
- Cameroon, 218
- CIMMYT involvement, 223
- Equipment development, 73
- Farmer assessments, 175
- Implement evaluation, 80

Mali, 220

- Methodology, 80
- Rapid rural appraisal, 176
- Rice farming, 224
- Senegal, 225
- Work rate interpretation, 170

Feeding Systems, Research studies

- Niger, 224

Fertilizer applicators, 136-137

Field capacity, 168

Field efficiency, 168

Food-aid

- Effect on profitability, 195

Forehead yokes

- See Yokes, forehead

Forestry applications

- Extraction rates, 155
- Options, 154
- Yoking systems, 31
- Swaziland, 226

Frog of plow, 87

Furrow wheel functions, 89

G

The Gambia

- Adoption of donkeys, 76
- GARD Project, 220
- Ridge cultivation, 93
- Tied ridges, 138
- Training manual, 99, 115

GATE

- Acknowledgement, 10
- Animal-powered gear project, 150
- Journal, 220

Gear systems

- Commercially available, 149
- Development, 148-149, 151, 153
- GATE involvement, 220
- Information sources, 154
- Internal friction, 18
- Longstanding designs, 149
- Multipurpose, 150
- University of Warwick, 227

Gears, animal powered

- See also Mills, animal powered
- Senegal, 225
- See also Sugar cane crusher
- See also Water lifting

German organizations, 220

Ghana

- Implement factory 177, 221

Tamale workshop, 220
 Weeder roller testing, 140
Giessen University, 220
GRDR, 219
 Cooperation with Senegal, 225
GRET, 219
Groundnut lifters, 111
GTZ
 Acknowledgement, 10
 Address, 220
 Weeder roller development, 140
Guérault, 147
Guinea
 Implement factory, 177, 221

H

Halter, 51
Hames, 46
Harnessing
 Attelage, definition, 27
 Bellerive Foundation, 224
 Breastband, 45
 Breeching strap, 28, 34, 46, 48, 128
 Bridles, 52
 Camel, 48
 Choice for transport work, 128
 Clarification of definitions, 27
 Coexistence of yokes and collars, 53
 Collar-type yokes, 57
 Collars, 45
 Collars for cattle, 53
 Comparative efficiency, 69
 Definitions of yoke types, 29
 Deventer College, 223
 Effect on power, 24
 Eveners, 39
 Fashions, 71
 Flexible, 57
 Girth straps, 48
 Halter, 51
 Hames, 46
 Harnais, definition, 27
 Importance of comfort, 69
 In tandem, 39
 Injuries, 66
 Joug, definition, 27
 Large teams, 39
 Manufacture, 45, 48
 Mixed teams, 60
 Multiple, 39
 Options for cattle, 28
 Organizations undertaking research, 72

Pack saddles, 48
 Padding for, 32
 Prejudices, 71
 Rein systems, 50
 Research criteria, 70
 Saddle harness, 61
 Saddles, 45
 Saddles for oxen, 61
 Selection of, 71
 Suggested reading, 72
 Suitable materials, 64
 Swingle tree, 36
 Traces, 36
 Transmission system definition, 27
 Tyre collars, 46
Harnessing collars for cattle
 Kenya, 222
Harnessing, breastband
 Description, 45
 Materials for manufacture, 45
Harnessing, collars
 Advantages, 56
 Advantages for oxen, 58
 Berne ox-collar, 54
 Buffaloes in Thailand, 58
 Camels, 49
 Disadvantages, general, 56
 Disadvantages for oxen, 58
 Efficiency claims, 58
 Efficiency measurements, 59
 Horses, 45
 Illustration of ox collar, 53
 Origin, 71
 Time required for construction, 64
 Tyre collars, 46, 55
 Use for cattle, 53
Harnessing, donkey
 Kenya, 222
 Sudan, 225
Harnessing, multiple
 Abreast, 39
 Advantages, 39, 41, 91
 Botswana, 40
 Disadvantages, 39, 41, 91
 Effect on draft force, 173
 Effect on work output, 165
 Efficiency of, 42
 Eveners, use of, 39
 Illustration, 40
 Implement size, 41
 In tandem, 39
 Use of double plows, 91

Harnessing, research on

Bolivia, 29

Harnessing, three-pad collars

See Three pad collar harnesses

Harrow

Blade, 95

Comb, 114

Disc, 94, 114

Functions, 94

Illustration, 94

Spanish, 114

Tine, 94

Triangular, 95, 114

Use for rice production, 114

Zigzag, 95

Harvesting equipment, 134

Heel of plow, 87

Herrandina, 224

Hohenheim University, 220

Work with ICRISAT, 224

Holland

Resource organizations, 223

Honduras

Road construction, 156

Horsepower (units), 21

Horses

Anatomical features, 43-44

Cart pulling, 120, 128

Collars for, 45

Draft force, 173

Forestry work, 155

Pack uses, 48, 117

Power output, 21

Pulling forces, 173

Sudan, 225

Transport uses, 130

Work output assessment, 224

Yokes for, 42

Houe Manga, 104

Houe Sine, 104, 107

Huller, 150

I

ICRISAT

Acknowledgement, 10

Address, 224

Broad-bed and furrow system, 142

Draft force measurements, 176

Niger, 224

Ridge-tiers, 139

Wheeled toolcarrier development, 133

IEMVT, 219

IITA, 218, 224

Ridge-tiers, 139

Rolling injection planter, 97

ILCA

Acknowledgement, 10

Address, 219

Broad-bed and furrow system, 142

Data-logging techniques, 69, 176

Modification of maresha ard, 143

Single yokes, 37

Wheeled toolcarrier testing, 142

ILO

Acknowledgement, 11

Address, 226

Imperial units and conversions, 19

Implement adoption

Case histories, 115

Implement design

Ariana, 108

Blacksmith involvement, 192

Carts and bearings, 126

Carts, information on, 130

Common assumptions, 75

Evolutionary processes, 74

Examples of inappropriate designs, 183

Experience of Jean Nolle, 116

Features of ards, 84

Groundnut lifters, 111

Indian experience, 116

Mechanical principles, 17

Methodology, 78

Mills and gear systems, 153

Multipurpose functions, 109-110

Need for farmer feedback, 186

Problem for manufacturers, 179

Project involvement, 116

Risk consideration, 76

Seeders, 99

Socio-economic criteria, 76

Source material, 116

Standardization, 110, 184

Tender specifications, 183

Weeder rollers, 139

Implement development

Ariana, 108

CEEMAT tine, 85

Crust breaker, 221

Houe Sine, 107

Kanol toolbar, 84-85

Maresha ard for single animal, 85

Multipurpose ard, 224

Peruvian long-beam toolbar, 84-85

Plow planters, Botswana, 102

- Rice puddler, 224
 - Ridge tier, 139, 218, 224
 - Role of AFRC-Engineering, 227
 - Role of ITDG, 227
 - Seeders, 96
 - Weeder rollers, 139
 - Weeders, 106
 - Wheeled toolcarriers, 131, 133
 - Implement draft**
 - Assumptions and problems, 75
 - Factors influencing, 157, 159, 161
 - Measurement, 157, 159, 161
 - Operator influences, 159
 - Principles, 24
 - Variations, 158
 - Implement selection**
 - Case histories, 115
 - Cost considerations, 14
 - Difficulties for manufacturers, 179
 - Donor influences, 183
 - Effect of cart bearings, 126
 - Farmer choices, 76
 - Harvesting implements, 135
 - Inappropriate designs, 183
 - Information sources, 116
 - Methodological steps, 78
 - Need for farmer involvement, 186
 - Review of models, 77
 - Risk of false impressions, 131
 - Role of blacksmiths, 194
 - Socio-economic criteria, 76
 - Technical excellence, 14
 - Testing procedures, 228
 - Weeders, 106
 - Work rate information, 169
 - Importation of implements, 179**
 - India**
 - Broad-bed and furrow system, 142
 - Camel harness, 49
 - Camels, use of, 48
 - Cart tyres, 123
 - CIAE, 221
 - Collar-type yokes, 57
 - Data-logging trials, 70
 - Reversible plows, 92
 - Root-harvesting implements, 134
 - Sugarcane crushers, 149
 - Use of ard plows, 84
 - Water-raising systems, 148
 - Work output measurement, 59
 - Yoking system comparisons, 59
 - Information sources**
 - Animal-powered gear systems, 149
 - Artisanal programmes, 196
 - Asian network for agricultural machinery, 224
 - Carts, 130
 - FAO, 221
 - GATE Journal, 220
 - Gear systems, 154
 - Harnessing, 72
 - Implement manufacture, 196
 - Implements, 115
 - Implements in Asia, 116
 - Maresha plow, 143-144
 - Measurement of force and work, 176
 - Mechanics of draft, 15
 - Mills, 149, 154
 - Need for cross-checking, 156
 - Relevant journals, 116
 - Ridge-tiers, 139
 - Water-raising systems, 148
 - Weeder rollers, 140
 - Injection planter, 97**
 - Interpretation of data, 174**
 - IRRI**
 - Address, 224
 - Puddler, 115
 - Irrigation systems, 144**
 - IRRT, 223**
 - ISRA, 225**
 - Water-raising systems, 147
 - IT-Dello, 220**
 - Italy**
 - Forestry operations, 155
 - ITDG, 227**
 - ITP, Acknowledgement, 11**
- ## K
- Kanoi toolbar**
 - Development, 84
 - Kenya**
 - Donkey harnesses, 48
 - Harness manufacture, 55, 65
 - Implement factories, private sector, 177
 - Multiple teams, use of, 40
 - Sawdust-filled tyres, 126
 - Scoops, 141
 - Sugarcane crushers, 149
 - KIT, 223**
- ## L
- Landside of plow**
 - Function, 26, 87
 - Latin America**
 - Bolivia, yoking systems, 29

- Forestry applications of animal power, 155
- Head yokes, 30
- Swiss support of animal traction, 226
- Use of forehead yokes, 29
- Lesotho**
 - Implement factory, dual sector, 177
 - Steel yokes, 63
- Levellers**, 141
- Liaison channels**, 186
- Loadcells**, 157
- Logging**
 - See Forestry applications
- M**
- Madagascar**
 - Cart wheel manufacture, 120
 - Reversible plows, 92
 - Sledges, 118
 - Sugarcane crushers, 149
- Malawi**
 - Donkey yokes, 42
 - Forestry operations, 155
 - Implement factory, private sector, 177
 - Ridge cultivation, 93
 - Spare parts supply, 189
- Malaysia**
 - Flexible harness, 57
 - Sledges, 119
 - Tyre collars, 56
- Mali**
 - Camel plowing, 49
 - Ciwara toolbar, 107
 - CMDT-Blacksmith scheme, 193
 - Implement factory, dual sector, 177
 - OHV Scheme, 194
 - Riding cattle, 62
- Manège Sahores**, 147
- Manèges**, 149
- Manufacture of implements**
 - "Disposable" plows, 183
 - Bureaucratic implications, 182
 - Competition from donor-funded imports, 182
 - Demand and supply, village level, 195
 - Fiscal policies, 181
 - Information sources, 196
 - Kit assembly, 194
 - Large-scale, 177
 - Location of workshops, 181
 - Maresha ard, 83
 - Methodological stages, 79
 - Need for farmer feedback, 186
 - Policy implications, 196
 - Private sector, 177
 - Problem of surplus capacity, 178
 - Production problems, 178
 - Public sector, 177
 - Seasonal demand, 181
 - Spare part supply, 187
 - Tender distortions, 183
- Manufacture, village level**
 - Carts, 122, 124, 129
 - CMDT-Blacksmith scheme, 193
 - COBEMAG, 192
 - Consumer demand, 195
 - Ethiopia, 185
 - Gear systems and mills, 152
 - Harnessing, 45, 48, 55, 63
 - Harrow, 95
 - Important roles of blacksmiths, 191
 - OHV-Blacksmith scheme, 195
 - Options, 190
 - Spare parts, 189
 - Traditional, 177
 - Training requirements, 195
 - Water-raising systems, 144
 - Wheels for carts, 120
 - Zaire, 195
- Maresha ard plow**
 - Broad-bed and furrow cultivation, 143
 - Construction, 83
 - Modification for single animal use, 38
 - Modification for terrace formation, 143
 - Sources of information, 143-144
 - Tillage action, 81
 - Use with single animal, 85
- Mass and weight**, 17
- Mauritania**
 - Artisanal training, 146
- Mauritius**
 - Cart wheel manufacture, 120
- Mechanical principles**, 15
- Mechanization policy**
 - Effects on local production, 183
 - Grinding mills, 153
 - Water-lifting equipment, 145
- Metabolic energy**, 19
- Metric units and conversions**, 19
- Mills**
 - GATE involvement, 220
 - GATE Project, 151
 - Information sources, 149, 152, 154
 - Millet, 151
 - Oil-seed, 149
 - Traditional, 149
 - University of Warwick, 227

- Mills, animal powered**
 Niger, 224
 Senegal, 225
- Morocco**
 Artisanal training, 146
 Data-logging trials, 70
 Mixed teams, 60
 Root-harvesting implements, 134
 Use of ard plows, 83
- Mote, 147**
- Mouldboards, functions, 89**
- Mowers, 134**
- Mozambique**
 Donkey yokes, 42
 Importation of wheeled toolcarriers, 183
 Multiple teams, use of, 40
 Steel cart wheels, 122
- Mules**
 Forestry uses, 155
 Pack animals, 117
 Swaziland, 225
 Transport uses, 130
 Yokes for, 42
- Multipurpose implements, 109**
- N**
- N'Dama cattle**
 Yoke sizes, 35
- National liaison committee**
 Tanzania, 226
- Nepal**
 Data-logging trials, 70
 Draft measurement, 159
- The Netherlands**
 Resource organizations, 223
- Networking and workshops**
 ACEMA, 219
 Botswana, 218
 CIMMYT, 223
 Commonwealth Secretariat, 227
 ILCA Animal Traction Research Network, 219
 ILO, 226
 Rice farming systems, 224
 RNAM, Asia, 224
 West Africa Animal Traction Network, 218
 West Africa Animal Traction Workshop, 225
 W. A. Farming Systems Research Network, 218
- Newsletters, 116**
 Appropriate Technology, 227-228
 DAP Project Bulletin, 2171
 Draught Animal News, 227
 GATE, 220
- ILCA Animal Traction Research Network, 219
 RNAM, 224
 Tillers Report, 228
 Togo, 227
 VITA news, 228
- Newton Definition of unit, 16**
- NIAE**
 See also AFRC-Engineering
 Wheeled toolcarrier development, 133
- Niger**
 Blacksmith training, 196
 Camel harness, 50
 Camel plowing, 49
 Training manuals, 115
 Yoke sizes, 35
- Nigeria**
 Camel plowing, 49
 Forestry operations, 155
 Ridge cultivation, 93
 Strad, 107
 Strad cultivator, 79
 Tied ridges, 138
- Nolle, Jean**
 Ariana development, 108
 Houe Sine development, 107
 Wheeled toolcarrier development, 133
- Nominal size (of yokes), 35**
- North Africa**
 Camels, use of, 48
 Cart wheel manufacture, 120
 Mixed teams, 60
 Pack donkeys, 117
 Use of ard plows, 83
 Water-raising equipment, 144
 Yokes for horses and mules, 42
- North America**
 Animal-powered gear systems, 149
 Horse collars, 46
 Mowers and reapers, 134
 Yoking systems, 33
- Nose rings, 51**
- O**
- OHV, 194**
- On-farm trials**
 Broad-bed maker, 143
 Farmer assessments, 169, 175
 Farmer evaluation of implements, 80
 Fertilizer applicators, 136
 Single yokes, Ethiopia, 39
 Wheeled toolcarriers, 133

On-station trials

- Assessment of, 175
- Broad-bed and furrow cultivation, 142
- Broad-bed maker, 143
- Differences with on-farm assessment, 169
- Fertilizer applicators, 136
- Harnessing, India, 59
- Harnessing, Thailand, 58
- Mowing implements, 135
- Need for on-farm replicates, 80
- Single oxen, Ethiopia, 38
- Tillage trials, Zambia, 228
- Wheeled toolcarriers, 133

Oxen

- Cart pulling, 128
- Draft force, 173
- Work output prediction, 171

P

Pack animals, 48, 117, 130

- Saddles for oxen, 61

Pack oxen, 62, 118

Pack saddles, 117

- Illustration, 62, 118
- Positioning, 61

Pakistan

- Animal-powered gear systems, 149
- Camels, use of, 48

Pannier baskets, 117

Peanut lifters, 111

Pecotool toolbar, 104

Persian wheel, 144

Peru

- Herrandina Project, 224
- Toolbar based on ard, 84

Pitching, 26

Planters

- See Seeders

Plow planter

- Illustration, 102

Plows, ard

- Description, 81
- Design features, 84
- Development in Latin America, 84
- Peru, 224
- Tillage action, 81
- Use in swamps, 113
- Use with single animal, 38

Plows, desi ard

- Kenya, 222

Plows, donkey

- Sudan, 225

Plows, double furrow

- Prototype made by blacksmith, 194
- Tanzania, 226

Plows, mouldboard

- Body types, 89
- Botswana, 217
- Description, 86
- Disposable, 184
- Double furrow, 91
- Effect of adjustments, 159
- Forces acting on, 18
- Horizontal adjustment, 26
- Kenya, 222
- Malawi, 222
- Morocco, 223
- Mouldboard types, 89
- Mozambique, 223
- Niger, 221
- Origin, 86
- Parts of, 87
- Pitch adjustment, 26
- Principles of adjustment, 26
- Reversible, 92
- Sudan, 225
- Togo, 227
- Use in swamps, 113

Plows, reversible

- Advantages, 92
- Description and action, 92
- Disadvantages, 92
- Madagascar, 92
- Use in swamps, 113

Plows, ridging

- Description and function, 92-93

Plowshare size

- Definition and significance, 88, 90

Poland

- Animal-powered gear systems, 149
- Root harvesting implements, 134

Polyculteur, 133

Pond excavation, 141

Portugal

- Yokes for mules, 42

Post-harvest operations, 148-149, 151, 153

Potato-harvesting implements, 134

Power, definitions and principles, 21

Project Equipment, 228

Pumping rates, 148

Puncture problems with carts, 126

R

Raw materials, 195

- Rayonneurs**, 102
Reapers, 134
Reins, 50
Repairs
 Blacksmith scheme, Mali, 195
 Lack of provision for, 184
 Plowshares, 90
 Problems in obtaining, 191
 Spare part provision, 187
 Water-raising systems, 148
Research on harnessing
 Bolivia, 29
 Criteria for research
 Organizations undertaking research, 72
Reversible plows, 92
Rice production
 Harvesting, 115
 Implements for, 112
 Levelling, 114
 Levelling boards, 141
 Mali, 220
 Puddling, 114-115
 Research at IRRI, 224
 Scoops for levelling, 140
 Swamp cultivation, 113
 Transplanting, 115
Ridge cultivation, 93
Ridge-tiers, 138
 See also Tied ridges
Ridgers - Plowing
 Malawi, 222
 Morocco, 223
 Niger, 224
 Nigeria, 224
Ridgers, Earthing-up, 94
Ridging plows
 Description and function, 92-93
Riding cattle, 62
RIIC, 218
Road construction, 156
 Harnesses for, 64
Rollers, heavy, 96
Rolling movements, 26
Rolling injection planter, 97
Rolling weeder/brushcutter
 See Weeders, Rolling brush cutter
Root lifters, 134
Roots and Tubers
 Animal-powered cassava grater, 150
 Harvesting implements, 134
Rope engine, 149
Row markers, 102
Rumptstad, 223
- S**
- SADCC**, 218
Saddles, 45
SAFGRAD, 218
 Ridge-tiers, 139
Sakia, 144
Sales agents, 185
SATEC, 219
 Sudan, 225
Sawdust-packed tyres, 221
Scoops, 140
Scratch plow, 81
Second-hand equipment, 189
Seed harrow, 97
Seeders
 Advantages, 101
 Blacksmith innovations, 194
 Botswana, 217
 Descriptions, 96-97, 99, 101
 Disadvantages, 101
 Drills, 98
 Ethiopia, 219
 Fertilizer applicator attachments, 137
 Hand-metered, 98
 Inclined plate mechanism, 101
 Method of operation, 97
 Multi-row, 101
 Niger, 224
 Plow planters, 102
 Precision, 98
 Preparation time required, 168
 Problems, 101
 Roller mechanism, 99
 Rolling injection planter, 97
 Sudan, 225
 Super Eco type, 99
 Training manual, The Gambia, 99
Selection
 See Implement selection
Senegal
 Adoption of seeders, 101
 Blacksmith training, 196
 Groundnut lifters, 112
 Harnessing systems, 71
 Houe Sine development, 107
 Implement factory, private sector, 177
 Manufacture of mills, 152
 Water-raising systems, 147
Share size defined, 88
Sierra Leone
 Animal-powered gear and pump, 150
 Artisanal repairs, 187

Training manuals, 115
Yoke sizes, 35

Single animals

Advantages, 36
Disadvantages, 36, 39
Ethiopia, 38
Farmer trials, 39
Feed implications, 37
ILCA reports, 37
Work potential, 37
Yoking systems, 35

Single ox

See Single animals

SISCOMA, 177

SISMAR, 177, 224

Skids, 32

Skids, functions, 89

Sledges, 118

Socio-economic criteria

Implement selection, 76

Soil

Effects on implement draft, 157

Obstructions, 74

Somalia

Cattle as pack animals, 118

Southern Africa

Lack of toolbar uptake, 110

Multiple teams, use of, 40

Sledges, 118

Withers yokes, 32

Spare part provision, 187-190

Spring tines, 103

Sri Lanka

Water-raising systems, 147

Standard units, 15

Staves, 32

Strad cultivator, 79

Sudan

Camel plowing, 49

Cattle as pack animals, 118

Sugarcane crushers, 149

Super Eco seeder, 99

Swamp cultivation, 113

Swaziland

Forestry operations, 155

Multiple teams, use of, 40

Training manuals, 115

Swedish cooperation

Mozambique, 223, 226

Swing plow, 89

Swingle tree, 35-36

Swiss organizations, 226

Switzerland

Three-pad collar harnesses, 54

T**Tanzania**

Double furrow plows, 91

Implement factory, dual sector, 177

Implement factory, Government-supported, 177

Multiple teams, use of, 40

Weeder rollers, 139

Wheels with string spokes, 121

Wooden bearings, 125

Terrace formation, 142

Thailand

Buffalo collars, 58

Tyre collars, 56

Three-pad collar harnesses

Advantages, 55

Bellerive Foundation, 226

Bolivia, 29

Burundi, 60

Disadvantages, 55

Evolution of, 33

Illustration, 28, 54

Origin in Switzerland, 54

Tied ridges

Burkina Faso, 218

Description, 138

IITA, 224

Illustration, 138

Tillers International, 228

Tine cultivation

Botswana, 217

Zimbabwe, 229

TIRDEP, 226

Cooperation with University of Giessen, 220

Togo

Triangle toolbar, 108

Implement factory, 177, 227

Toolbars

Anglebar, 107

Arara, 104, 107, 192

Ciwara, 104, 107

Houe Occidentale, 105

Houe Sine, 104, 107

Introduction, 107, 109

Kanol, 84

Kenya, 221

Lesotho, 221

Malawi, 222

Mali, 222

Niger, 223-4

- Pecotool, 104, 107
 Peruvian long-beam toolbar, 84
 Policultor 300, 107
 Reasons for success, 110
 Senegal, 224
 Togo, 227
 Triangle, 104
 Unibar, 107
- Toolframes**
- Advantages and disadvantages, 108
 - Ariana, 89, 108
 - Houe Saloum, 108
- Tractive effort**
- Principles involved, 24
- Trailers, 129**
- See also Carts
- Training centres**
- Tanzania, 226
 - Zimbabwe, 229
- Training manuals, 115**
- FAO, 221
 - Niger, 224
 - Zimbabwe, 229
- Training of animals**
- Rein systems, 51
- Training, extension workers**
- Niger, 223
- Treadmills, 153**
- Triangle cultivator/toolbar, 104**
- Tropicultor, 133**
- TUB**
- Acknowledgement, 10
 - Address, 220
- Tunisia**
- Use of ard plows, 83
- Turn-wrest plows, 92**
- U**
- UNIDO**
- Address and details, 217
 - Information source, 77
 - Lesotho, 221
- Units, definitions and conversions, 19**
- University of Giessen, 140**
- University of Hohenheim, 176**
- University of Warwick, 149**
- University research**
- Edinburgh, 227
 - Giessen, 220
 - Hohenheim, 220
 - Kenya, 222
 - Niger, 224
 - Warwick, 227
- UPROMA, 177**
- Rolling injection planter, 97
- USAID, 228**
- V**
- Vertisols, 142**
- Cultivation with multiple teams in India, 40
- Village associations**
- Cameroon, 218
 - Option for implement ownership, 139
- Village blacksmiths**
- ILO involvement, 226
 - Implement assembly, 218
 - Mali, 222
 - Zaire, 228
- VITA, 228**
- W**
- Warwick University, 227**
- Water conservation, 140, 142**
- Water harvesting, 140**
- Water lifting**
- AT International, 228
 - Morocco, 223
 - Senegal, 225
 - Sudan, 225
 - University of Warwick, 227
 - Zimbabwe, 229
- Water-raising equipment, 144-148**
- Water-raising systems**
- Information sources, 148
- Weeder rollers, 139-140**
- Information sources, 140
 - Rolling brush cutter, Tanzania, 226
 - University of Giessen, 220
- Weeders**
- Advantages, 106
 - Disadvantages, 106
 - Discs, 107
 - Duckfoot points, 102
 - Houe Manga, 104
 - Kenya, 221
 - Multirow, 106
 - Nigeria, 224
 - Operational problems, 106
 - Over-the-row, 106
 - Roller weeders, 139
 - Single row, 105
 - The Strad, 107
 - Sudan, 225

- Tanzania, 226
 - Tine options, 103
 - Triangle, 104
 - Types, 102
 - Weeder roller information sources, 140
 - Weeding**
 - Length of yokes, 35
 - Weight and mass, 17**
 - West Africa**
 - Animal-powered gears, 150
 - Head yokes, 30
 - Withers yokes, 32
 - Wheeled toolcarriers**
 - Adapted as ergometer, 69
 - Advantages and disadvantages, 131, 133
 - Broad-bed and furrow cultivation, 142
 - Cart functions, 129
 - Description, 131, 133
 - Development history, 131, 133
 - ICRISAT involvement, 221
 - Inappropriate designs, 183
 - Lessons from research, 78
 - Mower attachments, 135
 - Niger, 221
 - Preparation time required, 168
 - Ridge-tying attachment, 139
 - Wheels for carts**
 - Advantages and disadvantages, 121-122, 124
 - Bearings, advantages and disadvantages, 126
 - Braking systems, 128
 - Bush bearings, 124
 - Car tyres, 123
 - Friction effects, 18
 - Implications of size, 122-123
 - Oil-soaked bearings, 125
 - Pneumatic tyres, 122
 - Punctures, 126
 - Sawdust-filled tyres, 126
 - Sisal spokes, 121
 - Split rims, 127
 - Steel spokes, 122
 - Wooden spokes, 120
 - Wooden, no spokes, 121
 - Withers, Definition, 27**
 - Work, Definitions, 19**
 - Work output**
 - Animal limits, 171
 - Farmer assessment, 172
 - Measurement (organizations), 217, 219, 224, 228
 - Prediction of, 171
 - Work output, measurement**
 - AFRC-Engineering involvement, 228
 - Bolivia, 29
 - Buffaloes, Edinburgh, 59
 - Buffaloes, Thailand, 58
 - Costa Rica, 69
 - Factors affecting, 162
 - Harnessing systems, Thailand, 58
 - Harnessing, Bangladesh, 69
 - Harnessing, Burundi, 69
 - Harnessing, India, 69
 - Harnessing, Thailand, 69
 - Human influences, 165
 - ICRISAT, 224
 - Importance of distance travelled, 171
 - Interpretation of data, 174
 - Maresha ard, Ethiopia, 83
 - Non-working times, 167
 - Principles, 19
 - Question of necessity, 174
 - Role of CTVM, 227
 - UK, 69
 - USA, 69
 - Yoking systems, India, 59
 - Zimbabwe, 229
 - Work rates**
 - Measurement and interpretation, 172
- ## Y
- Yaks, 61**
 - Yams, Harvesting implements, 134**
 - Yawing, 26**
 - Yokes**
 - Adjustments to, 35
 - Belly yoke, 60
 - Donkey, 42
 - Horse, 42
 - Joug de corne*, 28
 - Joug de garrot*, 28
 - Joug de nuque*, 28
 - Joug de tête*, 28
 - Joug frontal*, 28
 - Joug*, definition, 27
 - Lever effects, 24
 - Mule, 42
 - Nominal size, 33
 - Padding for, 32
 - Practical problems, 66
 - Recommended definitions, 29
 - Single, 35
 - See also Yokes, single
 - Yokes, forehead**
 - Bolivia, 29
 - Double, 29

- Illustration, 28-29
 - Single, 29
 - Yokes, head**
 - Advantages of, 31
 - Characteristics of, 31
 - Definition, 28
 - Disadvantages of, 31
 - Fitting, 66
 - Forestry uses, 31
 - Illustration, 28, 30
 - Method of attachment, 31
 - Origin, 71
 - Single, 37
 - Transport uses, 128
 - Weeding with, 35
 - Yokes, horn**
 - Characteristics of, 31
 - Definition, 28
 - See also Yokes, head
 - Yokes, neck**
 - Definition and problems with, 29
 - Yokes, shoulder**
 - Description, 32
 - See also Yokes, withers
 - Yokes, single**
 - Advantages, 36
 - Buffalo, 35
 - Disadvantages, 36
 - Illustration, 28, 35
 - Transport applications, 36
 - Use with swingle tree, 36
 - Yokes, withers**
 - Advantages, 33
 - Camel, 49
 - Collar-type, 57
 - Construction in Ethiopia, 63
 - Description, 32
 - Disadvantages, 34
 - Efficiency measurements, 59
 - Fitting, 66
 - Illustration, 28, 32-34
 - Origin, 71
 - Single, 37
 - Steel, 32, 63
 - Transport uses, 128
 - Weeding with, 35
- Z**
- Zaire**
 - Village-level manufacture, 195
 - Wheels for carts, 121
 - Zambia**
 - Donkey harnesses, 48
 - Evaluation of cart bearings, 125
 - Harness manufacture, 55, 65
 - Multiple teams, use of, 40
 - Training manuals, 115
 - Wooden block bearings, 125
 - Wooden wheels for carts, 121
 - Zebu cattle**
 - Effect of temperature on work, 163
 - Forestry uses, 155
 - Position of withers, 27
 - Zimbabwe**
 - Donkey yokes, 42
 - Flexible harness, 57
 - Implement factories, private sector, 177
 - Multiple teams, use of, 40
 - Ridge cultivation, 93
 - Training manuals, 115
 - Yoke sizes, 35