

AT MICROFICHE
REFERENCE
LIBRARY

A project of Volunteers in Asia

Animal Power in Farming Systems

Edited by: Paul Starkey and Fadel Ndiame

Published by: Friedr. Vieweg & Sohn
Verlagsgesellschaft mbH
Braunschweig, Germany

Available from: Deutsches Zentrum für Entwicklungstechnologien--GATE
in: Deutsche Gesellschaft für Technische Zusammenarbeit
(GTZ) GmbH
Postbox 5180
D-6236
Federal Republic of Germany
Tel: (0 61 96) 79-0

Reproduced with permission.

Reproduction of this microfiche document in any form is subject to the same restrictions as those of the original document.

Paul Starkey, Fadel Ndiamé (Editors)

Animal Power in Farming Systems

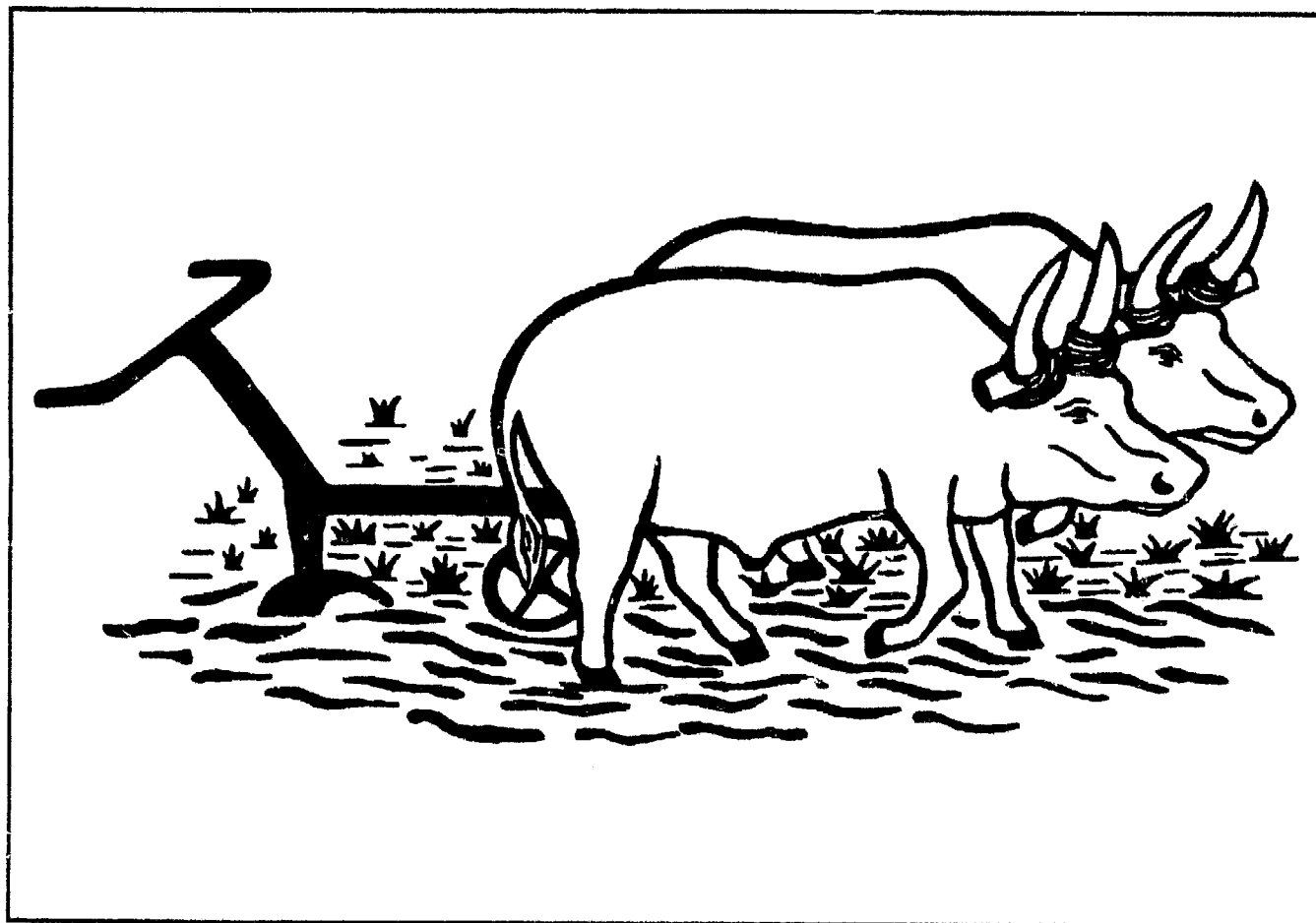

Vieweg

Deutsches Zentrum für Entwicklungstechnologien – GATE

Deutsches Zentrum für Entwicklungstechnologien – GATE – stands for German Appropriate Technology Exchange. It was founded in 1978 as a special division of the Deutsche Gesellschaft für Technische Zusammenarbeit (GTZ) GmbH. GATE is a centre for the dissemination and promotion of appropriate technologies for developing countries. GATE defines „Appropriate technologies“ as those which are suitable and acceptable in the light of economic, social and cultural criteria. They should contribute to socio-economic development whilst ensuring optimal utilization of resources and minimal detriment to the environment. Depending on the case at hand a traditional, intermediate or highly-developed can be the „appropriate“ one. GATE focusses its work on five key areas:

– *Technology Exchange*: Collecting, processing and disseminating information on technologies appropriate to the needs of the developing countries; ascertaining the technological requirements of Third World countries; support in the form of personnel, material and equipment to promote the development and adaptation of technologies for developing countries.

– *Research and Development*: Conducting and/or promoting research and development work in appropriate technologies.

– *Cooperation in Technological Development*: Cooperation in the form of joint projects with relevant institutions in developing countries and in the Federal Republic of Germany.

– *Environmental Protection*: The growing importance of ecology and environmental protection require better coordination and harmonization of projects. In order to tackle these tasks more effectively, a coordination center was set up within GATE in 1985.

– *Promotion of Women's Participation in Development*: A special section established within GATE has the task of implementing pilot projects for the promotion of women's participation in development. The findings of these projects shall be made available for all GTZ projects.

GATE has entered into cooperation agreements with a number of technology centres in Third World countries.

GATE offers a free information service on appropriate technologies for all public and private development institutions in developing countries, dealing with the development, adaptation, introduction and application of technologies.

Deutsche Gesellschaft für Technische Zusammenarbeit (GTZ) GmbH

The government-owned GTZ operates in the field of Technical Cooperation. 2200 German experts are working together with partners from about 100 countries of Africa, Asia and Latin America in projects covering practically every sector of agriculture, forestry, economic development, social services and institutional and material infrastructure. – The GTZ is commissioned to do this work both by the Government of the Federal Republic of Germany and by other government or semi-government authorities.

The GTZ activities encompass:

– appraisal, technical planning, control and supervision of technical cooperation projects commissioned by the Government of the Federal Republic or by other authorities

– providing an advisory service to other agencies also working on development projects

– the recruitment, selection, briefing, assignment, administration of expert personnel and their welfare and technical backstopping during their period of assignment

– provision of materials and equipment for projects, planning work, selection, purchasing and shipment to the developing countries

– management of all financial obligations to the partner-country.

Deutsches Zentrum für Entwicklungstechnologien – GATE

in: Deutsche Gesellschaft für Technische Zusammenarbeit (GTZ) GmbH

Postbox 51 80

D-6236 Eschborn 1

Federal Republic of Germany

Tel.: (06196) 79-0 Telex: 41523-0 gtz d

Paul Starkey, Fadel Ndiame (Editors)

Animal Power in Farming Systems

The Proceedings of the
Second West Africa Animal Traction Networkshop
Held September 19-25, 1986, Freetown, Sierra Leone

A Publication of
Deutsches Zentrum für Entwicklungstechnologien - GATE
in: Deutsche Gesellschaft für Technische Zusammenarbeit (GTZ) GmbH



Friedr. Vieweg & Sohn Braunschweig/Wiesbaden

The Editors:

Paul Starkey studied Natural Science at Oxford University, Education at Cambridge University and Tropical Agricultural Development at the University of Reading. He worked in Malawi for four years and for seven years he was a technical Cooperation officer in Sierra Leone, where he initiated a national animal traction programme. He is now consultant, specializing in animal traction, and also an Honorary Research Fellow at the Centre for Agricultural Strategy, University of Reading. His experience has been published in many journal articles and books. He has been closely involved in regional liaison activities, and has been the Technical Adviser of the West Africa Animal Traction Network since its inception in 1985. His main professional interests are the improved utilization of draft animal power and stimulating closer international liaison in this field.

Fadel Ndiame studied Economics at Cheikh Antadiop University in Dakar, Senegal, and Agricultural Economics at Michigan State University, USA. He works as an agricultural economist for the Institut Sénégalais de Recherches Agricoles (ISRA), in Senegal. He is currently assigned to the Djibelor farming systems research team.

Books by Paul Starkey include:

Animal-drawn wheeled toolcarriers: perfected yet rejected, GATE/Vieweg.
Animal traction directory: Africa, GATE/Vieweg.

Desk Top Publishing

These proceedings were fully published to the stage of camera-ready copy by the Chief Editor, Paul Starkey.

CIP-Titelaufnahme der Deutschen Bibliothek

Animal power in farming systems : a publ. of Dt. Zentrum für Entwicklungstechnologien - GATE in: Dt. Ges. für Techn. Zusammenarbeit (GTZ) GmbH ; [held 19 - 25 September 1986, Freetown, Sierra Leone] / [organized by: the West Africa Animal Traction Network ...]. Paul Starkey ; Fadel Ndiame (ed.). - Braunschweig ; Wiesbaden : Vieweg, 1988

(The proceedings of the ... West Africa Animal Traction Networkshop ; 2)

ISBN 3-528-02047-4

NE: Starkey, Paul [Hrsg.]; West Africa Animal Traction Network: The proceedings of ...

The author's opinion does not necessarily represent the view of the publisher.

All rights reserved.

© Deutsche Gesellschaft für Technische Zusammenarbeit (GTZ) GmbH, Eschborn 1988

Published by Friedr. Vieweg & Sohn Verlagsgesellschaft mbH, Braunschweig
Vieweg is a subsidiary company of the Bertelsmann Publishing Group.

Printed in the Federal Republic of Germany by Lengericher Handelsdruckerei, Lengerich

ISBN 3-528-02047-4

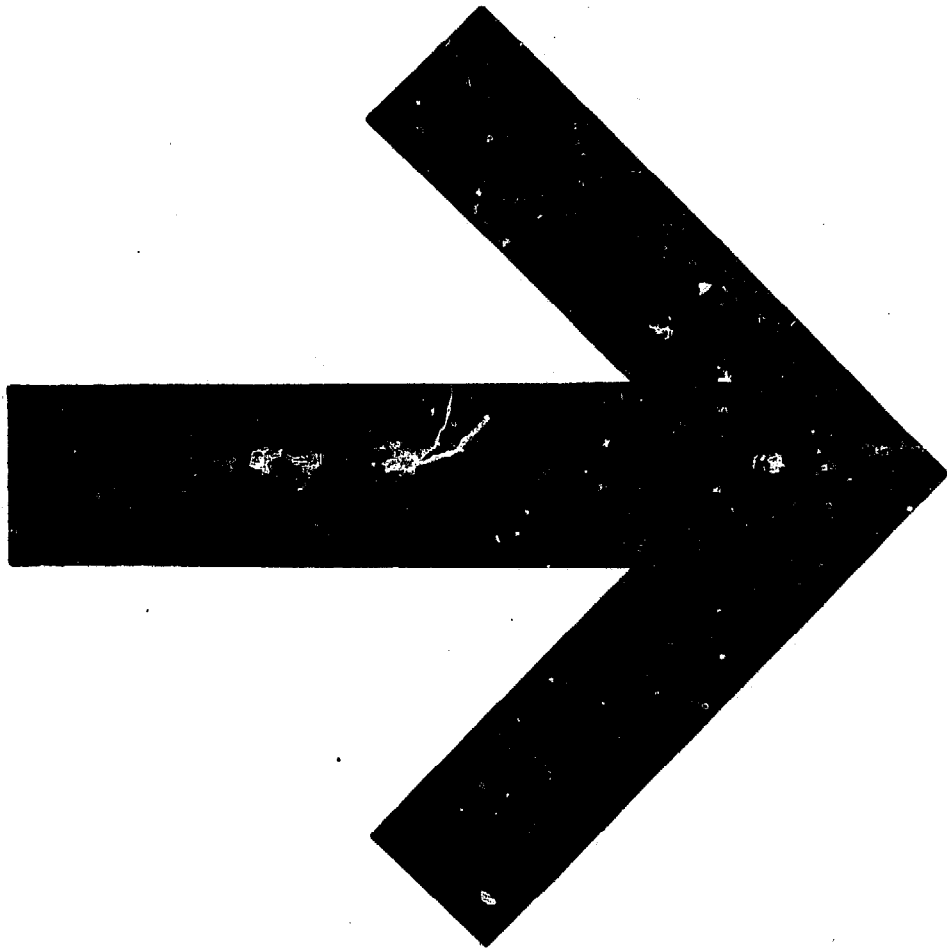

The workshop on "Animal power in farming systems" of the West Africa Animal Traction Network was unique in many ways. It brought together people from 20 countries and a broad range of ecological zones. The participants were specialists in widely differing fields: agricultural engineering, agronomy, animal science, anthropology, economics, extension, sociology, soil science and veterinary science. Their diversity of background was matched by their differing roles in development, for they included researchers, planners, administrators, aid-agency representatives and those actively implementing agricultural development programmes. Their common link was their purposeful interest in introducing, intensifying or diversifying the use of animal power in farming systems. As a result, the atmosphere at the workshop was likened to eighty experienced consultants from different agencies and backgrounds all working intensely together to try to find technical and organizational solutions to their common problems.

In this comprehensive volume the experiences and lessons of the workshop are clearly presented. In addition, through their prepared papers (22 in English, 12 in French) participants describe and analyse their professional experiences in animal traction. Throughout these carefully edited proceedings run the themes of the diversity of experience, the complexity of the farming systems and the desirability of greater information exchange.

This book, containing contributions from 51 authors, provides a wealth of ideas and experience on the problems and possibilities for developing animal traction, and will be valuable to all those interested in this important field of agricultural development.



Deutsches Zentrum für Entwicklungstechnologien

ISBN 3-528-02047-4

Table of Contents

Preface	7
Acknowledgements	8

Part 1: Report of the Networkshop

Introduction

Background to the Network and Workshop	13
Networkshop programme and methodology <i>Paul Starkey</i>	15

Report of Field Visits

Map of Sierra Leone, 22. Introduction, 23. Bumbandae Village, 24. Fadugu Village, 26. Karina Village, 29. Kamatum Village, 31. Kasasie Village, 33. Maforay Village, 36. Mapaki Village, 38. Waridala Village, 40. Demonstration of animal power gear systems at Rolako Ox Plow Centre <i>Jonas Koroma and Wulf Boie</i>	43
---	----

Report of Group Discussions

Soil conservation and tillage: the role of animal traction in establishing permanent cropping systems	49
The selection and development of animal-drawn equipment	52
Animal management and health	55
Research and evaluation methodologies for animal traction programmes	58
Social and economic aspects of animal traction use	60
Farmer needs for extension and training	63

Conclusions, Evaluation and Follow-up

Resolutions and proposals	67
Follow-up to the Workshop	69
West Africa Animal Traction Network	70
Networkshop evaluation	73
List of participants with addresses	82

Part 2: Papers prepared for the Networkshop

The Potential for Animal Power in West Africa

- Farming systems in West Africa from an animal traction perspective
Dunstan S. C. Spencer 91
- The introduction, intensification and diversification of the use of animal power
in West African farming systems: implications at farm level
Paul Starkey 97
- The selection and use of animal draft technology
R. C. Gifford 116
- The relevance of animal traction to the humid zone
L. Reynolds 119

Research on Animal Power at International Centres

- Low-cost modifications of the traditional Ethiopian tine-plow for land-shaping
and surface drainage of heavy clay soils: preliminary results from
on-farm verification
S. Jutzi, F. M. Anderson and A. Astatke 127
- Modifications à bas prix de la charrue éthiopienne de travail du sol et de
drainage de surface sur des sols argileux et lourds: résultats
préliminaires d'essais menés en milieu paysan
S. Jutzi, F. M. Anderson et A. Astatke 133
- Animal traction in improved farming systems for the semi-arid tropics: the
ICRISAT experience in India and West Africa
R. K. Bansal, M. C. Klaij and P. G. Serafini 139

Adapting Animal Power Equipment in West Africa

- Développement et adaptation de l'équipement de traction animale aux
conditions locales du Département de Niamey
S. A. S. Harouna et R. Imboden 151
- L'équipement de la traction animale au niveau de l'Institut des Sciences
Agro-zootechniques (I.S.A.F.)
Alassane Kesso Diallo 161
- Animal power equipment at the farm level in The Gambia
Sidi M. Jarju, Dawda M. Sarr and Alphu J. Marong 165
- Unité de Production de Matériel Agricole (UPROMA)
L. A. Afantonou 169

Animal Power in Mali

- Traction animale au Mali
D. Zerbo et A. Kantao 175

Use of animal power in West African farming systems: farm level problems and implications for research: perspectives from Mali <i>Sanath K. Reddy</i>	182
Contraintes et améliorations de la traction animale en zone Mali-Sud: l'expérience de la DRSPR <i>Moulaye I. Sangaré, Christian Ladrette, Ruben R. Mungroop et Abou Berthé</i>	191
Evaluation rétrospective de la vulgarisation de la culture attelée au sein d'une opération de développement rural: cas de l'Opération Arachide et Cultures Vivrières (OACV), Mali <i>G. Le Thiec</i>	212
Animal Power in Nigeria	
Economic implications of animal power at the small-scale level in the savannah zone of northern Nigeria: a linear programming simulation of farmer circumstances <i>D.O.A. Phillip, G.O.I. Abalu and S.A. Ingawa</i>	225
Utilization and management of work oxen in a Guinea-savannah environment in Nigeria: initial survey results <i>E. O. Otchere, H. U. Ahmed, S. A. S. Olorunju and M. S. Kallah</i>	233
Animal Power in Senegal	
Eléments d'analyse de la situation actuelle de la culture attelée au Sénégal: perspectives d'études et de recherches <i>Michel Havard et Adama Faye</i>	241
Animal traction in Lower Casamance: technical aspects and socio-economic implications <i>Fadel Ndiamé</i>	253
La culture attelée dans les systèmes de production de la Basse Casemance: Aspects techniques et implications socio-économiques <i>Fadel Ndiamé</i>	263
Animal Power in Sierra Leone and Liberia	
Animal traction development strategies in Sierra Leone <i>Bai H. Kanu</i>	277
The role of work oxen in swamp development in Sierra Leone <i>Scott Leaman</i>	288
The utilization and management of draft animals at farm level <i>Abu B. Bangura</i>	293
The economics of animal power in Koinadugu District, Sierra Leone: a case study of the work oxen introduction and credit programme <i>H. Corbel</i>	299
Farmer social variables influencing the adoption of agricultural innovations in Sierra Leone <i>M. L. S. Gboku</i>	311

An assessment of some aspects of work oxen use in Sierra Leone <i>R. D. Bell and D. C. Kemp</i>	320
Preliminary observations on the effect of draft work on growth and trypanotolerance of N'Dama oxen <i>S. Ravindran</i>	325
Animal Power in Togo	
Features of animal traction adoption in Togo <i>A. S. Westneat, A. Klutse and K. N. Amegbeto</i>	331
Caractéristiques d'adoption de la traction animale au Togo <i>A. S. Westneat, A. Klutse et K. N. Amegbeto</i>	340
Mechanical weeding with animal traction: some prerequisites <i>Pakoubatcho Lekezime</i>	350
Introduction de la traction animale dans les systèmes d'exploitation agricole au Togo; le problème de l'approvisionnement en animaux de trait <i>K. Apetofia</i>	353
Suivi sanitaire des animaux de trait au Togo: situation et amélioration <i>E. Leroy</i>	361

Second West Africa Animal Traction Networkshop

"The introduction, intensification and diversification of the use of
animal power in West African farming systems: implications at farm level."

Held 19-25 September 1986, Freetown, Sierra Leone

Organized by:

The West Africa Animal Traction Network, The Sierra Leone Work Oxen Project
The Farming Systems Support Project of the University of Florida

With support from:

United States Agency for International Development (Project 936-4099;
DAN-4099-A-00-2083-000), International Development Research Centre,
International Livestock Centre for Africa, International Institute of
Tropical Agriculture, Deutsche Gesellschaft für Technische Zusammenarbeit.

Preface

The West Africa Animal Traction Network aims to foster the use of animal power for agricultural development in the region and endeavours to ensure efficient exchange of information between its members in West Africa and also with related organizations elsewhere in the world. It is therefore important to acquaint interested individuals, organizations and countries with relevant and up-to-date information on animal traction. One of the ways in which information on animal traction can be gathered and exchanged is through conferences, seminars and workshops. To date, two regional workshops have been held under the auspices of the West Africa Animal Traction Network, and this present volume relates to the second of these.

The Steering Committee of the West Africa Animal Traction Network wishes to express its profound gratitude to the Farming Systems Support Project (FSSP) of the University of Florida, which took the initiative in organizing the first Networkshop in Kara in Togo in March 1985. FSSP also played a key role in the holding of the second animal traction networkshop which was held in Freetown in September 1986. The committee also commends and thanks the other organizations which provided support for the Networkshop including the International Development Research Centre (IDRC) of Canada, the International Livestock Centre for Africa (ILCA), Deutsche Gesellschaft für Technische Zusammenarbeit (GTZ), the International Institute of Tropical Agriculture (IITA) and national projects in

The Gambia, Niger and Togo, co-funded by the United States Agency for International Development (USAID).

The Steering Committee of the West Africa Animal Traction Network wishes to acknowledge the contributions made by all participants, discussion groups and rapporteurs at the Networkshop in Sierra Leone. The editors have presented these various contributions in two parts. The first part presents a summary of the Networkshop activities as well as the principal recommendations of the discussion groups and the whole workshop. The second part contains edited versions of the papers circulated or presented at the workshop.

The editing and publication of these proceedings were made possible thanks to the support of the Farming Systems Support Project (FSSP) and the German Appropriate Technology Exchange (GATE), a division of Deutsche Gesellschaft für Technische Zusammenarbeit (GTZ). The Steering Committee would like to express its deep and heartfelt gratitude to both these organizations.

This Preface has been written by the Steering Committee during a meeting at which it has been planning the Third West Africa Animal Traction Workshop, due to be held in Senegal in 1988. The committee would be most interested in learning the extent to which these proceedings are found to be useful, and would welcome constructive criticism and suggestions for future network publications.

West Africa Animal Traction Networkshop Steering Committee

Addis Ababa, 18 September 1987

Adama FAYE, *Senegal*,
(Committee Representative)
Stephen O. ADEOYE, *Nigeria*
Kossivi V. APETOPIA, *Togo*
Arthur S. GEDEO, *Liberia*

Bai H. KANU, *Sierra Leone*
Dawda M. SARR, *The Gambia*
Dramane ZERBO, *Mali*
Paul H. STARKEY, (*Technical Adviser*)
Michael R. GOE, (*ILCA Representative*).

(The addresses of committee members are given in the list of participants.)

Acknowledgements

The Editors would like to thank the Farming Systems Support Project (FSSP) of the University of Florida for commissioning the preparation of these proceedings. In particular a large proportion of the credit for arranging the Networkshop and ensuring the proceedings were prepared must be attributed to the enthusiasm, dedication and foresight of its Associate Director, Susan Poats. The Editors gratefully acknowledge her vital role and contribution.

The work of Fadel Ndiamé in editing the text of the papers prepared in the French language was authorized by the Directeur Général, Institut Sénégalais de Recherches Agricoles (ISRA), and the Directeur, Département Systèmes, ISRA. The Editors would like to thank ISRA for their excellent cooperation in providing this invaluable help.

The publication of the proceedings was made possible by the German Appropriate Technology Exchange (GATE), and particular thanks go to the Project Officer, Klaus Lengefeld, and the Publications Officer, Henriette Mende, for their support and assistance.

The International Livestock Centre for Africa (ILCA) made many facilities available to the Editors during a meeting in September 1987 and the Editors are very grateful for this help.

Help with the typing and desk-top publishing was provided by Malcolm Starkey. Maps and graphs were prepared by Nikki Barton and Malcolm Starkey. Photographs were provided by Paul Starkey, the Sierra Leone Ministry of Agriculture, Natural Resources and Forestry and Bart de Steenhuisen Piters.

Paul Starkey (*Chief Editor*)

Fadel Ndiamé (*French Text Editor*)

April 1988

Part 1

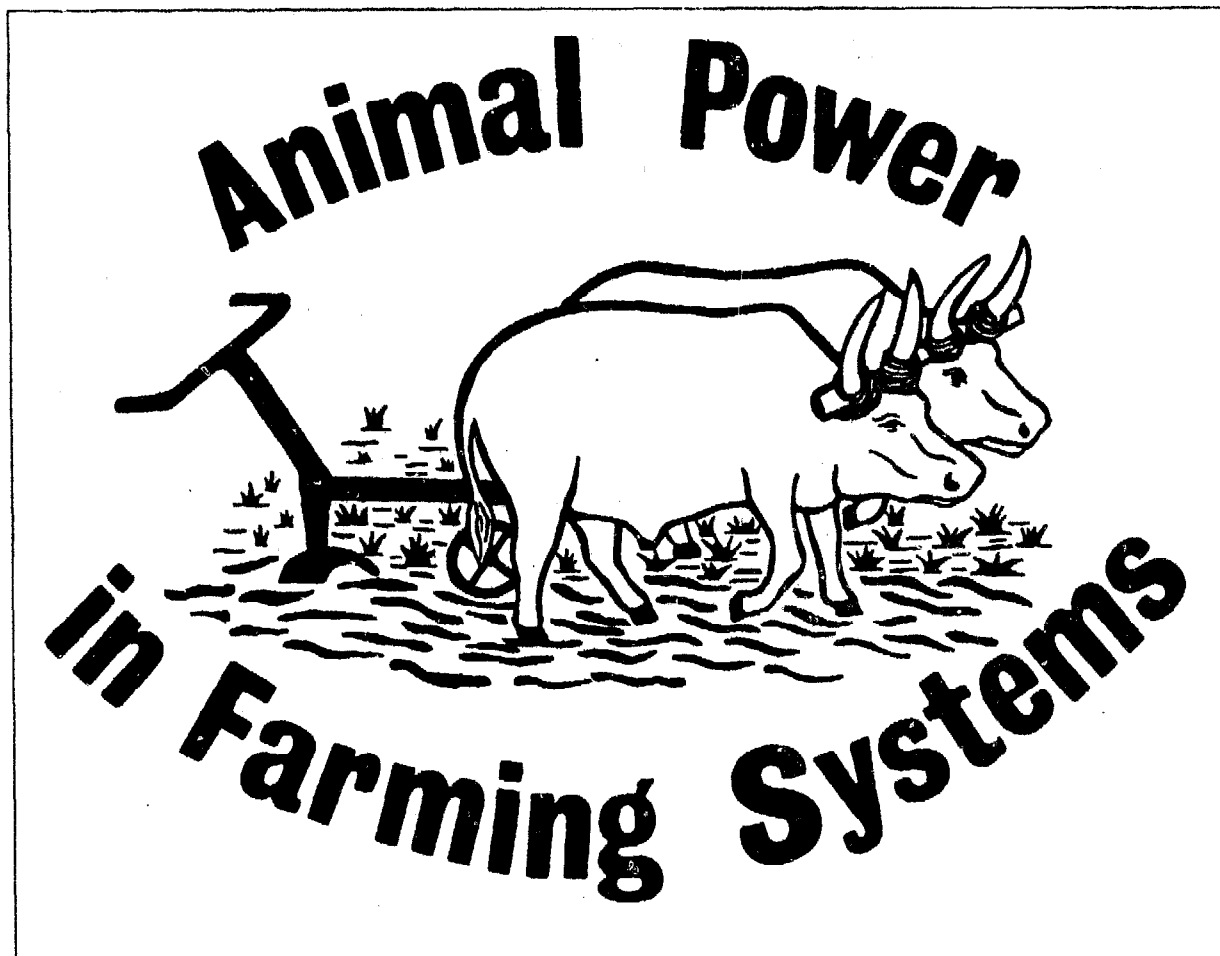

Report of the Networkshop

Title photograph (opposite)

Networkshop field visit group having discussions with farmers at the village of Waridala

(Photo: Ministry of Agriculture, Natural Resources and Forestry, Freetown)

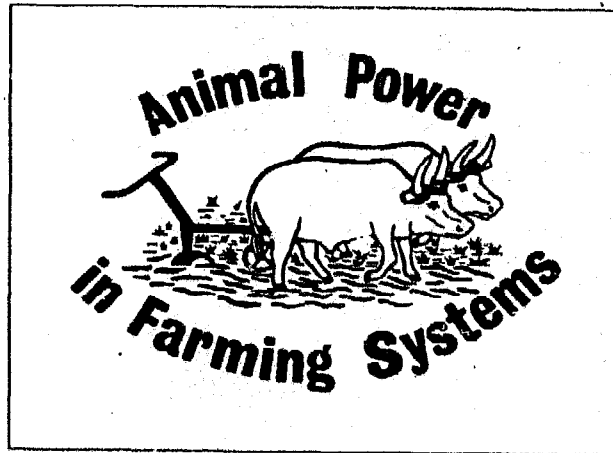

Introduction to the Networkshop



Background to the Network and Workshop

Start of the present initiatives

In late 1984 contact was made between the office of the United States Agency for International Development (USAID) in Togo and the Farming Systems Support Project (FSSP) of the University of Florida. FSSP, funded by USAID, was charged with stimulating a farming systems approach to research and development in West Africa and elsewhere. In Togo, the USAID-funded *Projet Culture Attelée* (PCA) (Kara-Savanes) wished to use a farming systems approach to develop animal traction. It was therefore agreed that FSSP would organize, and PCA/USAID would host, a West African workshop on animal traction. It was felt that animal traction was an area requiring greater exchange of experiences (networking) and that through this, and a farming systems approach to research and development, there could be more effective integration of livestock into West African cropping systems.

First Animal Traction Workshop

In March 1985 a workshop was held in Kara, Togo, with the theme of "Animal Traction in a Farming Systems Perspective". This workshop was the first significant attempt to facilitate direct information exchange between different animal traction programmes in West Africa. Since the workshop was designed to stimulate the development of a Network, it was referred to as a "networkshop". The workshop was run by an FSSP resource team, with logistical support from USAID and the host project. There were 30 participants, the majority of whom were either Togolese or expatriates working in West Africa. African nationals came from projects in The Gambia, Côte d'Ivoire, Senegal and Sierra Leone. The international or donor organizations represented were USAID and the International Development Research

Centre (IDRC) of Canada. The low representation of African and international organizations was attributed to limited planning time and lack of knowledge of just how to start contacting the various animal traction programmes in West Africa.

Activities included the presentation of national programmes, field visits and group discussions on the key topics identified by participants. The main recommendations of the workshop were:

- Nomination of a steering committee comprising African nationals from The Gambia, Côte d'Ivoire, Senegal, Sierra Leone and Togo, together with an expatriate Technical Adviser. The committee was charged with deciding the venue and the theme for a proposed follow-up networkshop.
- Encouragement of greater exchange of information and experience relating to animal traction. Specific suggestions included liaison between the animal traction programmes of Sierra Leone and Togo, and between the West Africa programmes and the International Rice Research Institute (IRRI) Farming Systems Network in Asia.

Follow-up to the First Animal Traction Workshop

In July 1985, FSSP funded a Sierra Leonean from the Sierra Leone Work Oxen Project to undertake a study visit to the various animal traction programmes in Togo. The report of this visit was circulated in both English and French.

In August 1985, FSSP funded two members of the steering committee to participate in the IRRI networking tour of Nepal and Indonesia. The report of the implications of this visit for

West African animal traction programmes was published in English (1986) and French (1987).

In November 1985 the steering committee met in Senegambia. The programme included field visits in Senegal and The Gambia. The meeting was attended by observers from the Food and Agriculture Organization (FAO), FSSP, the International Institute of Tropical Agriculture (IITA), ILCA and USAID (Niger). The meeting decided on the venue, themes, programme and methodology of the 1986 Network workshop to which these proceedings relate.

In March 1986, the workshop secretariat, comprising the Head of the Sierra Leone Work Oxen Project, a representative of FSSP and the Steering Committee Technical Adviser, met in Freetown to discuss proposed workshop arrangements with the local authorities and USAID. Following this meeting, in April 1986,

letters of notification and invitation were sent out to members of the committee, the authorities responsible for animal traction research and development in West African countries, to relevant international research centres and to organizations in Europe and North America supporting work on animal traction.

In August 1986, the proceedings of the first (1985) animal traction workshop were published in English (work was continuing on the French translation of these proceedings).

In September 1986, the Second West Africa Animal Traction Workshop was held in Sierra Leone, with the title of "Animal Power in Farming Systems". In the following sections, the activities and conclusions of this workshop are presented, and in the second part of the proceedings there are edited versions of many of the papers prepared.

Networkshop programme and methodology

by

Paul Starkey

Technical Adviser, Networkshop Committee

Background

The networkshop programme is discussed in some detail here as it incorporated methodological features designed to stimulate interaction that were new to some participants. The networkshop differed from a conventional workshop in its flexibility and its emphasis on small group discussions rather than individual presentations. The networkshop had its roots in the first animal traction networkshop held in Togo in 1985 and the outline of the programme was determined by the Networkshop Committee at its meeting in The Gambia in November 1985. The overall aim was to provide a framework for constructive discussion and information exchange. The draft programme was structured in a logical and progressive way yet was intended to be sufficiently flexible to be adapted to the specific needs of the actual participants, whose professional responsibilities and interests were impossible to prejudge at the planning stage. The provisional programme was circulated with the initial announcement letters, together with explanatory notes. The framework of the programme was adhered to as the basis for the workshop, but adjustments were made (following consensus approval) to respond to identified needs for change.

Introductory session

The networkshop was opened by a government minister responsible for Agriculture and Natural Resources, with words of welcome and encouragement from The Director of Agriculture and from a representative of the United States Embassy.

Two keynote addresses were then given. The first by Dunstan Spencer discussed farming systems research and extension from the perspective of animal traction initiatives. The second by Paul Starkey provided an overview of animal traction in Africa, and developed the networkshop theme of farm level implications of the introduction, intensification and diversification of animal traction in West Africa.

The third introductory session comprised brief "capsule" reports from each of the West African countries represented. The various country delegations nominated one of their members to give, in just 15 minutes, an overview of animal traction in their countries, with emphasis on farm-level problems and solutions. The objective was to obtain at an early stage in the workshop an impression of the diversity of experiences, the commonalities of problems, and the potential for learning from each other's experiences. This session had been scheduled for the first afternoon, but due to the delayed arrival of some participants it was decided to postpone the session. Thus the free time scheduled for the fourth afternoon was brought forward to the first day, and the capsule reports were given after the field visit. It was generally felt that this change was unfortunate in terms of logical sequences, but that it was a necessary compromise resulting from an unexpected airline problem. The delay in presenting the capsule reports may explain the comparative lack of enthusiasm for this session expressed in the final evaluation.

Also included in the planned introductory activities was an opening reception. This was generously hosted by the British High Com-

missioner who welcomed participants in both English and French, thus strengthening the workshop's aim of minimizing the language barriers that have historically impaired communications in West Africa. While not structured, the reception provided an important opportunity for informal discussion and information exchange.

The final introductory session was held at the beginning of the second day, by which time all delayed participants had arrived. This comprised an open session of informal introductions and networking announcements. All participants had the opportunity of briefly introducing themselves. Participants were encouraged to use this opportunity to highlight topics on which they desired information, areas in which they could offer useful experience, and the subjects they were most interested in debating during the informal discussions of the week. Representatives of aid agencies and research centres had the opportunity of briefly describing the work of their organizations and the potential that existed for future cooperation. These extended introductions and announcements allowed participants to clearly identify those institutions and people with whom they wished to make personal contact during the informal sessions.

The Sierra Leone Work Oxen Project and field visits

The host project was given an opportunity to present its work and experiences, and the Project Coordinator, Bai Kanu, did so in conjunction with a video film produced by the organization CEDUST (Centre de Documentation Universitaire Scientifique et Technique) in neighbouring Guinea.

The details of the field visits and their specific objectives were then given. It was stressed that the visits were designed to allow the participants to talk with farmers, and were primarily intended to be stimuli for broadly-based discussions. They should not be seen simply as



Bai Kanu, Coordinator of the Sierra Leone Work Oxen Project

local demonstrations. It was known that many problems would be observed during the visits, problems of animal husbandry, crop husbandry, extension advice, and social constraints such as theft. The host project had seen some of these problems during early planning stages and had considered changing difficult villages or making amends. In the end, the organizers had decided quite specifically that no changes or improvements should be made just because of the networkshop, for the problems arising were typical of many of the constraints found not only in Sierra Leone, but throughout West Africa. The objective was not to simply evaluate the strong and weak points of the Work Oxen Project, but rather to use the visits and discussions with farmers as a basis for understanding in greater depth the general issues involved in animal traction utilization at village level, which could then be brought forward into the thematic group discussions.

A total of eight villages had been selected, in order to allow detailed discussions between the farmers and small groups of about eight participants. The particular features of each village were described during the plenary sessions, so that participants could choose a village that was of specific interest to them. Villages differed in ethnic group, length of animal traction experience, crop mixes, individual or

group ownership and the gender of the main owners/users. While there were a few informal guidelines encouraging the mixing of nationalities and disciplines and clarifying the primary language for group discussions, in practice all participants were able to select a village of their own choosing. Group discussion leaders and rapporteurs were selected from within each group.

Following an overnight stay in Makeni, the eight groups visited their villages in the early morning, and saw farmer-managed demonstration plots and the use of N'Dama oxen for swamp plowing, upland rice weeding, groundnut lifting and, in some villages, ridging and transport. Following the demonstrations, detailed discussions were held in the villages to ascertain farmers' perceptions of the advantages and disadvantages of animal traction in their farming systems. The demonstrations had provided a context and a technical stimulus for the discussions, but with small numbers of people in each group, it was easy for the questions and answers to progress from the various operations being evaluated by the farmers to more fundamental issues. The discussions were followed by typical village hospitality in the form of generous meals.

The various groups re-assembled at Rolako, the technical headquarters of the Work Oxen Project, where they viewed the workshop where plows and other implements were fabricated. At Rolako, demonstrations were given of prototype animal-powered pumps and grinding mills, recently installed under a GTZ/GATE (German Appropriate Technology Exchange) technical cooperation agreement. Their construction had been specially brought forward in time for the networkshop, to balance the dominant field visit themes of *introduction* and *intensification* of animal power with the potential for the *diversification* of animal power through innovative designs.

Back in Freetown, the groups continued their village discussions and then summarized the



Informal discussions during coffee breaks were an important aspect of the Workshop

main observations and lessons from each village visit in a plenary session. Groups noted both successes and failures (positive or negative lessons) and attempted to not only identify the major constraints, but also to cite possible solutions. It was generally felt that the depth of discussions and recommendations was profound. Each group identified specific technical points (covering equipment, animal husbandry, crop husbandry, social interactions, economics and research methodology) but went on to look at the wider implications of animal traction in the farming systems. In different ways, each group concluded that a holistic vision of agricultural development was required, and that a *single technology* approach (even if multidisciplinary) was as problematic as trying to understand the intricacies of a farming system using only the perspectives of a *single discipline*. The very positive nature of the many observations and the criticisms were such that it was observed that it was like a development worker's dream, with 70 consultants from numerous different countries and organizations working constructively together on a single instructive case study and evaluation. This feeling appears to have been reflected in the participants' evaluation of the Networkshop, for most rated the field visit and the ensuing discussions as one of the most useful of the week's activities.

Thematic presentations and discussion groups

At its meeting in The Gambia in 1985, the steering committee had identified four dominant sub-themes for the workshop:

- Animal power equipment at the farm level.
- Animal utilization and management at farm level.
- Economic implications of animal power at the small farm level and village level finance.
- Social implications of animal power at the farm level.

Prior to the workshop all participants had been asked to prepare a brief paper based on their own experience, outlining key farm-level problems (and where practical proven solutions) in any one of these sub-themes. It was understood that only selected papers would be presented during the networkshop and that other papers would be circulated only in their written form to stimulate exchanges and discussion. It was also made clear that any plenary presentations would be brief, and would either be in the form of "capsule" reports relating to the countries or would be designed to stimulate discussion immediately prior to dividing into small thematic discussion groups. It had been requested that papers or abstracts be submitted in advance, and about one half of the participants had done so. About one third of the participants brought their papers with them. Only a few participants had not been able to prepare anything, and this was mainly due to last minute decisions to attend, or the fact that they had considered themselves to be observers.

One morning (Tuesday) was set aside for presentations relating to the proposed discussion themes, and eight papers were selected. The basis for the selection was the relevance of the individual papers to the workshop themes and a desire to maintain a balance between the various disciplines, geographical areas and



Workshop plenary session

organizations represented. The selected presentations included: a perspective on the technological choices available to farmers from the representative of FAO; contrasting methods of animal traction equipment research and development from scientists from ICRISAT, ILCA and NIAE (now called AFRC-Engineering); an overview of constraints to animal traction in the humid zone presented by an ILCA veterinarian; a discussion of research methodology and implications for small farmer economics presented by a USAID agriculturalist; and relevant case histories from Mali, Togo and Nigeria.

The limited time available (half an hour per presentation) necessitated concise deliveries and only a short period for discussion. In some ways this was frustrating, but it allowed much ground to be covered, and it had been an aim of the workshop to have as much time in small discussion groups as was feasible. Among the points raised during the session were the serious constraints caused by animal nutrition in the semi-arid zone and diseases in the more humid zones. The importance of economic profitability was stressed, together with the observation that farmers (and consumers in most countries) often override economic sense with personal preferences for status and convenience. A thought-provoking vision was provided of a technological shelf laden with so many equipment options that selection, rather

than invention, was required. Discussion was particularly stimulated by the clear contrast between a description of an ILCA research programme based on low-cost modifications to the traditional wooden *maresha* plow, and that of an ICRISAT programme developing more productive, but more expensive, cropping systems based on animal-drawn wheeled toolcarriers. Interest in the topics was high, and discussion during coffee breaks and at lunch time was very animated.

Although possible areas for in-depth discussions had been pre-selected, the actual subjects were not decided until after the field visits and the presentations. As a result six areas of interest and concern clearly emerged as requiring detailed discussion. Two of these topics (equipment and socio-economic aspects) were similar to the suggested sub-themes, but four of them were more specific as participants felt more discussion was required on soil conservation, research methodologies, animal health and farmer training. Participants were allowed to choose their own groups, from which were selected chairmen and rapporteurs. To facilitate in-depth discussion, the groups then selected their language for discussion, with two English language groups, two French language groups, one bilingual and one with simultaneous translation. One or two participants then moved from the group of their first subject preference to one that allowed them to use their preferred language. The chosen subjects of the discussion groups were:

- Soil conservation and tillage: the role of animal traction in establishing permanent cropping systems.
- The selection and development of animal-drawn equipment.
- Animal management and health.
- Research and evaluation methodologies for animal traction programmes.
- Social and economic aspects of animal traction use.
- Farmer needs for extension and training.



The Workshop brought together technical specialists from many agencies including GTZ, ICRISAT, SATEC, USAID and CEEMAT

The discussion groups met on Tuesday afternoon and the first half of Wednesday morning, and presented their reports to a plenary session on Wednesday afternoon. Forty minutes were allowed for each group to summarize its discussions and recommendations (with the help of flip charts), and for general discussion of the issues raised. The thematic discussions, as reported and discussed, tended to be more discipline-orientated than those relating to the farm visits. It was felt there was a need to review and discuss in some depth the various experiences within the various technical domains and come up with firm ideas for future directions to follow within these subjects. Although there was not always agreement on the technical merits of different options, there was generally a broad consensus on the methodologies to be adopted.

Final discussion, recommendations and evaluation

The last morning (Thursday) started with plenary discussions, but compared with the small group discussions, the final plenary session started quite slowly, and although some interesting points were raised, there was a certain feeling that many issues had already been discussed. It was clear that the majority of partici-

pants wished to pass onto more concrete recommendations, and so the final session, relating to the future of the Network, started early. Many ideas had been expressed during previous sessions on desirable networking activities, and several of these were put forward as follow-up proposals. It was unanimously agreed that initiatives should include exchange visits between programmes in different countries, and more information exchange, possibly involving the production of a Newsletter. Specific liaison was required between the various manufacturers of equipment in the region. Some formal establishment of the Network was considered desirable (but not without its problems) and the need for some form of secretariat was clear. Without any clear source of funds it was difficult to make concrete proposals, and several organizations including ILCA, ICRISAT, IDRC and FAO were reviewing their programmes and discussing various options for supporting animal traction networking activities. It was therefore considered most appropriate to give very strong support to the principle of networking, without making specific constitutional or organizational proposals. Rather a new Steering Committee was elected to plan and organize the next workshop, and was charged with discussing and investigating future options, and reporting these at the next workshop.

Before the session closed evaluation forms were distributed to all participants. These

allowed people to ascribe values from 1-5 (poor to excellent) for many of the elements of the workshop, including presentations, activities and the logistical services. In addition people were asked to make their own comments on favourable or unfavourable aspects of the workshop, and suggestions for improvements. The disadvantage of asking people to fill in evaluation forms at the end of the last session was that participants had not had the time to reflect on the whole workshop. However the great advantage was that everyone present completed and returned the forms immediately, allowing a good impression to be gained as to how participants viewed the workshop.

Following closing remarks from the committee members, FSSF representatives and the host project, the workshop was closed. There was an opportunity for some sightseeing and shopping in Freetown on this, the final afternoon. In the evening a final reception was hosted by the French Embassy and USAID, at which tee-shirts emblazoned with the workshop logo, and "gara" clothes given by one of the village associations were worn with pride!

The dates of the programme had been planned in conjunction with airline timetables, so that by finishing on a Thursday the great majority of participants were able to travel home on one of the flights leaving on Friday.

Title photograph (opposite)

A workshop field visit group at Karina Village, learning of the experiences of a farmer who had been evaluating the use of animal-drawn seeders and weeders for upland rice production.

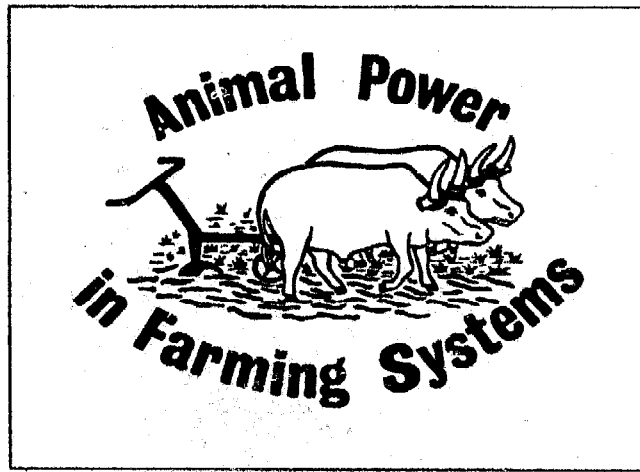

The Field Visits



Map of Sierra Leone

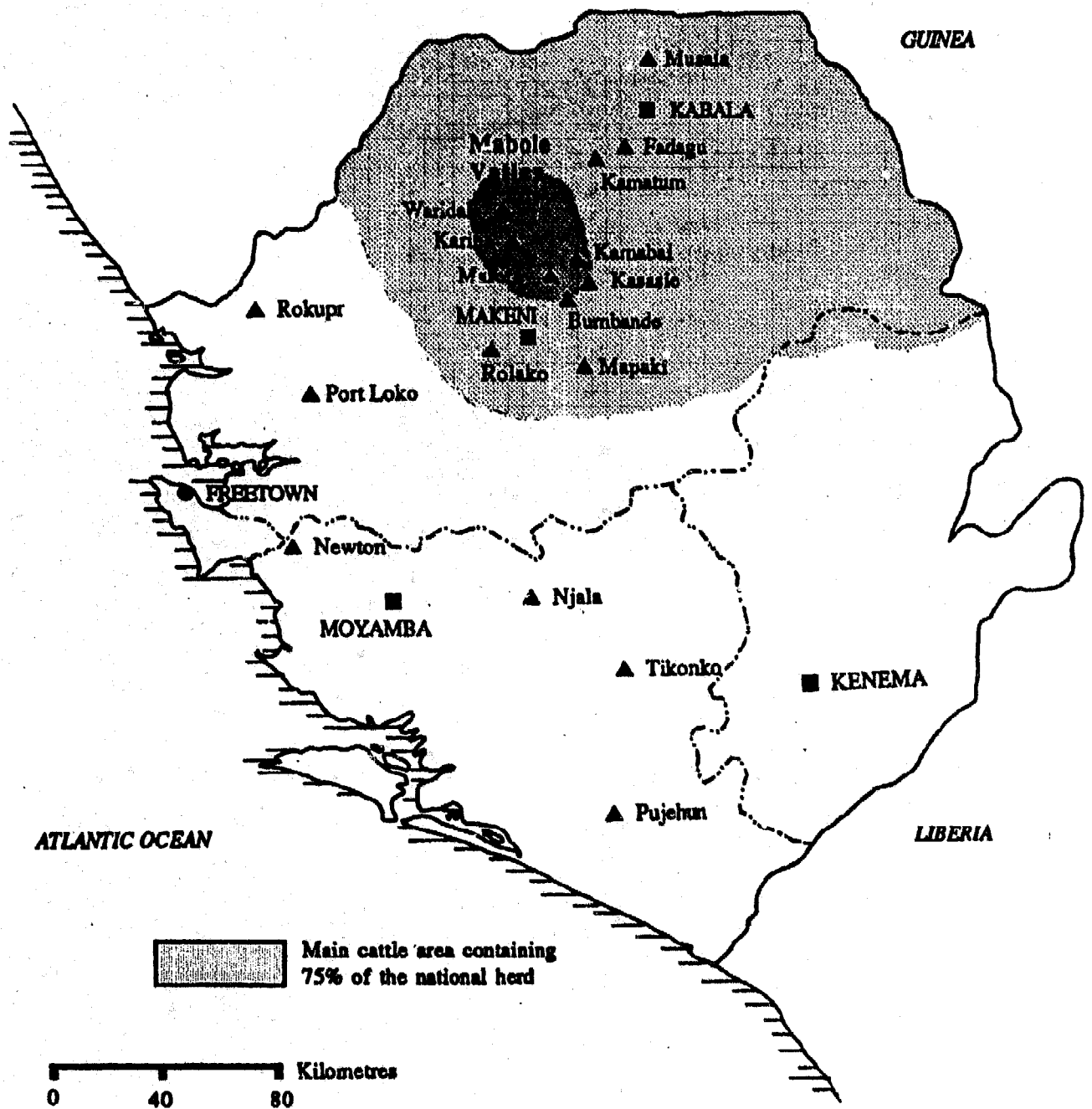

Sierra Leone showing sites of field visits and main animal traction centres

Introduction to the Field Visits

Before leaving Freetown, staff of the Work Oxen Project gave brief descriptions of each of the eight villages that had been selected for the field visits. A summary was given of the history and current status of animal traction in each village and what would be seen in the farmer-managed demonstration plots. The villages differed in their length of animal traction experience, their dominant ethnic group, the systems of ownership (individual or village association) and the gender of the users. Participants were then free to choose the village of their preference. A few adjustments were made to ensure roughly equal groups, the balancing of country representation and to allow just one language (English or French) to be used in the villages (where all questions, answers and discussions would have to be translated into the local vernacular).

Following an overnight stay in Makeni, the different groups, each comprising about seven people, travelled to the villages early on Sunday morning. The coordinating member of the Work Oxen Project introduced the visitors to the chief and farmers, and each group then saw some farmer-managed demonstrations of animal traction use. The groups were also able to visit farmers' fields and see the animal paddocks. The groups returned to their respective villages, and held detailed discussions with the farmers of the village, with the aid of local in-

terpreters. Following traditional village hospitality (lunch) the groups all met up again at the Rolako Ox Plow Centre, where they inspected the workshop and saw demonstrations of recently installed prototype animal-powered gears.

Back in Freetown, the groups re-assembled to discuss the implications of their observations and discussions. Each group was asked to summarize its findings to a plenary session of the Networkshop. It was suggested that each group start by describing briefly what was observed. Good or positive lessons were then highlighted, followed by examples of disappointments or negative lessons. Each group was asked to identify what it considered to be the most critical constraints to animal traction in the village, and then make suggestions on how these constraints might be overcome. Finally groups were asked to present their conclusions and any recommendations, which were briefly discussed.

Thus the following summaries of what was seen on the field visits and what was learned and suggested have been compiled from three sources: the background information supplied by the Work Oxen Project as part of the pre-visit briefing, the notes made by the rapporteur of each group, and the contents of the discussions that followed each report.

BUMBANDAE VILLAGE

Visiting group

A. Samura (Coordinator),
D. Phillip (Rapporteur),
A. Gedeo, S. Leaman, A. Mansaray, D. Sarr,
B. Mansaray, A. Schumacher, M. Sesay.

General information

Ethnic group: Limba

Location: Mabole Valley,
about 15 km from Kamabai

Population: 300

No. Farmers: 31

Cropping systems

Swamps: 25% of cropped area.
Rice in rainy season.
Cassava and sweet potatoes in
the dry season.

Boliland: 0% of cropped area.

Uplands: 75% of cropped area.
Mixed cropping: rice with
some maize, sorghum, Guinea
corn, pigeon pea, groundnuts
and millet.

Animal traction history

The section chief Morie Brima II bought the first set of oxen in 1983, and the oxen are now five years old. He is using the Pecotool plow manufactured in Sierra Leone. In 1986 the Work Oxen Project agreed to set up a farmer association for the use of oxen. The association has ten members. One new set of oxen (2-3 years old) and a new Pecotool plow have been provided. In the current year (1986) the farmers began plowing in June and finished at the end of August, plowing a total of 12 hectares. In the developed swamps, it is possible to plow two times before broadcasting but other swamps are only plowed once. Other implements that have been supplied for the

farmer-operated, on-farm demonstration plots include: triangular spike tooth harrow, Super Eco seeder, Pecotool weeder and Pecotool groundnut lifter.

General observations

The farmers demonstrated the use of their oxen for plowing, weeding and groundnut lifting. There were two sets of oxen, one for the farmers' association and one for the village chief. Both sets were trained in the village with the help of the Work Oxen Project. When oxen were used for cultivation, there was a tendency to opt for monocropping of swamp rice, upland rice and groundnuts. According to the chief, land availability was not a limiting factor, but labour and capital (cash) limited the area that could be farmed. The owners of the oxen claimed they made regular visits to the veterinary services to check the health of their oxen and treat any illnesses. Women were not involved in animal traction.

Successes or positive lessons

- Farmers were enthusiastic about the potential for using work oxen.
- Oxen had been shown to decrease the manual labour requirement.
- Demonstrations showed that most farm operations were possible with work oxen.
- The animals were well trained and responded to signs and vocal orders rather than being beaten.

Failures or negative lessons

- The farmers were dependent on the Work Oxen Project and showed no tendency for self-reliance.
- The large number of stumps made upland demonstrations difficult, so that the demonstration sites had been located near swamps.

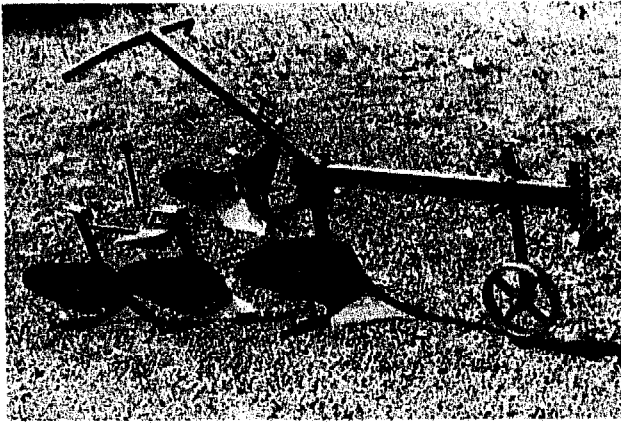

Pecotool showing three plow size options, ridger and groundnut lifter

- The weeder and groundnut lifter demonstrated did not seem effective under the prevailing conditions, and much manual labour was still required after the ox-weeder and groundnut lifter had passed.
- School age children were being used to supervise the oxen. This might restrict their education and be a long-term social problem.
- The animals in each pair did not fit well together.

Primary constraints

- There are at present too few oxen for the number of households, and yet there are severe financial constraints that restrict the potential for purchasing further oxen and equipment.
- The land needs preparation before being suitable for use with animals. The uplands are still full of roots and stumps, and most

swamps either have many stumps or have very deep flooding.

- There is a serious lack of infrastructural facilities, with poor road access and great difficulty in marketing farm products.

Possible solutions

- The provision of credit is essential if animal traction is to develop.
- A more integrated approach towards assisting farmers to overcome rural poverty is required. Animal traction should be seen as just one component of the farmers' many requirements to improve their production and their marketing.
- The farmers' self-reliance needs to be encouraged and developed.

Conclusions

- Water control needs to be developed in deep swamps before oxen can be used effectively.
- The use of animal traction for groundnut harvesting and weeding under such conditions seems premature.
- The weeder and groundnut lifter being used need to be redesigned.
- There is a need to investigate in more detail how animal traction can be integrated into upland farming systems. Until such systems are developed, the use of oxen should only be encouraged for swamp preparation.

FADUGU VILLAGE

Visiting group

P. Allagnat (Coordinator)
A. Westneat (Rapporteur),
S. Harouna, C. Ladrette, D. Zerbo.

General information

Ethnic group: Mandingo and Limba
Location: 80 km north of Makeni,
on road to Kabala
Population: 1500
No. Farmers: 150

Cropping systems

Swamps: 20% of cropped area.
Rice in rainy season.
Groundnuts, cassava, sweet
potatoes, rice in dry season.
Boliland: 45% of cropped area.
Rice in rainy season.
Uplands: 35% of cropped area.
Mixed cropping rice with
sorghum, maize, Guinea corn,
benniseed, cassava, groundnuts
and millet.

Animal traction history

In 1964 two cattle-owning farmers bought plows from traders from Guinea and started to use ox traction (without any assistance from extension agents). In 1967 a subsidized tractor hire scheme was started and the farmers lost interest in animal traction. Since 1982 tractors have been unavailable for hire. Farmers took a renewed interest in animal traction and they themselves contacted the Work Oxen Project. In 1985 the Work Oxen Project began to work with the farmers of Fadugu and in the current year (1986), five sets of oxen are in use, all owned by Mandingo farmers. All farmers own Pecotool plows and use them for plowing (twice) in swamps prior to planting in the rainy

season, and again for dry-season swamp cultivation. On-farm demonstrations, operated by the farmers, have included the use of triangular spike tooth harrows, a Super Eco seeder and Pecotool weeders and groundnut lifters.

General observations

The history of animal traction in Fadugu is particularly interesting. Farmers began using animal traction themselves in 1962, stopped when tractors were available for hire, and became interested again when the tractor programme finally collapsed. Farmers claimed that when tractors were available, farm families in Fadugu were producing about 300 sacks of rice per farm. When they returned to using the hoe and manual labour, they cultivated much smaller areas so that production fell to about 30 sacks of rice per farm. In 1985 some Mandingo farmers restarted the use of animal traction, and already, by 1986, five pairs of oxen were in use.

The group visiting Fadugu were treated to demonstrations of the yoking of a single ox and pairs of oxen, harrowing with a triangular spike tooth harrow, seeding with a Super Eco seeder, plowing in a swamp with a 6" Pecotool and weeding with an adjustable, two-blade Pecotool weeder.

The young N'Dama cattle were in good health and in their first year of traction work. Pairs of this sort were reported to cost about Le 6000 (about US\$200 at the rates current in September 1986). Head yokes were attached to the back of the animals' horns and nose rings were fitted to allow good control. The animals were handled by two people; one person controlled the animals from behind by using reins, while the other operated the equipment. The oxen had been trained by the farmers themselves with technical assistance from the Work Oxen Project staff. Each pair farmed about 6 ha.

Men worked with the animals. Women transplanted rice seedlings.

Successes or positive lessons

The farmers had a very positive attitude to the use of work oxen. They were very skilled at clearly diagnosing their problems and were closely analysing their initial efforts in the use of oxen. This high interest in animal traction technology, together with a clear aspiration for increased output, were considered positive points. Also important was the close collaboration between the farmers and the Work Oxen Project personnel. The farmers are already experienced in animal husbandry and their oxen were drawn from their own herds and this strongly favours the eventual success of animal traction in this area.

Positive and negative aspects of equipment being used

The Pecotool has a good, simple design with innovative engineering features including adjustable handles, a supplementary skid for swamp use and a system of implement attachment using movable bolts and fixed nuts. The long chain is good, as is the capacity to change between 6" and 9" plow bodies.

On the negative side, the Pecotool is oversized and its frame is too large. The wheel bearings are not sealed and allow sand and other abrasive material to penetrate into the axle area. No lateral adjustment is provided. There appeared to be a lack of precision in the implement construction.

The harrow featured a simple design and was constructed out of local materials. These positive aspects were offset by the lack of a handle to lift it up when the spikes became clogged with debris. It was judged to be too heavy for young oxen. No measures had been taken to preserve the wood used in its construction.

The weeder was strong, and each spring that held a tine was supported by a helper spring. It

was adjustable side-to-side and front-to-back. Its primary disadvantage was its size, being too heavy and costly for its weeding task. Also it was only supplied with symmetrical ducksfoot shares and not half-blades that would allow weeding nearer to the plant roots.

The harnessing with head yokes and nose rings was considered appropriate for the N'Dama oxen and controlling the animals from behind was good. Insufficient protection of the head was provided which could lead to injury to an animal. The operators placed excessive force on the nose via the nose ring in their efforts to control the pair.

Failures or negative lessons

The farmers complained about the rapid increases in the cost of animal traction equipment. Price rises had been necessitated by currency devaluations and local inflation, but in an attempt to protect the farmers from the effects of rapid inflation, the Work Oxen Project had not yet increased its prices to meet the true cost of production. The Work Oxen Project was thus selling high quality equipment at relatively low prices. Such subsidies would distort the farmers' perception of their true input costs and in the long term this would adversely affect the efforts of the Project.

There was no provision for credit for farmers wishing to adopt animal traction in Fadugu. The farmers who had adopted animal power this year had bought their equipment for cash and already owned cattle. However many of their neighbours who would like to adopt animal traction technology could not afford to buy animals and equipment unless credit was made available.

The animal health services available to the animal traction farmers of Fadugu were very inadequate.

There had been no discussion of soil conservation issues with the farmers.

Primary constraints

The low incomes of the farmers, the high cost of the equipment and the lack of credit will work against the adoption of animal traction.

The national economic situation with high inflation and rapid increases in input costs is adversely affecting the farmers' ability to plan their finances. This will inevitably retard animal traction adoption.

The farmers noted that any investment in crop production, such as the adoption of animal traction, necessitated improved protection from birds and better fencing to avoid crop destruction by cane rats ("cutting grass") and by monkeys. Fences currently built out of palm branches did not last for an entire season and there were insufficient qualified fence builders in the zone to meet the demand. The farmers also considered the grass weed *Imperata cylindrica* to be a major problem, and a means of reducing this needed to be found.

Possible solutions

Fadugu is in an unusual position in that it does not come under the scope of any of the main Integrated Agricultural Development Projects. As a result farmers do not have access to the extension advice and credit facilities available

to most other villages in the country. Including the Fadugu zone within a development project area should assist in the provision of credit and animal health services.

Conclusions

- The animal traction equipment currently in use should be comprehensively studied and appropriate modifications made.
- The extension strategies currently in use need to be studied with the objective of identifying priority training topics and establishing group training programmes which are more efficient than individual contacts.
- A credit system should be established, and this should allow low repayment in the first year of animal traction adoption. This should include some form of insurance for the animals.
- Improvements should be made in the animal health services, and in the fields of animal nutrition and management.
- There is a need to diversify the operations for which animals are used.
- Animals should be brought more permanently onto the farms, through the use of stables and composting technologies.

KARINA VILLAGE

Visiting group

A. Bangura (Coordinator),
F. Ndiame (Rapporteur),
A. Berthé, B Kouadio, S. Ouedraogo,
M. Sangaré.

General information

Ethnic group: Mandingo
Location: Mabole Valley,
about 10 km from Kamabai
Population: 500
No. Farmers: 25

Cropping systems

Swamps: 40% of cropped area.
Rice in rainy season.
Cassava and sweet potatoes in
dry season.
Boliland: 50% of cropped area.
Rainy season cultivation of
rice only.
Uplands: 10% of cropped area.
Mixed cropping of rice with
some maize, beans, okra,
benniseed and sorghum. Also
groundnuts, millet, cassava and
sweet potatoes.

Animal traction history

Karina was one of the first villages in the country to use animal traction. In 1927 domestic slavery was abolished, creating a major labour shortage for the relatively wealthy Mandingo farmers. Five men from Karina went to Kankan in Guinea for training in the use of draft animals. In 1928 ox traction began with six sets of oxen using Ransome Victory and French plows. In 1950 ten pairs of oxen were in use in Karina, but after that many people

left the village and went to diamond mines. When the Work Oxen Project began its programme in 1980 only seven sets were left in Karina. The enthusiasm of the farmers in Karina for animal traction was such that they readily put on impressive demonstrations of ox-plowing, and this led to the holding of national ox-plowing competitions. The President of Sierra Leone visited the 1985 plowing competition held at Karina and witnessed over 100 N'Dama oxen plowing simultaneously. In the current year, 1986, there are 14 sets of oxen in Karina, one for a farmers' association and 13 for individual farmers. Three farmers each have two sets. In the village there are now 25 plows (Pecotool, Ransome Victory, Guinean, Anglebar and Indian Victory). There are also two harrows (one zig-zag, one triangular), one ridger (for the farmers' association) and one ox cart that has been used for two years. The farmers' association was set up this year with ten farmers. French cooperation has provided them with one set of oxen, one Pecotool plow, one ridger and one harrow.

General observations

The village is located near the Mabole river and most of the population of 500 are Mandingo. Since the 1950s, a high rate of temporary migration to the diamond mining areas has led to a scarcity of male labour. Before the Work Oxen Project started working in the area, oxen were used only for plowing and harrowing. The WOP has tried to promote a more intensive way of using oxen. The group visited farmer-operated demonstration plots where groundnuts, maize and rice were growing. These plots had been plowed twice with a 9" Pecotool plow and then harrowed and levelled with a triangular harrow. A Super Eco seeder had been used for row planting and weeding had been performed with the Pecotool weeder.

Successes or positive lessons

- The farmers and village authorities were closely involved in the implementation of the demonstration trials and also in monitoring their progress.
- The WOP was working effectively through the local leaders in its programme to develop ox traction.

Failures or negative lessons

- The Work Oxen Project was looking at only one aspect of the farming system. Not enough attention was being paid to the diversity of farmers' conditions and constraints. The problems being studied were not necessarily representative or limiting.
- It was uncertain whether the techniques being tested were actually appropriate. There was insufficient monitoring of the technical and socio-economic aspects of the various animal-powered farm operations being tested by the farmers. As a result the Project did not have the means to explain why some plots failed.
- There was no use of manure.

Primary constraints

- The farmers received insufficient support for the purchase of seeds, pesticides, chemicals, fertilizers, drugs and spare parts. There was no assistance with marketing of produce.
- Crops were being destroyed by cattle.

Possible solutions

A better understanding of the farmers, their conditions and the diversity of their farms is needed. This should lead to the clear classification of the farms and farmers according to relevant criteria such as labour, type of equipment and type of constraints. This should allow the identification of the farmers' most critical constraints so that future trials could be more adapted to the identified constraints. A more multidisciplinary approach is required. It is likely that diversifying the use of animal power will prove important, but more research is required to identify the key operations and techniques.

Relevance for network

Similar research is being undertaken in several countries in the region, and there is much experience in this field. There is a great scope for exchange and cooperation on methodologies, on-farm experimentation, village associations and the training of extension workers.

Conclusions

Studies should be made within the Network concerning the various experiences and strategies for improving the farmers' use of animal traction through:

- Improved distribution of farm inputs.
- Credit.
- Marketing farm surpluses.
- Improved animal health and husbandry.

KAMATUM VILLAGE

Visiting group

A. Sheriff (Coordinator),
S. Reddy (Rapporteur),
H. Ahmed, R. Bansal, M. Gboku, S. Jarju,
B. Kehr, S. Ravindran.

General information

Ethnic group: Limba, Mandingo and Fula
Location: 65 km north of Makeni
and 15 km from Fadugu
Population: 200
No. Farmers: 15, with 10 coming from other
villages for farming.

Cropping systems

Swamps: 45% of cropped area.
Rice in rainy season.
Sweet potatoes, cassava,
groundnuts, maize and pepper
in the dry season.

Boliland: 35% of cropped area.
Rice in the rainy season.

Uplands: 20% of cropped area.
Mixed cropping of rice with
sorghum, maize and pepper.
Also cassava, groundnuts,
potatoes and millet.

Animal traction history

1986 is the first year of using draft animals. One set of oxen has been trained, and a second has been bought but is not yet trained. Unfortunately the trained set died because of lightning on 9 September 1986, a few days prior to the Networkshop. Two more farmers have decided to get work oxen. This year the pair of oxen plowed 5 hectares. Swamps were plowed once and bolilands had two plowings. The implements in use have been two plows (Pecotool and Ransome Victory) and one triangular wooden harrow.

General observations

This is the first year in which animals have been introduced. The farmer is enthusiastic, but is new to the system. He was happily undertaking trials involving row-planting with a Super Eco seeder, the inter-row weeding of groundnuts, rice and cassava with a Pecotool weeder and groundnut lifting with a Pecotool. The trained pair of animals had recently died and the new pair looked young, and the head yoke and equipment seemed heavy for their size. The rice field was impressive, but the groundnut field had lots of weeds. The demonstration fields were relatively small, and looked more like demonstration plots rather than normal fields. The farmers felt that the fields prepared with manual labour looked better than those prepared using animal traction.

Successes or positive lessons

- The farmers are very enthusiastic, and two more are going to invest in animal traction next year.
- There is plenty of land for expansion, and farmers do not see labour displacement as a problem.

Failures or negative lessons

- The animals seemed young and improperly trained.
- Farmers did not seem to know how to adjust the implements to control working depth.
- The yoke and rein system seemed complicated.
- The groundnut lifter does not seem to be effective and its design needs to be looked into.
- The equipment seems to be too heavy for the job.

The manner of the plowmen to the animals was not friendly or sympathetic.

- There seemed little sign of financial benefits from the adoption of animal traction. Unless there were production improvements, animal traction would not seem economically viable.
- Conceptually there appeared to have been a missing element: that of a farming systems approach. It looked as though animal traction was superimposed on the existing system without attempting to bring about modifications in cropping procedures. For example, the groundnut variety being used was the spreading type, while bunching varieties have to be used in connection with animal traction.
- There seemed to be a lack of effective animal husbandry extension services to advise farmers on cattle rearing and management.
- Linkages between the normal Ministry of Agriculture services and the Work Oxen Project seemed weak.

Primary constraints

- There is a lack of tradition of animal husbandry in general, and animal traction in particular.
- The traditional slash and burn system is not adapted to animal traction.
- Costs of acquiring animals and equipment are high, and there is no credit system to assist in this.
- There is a serious lack of effective animal husbandry and veterinary services.

Possible solutions

- Long-term efforts in farmer training are required.
- The upland farming system must be made more productive if animal traction is to be viable.
- The Work Oxen Project should work through other organizations, such as the Integrated Agricultural Development Projects, to develop credit programmes.

- The Work Oxen Project should work with the veterinary department to improve the animal health services.

Conclusions

Research is required to identify systems for improved nutrition, control of small biting flies (*Stomoxys spp.*) and control of tsetse flies and trypanosomiasis.

The present yoking system is too complicated and cruel. Research is needed to develop a simpler, more effective and comfortable harnessing system.

Animal-drawn equipment, of both traditional and modern designs, that is used in other counties, should be evaluated. A shortlist of designs suitable for promotion should be prepared.

A more integrated approach to agricultural development needs to be adopted. There should be more focus on cropping systems to go with equipment and the use of improved cultural practices to match the animal traction input.

Socio-economic studies should be intensified to assess opportunities for improving the animal traction system and determine its economic profitability. This should also include regular evaluation of the impact of the technology.

The Work Oxen Project might consider establishing training centres to allow farmers to be adequately trained in animal traction technology. It might also strive to establish better links with the other development agencies and agricultural services, notably the veterinary service and the IADPs. It should also try to exchange technology with other programmes within the region and in other areas of the world.

The major lesson learned was that animal traction is not an easy technology to promote and it is still at a testing stage in the area. Thus the approach should be to proceed with caution.

KASASIE VILLAGE

Visiting group

W. McKinlay (Coordinator)
 J. Oxley (Rapporteur),
 L. Foster, T. Hluchyj, S. Jutzi, D. Kemp,
 A. Marong, T. Mbeya, S. Leigh, S. Poats.

tomatoes, maize and sorghum.
 Also groundnuts and cassava.

General information

Ethnic group: Limba
 Location: 30 km north of Makeni and
 2 km from Kamabai
 Population: 250
 No. Farmers: 25

Cropping systems

Swamps: 30% of cropped area.
 Rice in the rainy season.
 Cassava, sweet potatoes,
 vegetables, peppers and
 groundnuts in the dry season.

Boliland: 20% of cropped area.
 Rice, potatoes and cassava.

Uplands: 50% of cropped area.
 Mixed cropping of rice with
 millet, Guinea corn, peppers,

Animal traction history

A village self-help project scheme commenced in 1976 and in 1978 Mrs. Sally Formen Kama-ra founded a women's association, which now has 60 members. In 1983 group farming was started on 0.5 ha, and by 1986 this has expanded to 2 ha. The women's association purchased a pair of oxen and a plow in 1983 with the help of the Canadian Universities Services Overseas (CUSO). The Work Oxen Project provided training for the oxen and the handlers who were girls from the women's association. During 1986 4 ha have been plowed for the association, as well as some private hire work. Projections indicate that the association will soon require three further sets of animals and an ox cart.

General observations

The group experienced a unique visit to an all-women association. About 20-30 women are

Demonstration of weeding upland rice at Kasasie





Girl demonstrates fixing yoke at Kasasie

active in the project, the aims of which are to provide rice seed for other village farms, to furnish food in case of shortages and to generate additional income from sale of surplus crops. The village women also produced handicrafts which were marketed in an outlet in Freetown to earn additional revenue for village needs. The founder of the group had contacted the Work Oxen Project after its symbolic sign had attracted her attention. CUSO paid for the group's first pair of work oxen and a Pecotool plow, with attachments.

Successes or positive lessons

The Kasasie association had successfully involved women in animal traction. Despite some problems, two girls provided an impressive demonstration of plowing, weeding and groundnut lifting using a young and unfamiliar set of animals that had been borrowed for the occasion. Other positive factors observed were easy access to a nearby market; the

strong and dynamic leadership of Mrs. Kamara who seemed to motivate people and inspire a village spirit; the incentive programme for village women who worked on the group farm which involved being given rice seed for use on individual farms, for which a small interest payment was charged; and an interest in training more women to use oxen. These factors have led to such successes as the establishment and operation of a group farm by women and of getting women involved in the use of draft animal power. The group has made effective use of the Work Oxen Project by calling on it for training oxen and operators, and seeking advice on implement use and animal health. The farm with its many crops (seed rice, millet, sorghum, sweet potatoes, peppers, tomatoes, groundnuts and maize) was a good example of the diversification and intensification of cropping and an ideal setting for using animal traction technology.

Failures or negative lessons

One of the major problems identified was animal health. One of the group's oxen had recently died of disease and the other was suffering from apparent parasitism. Consequently a pair of N'Dama were borrowed from neighbours to demonstrate swamp plowing, groundnut lifting and the inter-row weeding of rice. The project was faced with acquiring one or two more oxen and there was an expressed desire to secure an additional three pairs as soon as resources permitted.

There was a need for additional infrastructure in the village to complement the use of draft animals. Cattle from surrounding herds often invaded the group's farms resulting in damage and loss, and so a perimeter fence was one of the expressed needs. Also a partially built bridge just outside the village on the road to Kamabai and Makeni needed covering with wood to allow the possible use of an ox cart, one of the items desired by the village.

As the dominating project founder provided almost single-handed leadership, there was

lack of any clear leader to follow Mrs. Kamara, and the team considered that in the long term this might lead to problems.

There were doubts as to the suitability of the equipment being used. The changing of the attachments on the Pecotool seemed unnecessarily complicated. Moreover the implement was heavy to lift over fences and heavy to work, especially for use by young women in swampy rice fields.

Primary constraints

Primary constraints included:

- The present instability of the ox power system, due to its relatively new status, problems of health care and the uncertainty of obtaining suitable replacement animals.
- Uncertain economic viability of the group farm and its ability to continue to provide credit for the association members.
- The lack of availability of essential inputs such as drugs and fertilizer.

- Inadequate infrastructure including roads, bridges and transportation.
- Inadequate animal health services.
- Limited choice of technological innovations, e.g. few suitable alternatives for equipment, crop varieties and cultivation practices.

Possible solutions

Most of the potential solutions lay with expanded and improved extension and support services. There was also a need to explore viable credit schemes.

In the area of research the team observed that existing agronomic practices were not always compatible with animal draft technology and that studies should be conducted to help farmers fit their practices to animal power interventions. Also there was the need to evaluate alternative implements and field cropping systems related to animal draft technology. The team suggested that studies be undertaken on the suitability of the animal technology for women, including factors such as the appropriateness of implements for use by women.

The villagers of Kasasie provided the workshop participants with a colourful reception and with singing and music they crossed the small bridge en route to the field demonstrations.



MAFORAY VILLAGE

Visiting group

H. Corbel (Coordinator),
P. Serafini (Rapporteur),
L. Afantonou, A. Diallo, R. Imboden,
P. Lekezime.

General information

Ethnic group: Limba
Location: Mabile valley
1 km from Kamabai
Population: 250
No. Farmers: 25

Cropping systems

Swamps: 30% of cropped area.
Rice in rainy season.
Cassava, sweet potatoes,
onions, vegetables in dry
season.
Boliland: 5% of cropped area.
Rice.
Uplands: 65% of cropped area.
Mixed cropping of rice with
maize, sorghum, cassava,
Guinea corn, groundnuts and
millet.

Animal traction history

The use of animal traction in the village started in 1984, when one farmer bought a pair of oxen and a Pecotool plow. In the current year (1986) the farmer plowed 2 ha of swamp with his oxen, with one plowing in March and a second in July. Unfortunately, one of the farmer's oxen was recently stolen. However the village asked for a farmers' association to be established, with financial assistance from French Cooperation, and as the farmer is a member of this association, he can continue to work with oxen. The 1986 demonstration trials operated by the farmer have included row

planting and subsequent weeding of upland rice and groundnuts, and ridging for cassava production.

General observations

The small village was relatively affluent, an indication of which was that half of the houses had roofs with corrugated iron. The people appeared well fed and the children seemed healthy. There were surprisingly few sheep and goats in the village. The villagers themselves did not seem particularly interested in the demonstration of plowing, weeding and groundnut lifting and only people from the neighbouring village came.

Successes or positive lessons

The farmer who was the first and only ox-owner in the village was a blacksmith and carpenter. Thus, from the beginning, he should be capable of maintaining the animal-drawn equipment. It was felt that he could become a very good example.

The animals appeared well nourished and in good health. They were well trained and the operators appeared to have a good attitude towards the animals.

The owner did not operate the oxen himself, rather his children did. The farmer considered that animal power reduced his dependence on hired labour and village work societies.

Failures or negative lessons

The Pecotool equipment seemed much too heavy (perhaps twice as heavy as necessary) for the work it was doing, particularly in the muddy, swampy conditions. This toolbar was designed for upland conditions. The toolbar did not have any lateral adjustment. The animals were too small for use with such equipment.

The weeding tines were not adequately adjustable, front-to-back, to permit weeding in rice. The ducksfoot weeding sweeps were too small.

Farmers did not have access to some of the equipment being demonstrated, notably the weeding tines.

The yoke had not been adequately refined for use with the animals, and had too many square corners.

Crop performance was poor, despite a relatively good environment. Yields were far from their potential due to lack of fertilizer, weed competition and lack of water control.

The agronomic implications of animal power had been largely ignored by the Project and the farmer. The relationship between animal traction and other agronomic technologies and possibilities seemed to have been totally ignored. The Project had provided no inputs other than those directly relating to animal traction.

There was a lack of emphasis on production increases that might give the farmers the means to purchase the equipment they needed. Instead farmers were left almost at subsistence level and provided with equipment at an unrealistic, subsidized cost. If farmers were to use animal traction in the long term they would have to be able to afford the full cost of equipment through increases in crop production.

It was noted that most farm income came from tree crops, including tapping palm trees for palm wine and the sale of palm oil, palm kernels and oranges. Many of the trees had not even been planted so that the farmers were basically gathering what was naturally available in the forest without any significant agricultural efforts. This important economic activity was not linked commercially or psychologically with animal traction.

Farmer training was based on limited operations. As a result the farmers did not exploit

the full multipurpose potential of the equipment and had little appreciation of the possible applications of the toolbar.

Animal husbandry was not an integrated component of the farming system. Even small ruminants were not common, despite vastly under-exploited forage resources. It is possible that serious animal health problems may be implicated in this situation.

Primary constraints

The farmers lack vision of the possibilities of integrating their enterprises; for example the farmers talked of their problems, and not the implications of their problems in terms of the lost opportunities for production. There is therefore a lack of any concept of the improvements in productivity that might be possible with the introduction of animal traction.

There is no coverage of the village by the extension or veterinary services.

Possible solutions

It is recommended that the introduction of animal traction be looked at as a part of an integrated production system and not as an end in itself.

An integrated farming systems research programme is needed. This might include on-farm experiments, one set managed by researchers and the other managed by farmers, designed to establish an appropriate set of agronomic practices for use in an integrated farming system in which animal traction is used for crop production. Simultaneously and in association with this, a basic research and development effort on appropriate animal traction equipment should be undertaken with emphasis on possible participation of local artisans in the fabrication and maintenance of equipment. Furthermore an investigation should be made into appropriate ways of organizing and training the farmers once appropriate extension advice becomes available.

MAPAKI VILLAGE

Visiting group

J. Koroma (Coordinator),
M. Klaij (Rapporteur),
S. Adeoye, E. Busquets, S. Hooke,
M. Jambawai, I. Kabia, T. Turay.

General information

Ethnic group: Limba and Temene
Location: 30 km southeast of Makeni
Population: Over 1000
No. Farmers: 30

Cropping systems

Swamps: 30% of cropped area.
Rice in the rainy season.
Sweet potatoes and vegetables
in the dry season.

Boliland: 5% of cropped area.
Rice in the rainy season.

Uplands: 65% of cropped area.
Cassava, rice, maize, sweet
potatoes, groundnuts, citrus,
vegetables and oil palm trees.

Animal traction history

A farmers' association had been formed in 1983 by school leavers and local farmers. The association's leaders had heard of the Work Oxen Project and in 1985 several members of the association attended the Work Oxen Project's National Plowing Competition at Karina and also visited Rolako. A request was put to the Peace Corps Small Project Scheme who donated a set of work oxen and Pecotool implements. The association's ox handlers were trained at Mapaki by staff of the Work Oxen Project based at Rolako. Since 1985 association members have used work oxen to cultivate 3 ha for the members of the association plus 3.5 ha for other farmers. Members of the association are managing demonstration plots

on which they have undertaken row-planting with a Super Eco seeder, inter-row weeding, groundnut lifting and ridging.

General observations

The group was received by the association's leader who had developed an 8-ha area of fallow land for demonstration purposes. A tractor had been used in initial cultivation to save time. Upland rice (Rok III variety) was inter-cropped with oil palm. An adjacent upland plot had been plowed using oxen and planted with pincapples. There were fields with improved cassava varieties and vegetable gardens with improved varieties of sweet potato.

A plowing demonstration took place in one of the vegetable plots. The oxen were harnessed with a head yoke and pulled a Pecotool 6" plow. The soil was gravelly and there were some stumps which made plowing difficult. A tine-harrow having a wooden frame and iron spikes was also demonstrated. Near the village was the paddock erected for the oxen, complete with a compost pit. In the village a communal building was under construction, which was to be used as a seed store. A young cripple had been trained as a blacksmith, and was making machetes and knives.

Successes or positive lessons

There was dynamic leadership of the association by an extension worker who came from the village. He motivated the association to initiate group action, and caused farmers to adopt new practices by demonstrating, as opposed to *imposing*, the techniques. There had been attempts at soil conservation, with the use of field bunds designed to control erosion. Improved planting techniques (using vine transplantation) had been adopted for sweet potatoes. Farmers appreciated the shorter duration cassava and the increased food production. There was plenty of farmland available.



Plowing with the Pecotool plow at Mapaki

Failures or negative lessons

Several pests were mentioned during group discussions, including monkeys, rodents, birds and human thieves. Small biting flies (*Stomoxys*) were a problem and oxen refused to work in the presence of too many flies. The Pecotool plow and other equipment were too heavy for easy transport to the fields of other farmers. Chemical fertilizers were generally unavailable.

Primary constraints

Labour requirements for weeding and harvesting were the main constraints to using the large land area that was available.

Possible solutions

There was the need to strengthen the external supporting services, notably the veterinary ser-

vices and services supplying inputs such as seeds and fertilizers. Improvements in animal husbandry were required, and farmers were testing the use of mineral oils and certain plants to control the flies. There was a need for improved transport to allow the provision of inputs and the collection and marketing of produce.

Conclusions

Further on-farm adaptive research is required with the active participation of farmers in order to understand the farming system and all its ramifications. This has already been well started and the required basis exists for a good understanding of the local system. The present aim is to generate economically viable low-cost (low-input) cropping techniques and in the circumstances this seems very appropriate.

WARIDALA VILLAGE

Visiting group

Y. Schwartz (Coordinator),
A. Faye (Rapporteur),
K. Apetofia, R. Mungroop, R. Roosenberg,
G. Le Thiec.

General information

Ethnic group: Mandingo
Location: Mabole Valley,
16 km from Kamabai
Population: 300
No. Farmers: 11

Cropping systems

Swamps: 50% of cropped area.
Rice in rainy season.
Sweet potatoes and cassava in
the dry season in about one
quarter of the swamps.
Boliland: 35% of cropped area.
Rice and millet.
Uplands: 15% of cropped area.
Mixed cropping of rice with
sorghum, millet and
groundnuts. Maize grown
inside the village.

Animal traction history

Ox traction started in Waridala in the 1930s and during the Mabole Valley Ox Ploughing Scheme of the early 1950s several Ransome Victory plows were bought. Use of animal traction persisted without any external support, so that by the time the Work Oxen Project started at Njala University College in 1980, there were still seven sets of oxen in regular use. These oxen were only used for plowing for rice production in a system that involved two plowings between May and August prior to broadcasting or transplanting. Early cooperation with the Work Oxen Project in-

cluded the testing and evaluation of several plow designs, including a light plow made in Guinea and the Pecotool. In 1983 the Work Oxen Project set up a village association of 23 members and provided one set of oxen, a Pecotool toolbar (complete with 6" and 9" plows, weeder, ridger and groundnut lifter), a harrow, ox-cart and a Super Eco seeder. In 1986, French cooperation provided the association with a second set of oxen and a new Pecotool and triangular harrow. There are currently 11 sets of oxen in Waridala, two pairs belonging to the association and eight belonging to individual farmers, including the chief. In the current year there have been farmer-operated demonstration plots evaluating techniques for row planting and inter-row weeding of upland rice, groundnuts and cowpeas.

General observations

Demonstrations were seen of swamp and boliland plowing with a 9" Pecotool, planting millet in boliland with a Super Eco seeder, harrowing with a zig-zag metal harrow, groundnut lifting, and ridging for cassava and sweet potatoes.

Successes or positive lessons

- Waridala appears a well-structured village with good social cohesion and a stable and coherent village hierarchy. The village association for using draft animals is well organized.
- Farmers are very interested in animal traction and ready to learn new ideas or techniques from the Work Oxen Project.
- Plowing depth and land inversion are satisfactory.
- The ox handlers performed well and the animals were well trained.
- Efforts had been made to improve animal husbandry, with clean compounds, daily

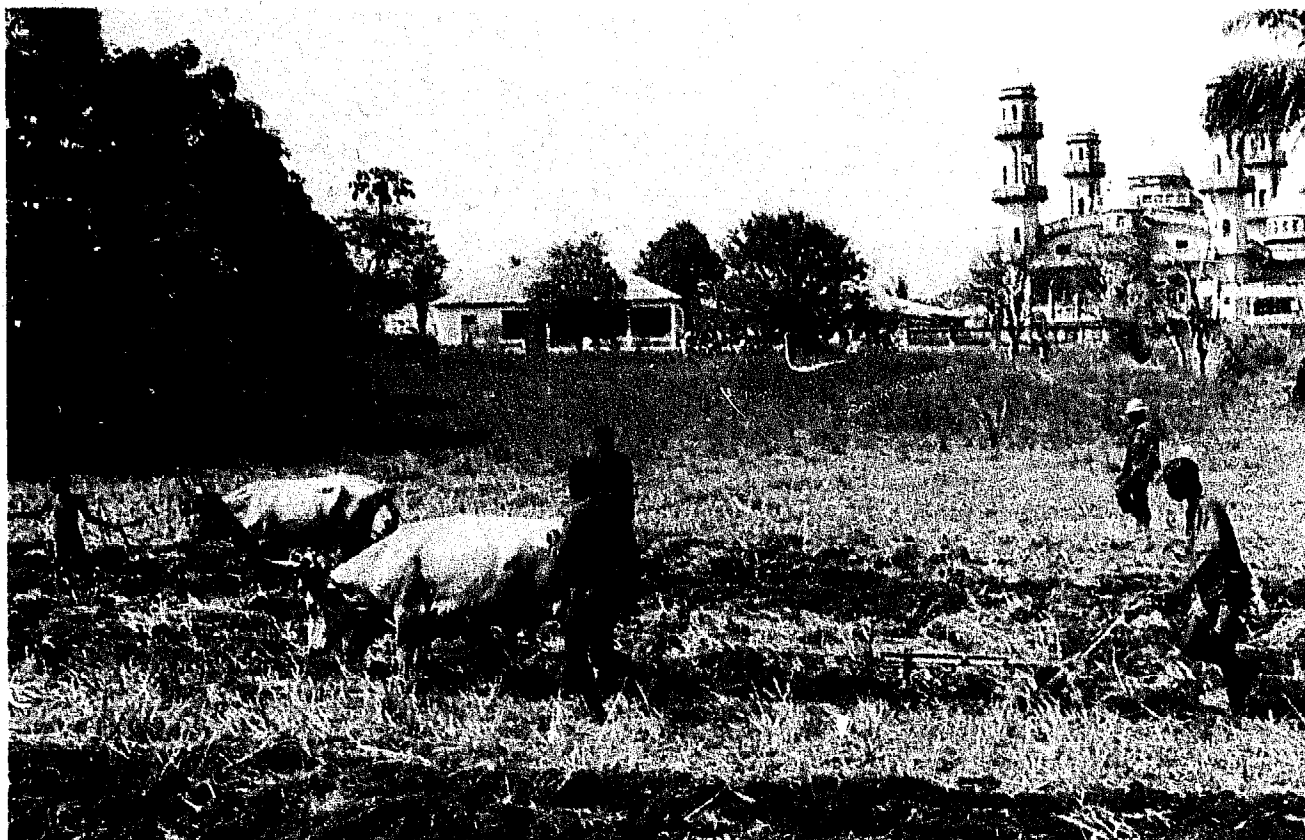

Plowing swamp using old Victory plow at Waridala

health checks, and attempts at the systematic use of traditional health practices and medicines.

- Manure is made into compost and used for crop production.

Failures or negative lessons

- The village is highly structured in terms of traditional gender roles and women do not use work oxen. As a result it appeared that development of animal traction might further marginalize the women, and possibly also the children, who often have to look after the animals.
- Yokes are not well designed or manufactured. They are not tightly attached to the horns, and this movement reduces the tractive power of the animals.
- Pairs of oxen were used for seeding, whereas only a single animal is needed.
- The plow has no provision for horizontal/lateral adjustment. The landside is not adjustable. The wheel is not of suitable design since the use of ball bearings should be avoided. The Anglebar plow (superseded by the Pecotool, but still in use) clogged easily due mainly to its low clearance and the rectangular shape of the plow support. The Pecotool weeding and groundnut lifting attachments are underutilized.
- The Super Eco seeder is not adapted to the prevailing humid soil conditions as it is easily clogged.
- The metal zig-zag harrow is too light and does not allow good harrowing.
- The farmers complained that the cost of spare parts is high.
- The Work Oxen Project is only supporting the animal traction aspect of farming, and farmers require other inputs as well.
- The commercial development of farming seems poor, since there is no cash crop. There is little demand for produce within the

village and no easy access to external markets.

- External services, such as animal health or credit provision are lacking.
- Farmers cited that they had difficulty in obtaining oxen.

Primary constraints

The Work Oxen Project is working in "technological isolation". There are many agronomic and economic problems for which it cannot offer any solution.

There is no marketing structure to encourage the commercial development of farming.

Possible solutions

- There is a need to adopt a more interdisciplinary and integrated approach to agricultural development. The Work Oxen Project should be less isolated and should coordinate its activities with other projects to ensure the farmers have access to a much wider range of services.
- Marketing structures should be established as an incentive for crop production.
- There should be further testing and adaption of the animal traction equipment. New designs, such as the UPRONA seeder from Togo, should be tested.
- It might be useful to undertake trials using draft cows, in case this could be a solution to the problem of obtaining replacement animals.

Weeding upland rice with Pecotool at Waridala



Demonstration of animal power gear systems at Rolako Ox Plow Centre

by

Jonas Koroma¹ and Wulf Boie²

Background

Two animal power gears were set up at the Rolako Ox Plow Centre during the months of August and September 1986, with financial and technical support of the German Appropriate Technology Exchange (GATE), a division of GTZ. These gears will serve the Work Oxen Project as equipment for demonstrations and tests. The current programme is also intended to determine the extent to which animal power gears can be introduced at village level. The Work Oxen Project (WOP) will carry out a research programme on it during the next few months.

The gears have been built in the workshop of the Ox Plow Centre, although some parts, such as the chain drive and the machines driven by the gears (the rice huller, cereal mill and water pump), have been imported from Europe.

Single purpose gear

This system is used to drive a maize mill with a single ox. It is also planned to carry out trials using this gear system to drive a cassava grater, but this installation could not be finished before the demonstration for the Networkshop.

Several gears of this type have already been installed at village level in Senegal and Burkina

¹ Sierra Leone Work Oxen Project

² Projekt-Consult GmbH, on behalf of GATE/GTZ

Demonstration of the single purpose gear used as a maize mill





Oxen turning the multipurpose gear at Rolako

Faso. In these countries the system is used to grind millet, and donkeys are used as draft animals. The women who utilize the mill usually use their private donkeys and operate the mills themselves.

The working principle is as follows. A draft animal moves the frame around a circular wall built of bricks. This brings into motion the car wheel that is supported by the wall. This wheel, in turn, drives the mill by means of a chain drive.

The main advantages of this gear are its comparatively low cost and its simple design. On the basis of current prices, the locally purchased materials to construct the unit cost about US\$ 450, and the mill, imported from Europe, costs about US\$ 250.

The output of the mill has been calculated at about 14 kg maize per hour when two grinding operations are carried out (the first grinding

produces a rough milling while the second is more fine). As the machine is still undergoing tests and research, the final output rates are not yet known. The output of the mills installed in Senegal and Burkina Faso range between 10 and 15 kg h⁻¹.

Multipurpose animal power gear

The installed multipurpose animal-powered gear system is a prototype being tested for the first time in an African country. The system is designed as a multipurpose drive for different machines that require a relatively high rotational speed, and it provides an output of up to 500-600 revolutions per minute (rpm). The gear is intended to drive various crop processing machines, including a rice huller, cereal mill, cassava grater and oil press. The system is currently driving both a rice huller and a water pump. The present price is relatively high (US\$1500) and the main tasks for further de-

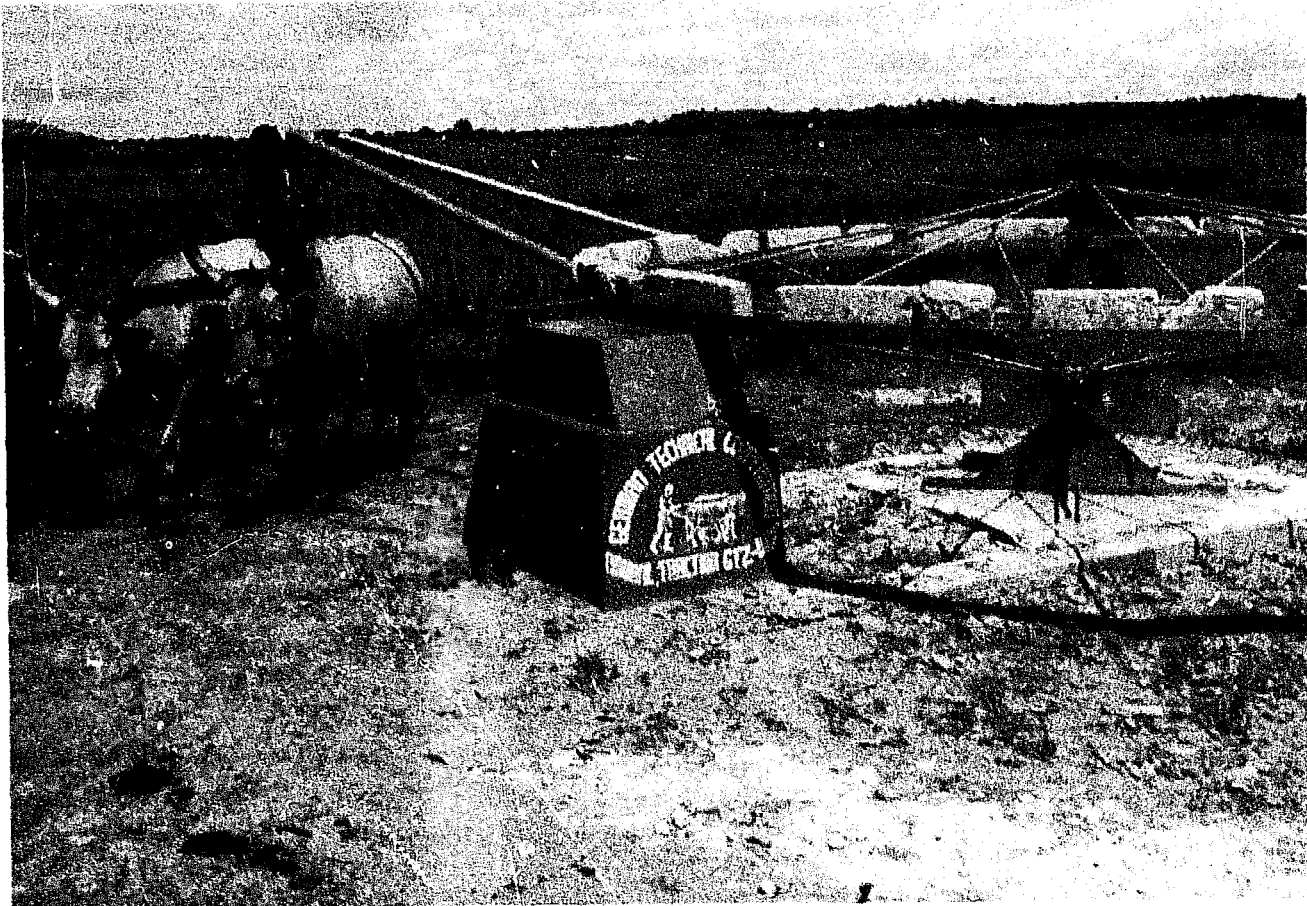

Multipurpose animal-powered gear being demonstrated at Rolako

velopment are to decrease the overall cost and to increase the output of the rice huller.

This system works upon the principle of friction. A large wheel made from U-channel steel is turned by a pair of yoked animals. This drives a small friction wheel with a rubber surface from a car tyre. The friction wheel, in turn, drives a shaft leading to the machines. The shaft drives the machine by means of a simple flat belt drive. The change from one machine to another can be done by changing the flat belt.

The water pump that is driven by the gear system is designed to provide Rolako station with water for domestic purposes. The pump is able to lift the water at the rate of about $2 \text{ m}^3 \text{ h}^{-1}$, through a 120-m pipe, to a total height of about 16 m.

The output of the rice huller depends on several parameters including the adjustment of the huller blade and its outlet, the number of revolutions per minute, the variety of the rice being milled, the moisture content of the rice, whether the rice is parboiled or not and the temperament of the animals. During the first tests with parboiled rice, the output was about 15 kg h^{-1} . There were hardly any broken rice grains among the milled rice, and the recovery rate was good at about 80%. During the demonstration, non-parboiled rice was milled, which gave a higher output rate but a lower recovery rate. During the coming year the Work Oxen Project will carry out a research programme to establish the influence of various parameters on the quantity and quality of rice milled and to evaluate the acceptability of the product to consumers.

Title photograph (opposite)

Workshop group discussing animal traction research and evaluation methodologies

(Photo: Ministry of Agriculture, Natural Resources and Forestry, Freetown)

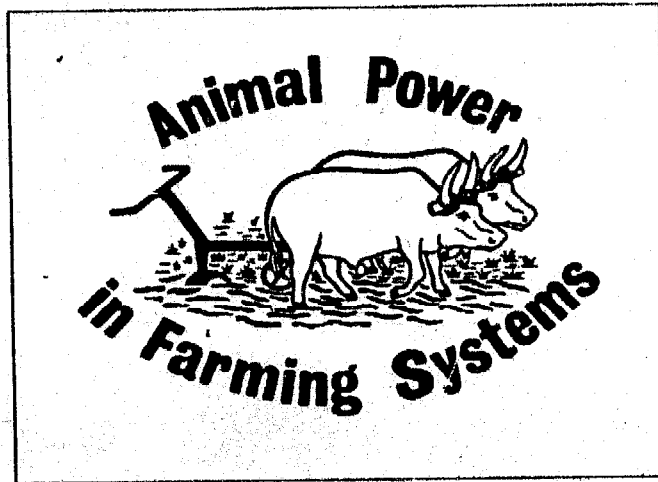

The Discussion Groups

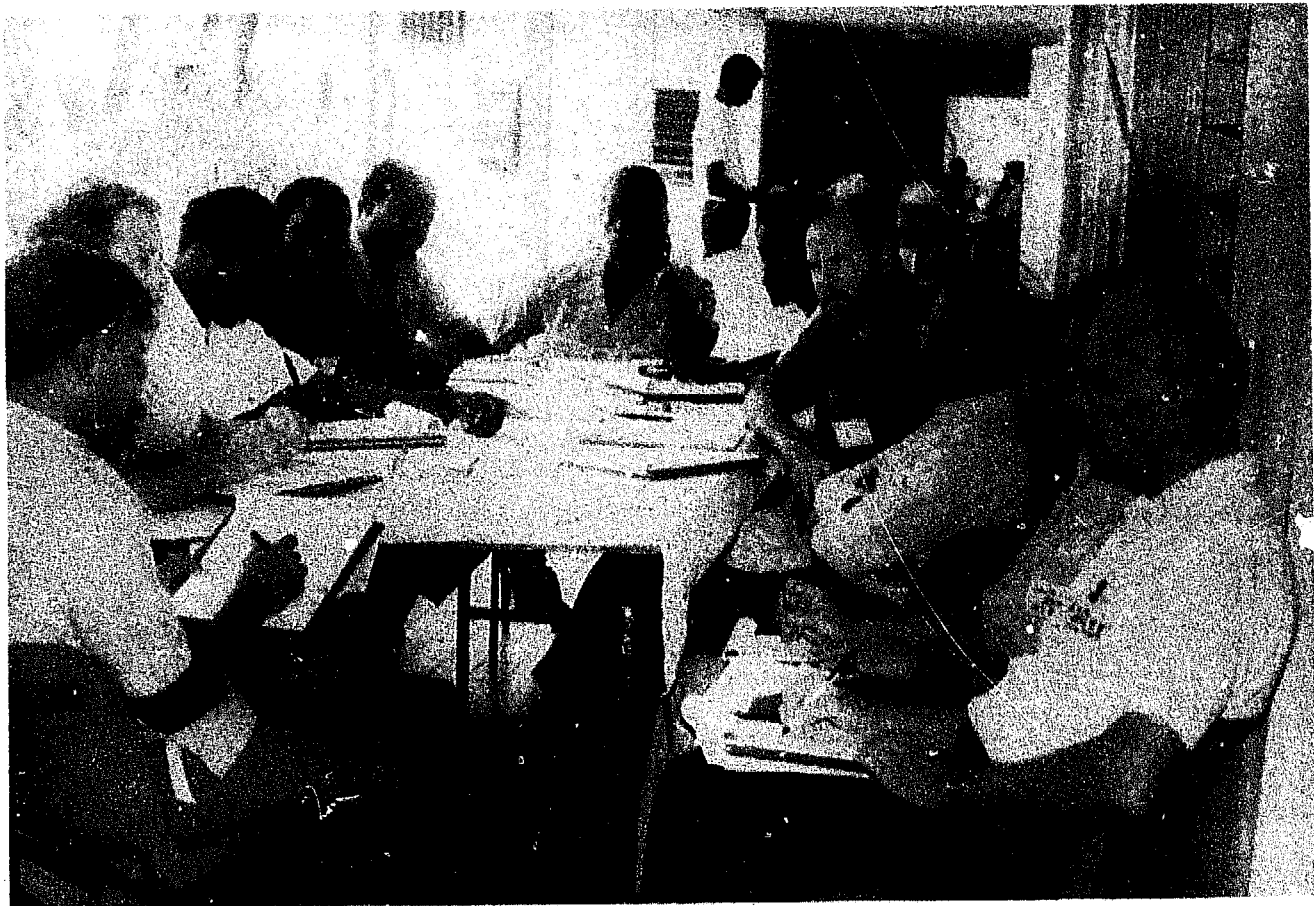

Soil conservation and tillage: the role of animal traction in establishing permanent cropping systems

Group chairman: R. Mungroop
Rapporteur: M. Klaij
Group participants: A. Conteh, M. Forster, H. Freeman, R. Gifford, M. Jambawai, S. Jarju, N. Jezzard, A. Kamara, B. Mansaray.

General

The subject is wide and site-specific but generalizations can be made. Developing bush into permanent cultivation systems involves soil and water conservation considerations at all stages of the process. The golden rule of soil conservation is to keep maximum soil cover, both in terms of time and space. Erosion starts with the impact of individual raindrops. These disperse soil particles which then block the larger pores in the soil, so that infiltration rates are reduced considerably.

There will be times where crop cover is minimal or absent and the extent to which this happens depends on the cropping systems and the technology level used. It is then that land formation and proper tillage methods play a decisive role in conserving soils. Environmental conditions vary greatly and each site will need a specific set of cultural measures to be taken. Soil management, soil tillage and cropping systems are interrelated and all together serve one aim: economic production whilst maintaining the productive potential of the resource base. Animal traction and appropriate implements can be employed for several soil conservation measures.

Land clearing

The slash and burning method of clearing small areas is relatively safe compared to the mechanized clearing. In the latter system, the heavy equipment used can compact the soil over large areas. Infiltration capacity is then reduced and root growth is affected, which can

lead to irreparable damage due to soil erosion. Brushing, felling, burning, destumping and raking have to be done. There is some potential for using animal power in conjunction with ropes and pulleys to assist with the felling and logging of trees during land clearance. There is greater potential for using animals for raking up of residues, an operation performed during the establishment of the farm of the ICRISAT Sahelian Centre in Niger.

Land formation

Terracing, levelling, bunding, and contour tillage were discussed. The diversity of ecological zones, slope, slope length, and the envisaged cropping technology determine which land formation type to apply. Very clearly there is great potential for use of animal traction and equipment to reduce the drudgery of hand labour in moving soil. Animal-drawn scoops, levellers, bundformers and a vast range of tillage equipment are currently being used in many parts of the world, and this is an area where animals can be used most effectively.

Cropping system

Maximum crop cover, in terms of time and space, can often be best achieved by mixed cropping. Intercropping and alley cropping have potential in farming systems using draft animal power. Cover crops can also be established using animal traction.

Conservation tillage

Conservation tillage is based on the central theme of keeping the soil in place so that it is not moved by wind or water. Crop cover and use of crop residues are important in achieving this. Animal traction has great potential not only because it substitutes hand labour but

also because many operations can be accomplished more quickly and therefore with greater timeliness. The ways and means to achieve this are again site-specific, and depend on cropping systems. Techniques for using animal traction and equipment need to be adapted to the cropping system, and *vice versa*. The cropping practices discussed included sowing, weeding and crop protection. Weeding deserves particular attention. Expansion of the sown area (associated with animal traction) leads to severe labour bottlenecks at weeding, particularly for the women, on whom this workload generally falls. Consequently weeding is often insufficient and untimely, and this results in considerable reductions in crop yields, compared with the potential yields. Proper combinations of tillage methods, row spacings and weeding equipment need to be selected. Weed control requires year-round effort to ensure that noxious weeds are not allowed to shed seed, as this leads to a build-up in weed populations over the years.

The option to use chemicals for crop protection is mainly important for (so-called) cash crops, such as cotton, groundnuts, cowpeas and some plantation crops. The use of animal traction for applying such chemicals appears limited.

Research needs and recommendations

- Much information is available on animal traction techniques and equipment, but most of this is found in various publications produced by international institutions and donor agencies. Several of these publications need updating and all need a wider circulation by the international community.
- Adaptive research, which is site-specific, needs to be done at a national level. Such research must involve the target group, in other words those farmers who are the end-users of the system.

- Local training programmes exist, but they may need to be expanded and intensified.
- Workshops, such as this networkshop or ICRISAT roving workshops, provide an excellent way of exchanging information on a personal basis, and this can often lead to further collaboration and joint action.

Discussion points

Many questions and comments expressed the concern and belief that tillage invariably leads to soil erosion and degradation, particularly tillage in dry soils. It was felt that tillage using animal traction *may* lead to soil degradation, but that with the careful selection of conservation tillage methods, soil productivity *can* be maintained at high production levels. The actual methods to use depend on each site and points to consider include the rainfall amount and intensity, the soil type, slope and the cropping system.

The subject of tied ridging was raised. Research trials had shown that in the semi-arid areas tied ridging can raise yields. Tied ridging is labour-intensive, but animals can be used effectively. Research on equipment and techniques for animal-powered ridging tying was being undertaken by ICRISAT and IITA/SAFGRAD, but it was too early to say whether the farmers would feel the enhanced yields would justify the extra work required to achieve them.

There were questions about terracing. While some participants thought it to be too labour-intensive for many applications, others thought that this problem could be overcome using animal power and appropriate implements.

It was noted that soil conservation techniques such as terracing and bunding often require considerable farmer cooperation. Examples of communal cooperation for terrace construction in Latin America were cited, as were the watershed committees formed in The Gambia.

The significant social implications of such co-operation were noted.

The need for integrating agriculture with animal husbandry was discussed in relation to the common observation that animals are often weakest at the time they have to perform most work. It was thought that, by planting forage plants or trees on slopes or areas likely to erode, farmers can both conserve their land and improve the condition of their animals.

The problem of destumping was raised, and it was wondered whether chemicals could be effectively used to speed up the decomposition of roots.

It was concluded that emphasis in research and extension should be on means of avoiding erosion, as prevention was both cheaper and easier than the measures needed to cure eroded landscapes.

The selection and development of animal-drawn equipment

Group chairman: G. Le Thiec
Rapporteur: R. K. Bansal
Group participants: L. Afantonou, W. Boie, E. Busquets, A. Diallo, S. Harouna, S. Hooke, R. Imboden, E. Koroma.

Context

Animal-drawn implements cannot be considered in isolation from crop production systems. For any particular region, crop or soil type it is essential to take into account operational requirements for agronomic and soil management practices.

Use of available designs

When selecting implements for testing, the potential of implements currently used by farmers should be evaluated. Only if locally available equipment fails to meet the needs, should new designs be introduced.

Evaluation of simple equipment

It is desirable to study the potential in West Africa for the simple wooden implements widely used in Ethiopia and southern Asia. They are made largely from wood, and could be made and maintained at low cost by local artisans with little upgrading of existing skills and facilities.

Use of wooden implements

While some group members favoured the development of wooden implements in West Africa, others felt that this would put further deforestation pressure on the precarious ecological balance of the Sahel.

A checklist of equipment selection criteria

- Available animals (species/breed, size/weight, pulling capacity).
- Soil type.
- Existing farming practices and cropping systems.
- Typical farm size.
- Equipment ownership patterns (individual/collective).
- Range of operations required and potential use of equipment during the season/year.
- Technical level of intended users and possible needs for training.
- Existing equipment.
- Existing manufacturing techniques used by local artisans or workshops.
- Possibilities for further developments (e.g. other parts/attachments) to achieve greater working capacity and additional applications.
- Financial conditions of farmers (yields, cash flows, profitability, credit worthiness, financial management abilities).
- Possibilities for renting out equipment to generate additional farmer income.
- Cost and availability of raw materials for fabrication.

Methodological stages for testing, evaluating and promoting equipment

1. Identification of needs: study of the farming system in which equipment will be used, and context of work for which it will be selected or developed.
2. Operational requirements: definition of exactly what the equipment is required to do.

3. **Specifications:** clear listing of weight, draft, size, working width (requirements, limits), affordable costs, technical level of users, maintenance requirements, working life.
4. **Study of options:** review of available equipment (locally or from other countries) that meets specified requirements. If none available development of new prototype or adaptation.
5. **On-station testing and evaluation** of selected design.
6. **On-farm testing and evaluation** with farmers.
7. **Standardization** of appropriate design, with formal drawings.
8. **Small batch production and distribution** to farmers.
9. **Further on-farm evaluation** with farmers to establish durability and suitability.
10. **Economic studies and assessment.**
11. **Large scale production and extension.**

In recognition of the diversity of conditions this checklist was made general to allow widespread applicability in different regions and countries. The pattern can be made more specific as details become known, and networking activities are implemented.

Networking initiatives

Synthesis and exchange of technical information. There is a need for greater information exchange. One practical way of achieving this would be to synthesize existing knowledge on different forms of equipment used in various countries and make it available to researchers and manufacturers in cooperating countries. This work might be carried out by consultants who could visit different countries to gather information on technical specifications, test results, conditions of use (soils, agronomic conditions), potential for further improvements and the costs of equipment available within West Africa.

Once this information is available and has been circulated to national research and development programmes and manufacturers in each country, these organizations will be in a position to assess their own requirements and specific requests for network cooperation are likely to emerge.

A regional meeting of experts involved in farm equipment development and representatives of manufacturers would promote linkages, and its organization should be considered as a specific networking activity.

Discussion points

Experience of the Asian Regional Network on Agricultural Machinery (ARNAM) was cited indicating that initially there had been great interest in prototype exchanges between the countries. However it became apparent that most prototypes were simply the result of on-station development that had little relevance to the farmers. Thus it became network policy only to exchange equipment designs that had been proven by farmer use, that were being commercially manufactured and which farmers were buying. It was also noted that it was often more instructive to arrange professional visits to a country with a potentially useful design, rather than send out an implement which might be received without knowledge of its background and context.

The fact that most West African countries have their own factories was noted and the importance of developing complementarity and cooperation was considered a vital and necessary network initiative. This could start with a regional meeting of manufacturers and agricultural professionals.

There was no consensus reached on the relative advantages and disadvantages of wood implements. While wood was not always readily available or cheap in the Sahel, the ability of wooden implements to be made and maintained by village artisans in Ethiopia and Asia

indicated potential durability and sustainability.

There was seen to be a need to strike a balance between the "engineer"-orientated approach that good designs can be produced and perfected on-station and the approach of "the farmer knows best". The former can lead to the production of technically good but economically or socially inappropriate designs, while the latter neglects the historically proven importance of persuasion and even salesman-

ship in the promotion of innovations. The value of private sector initiatives in designing and promoting equipment was stressed. However it was recognized that for reasons of social and political balance, rural development initiatives such as animal traction equipment development could not be left entirely to the private sector. The exact relationship between extension workers, government research stations and the private sector in terms of equipment promotion and subsidies could be a matter of sensitivity and controversy.

Animal management and health

Group chairman: K. Apetofia
Rapporteur: S. Ravindran
Group participants: W. McKinlay,
 S. Adeoye, A. Mansaray, M. Sesay, A. Kamara.

Introduction

It was the general feeling of the group that although the animal is, by definition, the key component of animal traction research and extension programmes, it is usually given very little importance. In general there is more emphasis on equipment, agronomic practices or socio-economic factors than on the animals themselves. This is probably due to the small number of veterinarians or animal scientists associated with such programmes.

The methodology adopted by the work group was to first identify some of the problems relating to animal management and health. Then some possible solutions, both at village and national level, were discussed. Finally some research priorities and needs for improved documentation and communication were identified.

Identification of animal health and management problems

The group noted that some of the major diseases of draft animals known to occur in West Africa were rinderpest, contagious bovine pleuropneumonia, black quarter, trypanosomiasis, external and internal parasites, footrot and deficiency diseases caused by nutritional shortages of key minerals. Although most of these diseases are common to other ruminants in West Africa it was considered that draft animals might be particularly at risk. This was because it was assumed that work stress may interfere with the immune system of draft animals, so that disease prevention and control for work animals are vital.

In most countries, animal traction projects emphasize the spread of work oxen technology to farmers without due consideration of the disease situation or the availability and quality of feeds and fodder in the prevailing farming systems. The manpower of the animal traction projects, especially at the senior technical level, is also grossly inadequate to monitor and service the needs of farmers relating to animal health and management.

The group highlighted the weak linkages between animal traction projects, veterinary departments and those concerned with extension in the field of animal husbandry. This in the past has resulted in the poor management of draft animals at village level, resulting in low work output and even deaths. It was noted that vaccinations against contagious and communicable diseases were often not practised on a regular basis due to shortages of supplies, and this could have catastrophic results.

Possible solutions at village level

The group felt that most of the problems in animal health originate from the poor sanitary conditions under which most cattle are maintained overnight. Therefore there is a need to improve the sanitary practices, especially the removal of animal dung or bedding on a daily basis, in order to reduce the populations of flies. The dung so removed can be utilized for making compost, and this is an area requiring extension advice and farmer training.

Local remedies at present used by farmers for controlling fly attack include the application of vegetable and mineral oils on the skin. These appear to give varying results. The use of a mixture of salt and wood ash in water as a remedy for ticks has been in existence in villages now for a long time. In the absence of veterinary services offering alternative solutions which are affordable by the farmers, the use of such local remedies may be encouraged.

The mineral deficiencies noticed among the work oxen in the region might be reduced if leguminous plants were to be intercropped in areas where animals graze. Provision of crop residues like groundnut hay and other leguminous hays can provide specific minerals as well as improve the overall nutritional status of the work animals. However the provision of mineral licks may be a superior solution, especially in areas of high deficiency.

Some solutions at national level

Before the utilization of animal traction technology is intensified it would seem advisable to conduct disease surveys to identify potential constraints. In those West African countries where this has not been carried out, special emphasis should be placed on defining the importance of trypanosomiasis and its vector the tsetse fly. In tsetse-infested areas, it is recommended that only trypanotolerant cattle should be promoted by animal traction programmes.

The veterinary laboratory facilities existing in most of West Africa are inadequate. It is therefore advisable to set up small veterinary diagnostic facilities in association with animal traction programmes, in order to diagnose and treat the diseases that are of special importance to draft animals. Where there is not already a major contribution from animal scientists, animal traction projects may need more technical supervision and guidance from specialists in animal health and management. Animal traction projects should be upgraded into permanent divisions or departments within the relevant agriculture ministry, to ensure long-term commitment to animal traction.

Tethering systems of animal grazing can be practised in villages to prevent crop destruction, but these are only really satisfactory if they involve improved pastures. Therefore improvements in the status and management of communal (or private) pasture land should be given priority within national animal traction programmes.

The use of cows for draft work in villages should be encouraged as it may become an important solution to the problem of obtaining and replacing animals for traction. However this should only be recommended for areas where good husbandry and management systems already exist.

Farmer instruction relating to animal traction should not simply deal with animal training and the use of equipment. The husbandry and management of work animals should be more strongly emphasized.

Research needs

- The nutritional requirement of work animals, both males and females, for varying levels of work output and in both tsetse-infested and tsetse-free zones is a subject of top research priority.
- Research on the utilization of cows as draft animals should be intensified.
- Quantitative and qualitative research on carcase and meat characteristics of draft animals may be necessary, since an increasing proportion of the beef consumed in West Africa is likely to originate from draft animals.
- Investigations into the usage of local remedies and indigenous herbal medicines for working animals should be continued.

Documentation and communication

An animal traction network should assist national programmes by identifying all current research programmes in the region that are involved with work relating to draft animals. A directory and bibliography relating to current and past draft animal research in West Africa should be produced and circulated by the Network committee.

To facilitate the exchange of information and ensure requests for information reach appropriate people, points of contact should be defined or established in every country (or

even within provinces, districts or projects if their size and activities warrant this).

Subject matter specialists working on animal traction should participate in exchange visits with their colleagues in the region, to facilitate the exchange of ideas, information and experiences.

There is a need for a quarterly or biannual newsletter to be published covering all aspects of animal traction in the Network area.

Discussion points

It was noted that there was very little information available on the use of donkeys or mules. Donkeys could be particularly important for assisting women in their work. This was an area requiring research and information exchange.

The disease problems of moving animals from one area to another were stressed. Examples were cited from Sierra Leone, Burkina Faso and Senegal of disease problems that followed the purchase of animals from other areas.

The need for *simple* methods of improving the nutrition and health status of animals was stressed. Crop residues seemed particularly appropriate. The importance of small quantities of nitrogen was noted, and this could come from legumes or even from urea, which is relatively cheap and available. Work by ILCA Nigeria on alley cropping and the development of forage banks was cited.

Some details were given of ILCA's work on the nutrition of draft animals in Ethiopia. In various trials it was noted that the smaller, local cattle needed less water, had a greater ability to digest local pasture and had fewer health problems than the larger crossbred animals. In general working animals could not eat enough poor quality diet (such as that of local pastures) to replace their energy requirements and so lost weight. Wherever practical, work animals should be brought into condition before the time they are required to work, to allow such weight loss from a position of strength. However, in one trial working animals continued to work well for several months, despite losing weight, indicating that cattle can be very resilient in the face of poor nutrition.

Research and evaluation methodologies for animal traction programmes

Group chairman: S. Reddy
Rapporteur: P. Serafini
Group participants: A. Berthé, A. Gedeo,
A. Faye, J. Jindia, B. Kanu, D. Kemp, B. Kehr,
A. Marong, J. Oxley, D. Phillip, D. Sarr.

General

Both research and evaluation studies relating to animal traction need a comprehensive approach to the whole farming system. Farming systems involve many interacting components and therefore require some form of global view and overall analysis.

There is a need to study and measure the impact of animal traction technology. One clear, overall measure seems to be the rate of adoption of a technology.

While economics are clearly important, there is a danger when too much emphasis is placed on economic issues at the expense of social effects. There should be some means of assessing social values such as prestige and status, which have a large influence on determining what technology is purchased. Oversimplified input-output statements should be avoided; for example, it is inappropriate to make generalizations concerning the ratio of oxen to land area, unless the crops and the intensity of cropping are clearly specified.

There is a need for some standardization of methodology; for example certain defined categories of measurements or data collection should be adopted by different research programmes to facilitate cooperation between programmes. Such common data sets could arise from group reviews of the results of various existing methodologies.

Recommendations

1. Guidelines for the comprehensive analysis of animal traction information based on farming system strategies need to be developed. Within this context the use of common data sets should be encouraged.
 2. Experimental treatments should be arranged to ascertain the relative performance of animal traction practices with other agronomic interventions, and particular importance should be placed on defining and measuring the *interactions* between the various components.
 3. At all level of experimentation, and *in every year* of an animal traction research programme, representative sub-sets of experimental treatments should be performed:
 - on-station at an operation level
 - on-station at a disciplinary level
 - on-farm, researcher managed
 - on-farm, farmer managed
- Thus on-station research should be replicated on typical farmers' fields at an early stage.
4. When planning or evaluating research, it is important to take into consideration the long learning periods associated with farmer adoption of animal traction technologies. Slow initial uptake does not necessarily mean that a technology is inappropriate.
 5. Methodologies and research activities should be discussed and reviewed by colleagues in several disciplines. Such group reviews should be regarded as an important component of animal traction workshops, and should enhance the quality of research activities within the countries of the animal traction network. Such cooperation should lead to the development of a more professional approach to animal traction research.

Discussion points

Animal traction research must be orientated towards the farmers, and be appropriate to the farming systems. Farmers' ideas should be sought out, but this should not be taken to imply that all innovative ideas have to originate from the farmers themselves.

It is particularly important that research be carried out at the same time on-farm and on-station. Many animal traction research programmes have presented technology to the farmers only after several years of on-station development, and have been disappointed because technology proved inappropriate to the different conditions and practices of the farmers' fields. Similarly on-station replications may help in the interpretation of on-farm trial results.

More work is needed on methodologies for socio-economic studies. It might be useful if the Network could assist in the preparation of guidelines for such studies.

While standardized data sets may be desirable, there is a danger in attempting to standardize, since local conditions are so variable that comparisons may become meaningless. Even within countries, an economic index such as the opportunity cost of a person's time varies enormously between locations and seasons, and between different gender and age groups. While there is much to be gained from information exchange between countries, it may be dangerous to try to make direct comparisons of the data from different locations.

Research and evaluation studies should take more note of the needs of development planners. This may mean the scope of the work, or simply its reporting, may have to be broadened to allow it to be more effectively used in determining national policies. While farmers are the ultimate end-users of research results, it is development planners that determine the policies that greatly influence whether or not a technology succeeds.

Social and economic aspects of animal traction use

Group chairman: P. Allagnat
Rapporteur: S. Jutzi
Group participants: F. Ndiame, S. Poats,
M. Sangaré, Y. Schwartz.

Low profitability

In general animal traction is insufficiently profitable to justify commercially orientated loans from banks and projects. The relationship between the costs of the inputs (equipment and animals) and those of the outputs (crop produce for sale) is usually unfavourable from the point of view of the farmer. Possible remedies for this problem include:

- Lower the price of inputs required to start animal traction.
- Increase the prices paid for farm produce.
- Modify the conditions governing loans, perhaps with credit subsidies.
- Improve farmer training to ensure farmers master the technology quickly and so gain full benefits from animal traction from the first year.

Cash-crop orientation

Since the input costs of animal traction are high, relative to the outputs, animal traction generally has to be promoted in connection with the more profitable "cash crops". This can lead to an *economically* acceptable balance of inputs and outputs, but one usually based on relatively *high-cost* inputs and outputs. An equilibrium based on a lower level of inputs would often be preferable. In order to achieve this, programmes might:

- Analyse the relative importance of the technical qualities of implements and the need for low costs.
- Clearly define the maximum cost of equipment that would be appropriate to the target groups. If high cost equipment does not appear to be economically feasible, then *afford-*

able implements should be promoted, even if they have a lower technical specification than more expensive alternatives.

- Define development strategies based on the low cost implements suitable for low-input, low-output farming systems, in order that the technology is not restricted to richer farmers.

Credit systems

Credit systems are seldom adapted to the needs of animal traction farmers. The adoption of animal traction is a long-term investment, which is often only profitable if the costs are spread over many years. This implies:

- Credit conditions relating to animal traction must be appropriate to the technology. This may imply longer periods before the first repayment is due, and longer overall loan periods than other loans. To allow this, interest rates may need to be subsidized.
- Alternative systems to allow farmers to obtain credit may be necessary. For example instead of concentrating on individual loans, credit might be provided to associations of farmers.

Extensification

The adoption of animal traction tends to lead to *extensification*, i.e. the cultivation of larger areas of land, rather than leading to the more *intensive* use of existing land. Insufficient attention has been given to techniques that can lead to more intensive production systems. This implies:

- Options for *intensifying* production with animal traction should be studied to determine the most profitable systems. This may require linear programming techniques.
- There should be promotion of operations and techniques (such as weeding) that encourage intensification of cropping, and not

simply operations (such as plowing) that may only lead to the extensification of the farms.

Multipurpose implements

Multipurpose implements that are expensive have often been promoted, but the utilization of the multipurpose functions has been disappointing. Most have only been used for primary cultivation, and single purpose implements for this are cheaper and simpler. Farmers have thus often had to repay large loans for multipurpose equipment even though the relatively high price of these has not been justified by the operations actually performed. This suggests:

- More emphasis should be placed on equipment that is cheap and simple, even if this implies single purpose implements.
- Where multipurpose implements have been promoted, more emphasis should be placed on farmer training to stimulate the multipurpose use of the implements.

Animal traction as an element in the farming system

Frequently, insufficient attention is given to the fact that animal traction is only one element among many within complex farming systems. The different elements are mutually dependent on each other, and the interactions need to be fully appreciated. The implications of this are:

- Animal traction activities should be coordinated with other development initiatives in an integrated, multidisciplinary way.
- In-depth, multidisciplinary surveys with a socio-economic component should be carried out prior to, and during, animal traction development initiatives. Such base-line surveys are essential to ensure the development programme is appropriate and orientated to the farming system, and, by continuing such surveys, feedback can be obtained as to the

impact of the programme on all aspects of the farming system.

Non-economic factors influencing animal traction

The acceptance and adoption of animal traction do not only depend on economic factors. Social considerations such as enhanced (or diminished) status, traditional gender roles, or changes in the drudgery connected with work can all determine whether or not animal traction is desirable. The implications of this include:

- Socio-economic studies should accompany animal traction programmes from the outset. These should include information on decision-making processes, and any effects animal traction has on the role of different social groups (women, children, hired labour), wealth distribution and attitudes. Reasons for the acceptance or rejection of various parts of the programme should be used for determining the future direction of the animal traction initiatives.

Definition of target groups for animal traction programmes

Animal traction programmes do not always have a clear idea as to the type of farm or farming family for whom the technology is intended. Within any area there are large differences between the sizes of farms, the numbers of people in farming households and the type of people who make key decisions. It is not realistic to expect all types of farm to adopt animal traction at the same time. The implications of this are:

- Animal traction programmes should study the various farm types in an area, clearly define their target groups and choose an approach that is appropriate for this group. This implies that the services of a sociologist are required at an early stage in any programme.

Specific recommendations

Social scientists should be more actively involved in animal traction programmes in order to identify the target groups, the financial implications of the technology and its social effects.

Social scientists should work more closely with colleagues in the more technical disciplines, such as agricultural engineering and animal science. This is particularly important in order to ensure that promoted technology is fully adapted to the social, economic and cultural realities of the target groups and their farming systems.

Credit programmes for animal traction need to be more flexible and more tailored to the particular and long-term nature of such investments. Alternative systems for providing credit should be more fully investigated.

Social scientists should have a more active role at both national and project level in suggesting or determining appropriate policies relating to animal traction, such as those relating to prices, credit and subsidies.

More effective exchange of information between the different countries in the region is essential to accelerate progress in developing and spreading appropriate and acceptable animal traction technologies.

Discussion points

Some of the components that lead to profitable use of animal traction were discussed. The difficulty in defining profitability was high-

lighted, particularly since animal traction may persist and spread even in areas where it appears to be intrinsically unprofitable. This may be associated with social benefits, such as reduction in drudgery, or hidden economic benefits, such as more profitable use of a farmer's time. Similarly there are hidden economic and social costs relating to animal traction, including the element of risk.

The potential profit that comes from resale of animals was highlighted, as was the associated need to provide some form of insurance for expensive draft animals, particularly those bought on credit. Underutilization of animals was a problem since the costs of maintaining animals had to be spread over a small number of operations. To solve this might require greater understanding of the links between the different components of the farming systems: for example improved marketing of produce through the use of animal transport.

The problems of emphasizing cash crops at the expense of staple food crops were discussed, but it was recognized that the families of farmers in areas where cash crops (such as cotton) were promoted often had standards of living above those of areas producing less marketable crops.

It was stressed that more attention needed to be paid to the clients of animal traction technology, rather than simply to the technology itself. A client-orientated approach would imply more emphasis on the social and economic realities of the farming systems and this should lead to more appropriate implements, credit packages and extension advice being offered.

Farmer needs for extension and training

Group chairman: C. Ladrette
Rapporteur: A. Westneat
Group participants: A. Bangura,
 B. Kouadio, P. Lekezime, S. Ouedraogo,
 A. Schumacher, D. Zerbo.

Introduction

The group underlined the critical importance of a comprehensive understanding of the rural milieu in which prospective animal traction farmers live and work. It was also recognized that individual farmers have different training needs. The group decided to identify those training topics which new, inexperienced adopters of animal traction might need. These were classified in five main groups: animals, equipment, land, use of animals on farms, and management. Some suggestions were also given for training strategies, extension services and research and development.

Farmer training topics

Animals

- Selection of suitable animals.
- Nutrition.
- Daily care.
- Animal health: problem of disease and preventive requirements.
- Animal housing and stables.
- Hygiene: stable, food, animals.
- Animal husbandry.

Equipment

- Farmers need to be presented with an overview of what is possible in the area concerned.
- Criteria which determine the appropriateness of each piece of equipment in relation to the local environment.
- Composition of the recommended package.
- Assembling equipment and taking it apart.

- Spare parts, anticipated wear on wearing parts.
- Maintenance, repairs, useable life.
- Accessories and their manufacture, including different sizes of yokes or harnessing systems.

Land

- Presentation of recommended standards for field sizes and total areas suitable for use with draft animals.
- How to define and lay out fields.
- Methods of destumping and land clearing.
- Anti-erosion techniques.

Animal traction techniques

- Training of oxen by the farmers themselves on their farms.
- *Progressive* training programme in undertaking different farming operations using draft animals.
- Agricultural techniques (clearing fields, plowing, cultivation, transport, fertilizer application, forage storage, etc.)

Management

- Planning for the agricultural season, work calendar.
- Standards of management.
- Principles of credit and reimbursement.
- Retiring and replacing animals.
- Financial management of the farm and the importance of savings.

Developing training strategies: points to consider

- Importance of adequate training for trainers.
- Location of farmer training: training centres good for demonstrations, but on-farm training more effective.
- Timing of farmer training: e.g. dry season when farmers not pressed.

- Training in literacy should accompany practical training.
- Technical follow-up, monitoring and evaluation: in this context farmers' associations may be encouraged.
- An inventory of past research must be made in each area before further research is planned.
- The technologies already available in the rural sector should be used as a basis for further development.

Training recommendations

- Extension agents should have a comprehensive knowledge of the rural environment and the type of farmers found there.
- Training must be highly practical and structured so that topics are covered progressively.
- Permanent systems of technical follow-up and evaluation should be established and should regularly reassess farmers' needs for further training.

Extension services

- A primary role should be to act as a two-way channel to provide feedback.
- Extension services should evaluate and respond to the expressed needs of farmers in order to assure the evolution of the technology, farm profitability and the living standard in farming communities.
- Assist farmers to have access to credit.
- Develop reliable supply systems for farm inputs. This may involve working with local blacksmiths.
- Promote the spirit of on-going training to farmers. This may include the production of documents in the local language and use of audiovisual materials.
- Ensure farmers know how to obtain further information: this may involve developing or strengthening simple communication channels.

Research and development

- Research is an indispensable tool in a development structure.

Discussion points

The training of trainers is particularly important. Extension workers should be closely associated with research programmes. Training should be a continuing process, with regular in-service training courses. To ensure good trainers remain in the service, there should be good career structures within extension departments. There should be prospects for professional recognition at all levels, with rewards or incentives (financial or through status) for effective field work.

Farmers can themselves be particularly effective trainers or advocates of a technology. Arranging visits by groups of farmers considering adopting animal traction to nearby farmers already using the technology may be especially useful. Farmers' associations can allow useful contact between farmers themselves and between the associations (or their leaders) and extension services and research workers.

More use should be made of mass media services, notably the radio. Farmers often listen to the radio and farming programmes can have an important impact. The media can also assist in the promotion of technologies among decision-makers. Since decision-makers and those with political power have often been educated in an environment where animal traction was regarded as a backward technology, the importance of convincing the authorities the advantages of animal traction should not be neglected. Indeed it may be vital in order to ensure that national policies are favourable to the development of animal power.

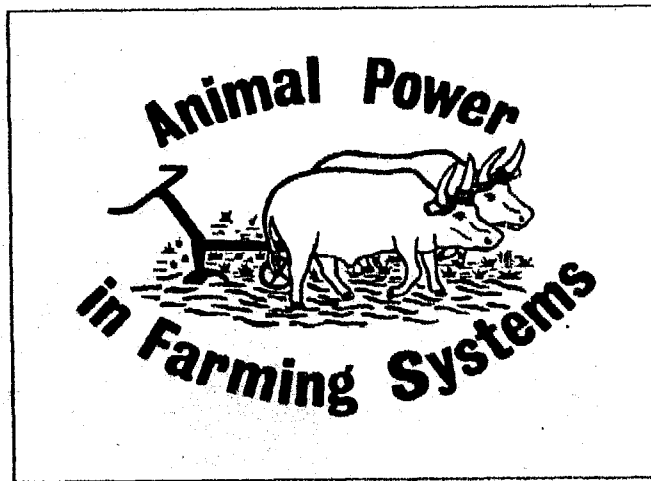

Conclusions, Evaluation and Follow-up



Title photograph (over-leaf)

West Africa Animal Traction Network Committee at planning meeting at Debre Zeit, Ethiopia in September 1987

(Photo: Fadel Ndiame)

Workshop conclusions and resolutions

Technical recommendations

The final workshop session was mainly concerned with the future of the Network and discussing organizational aspects of this. Most of the specific technical recommendations had been contained in the reports of the discussion groups. However two important technical recommendations that were restated during the final session of the workshop were as follows:

- It was recommended that animal traction projects in West Africa should adopt a more holistic or global attitude to animal traction development. This implied a farming systems perspective, so that, in addition to the technology being developed or promoted, greater attention should be paid to the *impact* of animal traction, the key *constraints*, and to social and economic issues.
- It was suggested that animal traction projects should give more attention to effective traditional animal husbandry practices, including indigenous remedies.

Recommendations for the Network

The following comments, suggestions and recommendations were made by the various discussion groups.

- This networkshop has already promoted useful exchanges of experience and other initiatives should further strengthen the cooperation. Follow-up activities should be investigated.
- The Network should stimulate the exchange of information and experiences through networkshops, such as the current one, and a newsletter produced every 3-6 months. There should be exchange of

prototypes between countries and the standardization of evaluation procedures.

- There were important networking opportunities for effective information and training exchanges between projects. Such exchanges would provide the shaping of valuable experience related to farming with oxen, the identification of common needs to make projects more effective and the stimulation of interest in ox farming that comes from visiting another's work.
- Networking would be most useful if liaison were mainly between groups operating within similar agro-economic zones. A newsletter should be produced. In addition to the periodic major meetings, such as the current networkshop, three types of networking activities were foreseen.
 - o Planning sessions for coordinated problem identification and definition, and for the elaboration of pertinent methodologies.
 - o Periodic informal on-site evaluations and discussions.
 - o Formal end-of-project evaluations producing written reports.

During the final workshop session it was specifically recommended that:

- The Network should be reinforced and strengthened. In particular, the options to formalize the Network with a secretariat and to produce a newsletter should be investigated.
- The Network should encourage and facilitate the holding of meetings on key problems of animal traction in the region. For example it was specifically recommended that a meeting should be held between those responsible for the development,

manufacture and promotion of animal traction equipment in the subregion.

Committee nomination

Nominations were made for the new steering committee. There was no formal election and all the following nominees were considered elected by acclamation:

- Adama FAYE, *Senegal*
- Stephen O. ADEOYE, *Nigeria*
- Kossivi V. APETOFIA, *Togo*
- Arthur S. GEDEO, *Liberia*
- Bai H. KANU, *Sierra Leone*
- Dawda M. SARR, *The Gambia*
- Abou BERTHE, *Mali*

The Committee's Technical Adviser (Paul H. STARKEY) was asked to continue to facilitate network activities.

The ILCA scientist designated to be responsible for ILCA's work relating to animal trac-

tion networking (Michael R. GOE) was nominated as ILCA's Representative on the Committee.

It was agreed that other relevant organizations, including international centres (such as ICRISAT), national research centres (such as CEEMAT) and donor agencies (such as GTZ), might be invited to send observers to committee meetings if they expressed particular interest in supporting the Network and its activities.

Role of the Committee

The committee was charged with planning a third animal traction workshop and preparing suggestions for the future structure and organization of the Network for presentation at the next workshop. It was suggested that the committee might meet in 1987 in Mali, Senegal or Ethiopia and combine a planning session with field visits.

Follow-up to the Workshop

Introduction

It is possible to make use of the time lapse between the workshop and the publication of these proceedings to add a brief note on follow-up activities. Initial brief accounts of the workshop were published in the FSSP Newsletter and ILCA Newsletter. The Network Technical Adviser started work on the workshop proceedings and the Institut Sénégalais de Recherches Agricoles (ISRA) allocated the services of an animal traction researcher for three months to help edit those workshop papers that had been prepared in French.

In the year following the second workshop, various information exchanges took place within the region, directly or indirectly stimulated by the Sierra Leone workshop. These were funded by a variety of organizations within and outside West Africa. Examples are the visit by Gambians to study the use of animal traction for rice production in Sierra Leone, and the visit by a Sierra Leonean to Togo to study animal health programmes for draft animals. Information was also exchanged through consultancy visits and the preparation and dissemination of reports and documents.

Activities of the Steering Committee

The Steering Committee met in September 1987 in Ethiopia to plan the Third Animal Traction Workshop and to discuss the future orientation of the Network. The meeting was funded jointly by ILCA and FSSP. The Committee reviewed the work of the Network and came to the following conclusions:

- The West African Animal Traction Network has not been formally established, but its existence has stimulated much exchange of information within West Africa, and between West Africa and elsewhere. The changes that have taken place can be

illustrated by the difficulty the organizers of the first workshop had in bringing together a representative group of West African countries, and the fact that the second networkshop had a broad attendance, with most West African countries represented by African nationals working in animal traction programmes.

- The Network has been open, with several different donor organizations funding the different activities. The first initiatives were taken by FSSP, but as this project neared the end of its funding period, other organizations have increasingly been involved. The lack of a single donor has meant that there has been no centralization or secretariat. This has made it difficult to clearly identify or focus what the Network is, and what it is achieving. It has also meant that much of the organization of activities has been undertaken by the Technical Adviser and the various donor agencies.
- To date, the Network has achieved many of the objectives set for it through Networkshop recommendations. In particular it has stimulated improved information exchange through meetings, publications and informal liaison. It has also made the relevant international agricultural research centres (IARCs), national agricultural services (NARS) and donor agencies aware of its existence, in such a way that many appear willing to assist with specific network activities. The Network has not yet been able to rapidly organize all its recommended activities. This appears largely attributable to the fact that no single person or organization is formally charged with Network coordination, and that all the persons involved in planning and implementing activities have their own very busy professional programmes.

The West Africa Animal Traction Network

At its meeting in September 1987, the Steering Committee discussed the present and future role of the Network. In the following extract from the Committee's report some ideas relating to Network structure and function are summarized.

Overall goal of the Network

The aim of the network is to improve the productivity and stability of West African farming systems, and the quality of rural life, through the appropriate use of animal traction.

Objective of the Network

The objective of the network is to strengthen the capabilities of those individuals and organizations directly or indirectly involved in appropriate initiatives designed to assist the introduction, intensification and diversification of the use of animal power in West African farming systems.

Activities of the Network

The Network promotes information exchange relating to animal traction research, development, training and extension. This is achieved through correspondence, exchange of documents, study tours, training visits, meetings, workshops and publications.

The Network organizes West African workshops, bringing together professionals from many different West African countries, international agricultural research centres (IARCs), aid agencies and other relevant organizations.

Present structure of the Network

The network is open to all concerned with the development of animal traction in West Africa. There is no formal procedure for membership, and so those individuals and organizations that cooperate in network activities may

be considered as the members of the network, without prejudice to their autonomy or status.

Organizations within West Africa participating in Network activities include government ministries, research and educational establishments, agricultural development projects, non-governmental organizations, equipment manufacturers, international research centres, sub-regional organizations and aid agencies. Organizations outside the region assisting or participating in Network activities include international and bilateral aid agencies, international and national research centres, universities, non-governmental organizations, development projects, and complementary networks.

The Network provides a broad framework in which many different activities can take place. Emphasis is placed on direct member-member contacts and cooperation between organizations in the region. Centralization of the network is limited, and many activities, including information exchange and study visits, are arranged directly between two or more of the Network members.

A Steering Committee is charged with planning major Network activities, including the West African Animal Traction Workshops. The committee at present comprises a multi-disciplinary team of seven West Africans nominated by the 1986 Animal Traction Workshop. A member of Animal Traction Thrust of the International Livestock Centre for Africa (ILCA) is invited to participate in committee meetings, and major organizations involved in network funding are invited to send observers. An expatriate specialist in animal traction currently acts as Technical Ad-

viser to the committee, and facilitates Network liaison.

Finance and support for Network activities come from a variety of sources. Initially most of the funding, technical and logistical support came from the USAID-funded Farming Systems Support Project (FSSP). More recently support has come from several organizations including ILCA, the International Development Research Centre (IDRC) of Canada, Deutsche Gesellschaft für Technische Zusammenarbeit (GTZ) GmbH and donor-supported projects within West Africa. It is considered that a broad spectrum of donor support is appropriate in view of the open nature of the Network.

The future of the Network

Planning and decision-making

The Committee considers it necessary for the Network to have formal statutes in order that a secretariat can be established to facilitate Network liaison. Specific proposals for Network statutes will be discussed by a working group comprising members of the Steering Committee and representatives of potential donor agencies. This group will meet at, or immediately prior to, the 1988 Workshop, and present its conclusions to a plenary session of the Workshop for possible adoption. In drawing up the statutes, particular attention will be given to the statutes and experiences of other networks.

Establishment of a secretariat

The Network will continue to be broadly based and emphasize direct contacts between members. However, a secretariat will be established to facilitate liaison. The Secretariat will be established in association with one of the organizations of the Network. The mandate of the Secretariat will be defined in the Statutes, and practical details will be determined by the

Steering Committee in discussion with the host organization and relevant aid donor(s). It is envisaged that in the first instance the Secretariat will comprise one bilingual West African expert in animal traction who has specific communication abilities. The expert might be assigned from the host organization, but this would not be a precondition. It is also envisaged that this person would be supported by a Technical Adviser, who may, or may not, be a West African national. The Secretariat would require logistical support in the form of clerical staff, computer and photocopying equipment, telecommunication facilities, and a budget that allowed for liaison travel.

Prior to the formal establishment of a Network Secretariat, the Secretariat of the biennial workshop may act as a temporary Network Secretariat.

National focal points for the Network

Within West African countries there will be designated network focal points to facilitate liaison. These organizations or individuals will assist network communications by receiving and disseminating information. While there will be no requirement that all Network communications pass through these focal points, it will be considered courteous if these are kept informed of relevant networking activities.

Steering committee

It is envisaged that the Steering Committee will continue to be elected at the biennial workshop. In the past there have been no fixed rules governing the size and composition of the committee, or the length of service. Prior to the acceptance of formal Statutes, the Committee proposes that following guidelines should be considered at the time of any election:

- The Committee should comprise experienced persons who are actively involved in animal traction research, development, training or extension.

- As far as practicable, there should be a balance between the different ecological zones of the region, between Anglophone and Francophone countries and between professional disciplines.
- The size of the committee should be such that it is relatively easy to arrange meetings, afford the costs of participation and small enough to be efficient at decision-making. A five-person committee might be most appropriate.
- The committee will be most efficient if all members understand both French and English.
- Continuity between an out-going and an in-coming committee is desirable.
- The country(ies) likely to host the next biennial workshop should be represented on the committee.
- When required, the Committee will be able to call upon the services of non-Committee members to facilitate its work.

Workshop evaluation

Introduction

At the end of the final session, immediately before the closing ceremony, evaluation forms in both English and French languages were handed out. It was explained that these were to be completed immediately and anonymously, in order to gain an impression of what participants thought were the stronger and weaker parts of the workshop. About fifteen minutes were allowed for them to be completed. A total of 55 forms were returned, 38 completed in English and 17 in French.

The answers were subsequently analysed by Jean Gearing, an anthropology graduate student of the University of Florida. Although Jean Gearing was working as a research assistant for Dr. Susan Poats of FSSP, she had no connection with the workshop, and was thus

considered a suitable person to analyse the evaluation forms objectively, without preconceptions or biases. Her detailed twenty-one page evaluation report included a numerical analysis of the fixed response questions, all the comments made by participants and her conclusions based on these comments. This report (Gearing and Poats, 1986) was circulated to all participants and supporting donor agencies. In the following sections the numerical results of the evaluation are presented in visual form, with data being converted to percentages for ease of comparison. Following this, a summary of the reactions to the more open-ended questions is provided, based on the evaluation report* of Gearing and Poats.

* Gearing, J. and Poats, S. V. 1986. Animal traction networkworkshop evaluation. Farming Systems Support Project (FSSP), University of Florida, Gainesville, USA. 21p. (E). (unpublished).

Participant evaluation of programme components

Question 1.

How would you rate the Keynote Address by Dunstan Spencer (Friday)?

* Note: Due to late arrival several participants missed the opening session.

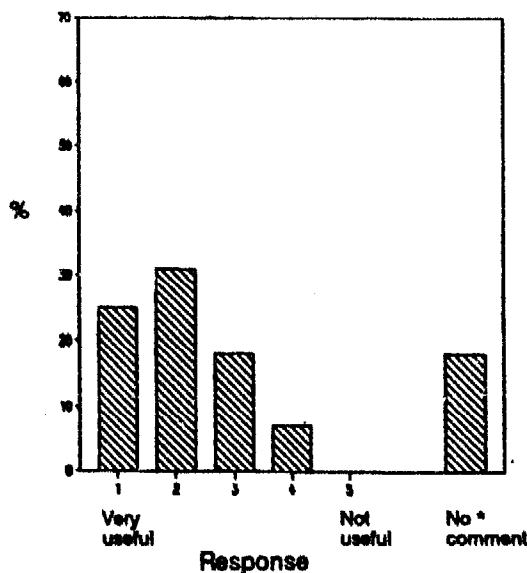

Question 2.

How would you rate the Keynote Address by Paul Starkey (Friday)?

* Note: Due to late arrival several participants missed the opening session.

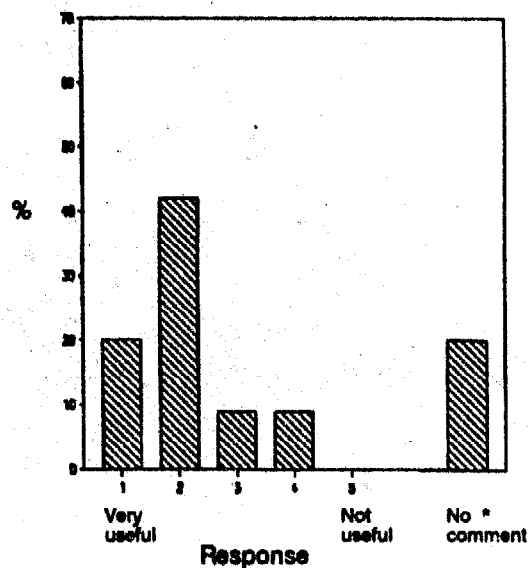

Question 3.

How would you rate the open networking session with participant introductions and announcements (Saturday)?

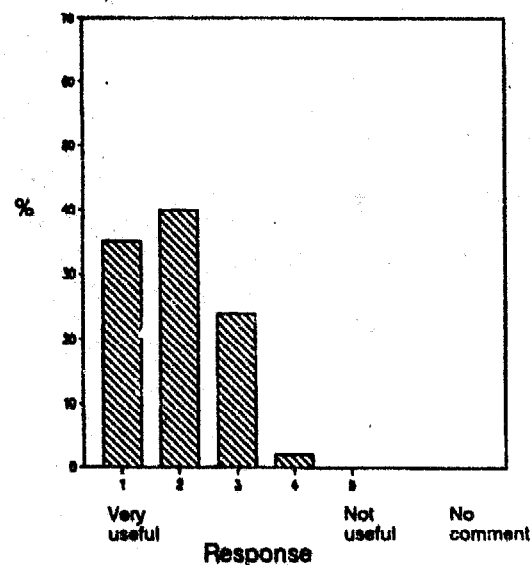

Question 4.

How would you rate the Work Oxen Project presentation (Saturday)?

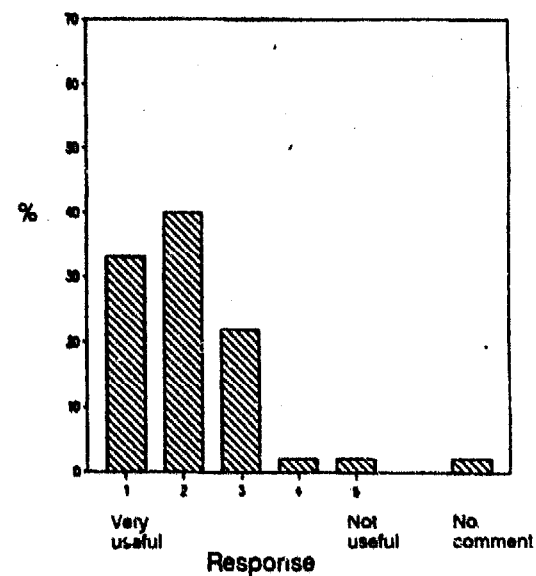

Question 5.

How would you rate the field trip (Saturday-Sunday)?

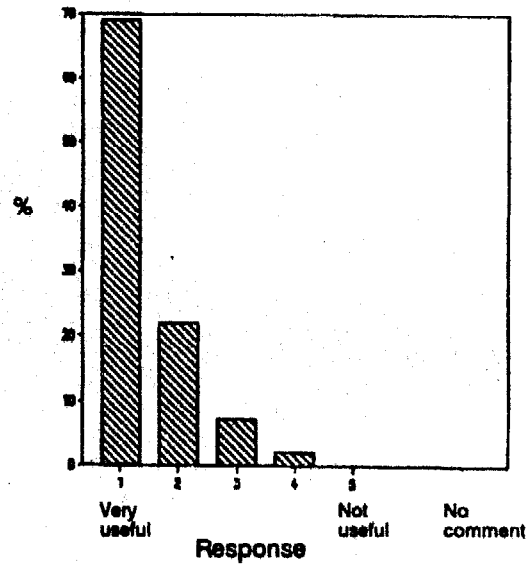

Question 6.

How would you rate the small group discussions about the field trip (Monday)?

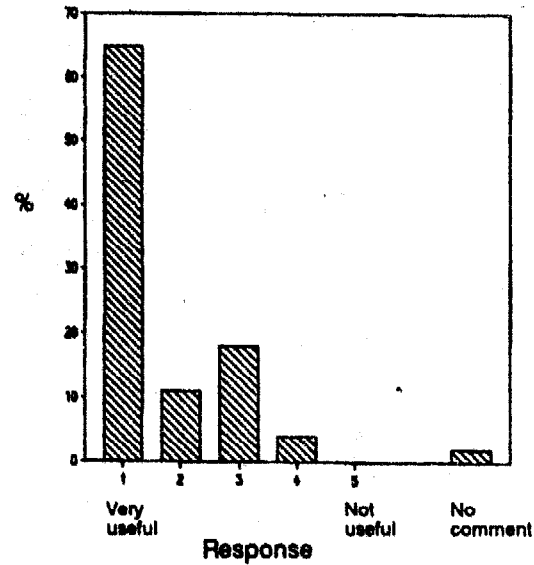

Question 7.

How would you rate the country presentations (Monday)?

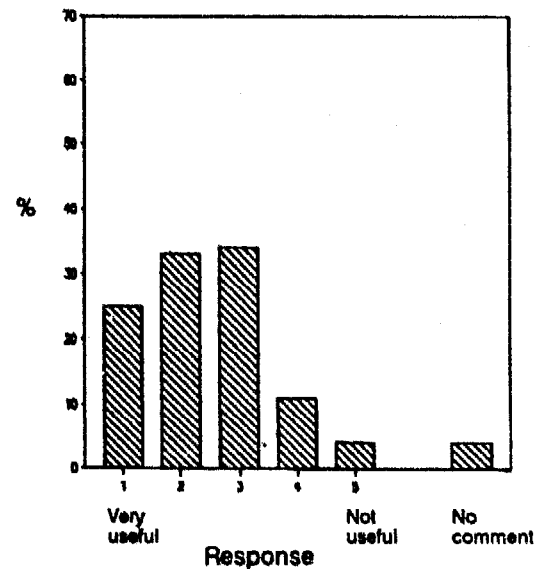

Question 8.

How would you rate the thematic presentations (Tuesday)?

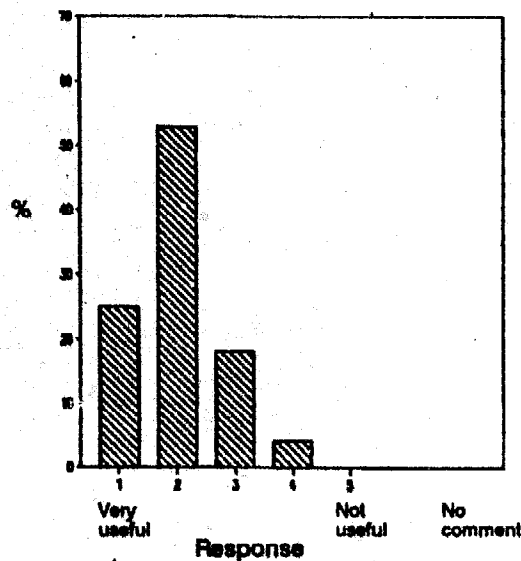

Question 9.

How would you rate the thematic discussions in small groups (Tuesday-Wednesday)?

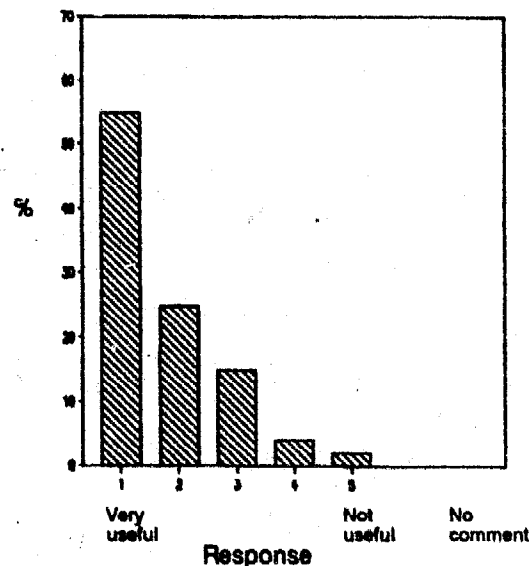

Question 10.

How would you rate the presentations and discussions of thematic groups (Wednesday)?

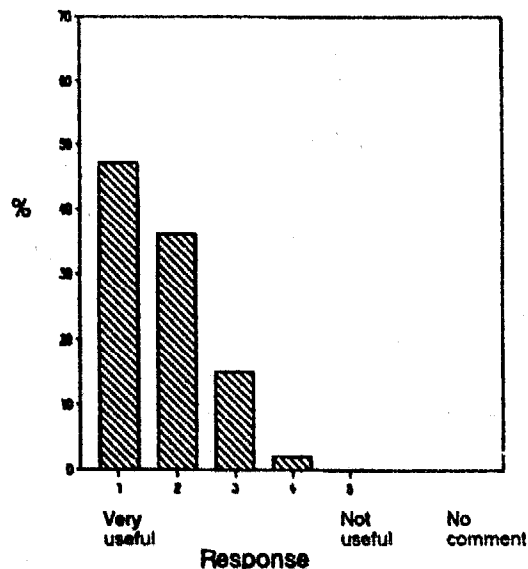

Question 11.

How would you rate the planning session for future networking (Thursday)?

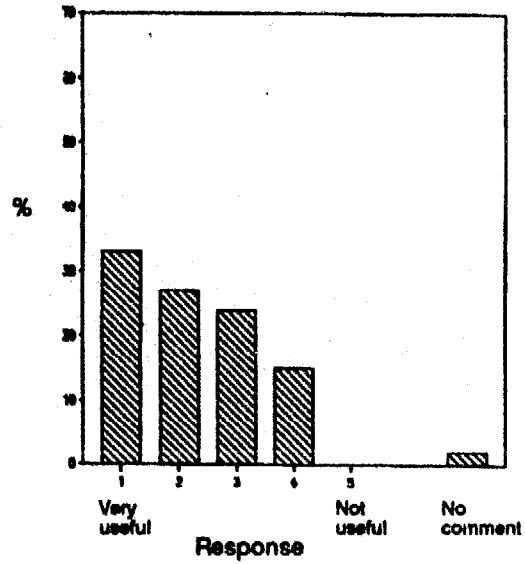

Question 12.

How would you rate the translation services?

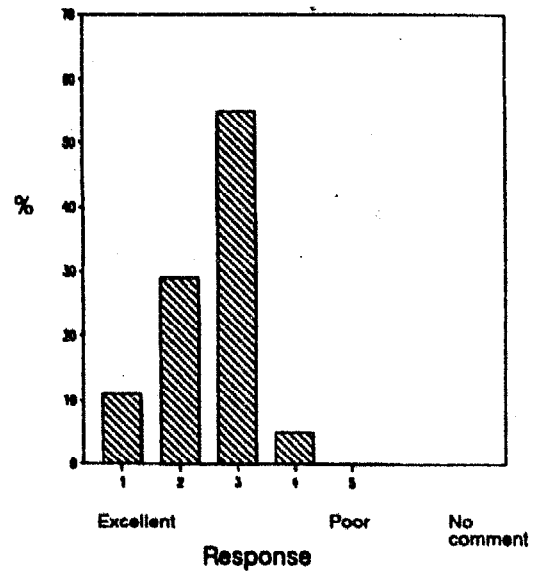

Question 13.

How would you rate the organization and logistical support for the workshop?

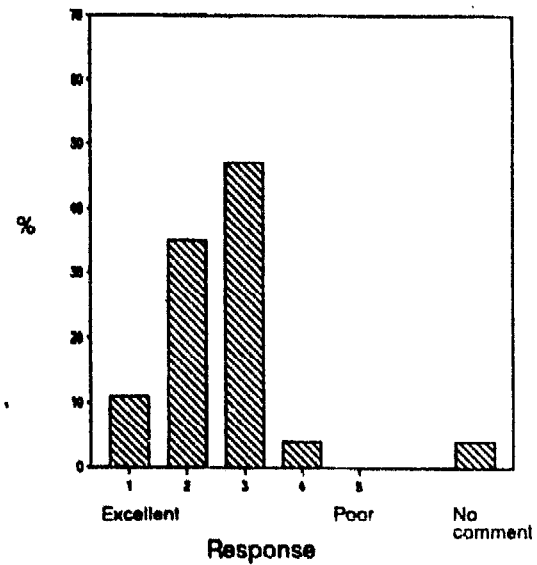

Question 14.

How would you rate the services provided by the Brookfields hotel for the Networkshop?

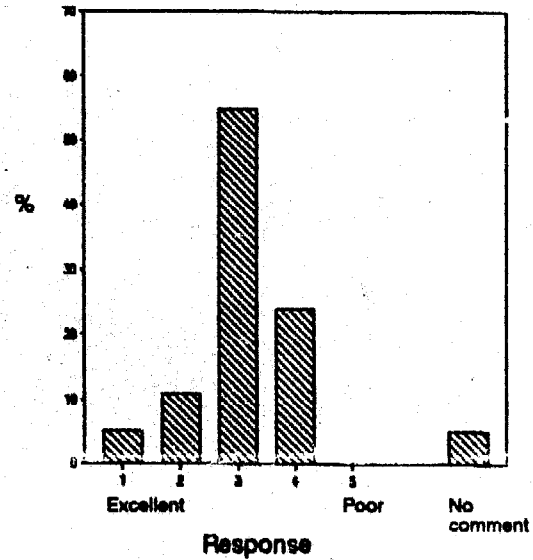

Question 17.

Overall, how would you rate the workshop?

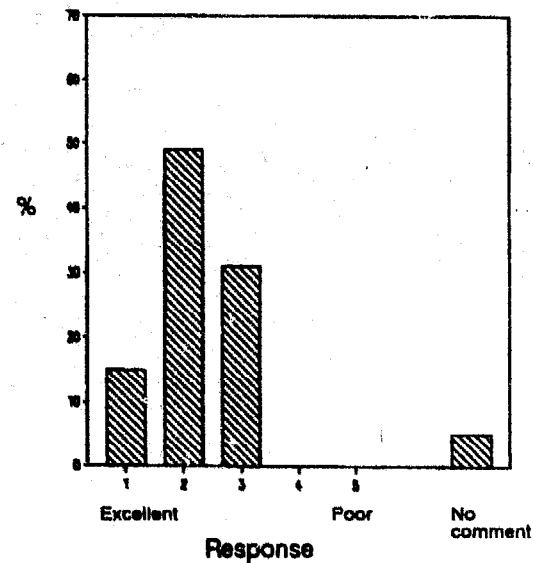

Question 18.

Would you like to attend the next networkshop?

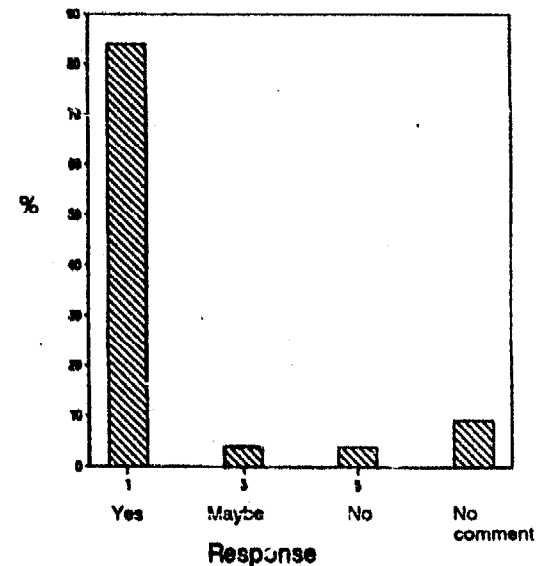

Comments of the participants

The following discussion presents the major themes which occurred in response to requests for:

- comments on the various workshop activities (Questions 1-11, as displayed in the bar graphs);
- comments about the organization and logistics of the workshop (Question 13, as displayed in the bar graphs);
- suggested changes to improve the workshop (Question 16: In your opinion, what would you change in order to improve the Workshop?);
- an overall evaluation of the workshop (Question 17, as displayed in the bar graphs).

Responses to all items tended to cluster around several recurrent themes. What one respondent may have listed under the request for additional comments on Questions 1-11, others listed under suggested changes (Q.16), under comments about logistics (Q.13), or under the overall evaluation (Q.17). Since there was this crossover, all of these items are discussed together. These themes represent the summarization of several individuals' comments and are not presented in order of importance.

Question 12, on the translation services, and Question 15, the request to name the most positive part or aspect of the workshop, elicited different kinds of responses and are discussed in subsequent sections.

Ways to improve the workshop

Programme elements

Recurrent themes in the amplified responses to Questions 1-11 included:

- shorten or even eliminate the country presentations;
- clarify the difference between country and thematic presentations;

- have discussion after country reports;
- have more time for thematic presentations and small group discussions;
- have more time for field trip and discussion afterwards;
- have fewer and more selective presentations and more discussions of each;
- narrow the focus of the agenda and make it more structured;
- rotate the role of the chairperson;
- allow more time for informal discussions, making contacts, and more time to rest and assimilate information;
- pre-schedule a donors' meeting and have prepared project summaries (for funding purposes) available.

Improving the logistics

Recurrent themes in the responses to Question 13 included:

- provide adequate physical support (electricity);
- make papers and documents available earlier and in greater quantity;
- make better use of steering committee;
- have different chairperson for each session;
- provide more time for discussions;
- have more rest time.

Suggested changes

Recurrent themes in the responses to Question 16 included:

- have more and longer field visits;
- have more time for questions and discussions after all presentations;
- summarize or make shorter country presentations;
- give more time to thematic presentations;
- have more technical or methodological presentations and fewer theoretical;
- increase the amount of small group discussion;
- present only selected papers and make them more focused;

- make agenda clearer and more focused, and have precise objectives for the networkshop;
- rotate the chairperson of sessions;
- have more rest time;
- give steering committee larger role and reduce the role of the expatriate technical advisers;
- formalize the informal contact-making activities which occur at the networkshop.

Overall evaluation

Recurrent themes in the responses to Question 17 included:

- have a few special presentations;
- reduce number of items on programme;
- rotate the role of chairperson of sessions;
- create a formal mechanism for inter-regional contacts between participants;
- have more time for discussion.

Translation services

Question 12 asked respondents to evaluate the translation services. Seventeen (17) or 31% of the respondents (8 or 21% of the English and 9 or 53% of the French) answered this item. The French to English translation received three positive and five negative comments. The English to French translation received three positive and six negative comments. Several respondents also mentioned that problems with the electricity hampered translation services. Overall, the translation services received mixed reviews and could have been improved.

The best part of the workshop

Question 15 asked participants to list the best part, or aspect, of the networkshop. Fifty people (91% of the respondents) answered this item.

The field trip was mentioned by 21 participants (42% of the respondents); it is also noteworthy that 50 participants (91%) rated the field trip as very useful or useful (1 or 2 on the scale) in the earlier part of the questionnaire.

Small group discussions were mentioned by 12 of the respondents (24%) and these were paired with the field trip by 6 respondents (12%). In the earlier questions, 42 respondents (72%) had rated small group discussions about the field trip as useful or very useful (1 or 2 on the scale).

The thematic discussions were considered the best part of the workshop by seven participants (14% of the respondents). In the earlier question, 44 participants (80%) rated these as very useful or useful (1 or 2 on the scale).

The presentations and discussions of thematic groups were mentioned by five (Francophone) participants (10% of the respondents). In the specific question on this part of the workshop, 46 participants (83%) had rated these as very useful or useful (1 or 2 on the scale).

The country reports were cited as being the best part of the workshop by only two participants (4% of respondents). The ratings of the country reports in the earlier part of the questionnaire were quite mixed: while 58% of respondents thought them very useful or useful, 39% rated them less than useful and two people (4%) classified them as being "not useful", a rare example of participants making use of the lowest category of the evaluation.

Other recurrent answers as to the best part or aspect of the networkshop referred to the networking aspects of the workshop rather than the actual programme components.

- Making contacts was mentioned by seven participants (14% of the respondents).
- The exchange of ideas, experiences, or technical information was mentioned by ten people (20% of the respondents).
- Informal discussions between participants were mentioned by four participants (8% of the respondents).
- The "integrated approach to animal traction presented"; the "spirit of openness"; and positive reassurance about the "value of animal traction" were each mentioned by single participants.

With the exception of one Francophone respondent who referred to "making contacts" the more general observations were made by Anglophone participants. Enthusiasm for the field trip and the small group discussions was shared equally by French- and English-speaking respondents. The Francophone respondents highlighted the thematic groups and presentations more than the Anglophone ones (nine Francophone respondents (53%) referred to the thematic groups and presentations while only 3 Anglophone respondents (8%) did so). Two English-speaking respondents indicated some confusion over the difference between thematic and country presentations and wanted further clarification on what was meant by a "theme".

Conclusion

It is clear that the majority of participants found the workshop valuable. In their overall evaluation 64% considered the networkshop to have been excellent or very good, and a further 31% felt it had been adequate. No one considered the workshop to have been poor or very poor. Only two people (4%) stated that

they did not wish to attend the next workshop, while 46 participants (84% of respondents) stated that they would like to attend the next networkshop.

Reviewing the recurrent themes for ways of improving the next networkshop, those more frequently mentioned included:

- having more time for the field trip;
- having more time for small group discussion;
- having fewer, and more selective, presentations, all followed by discussion;
- making the focus of the workshop narrower;
- rotating the role of chairperson;
- allowing more time for rest;
- creating some mechanism to facilitate making contacts between participants.

There was broad agreement that the visits to the villages, coupled with detailed discussions in small groups, had been particularly valuable. A further recurring theme was that the networkshop had allowed many informal contacts to be made and that these were probably at least as significant as the more formal presentation of papers.

List of participants

Senegal

M. Adama FAYE,
Chef du Centre de Recherches Zootechniques de
Kolda, Institut Sénégalais de Recherches Agricoles
(ISRA), B.P. 53, Kolda, SENEGAL.

M. Fadel NDIAME,
Chercheur, Economiste Agricole,
Département Systèmes, ISRA/Djibelor,
B.P. 34, Ziguinchor, SENEGAL.

The Gambia

Mr. Sidi M. JARJU,
Principal Soil Conservationist,
Soil and Water Management Unit,
Department of Agriculture,
Yundum, THE GAMBIA.

Mr. Alphu J. MARONG,
Senior Scientific Officer,
Rice Research Program,
Department of Agriculture,
Cape St. Mary - Bakau, THE GAMBIA.

Mr. Dawda M. SARR,
Department of Agricultural Engineering,
The Gambia College,
Brikama, Western Division,
THE GAMBIA.

Guinea

M. Alassane Kesso DIALLO,
Ingénieur-Machiniste Agricole,
Institut des Sciences Agro-Zootechniques de
Foulaya - Kindia,
B.P. 161, Kindia, GUINEE.

M. Robert DRAY, Conseiller Audio-visual,
Centre de Documentation Universitaire Scientifique
et Technique (CEDUST),
B.P. 1003, Conakry, GUINEE.
*or: CEDUST,
c/o Ambassade de France en Guinée,
Valise diplomatique, 37 Quai d'Orsay,
75007 Paris, FRANCE.*

Liberia

Mr. Arthur S. GEDEO,
Socio-Economic Officer,
Central Agricultural Research Institute (CARI),
Suakoko, P.O. Box 3929,
Monrovia, LIBERIA.

Mr. Samuel T. HOOKE,
Administrative Officer,
Central Agricultural Research Institute (CARI),
Suakoko, P.O. Box 3929,
Monrovia, LIBERIA.

Dr. S. RAVINDRAN,
Head of Animal Science,
Central Agricultural Research Institute (CARI),
Suakoko, P.O. Box 3929,
Monrovia, LIBERIA.

Côte d'Ivoire

M. Brou Pascal KOUADIO,
Responsable Culture Attelée,
Projet de Motorisation Paysanne,
Centre Ivoirien du Machinisme Agricole (CIMA),
B.P. 144 Boundiali,
COTE D'IVOIRE.
ou CIMA, B.P. 1193 Bouaké, COTE D'IVOIRE.

Togo

M. Ladikpo A. AFANTONOU,
Directeur,
Unité de Production de Matériel Agricole
(UPROMA),
B.P. 111, Kara, TOGO.

Dr. Kossivi APETOFIA,
Directeur, Projet pour la Promotion de la Traction
Animale (PROPTA),
B.P. 82, Atakpame, TOGO.

M. Pakoubatcho LEKEZIME,
Directeur,
Projet Culture Attelée Kara-Savanes,
B.P. 3, Kara, TOGO.

Mr. Arthur S. WESTNEAT,
Conseiller Technique,
Division Programmation,
Evaluation, et Statistiques, PROPTA,
B.P. 82, Atakpame, TOGO.

Nigeria

Mr. Hassan Usman AHMED,
Research Fellow,
Livestock Systems Research Project,
National Animal Production Research Institute
(NAPRI),
Ahmadu Bello University, Shika,
P.M.B. 1096, Zaria, Kaduna State,
NIGERIA.

Dr. Dayo O. A. PHILLIP,
Research Fellow,
Department of Agricultural Economics,
Ahmadu Bello University,
P.M.B. 1044, Zaria, NIGERIA.

Zaire

Mr. Andreas SCHUMACHER,
GTZ Staff member,
Compagnie de Développement Agropastoral Intégré
du Kwango-Kwilu (CODAIK),
11 rue Ituri, B.P. 7555, Kinshassa, ZAIRE.

Mali

M. Abou BERTHE,
Coordonnateur volet DRSPR-V/IER/USAID,
Institut d'Economie Rurale,
B.P. 9030, Bamako, MALI.

M. Christian LADRETTE,
Specialiste Culture Attelée,
SATEC/DEVELOPPEMENT,
24-26 rue Jean Duplessis, 78150 Le Chesnay,
FRANCE.

M. Ruben René MUNGROOP,
Chercheur DRSPR volet Fonséboougou,
Division de Recherches sur les Systèmes de
Production Rurale (DRSPR),
B.P. 186, Sikasso, MALI.

Dr. Sanath K. REDDY,
Senior Agricultural Adviser, USAID,
B.P. 34, Bamako, MALI.

M. Moulaye I. SANGARE,
Ingénieur Agro-Zcotechnicien,
Division de Recherches sur les Systèmes de
Production Rurale (DRSPR),
B.P. 186, Sikasso, MALI.

M. Dramame ZERBO,
Directeur, Division Machinisme Agricole,
Direction Nationale du Génie Rural,
Ministère de l'Agriculture,
B.P. 155, Bamako, MALI.

Burkina Faso

M. Soleymane OUEDRAOGO,
Ingénieur agronome,
Recherche sur les Systèmes de Production,
Institut d'Études et de Recherches Agricoles
(INERA), B.P. 540 Bobo-dioulasso,
BURKINA FASO.

Niger

M. Serkin Abzine Salifou HAROUNA,
Ingénieur d'Agriculture,
Artisanat Rural et Machinisme Agricole,
Projet Productivité du Département de Niamey,
B.P. 10231, Niamey, NIGER.

M. Roman IMBODEN,
Conseiller technique,
Artisanat Rural et Machinisme Agricole,
Projet Productivité du Département de Niamey,
B.P. 872, Niamey, NIGER.
*ou 50 rue Moutchoisy, 4207 Genève,
SWITZERLAND.*

ILCA

Dr. Samuel C. JUTZI,
Leader ILCA/ICRISAT/Ethiopia Vertisol
Management Project,
Highlands Programme,
International Livestock Centre for Africa (ILCA),
P.O. Box 5689, Addis Ababa, ETHIOPIA.

Dr. Stephen O. ADEOYE,
Animal Health and Production Research Officer,
Humid Zone Programme,
International Livestock Centre for Africa (ILCA),
P.M.B. 5320, Ibadan, NIGERIA.

IITA

Dr. Dunstan SPENCER,
Director, Farming Systems Programme,
International Institute of Tropical Agriculture, IITA,
P.M.B. 5320, Ibadan, NIGERIA.

ICRISAT

Mr. Ram K. BANSAL,
Agricultural Engineer,
Resource Management Program,
International Crops Research Institute for the
Semi-Arid Tropics (ICRISAT),
Patancheru P.O., Andhra Pradesh 502 324,
INDIA.

Dr. Michael C. KLAU,
Soil and Water Engineer,
Resource Management Programme,
ICRISAT Centre Sahélien,
B.P. 12404, Niamey, NIGER.

Mr. Philip G. SERAFINI,
Farm Manager,
ICRISAT Centre Sahélien,
International Crops Research Institute for the
Semi-Arid Tropics (ICRISAT),
B.P. 12404, Niamey, NIGER.

FAO

Mr. R. C. GIFFORD,
Senior Farm Mechanization Officer,
Agricultural Engineering Service,
Agricultural Services Division (AGS), F.A.O.,
Via delle Terme di Caracalla, 00100 Rome,
ITALY.

CEEMAT

M. Gérard LE THIEC,
Expert Traction Animale,
Centre d'Etudes et d'Expérimentation du
Machinisme Agricole Tropical (CEEMAT),
Parc de Tourvoie, 92160 Antony, FRANCE.

GTZ

Mr. Eduardo R. BUSQUETS,
Project Officer,
German Appropriate Technology Exchange
(GATE), GTZ,
Postfach 5180, D - 6236 Eschborn 1,
FEDERAL REPUBLIC OF GERMANY.

Mr. Burghard KEHR,
Dept. 17 - Agricultural Mechanization,
Agro-Industries and Food Technologies,
Deutsche Gesellschaft für Technische
Zusammenarbeit (GTZ) GmbH,
Postfach 5180, D-6236 Eschborn 1,
FEDERAL REPUBLIC OF GERMANY.

Projekt-Consult

Mr. Wulf BOIE,
Consultant Engineer, Projekt-Consult,
Savignystrasse 41, D-6000 Frankfurt /Main 1,
FEDERAL REPUBLIC OF GERMANY.

AFVP

M. Philippe ALLAGNAT,
Consultant, Association française des volontaires du
progrès (AFVP), B.P. 2, Linas,
91310 Montlhéry, FRANCE.

AFRC-Engineering

Mr. David KEMP,
Head of Animal Traction and Small Equipment
Section, Overseas Division,
AFRC-Engineering (*formerly National Institute of
Agricultural Engineering, NIAE*),
Wrest Park, Silsoe, Bedford, MK45 4HS.
UNITED KINGDOM.

University of East Anglia

Mr. Horatio FREEMAN,
Postgraduate Student,
School of Development Studies,
University of East Anglia, Norwich NR4 YTJ,
UNITED KINGDOM.

Mr. Nick JEZZARD,
Recent graduate of School of Development Studies,
University of East Anglia,
Norwich NR4 YTJ, UNITED KINGDOM.
*Present address: 2i The Millbank, Ifield,
Crawley, Sussex RH11 0JQ,
UNITED KINGDOM.*

FSSP

Dr. Susan POATS,
Associate Director,
Farming Systems Support Project (FSSP),
International Programs, 3028 McCarty Hall,
University of Florida, Gainesville,
Florida 32611, U.S.A.

Mr. Paul STARKEY,
Technical Adviser, Network Committee,
Animal Traction Development,
Oxgate, 64 Northcourt Avenue,
Reading RG2 7HQ,
UNITED KINGDOM.

Colorado State University

Dr. James W. OXLEY,
Professor of Animal Science,
College of Agriculture,
Colorado State University, 121 Shepherdson,
Ft. Collins, Colorado 80523, U.S.A.

Tillers

Mr. Richard ROSENBERG,
and Ms. Terry HLUCHYJ,
TILLERS Small Farm Program,
Kalamazoo Nature Center Inc.,
7000 N. Westnedge Avenue, Kalamazoo,
Michigan 49007, U.S.A.

Sierra Leone

Mr. Bai H. KANU,
Coordinator,
Sierra Leone Work Oxen Programme,
Private Mail Bag 766, Freetown,
SIERRA LEONE.

Mr. Abu Bakar BANGURA,
Head of Rolako Rice Station and Senior Extension
Officer, Sierra Leone Work Oxen Programme,
Private Mail Bag 766, Freetown,
SIERRA LEONE.

Mr. Jonas J. A. KOROMA,
Equipment Officer (Animal Gears),
Sierra Leone Work Oxen Programme,
Private Mail Bag 766, Freetown,
SIERRA LEONE.

Mr. Augustine SAMURA,
Research/Extension Officer, Kamabai,
Sierra Leone Work Oxen Programme,
Private Mail Bag 766, Freetown,
SIERRA LEONE.

Mr. Abdul M. SHERIFF,
Extension Officer, Northwest Region,
Sierra Leone Work Oxen Programme,
Private Mail Bag 766, Freetown,
SIERRA LEONE.

M. V. SCHWARTZ,
Research Officer (Socio-economics),
Sierra Leone Work Oxen Programme,
Private Mail Bag 766, Freetown,
SIERRA LEONE.

Mr. Wilson MCKINLAY,
Technical Adviser,
Sierra Leone Work Oxen Programme,
Private Mail Bag 766, Freetown,
SIERRA LEONE.

M. Hervé CORBEL,
Monitoring and Evaluation Officer,
Musaia Ox Unit,
Koinadugu Integrated Agricultural Development
Project (KIADP), Kabala,
SIERRA LEONE.

Present address:
7 place Pinel, Paris, 75013 FRANCE.

Mr. Alpha U. S. BARRIE,
Officer in Charge, Musaia Ox Unit,
Koinadugu Integrated Agricultural Development
Project (KIADP), Kabala,
SIERRA LEONE.

Mr. Scott M. LEAMAN,
Peace Corps Volunteer,
FAO Swamp Rice Development Project,
Peace Corps, Private Mail Bag, Freetown,
SIERRA LEONE.

Mr. Mathew L. S. GBOKU,
Lecturer, Department of Agricultural Economics
and Extension,
Njala University College,
Private Mail Bag, Freetown,
SIERRA LEONE.

Mr. Musa J. JAMBAWAI,
Lecturer,
Department of Agricultural Engineering,
Njala University College, Private Mail Bag,
Freetown, SIERRA LEONE.

M. Bruno LECAITEL,
(outgoing Equipment Officer,
Rolako Workshop, Work Oxen Programme),
c/o Association française des volontaires du progrès
(AFVP), B.P. 2, Linas,
91310 Monthéry, FRANCE.

Mr. Thomas Mark TURAY,
Farm Coordinator,
Mapaki Descendants Farming Association,
Diocesan Development Office,
Catholic Mission, P.O. Box 1. Makeni,
SIERRA LEONE.

List of Participants

Mr. B. S. MANSARAY,
Agriculturalist,
North Western Integrated Agricultural
Development Project, MANR, Kambia,
SIERRA LEONE.

Mr. I. B. KABIA,
Work Oxen Officer, Magbosi IAD Project,
Private Mail Bag 545, Freetown,
SIERRA LEONE.

Dr. Albert AGARD,
Chief of Party, ACRE Project,
c/o U.S. Embassy, Freetown,
SIERRA LEONE.

Dr. Jaswant R. JINDIA,
Agricultural Economist, ACRE Project,
c/o U.S. Embassy, Freetown,
SIERRA LEONE.

Mr. Knut HOLM,
Agronomist (GTZ),
Seed Multiplication Project,
P.M.B. 231, Freetown,
SIERRA LEONE.

Mr. Allie Badara MANSARAY,
Production Assistant,
Seed Multiplication Project,
P.M.B. 231, Freetown,
SIERRA LEONE.

Mr. Samuel Bockari KUGBEI,
Seed Centre Manager,
Seed Multiplication Project,
P.M.B. 231, Freetown,
SIERRA LEONE.

Mr. Alpha Bakai KAMARA,
Seed Centre Manager,
Seed Multiplication Project,
P.M.B. 231, Freetown,
SIERRA LEONE.

Mr. Alpha B. CONTEH, Farm Manager, Rokupr
Rice Research Station,
P.M.B. 736, Freetown,
SIERRA LEONE.

Mr. Edward Yamba KOROMA,
Agricultural Engineer,
Rokupr Rice Research Station,
P.M.B. 736, Freetown,
SIERRA LEONE.

Mr. Momoh B. SESAY,
Agricultural Instructor,
Swamp Rice Development Project, MANR,
Gbinti, Via Port Loko,
SIERRA LEONE.

Mr. Paul FRANCIS,
FAO Chief Technical Adviser,
Swamp Rice Development Project, Moyamba,
c/o UNDP, P.O. Box 1011, Freetown,
SIERRA LEONE.

Mr. Dramani Andrew TURAY,
Project Manager, NIADP,
P.O. Box 1435, Freetown,
SIERRA LEONE.

Part 2

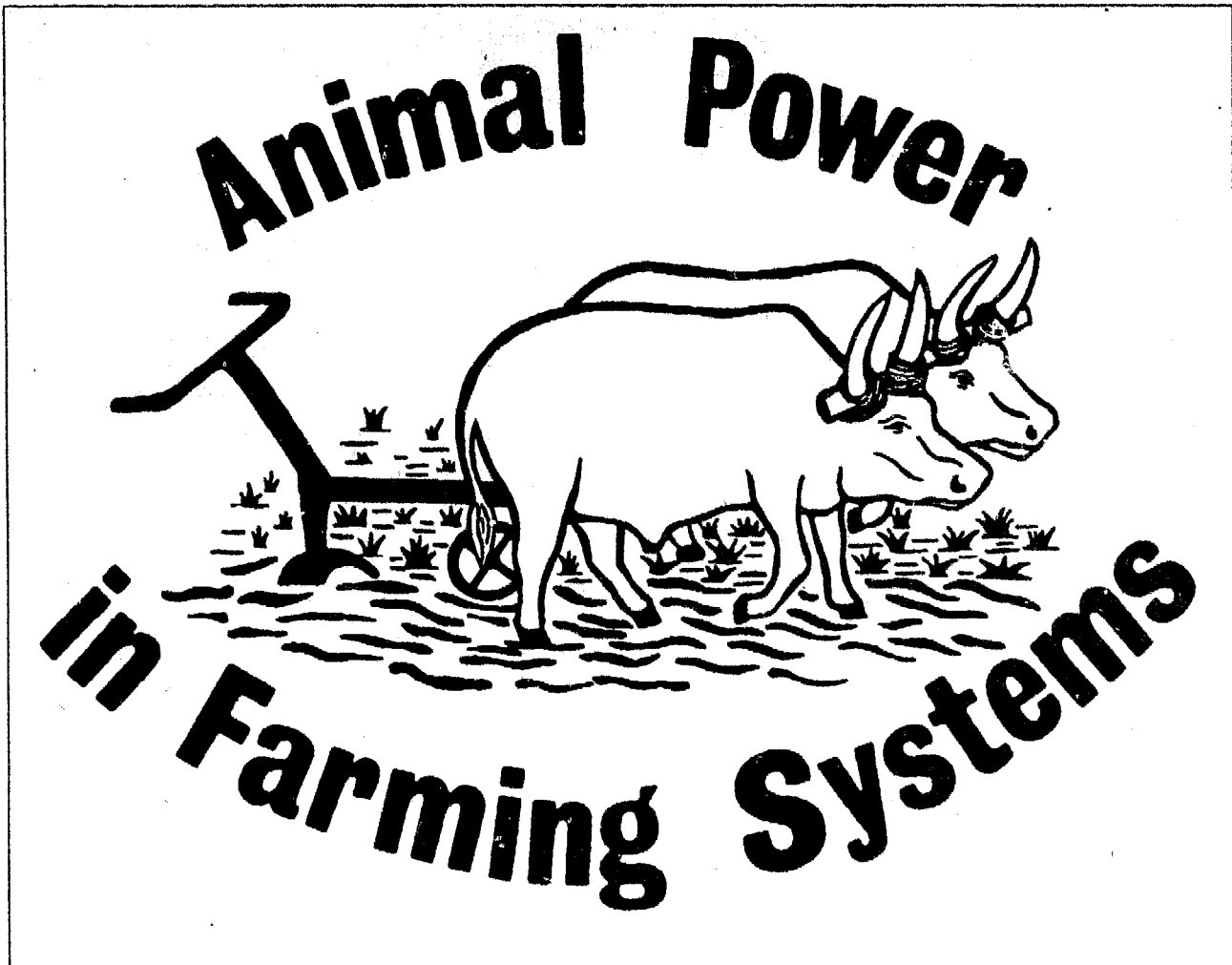

Papers prepared for the Networkshop

Title photograph (opposite)
Donkey cart and boy, Senegal
(Photo: Paul Starkey)

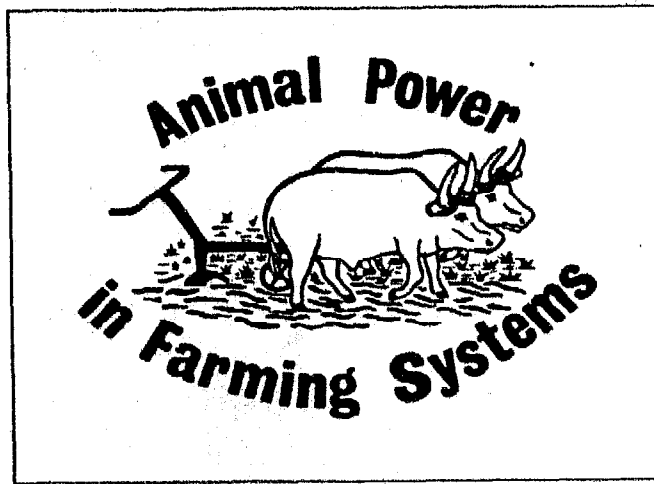

The Potential for Animal Power in West Africa



Farming systems in West Africa from an animal traction perspective

Keynote address

by

Dunstan S. C. Spencer

*Agricultural Economist and Director, Farming Systems Programme,
International Institute of Tropical Agriculture (IITA), Ibadan, Nigeria*

Introduction

In this address I intend to first of all describe what is generally accepted as Farming Systems Research and Extension (FSR/E) or Research with a Farming Systems Perspective (RFSP). Secondly, I will attempt to spell out the conditions under which animal traction as a technological innovation could be expected to fit into farming systems in West Africa, given the agro-ecological and socio-economic variability of the region. Next I discuss the chances of successfully introducing animal traction on a large scale into farming systems in West Africa. Finally I will briefly highlight some practical problems relating to on-farm studies incorporating animal traction.

Research with a farming systems perspective

The literature on farming systems research is quite voluminous. A vast array of terms and terminology has developed and each writer or speaker on the subject seems to coin a new term! But the general principles and activities in FSR are relatively few. Plucknett, Dillon and Vallaeys (1986) have in my opinion adequately described the objectives that farming systems research should aim to meet as follows:-

- To understand the physical and socio-economic environment within which agricultural production takes place.

- To gain an understanding of the farmer in terms of his or her skills, constraints, preferences, and aspirations.
- To comprehend and evaluate existing important farming systems, in particular the practice and performance of these systems.
- To enhance the capacity of research organizations to conduct research on priority problems.
- To conduct research on new or improved practices or principles and to evaluate these for possible testing on farms.
- To evaluate new or improved systems, or system components, on farms in major production areas under normal farm conditions.
- To assist the extension, monitor the adoption, and assess the benefits of improved farming systems.

It is now generally agreed that the above objectives could be met within the context of three interlinked multidisciplinary activity areas referred to as base data analysis (BDA), research station studies (RSS), and on-farm studies (OFS) (Plucknett *et al.*, 1986). BDA involves the collection, collation and analysis of data on the many factors characterizing the environment and farming systems of a region, with particular emphasis on the constraints facing farmers. RSS involve a focused research programme aimed at the development of components for the improvement of existing systems or for the putting together of new sys-

tems. OFS involve studies of existing systems, on-farm experimentation, studies of technology adoption, and assessment of the impact of new technology - all in relation to the farm household. It should be emphasized that research with a farming systems perspective is not only limited to OFS. It is an interactive process starting and ending on farm, but including on-station (component and farming systems) research.

I would also like to stress that although the name farming systems research might be rela-

tively new, the concept or approach is not new in agricultural research. E.T. York provided an example of such a program conducted by North Carolina University in the 1950's although it was not so named. The agricultural anthropology of de Schippe in the 1950's was a classic example of farming systems analysis although it did not involve on-farm tests, while the "Paysannats" in Belgian Congo incorporated a sort of on-farm testing of new farming systems by the Institut National pour l'Etude Agronomique du Congo Belge (INEAC) (Fresco, 1984).

Table 1. Francophone and Anglophone approaches to FSR

	Francophone R-D	Anglophone FSR
1. Objectives		
explicit mention of national policy	xxx	x
generation of technologies relevant to small farmers	x	xxx
ex-post analysis of technology adoption results	xx	x
2. Problem diagnosis		
interdisciplinary	xxx	xxx
emphasis on hypothesis formulation	xxx	x
holistic approach	xx(x)	xx(x)
time perspective	long-term, several seasons	short-term, rapid appraisals
3. Target group categorization		
farm enterprise as a unit of analysis	xxx	xx
socio-economic criteria for categorization	xx	xxx
geographical and physical criteria for categorization	xxx	x
4. On-farm experiments		
farmer participation	x	x
size of trial plots	entire fields	part of farmer's field
5. Types of interventions		
dissemination of technology	xxx	xx
spatial reorganization of agricultural production	xxx	(x)
organization of delivery systems	xxx	xx
scale	area/subregion	pilot
6. Institutional context		
close ties with/integrated in IARCs	x	xx(x)
linkages with extension services	xxx	x
links with (rural) development programmes	xxx	x

Note: x = degree of emphasis

Source: Fresco (1984)

Much has been written about the differences between the Francophone approach (*Recherche-Développement*) and the Anglophone approach to FSR/E. As is shown in Table 1, the similarities are much more than the differences, which appear to be one of scale and time frame (Fresco, 1984). This group should not spend any time discussing methodological differences. It is sufficient to accept the broad objectives of FSR/E, which are common to most programmes in order to proceed with an examination of the introduction, intensification and diversification of the use of animal power in West African farming systems.

Animal traction as a technological innovation

Farmer adoption of a technological innovation will depend on the degree to which the innovation reduces the unit costs of inputs used in the production process (Binswanger, 1986). Since unit costs depend on input levels per unit of output as well as on input prices, economic as well as agroclimatic and soil factors are important in assessing the potential for farmers' adoption of any technological innovation in a farming system.

If we define animal traction as the use of livestock (cattle, horses, donkeys and camels) as a source of power for transportation, field cultivation and processing, its effect on any farming system in terms of input savings per unit of output would be to save labour as crop area per unit of labour increases. Yield-increasing effects of mechanization are negligible (Pingali, Bigot and Binswanger, 1987), and therefore area required per unit of output is usually unaffected. This means that the savings achieved in labour input per unit of output must be more than offset by the extra livestock and equipment cost. Thus, the higher the wage rates in an area (cost of labour), the greater the potential benefits from animal traction.

Given the considerations above we can begin to examine the agro-ecological conditions and farming systems in which we could expect animal traction to be attractive at the farm level in West Africa.

Participants at the Togo workshop on "Animal traction in a farming systems perspective" considered four factors as important in developing a typology of animal traction in West Africa, namely, agroclimatic zone, livestock traditions, project influence and socio-economic resource levels. Using these factors and following Ruttenberg (1980) we could classify farming systems in West Africa into two broad categories, namely, natural fallow systems in which the land is left fallow for many years after a short period of cultivation, and permanent cultivation systems in which the soil is cultivated nearly every year and the proportion of area under cultivation in relation to total area available for arable farming is more than 66%. Natural fallow systems could be subdivided into forest, bush, savanna and grass fallow systems.

The distribution of the four natural fallow systems follow broad agroclimatic zones with grass fallows predominating in the Sahel zone, savanna fallows in the savanna, and bush and forest fallows in the forest zones of West Africa. Where population densities are high permanent cultivation systems such as intensive cultivation of valley bottoms and use of manure and other crop residues on uplands become important in all agro-ecological zones.

We can distinguish three levels of animal traction use, namely, use of livestock as pack animals, use in pulling carts, and use in field cultivation and post-harvest operations. The appropriateness of each level of animal traction for each type of farming system is discussed in the next section in relationship to the theme of the workshop.

Introduction, intensification and diversification of animal traction into farming systems in West Africa

As already pointed out, animal traction must have the potential of reducing unit costs of production in a farming system into which it is being introduced if it is to have much chance of success. This means that the saving in labour cost must be greater than the cost of the animals and equipment. Consequently the lower the capital and operational costs of the animals and equipment, and the higher the wage rates in an area, the greater the chances of successfully introducing animal traction.

Table 2.
Prospects for introducing animal traction

Farming System	Level of Animal Traction		
	Pack	Cart	Field work
Permanent Cultivation	xxx	xx	xx
Forest Fallow	x	-	-
Bush Fallow	xx	-	-
Savanna Fallow	xxx	xx	x
Grass Fallow	xxx	xx	x

Notes:

- No chance

x Poor chance

xx Average chance

xxx Good chance

There will be of course variations within the broad categories of farming systems in terms of unit costs of animal traction. The many factors that will affect these costs will be discussed during this networkshop and could only be precisely determined under actual farm conditions during on-farm tests. These include the actual labour supply in households, availability of adapted animals, household capital and credit, as well as availability of key services such as equipment supply and repair, animal

health, training, extension, and research (Starkey, 1986).

For purposes of introducing the discussions I have provided in Table 2 my evaluation of the *a priori* chances of introducing the three levels of animal traction into farming systems in West Africa. Considering that it is in permanent cultivation systems that wage rates are likely to be highest and operational costs of field cultivation are likely to be lowest because, for example, stumps have been removed over the years, it is in these systems that animal traction is likely to have the highest chances of being adopted by farmers. There is hardly any chance of adoption of animal traction for field cultivation in forest and bush fallow systems where the land is cropped for one or two years, stumps are left to encourage fallow regrowth and wage rates are likely to be quite low. There are only slightly higher chances of adoption in the savanna and grass fallow systems because resident populations are already familiar with livestock, and the sparse vegetation cover makes operational costs reasonably low.

Use of animals as pack animals has the highest chance of success in all farming systems since investment costs would be lowest as only an animal needs to be purchased and maintained.

In summary, I believe that the use of animal traction in field cultivation on a large scale should only be contemplated where permanent cultivation systems currently exist, i.e. where land is fallowed a maximum of one year in three. Use of pack animals may be considered in the other systems, particularly the savanna and grass fallow systems.

Consideration of issues relating to intensification and diversification is only relevant in farming systems in which animal traction is already utilized, i.e. in permanent cultivation or savanna and grass fallow systems. It would mean for example using pack animals for field cultivation or using oxen for weeding or post-

harvest operations where they are already being used for plowing.

As is the case for introduction into farming systems, intensification and diversification of animal traction use are not expected to increase yield or quality of produce. Consequently the rate of increase will depend, as with introductions, on their unit cost reduction effect. The lower therefore the cost of the change, the higher the prospects of its adoption by farmers. In this regard we can expect diversification into the use of animals in weeding, where they are already used in plowing, to be the easiest to extend. Movement from use as pack animals to use of carts or plows would be more difficult as that would entail greater increases in capital cost and operational costs, e.g. training animals to plow or increased nutritional requirements, etc.

On-farm tests of animal traction technology

As indicated earlier it is through on-farm tests that the unit cost effect of animal traction in farming systems can be measured. On-farm tests could be researcher-managed, jointly managed by researchers and farmers or completely farmer-managed. Researcher-managed trials are useful in examining the performance of a new technology under environmental conditions that are different from those of the experiment station, but it is in farmer-managed or jointly managed trials that the socio-economic effects of technological innovation are best evaluated.

Assuming that all the necessary base data analysis has taken place and it has been decided that some level of animal traction is likely to be a profitable innovation in the farming system, there would remain a number of practical issues to be addressed in the design and implementation of the tests. The steps to be followed in designing alternative production systems were discussed by Zanstra (1986) at the

First West Africa Animal Traction Networkshop.

It is well recognized that there is a long learning process involved in the proper use of animal traction, particularly for people unfamiliar with large ruminants. Even for people familiar with livestock the process may take four to seven years (Jeager and Sanders, 1985). The dilemma that arises relates to whether long-term farmer training should precede on-farm tests, or whether animal traction should be provided on a custom basis to farmers, thus reducing on-farm test to a measurement of labour-saving effects without observation of the farmer management effect, a potentially important bottleneck for adoption of animal traction.

Furthermore tillage may have important long-run effects on the physical and chemical properties of soils, particularly in the more humid environments. Such effects usually only become evident after three or more years of tillage even in permanent cultivation systems. Long-term monitoring of soil degradation and the measurement of the cost of soil fertility maintenance must therefore be included in the on-farm trials.

Also, as indicated earlier, the most important effect of animal traction is on the quantity and distribution (seasonality) of labour use. But labour is probably the most difficult input to measure accurately in West African conditions. This is due to the great variability in the type of labour used in terms of age and sex, and the multiplicity of contractual arrangements (family versus hired labour, daily wage or piecework, payments in cash and in kind, etc.).

The net effect of all the above factors is that on-farm trials with animal traction could be expensive, complicated and must be long-term in nature. This explains why such trials have tended to take on more of an extension or demonstration rather than a research focus in the past. But we must resist the temptation to go into widespread demonstrations before we

have verified and established the economic viability of the technological innovation. This workshop will provide participants with the opportunity to examine many of the practical problems related to on-farm tests of animal traction.

References

- Binswanger, H. 1986. Evaluating research system performance and targeting research in land-abundant areas of sub-Saharan Africa. *World Development* 14,4: 469-475.
- Fresco, L. 1984. Comparing Anglophone and Francophone approaches to farming systems research and extension. Farming Systems Support Project (FSSP) Networking Paper No. 1, International Programs, University of Florida, Gainesville, U.S.A.
- Jeager, W. and Sanders, J.H. 1985. Profitability of animal traction: field study in Burkina Faso. pp. 347-353 in H.W. Ohm and J.G. Nagy (Editors): *Appropriate technologies for farmers in the semiarid zones of West Africa*. Purdue University Press, West Lafayette, Indiana, U.S.A.
- Pingali, P. L., Bigot, Y. and Binswanger, H. P. 1987. *Agricultural mechanization and the evolution of farming systems in sub-Saharan Africa*. World Bank in association with Johns Hopkins Press, Baltimore, USA. 216p. (E).
- Plucknett, D.L., Dillon, J.L. and Yallaey, G.S. 1986. Review of concepts of farming systems research: the what, why and how. Paper presented at the International Agricultural Research Centres Workshop on Farming Systems Research, ICRISAT Centre, India, February 17-21, 1986, ICRISAT, Patancheru, India.
- Poats, S.V., Lichte, J., Oxley, J., Russo, S.L. and Starkey, P.H. 1986. Animal traction in a farming systems perspective. Network Report 1, Farming Systems Support Project, University of Florida, Gainesville, U.S.A. 187p. (E,F).
- Ruttenberg, H. 1980. *Farming Systems in the Tropics*. Clarendon Press, Oxford, U.K. 424p. (E).
- Starkey, P.H. 1986. Draught animal power in Africa: priorities for development, research and liaison. Networking Paper 14, Farming Systems Support Project, University of Florida, Gainesville, U.S.A. 40p. (E).
- Zanstra, H.G. 1986. The design and testing of improved livestock technology for mixed farms. pp. 165-187 in S. Poats et al. (Editors): *Animal traction in a farming systems perspective*. Network Report 1, Farming Systems Support Project, University of Florida, Gainesville, U.S.A. 187p. (E,F).

The introduction, intensification and diversification of the use of animal power in West African farming systems: implications at farm level

Keynote address by

Paul Starkey

Technical Adviser, Networkshop Committee
Animal Traction Development, Reading, United Kingdom

Abstract

In Ethiopia and North Africa, draft animals have been used for centuries, sustained by traditional services. In much of sub-Saharan Africa, systematic attempts to introduce animal traction to increase export crops started between 1905 and 1945. Almost all countries in Africa are now actively encouraging the use of animal power.

In Africa about 10 to 17 million draft animals are employed. Estimates are given of the numbers in use in different countries. In West Africa about one million draft cattle and 800,000 donkeys and horses are used for work. Most of these are found in the Sahelian and savannah zones, with the highest concentrations in central Senegal and central and southern Mali. In Africa, primary soil cultivation accounts for 90% of animal power usage. Less than 5% of farmers who plow with animals use seeders or weeding tines. Carts are used all year so their importance is greater than their numbers imply.

Single discipline, component, on-station research has generated technically excellent, expensive solutions to non-limiting factors. Examples include wheeled toolcarriers and large draft animals, which are unaffordable and unadapted to farm conditions. Research programmes should consult farmers from the outset, concentrate on limiting factors, and maintain economic and environmental realism.

In The Gambia an extension programme, based on training centres, started in 1955 and by 1975 it had brought work oxen into most villages. Between 1965 and 1985, donkeys became increasingly important. Donkeys are inexpensive and un-

likely to be stolen. The rapid adoption of donkeys involved major changes in harnessing equipment and cropping systems and these were achieved through farmer innovation, and not government intervention.

When animal traction is introduced, equipment should be selected that is simple, affordable, available and easily maintained. Animals should be well adapted to the environment and capable of existing on available resources. Animal traction involves investment in time and money and exposes farmers to increased risks. The social and economic costs and benefits of animal traction vary between gender and age groups and develop over a period of years. Where animal traction is clearly profitable, social constraints and unfamiliarity can be rapidly overcome.

Intensifying animal power can involve using draft animals for more cultivation operations or for transport. A wide range of implements is available. An association between the adoption of carts and the conservation of crop residues has been seen in several countries. Diversified uses include animal-powered systems for water raising and milling, water harvesting and the construction of ponds or terraces. These operations often require social cohesion.

Introduction and workshop orientation

The objective of this paper is to provide an overview of animal traction in West Africa, and also to introduce some of the workshop themes. The overall workshop theme of "the introduction, intensification and diversification of the

use of animal power in West African farming systems" was chosen by the Networkshop Committee at its combined meeting and study tour that took place in Senegal and The Gambia in November 1985. The committee decided that deliberations during this workshop will focus on the farm level implications of animal traction. The village discussions with farmers that are planned for the field visit should assist this orientation.

Four closely interrelated subthemes have been selected to help stimulate discussions: animal power equipment at the farm level; animal utilization and management at farm level; economic implications of animal power at the small farm level; and social implications of animal power at the farm level. At first it might seem that these topics, each closely associated with a single discipline, might discourage the holistic approach that is normally encouraged by those with a farming systems perspective. In fact it is intended that the small groups visiting the villages and discussing the workshop theme will be multidisciplinary. During the course of the workshop all participants should have an opportunity to consider, in greater or less detail, all the subthemes. For example it is anticipated that, in addition to their discussions in their own fields, the economists and sociologists will look at the problems of equipment and animal health, and also that the agricultural engineers and veterinarians will consider the economic and social implications of animal traction technology.

It is hoped that as the workshop develops, networking will be seen as a valid methodological component of research and development programmes. Networking through document exchange, study visits and workshops allows people to broaden their horizons, become more aware of the options, and build on each other's experiences. Study visits can benefit both sending and recipient organizations by stimulating, in a non-threatening way, self-assessment by both projects. Some of the benefits of study tours and workshops can be successfully com-

bined through network monitoring tours. Examples of these are the crop-livestock systems tours of the Asian Rice Farming System Network, coordinated by the International Rice Research Institute, IRRI. These have involved international groups of research workers travelling extensively for two weeks to farm sites in several locations in two countries, and combining discussions of the farming systems observed with presentations of the work being undertaken by the participants in their own countries (IRRI, 1985; Starkey and Apetofia, 1986).

The Farming Systems Support Project (FSSP) has, in the last 18 months, attempted to improve contacts between those working on animal traction in West Africa, and many of the ideas and examples cited in this paper can be traced back to previous networking activities in the region. For example, this paper will draw on three animal traction network publications produced in the last year: the proceedings of the animal traction workshop in Togo (FSSP Network Report 1, edited by S. Poats *et al.*, 1986), Networking Paper No. 14 (Starkey, 1986) which provided an overview of animal traction in Africa and the report of the visit of animal traction specialists in West Africa to Nepal and Indonesia (Network Report 3 by P. Starkey and K. Apetofia, 1986). The paper also benefits from the ideas and information exchanged during the network meetings in Togo and Senegambia.

Other organizations have also been promoting information exchange; for example, the Mano River Union has financed visits between animal traction programmes in Sierra Leone, Guinea and Liberia. Participants at this workshop are being funded by a wide range of organizations. It is hoped that the workshop will stimulate similar examples of cooperation between animal traction programmes in the region.

This workshop will be orientated to village level and the individual farmers. It is understood that such farmers are highly dependent on decisions taken by governments, projects, credit organizations and other institutions at a national level.

While it would certainly be most useful to exchange experiences concerning the organization and operation of development projects, national services and large-scale manufacturers, this is not the objective of the present workshop. It is hoped that, by focusing on the village level, implications for national organizations will become clear through identification of key constraints. However detailed discussion of national strategies may well have to wait for a subsequent workshop.

Overview of animal traction in Africa

The great diversity of Africa, geographically, ecologically, socially, economically and politically, makes meaningful generalization very difficult. Even within countries, there can be a great range of conditions, making global statements concerning animal traction in just one country fraught with problems. Yet there is a need to draw together experience from widely different farming systems. Thus while the danger of generalization and simplification is acknowledged from the outset, it is hoped that this will be offset by the enhanced understanding that can come from an overview.

An historical perspective

It is helpful to briefly contemplate the history of draft animal power in Africa, as this assists an understanding of some of the present constraints. The development of draft animal power in Africa has been considered in several reviews, including those of ILCA (1981), Munzinger (1982), Bigot (1985), Starkey (1986) and Pingali, Bigot and Binswanger (1987). In Ethiopia, the Nile Valley and North Africa, draft animals have been very widely used for centuries, and in many ways the well proven systems of utilization found today differ little from those used long ago. In these countries the plows, or ards, are made by the farmers themselves or by village artisans and they can be maintained in the villages. Apart from exceptional needs resulting from droughts or resettle-

ment, government services are not normally required to sustain animal traction technology. The training of animals is carried out by farmers, and transactions relating to implement and animal ownership involve mainly traditional sources of capital and credit. The use of animals for pack transport is also very common in Ethiopia and northern Africa. In several other parts of Africa, including Mali and Somalia, different cultures have traditionally used animals for carrying people or goods. However in most sub-Saharan African countries the use of draft animal power for crop cultivation is less than a century old.

In the nineteenth century, animal traction was widespread throughout Europe, and as missionaries, traders, colonizing forces and settlers came to Africa they brought with them the draft animal technology with which they were familiar. Animal-drawn carts generally came first, and these were used around many of the trading ports in the nineteenth century. In a few cases including Botswana, Kenya, Madagascar and South Africa plows were introduced before the beginning of the present century. In Madagascar and Botswana, the use of plows diffused rapidly, and plowing with animals rapidly became a standard practice for many of the smallholder farmers in these countries (Pingali *et al.*, 1987).

In most sub-Saharan countries, the first systematic attempts at the introduction of animal traction for crop production took place between 1905 and 1945. In the majority of cases the objective was to increase the production of export crops. In many parts of Francophone West Africa, including Burkina Faso, Cameroun, Guinea, Côte d'Ivoire, Mali and Senegal, private companies provided all the training, extension, credit and equipment necessary to allow very rapid rates of adoption of draft animals for cotton and groundnut production (Sargent, Lichte, Matlon and Bloom, 1981). For example, in Guinea, animal traction was first systematically introduced for crop production in 1919, in the flat savannah area of Haute Guinée to the

northeast of the country. The colonial administration and the French cotton company CFDT (Compagnie Française pour le Développement des Fibres Textiles) wished to increase the export of cotton. As a result of the extension efforts, the number of Guinean farmers using work oxen increased rapidly from 24 in 1919 to 790 in 1924. By 1928 over 4000 farmers were using oxen, with a total of 24,000 ha being plowed with animals (H. Verheaghe, personal communication). Today about 100,000 draft oxen are used in Guinea. Similar rapid and very localized expansion was seen in parts of Kenya, Uganda and Tanzania, also associated with cotton production (Kinsey, 1984; Pingali *et al.*, 1987).

Thus by the time of the second world war, animal traction was well established in several southern African countries, and was used in very specific and limited areas in most savannah regions of Africa. At this time most of Africa was under European administration, and it is important to understand the dramatic changes that were occurring in European agriculture at this time. The psychological effect of these changes directly or indirectly influenced policies in Africa for the subsequent three decades, including the period immediately following the emergence of new, independent states. In Great Britain, there were 11 million draft horses in use in 1910, but as tractor power developed this fell to 650,000 in 1940 and 370,000 in 1965. In France in 1940, there were 2 million draft cattle and 1.8 million work horses, but by 1965 this had dropped to 100,000 working cattle and 730,000 draft horses (Binswanger, 1984). Clearly, in European agriculture, animal traction was becoming a rapidly outmoded technology, and the universities and agricultural colleges naturally emphasized the new forms of mechanization and neglected animal traction. This had two major consequences. Firstly during the 1950s, 1960s and 1970s there were numerous attempts to introduce tractorization schemes in Africa, often with disastrous economic and ecological consequences. Secondly, a whole generation of African educators and

decision-makers had been trained in an environment (whether in Africa or Europe) in which it was generally assumed that animal traction was old-fashioned and of purely historical interest. Thus, in the pre- and post-independence periods, very many national policy decisions in agriculture were taken by people who considered any promotion of animal traction would be a U-turn back to the stone age (Argus, 1979). (This delightful phrase comes from an article written by a university lecturer who was criticizing attempts to introduce draft animals on the farms of Njala University College in Sierra Leone).

By the 1970s, most countries had recorded failures in over-ambitious tractorization schemes (Pingali *et al.*, 1987). Fuel crises were followed by chronic foreign exchange problems. Agricultural planners and donor agencies realized that the majority of the farmers in Africa still used hand cultivation techniques, and in most countries there grew a new interest in stimulating the development of animal traction. Interest of national authorities was complemented by donor support so that multilateral and bilateral aid projects proliferated (Sargent *et al.*, 1981). During the 1960s and early 1970s, few governments kept statistics relating to animal traction, and many writers and development workers claimed draft animal power was a badly neglected subject (Smith, 1981; Vietmeyer, 1982; FAO, 1982; Munzinger, 1982). Nevertheless attitudes were rapidly changing, so that by 1986 in almost all countries in Africa animal traction was being actively encouraged by government departments, parastatal organizations, major aid projects and non-governmental agencies (Starkey, 1985; Starkey and Goe, 1985; Starkey, 1988). Thus, if viewed from a continental perspective, relatively large amounts of public sector funds (African, international and bilateral) are now being channelled into the active promotion of animal traction, and related research and development activities. In a few countries, draft animal power is also being promoted by private manufacturing and commodity trading companies.

Since there is now a significant interest in animal traction, it is important to ensure that those resources being allocated to draft animal power are efficiently utilized.

A geographical and numerical perspective

North and Northeast Africa

While in the whole world there may be as many as 400 million draft animals (Ramaswamy, 1981), in Africa the total figure is only in the order of 10 to 17 million (ILCA, 1981; Anderson, 1984). Of these around 6 million are found in Ethiopia, where almost all the farmers in the highlands use draft oxen (Anderson, 1983; Gryseels, 1983). In Morocco, over one million animals are employed including oxen, donkeys, mules, horses and camels. In Egypt, about one million cattle and water buffaloes are used for work. Elsewhere in North Africa animal traction is also widespread in the small-farm sector, although the number of animals employed is smaller.

West Africa

In West Africa, there are three broad zones in which draft animals are used. In the north of the Sahel, where rain is less than 600 mm per year and arable farming is limited, most of the animals employed for work are donkeys, horses and camels, all mainly used for transport. Further south is an ecological belt running from central Senegal to Chad including northern Nigeria and northern Cameroun, where zebu breeds of cattle are widely used for crop cultivation. South of this zone, trypanosomiasis is a major constraint. Thus in The Gambia, southern Senegal, southern Mali, southwestern Burkina Faso and the northern parts of Guinea, Sierra Leone, Côte d'Ivoire, Ghana, Togo and Benin, where work animals are used, they are generally small, trypanotolerant taurine cattle. Equines are seldom used in these Guinea savannah areas and purebred zebus are rare. In the more humid zone, a belt stretching some

400 km inland from the southwestern and southern coastline, there are very few cattle of any breed and no equines.

In Mauritania, crop cultivation with animal traction is uncommon and probably only 4000 zebu oxen are employed. However donkeys, horses and camels are widely used for transportation. In Senegal over 30% of farmers use draft animals for cultivation, including about 200,000 horses, 130,000 donkeys and 100,000 cattle (Harvard, 1985). In The Gambia about two thirds of the farmers use animal power, and employ 30,000 donkeys and 18,000 N'Dama taurines (Starkey, 1986). In Guinea about 100,000 N'Dama are used for work (Bigot, 1983). Between 30,000 and 40,000 taurines and taurine-zebu crosses are employed in each of Côte d'Ivoire, Ghana and Benin (Bigot, 1983; Smid, 1982; Manigui and Medenou, 1986). In Togo about 7000 taurine and taurine-zebu cattle are employed, while in Sierra Leone about 1000 N'Dama oxen are used (Starkey and Apetofia, 1986; Starkey and Kanu, 1986). In Mali, about 50% of the farmers use animal traction, employing a total of about 400,000 draft animals: 200,000 cattle (taurines, zebus and crossbreds), 150,000 donkeys and 40,000 horses (DMA, 1986). In Burkina Faso 140,000 draft animals are employed by 10-15% of the farmers. About 80,000 cattle are used for cultivation, particularly in the southwest of the country, while the majority of the 60,000 donkeys and horses are used for transport in the central areas (Imboden *et al.*, 1983). In Niger about 16,000 zebu cattle are employed, together with 10,000 donkeys, while in Chad the figures are much higher, with 130,000 zebu cattle and over 50,000 donkeys. In northern parts of Nigeria 200,000 zebu cattle are used for work while the comparable figure for Cameroun is 55,000 (SODECOTON, 1986). In the central and southern parts of both these countries, the use of draft animals is rare.

Thus in the whole of West Africa about one million draft cattle and 800,000 donkeys and horses are used for work, in addition to a much

smaller number of camels. The great majority of the working animals are found in the Sahel and savannah zones, with very small numbers in the arid and humid zones. Overall, perhaps 10-20% of farmers in West Africa use draft animal power, with the highest concentrations in the cotton- and groundnut-growing areas of central Senegal, central and southern Mali, and the southern parts of Burkina Faso, Niger and Chad together with the northerly parts of Côte d'Ivoire, Ghana, Benin, Nigeria and Cameroun. All countries in the sub-region have research and development activities relating to animal traction.

Central Africa

In the forest zone of central Africa, there are very low cattle populations, and even fewer equines. Projects promoting the use of draft animals in northwest Cameroun and Zaire have experienced high cattle mortality, but have persisted due to the sustained interest of farmers and development agencies (Wagner and Munzinger, 1982; Starkey, 1984a). In most countries in the sub-region, both governments and non-governmental organizations are carrying out studies on the potential for draft animal power, and a few private agricultural companies are using work oxen. However, at present well under 1% of farmers use this technology.

East Africa

Animal traction is used in all countries of East Africa, but there are great differences between and within countries in the extent of its use. For example in Kenya, an overall figure of 12% of all farmers using a total of 700,000 working animals, mainly zebu oxen, derives from some areas, such as Machakos, where 80% of farmers use draft animals, and from other areas, such as the Maasai rangeland, where no cattle are used for cultivation (Starkey and Goe, 1984). In Tanzania around 600,000 East African Zebus are used for work, and cultivate about 15% of the cropped area (Kjaerby, 1983). In Uganda, about 600,000 draft oxen are used, particularly in the cotton-growing areas in the south. In

many parts of the East African sub-region, agricultural research stations, universities and agricultural projects are currently undertaking research and development studies relating to animal traction.

Southern Africa

Draft animals are used in all countries in southern Africa, and in Botswana 80% of farmers work with animals, using a total of 350,000 cattle and 140,000 donkeys. Cattle often plow in mixed teams of 6-12 oxen, bulls and females (Farrington and Riches, 1984; Starkey and Goe, 1984). In Malawi, about 70,000 work oxen are used, with adoption ranging from 60% in some areas in the north to less than 5% in the south (Starkey, 1985). About 500,000 oxen are used in Zimbabwe, where 15-20% of smallholders use animal power, and 180,000 are used in Zambia, mainly in the central and southern areas (Shumba, 1983; MAWD, 1985). In Mozambique, about 100,000 draft animals are employed, mainly in the south of the country, while in Madagascar, 330,000 draft oxen are used (Lexa, 1985; Tran van Nhieu, 1982). In central Angola, about 350,000 draft oxen are employed. Work oxen have been quite widely used for crop cultivation in Swaziland and Lesotho for many years, and in Lesotho donkeys and horses are commonly used for transport. Throughout the independent countries of southern Africa, and in Madagascar, development projects are currently promoting the use of draft animals, and several research studies are being undertaken.

From these generalized figures, it is clear that while there are differences between the present extent of draft animal power utilization in the different sub-regions and countries, there are also some important similarities. With the notable exceptions of Ethiopia and Botswana (and perhaps some central African countries), there are wide variations within each country as to the extent of adoption. While overall national figures are commonly in the order of 10-25%, these disguise large within-country variations,

with localized adoption rates as high as 80% being offset by other areas where fewer than 5% of farmers use animal power. In almost all countries, animal traction has been proven to be viable in certain (often undefined) circumstances, and therefore in each country innovative farmers could travel to see draft animals in use and could obtain basic advice and equipment. In almost all countries, there are full-time professional staff of ministries, projects, research stations and educational institutions that are currently devoting a great deal of time to development activities aimed at improving the use of draft animal power.

The range of operations

Having considered the numbers of draft animals in use in Africa, it is important to understand the extent to which they are used. Primary soil cultivation accounts for probably 90% of animal power usage, with probably three million maresha ards in use in Ethiopia, and a similar number of steel mouldboard plows in use elsewhere in sub-Saharan Africa. The majority of plowing is for dryland crops, notably maize, sorghum, groundnuts, cotton and teff. In Madagascar, parts of West Africa and in small irrigation schemes elsewhere, oxen are used for plowing and puddling rice swamps. In a few places in Africa, including northern Nigeria, ridgers are used instead of mouldboard plows. Senegal is unusual in that about 150,000 seeders and 70,000 groundnut lifters are in use (Harvard, 1985), but elsewhere numbers of seeders and groundnut lifters are very small. Throughout Africa, harrows may be used, but there may be ten plows for each harrow in use. While weeding implements are available in most countries, it is likely that less than 5% of farmer who plow with animals use weeding tines. While fewer than 10% of animal power users have carts, these may well be in use throughout the year, and so their importance may be greater than absolute numbers imply. In Ethiopia the use of animals for threshing by trampling is common, but this involves little time and no equipment. In some parts of the

Sahel and Botswana, animals are used to raise water from wells, and in a few countries in Africa oxen and mules are used in timber extraction. In Northeast Africa, animals are used for grinding and oil extraction, using traditional wooden mills.

It should be remembered that the majority of crop farmers in Africa still use manual labour for their farming. However it is clear that animal traction is becoming increasingly important in most sub-Saharan countries. At present most draft cattle are only used for plowing, an operation frequently restricted to one cropping period each year. As the ownership of draft animals necessitates investment in time and resources throughout the year, the lack of regular employment has major implications both for overall farm profitability and the standard of training of the animals.

Animal traction component research

Single discipline studies

Many countries now have multidisciplinary farming systems research teams, but in most countries such team work is a quite recent phenomenon. Historically, and this includes the time up to the early 1980s, most research relating to animal traction was carried out by single disciplines working in isolation. For example, in most countries those responsible for research on agricultural engineering and those responsible for research on animal nutrition and breeding worked in separate organizations, ministries or divisions, with few linkages or contacts between the professional staff. In such circumstances, it was common to find the agricultural engineers designing and re-designing plows and implements, while the livestock specialists concentrated on producing feed supplements or the genetic improvement of potential draft animals through breeding. Staff of both divisions strove to achieve excellence in their fields, and the results were often implements and animals of superb quality. However, all too

often, the research had little impact on the farmer, as it did not address the critical limiting factors, and did not take into account the fact that the farmers could not afford the cost of such high quality products.

Wheeled toolcarriers

Perhaps the best example of component research leading to unaffordable solutions is the wheeled toolcarrier, which has been developed and refined for three decades. Despite widespread and continued promotion by different development agencies in many countries in Africa, it has not yet been proven by farmer adoption. In The Gambia, several hundred wheeled toolcarriers were imported, before it was found to be too expensive and insufficiently manoeuvrable (Mettrick, 1978). Different designs were tried in Botswana, and after the initial optimistic suggestions that they would prove invaluable (Gibbon, Harvey and Hubbard, 1974; Mochudi, 1975), they were quietly rejected by farmers (EFSaip, 1981). In Senegal, wheeled toolcarriers have been commercially available to farmers for many years, but due to lack of demand, regular production has now ceased, and only small numbers are made to meet the requirements of research stations. In the past ten years, about 1000 wheeled toolcarriers, some ready-manufactured and some in the form of raw materials, were imported into Mozambique, but not used by farmers to any significant extent. Elsewhere in Africa, for example Ethiopia, Kenya, Malawi, Mali, Nigeria, Tanzania, Zimbabwe, wheeled toolcarriers have been evaluated and modified on research stations, but have not been recommended for farmer use. Altogether more than 5000 wheeled toolcarriers have been made in Africa or imported, but the number ever used by farmers as multipurpose implements for several seasons has been negligible. A similar combination of on-station success and on-farm rejection has been observed in India and Latin America (Starkey, 1987).

The problems of wheeled toolcarriers at farm level are seldom discussed in the literature, so that many people are under the impression that the technology has been widely adopted by farmers. There have been a few technical problems, and some designs have needed much modification, but most of the difficulties have been due to the differences between the conditions under which the equipment was developed, and the realities of the farms. For example farmers have often complained of the weight of the toolcarriers, which had been developed and tested using station-maintained animals that have been far bigger and stronger than village animals. Similarly farmers have complained of problems of manoeuvring wheeled toolcarriers around stumps, whereas these and other obstructions seldom exist on research stations. In many countries the wheeled toolcarriers have been rejected on the grounds of convenience or of economics. Some farmers who have been lent them for evaluation have been happy to keep them, but not to pay the real cost of the toolcarriers. Few farmers have used wheeled toolcarriers as multipurpose implements for long. After initial testing, most farmers have used them only in a single mode (plowing, cultivating or, most often, transport). Farmers have pointed out that it is preferable to own a simple cart and a simple plow than one combined implement. This is more flexible, more convenient and it reduces risk. Much time (and money) could have been saved had researchers spent more time discussing with farmers the technical and economic realities of their farming systems, rather than concentrating on the undoubted successes achieved on the research stations (Starkey, 1988).

Improved draft breeds

There are strong parallels between the development of wheeled toolcarriers and the development of improved draft animals. Both have tended to be the domain of a single discipline, both have been centred on research stations, and both have had strong donor support. In both cases, the goal has been excellence, rather

than adaptability and affordability. In several countries, including Côte d'Ivoire, Kenya, Madagascar, Malawi and Senegal, breeding programmes have produced crossbred animals that are clearly stronger than indigenous breeds, (Letenneur, 1978; Tran van Nhieu, 1982, Tessema and Emojong, 1984). However the crossbreds have inevitably required more maintenance feeding (Anderson, 1983; Tessema and Emojong, 1984), they have often been disease-susceptible (Letenneur, 1978), and have been more expensive (Tran van Nhieu, 1982). Discussions with farmers indicate that while strength may be desirable, vital characteristics of draft animals include the requirement to be relatively inexpensive, readily available and easily changeable, and animals must be able to survive using available and affordable feed resources and animal health services (Starkey, 1985). Thus, while farmers are often happy to benefit from the output of subsidized breeding programmes, such schemes are unlikely to be viable in the long term. This was seen in Senegal where little now remains of the draft animal breeding programme of the late nineteen sixties (Hamon, 1970).

The examples cited have involved agricultural engineers and animal scientists. However many comparable examples of component research giving rise to relatively expensive solutions to non-limiting factors could be cited in other disciplines, for example relating to the development of nutritionally excellent but highly expensive feed supplements, and even technically sound but excessively time-consuming training courses.

Lessons from previous methodologies

The most important lessons from these examples are that farmers should be consulted from the outset, that studies should be prioritized to address the key limiting factors, and that economic criteria must not be forgotten. It is also important that research should be carried out under conditions representative of the local farming systems. The multidisciplinary ap-

proach should include a careful assessment of the priorities for the farmer, and care should be taken that research subjects reflect the key constraints of the farmers, rather than simply the interests of the researchers. A strong element of economic realism should be integral within any research team, so that time is not wasted on developing technically excellent, but clearly unaffordable solutions. The methodology should be flexible and open-ended, being designed to seek solutions, rather than prove points. The studies should be highly development-oriented, with any data collection being merely a means to an end, rather than an end in itself, and measurements or assessments should clearly reflect those parameters important to the farmer. Wherever possible, research should be carried out on representative local farms, using resources that are available to, and affordable by, the farmer. Finally, research should be undertaken in close liaison with similar programmes elsewhere, to ensure that researchers do not duplicate studies unnecessarily, and that they build on each other's experience.

Animal traction in The Gambia

Introduction of draft oxen

In many West African countries at the present time, projects are attempting to introduce animal traction into different farming systems with very different success rates. The Gambia is a small country that has not had any long history of using draft animal power, and yet today over 60% of rural households use animal for work. It is therefore interesting to see how such innovative changes have come about, and what the implications may be for the introduction and the diversification of animal power in other countries in the region.

The first recorded systematic attempt at promoting working animals in The Gambia appears to have taken place in 1947, when a small

number of ex-servicemen were assisted to purchase oxen and steel plows. However the major extension thrust started in 1955, with the establishment by the Department of Agriculture of the first ox-plowing schools. These schools initially trained both young men and oxen for long periods of six to nine months, during which time accommodation and board were provided, and a small allowance paid. By 1965 there were 24 schools (subsequently known as Mixed Farming Centres) with 377 trainees. The period of training was gradually reduced, so that in 1965 it involved two months at the centre, the cultivation season on farm, with supervisory visits, and regular refresher training at the centre. Cattle had to be provided by the family or sponsors of the trainee but for the first season robust Emcot ridging plows were lent to the trainee. Small financial incentives were given to the trainees and trainers to encourage widespread use of the animals during the first season, and short-term credit was made available for purchase of seeds and fertilizer. Trainees, or their sponsoring farmers, were expected to purchase their own ridger by cash payment after the training period.

The initial impact of the ox-plowing schools was encouraging and the numbers of work oxen in use increased rapidly. Prior to 1955 very few farmers in The Gambia used draft animals. However the ox-plowing schools and extension programme during the period 1955 to 1970 brought animal traction into the majority of villages in the country. By 1975 about one third of farming families were using draft animal power and such a major change in just twenty years represents a small agricultural revolution. The importance of the formal extension programme was highlighted during a recent visit to The Gambia when farmers in fifteen villages all asserted that animal traction had started in their villages 17 to 20 years before as a direct result of the Department of Agriculture programme, and that prior to this extension programme no one in their families had ever tried to use work animals.

Diversification and donkeys

From 1955 to 1976 training had been based at Mixed Farming Centres and involved only N'Dama work oxen. In 1977 it was decided to start a programme of village-based farmer training, in order to reach more farmers. At the same time it was decided to allow extension staff to assist in the training of donkeys and horses. In contrast to the initial, highly innovative decision of the Department of Agriculture to promote oxenization, the decision to train donkeys and horses was an example of the extension staff responding to the farmers' own innovation. Up to this time all government reports had referred to oxenization and ox-drawn implements. Donkeys and horses had not been used or trained at Mixed Farming Centres, and animal traction research involved only N'Dama oxen. However farmers, on their own initiative, had been increasingly using donkeys and horses for work, often obtaining the animals and harnessing from private traders in Senegal.

The 1974 the Agricultural Census put the number of oxen or bulls in use at 44,000 and the donkeys and horses at 10,000 and 5000 respectively. Thus already by 1974, 25% of compounds were using donkey power, primarily for seeding. In one area there were more donkeys in use than oxen. The numbers of donkeys in use have risen very rapidly, and there are now estimated to be 30,000 donkeys working in The Gambia while the number of oxen has dropped to about 18,000. Figures for 1983 put the national figures at 38% of compounds using oxen, 44% using donkeys and 13% using horses (these figures are not exclusive and some farmers will be in more than one category). Thus during the period 1965 to 1985, donkeys changed from being of minor importance to their present status of the dominant draft animal of The Gambia. This rapid change, almost another farming revolution, appears to have come about almost entirely through farmer innovation rather than extension effort, and illustrates clearly how quickly a technology can

spread without government intervention if farmers see it to be profitable.

Reasons for preferring donkeys

The increasing popularity of donkeys was largely due to their low cost. The meat of donkeys is not eaten in The Gambia and surplus donkeys from Senegal could be bought for US\$15-25. On the other hand oxen, which are valuable for their meat, cost US\$100-170. However it was not simply cost that caused the change, for some farmers who owned cattle started using donkeys in preference to their oxen. One major reason for the use of donkeys is related to the perceived requirement for several people to work with oxen, while frequently only one person is used to control a donkey. Some farmers appeared unaware that it is possible for oxen to be worked with one person, as is normal in Ethiopia and Asia. For others, the risk of theft prevented them investing more of their time in training, since well-trained, docile oxen are much easier to steal than poorly trained, wilder animals. Donkeys are not very attractive to thieves since they are of low value and cannot be easily transported and sold in the form of fresh meat. This means a farmer can allow a well-trained and docile donkey to wander unsupervised in the dry season without the nagging fear of theft.

This example shows that The Gambia has experienced two dramatic changes in its farming systems in less than thirty years. Firstly through a highly structured extension programme based on formal training centres, the extension service brought what previously was almost an unknown technology into the majority of the villages in The Gambia. This suggests that lack of knowledge of innovative technologies, or lack of confidence to try them, can indeed be limiting factors, and that catalytic programmes to introduce draft animal technology can sometimes be both appropriate and highly effective.

Implications of the farmer innovation

The rapid spread of donkey technology throughout The Gambia, prior to any official encouragement or endorsement by the extension services, illustrates how very quickly knowledge can diffuse through informal channels. This spread involved not just a change in animal, but a change in cultivation system: a change from heavy draft plowing and ridging with oxen, to tine cultivation or direct planting with donkey-drawn seeders. In many cases this involved obtaining new equipment and spare parts from neighbouring Senegal, and often innovative equipment modifications were undertaken in the villages. The change from paired oxen to single donkeys involved a change from simple wooden yokes to more complicated rubber or leather harnesses and different hitching systems. Yet these dramatic changes did not involve government services but were based mainly on traditional means of obtaining knowledge, training, advice and credit.

It could be argued that the example of The Gambia is not typical, since it is a small country, and farmers were influenced by developments in neighbouring Senegal. However the case of animal traction technology crossing national frontiers is by no means unique in West Africa. Emcot ridging plows from Nigeria have spread into neighbouring Niger, Benin, Togo and northern Ghana through private traders, and plows from Guinea have been brought into Sierra Leone. In many countries animal traction has been sustained entirely by private training, equipment and financial services. Conversely there have been many expensive projects that have actively tried to promote animal traction, with disappointing results.

Economic and social considerations (costs and risks) are crucial to the adoption of technology. In The Gambia, farmers have adopted a novel, exotic species of animal with a high mortality rate which was cheaper than the indigenous cattle. Elsewhere donor-assisted projects have often tried to promote the use of new breeds

that have been disease susceptible and more expensive than local breeds, and this has not generally been successful. In The Gambia, a new harnessing system using a single animal spread rapidly, despite the fact that it was slightly more expensive and complicated than the wooden yoke, and this may be because it allowed the use of the cheaper animals that required less training and supervision. Elsewhere new yoking systems have not been rapidly adopted, because they have often not been associated with clear benefits. In The Gambia the farmers rejected the government-subsidized wheeled toolcarriers that were complicated, heavy and very expensive. Nevertheless they have also shown themselves willing to invest their private resources in other technology, such as the Super Eco Seeder, that also seems quite complicated and expensive, but which is seen by the farmers as very appropriate.

The introduction of animal traction

Equipment

In general, equipment should be selected that is simple, affordable, readily available and can be easily maintained. The word selected, rather than developed, is used since there already exists a vast number of equipment designs. Innovative farmers and village artisans are generally very astute at selecting the most appropriate equipment to their needs from a range of options. They can often fine-tune the equipment to their particular conditions by various modifications to the existing design.

Animals

When animal traction is introduced, it is particularly important that the animals used should be well adapted to the environment and capable of existing on the resources available to the farmer. Many introduction programmes have been severely set back by high mortality rates in the early years. Animals should be af-

fordable and available in sufficient quantity that a farmer can obtain replacements easily. In most cases this will mean that indigenous breeds are used. There are far too many suggestions by external consultants that large or exotic breeds should be used by programmes attempting to introduce animal traction into an area. Such animals would almost certainly be less hardy than local animals, require greater resources and a higher degree of management, and be difficult to obtain in the short term. When a new technology is combined with a new animal, there is a strong risk that the appropriate technology would be rejected because of problems with the inappropriate animals.

Economic issues: risk and credit

Introducing animal traction is likely to involve farmers in considerable investment in their time and resources, and expose them to significantly increased risk. It may be desirable to provide some form of insurance against the risk of losing an animal, and some credit schemes, such as those operating in Burkina Faso, include an insurance element within the loan terms. In the first year, there are unlikely to be rapid returns from adopting animal traction, and the benefits may only develop over a period of five to seven years (Barratt *et al.*, 1982). It is unlikely that loans based on standard commercial credit conditions for interest rates and repayment periods will be appropriate to programmes introducing animal traction. If credit is given, it should be based on realistic and not optimistic forecasts of farm profitability over the years, and should not assume that farmers will immediately make full use of the technology. Animal-powered farming systems require considerable effort in stumping, and it is unlikely that farmers will have the resources, time or confidence to rapidly destump their land. Thus animal traction use is likely to be progressively increased over several years. This is not simply a question of stumping, it is a question of risk. Farmers are likely to be changing from traditional mixed cropping systems that require little investment and provide low, but reliable, out-

puts. Animal power adoption implies a great investment, that has to be paid for by increased or more valuable outputs. This often is achieved by monocropping saleable commodities, a strategy which is risk-increasing, since repeated monocrops are more likely to be devastated by weeds, pests or environmental conditions than are a range of mixed crops. Farmers adopting animal traction often try to keep two farming systems running parallel for the first few seasons, thus spreading their risks, but also preventing them from maximizing their benefits from animal traction adoption.

Social implications

Programmes attempting to introduce animal traction should be aware of the social costs and benefits of the technology. In some cases the benefits achieved by one gender or age group necessitate extra costs for another social group. One example of gender effects arises in some societies when animals are used only for primary cultivation, thus saving the traditional cultivators (often men) from the drudgery and allowing greater areas to be tilled. This may result in those responsible for weeding and harvesting (often women) actually having more work, without there being compensating social or economic benefits for these people. Children are often used to look after draft animals, and farmers adopting draft animals may be less willing to send their children to school if this interferes with herding duties.

Lack of social tradition of keeping large animals is often cited as an important reason why the introduction of draft animals is difficult. Nevertheless there seems to be strong evidence from many West African countries that farmers can very rapidly adopt a technology that is unfamiliar if it has clear social or economic benefits. While it is clear that traditions and taboos can be important in any society, these can rapidly change with time. In general social constraints to animal traction adoption are only cited when there is also another problem, and this is most commonly a lack of economic

profitability. For example, in two neighbouring regions in Zaire, one project made very slow progress at the same time as another achieved rapid success. In the area where animal traction adoption was very slow, farmer unfamiliarity with cattle was cited as a major constraint; there was also no market outlet for produce. In the second area, there was a main road. Along this it was possible to sell maize at twice the price that prevailed in the first area, since there was a high demand in a nearby town. As a result villages that had hardly ever seen cattle before, and in which no one was used to handling animals, rapidly adopted animal traction. In the area in which animal traction was clearly profitable, there was little talk of social constraints (Starkey, 1984).

Environmental issues

Finally, although there is emphasis here on the equipment, the animals and the socio-economic implications of animal power introduction, one should also be aware of the environmental impact of animal traction. Introducing draft animals in West Africa has been associated with the stumping of land and the introduction of mouldboard plows or ridgers which invert the soil. It has also often been associated with extensified, rather than intensified, production. Compared with traditional, long-duration, bush-fallow systems of cultivation, animal traction farming systems tend to cause greater erosion. Animal traction may also lead to great problems of weed infestation; for example clearing forests can lead to the development of unproductive fire-climax grasslands, dominated by grasses such as *Imperata cylindrica* whose tough rhizomes make further cultivation very difficult. It may well be argued that the problem in these cases is not animal traction but the change from the traditional systems that cannot sustain the growing populations, and that there are few viable alternatives to the use of animal power. Nevertheless inevitable, it does seem important to consider the environmental implications of introducing animal traction.

The intensification of animal traction

Increasing annual utilization

In terms of the workshop theme, intensifying the use of animal traction implies using draft animals for more days of the year. Very many working animals employed by farmers are only used for primary cultivation and only work for a few weeks each year. This may mean that it is difficult to justify spending a great deal of time on training animals, so that farmers do not have precise control over their animals, and some re-training is needed each year. Intensifying animal power may involve using draft animals for more cultivation operations, notably seeding and weeding or using animals for transport. This may have important implications for cropping techniques, particularly if row planting is adopted, and the extra work involved may necessitate more attention to animal feed resources.

Equipment

There is a very wide range of implements available to carry out seeding, secondary cultivation operations and transport. An elegant idea was to combine these into a single, multipurpose implement known as a wheeled toolcarrier, but as noted above, such implements have not been adopted by farmers. Simpler multipurpose toolbars such as the Houe Sine have had some success in Senegal and Mali where they are mainly used for tine cultivation, weeding and the "earthing-up" of ridges. In Togo and Burkina Faso a triangular cultivator is sold for tine cultivation and weeding, but sales are much lower than those for plows. In northern Nigeria ridging plows are used for weeding between ridges. In southern and eastern Africa, weeders are available which are fitted with levers to adjust row width, but although they have been in use by farmers for many years, overall adoption rates are low. In some countries, including parts

of Kenya, farmers have modified their plows for inter-row weeding.

A wide range of cart designs is also available. In Asia, most carts have been based on large wooden wheels. The large diameter of the wheels is useful when negotiating pot-holes and allows the wooden bearing to turn quite slowly. In Africa wheels with wooden spokes have seldom become popular. Reasons cited for this have included difficulties in obtaining well-seasoned timber, and the stresses caused by the large changes in humidity between the wet and dry periods of the year. Carts with steel wheels fixed to stub axles and oil-soaked wooden bearings have spread on a small scale in several African countries. They are most suited to light use, for with heavy use they tend to suffer welding fatigue and wear of thrust washers and bearing blocks. In many countries carts are made from wrecked cars and pick-ups. In several West African countries including Senegal and Mali, large numbers of carts with pneumatic tyres and sealed bearings have been purchased by farmers. Although expensive, these are generally considered to be the most satisfactory type of cart, and farmers have been seen to be prepared to cope with the inevitable puncture problems once they have appreciated the economic and social value of carts.

Equipment-nutrition interactions

The interaction of the different technologies for intensifying animal power use can be seen in relation to carts and animal nutrition. Draft animals in Africa generally obtain all, or most, of their food from rough grazing. For working a small number of days each year, many animals can make use of rough grazing, and simply lose some weight during the main work period. As the number of working days each year increases, the need for farmers to provide supplementary feed for their animals also increases. One of the cheapest and simplest means of providing supplementation is the conservation of crop residues, notably groundnut straw and maize stover. Such materials are

bulky and transporting them by headload is very inefficient. By contrast residues are ideal materials for being transported in animal-drawn carts, so that the use of carts makes the stocking of residues feasible. The association between the adoption of carts and the conservation of crop residues can be seen in several countries including Senegal, The Gambia and Mali. In Ethiopia, where conservation is widely practised, pack animals are used to carry the hay and straw. In both Ethiopia and West Africa, where animal transport has become an important income-generating activity (particularly around towns), markets have developed for feed supplies, such as crop residues. Farmers, without any assistance from development projects, have often responded rapidly to the demand for animal feeds by conserving crop residues, or even growing fodder specially. In contrast many feed supplements developed by researchers, and promoted by development projects, have had little uptake, often because they were not considered to be cost-effective. This again illustrates that profitable marketing opportunities are often a prerequisite for adopting a technology.

Social and economic effects

Animal-drawn carts can have important social and economic effects within communities. In Sierra Leone, ox-carts have been used to transport sick people, to take village officials to chieftain meetings and to allow village tailors to work at local markets. In Zambia, it was considered that in some regions agricultural production was suppressed by lack of marketing opportunities, and that marketing was constrained by lack of rural transport. As a result, farmers were assisted to purchase ox-carts, as an indirect means of stimulating crop production (Mack, 1984). In Malawi it was reported that some farmers found that their secondary transport operations became more profitable than their primary production (Starkey, 1985).

Intensified production may require different systems for managing draft animals during the year. In much of West Africa, animals remain in large herds for most of the year and are only kept within villages during the cultivation season. As the use of animals increases, there is a tendency for animals to remain in the villages for longer. This may have implications for the work of children, as herders. Since it is relatively inefficient for one person to supervise the grazing of a single pair of animals, community grazing schemes may be adopted, provided there is sufficient social cooperation. An alternative strategy adopted by some communities is to move towards the stall feeding of draft animals.

Diversification of animal traction

Novel uses of animal power

In the context of this workshop, diversifying the use of animal traction implies extending the use of power beyond the standard range of crop cultivation and transport operations. Examples of diversified uses include animal-powered systems for water raising or milling, such as those being evaluated by the German Appropriate Technology Exchange (GATE) in Senegal, Burkina Faso and the Central African Republic. Also under this category would fall the use of draft animals for water harvesting in arid areas such as the Turkana district of Kenya; the construction of ponds or terraces as being developed in Ethiopia; and the use of animal power for timber extraction, whether at a commercial level, such as in the forestry operations in Malawi and Swaziland, or at the village level, as is found in Togo. Diversification may also be taken to include the use of novel breeds or species, such as the evaluation of water buffalo in Senegal. Perhaps more importantly it can include the use of female animals for work, a subject of interest to farmers and research programmes in several countries in parts of Africa, including Senegal and Cameroun.

Equipment

The equipment for diversified operations is often very expensive, as in the case of animal-powered mills and gears. While in North Africa and Asia there have been traditional systems for grinding and for raising water based largely on wooden construction, many modern designs being evaluated are made of steel and are relatively complicated and expensive. Some designs being evaluated by the German Appropriate Technology Exchange (GATE) can be seen at Rolako during the field visit. It should be stressed that these should be considered prototypes, as yet unproven by sustained farmer adoption.

Other animal-drawn equipment, such as earth-moving scoops, have been used at agricultural stations and on large farms in Kenya, Zambia and Zimbabwe for decades. Recent work on pond construction in Ethiopia, stimulated by ILCA, has been based on similar scoop designs. Such earth-moving scoops have seldom been used by the small-scale farmer, partly because their cost relative to their use is also quite high. Whether one is talking of a large mill or an earth-moving scoop, it is unlikely that individual small farmers could justify purchasing such equipment, so that such implements are either likely to be owned communally or by contractors.

Social and economic implications

This has significant social and economic implications. An entrepreneur would probably require a major loan, and would expect to cover the cost of this in hire charges. On the other hand, if equipment were communally owned, there would have to be great social organization and cohesion to ensure that it was correctly and equitably used and maintained. Water harvesting, terracing and pond construction are likely to involve community decisions, not only because of the large investment but also because their success is likely to depend on how land is allocated within a community and on planning

over quite large catchment areas. Installation of grinding mills and water-raising systems in Senegal have often imposed new strains on communities in managing the resources. For example, if members of a community install a water-lifting device, it has to be decided whether non-contributors are allowed to benefit from it and, if so, whether charges should be or could be levied (Jacobi and Löwe, 1984). At some village grinding mills, users are expected to bring along their own animals to provide power (Busquets, 1986).

Innovative use of animals

When animal traction is well established using local animals, it may be possible to diversify the type of animal employed. The example of The Gambia showed how farmers can rapidly adapt to a new type of animal, if this is socially and economically desirable. In parts of Mali, Niger and northern Nigeria, farmers are increasingly using camels for crop cultivation, although absolute numbers are still very low. In northern Nigeria, farmers have started to stall-feed work bulls for beef production. In Sine Saloum in Senegal, farmers have increasingly employed cows for work (Lhoste, 1983; Reh and Horst, 1985). With high levels of management, and the availability of good quality feed such as groundnut hay, the use of cows can be economically attractive. In conditions of high management and clear economic profitability, it may even be possible to consider using exotic animals or crossbreds, although previous experiences indicate that any such initiatives should proceed with very great caution.

Innovative cropping systems

Several programmes in West Africa are looking at the options for diversifying the crops for which animal traction is currently used. In Côte d'Ivoire, Togo and Sierra Leone, there has been interest in the potential for using oxen to make ridges for growing root and tuber crops (Bigot *et al.*, 1983). In The Gambia the options for using N'Dama oxen for rice cultivation are

being studied. These are areas where networking can play an important role. For example, following this workshop the participants from The Gambia will be staying on to visit projects in Sierra Leone working in this field.

Conclusions

This paper has attempted to provide a perspective on the use of animal traction in Africa, and some of the influences of history, promotional schemes and research programmes in determining the present situation. One thing that is clear from the examples cited of Ethiopia, North Africa, Asia and The Gambia is that animal traction can be developed by farmer initiatives. Within West Africa there are many examples of traditional village credit and financial arrangements sustaining animal traction. In many countries animal husbandry practices developed by livestock owners themselves are more important for maintaining the health of animals than the over-stretched veterinary services. Harnessing systems and animal traction equipment have been developed by farmers in cooperation with local artisans. Moreover there is a very great tradition of farmers carrying out research and development studies themselves (Richards, 1985).

While farmers do not use the jargon and acronyms associated with the modern, academic form of Farming Systems Research, their methodology is often faultless. While farmer research is seldom replicated or reported, it is frequently more rigorous, in scientific and methodological terms, than the research of some development projects which try to prove the validity of their preconceived ideas. Thus there seems no justification for researchers or extension workers having patronizing attitudes towards farmers. Research and development projects are not prerequisites to innovation, but they can provide valuable opportunities for working with farmers to accelerate the processes of development.

The challenge of the workshop is to obtain a closer understanding of the farm level implica-

tions of the introduction, intensification and diversification of animal power in West African farming systems. As the workshop develops it is hoped that the problems of the farmers can become more clearly understood, that their major constraints can be defined, and that their crucial needs can be identified. Such an understanding would be a major achievement. Easy answers to farm level problems are unlikely to be found, but during the months that follow this workshop, participants will be able to reflect on appropriate means of overcoming the constraints. To facilitate this, a practical and realistic approach to animal power research and development should be elaborated, one that combines the farming systems perspective with a networking methodology.

References

- Anderson, F. M. 1983. An overview of ILCA's animal traction research in Ethiopia. pp 178-183 in C. B. Flora (Editor) *Animals in the farming system. Proceedings 1983 Farming Systems Research Symposium, 31 October - 2 November 1983. Kansas State University, Manhattan, Kansas, USA. 924p. (E,F). Reprinted ILCA, Addis Ababa, Ethiopia. 8p. (E,F).*
- Anderson, F. M. 1984. Draught animal power in Africa: an overview. pp. 60-66 in *Animal energy in agriculture in Africa and Asia. Animal Production and Health Paper 42, FAO, Rome, Italy. 143p. (E,F).*
- Argus, 1979. *Appropriate technology. Argus (Informal magazine published by staff of Njala University College, Sierra Leone) 2 (1): 21. (E).*
- Barratt, V., Lassiter, G., Wilcock, D., Baker, D. and Crawford, E. 1982. *Animal traction in Eastern Upper Volta: a technical, economic and institutional analysis. International Development Paper 4. Department of Agricultural Economics, Michigan State University, East Lansing, Michigan, USA. 118p. (E,F).*
- Bigot, Y. *Rapport de mission effectuée en Guinée Forestière et en Haute Guinée du 20-30 novembre 1983. Projet de recherche sur la mécanisation agricole en Afrique sub-saharienne. Agricultural Research Unit, World Bank, Washington DC, USA. (unpublished). 40p. (F).*
- Bigot, Y. 1983. *La culture attelée et ses limites dans l'évolution des systèmes de production en zones de savanes de Côte d'Ivoire. Machinisme Agricole Tropical 84: 44-52. (F).*
- Bigot, Y. 1985. *Quelques aspects historiques des échecs et des succès de l'introduction et du développement de la traction animale en Afrique sub-saharienne. Machinisme Agricole Tropical 91: 4-10. (F).*

- Bigot, Y., Monnier, J., Landais, E. and Mandjoba, C. 1983. La culture attelée en Côte d'Ivoire de la croissance cotonnière au développement agricole des régions de l'élevage bovin. BETPA, Ministère de l'Agriculture, Abidjan, Côte d'Ivoire. 250p. (F).
- Binswanger, H. P. 1984. Agricultural mechanization: a comparative historical perspective. Staff Working Paper 673, World Bank, Washington DC, USA. 80p. (E).
- Busquets, E. 1986. The power gear makes it worthwhile to keep draught animals. GATE (German Appropriate Technology Exchange) 4/86: 13-16. (E).
- DMA 1986. La traction animale au Mali. Division du Machinisme Agricole, Bamako, Mali. 39p. (F).
- EFSAIP 1981. Report No 5, 1980-1981. Evaluation of Farming Systems and Agricultural Implements Project (EFSAIP), Ministry of Agriculture, Gaborone, Botswana. 149p. (E).
- FAO 1982. Report of the FAO expert consultation on the appropriate use of animal energy in agriculture in Africa and Asia, held 15-19 November 1982, Rome. FAO, Rome, Italy. 44p. (E,F).
- Farrington, T. and Riches, C. R. 1984. Draught power in Botswana: Parts I and II. Bulletin of Agricultural Research in Botswana, 2: 53-77. (E).
- Gibbon, D., Harvey, J. and Hubbard, K. 1974. A minimum tillage system for Botswana. World Crops 26, 5, 229-234. (E).
- Goe, M. R. 1983. Current status of research on animal traction. FAO World Animal Review 45: 2-17. (E,F,S).
- Gryseels, G. 1983. On-farm animal traction research: experiences in Ethiopia with the introduction of the use of single oxen for crop cultivation. pp 419-430 in C. B. Flora (Editor) Animals in the farming system. Proceedings 1983 Farming Systems Research Symposium, 31 October - 2 November 1983. Kansas State University, Manhattan, Kansas, USA. 924p. (E,F). Reprinted ILCA, Addis Ababa, Ethiopia. 15p. (E,F).
- Hamon, H. 1970. Création, amélioration et performances d'une race de bovins de trait au C.N.R.A. Bambey (métis Zébu-Gobra x N'Dama). Colloque O.C.O.M. sur l'Élevage, 8-13 Déc 1969, Fort Lamy, Tchad. Précis: Machinisme Agricole Tropical, 29: 24-25. (F).
- Harvard, M. 1985. Principales caractéristiques et contraintes de gestion du parc de matériels de culture attelée au Sénégal. Machinisme Agricole Tropical 91, 19-23. (F).
- ILCA 1981. Animal traction in sub-Saharan Africa. ILCA Bulletin 14, International Livestock Centre for Africa, Addis Ababa, Ethiopia. 17p. (E,F).
- Imboden, R., Starkey, P. H. and Goe, M. R. 1983. Rapport de la mission de consultation préliminaire à l'établissement d'un réseau de coopération technique dans les pays en voie de développement (TCDC) en matière de développement, recherche et formation pour l'utilisation de l'énergie animale. FAO, Rome, Italy. 115p. (E,F).
- IRRI 1985. Report of the crop-livestock systems research monitoring tour of Philippines and Thailand, 10-18 December 1984. International Rice Research Institute, Manila, Philippines. 480p. (E).
- Jacobi, C. 1985. Raising water with the Guérout creates conflicts. GATE (German Appropriate Technology Exchange) 2/85: 40-42. (E).
- Jacobi, C. and Löwe, P. 1984. Diffusion des pompes guérout: impacts techniques et sociaux. E.T. 121, ENDA, Dakar, Sénégal. (F).
- Kinsey, B. H. 1984. Equipment innovations in cotton-millet farming systems in Uganda. pp. 209-252 in: Ahmed, I. and Kinsey B. H. (Editors). Farm equipment innovations in Eastern and Central Southern Africa. Gower Publishing, Aldershot, U. K. 345p. (E).
- Kjaerby, F. 1983. Problems and contradictions in the development of ox-cultivation in Tanzania. Research report 66, Scandinavian Institute of African Studies, Uppsala, Sweden. 164p. (E).
- Letenneur, L. 1978. Crossbreeding N'Dama and Jersey cattle in Ivory Coast. FAO World Animal Review 27: 36-42. (E,F,S).
- Lexa, J. P. 1985. Some aspects of the mixed farming systems in the family sector of Mozambique. pp. 218-239 in: J. Timberlake and C. Jordao (Editors) Selected papers from Livestock Production Seminar held 2-7 Dec 1985, Maputo, Mozambique. Ministry of Agriculture, Maputo, in cooperation with FAO, Rome. 299p. (E,P).
- Lhoste, P. 1983. Développement de la traction animale et évolution des systèmes pastoraux au Siné Saloum, Sénégal (1970-1981). Rev. Elev. Méd. vét. Pays trop., 36 (3): 291-300. (F).
- Mack, R. P. 1984. The impact of the introduction of work-oxen within the frame of the Integrated Rural Development Programme (IRDP) in the North-West Province of Zambia. GTZ, Eschborn, Fed. Rep. Germany. 65p. (E). (unpublished).
- Manigui, S. A. and Medenou, C. K. 1986. La culture attelée en République Populaire du Bénin: Etat actuel et perspectives. Direction des Etudes et de la Planification, Ministère du Développement Rural et de l'Action Coopérative, Cotonou, Bénin. 115p. (F).
- MAWD 1985. Animal draught power. Investment Plan Task Force, Planning Division. Ministry of Agriculture and Water Development, Lusaka, Zambia. 159p. (E).
- Mettrick, H. 1978. Oxenisation in The Gambia. Ministry of Overseas Development, London. 68p. (E).
- Mochudi 1975. Makgonatsotthe: Mochudi tool bar. Technical drawings. Mochudi Farmers Brigade, Kgatleng Development Board, Botswana. 49p. (E).
- Munzinger, P. 1982. (Editor). Animal traction in Africa. GTZ, Eschborn, Germany. 490p. (E,F,G).
- Pingali, P. L., Bigot, Y. and Binswanger, H. P. 1987. Agricultural mechanization and the evolution of farming systems in sub-Saharan Africa. World Bank in association with Johns Hopkins Press, Baltimore, USA. 216p. (E).
- Poats, S. V., Lichte, J., Oxley, J., Russo, S. L. and Starkey, P. H. 1986. Animal traction in a farming systems perspective. Report of workshop held Kara, Togo, March 3-8 1985. Network Report 1, Farming Systems Support Project, University of Florida, Gainesville, USA. 187p. (E,F).
- PROPTA 1985. Situation actuelle de la traction animale au Togo. Projet pour la Promotion de la Traction Animale (PROPTA), Atakpame, Togo. (F).

- Kamaswamy, N. S. 1981. Report on draught animal power prepared for the Food and Agriculture Organization of the United Nations. India Institute of Management, Bangalore, India. 173p. (E). (mimeo).
- Reh, I. and Horst, P. 1985. Beef production from draught cows in small-scale farming. *Quarterly Journal of International Agriculture* 24 (1): 38-47. (E).
- Richards, P. 1985. Indigenous agricultural revolution: ecology and food production in West Africa. Hutchinson, London, U.K. 192p. (E).
- Sargent, M. W., Lichte, J. A., Matton, P. J. and Bloom, R. 1981. An assessment of animal traction in francophone West Africa. Working Paper 34. Department of Agricultural Economics, Michigan State University, East Lansing, USA. 101p. (E,F).
- Shumba, E. M. 1983. The crop-livestock interrelationship and farmer adaptation to problems of reduced cattle numbers and lack of dry season feed in communal areas of Zimbabwe. Paper presented at workshop on draught power and animal feeding, held Ezulwini, Swaziland, October 4-6 1983. Summarized in: *Networking Workshops Report 2. CIMMYT Eastern and Southern Africa Economics Programme, Mbabane, Swaziland.* 93p. (E).
- Smid, J. 1982. Use of draught oxen in Northern Ghana. pp.453-476 in P. Munzinger (Editor) *Animal traction in Africa.* GTZ, Eschborn, Federal Republic of Germany. 490p. (E,F,G).
- Smith, A. J. 1981. Draught animal research, a neglected subject. *World Animal Review* 40: 43-48. (E,F,S).
- SODECOTON 1986. Rapport annuel: campagne 1985/86. Société de Développement du Coton du Cameroun (SODECOTON), Garoua, Cameroon. 271p. (F).
- Starkey, P. H. 1984. The use of draught animal power in the Kasai Occidental and Kasai Oriental regions of Zaire. *Work Oxen Project, Freetown, Sierra Leone.* (mimeo). 40p. (E,F).
- Starkey, P. H. 1985. Genetic requirements for draught cattle: experience in Africa. pp 109-114 in: J. W. Copland (Editor) *Draught animal power for production. Proceedings of an international workshop held at James Cook University, Townsville, Qld, Australia, 10-16 July 1985.* ACIAR Proceedings Series 10, Australian Centre for International Agricultural Research, Canberra. 170p. (E).
- Starkey, P. H. 1985. Some organizations concerned with animal traction research and development in sub-Saharan Africa. *Agricultural Research Unit Report 38.* World Bank, Washington DC, USA. 44p. (E).
- Starkey, P. H. 1985. Animal power utilization in Malawi. Report of consultancy mission 7-21 September 1985. FAO, Rome, Italy. (mimeo). 26p. (E).
- Starkey, P. H. 1986. Animal traction research and development in Africa: an overview. pp. 19-27 in: Poats, S. et al. (Editors), *Animal traction in a farming systems perspective. Proceedings networkshop held March 1985, Kara, Togo.* Farming Systems Support Project, University of Florida, USA. 187p. (E,F).
- Starkey, P. H. 1986. Draught animal power in Africa: priorities for development, research and liaison. *Networking Paper 14, FSSP, University of Florida.* 40p. 1986. (E).
- Starkey, P. H. 1986. Strengthening animal traction research and development in The Gambia through networking. *Consultancy Mission Report and Annotated Bibliography on Animal Traction. Gambia Agricultural Research and Diversification Project (GARD), Banjul, The Gambia.* 30p. and 17p. (unpublished). (E).
- Starkey, P. H. 1988. *Animal traction directory: Africa.* GATE, GTZ, Eschborn, Germany. 151p. (E).
- Starkey, P. H. 1988. *Animal-drawn wheeled toolcarriers: perfected yet rejected.* GATE, Eschborn, Germany. 161p. (E).
- Starkey, P. H. and Goe, M. R. 1984. Report of the preparatory FAO/ILCA mission for the establishment of a TCDC network for research training and development of draught animal power in Africa. FAO, Rome. 82p. (E,F).
- Starkey, P. H. and Goe, M. R. 1985. Report of third joint FAO/ILCA mission to prepare for the establishment of a TCDC network for research training and development of draught animal power in Africa. FAO, Rome. 85p. (E,F).
- Starkey, P. H. and Apetofia, K. V. 1986. Integrated livestock systems in Nepal and Indonesia: implications for animal traction programs in West Africa. *Network Report. No 3, Farming Systems Support Project (FSSP), University of Florida.* 64p. (E,F).
- Starkey, P. H. and Apetofia, K. V. 1986. Animal traction in Togo. pp. 660-663 in: *Proceedings of the 2nd Monitoring Tour Crop-Livestock Systems Research, Nepal and Indonesia.* International Rice Research Institute, Manila, Philippines. 668p. (E). Reprinted in: Starkey and Apetofia, 1986. *Network Report No 3, Farming Systems Support Project (FSSP), University of Florida.* 64p. (E,F).
- Starkey, P. H. and Kanu, B. H. 1986. Animal traction in Sierra Leone. pp. 35-36 in: Poats, S. et al. (Editors). *Animal traction in a farming systems perspective. Report of networkshop held Kara, Togo, March 3-8 1985.* Network Report 1, Farming Systems Support Project, University of Florida, Gainesville, USA. 187p. (E,F).
- Tessema, S. and Ernojong, E. E. 1984. Feeding of draught oxen for improved and more efficient power. in: *Dryland Farming Research, the Kenya experience.* E. Africa J. Agric. and For. 44: 400-407 (E).
- van Nhieu, J. T. 1982. Animal traction in Madagascar. pp. 427-449 in: Munzinger, P. (Editor). *Animal traction in Africa.* GTZ, Eschborn, Germany. 490p. (E,F,G).
- Verheaghe, H. Personal communication. Information from archives of CFDT (Compagnie Française pour le Développement des Fibres Textiles), Paris.
- Vietmeyer, N. 1982. The untapped science of animal power. *Ceres, July-August 1982:* 42-45. (E,F,S).
- Wagner, C. M. and Munzinger, P. 1982. Introduction of draught animals in north-west Cameroon by the Wum Area Development Authority. pp 377-402 in: Munzinger, P. (Editor). *Animal traction in Africa.* GTZ, Eschborn, Germany. 490p. (E,F,G).

The selection and use of animal draft technology

by

R. C. Gifford

*Agricultural Engineering Service, Agricultural Services Division,
Food and Agricultural Organization (FAO), Rome, Italy*

Introduction

The title of this paper is meant to establish a thought process which differs from that implied in the use of Draft Animal Power or its acronym - DAP. I believe we should all be thinking in terms of a total agricultural mechanization technology, a technology which is made up of components, each of which is dependent on the others in relation to the task which is to be accomplished. The term DAP carries a connotation of concern only for the source of power, which is only one element amongst all the interacting elements of the technology. This focus on the power source instead of the totality of the technology has, in numerous instances, led to the selection and introduction of animal draft technology into farming systems when it was completely inappropriate in technical, economic, social, or political terms. The same is equally true when the focus has been on tractors - the source of power for much of the mechanical technology in agriculture. The effort of the Farming Systems Support Project in this workshop is, to me, a welcome and refreshing contribution. It implies, at least, that the selection and use of animal draft technology will be in the context of the development situation in which it is to be applied. FSSP's efforts suggest that we are here to discuss firstly where, or in what circumstances, animal draft technology is the appropriate level of mechanization technology; and secondly how it can best be introduced into development situations where it will contribute to national development objectives. After all any level of mechanization technology - hand

tools, animal draft or mechanical power - is a means to an end: it is not an end in itself. I wish to stress, therefore, that the selection of a specific level of mechanization must be in the context of its contribution to the development of the farming system in which it will be used. I also wish to stress that the use of agricultural mechanization at any technological level cannot reach its potential contribution in isolation from other technologies which are important elements in farming systems. We have all seen improved land preparation nullified by failure to use improved seeds or failure to establish an appropriate plant population or to control weeds and other agricultural pests. Finally, animal draft technology, just as other mechanization technologies, can only contribute to development if it is seriously supported at the national level through research, training, credit, supply of operational inputs, and other institutional arrangements.

Selection of technology

This workshop focuses on the implications of animal draft technology at the farm level. While respecting this decision of the organizers, it is, nonetheless, necessary to point out that it is first necessary to determine that animal draft technology is the appropriate level of mechanization for the specific development situation being considered. Thus, we can only assume here that animal draft technology has been selected as the technology of choice after careful consideration of all three main mechanization technology alternatives. I would sug-

gest that this could be a dangerous assumption. FAO has found that few developing countries have formulated or implemented a national strategy for agricultural mechanization. Without such a strategy or plan, the chances are slim that a serious evaluation can be made of technical, economic, social, and political factors to determine appropriate mechanization technology for each category of farming systems.

At the farm level, selection of hardware for animal draft technology starts with the farmers' judgement on two key issues. First, the specification of the animal power available to them, either on hand or which can be obtained. How many animals are available, what size are the animals, and what will be their physical capability at the time they are needed? Second, the availability and cost of the harness and implements. The record shows that many attempts over the past twenty years to introduce improved harness and implements have failed because either appropriate models were not consistently available on the market, or the cost was beyond the means of the farmer.

With reference to draft animals, my personal experience is that there has been a relatively negligible adoption of improved species and breeds in spite of numerous efforts in research and development. Perhaps the reason is again the cost. In any event, farmers worldwide continue to use the draft animals which are traditionally available in their areas. Without minimizing the need for continued research and development on improving the quality of animals for draft purposes, the situation, as I see it, calls for a greater effort in helping the farmer - at the farm level - to develop ways of improving the capability of the animal power he already has. Improved feeding practices, for example, would go a long way towards ensuring that animals are fit for work when they are most needed. The answer is not to recommend the feeding of concentrates or supplements which carry a cash purchase requirement.

Ways must be found to introduce and sustain feeding regimes which are based on alternative crop production systems that the farmer could apply on his own farm. There has been much ado about the need for engineers to invent or design animal-drawn implements to fit the special circumstances of various country or regional situations. The statement is often made that implements for draft animals are old-fashioned and not efficient. If farmers are using a plow which was used 2000 years ago, it does not mean there are no better designs available. Rather it means farmers are not aware of better plows or it is beyond their ability to afford such plows. The technology shelf of animal-drawn implements which are technically appropriate for nearly every development situation is enormous. We, the international community, have done an abysmal job of making farmers aware of alternatives and ensuring that they have access to the ones which are appropriate to their individual situation. Here, I am speaking mainly of implement design. The material used for making the implement is a different matter. Too often implements of good design incorporate materials and production methods which are not readily available in most developing countries. The result is invariably that local manufacture, which is essential for the widespread introduction and maintenance of animal draft technology, cannot be sustained. There are numerous technical issues related to the design and quality of animal-drawn implements all of which are controversial and all of which have been debated many times. I do not believe this forum is the place to continue the debate. It is impossible to generalize whether, for example, a chain hitch or a beam hitch is technically better; it depends on the traditions and specific situations in which the implement will be used. I suggest we leave such issues to be decided at a more appropriate time and place.

Use of animal draft technology

FAO experience shows that the use of animal draft technology has generally been limited to

primary tillage and transport. Only isolated pockets exist where the full potential for using this technology has been exploited. Of course, in this situation the full benefit of the technology cannot be realized at the farm level and the oft made statement that draft animals are usually underutilized is quite true. Why this underexploitation of such a potentially beneficial technology? There is no single reason. I believe that, generally, the use of animal-drawn row-planters and inter-row cultivators, for example, has been constrained by a lack of farmer awareness of opportunities and potential benefits, limited availability on the local market of appropriate implements or equipment, inability of farmers to buy additional equipment, and the presence of field obstacles which inhibit the use of row-crop equipment. Some of these constraints can only be reduced by the natural course of events over time. It is obvious, however, that there is a need for increased effort to improve farmer awareness, increase his access to appropriate implements, and create an economic environment which will motivate farmers to expand the use of the technology.

Conclusions

I want to conclude this paper by reiterating the key points which I believe are crucial to the selection and use of animal draft technology:

- The appropriateness of the technology must be determined by the specific farming systems in which it will be applied.
- National agricultural mechanization strategies and plans are needed to put animal draft technology in perspective with regard to national development objectives and resources.
- The technological shelf to support animal draft technology is enormous and this should be exploited to the full before using scarce resources to mount further extensive research and development schemes.
- Greater efforts are needed to build the base for the technology on what the farmer already has, and on what is already feasible within a country. This implies actions such as improving the capacity of existing animals, encouraging local manufacture of appropriate equipment, and mounting programmes to improve farmer awareness of alternatives.

The relevance of animal traction to the humid zone

by

L. Reynolds *

International Livestock Centre for Africa, Humid Zone Programme, PMB 5320, Ibadan, Nigeria

Introduction

Animal power for cultivation and transport is probably used in every African country. Why is it therefore necessary to question the relevance of animal traction in the humid zone? A literature search quickly reveals that the majority of reported draft schemes occur in semi-arid conditions, less often in sub-humid areas and very few in the humid zone. Within the humid zone the lowland forest region has remained particularly unattractive to proponents of animal traction.

The humid zone can be defined as that area receiving over 1500mm annual rainfall, with a growing season in excess of 270 days. The coastal strip of West Africa, much of central Africa, eastern Madagascar and a small part of Mozambique, giving a total area of 4.1 million sq km (18.5% of tropical Africa), fall within this zone. Only 6% of the cattle and 9% of the human population of tropical Africa are included in the zone (Jahnke, 1982). A typical small farm comprises 6-8 individuals, cultivating 2-4 ha and owning 2-4 small ruminants. Major food crops are maize, yam and cassava; the tree crops cocoa and oil palm are important in some areas.

The lowland forest zone contains farmland under cultivation and bush fallow. Coarse grasses invade these areas and natural clearings, but grass cover is sparse or absent under the tree cover. A derived savannah belt is found adjacent to, and north of, the lowland

forest. This area is subject to regular fires and many tall trees have been destroyed leaving low trees, shrubs and bushes. Coarse grasses cover fallow areas, but a reduction in the frequency of burning on uncultivated land allows an invasion of woody species and reversion to forest (Crowder and Chheda, 1977). Rattray (1960) has identified *Pennisetum spp.* as typical of the grasses of this zone.

Major factors

General

The requirements for successful introduction of animal traction into an area have previously been discussed by various authors (Goe and McDowell, 1980; Sargent, Lichte, Matlon and Bloom, 1981; Munzinger, 1982a; Starkey, 1985). Many factors overlap so that consideration of one involves interaction with others. This paper concentrates on those aspects of particular relevance to the humid zone, bearing in mind that the focus of discussion is resources available within a small farmer community.

Animals

The primary requirement must be animals, which need feeding and keeping alive. We have already seen that cattle are relatively scarce, generally explained by the presence of tsetse flies and the parasitic disease trypanosomiasis which infests 90% of the humid zone. Some

* As Dr. Reynolds was unable to attend the workshop in person, many ideas contained in this paper were presented by his ILCA colleague, Dr. S. Adeoye.

breeds, such as N'Dama and West African Shorthorns, can tolerate trypanosomes and exist where non-trypanotolerant humped zebu breeds succumb. The humid zone has an extremely unsuitable climate for exotic breeds. However the concentration of tsetse flies varies from area to area, and a recent survey in southern Nigeria indicated the presence of 0.3 million cattle, compared with 12.0 million cattle in the country as a whole (Akinwumi and Ikpi, 1985; Jahnke, 1982). Zebu outnumbered trypanotolerant cattle by 3 to 1, with the numbers of all bovines declining towards the coastline.

In the forest region very few cattle are found but they are present in larger numbers in the derived savannah where dense rainforest has been cleared. A number of observations, outside the scope of this paper, suggest that the tsetse challenge in southern Nigeria has decreased in recent years, allowing permanent settlement of cattle owners in the derived savannah. It is not known whether other countries have experienced similar changes. Some cattle are therefore immediately available, but are they suitable for animal traction? Elsewhere zebu cattle are widely used, and N'Dama are worked in Sierra Leone (Starkey, 1982). Suitability depends upon what work is to be performed, and the power required. Work output is related to body size and a small breed would be more limited in its usefulness where heavy soils, requiring more effort for land preparation, are found (Goe and McDowell, 1980).

Before a plow can satisfactorily be used, it is necessary to destump the land. In the forest zone fields are cultivated for around three years before reversion to bush fallow. Destumping could only be justified if the means were available to maintain soil fertility levels and thereby allow extended periods of cultivation.

Farmers can overcome the lower power capacity of small animals by increasing the numbers in a team. There is, however, evidence that

stress, which can arise from work, poor nutrition, other concurrent diseases, pregnancy and lactation, increases susceptibility to trypanosomiasis (MacLennan, 1970). These factors have not been quantified but they will constitute an additional constraint on the use of draft power in a tsetse-infested zone. Prevention and control of disease will be influenced by the standards of husbandry, but exogenous veterinary inputs are also required which are outside the control of individual farmers.

As regards feeding, the humid tropics have the advantage of a lengthy growing season and high rainfall producing lush vegetation so that fodder is available throughout the year. However the nutritional value of grasses falls rapidly as plants mature, and become unpalatable, but browse maintains its feeding value over a long period and is therefore a valuable supplement to grass. Leguminous browse in particular has the potential to provide high quality feed at low cost throughout the year. If a farmer in the humid zone requires a team of 4 small trypanotolerant cattle to provide sufficient draft power for land preparation he will need a large quantity of fodder. A team of 4 N'Dama cattle, each weighing 300 kg, would need around 11 tonnes dry matter (DM) per year, obtainable from 0.55 ha of *Panicum maximum* pasture (Doppler, 1980). It is unlikely that such an area would be available close to a village even if the farmer was willing and able to plant pasture.

A steady supply of mature animals would be needed for any successful animal traction scheme. Butterworth (1985) pointed out that a herd of 12 young and breeding animals is required to provide replacements for 2 oxen. In the humid zone self-sufficiency is unlikely to extend to the provision of draft animal replacements, and small farmers would be forced to purchase stock.

Forage and fodder crops in West Africa have been reviewed by Crowder and Chheda (1977). Dry matter yields of natural pasture range from 2 to 6 tonnes/ha, but planted pasture can

frequently produce 20 tonnes DM/ha. Animal production from planted pasture on the derived savannah of Nigeria has been recorded as 4 times that from natural rough grazing (Ogor and Hedrick, 1963). Continuous grazing in humid areas permits a build-up of ticks and internal parasites in cattle, and possibly nematode infestation in the soil. Grazing young stock together with older animals causes heavy helminth burdens in the former and retards growth. Rotational grazing of planted pasture is therefore necessary requiring additional fencing (Crowder and Chheda, 1977).

Annual biomass production on fallow land in an established forest environment would be around 10 tonnes DM/ha, compared with 8 tonnes DM/ha in a savannah region (Nye and Greenland, 1960). However a lower proportion of the regrowth on forest fallow is palatable to livestock, and the practicality of allowing cattle to graze on small scattered fields within rainforest is questionable. Regular burning of accumulated and dead plant material following shifting cultivation on savannah land encourages *Imperata cylindrica*, a grass that is fairly nutritious when young but which rapidly becomes lignified and unpalatable.

Crop residues are a valuable feed resource to alleviate any deficit in the dry season. Residues can be grazed *in situ*, but some crops, such as cassava, remain in the fields after others have been harvested and the problem of access to scattered forest fields arises again. Residues can also be collected and fed to penned animals, but labour may be a constraint for collection of residues from the first season crops, when planting a second season crop is in progress. There will be less demand for farm labour during the dry season after a second crop has been harvested, and animals should also be free for transporting residues back to the household.

During the rainy season fodder production is likely to be in excess of requirements. Conservation of this surplus could provide additional material for dry season feed, but competition

for labour, difficulties in drying hay, and technical problems for small farmers making silage reduce the likelihood of either process significantly contributing to small-scale farming.

A more serious obstacle than the provision of feed *per se* is the integration of cattle into a farming system where at present livestock are outsiders. Small ruminants exist but in reality they look after themselves. If farmers are to own draft cattle drastic changes to the present farming systems are inevitable. Each individual component of the change may be small but in total they are practically and psychologically immense.

Maintenance of draft animals in good health is only partly dependent on husbandry and hygiene. Prophylaxis against diseases such as rinderpest, trypanosomiasis, and contagious bovine pleuropneumonia requires medication from an external source. In most countries within the humid zone veterinary services are over-stretched attempting to meet existing obligations. The additional burden of valuable draft animals would require the attachment of staff to a project, and as such this would be outside the control of smallholders.

Farmers unaccustomed to dealing with cattle could find it difficult to recognize health problems at a sufficiently early stage to allow simple remedies to be effective. A natural step would be for a farmer to turn to a more experienced neighbour for advice, but to whom does he turn when cattle owning is new to a district? Accessible and well-trained extension staff would be necessary to provide advice.

Finance

A considerable investment is required for a smallholder to purchase draft animals, and as indicated earlier, few farmers in the humid zone are likely to own a large enough herd to produce their own stock. In addition the animals are of limited use without, at the very least, equipment for land preparation. Weeding, a very labour-intensive operation, can also

be performed with draft, but requires further equipment. Access to adequate credits on favourable terms is a prerequisite for the adoption of animal traction (Munzinger, 1982b). Thus the involvement of a credit agency is essential.

Selective promotion of market crops is necessary unless existing cropping structures can support repayment schedules for the credit scheme (Munzinger, 1982b). Delgado and McIntire (1982) have shown that profits generated from the staple millet-sorghum cereal system in the Sahel are too low, although production of groundnuts and cotton improved the viability of a traction scheme. Upland rice in Sierra Leone is also of limited profitability (Starkey, 1982).

Studies outside the humid zone indicate that farmers with oxen plant a larger area than those without draft power, but a shortage of labour often prevents adequate weeding on the expanded area. Crop yields per hectare tend to be lower although the total yield rises, reflecting the increased area under cultivation (Zalla, 1976; Sargent *et al.*, 1981; Faye, 1985; P.A. Francis, personal communication).

In the early years animal traction is likely to have a negative effect on farm profitability, because of the repayment of credits (Starkey, 1984, 1985; Doppler, 1978, quoted in Munzinger, 1982b; Sargent *et al.*, 1981). Barratt (1985) reported in Burkina Faso that the cash costs of animal traction were so high and farm cash revenues so low that non-farm revenues were needed to support the cost of animal traction, particularly the purchase of equipment.

If, in the planning stage, the existing cropping system is found to be incapable of generating sufficient income for animal traction to be profitable an alternative market crop would be needed. The simultaneous introduction of a new crop and livestock is inadvisable. If a cash crop must be introduced it is better to allow farmers time to assimilate the cropping skills

before introducing a second and fundamentally more drastic change, in the form of draft power.

Social factors

Animal traction projects have frequently been dominated by factual analysis of agricultural engineering and economics, so that recording and analysis of social factors remained rudimentary (Kalb, 1982). Specific ethnic or cultural identities may be linked to animal traction so that a particular tribal group may not be adopters because animal traction is not part of their culture. A resource-demanding intervention may be targeted at wealthy or elite farmers, whose activities may be of no interest to non-progressive farmers who find it impossible to identify with this elite (Schonherr, 1975, quoted in Kalb, 1982). Women play important roles in African agriculture but often innovations are directed solely at the male farmer. Access to land, to allow the expected increase in area under cultivation to take place, is important. In many places population increase has raised the demand for arable land, resulting in a shortening of fallow periods. This may cause a decrease in soil fertility, that could be exacerbated by the introduction of animal traction and subsequent additional demand for land. Production strategies are often oriented towards ensuring sufficient food for home consumption, so that increases in total production, expected by project staff, fail to materialize (Kalb, 1982).

Rogers and Shoemaker (1971) have emphasized that what really matters in the adoption of any innovation is the way the project is perceived by potential adopters. Five criteria should be fulfilled: observability, trialability, complexity, relative advantage and compatibility. Thus target farmers should be able to observe animal traction in operation over a period of time, and be able to try it out for themselves. Where complex new techniques are involved intensive training will be required and the project may appear less attractive to

the target group. Thus, rather than offering a complete package of new techniques, a step-wise approach is recommended. Relative advantage of an innovation to development planners might be primarily economic but small farmers, at a subsistence level, may place more importance on social prestige, social approval, and relief from drudgery relegating economic factors to a secondary level. Finally the innovation must not only be compatible with socio-cultural values and previous experiences of the target group but must also meet the felt needs of the group.

Starkey (1984) quotes an example from Zaire where a complicated matrilineal inheritance system meant that a farmer's assets, such as ox, plow and cart pass to his nephew on his wife's side rather than his son. This naturally restricted the interest of the son in working with his father on the project. Jealousy was also a strong factor in the project area, with reports of reprisals being taken against individuals who appeared to be flourishing, which acted against the adoption of animal traction with its high cost and status implications.

The inclusion of cattle for the first time in a farming system requires radical changes. Any such development project would have to take a long-term view with a funding horizon extending for at least eight years. Demonstration units would be needed, and pioneer farmers would have to be identified, trained and provided with necessary animals and equipment so that others could see the innovation and relate it to their own circumstances. Barratt, Lassiter, Wilcock, Baker and Crawford (1982) have shown that the learning curve for animal traction extends up to four years. In the early stages mistakes are made and benefits are not maximized. Premature extension of the project could lead to disenchantment and disillusionment, to the detriment of longer-term objectives.

Summary and conclusions

None of the difficulties of introducing animal traction to the humid zone are insurmountable. Problems would be fewer where farmers already are familiar with handling cattle, in the derived savannah rather than the forest zone, where additional land is available, and where infrastructure is in place to market a cash crop and provide necessary inputs.

Given that funds for development are not unlimited it is necessary to select projects with the best chance of success. Animal traction is never an easy target because of its many interacting facets and the complexity of the infrastructure required. As a guide it should be simpler to establish animal traction in lower rainfall areas than the humid zone, and in highland rather than lowland areas. Exceptions can be found to any general rule and individual countries will have different priorities within their development plans. However in the opinion of this author the general development of animal traction within the humid zone should be deferred until softer targets have been tackled. When more of the necessary preconditions have been achieved through the adaption of existing farming systems, animal traction could eventually be viewed as a natural addition, instead of a "big bang" change.

A final word of warning from Eicher and Baker (1982). Africa's history over the last 50 years is littered with discontinued animal traction schemes sponsored by missionaries, colonial governments, and more recently foreign aid programmes. "Waves" of animal traction have appeared, only to disappear or recede during periods of drought, changes in government policy and the failure to provide veterinary support services. Sponsors of any scheme, foreign and domestic, must be prepared for a long-term commitment, without which a potentially sound project may flounder through lack of resources before it has reached maturity.

References

- Akinwumi, J. A. and Ikpi, A. E. 1985. Trypanotolerant cattle production in Southern Nigeria. ILCA Research Report, Ibadan, Nigeria.
- Barratt, V., Lassiter G., Wilcock, D., Baker, D. and Crawford, E. 1982. Animal traction in Eastern Upper Volta: a technical, economic and institutional analysis. International Development Paper 4. Department of Agricultural Economics, Michigan State University, East Lansing, Michigan, USA. 118p. (E,F).
- Barrett, V. 1985. Animal Traction in Burkina Faso. pp. 39-41 in: S. V. Poats, J. Lichte, J. Oxley, S. L. Russo and P. H. Starkey (Editors) Animal Traction in a Farming Systems Perspective. Network Report No. 1, Farming Systems Support Project (FSSP), University of Florida, Gainesville, Florida, USA. 187p. (E,F).
- Butterworth, M. H. 1985. Beef cattle nutrition and tropical pastures. Longman, England. 500p. (E).
- Crowder, L. V. and Chheda, H. R. 1977. Forage and Fodder Crops. pp. 127-159 in: C. L. A. Leakey and J. B. Willis (Editors). Food crops of the lowland tropics. Oxford University Press, U.K. (E).
- Delgado, C. L. and McIntire, J. 1982. Constraints on oxen cultivation in the Sahel. American J. Agric. Economics 63: 188-196. (E).
- Doppler, W. 1978. Einführung in die Projektplanung und Beurteilung. Stuttgart, Hohenheim, Germany. (G).
- Doppler, W. 1980. The economics of pasture improvement and beef production in semi-humid West Africa. GTZ, Eschborn, Germany. 195p. (E).
- Eicher, C. K. and Baker, D. 1982. Research on agricultural development in sub-Saharan Africa: a critical survey. MSU International Development Paper No. 1. Department of Agricultural Economics, Michigan State University, East Lansing, USA. 335p. (E).
- Faye, A. 1985. Project experiences in Senegal. pp.43-45 in: S. V. Poats, J. Lichte, J. Oxley, S. L. Russo and P. H. Starkey (Editors) Animal Traction in a Farming Systems Perspective. Network Report No. 1, Farming Systems Support Project (FSSP), University of Florida, Gainesville, Florida, USA. 187p. (E,F).
- Goe, M. R. and McDowell, R. E. 1980. Animal traction: guidelines for utilisation. International Agricultural Development Monograph 81. Cornell University, Ithaca, NY, USA. 84p. (E).
- Jahnke, H. E. 1982. Livestock production systems and livestock development in Tropical Africa. Kieler Wissenschaftsverlag Vauk, Kiel, Germany. 253p. (E).
- Kalb, D. 1982. Sociological aspects of the use of draught animals on African smallholdings. In: P. Munzinger (Editor). Animal traction in Africa. GTZ, Eschborn, Germany. 490p. (E,F,G).
- MacLennan, K. J. R. 1970. The epizootiology of trypanosomiasis in livestock in West Africa. pp.751-765 in: H. W. Moulding (Editor). The African trypanosomiasis. Allen and Unwin, London. (E).
- Munzinger, P. 1982a. Development and situation of animal traction in Africa and conditions limiting further promotion. pp. 13-61 in: P. Munzinger (Editor). Animal traction in Africa. GTZ, Eschborn, Germany. 490p. (E,F,G).
- Munzinger P. 1982b. Economic aspects of using draught animals. pp. 269-337 in: P. Munzinger (Editor). Animal traction in Africa. GTZ, Eschborn, Germany. 490p. (E,F,G).
- Nye, P. H. and Greenland, D. J. 1960. The soil under shifting agriculture. Technical Communication No. 51. Commonwealth Bureau of Soils, C.A.B., Farnham Royal, Bucks, England. (E).
- Ogor, E. and Hedrick, D. W. 1963. Management of natural pasture (range grazing) in West Africa. Journal of the West African Science Association 7: 145-153. (E).
- Owen, S. 1985. Animal traction experiences in the Gambia. pp. 37-38 in: S. V. Poats, J. Lichte, J. Oxley, S. L. Russo and P. H. Starkey (Editors) Animal Traction in a Farming Systems Perspective. Network Report No. 1, Farming Systems Support Project (FSSP), University of Florida, Gainesville, Florida, USA. 187p. (E,F).
- Rattray, J. M. 1960. The grass cover of Africa. Agricultural Studies No. 49. Food and Agricultural Organization, Rome, Italy. 168p. (E).
- Rogers, E. M. and Shoemaker, F. F. 1971. Communication of innovations: a cross-cultural approach. New York, USA. (E).
- Sargent, M. W., Lichte, J. A., Matton, P. J. and Bloom, R. 1981. An assessment of animal traction in francophone West Africa. Working Paper 34. Department of Agricultural Economics, Michigan State University, East Lansing, USA. 101p. (E,F).
- Schonherr, S. 1975. Neue Extensionsmethoden zu beschleunigter Verbreitung agrarischer Innovationen. In: G. Wurzbacher (Editor). Störfaktoren der Entwicklungspolitik Empirische Materialien zur Entwicklungsländerforschung. Stuttgart, Germany. (G).
- Starkey, P. H. 1982. N'dama cattle as draught animals in Sierra Leone. World Animal Review 42: 19-26. (E,F,S).
- Starkey, P. H. 1984. The use of draught animal power in the Kasai occidental and Kasai oriental regions of Zaire. Report to the British Overseas Development Administration, London, U.K. (unpublished). 41p. (E,F).
- Starkey, P. H. 1985. Preconditions for successful animal traction adoption. pp.67-75 in: S. V. Poats, J. Lichte, J. Oxley, S. L. Russo and P. H. Starkey (Editors). Animal Traction in a Farming Systems Perspective. Network Report No. 1, Farming Systems Support Project (FSSP), University of Florida, Gainesville, Florida, USA. 187p. (E,F).
- Zalla, T. 1976. A proposed structure for the medium term credit program in the Eastern O.R.D. of Upper Volta. African Rural Economy Program Working Paper No. 10. Department of Agricultural Economics, Michigan State University, East Lansing, USA. (E).

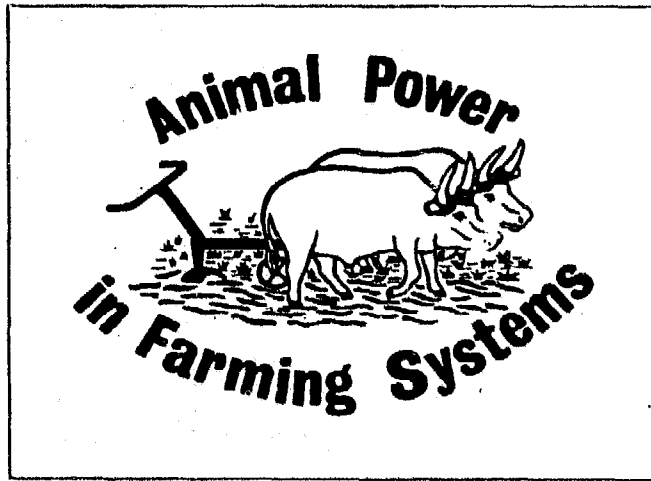

Research on Animal Power at International Centres



Tile photograph (over)
Tropicultor wheeled toolcarrier in use at ICRISAT Centre at Patanacheru, India
(Photo: Paul Starkey)

Low-cost modifications of the traditional Ethiopian tine-plow for land-shaping and surface drainage of heavy clay soils: preliminary results from on-farm verification

by

S. Jutzi, F. M. Anderson and A. Astatke

International Livestock Centre for Africa (ILCA), Addis Ababa, Ethiopia

Abstract

The traditional ox-drawn Ethiopian ard plow ("maresha" in Amharic) has been modified at the International Livestock Centre for Africa (ILCA) (1) for use in the construction of terraces for soil conservation and (2) for the construction of raised beds and furrows to facilitate surface drainage on heavy clay soils. These two modifications are described in this paper and results from on-station and on-farm tests are reported.

The plow for terrace making has slightly lower power requirements than the traditional plow, while the plow for making raised beds requires about 50% more power than the traditional implement. Both implements can be drawn by a pair of the light (250 kg) East African Short-horned Zebu. Level terraces, four metres wide, can be established by three cultivating passes on an 8% slope. Raised beds 20 cm high and 120 cm wide can be established at a rate of 0.4 to 1.2 ha per day (7 hours' work) per oxen-pair, depending on the required uniformity of the raised beds and on the moisture status of the soil.

The surface drainage facilitated by the furrows between the beds increased bread wheat yields on farmers' fields by about 80% as compared with the traditional method of land cultivation on flat land. These beds also facilitate weed control.

In a cereal-pulse area of the Ethiopian highlands where raised beds are traditionally made by hand, the human labour input required was reduced from 60 hours/ha to 16 hours/ha when using the new ox-drawn implement.

Incremental costs of the two modifications are US\$5 for the terrace-plow and US\$25 for the raised-bed-maker. Both modifications can be made by village craftsmen.

Introduction

In the Ethiopian highlands land cultivation is almost exclusively done using animal power. The traditional wooden plow ("maresha") has a sharply pointed metal tine and a metal hook tied to the handle of the plow. Two flat wooden wings are fitted by the hook to the handle and by a steel pin to the beam on either side of the implement. This simple implement is owned by almost all farmers. However only about one third of all highland farmers own two oxen (Ethiopian Ministry of Agriculture, unpublished data), and the majority have to enter some of the many forms of traditional renting and exchange agreements for draught oxen in order to plow their land.

To help relieve this ox-power constraint, ILCA developed a yoke and harness, and a modified version of the local plow suitable for use by a single ox. This modification has been described elsewhere (Gryseels *et al.*, 1984). A report on its on-farm performance was prepared by Gryseels and Jutzi (1986).

This paper reports on two further modifications which allow controlled soil movement. The traditional plow basically only scratches the soil, lifts and slightly turns it equally on

either side of the plow and leaves a furrow and two small ridges behind. The first modification (henceforth called "terrace-plow") is a device to shift soil to one side when plowing. As it can turn soil in either direction, depending on its setting, it acts as a reversible plow. The second modification (henceforth called "Broad-Bed-Maker" or "BBM") is devised to shape the topsoil into broad beds and furrows (BBF), i.e. raised beds with furrows in between, for the drainage of excessive surface water on heavy clay soils. Both modifications have been developed within ILCA's Highlands Programme, based at Addis Ababa, Ethiopia.

Detailed descriptions of both modifications are given. Their potential use and their impact on soil and water conservation, crop yields and farm-level labour economy are discussed on the basis of the first on-station and on-farm verification trials.

The terrace-plow

Description and operation

The terrace-plow modification is made by removing the two flat wings of the "maresha" and by replacing them with a wooden mouldboard-shaped wing which is reversible, i.e. can be shifted from one side of the beam to the other without being detached from the implement. The wing has a steel sheet reinforcement at its tip through which two metal rings pass to loosely fasten the wing to the handle of the plow. The metal rings are made of reinforcing rods designed for concrete. The wing is fixed to the beam using the same metal pin used to fasten the two traditional flat wings to the beam (Figure 1).

When the wing is to be changed to the other side of the beam, the fixing pin is pulled out and the wing is swung around underneath the beam to the other side, where it is fixed again with the same pin. Thus the frame of the traditional plow does not need any modification for its use as a terrace-plow. The mounting of the

reversible wing to the plow takes about 3 minutes.

The cost of the wing, including a 40 cm long and 5 cm wide metal sheet of about 4 mm thickness, two bolts of 7 cm, about 80 cm of 10 mm iron reinforcing rod with two welding points, and about 3 kg of hardwood (preferably *Acacia*) shaped as a mouldboard, is of the order of US\$5.

The operation of the terrace-plow does not substantially differ from the traditional plow, except that the reversal of the wing is needed at the end of each pass in order to shift soil in one way only.

Performance

Animal power consumption by the implement was measured using the method described by A. Astatke *et al.* (1986). The force exerted by each pair of oxen was measured with a portable, battery-powered dynamometer (Novatech Measurements Ltd., UK) consisting of a loadcell inserted between yoke and drawbar of the plow and a digital indicator connected to the load cell by a cable. The minimum and maximum force (kN) over a 20 m distance and the time taken to travel the 20 m were recorded. The working heights of both the yoke and the implement hitch and the length of the draft chain were measured, and the force parallel to the ground was calculated. Power consumption was established by multiplication of actual force exerted (kN) by speed (m/sec).

Power consumption for the third pass of plowing with the traditional plow is about 660 W (SD 112) (A. Astatke and Matthews, 1982). Power consumption of the terrace-plow used at the same stage of land cultivation (after second plowing) is 534 W (SD 110), about 80% of the power requirements of the local plow (Jutzi, unpublished data). The decrease in power requirement is explained by the fact that the terrace-plow penetrates less deeply into the soil in shifting loose soil to one side.

On a field of 8% slope with clay-loam soil, an average of 3.3 passes was sufficient to establish level terraces of 4 m width. The borders of the terraces (about 30 cm high) were stabilized with rows of *Sesbania sesban*.

In a seven-hour day, an ox-pair prepared 1911 m² (SD 298) of finished terraces on this slope. Twenty-two terraces of 420 m length were monitored. With one pair of oxen, it is therefore possible to cover about 1 ha in 5 days, which is roughly the time input for land cultivation using the traditional plow.

There is therefore no incremental time input required over normal cultivation for the estab-

lishment of terraces. The terraces reduce soil loss and conserve water through the reduction and slow down of run-off. More stable crop yields can be expected immediately, through the water conservation effect of terracing. In the longer term improvements can be anticipated through the effects of terracing on soil conservation.

The broad-bed-maker (BBM)

Description and operation

Much evidence indicates that waterlogging is a strong constraint to plant growth on deep black clay soils, also known as Vertisols or

Figure 1. Traditional maresha plow, new terrace-plow and detail of terrace plow wing

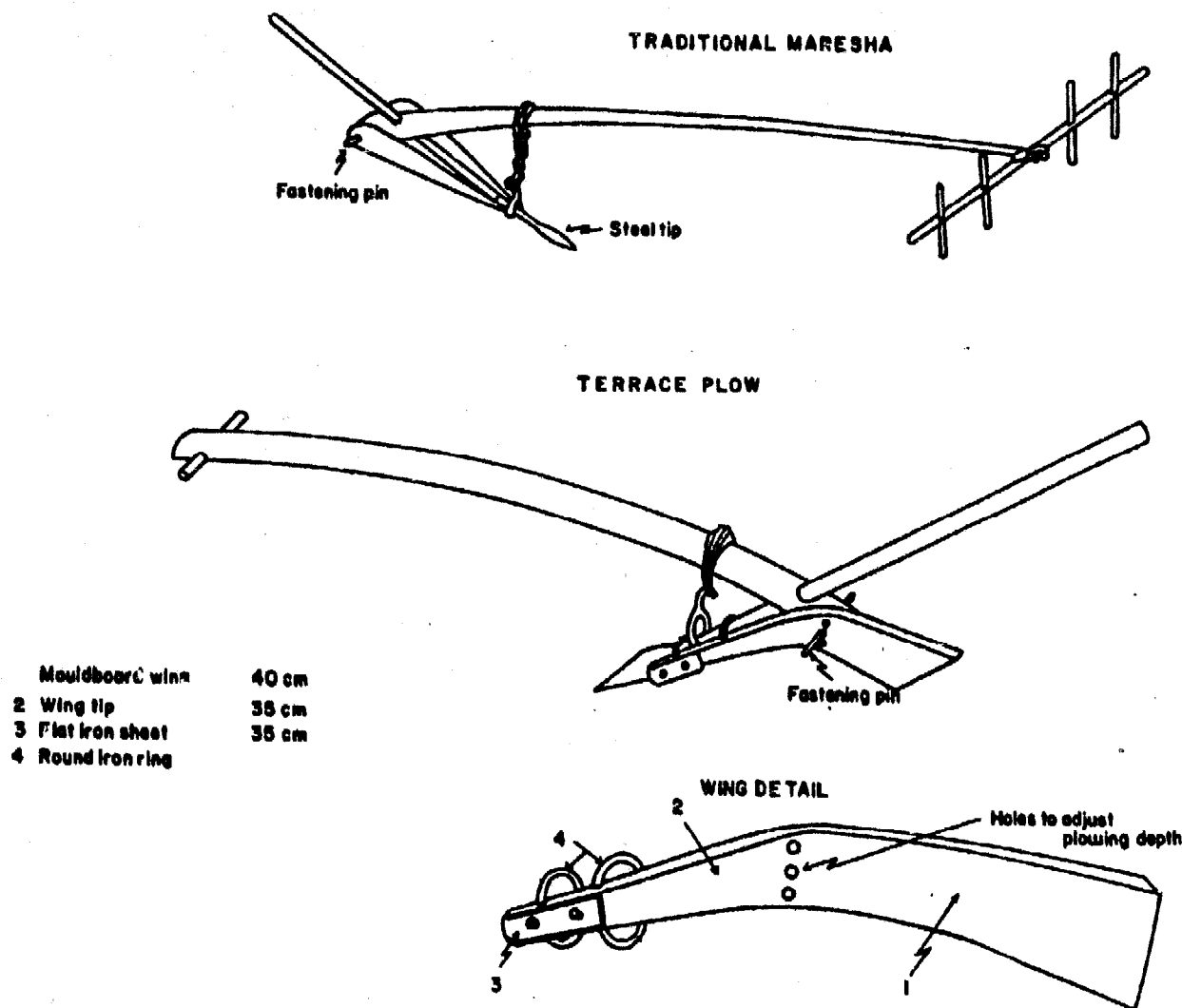

"black cotton soils" (Kanwar *et al.*, 1982; Ryan and von Oppen, 1983; Haque and Jutzi, 1984). This waterlogging is especially serious in high rainfall areas.

ICRISAT (International Crops Research Institute for the Semi-Arid Tropics) began experimenting in the mid 1970's with different systems of surface soil drainage to overcome this constraint (ICRISAT, 1986), and developed an animal-drawn toolcarrier with a number of attachments. The ICRISAT implement is effective but expensive. Lower-cost devices are essential for successful application of improved land management practices in the prevailing subsistence farming systems of sub-Saharan Vertisol areas. These account for 97 million ha of Africa. ILCA therefore developed a broad-bed-maker based on the local plow with attention given to low external inputs.

The BBM is made from two local plows. Their main beams are shortened to about 90 cm, and they are connected with a simple wooden

frame (Figure 2). The two flat wings of the traditional plow are replaced by mouldboard-shaped wooden wings, two bigger ones throwing to the centre and two smaller ones to the outside. The two handles are connected for ease of operation. Total weight of the implement is about 30 kg depending on the wood used. The weight of the traditional "maresha" is about 20 kg. The incremental cost of the BBM (additional to the two local plows needed) is about US\$25 (8 bolts, 8 m wooden poles, 8 kg hardwood for wings).

Performance and effects on crop yields and labour use

Power requirements for the BBM are higher than those for the traditional plow (O'Neil and Howell, 1986). The power consumption for both implements was established in a comparative study by measuring the force in the draft chain (using a standard Novatech load cell), the angle of pull (using a "Ferranti" potentiometric clinometer) and the forward

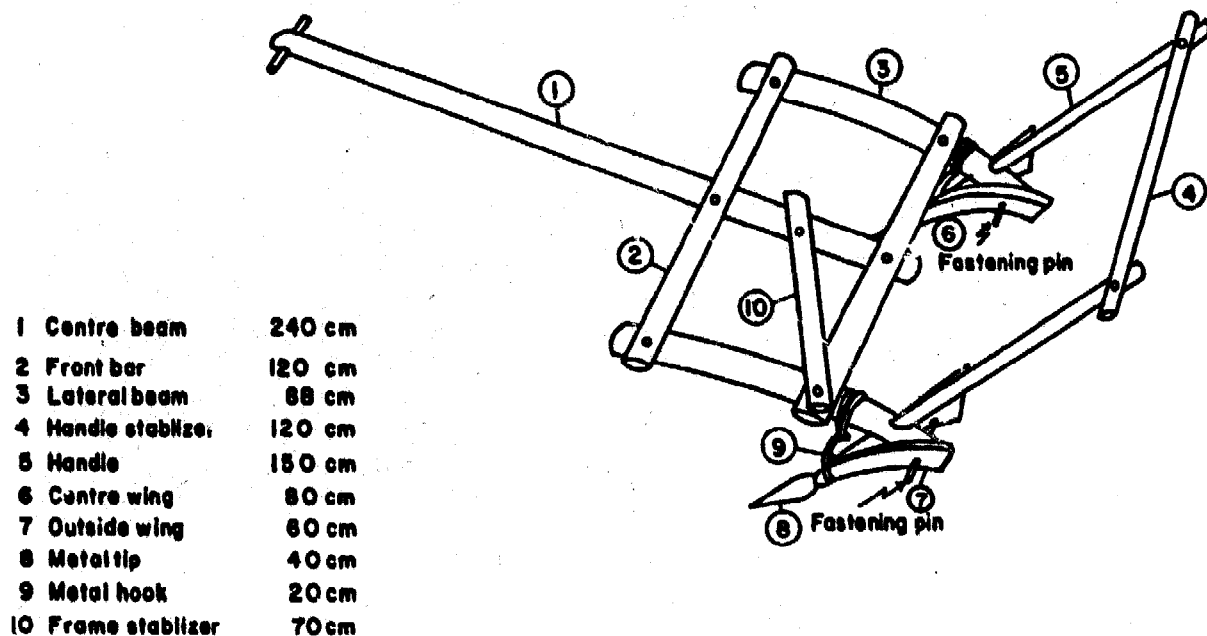

Figure 2. Broad Bed Maker (BBM), with dimensions

speed (using a "Dickey-John" radar velocity sensor).

Average power consumption of the traditional plow in a well-worked field was 398 W (SD 61, 17 observations), while the BBM consumed 634 W (SD 81, 13 observations). This power development is considerably lower than the potential power developed by the rather small (250 kg LW) local zebu (about 800 W) when hitched to the implement by a ridged neck yoke. The BBM can cover between 0.4 and 1.2 ha per day with one pair of oxen depending on the number of passes applied on each BBF and on the moisture or tith status of the top-soil. Normally 2 passes are required on any one BBF in order to provide a uniform shape of both furrow and seedbed. A chain, connected to both centre wings, acts as a simple harrow and provides uniformity in surface cultivation.

The effects of the enhanced drainage on crop growth, achieved by the BBF, are substantial. In a series of on-farm verification tests, bread wheat yields were 78% (grain) and 56% (straw DM) higher than on the traditionally managed plots (1985, 8 participating farmers). Interestingly teff (*Eragrostis abyssinica*), the Ethiopian cereal which is an important traditional Vertisol crop and supposed to be tolerant of waterlogging, reacted with a 25% (grain) and 23% (straw) increase to improved drainage (1985, 15 participating farmers). The potential impact of this low-external-inputs technology on food production in Ethiopia, which has 8 million ha of Vertisols in high-rainfall highland areas, is considerable.

In a Vertisol area with extensive traditional hand-making of broad beds and furrows (average width 1.2 m; Inewari-plateau, North Shewa, central Ethiopia), the human labour required for this operation is about 60 hours/ha. When using the BBM for this activity, the human labour input is reduced to 16 hours/ha with one implement handler only.

Thus labour productivity for crop production can be dramatically improved using BBF tech-

nology. Total labour inputs for land preparation, seeding and drainage-making in the traditional system of BB-making are about 120 hours/ha. This figure drops to 75 hours/ha with the use of the BBM. This results in a 40% increase in labour productivity on the assumption that crop yields will be the same for both systems. The implement is currently in a large on-farm verification test in this and three other areas of Ethiopia. Early indications in the mid-season 1986 are that the BBM-treated plots will outyield the traditional system because of greater uniformity of the BBFs.

Further developments

The broad-bed-maker, as described above, can be used as a toolbar.

Two prototypes of attachments to this BBM or toolbar are currently in tests:

- *A blade-harrow.*

This attachment consists of a metal blade fixed on the tines on either side of the implement and supported by an extended bolt at the rear centre of the frame. This blade harrow uniformly cuts the soil on a BBF at about 5 to 10 cm below the surface, thus uprooting most weeds. This implement contributes to a drastic reduction in power and time inputs for Vertisol cultivation, enabling the permanence of the BBF with only surface cultivation for weed management. The cost of the blade attachment is about US\$7.

- *A row-planter.*

The rear end of the BBM can also be used to support the seed hopper and agitator of a planter attachment. The rotary agitator is driven by a star-wheel running on one side of the BBM. The prototype has a double-hopper, one for seed (compartmentalized for simultaneous planting of intercrops) and one for fertilizer (for band application). This implement can plant 1 to 6 rows on the 70 cm top width of the BBF. Metering discs under the rotary agi-

tator allow planting of any conventional crop seed at desired rates. During planting, the planter attachment is simply run over the BBF. A chain attached to the two centre wings covers the seed in the planting rows. The rows are opened by metal row-makers fixed in front of the rear bar of the BBM. The cost of the planter attachment is about US\$40.

References

- Astatke, A. and Matthews, M. D. P. 1982. Progress report of the cultivation trials and related cultivation work at Debre Zeit and Debre Behan. ILCA (International Livestock Centre for Africa) Highland Programme, Addis Ababa, Ethiopia. (unpublished). (E).
- Astatke, A., Reed, J. D. and Butterworth, M. H. 1986. Effect of diet restriction on work performance and weight loss of local Zebu and Friesian x Boran cross-bred oxen. ILCA (International Livestock Centre for Africa) Bulletin 23: 11-14. (E,F).
- Gryseels, G., Astatke, A., Anderson, F. M. and Assanew, G. 1984. The use of single oxen for crop cultivation in Ethiopia. ILCA (International Livestock Centre for Africa) Bulletin 18: 20-25. (E,F).
- Gryseels, G. and Jutzi, S. 1986. ILCA's (International Livestock Centre for Africa) ox/seed project 1985. ILCA, Addis Ababa, Ethiopia. (unpublished). (E).
- Haque, I. and Jutzi, S. 1984. Effects of improved drainage and fertilization on the growth of Italian ryegrass and oats on a soil with vertic properties at Debre Behan, Ethiopia. ILCA (International Livestock Centre for Africa) Newsletter 3: 4. (E,F).
- ICRISAT 1985. The Tropiculator operator's manual: field operations. International Crops Research Institute for the Semi-Arid Tropics (ICRISAT), Patancheru, India. 62p. (E).
- ICRISAT 1986. Farming systems research at ICRISAT (International Crops Research Institute for the Semi-Arid Tropics). IARC's workshop on Farming Systems Research (FSR), 17-21 February 1986. Patancheru, A.P. 502 324, India. (E).
- Kanwar, J. S., Kampen, J. and Virmani, S. M. 1982. Management of Vertisols for maximizing crop production: ICRISAT experience. pp. 94-118 in: Vertisols and Rice Soils of the Tropics: Symposia Paper 2, 12th International Congress of Soil Science, New Delhi, India. (E).
- O'Neil, D. H. and Howell, P. J. 1986. A study of draught ox cultivation with *maresha* ploughs. Overseas Division, National Institute for Agricultural Engineering (NIAE), Silsoe, UK. (unpublished). (E).
- Ryan, J. G. and von Oppen, M. 1983. Assessment of impact of deep Vertisol technology options. Economics Program Progress Report 59, International Crops Research Institute for the Semi-Arid Tropics (ICRISAT), Patancheru, India. 14p. (E).

Modifications à bas prix de la charrue éthiopienne de travail du sol et de drainage de surface sur des sols argileux et lourds: résultats préliminaires d'essais menés en milieu paysan

par

S. Jutzi, F. M. Anderson et A. Astatke

Centre International pour l'Elevage en Afrique (CIPEA), Ethiopie

Résumé

Le Centre International pour l'Elevage en Afrique (CIPEA) a procédé à la modification de la charrue à traction bovine (un araire appelé *maresha* en Amharic) utilisée traditionnellement pour les labours en vue 1) du terrassement pour la conservation des sols et 2) de l'établissement de lits de semences et de billons susceptibles de favoriser un meilleur drainage de surface sur des sols argileux lourds. Le présent document est consacré aux résultats de ces travaux et des essais effectués en station et au niveau des exploitations agricoles.

La nouvelle charrue conçue pour le terrassement requiert une force de traction légèrement inférieure à celle qui est nécessaire pour tirer l'araire traditionnel alors que la force de traction requise pour tirer l'instrument utilisé dans la confection des billons est d'environ 50% supérieure à celle requise pour la charrue traditionnelle. Une paire de boeufs de la petite espèce de zébu *Shorthorn* de l'Afrique de l'Est suffit pour tirer chacun des deux instruments. Il est possible d'effectuer des terrasses de niveau larges de quatre mètres en trois passages avec une pente de 8%.

Le deuxième instrument permet d'effectuer des billons hauts de 15 cm et large de 120 cm avec une paire de boeufs et à une vitesse qui varie entre 0,4 et 1,2 ha par jour de 7 heures de travail selon le degré d'uniformité requis et l'humidité du sol.

Le drainage de surface réalisé grâce aux billons entre les lits de semence a permis aux exploitants d'enregistrer une augmentation des rendements

de grain d'environ 80%. Ces lits améliorés facilitent également la lutte contre les adventices. L'utilisation de la nouvelle version à traction bovine sur des terres de hauts plateaux réservées à la culture mixte des céréales et des légumineuses a permis de réduire les besoins en main-d'oeuvre de 60 à 16 heures/ha par rapport aux opérations manuelles traditionnelles. Le coût des modifications est de 5 dollars-US pour la charrue de terrassement et de 25 dollars-US pour le second instrument. En outre, ces modifications peuvent être effectuées par les artisans locaux.

Introduction

Sur les hauts plateaux éthiopiens, les labours sont presque exclusivement effectués en utilisant la traction animale. La charrue traditionnelle en bois (*la maresha*) est dotée d'une dent métallique aiguë et d'un crochet en métal relié au manche. Deux ailerons plats en bois sont reliés au manche, grâce au crochet et à l'âge, par des aiguilles métalliques situées des deux côtés de l'instrument. La quasi-totalité des agriculteurs disposent de cet instrument. Cependant, d'après des données non publiées du ministère de l'Agriculture, seul le tiers des agriculteurs des hauts plateaux possède une paire de boeufs; la plupart d'entre eux doivent louer des animaux ou conclure des accords d'échange pour l'utilisation des boeufs de labour.

Cette contrainte a amené le CIPEA à mettre au point un nouveau joug, un harnais et une version modifiée de la *maresha* pouvant être

tirée par un seul boeuf. Ce type d'instrument a été décrit par Gryssels *et al.*, (1984) et ses performances pratiques ont été signalées par Gryssels et Jutzi (1986).

Dans le présent rapport, les auteurs présentent deux autres modifications susceptibles de favoriser un contrôle du mouvement des sols. En fait, la *maresha* ne fait que retourner légèrement la terre qu'elle déverse de chaque côté pour confectionner, après le passage, un sillon et deux billons.

Le premier instrument modifié, appelé charue de terrassement a été conçu pour déverser la terre d'un seul côté, à la manière d'une charue à soc réversible. Le second matériel de préparation du sol, dénommé tourneuse de

planches ou BBM, a été par contre conçu pour confectionner des billons larges avec des sillons au milieu, pour le drainage de l'eau de surface excédentaire sur les sols argileux lourds.

Toutes les deux modifications ont été réalisées par le programme des hauts plateaux du CI-PEA, à Addis-Abeba (Ethiopie). Le présent document repose sur les premiers résultats d'essais menés en station et en milieu paysan. Le rapport décrit les deux nouveaux instruments et présente leurs performances potentielles en analysant leur impact en matière de conservation du sol et de l'eau, leur effet sur les rendements agricoles et l'économie de main-d'oeuvre qu'ils permettent de réaliser.

Figure 1. Charrue traditionnelle (*maresha*) et charrue de terrassement avec versoir

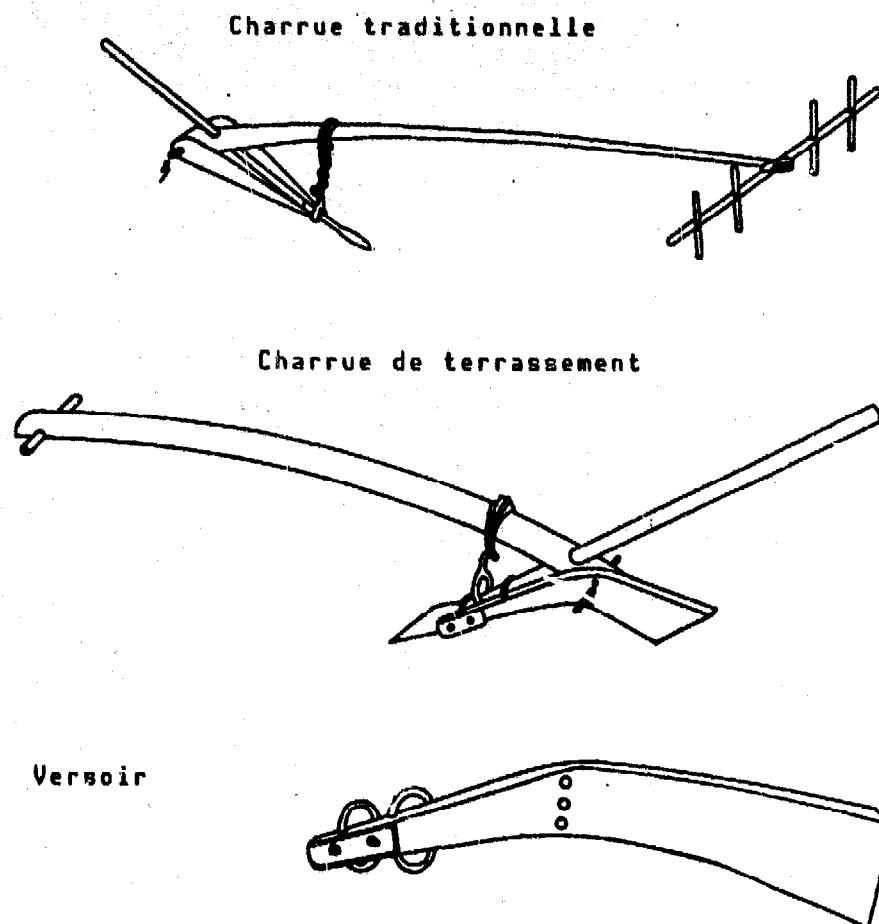

La charrue de terrassement

Description et fonctionnement

La modification consiste à enlever les deux ailerons plats de la *maresha* et à les remplacer par un aileron unique en bois en forme de versoir, et réversible; autrement dit, il peut être inversé sans que l'on ait à le détacher de l'age de l'instrument. L'aileron est renforcé à son bout par une feuille d'acier et deux bagues permettant de le relier au manche tout en conservant la souplesse du jeu entre les pièces. Les bagues sont faites de deux barres métalliques de renforcement. L'aileron est relié à l'age par la même aiguille utilisée pour les deux ailerons de l'instrument traditionnel (figure 1).

Pour inverser l'aileron, il suffit de retirer l'aiguille, de faire passer l'aileron de l'autre côté sous l'age et de remettre l'aiguille en place. De ce fait, il n'est pas nécessaire de modifier le cadre de la charrue traditionnelle. En outre, le montage de l'aileron réversible ne prend que trois minutes environ.

Le coût de cette modification est de l'ordre de 5 dollars-US couvrant l'achat des éléments suivants:

- une feuille métallique longue de 40 cm, large de 5 cm et d'une épaisseur de 4 mm;
- boulons de 7 cm;
- deux barres métalliques de renforcement de 80 cm de longueur et de 10 mm d'épaisseur avec deux points de soudure;
- environ 3 kg de bois dur (acacia de préférence) pour le versoir.

Le fonctionnement de l'instrument ne diffère guère de celui de l'araire traditionnel sauf qu'il faut inverser l'aile à la fin de chaque passage pour verser la terre du même côté.

Performance

Les mesures de la force de traction animale nécessaire pour tirer cet instrument ont été effectuées en utilisant la méthode décrite dans

Abiye Astatke *et al.* (1986). Pour les mesures de la puissance animale déployée par paire de boeufs, un dynamomètre portable à batterie (Novatch Measurements Ltd, UK) comportant un élément chargé inséré entre le joug et la barre d'attelage ainsi qu'un indicateur gradué relié à l'élément chargé par un câble ont été utilisés. La force (kN) minimale et maximale exercée sur une distance de 20 m et le temps requis pour couvrir celle-ci ont été relevés. La hauteur du joug et du point d'attelage ainsi que la longueur de la chaîne ont été mesurées et la force de frottement parallèle au sol a été calculée. Le calcul de la puissance a été effectué en multipliant la force effective (kN) par la vitesse (m/s).

Avec l'araire traditionnel, la puissance exercée lors du troisième passage est d'environ 660 W (ET = 112; Abiye Astatke et Mathews, 1982). L'instrument modifié, par contre, ne requiert à ce stade qu'une puissance moyenne de 534 W (ET = 110), soit 80 % de la puissance nécessaire pour la *maresha* (Jutzi, données non publiées). Ceci s'explique par le fait que le nouvel instrument creuse le sol moins profondément en ne versant la terre que d'un seul côté.

Sur des sols argileux et gras avec une pente de 8%, les terrasses confectionnées (hautes d'environ 30 cm) avaient été stabilisées en plantant sur les bords des rangées de *Sesbania sesban*. Sur une telle pente, une paire de boeufs a permis d'effectuer des terrasses sur une aire de 1911 m² (ET = 298). L'examen a porté sur 22 terrasses d'une longueur de 420 m. C'est dire donc qu'une paire de boeufs peut couvrir un hectare en 5 jours, soit à peu près la même performance qu'avec la *maresha*. En conséquence, la confection des terrasses ne prend pas plus de temps que les travaux traditionnels. Or, les terrasses permettent de lutter contre l'érosion des sols et favorisent la conservation de l'eau en freinant le ruissellement. On peut s'attendre immédiatement à des rendements agricoles plus stables grâce à la conservation de l'eau et, à plus long terme, à la conservation des sols.

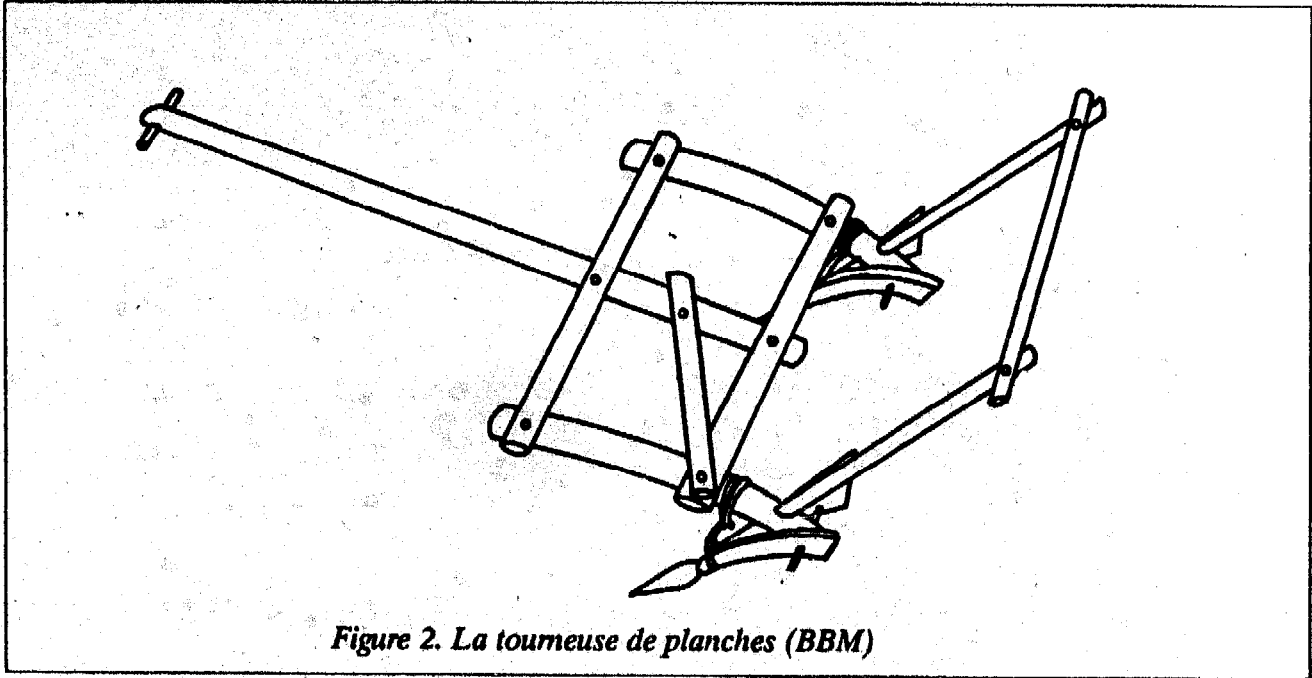

Figure 2. La tourneuse de planches (BBM)

La tourneuse de planches (BBM)

Description et fonctionnement

Il a été largement prouvé que la saturation hydrique est une contrainte majeure à la croissance végétale sur les sols argileux noirs (Kanwar *et al.*, 1982; Ryan et von Oppen, 1983; Haque et Jutzi, 1984). Cet effet dépressif est encore plus marqué dans les zones à pluviosité élevée.

Au milieu des années 70, l'Institut International de Recherches sur les Cultures des Régions Tropicales Semi-Arides (ICRISAT) a lancé des essais de drainage de l'eau de surface pour lutter contre ce phénomène et a mis au point un bâti polyvalent à traction bovine (ICRISAT, 1986). Cet instrument est efficace mais coûteux. Il est nécessaire de mettre au point des instruments peu coûteux en vue de l'adoption de pratiques culturales améliorées dans les systèmes d'agriculture de subsistance, prédominants dans les zones à vertisols de l'Afrique au Sud du Sahara avec une superficie de 83 millions d'hectares. C'est ainsi que le CIPEA a mis au point une formeuse de planches à partir de la charrue locale en tenant compte du facteur coût-efficacité.

La BBM est une version modifiée de la charrue locale. Son age a été raccourci (90 cm) et le cadre est en bois (Figure 2). Les deux ailerons plats de la charrue traditionnelle ont été remplacés par des ailes en bois en forme de versoir, les deux principales déversant la terre au centre et la plus petite sur le côté. Les deux manches sont reliés par un stabilisateur pour en faciliter le fonctionnement.

Le poids total de l'instrument est de 30 kg en moyenne selon le bois utilisé, alors que la *maresha* pèse environ 20 kg. Le coût marginal de la BBM est de l'ordre de 25 dollars-US (8 boulons, barres en bois longues de 8 m et 8 kg de bois dur pour la confection des ailerons).

Performance, rendements agricoles et main-d'oeuvre

La BBM requiert une force de traction supérieure à la puissance nécessaire pour tirer la charrue traditionnelle (O'Neil et Howell, 1986). Une étude comparative a été effectuée en mesurant la tension sur la chaîne de trait (grâce à une batterie dotée d'un élément chargé du type Novatech), l'angle de tirage (en utilisant un clinomètre potentiométrique

Ferranti) et la vitesse de travail (en utilisant un senseur de vitesse à radar Dickey-John).

La puissance requise sur un terrain bien préparé est de l'ordre de 398 W pour la charrue traditionnelle (ET = 61; 17 relevés) et de 634 W pour la BBM (ET = 81, 13 relevés). C'est dire que l'énergie nécessaire est de loin inférieure à la puissance que peut développer le zébu local (800 W) d'assez petite taille (250 kg de poids vif) lorsqu'il est attelé avec un joug d'encolure rigide.

Avec la BBM, une paire de boeufs de cette espèce peut couvrir 0,4 à 1,2 ha par jour selon le nombre de passages sur chaque BBF et selon l'humidité du sol dans la couche supérieure. Sur chaque BBF, il est en principe nécessaire d'effectuer deux passages en vue d'obtenir un profil uniforme des sillons et des lits de semence. Une chaîne reliée aux deux ailerons permet de réaliser, à la manière d'une herse simple, un grattage uniforme.

Le système du BBF (planches et sillons de drainage), grâce à son incidence positive sur le drainage permet de réaliser des accroissements substantiels des rendements agricoles. Au cours de nombreux essais sur le blé panifiable menés en 1985 en milieu paysan, avec 8 agriculteurs suivis, on a trouvé que ces accroissements étaient de 78% (grains) et de 56% (MS de la paille). Ce qui est plus intéressant encore, c'est que pour le teff (*Eragrotis abyssinica*), la principale céréale en Ethiopie, qui est une culture sur vertisols supposée résistante à la saturation hydrique, il y a eu des accroissements de rendements de 25% sur la production de grains et de 23% sur la production de MS (1985, 15 agriculteurs suivis). C'est dire donc que la nouvelle technologie est peu coûteuse et offre d'énormes possibilités en matière de production alimentaire pour les agriculteurs d'Ethiopie, pays où 8 millions d'hectares sont des hauts plateaux à vertisols, et où la pluviosité est élevée.

Les labours extensifs effectués à la main sur des vertisols requièrent pour la confection de

BBF (largeur moyenne 1,2 m; Inewari plateau, Nord Shoa, centre du pays) une main-d'oeuvre équivalente à environ 60 heures par hectare. La BBM permet de ramener ce chiffre à 16 heures par hectare avec un seul opérateur derrière la charrue.

En conséquence, la nouvelle technique d'établissement des BBF permet d'améliorer de manière substantielle la productivité de la main-d'oeuvre agricole. Dans le cadre du système traditionnel, les besoins en main-d'oeuvre pour la préparation des sols, le semis et le drainage par l'établissement de BBF s'élevaient à environ 120 heures par hectare. La BBM permet de ramener ces besoins à 75 heures par hectare, soit un accroissement de 40% de la productivité de la main-d'oeuvre, sous l'hypothèse de rendements agricoles constants. L'instrument est à présent soumis à des essais à grande échelle dans les exploitations de cette région et de trois autres zones en Ethiopie. A la mi-saison 1986, on a trouvé que le système utilisant la BBM surpassera le système traditionnel grâce à une plus grande uniformité des BBF.

Développements

La BBM décrite dans le présent document peut également être utilisée comme bâti polyvalent. Des essais sont actuellement menés avec deux instruments basés sur la BBM:

Une herse à lame

Elle est faite d'une lame métallique reliée aux dents des deux côtés de l'instrument et reposant sur un grand boulon au centre de la partie arrière du cadre. Cette herse à lame permet de creuser le sol en BBF d'environ 5 à 10 cm de profondeur, et partant, de déraciner la plupart des adventices. Cet instrument permet de réduire de manière substantielle les besoins en énergie et le temps requis pour les travaux sur vertisols, et d'établir des BBF durables; par la suite, le sarclage constitue la seule opération nécessaire. Le coût de la lame est de 7 dollars-US.

Le semoir en ligne

Le bout arrière de la BBM peut également être utilisé comme bâti pour un semoir et une souleveuse. La souleveuse à rotation fonctionne avec une roue en étoile sur un côté de la BBM. Le prototype est un instrument combiné pour le semis (divers compartiments permettent de semer simultanément différentes graines pour la culture associée) et la distribution d'engrais (pour l'épandage en ligne). Il permet de planter sur des BBF une à six lignes de 70 cm de largeur au sommet. Les disques de distribution placés sur la souleveuse permettent de semer toute sorte de culture conventionnelle au rythme voulu. Pour cette opération, le semoir doit simplement passer au-dessus des BBF. Une chaîne au centre des deux ailerons centraux recouvre les semences entre les lignes. Les lignes sont effectuées par des dents métalliques fixées en avant de la barre arrière de la BBM. Le coût marginal de l'instrument est d'environ 40 dollars-US.

Références

Astatke, A. and Matthews, M. D. P. 1982. Progress report of the cultivation trials and related cultivation work at Debre Zeit and Debre Behan. ILCA (International Livestock Centre for Africa) Highland Programme, Addis Ababa, Ethiopia. (Unpublished). (E).

Astatke, A., Reed, J. D. and Butterworth, M. H. 1986. Effect of diet restriction on work performance and weight loss of local Zebu and Friesian x Boran crossbred oxen. ILCA (International Livestock Centre for Africa) Bulletin 23: 11-14. (E,F).

Gryseels, G., Astatke, A., Anderson, F. M. and Assanew, G. 1984. The use of single oxen for crop cultivation in Ethiopia. ILCA (International Livestock Centre for Africa) Bulletin 18: 20-25. (E,F).

Gryseels, G. and Jutzi, S. 1986. ILCA's (International Livestock Centre for Africa) ox/seed project 1985. ILCA, Addis Ababa, Ethiopia. (Unpublished). (E).

Haq, I. and Jutzi, S. 1984. Effects of improved drainage and fertilization on the growth of Italian ryegrass and oats on a soil with vertic properties at Debre Behan, Ethiopia. ILCA (International Livestock Centre for Africa) Newsletter 3: 4. (E,F).

ICRISAT 1985. The Tropicutor operator's manual: field operations. International Crops Research Institute for the Semi-Arid Tropics (ICRISAT), Patancheru, India. 62p. (E).

ICRISAT 1986. Farming systems research at ICRISAT (International Crops Research Institute for the Semi-Arid Tropics). IARC's workshop on Farming Systems Research (FSR), 17-21 February 1986. Patancheru, A.P. 502 324, India. (E).

O'Neil, D. H. and Howell, P. J. 1986. A study of draught ox cultivation with maresha ploughs. Overseas Division, National Institute for Agricultural Engineering (NIAE), Silsoe, UK. (Unpublished). (E).

Kanwar, J. S., Kampen, J. and Virmani, S. M. 1982. Management of Vertisols for maximizing crop production: ICRISAT experience. pp. 94-118 in: Vertisols and Rice Soils of the Tropics: Symposia Paper 2, 12th International Congress of Soil Science, New Delhi, India. (E).

Ryan, J. G. and Von Oppen, M. 1983. Assessment of impact of deep Vertisol technology options. Economics Program Progress Report 59, International Crops Research Institute for the Semi-Arid Tropics (ICRISAT), Patancheru, India. 14p. (E).

Animal traction in improved farming systems for the semi-arid tropics: the ICRISAT experience in India and West Africa

by

R. K. Bansal^{*}, M. C. Klajj^{**} and P. G. Serafini^{***}

International Crops Research Institute for the Semi-Arid Tropics (ICRISAT)

Abstract

In the semi-arid tropics (SAT), power availability is an important constraint to crop production. Limited available power coupled with the seasonal nature of crop production can lead to severe labour bottlenecks. Uncertain rainfall and high evaporative demand dictate the timing of cultural operations. The capability for timely weeding is considered to be the principal factor limiting the area cultivated.

Improved technologies combine biological and chemical elements (such as improved varieties, crop rotations, fertilizers, plant protection and improved residue management) with elements of mechanization such as the use of animal traction (AT). The use of AT without other intensified production practices will not have an appreciable impact on productivity. Yield-increasing synergistic effects are greatest when other improved management techniques are used with a high-yield-potential variety and adequate fertility. If cropping patterns cannot be intensified, increasing population pressures will result in the use of more marginal lands.

The use of AT in the SAT is largely confined to tillage, weeding, planting and land-levelling operations. Single purpose implements are common. Multipurpose toolbars are not well known. A distinction is made between toolbars with depth gauge wheels or skids and wheeled toolcarriers (WTC). With a WTC the working depth, weight transfer, and rake angle can be precisely regulated.

AT is commonly used in India. Current AT research at the ICRISAT Centre focuses on improving the quality and timeliness of farm operations. A "technological package" for Vertisols has been developed based upon an improved soil and water management. AT and the WTC play an important role. WTCs reduced the total oxen-pair hours per hectare by 18-54%. The greatest savings occurred in tillage and sowing operations.

ICRISAT's experience in West Africa is limited to on-station research using simple AT equipment. A multidisciplinary team is evaluating AT in operational-scale on-station experiments. WTCs have been integrated into the research farm operations.

Research on AT needs to be conducted at several levels of technological sophistication relevant to the diverse enterprises and ecologies within the region. AT is relatively inexpensive, not too complicated, and can help increase productivity. The information base necessary to fully exploit AT use needs to be developed and disseminated.

Introduction

In the semi-arid tropics (SAT) the power available at the farm level is an important factor limiting crop production. Giles (1975) estimates that in India there is 0.16 kW of available power per hectare. Of this, 67% is provided by human labour and 26% by draft animals. In Africa the available power is 0.08 kW

^{*}Agricultural Engineer, ICRISAT Centre, Patancheru, AP 502 324, India.

^{**}Soil and Water Engineer, ICRISAT Sahelian Centre, Niamey, Niger.

^{***}Farm Manager, ICRISAT Sahelian Centre, B.P. 12404, Niamey, Niger.

(Approved as ICRISAT Conference Paper No: 87-018)

per hectare. The figure is probably lower in much of the West African SAT where farmers working with simple hand tools carry out all farming operations. Giles (1975) suggests that a minimum of 0.37 kW per hectare is required for high yields.

The limited power available to SAT farmers coupled with the highly seasonal nature of crop production often leads to severe labour bottlenecks. Unpredictable and uncertain rainfall dictates the timing of land preparation, planting, and weeding. High evaporative demand shortens the time available to perform those operations. As conditions become less favourable the quality of the operations is reduced. This may negatively affect plant stands, early growth, and yield. The farmers' inability to effectively use the limited available time increases the instability of rainfed agricultural production in the SAT. Although there are traditional strategies to increase the efficiency of tasks accomplished in the limited time that is available, such as mixed cropping and delayed planting of cash crops, the capability to weed in a timely fashion is generally considered to be the principal factor limiting the area farmers cultivate. Timely land preparation and planting are serious constraints (Norman *et al.*, 1981).

Improved technologies generally combine land-intensive biological and chemical elements such as improved varieties, crop rotations that include a legume, chemical fertilizer, plant protection, seed treatment, and improved residue management with elements of mechanization such as the use of animal traction (AT) and equipment. The improved labour efficiency that results from the use of AT can lead to a more land-extensive cropping strategy (McIntire, 1982). None the less Norman *et al.* (1981) concluded that intensifying land use patterns may be desirable and indeed necessary for many regions in West Africa. It is felt that, if cropping patterns cannot be intensified, increasing population pressures will result in the use of more marginal lands.

The approach of ICRISAT's Farming Systems Research Program in India has been to choose a balanced mixture of improved cropping techniques to intensify crop production on land presently under production. As a result, the animal traction component emphasizes the adaptation, improvement, and effective use of AT equipment and techniques in improved, intensified, soil and crop management systems.

In West Africa there is scope for cropping strategies that are more intensive and/or extensive; both aspects will receive attention. Whether extensive or intensive the ultimate goal is improving the productivity of farmers in the SAT. This paper will examine the use of AT for soil and crop management operations, its possible impact on farming systems, and ICRISAT's Indian and West African experiences.

Animal traction equipment

Historically, a wide range of AT implements and techniques have been used to mechanize many facets of crop production. The on-farm use of AT in developing countries is largely confined to tillage operations, weeding, planting and land levelling. Single-purpose implements such as mouldboard plows, tined cultivators, harrows, and carts are common. In West Africa, it is principally used for primary tillage and transportation. The use of carts and mouldboard plows is more widespread than other kinds of equipment. Single-row precision seeders are used for cash crops. This is sometimes combined with fertilizer application. Groundnut-lifting blades are often used to facilitate harvesting.

Multipurpose frames to which a variety of implements can be attached are less well known. There are two basic types. A distinction is made between multiple toolbars that have one or more depth gauge wheels or skids and may be used for most tillage and weeding operations, and the bigger, more sophisticated and versatile, wheeled toolcarrier (WTC). It can be used for the full range of cropping activities. It

Table 1. Average grain yield of pearl millet and sorghum crops from steps-in-technology experiments, ICRISAT Centre 1976-79

Treatments	Seed variety	Fertilizer	Management	Pearl millet	Yield increase	Sorghum	Yield increase
				(kg ha ⁻¹)	over treatment No. 1 (%)	(kg ha ⁻¹)	over treatment No. 1 (%)
1.	Local	FYM	Traditional	590		410	-
2.	HYV	FYM	Traditional	980	166	880	215
3.	Local	Recommended	Traditional	990	168	1000	244
4.	HYV	Recommended	Traditional	1420	241	2360	576
5.	Local	FYM	Improved	570		520	127
6.	HYV	Recommended	Improved	2010	341	3470	846
S.E.				+/-35		+/-120	

Notes:

FYM: Farmyard manure 10 tonnes ha⁻¹ applied in alternate years.

HYV: High yielding variety.

Recommended Fertilizer applied at 80 kg of N and 34 kg P₂O₅ ha⁻¹.

Traditional: Use of traditional methods of soil management, agronomy and implements.

Improved: Cultivation on broad bed and furrows, use of a WTC and recommended agronomic practices.

Source: Gilliver (1981)

is possible to adjust the working depth, weight transfer, and rake angle very precisely. As much as 1.5 m can be covered in one pass. As a result, it is capable of delivering timely and high quality work. In addition, most WTCs can be converted into a cart. This is an important option because it increases the opportunities for non-crop-related work and income-earning activities (Binswanger *et al.*, 1979).

On-station farming systems research

ICRISAT's mandate is to develop farming systems that will help increase and stabilize agricultural production through the more effective use of natural and human resources in the seasonally dry SAT. Research activities are carried out in two phases: disciplinary research on production factors, and interdisciplinary operational-scale research. The latter integrates promising techniques into improved systems that are applied to large enough areas to "simulate" their on-farm use.

AT has been an important feature of improved systems at both the ICRISAT Centre in India and the ICRISAT Sahelian Centre in Niger. Data is taken on water use, crop growth and

yield, pest incidence, labour use, runoff and erosion. The economic implications of this data are thoroughly evaluated. Finally the best combinations are tested on farm. Information from this stage is fed back into the factor and operational-scale research activities for appropriate refinement.

The importance of a balanced and complete set of crop materials and techniques in an improved production system should be stressed. This point is well illustrated in the "steps in technology" experiments conducted on Alfisols and Vertisols at ICRISAT Centre from 1976 to 1979 (ICRISAT Annual Report 1981, pages 218-219; Gilliver, 1981). In these experiments variety, fertilizer, soil and crop management options were compared in different combinations (see Table 1). The use of local varieties with the application of about 10 tonnes ha⁻¹ of farmyard manure every second year was considered to be a reasonable approximation of farmer practices. Average grain yields for pearl millet of 590 kg ha⁻¹ and for sorghum of 410 kg ha⁻¹ from an Alfisol were obtained. Changing a single factor such as the use of a high-yielding variety (HYV) or chemical fertilizers increased pearl millet grain yield by 166-168% and sorghum by 215-244%. The use

of both an improved variety and chemical fertilizer increased pearl millet yields by 341% to 1420 kg ha⁻¹ and sorghum yield by 576% to 2360 kg ha⁻¹.

The synergistic effects of the combined treatments were greatest when improved management techniques were used. In this case the improved management techniques included: minimal land shaping and tillage to ensure drainage and minimize erosion, the use of an animal-drawn WTC, sowing and fertilizing early in the rainy season, and timely inter-row cultivation to ensure adequate weed control. Pearl millet yielded 2010 kg ha⁻¹, an increase of 341% from the low input farmers' system, and sorghum yielded 3470 kg ha⁻¹, an increase of 846%. Improved management without a HYV or fertilizer use had virtually no effect on crop yields.

The Indian experience

In India draft animals are widely used in agriculture and for transport. At present over 80 million draft animals (Ramaswamy, 1982) and 0.7 million tractors are used to cultivate approximately 143 million hectares. Farmers primarily use oxen with a wide variety of traditional equipment for land preparation, sowing and inter-row cultivation. Oxen are commonly used for land-development activities such as field levelling, constructing anti-erosion bunds, and field drains. Traditional equipment is varied and effective (ICAR, 1960).

Most crop residues are harvested for animal feed. The transport and sale of crop residues are an important source of income for farmers. Veterinary services are reasonably good in India. This is not the case in much of SAT West Africa where livestock health problems, such as trypanosomiasis, are more serious.

Current research on animal-traction equipment at the ICRISAT Centre is focused on improving the quality and timeliness of farm

operations. This involves adapting equipment, a need that became evident from experiences in the soil and water management research activities, related agronomic and other disciplinary research, constraints observed in the operational scale research program, on-farm testing, and collaborative research activities carried out with other institutions. Local, private sector manufacturers have also been involved in prototype design, manufacturing, and testing.

In the past decade, a successful "technological package" for Vertisols has been developed based upon an improved soil and water management system. It employs the use of a zonal minimum-tillage system to construct and maintain a broad bed and furrows (BBF), with 150 cm spacing. The WTC has been used to overcome the problems of working these soils that are sticky when wet and hard when dry. The package permitted the use of these soils in the rainy season and, in certain cases, for double cropping. Traditionally only a dry season crop was grown on residual moisture. There are large areas of Vertisols in SAT India, Sudan, Ethiopia and to a smaller extent in sub-Saharan Africa, where this technology has potential (Swindale, 1981).

The WTC concept originated in Britain and France almost simultaneously in the early 1960s. A multipurpose WTC developed by the National Institute of Agricultural Engineering, U.K., was tested in Nigeria and Tanzania (Kline *et al.*, 1969). Mr. Jean Nolle, working at Bambey, Senegal, designed the "Polyculteur" and "Tropiculteur" that were tested and extended to farmers in Senegal. They were not widely adopted due to their relatively high cost and, in the case of the Polyculteur, design flaws in the toolbar lift mechanism. With some minor modifications both of these WTCs proved to be extremely versatile at the ICRI-SAT Centre. When other relevant agronomic and varietal factors were improved they effectively accomplished all cropping operations improving both yields and worker efficiency.

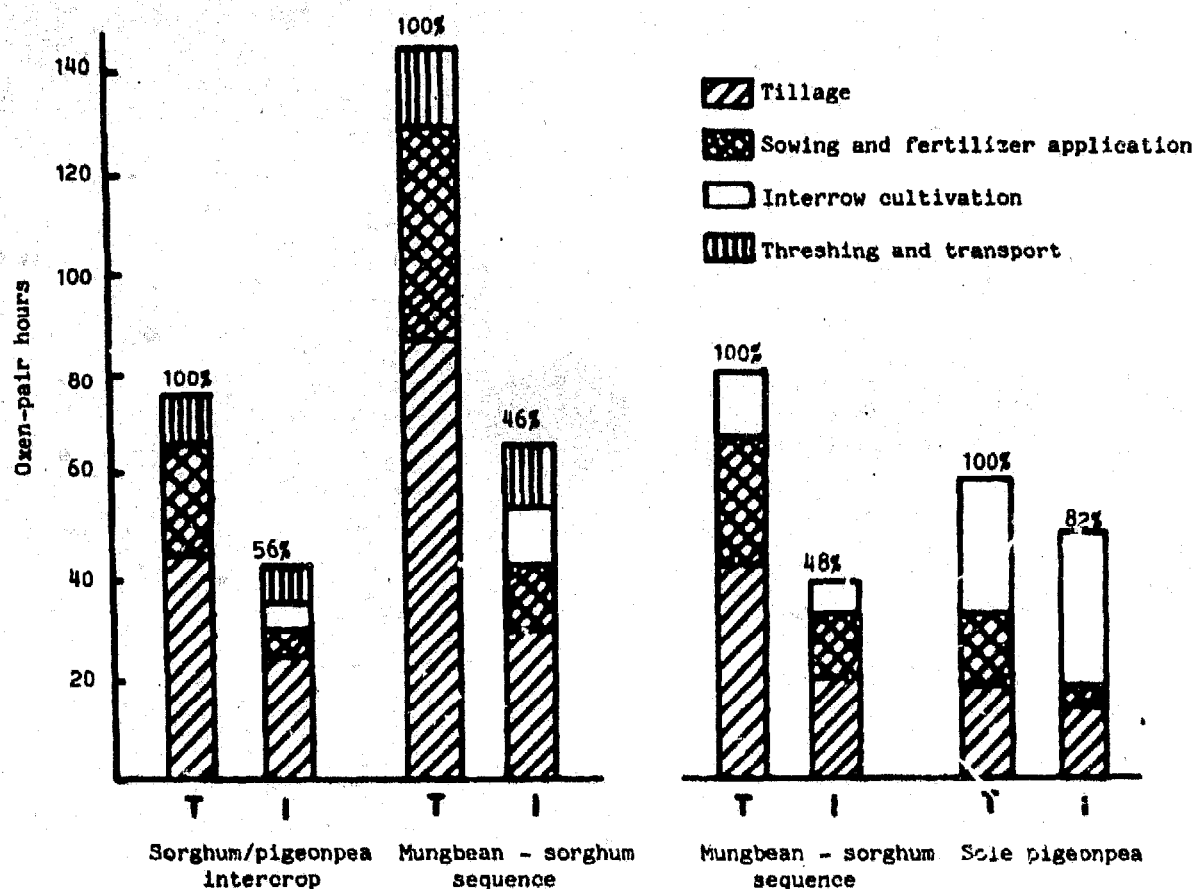

Figure 1. Oxen pair hours required using traditional (T) and improved (I) management

Early emphasis was put on the Tropicultractor. It provided adequate versatility, flexibility, and stability for the mechanization of a variety of multiple cropping systems. It was particularly effective as a crop management tool on 150 cm raised beds. Sowing and fertilizer application equipment was developed for faster and more precise seed and fertilizer placement. Metering of seed and fertilizer was also improved.

After the successful experiences at the ICRISAT Centre with the Tropicultractor, another WTC and equipment package using the "Nikart" WTC was developed in collaboration with the National Institute of Agricultural Engineering, U.K. The Nikart is lighter, easier to fabricate, and less expensive than the Tropicultractor. It features superior weight transfer characteristics, as well as better toolbar lifting and working depth adjustment mechanisms, and it is suited to manufacture by small industries in developing countries.

At the ICRISAT Centre animal-drawn WTCs have been successfully integrated in improved farming systems developed for the management of Vertisols. In the Indian SAT on-farm verification has been carried out in different regions. Data from two villages, Taddanpally in Andhra Pradesh state and Farhatabad in Karnataka state, illustrates the role of improved farm equipment in a new system of farming. Taddanpally is located about 40 km northwest of the ICRISAT Centre and has an annual mean rainfall of 750 mm. It is representative of areas with relatively reliable rainfall. Farhatabad is about 250 km southwest of the ICRISAT Centre and has a mean annual rainfall of 727 mm. There is a higher risk of mid-season drought and crop damage or loss during the rainy season at this site. In both villages farming depends entirely on draft oxen and human labour. The improved farming systems tested at these locations combined the use of HYVs for sorghum, pigeon pea, and

mung bean with fertilizers, BBF cultivation, and the use of WTCs.

The oxen-pair hours required per hectare are summarized in Fig. 1. To facilitate comparison between the traditional and improved management systems, primary tillage and seedbed preparation are grouped under "tillage". In the traditional management system, manure application, sowing, and seed covering are grouped under sowing and fertilizer application.

The WTC reduced the total oxen-pair hours required per hectare by 18-54% depending on cropping system and location. The greatest time savings occurred in the tillage and sowing operations. The WTC covers an effective width of 1.5 m with each pass whereas a country plow covers only 15 cm and most other traditional implements cover 60-75 cm. The 50-75% savings in the time required for sowing operations are particularly important. The availability of good planting conditions is often limited in the SAT due to the erratic nature of early season rainfall. The WTC can be fitted to sow and fertilize simultaneously. Traditionally sowing involves two operations, one for placing the seed and the other for covering it and firming the seedbed. Accurate and timely seed and fertilizer placement with the WTC substantially

contributes to improved crop stands, early growth and yields.

It has been shown at the ICRISAT Centre that with one pair of oxen and traditional equipment it is possible to double-crop only 4-7 ha while a WTC has been used to effectively farm 12-15 ha (Ryan and Sarin, 1981). It is not the source of power, but rather the use of improved soil management systems and equipment that is important for the intensification of AT based farming systems.

Work patterns and productivity were also affected by the use of the WTC-based improved management system (Ghodake and Kshirsagar, 1983), but the total labour requirements were not (Table 2). In Taddanpally, where double cropping is practised, the use of a WTC led to substantial labour savings for field operations, but higher yields increased the labour requirements for harvesting and threshing. In Farhatatabad, tillage and weeding operations with the improved system required slightly more labour than the traditional system. The additional labour was largely provided by women who removed the pigeon pea stubble from the fields to facilitate sowing. The women's labour contribution increased by 12% at Taddanpally and by 22% at Farhatatabad. Labour productivity

was defined as the grain yield per person-hour. The use of improved animal-drawn equipment, high yielding varieties, and fertilizer increased labour productivity from 1.71 to 2.97 kg person-hr⁻¹ ha⁻¹ at Taddanpally

Table 2. Average human labour utilization for farm operations in selected cropping systems at two locations of on-farm testing in India during 1982-83

	Taddanpally		Farhatatabad	
	Traditional hour ha ⁻¹	Improved hour ha ⁻¹	Traditional hour ha ⁻¹	Improved hour ha ⁻¹
Tillage and seedbed preparation	80	46	64 (42)	72 (76)
Sowing and fertilizer application	55	14	34 (37)	16 (33)
Inter-row cultivation	240 (86)	196 (90)	179 (80)	219 (91)
Plant protection		22	28	29
Harvesting and threshing	315 (59)	405 (77)	276 (62)	270 (92)
	690 (60)	683 (72)	571 (61)	606 (83)

Figures in brackets show female labour expressed as a percentage of the total.

Table 3. Grain yield (kg ha⁻¹) for selected cropping systems and labour productivity in two villages in India, 1982-83

	Taddanpally		Farhatabad	
	Traditional	Improved	Traditional	Improved
Sorghum	980	1953		
Pigeon pea (intercrop)	189	696		
Mung bean	786	802	341	541
Sorghum (seq. crop)	409	612	1248	1456
Pigeon pea (sole crop)		72 ^a	1350	
Average grain yield	1182	2031	1159	1673
Yield man-hour ⁻¹	1.7	2.97	2.03	2.76

and from 2.03 to 2.76 kg person-hr⁻¹ ha⁻¹ at Farhatabad.

Although ICRISAT is not actively doing so, the quality of the power source, the oxen, could be improved through appropriate breeding. It is possible that the number of animals necessary for AT activities could be reduced if higher quality cattle were available.

The West African experience

ICRISAT's experience in West Africa is limited to on-station research, operational and training activities in Mali (1978-1983) and more recently at the ICRISAT Sahelian Centre (ISC), 42 km southeast of Niamey, Niger.

A resource management research programme is now fully established at the ISC. Staff participating in this research area include an agroclimatologist, a soil chemist, a soil and water management engineer, a cowpea breeder/agronomist, a millet agronomist, a farming systems agronomist, an animal nutritionist and an economist. Most research is still addressing the performance and interactions of various production factors although an

operational-scale experiment based on the synthesis of promising results from the more basic research activities was started in 1986. The treatment combinations were based on the use of phosphate fertilizer, rotations of improved millet and cowpea varieties, and animal traction for pre-planting cultivation and inter-row weeding. The plots were large enough for measuring material and labour inputs.

The AT component involved pre-planting ridging using a single-mouldboard plow pulled by a pair of oxen. Ridges were spaced 1.5 m apart. Preliminary results indicate that ridging took

Table 4. Labour and animal traction utilization for cropping operations during operational-scale research experiment, ICRISAT Sahelian Centre, rainy season 1986

Operation	Hand cultivation (person-hr ha ⁻¹)	Animal traction [*] (person-hrs ha ⁻¹)	SE
RIDGING	-	12.8	+/- 1.2
PLANTING: Traditional			
Millet/cowpea	33.3	28.7	0
PLANTING: Improved			
Millet	21.5	21.5	0
Cowpea	64	64	0
Millet/cowpea	26	26	0
WEEDING (1st) ^{**}			
Millet/cowpea	103.0	26.7	+/- 6.38
Millet	106.0	28.9	+/- 5.04
Cowpea	158.2	75.4	+/- 4.32
WEEDING (2nd) ^{**}			
Millet/cowpea	54.8	33.8	+/- 4.36
Millet	45.0	34.4	+/- 5.62
Cowpea	35.8	39.6	+/- 4.47

Notes

* Weeding data are the sum of the time for inter-row cultivation using one operator working with one pair of oxen (time requirement range 3.5-4 person-hours ha⁻¹) and hand weeding within the row.

** Weeding with spring-tined cultivator

13 h ha⁻¹. Hand planting traditional millet and cowpea required 33 person-hr ha⁻¹. The more densely planted improved millet required 21.5 person-hr ha⁻¹ and sole cowpea 64 person-hr ha⁻¹.

The first weeding of AT-cultivated plots required less than 25% to 50% of the time spent weeding by hand depending on the cropping system. A tined cultivator was used for the AT weeding. Ridging reduced weed populations and the AT tine-cultivator was much faster than hand cultivation. The second AT weeding required 46% of the time spent in hand weeding because inter-row weeding still had to be done by hand (Table 4).

While the simplest and most widespread AT equipment has been used for experimental purposes, the "Nikart" WTC is used for regular general operations of the research farm at the ICRISAT Sahelian Centre. Trees and shrubs outside designated windbreaks were pulled by hand and removed with horses. Primary tillage, fertilization, seeding, and weeding were accomplished with three "Nikarts". Two pairs of oxen or cows were used per AT equipment unit during the day to develop and crop a total of 25 hectares. Ridging and weeding operations were carried out on another 120 ha. Each equipment unit effectively accomplished a quarter of the work of a 40 kW tractor. The quality of the operations carried out was equivalent or superior to the same operations accomplished with a tractor. The experience on the research station at Cinzana in Mali with the Nikart is similar.

Research needs and networking

Any agricultural research institution in the SAT must conduct research and farm operations at several levels of technological sophistication relevant to the diverse farm enterprises and ecologies within the region. Although a significant part of our programme is carried out with hand labour or tractors, AT offers an intermediate alternative that is relatively affordable, not too sophisticated, and, if

properly applied, can effectively help farmers to increase their agricultural productivity.

ICRISAT has demonstrated that a properly conceived, AT-based crop management strategy can have significant impact on productivity. It has also been shown that the BBF system is applicable primarily on Vertisols with relatively reliable rainfall.

India has a long and sophisticated tradition of AT use. In West Africa, efforts to introduce and intensify the use of AT began in this century. ICRISAT should exploit the Indian-African contrast while exploring the possibilities for AT in the future.

In Africa, it is important that the information base necessary to fully exploit AT use be developed and disseminated. Appropriate techniques exist but are often unknown to those who could best benefit from their use. In some cases existing techniques need to be adapted through appropriate research to become most effective. Whatever be the case, it is only by working with animal traction techniques and equipment on both the production and research level that the potential of AT will be realized.

Conclusion

The use of AT and equipment is commonplace in India. In West Africa it was almost unknown as recently as 50 years ago, and it is still not widely practised. Increasing population pressure makes the intensification of crop production inevitable although in Africa, population densities are generally lower than in South Asia. The technical characteristics and adoption patterns of the animal traction component will necessarily reflect these and other differences.

As an isolated technique the introduction or intensification of AT use has not had a substantial effect on farmer efficiency. However, when it has been coupled with improved biological and chemical technology, appropriate soil management techniques, and adapted

equipment there have been substantial and sustainable increases in production. Furthermore, significant synergistic interactions exist between AT use and other crop production techniques.

AT has an important role to play in strengthening agriculture. The exchange of information among cooperating institutes on implements and tools, agricultural mechanization programmes and relevant technological developments will accelerate this process.

References

- Binswanger, H. P., Ghodake, R. D. and Thierstein, G. E. 1980. Observations on the economics of tractors, bullocks and wheeled tool carriers in the semi-arid tropics of India. pp. 199-212 in: Socioeconomic constraints to development of semi-arid tropical agriculture. Proceedings of an international workshop held February 1979, Hyderabad, India. ICRISAT, Patancheru, India. 436p. (E).
- Ghodake, R. D. and Kshirsagar, K. G. 1983. Employment generation potential of deep Vertisol technology in semi-arid tropical India. Presented at the Seminar on Rural Employment Policies in Asia, 7-10 Dec 1983. Asia Regional Team for Employment Promotion, Pattaya, Thailand. Reprint available from ICRISAT, Patancheru, India. (E).
- Giles, G. W. 1975. The reorientation of agricultural mechanization for the developing countries. Part 1. Policies and attitudes for action programs. *Agricultural Mechanization in Asia* 6 (2): 15-25. (E).
- Gilliver, B. 1981. Steps in technology: results of experiments conducted from 1976 to 1979 at Patancheru A. P. 502 324, India. Statistics Unit Report 1/81. International Crops Research Institute for the Semi-Arid Tropics (ICRISAT), Patancheru, India. (Restricted publication). (E).
- ICAR 1960. Indigenous agricultural implements of India: an all-India survey. Edited by D. Raghuvan. Indian Council of Agricultural Research, New Delhi, India. (E).
- ICRISAT 1981. Annual Report 1979/80. International Crops Research Institute for the Semi-Arid Tropics, Patancheru, A.P. 502 324, India. (E).
- Kline, C. K., Green, D. A. G., Donahue, R. L. and Stout, B. A. 1969. Agricultural mechanization in Equatorial Africa. Research Report No. 6, Institute of International Agriculture, Michigan State University, USA. 181p. (E).
- McIntire, J. 1982. Reconnaissance socioeconomic surveys in north and west Upper Volta. Progress report 3, ICRISAT Economics Program, Ouagadougou, Burkina Faso. (Available from ICRISAT, Patancheru, India). (E).
- Norman, D. W., Newman, M. D., and Ouedraogo, I. 1981. Farm and village production systems in the semi-arid tropics of West Africa: an interpretive review of research. Research bulletin No.4, Vol. 1. International Crops Research Institute for the Semi-Arid Tropics (ICRISAT), Patancheru, India. (E).
- Ramaswamy, N. S. 1982. The mechanization of bullock cart system and the management of animal resources. Report submitted to Department of Science and Technology. Indian Institute of Management, Bangalore, India. 103p. (unpublished). (E).
- Ryan, J. G. and Sarin, R. 1981. Economics of technology options for deep Vertisols in the relatively assured rainfall regions of the Indian semi-arid tropics. pp 37-58 in: Proceedings of seminar on the Management of Deep Black Soils held May 1981 in New Delhi, India. International Crops Research Institute for the Semi-Arid Tropics (ICRISAT), Patancheru, India. 106p. (E).
- Swindale, L. D. 1981. An overview of ICRISAT's research on the management of deep black soils. pp. 17-20 in: Improving the management of India's deep black soils. Proceedings of workshop held May 1981 in New Delhi, India. International Crops Research Institute for the Semi-Arid Tropics (ICRISAT), Patancheru, India. 106p. (E).

Title photograph (opposite)
Demonstrating an adapted Super Eco seeder at Yundum, The Gambia
(Photo: Paul Starkey)

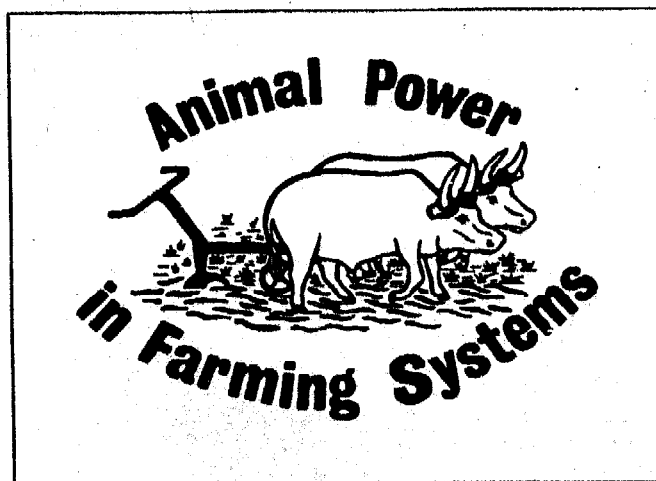

Adapting Animal Power Equipment in West Africa



Développement et adaptation de l'équipement de traction animale aux conditions locales du Département de Niamey

par

S. A. S. Harouna et R. Imboden

Artisanat Rural et Machinisme Agricole, Projet Productivité du Département de Niamey, Niger

Résumé

La cellule de l'Artisanat Rural et du Machinisme Agricole (ARMA) a été créée dans le but d'améliorer les matériels agricoles de traction animale en recherchant une collaboration avec tous les organismes nationaux qui vulgarisent ou produisent ces matériels. Un autre objectif important de cette cellule est la formation-recyclage des vulgarisateurs et des artisans ruraux impliqués dans les programmes des projets de développement agricole.

La collaboration avec ces organismes a permis de réaliser divers travaux généralement axés sur une meilleure utilisation de l'énergie animale et portant notamment sur la production d'accessoires et de pièces travaillantes, la réhabilitation de matériels aratoires, la recherche de prototypes et l'appui à la fabrication locale de modèles retenus. Les méthodes de travail de ARMA s'inspirent des principes de fiabilité et de moindre coût du matériel d'une part et, d'autre part, de son adaptation aux conditions locales et aux types d'animaux disponibles. Cela conduit ARMA à effectuer des modifications sur le matériel en fonction des besoins d'un groupe d'intérêt donné, en partant du matériel ou des possibilités et connaissances locales en termes de fabrication et de vulgarisation.

De manière générale, il n'existe pas de structure idéale pour abriter les activités de recherche-développement sur le matériel agricole. Les différentes options comportent des avantages et des inconvénients. Mais quelle que soit l'option retenue la condition minimale requise pour la réussite de l'atelier est la collaboration avec tous les partenaires en amont (notamment avec les fabricants, agronomes et zootechniciens) et, en

aval, avec les structures de vulgarisation et les utilisateurs (paysans et coopératives).

Introduction

Présentation de l'ARMA et cadre d'activités

La cellule de l'Artisanat et du Machinisme Agricole a pour but de concevoir et de développer du matériel et des équipements agricoles, à traction animale notamment. Elle assure également la formation et le suivi des artisans ruraux de la zone du projet. Cette cellule fait partie d'un projet agricole intégré: le Projet Productivité Niamey (PPN). Le PPN a pour objectif de renforcer les services techniques départementaux des ministères de l'Agriculture et des Ressources Animales en vue de promouvoir l'accroissement de la production agricole en général.

Le PPN soutient donc essentiellement des opérations ponctuelles et précises menées pour la plupart par des services techniques (élevage, production agricole, forêt et faune, animation féminine, crédit agricole) à travers un appui logistique, des subventions et des crédits à court et à moyen terme.

En plus de ces opérations d'appui, le projet mène à travers ses cellules une série d'actions:

- Formation aux thèmes agricoles modernes de jeunes couples d'agriculteurs (150 à 180) durant une campagne agricole dans

- 6 centres de perfectionnement technique et dans 17 centres villageois de formation.
- Recherche agronomique et démonstration de pratiques culturales dans ces 23 centres et dans les villages-test (28 en 1987).
- Promotion d'activités coopératives de production agricole, maraîchère et artisanale à l'aide d'un fonds d'investissement local remboursable par les intéressés.
- Renforcement de l'agence départementale de crédit agricole et préfinancement des équipements placés à crédit auprès des agriculteurs ex-stagiaires des centres de perfectionnement technique et villageois.
- Soutien aux coopératives de développement par un appui logistique et des crédits pour les approvisionnements en intrants agricoles et formation des gestionnaires et des magasiniers de coopérative.

La recherche de prototypes se fait donc au centre d'un ensemble d'activités qui assurent un feed-back du terrain et des structures de formation et de vulgarisation.

Principaux organismes en contact avec PPN-ARMA

Le Niger possède un nombre important d'organismes bien expérimentés qui travaillent dans le secteur rural et agricole et qui sont par ailleurs soutenus par des sources de financement et des organismes très divers (FAO, Banque Mondiale, USAID, FED, etc.). Les principaux interlocuteurs techniques sont les suivants:

La recherche

L'Institut National de Recherche Agronomique du Niger (IRAN) a son centre à Niamey. Il conduit des recherches dans les domaines de l'agronomie, de l'agro-économie, et de la foresterie. Il est soutenu par l'USAID, la FAO, la France, les Pays-Bas, etc. L'ICRISAT a un centre important à Sadoré, à 40 km de Niamey.

Une extension en cours de réalisation devrait faire de cette antenne le centre ouest africain. Un nombre important de chercheurs travaillent sur la recherche de nouvelles variétés et sur les systèmes de culture, y compris l'utilisation de la traction animale. Le Projet National de Machinisme Agricole, qui a récemment été mis en place dans le centre du pays, a pour but d'établir une antenne de l'IRAN à Birni N'Konni et d'établir un Comité National de Machinisme Agricole qui sera chargé de coordonner les recherches dans cette matière.

La formation et la vulgarisation agricole

L'Institut Pratique du Développement Rural (IPDR) situé à Kollo forme, sur 2, 3 et 4 ans, des agents techniques, des conducteurs de travaux et des conseillers agricoles. Cette école forme et recycle l'essentiel des cadres nigériens de l'agriculture, des forêts et de la faune ainsi que ceux de l'animation au développement. L'Ecole des Cadres de l'Élevage se trouve également à Kollo. Elle forme des cadres de différents niveaux qui rejoignent ensuite les services et projets de santé et de production agricoles. Les CPT et CVF ont formé en 1986 l'auto-encadrement paysan aux techniques agricoles.

Distribution de matériels et de crédits agricoles

La distribution des intrants agricoles se fait essentiellement par le biais des coopératives et des groupements mutualistes. Ceux-ci transmettent leurs besoins à travers les structures coopératives (locale, sous-régionale, régionale et nationale) à une centrale d'approvisionnement coopérative qui se charge des achats et du transport. Les ateliers de fabrication de matériels agricoles qui livrent des équipements à la centrale d'approvisionnement commercialisent également directement une partie de leurs produits dans les zones proches des ateliers centraux et secondaires. La Caisse Nationale de Crédit Agricole (CNCA) qui possède plusieurs agences sur tout le territoire assure l'essentiel des crédits de l'équipement pour la

culture attelée. Tous les projets de développement et les coopératives bénéficient de lignes de crédit en fonction de leurs activités. L'octroi du crédit est contrôlé par des comités techniques au niveau du département et des arrondissements.

La vulgarisation et l'encadrement agricole

L'encadrement des agriculteurs et la vulgarisation des thèmes techniques (semences sélectionnées, engrais, produits phytosanitaires et culture attelée) se font principalement à travers les services de la production agricole qui ont des agents jusqu'au niveau des districts. Par ailleurs, plusieurs "Projets Productivité" (en principe un par département) et des projets agricoles centrés sur des régions ou des aménagements précis, forment des groupes d'agriculteurs, les équipent et les encadrent. Toutes les actions d'encadrement des projets (durée de vie limitée) se font soit par l'intermédiaire soit avec la collaboration des services agricoles et des structures nationales permanentes, les offices notamment.

Les structures de production du matériel agricole

C'est un ensemble d'ateliers spécialisés qui assurent la fabrication du matériel agricole. Ces ateliers, au nombre de quatre, sont répartis sur l'ensemble du territoire. Certains d'entre eux ont également des ateliers secondaires qui dépendent plus ou moins de l'atelier central. Dans certains cas, ces ateliers secondaires commercialisent le matériel de l'unité centrale en plus de leurs propres productions. L'importance des ateliers ainsi que leurs origines sont assez variables. Jusqu'en 1984, ils étaient en principe tous coiffés par une structure centrale qui assuraient la planification, les approvisionnements ainsi que la prise en charge des produits finis. Ceux-ci étaient ensuite commercialisés par l'intermédiaire de la centrale d'approvisionnement des coopératives. Actuellement, chaque atelier est devenu indépendant du fait de la dissolution de la structure centrale et le

ralentissement des activités de la CNCA a obligé ceux-ci à rechercher des marchés locaux. La production s'est donc diversifiée et certains d'entre eux ont réussi à retrouver de nouvelles productions qui leur permettent d'assurer leur autofinancement.

Recherche et développement de nouveaux matériels agricoles

Introduction

Cette activité se situe à mi-chemin entre le monde agricole (utilisateurs, instituts et projets de recherche, etc.) et les constructeurs et fabricants (firmes étrangères, ateliers industriels nationaux, artisans ruraux, entreprises privées, etc).

La cellule ARMA n'a pas pour objectif le créer des matériels pour les constructeurs mais plutôt de faire évoluer le matériel et les équipements agricoles vers une plus grande efficacité et un meilleur rendement économique. Les prototypes qui sortent de la cellule peuvent être aussi bien construits localement, par des agriculteurs et des artisans, qu'être produits en série, par des ateliers industriels nationaux.

La gamme de matériels étudiés est en principe axée sur une amélioration de la production agricole et une meilleure utilisation de l'énergie animale. Les zones de culture visées comprennent aussi bien les sols dunaires que les cultures irriguées (contre-saison notamment). Les recherches englobent aussi les matériels de transport à traction animale, l'amélioration de l'exhaure à traction animale, la transformation et le stockage des produits agricoles en milieu paysan.

Développement de prototypes

Elles s'articulent autour de 4 axes:

- Les travaux portant sur la production d'accessoires et des pièces travaillantes pour

les matériels déjà mis en place et qui se trouvent au niveau des agriculteurs (25%).

- La réhabilitation des matériels aratoires non encore distribués et qui se trouvent en stock dans les magasins des coopératives. Il s'agit là de valoriser un patrimoine existant important en corrigeant certains défauts de fabrication et en adaptant sur ces matériels les derniers résultats en matière de recherche sur les pièces travaillantes et sur les accessoires. On pense notamment à des matériels qui favorisent la lutte anti-érosive et répondent aux critères économiques en utilisant éventuellement la traction mono-bovine ou la traction asine (15%).
- La recherche proprement dite de prototypes, qui constitue le troisième axe, s'appuie essentiellement sur les résultats obtenus à partir du matériel déjà mis en place. On tient également compte des plus récents progrès en matière de recherche appliquée obtenus auprès des exploitants agricoles du département. Dans tous les cas l'objectif prioritaire est une recherche de l'évolutivité des matériels existants afin de profiter des acquis et de l'expérience au niveau des vulgarisateurs et des artisans notamment (50%).
- L'appui à la fabrication locale des modèles retenus, que ce soit au niveau des paysans, des artisans ou de l'industrie. A ce titre, l'atelier de prototypes établit les dossiers techniques (dessins de fabrication, méthodes de fabrication, structure de prix de revient) et le cas échéant fabrique les outillages spéciaux, tels que le gabarit de contrôle, pour promouvoir l'intégration locale de la fabrication en lieu et place de l'importation (10%).

Les prototypes actuellement à l'étude sont les suivants:

- les bâtis légers, acceptant si possible des pièces travaillantes standard déjà diffusées.

- La mise au point et l'adaptation de moyens d'exhaure traditionnels ou nouveaux à traction animale.
- La production de matériel de traitement post-récolte, d'équipements de ferme, etc.
- les charrettes de grand gabarit à traction animale.

Capacité et potentiel de l'atelier

L'atelier est doté d'un équipement puissant qui lui permet de réaliser ou de modifier rapidement un équipement en cours de test. C'est un point important pour l'aboutissement rapide d'une étude de prototypes car le temps durant lequel les conditions idéales d'utilisation sont remplies est souvent très court et dépend d'éléments climatiques imprévisibles. Ainsi au cas où une modification est nécessaire durant un test, il est possible de réagir rapidement et de reprendre le test aussitôt après.

Le personnel technique, au nombre de 10, est composé essentiellement de professionnels. Une moitié d'entre eux est constituée d'ouvriers très expérimentés souvent formés sur le tas, et l'autre moitié est récemment sortie d'écoles professionnelles techniques du Niger.

Le potentiel de l'atelier en équipements pourrait couvrir des besoins plus importants que ceux du projet et il est prévu de recruter du personnel complémentaire pour sous-traiter la fabrication de prototypes pour d'autres projets, au fur et à mesure des possibilités. Ceci diminuera les charges récurrentes et entraînera une plus grande rentabilité de l'équipement disponible.

Méthodes de travail de l'ARMA

Les activités de la cellule sont sous-tendues par les concepts suivants:

- Le matériel qui est étudié doit avant tout être fiable et abordable pour les agriculteurs auxquels il est destiné, en évitant

dans toute la mesure du possible le recours systématique au crédit à moyen terme.

- Une diversification du matériel est recherchée afin de l'adapter aux circonstances rencontrées (types de sols et de culture, moyens financiers disponibles, entretien, etc.), en évitant de multiplier les types et les dimensions des composantes comme la boulonnerie, les ressorts des cultivateurs, les systèmes d'attache, etc.
- Diverses formes d'utilisation de l'énergie animale sont étudiées sans forcément intégrer des instruments aratoires non rentables dans l'équipement de base de l'utilisateur. Un éleveur, par exemple, peut très bien utiliser un animal de trait pour l'exhaure ou des transports sans posséder d'équipement aratoire.
- Les équipements sont recherchés en fonction de la taille des types d'animaux habituellement disponibles plutôt que de rechercher des animaux qui conviennent à un matériel donné.
- Dans toute la mesure du possible, et à condition que la qualité et la fiabilité des équipements ne soient pas remises en cause, on utilisera les matériaux de récupération et ceux disponibles localement; les approvisionnements spéciaux resteront des exceptions.
- Les outils sont conçus de manière à faire fabriquer par l'agriculteur le plus d'éléments de son équipement, notamment les harnachements et les parties en bois des jougs. Dans d'autres cas, on favorisera prioritairement le travail des artisans avant d'avoir recours à des ateliers industriels.

Résultats obtenus

Malgré la mise en place relativement récente de la cellule, plusieurs prototypes de matériels

aratoires ont été réalisés. Certains d'entre eux ont été produits en petite série afin d'élargir la zone de test et vérifier si ce nouveau matériel pouvait rendre service à un grand nombre d'agriculteurs.

Modification du bâti Arara

Ce bâti a été commercialisé ces dernières années par dizaines de milliers d'exemplaires. Il a été étudié pour des travaux lourds, labours et buttage notamment. Par la suite, on a adapté des traverses de fer en U sur lesquelles ont été fixés les ressorts du type Nolle avec des platines de fixation spécialement conçues à cet effet.

Ce bâti Arara, qui donne de bons résultats en terrain irrigué, a par contre le désavantage d'être trop lourd sur des sols légers qui représentent 90% des terres cultivées au Niger. En outre, les traverses en U ont tendance à se vriller en cas de rencontre avec une souche ou une touffe d'herbe bien enracinée. Par ailleurs, il n'est pas possible de travailler en interlignes dans du mil qui "tale" car les traverses blessent les tiges. Les réglages nécessitent 2 clés qui sont trop longs et aléatoires du fait de la rouille qui s'installe dans les filetages dès la deuxième saison.

La recherche a donc porté sur une plus grande légèreté de l'ensemble, des traverses réglables en largeur et le remplacement des réglages avec boulons par des axes goupillés. Deux modèles différents sont nés de ces modifications:

- Un modèle dit de transition qui est destiné aux agriculteurs qui ont déjà un équipement et sur lequel on peut monter de nouveaux accessoires sans avoir à reprendre le bâti de base à l'atelier.
- Un modèle amélioré qui est tiré des stocks existants et qui sont transformés avant d'être commercialisés.

Solutions proposées pour l'amélioration du matériel Arara

Traverses

- Les traverses sont séparées en deux et coulisent sur le bâti en se croisant, ce qui permet de varier l'encombrement et la largeur du travail.
- Les traverses centrales sont reliées aux traverses arrières par un fer plat soudé sur champs à leurs extrémités. Ceci empêche les traverses de se vriller sans alourdir l'ensemble, car il est alors possible de supprimer le doublage du U.
- Les traverses centrales sont légèrement surélevées, ce qui évite de retourner le bâti-poutre au moment du passage de la charrue à la version cultivateur.

Roulette

- Lors du remplacement de l'axe de la roulette, une série de trous sont percés sur le montant; il est ainsi possible de remplacer la poignée de blocage par un axe goupillé. Cette transformation, qui peut être faite par un forgeron, facilite considérablement le réglage de la profondeur de l'outil sur le lieu de travail.

Pièces travaillantes

- Plusieurs pièces travaillantes dites "améliorées" sont proposées au moment du remplacement des pièces d'origine usées. Ces nouvelles pièces se montent sur les étançons existants et il est possible de revenir au montage d'origine à tout moment. Les forgerons ayant reçu une formation proposent les alternatives suivantes:
- Rasette profilée, bien à plat, de 210 mm au lieu des 160 mm de la version originale.
- Soc canadien réversible non compris dans la composition d'origine.

- Soc de labour à bec de canard pour la pénétration et la stabilité dans les sols difficiles.
- Pics fouilleurs pour les scarifiages à sec, effectués avant les pluies.

Régulateur goupillé

Régulateur goupillé avec report de traction pour éviter la torsion de l'ensemble dans des travaux lourds.

Support de roulette

Support de roulette incliné et attache du bâti modifiée permettant un relevage maximum de la roulette, une plus grande profondeur de travail et l'utilisation d'étançons courts, d'où une amélioration de la stabilité de l'outil.

Accessoires en cours de réalisation

- Train avant à double roulettes pour conduite à une main et guidage depuis l'arrière par un seul homme.
- Renforcement des mancherons par soudure pour prévenir la casse de l'assemblage du guidon sur les montants.
- Régulateurs goupillés avec une chaîne de report qui évite la torsion du régulateur et allonge la chaîne de traction.

Prototypes dérivés de l'amélioration du bâti Arara

Les recherches effectuées sur l'adaptation du bâti Arara ont également débouché sur 2 autres prototypes:

- Conception d'une houe à base extensible à partir d'un stock important de houes asines en utilisant les résultats des recherches et certaines pièces travaillantes de la houe Arara.
- Fabrication d'un bâti en tôle pliée pour atelages légers (mon. boeuf, âne.)

La conception de ces deux outils a été conduite en gardant les pièces composantes du matériel de base (Arara). Cette démarche a eu pour résultat de diversifier le matériel d'entretien des cultures sans modifications sensibles de l'assortiment de pièces détachées. Dans le cas où l'on change une pièce composante (pièces d'usure notamment), on garde la caractéristique d'interchangeabilité de manière à pouvoir, le cas échéant, dépanner l'outil avec une pièce d'origine. Ce concept a parfois compliqué notablement le travail de conception et, dans certains cas, il a diminué la performance de l'outil. Cependant la garantie d'un entretien facile et d'une vulgarisation simple a été sauvegardée, ce qui est essentiel dans le contexte du développement de la traction animale en milieu rural.

Conclusions et recommandations

Philosophie de la recherche

L'étude d'un matériel agricole se fait en fonction d'un certain nombre de critères et de priorités. Bien qu'il existe un certain objectif final commun, il arrive souvent que les objectifs immédiats et à court terme des financiers, constructeurs, réparateurs et utilisateurs varient sensiblement. En effet, les démarches varient considérablement selon que l'on se place du point de vue d'un de ces différents partenaires.

La recherche de nouveaux matériels va donc se faire en fonction du groupe d'intérêts qui commande cette recherche. L'atelier de recherche-développement utilisera ainsi des procédures et des démarches qui vont sensiblement différer suivant les cas:

Si cette opération est initiée pour le compte d'un donateur étranger

Un consultant ou un projet local sera sollicité pour prendre contact avec les autorités locales et les constructeurs potentiels susceptibles d'absorber une certaine quantité de crédits. La tendance va être de porter le choix sur les matériels dont les composantes sont disponibles

dans le pays d'origine du donateur parce que, en général, les conditions du don l'exigent.

Risques

Il est tout à fait possible que le matériel qui sera retenu ne correspondra pas au standard de celui déjà en place. Cela entraînera des problèmes de maintenance et peut-être même de vulgarisation. D'autres risques comme des prix de revient élevés ou une trop grande sophistication sont également à craindre étant donné le niveau technologique du partenaire industriel du pays donateur.

Si cette opération est initiée par une industrie

La réflexion va s'articuler notamment autour de 2 concepts de base:

- Le potentiel disponible pour réaliser une fabrication en série au sein de l'usine ou du groupe en question.
- Le profit réalisable et le temps d'immobilisation des capitaux.

Risques

Il n'est pas certain que la standardisation soit respectée d'une année à l'autre. D'autre part, les matériels offrant le plus de perspectives commerciales seront retenus en priorité. Enfin les possibilités de modification de certaines pièces pour en faciliter la maintenance ne pourront pas toujours être prises en considération, surtout si cela complique la fabrication.

Si cette opération émane d'une structure d'approvisionnement et/ou de commercialisation

La structure qui comporte une organisation interne de type administratif va rechercher une gamme de matériels susceptibles de couvrir de manière satisfaisante l'ensemble du territoire. Dans le but d'une simplification évidente, elle va se limiter à un certain nombre d'assortiments-types avec des conditions de vente uniformes pour tous les agriculteurs.

Risques

Cette option, qui va entraîner une centralisation des opérations, va couper les relations entre les producteurs et les utilisateurs finaux, la structure de distribution jouant le rôle d'intermédiaire. Les lois du marché et les demandes de modifications des utilisateurs ne seront pas bien perçues par les producteurs tandis que les intermédiaires et les stocks entraîneront une hausse sensible des prix de revient à l'utilisateur.

Si cette opération est exécutée au sein d'un réseau artisanal

La recherche-développement du matériel tiendra compte du potentiel des artisans. Comme pour les constructeurs industriels, l'aspect commercial et la possibilité d'écoulement seront très importants avec peut-être un coût moins élevé. Les produits correspondront aux besoins des cultivateurs car ils seront en général commandés directement par ceux-ci.

Risques

Il n'y aura pas d'interchangeabilité des pièces d'usure qui devront être ajustées séparément sur chaque matériel. Cela entraînera une très grande dépendance des agriculteurs et la concurrence aura de la peine à se faire sentir, ce qui risque d'entraîner des coûts d'entretien élevés. Le plus grand danger sera que la conception d'un matériel ne sera pas forcément basée sur des impératifs agronomiques, ce qui pourrait entraîner une dégradation rapide des sols. Ce danger existe également avec la fabrication industrielle.

Si cette opération est conduite par un centre de recherche agronomique

L'étude sera réalisée sur la base de données scientifiques solides. La réalisation des prototypes sera faite en relation étroite avec des chercheurs, ce qui devrait assurer une qualité optimum du travail des outils.

Risques

Il est prévisible que l'on aura une assez grande quantité de modèles d'outils assurant chacun un usage particulier. Il sera compliqué de garder une certaine standardisation entre les différents modèles car cela suppose que l'on diminue quelque peu certaines performances. D'autre part, un outil testé au sein du centre ne sera pas obligatoirement efficace sur le terrain pour différentes raisons (niveau des utilisateurs, environnement technique, etc.).

Si cette opération est conduite par des utilisateurs finals

L'expression des besoins passe généralement par la comparaison avec des matériels existants ou des expériences passées. La culture attelée suscite souvent un grand intérêt dans les communautés villageoises; elle n'est cependant pas toujours bien comprise et n'est souvent pas utilisée en fonction de critères agronomiques ou de considérations économiques. En effet, des critères de prestige social, d'augmentation de la production, grâce en particulier à l'accroissement des superficies cultivées, priment souvent, et pour des raisons évidentes, sur les notions de conservation des sols, de préservation du milieu et d'investissement à long terme.

Risques

La recherche-développement de matériels agricoles aura de la peine à définir des objectifs. Elle sera peu performante car elle aura tendance à se disperser ou, au contraire, elle ne concernera qu'une petite région. Les investissements en hommes et en moyens matériels seront difficiles à rentabiliser.

En résumé, il n'y a pas de structure d'accueil idéale pour abriter une activité de recherche-développement de matériel agricole. Les différentes options comportent des avantages et des inconvénients; cela impose le recours à des compromis entre ces différents aspects.

Propositions pour l'étude d'une structure de recherche-développement

Il existe deux grandes options de domiciliation des activités de recherche-développement:

- La recherche-développement de prototypes est rattachée à une structure dépendant du Génie Rural et la collaboration des autres partenaires est recherchée.

Cette solution est la plus classique et c'est elle qui domine dans les pays africains francophones. Elle a été longtemps utilisée dans les pays avant l'indépendance au moment où ceux-ci n'avaient pas encore d'unités de production et où l'emploi du matériel agricole de culture attelée par les petits exploitants était marginal. Elle a l'inconvénient d'être coûteuse (frais récurrents élevés) et elle a souvent un caractère très administratif qui limite les contrats interministériels.

- La recherche est conduite par une industrie qui s'appuie sur des instituts nationaux de recherche, pour les aspects agro-économiques, et sur des structures nationales de commercialisation.

Cette solution a été généralement adoptée après l'indépendance des pays africains, au moment où les industries de matériels agricoles se sont mises en place et où la coopération des pays développés était encore très peu diversifiée. Elle présente l'inconvénient que, la plupart du temps, seuls des matériels susceptibles d'être produits en série importante sont étudiés.

La démarche adoptée par le Niger est différente. Elle n'est pas définitive mais elle constitue une voie assez originale: on appelle une collaboration de tous les niveaux intéressés par la recherche-développement de prototypes de matériels agricoles autour d'un atelier de prototypes dont l'objectif principal est la réalisation de nouveaux modèles. C'est dans ce contexte que l'atelier de prototypes de l'AR-MA a été créé. Actuellement, il répond aux besoins exprimés par tous les services appuyés

par le PPN. Au fur et à mesure des possibilités pratiques, il répondra aux demandes de plus en plus nombreuses de projets et d'organismes fort divers qui n'ont pas la possibilité financière de créer et d'entretenir à eux seuls un atelier de ce type.

Sur le plan national, l'atelier de prototypes s'est préparé à une collaboration étroite avec le projet national de machinisme agricole, récemment créé et chargé d'animer un comité national de machinisme agricole. En ce qui concerne les relations avec les structures industrielles de fabrication et avec le réseau artisanal il existe des liens de collaboration très directs. En effet, ces fabricants ne craignent pas d'être concurrencés par l'atelier de développement de prototypes étant donné que celui-ci n'a pas pour objectif une fabrication en série. Ils peuvent ainsi compter sur un partenaire fidèle pour une contribution à leurs problèmes de développement de leur gamme de fabrication, mieux adapté à leur potentiel et à leur clientèle.

Le financement du fonctionnement régulier de cet atelier est assez modeste. En effet, chaque projet finance au prix coûtant le prototype qu'il y fait exécuter. Les ateliers de production devront également prendre en charge le coût des outillages de production qu'on envisage de construire pour leur compte. On étudie la possibilité de continuer l'action de l'atelier de prototypes après la fin du projet financé par l'USAID en 1988. On a notamment envisagé de rattacher cet atelier à la Direction de l'Agriculture et l'on a prévu de compléter un nouveau financement de l'USAID avec des fonds d'autres partenaires comme le FED et la GTZ.

Recherche-développement de prototypes: conditions à réunir pour réussir

Quelle que soit la forme d'organisation de l'atelier de développement de prototypes, il devra réunir un certain nombre de conditions pour pouvoir atteindre son objectif. Les conditions minimales sont les suivantes:

- Disposer d'un personnel technique pour qui routine n'est pas synonyme de bon travail. Ce personnel doit être issu de la serrurerie et de la mécanique générale et il doit savoir utiliser du matériel agricole pour comprendre ce qu'on attend de lui.
- Pratiquer une politique de "porte ouverte" pour faciliter les contacts et entretenir des relations actives avec les instituts de recherche. De plus, des contacts fréquents et parfois informels avec des hommes du terrain sont très instructifs.
- Avoir une liaison permanente avec les structures de vulgarisation de façon à être réaliste par rapport aux problèmes du terrain, que ce soit dans le cadre d'études pour des modifications à réaliser, ou d'introduction d'un nouveau type matériel.
- La conception d'un nouveau type de matériel doit être guidée par la recherche d'un maximum d'interchangeabilité des composantes avec le matériel déjà vulgarisé. Une diversification anarchique des entraxes de fixation et des types de boulons peuvent annuler les avantages d'une amélioration. Ceci est également valable pour les pneumatiques et les pièces de rechange des essieux de charrettes.
- L'étude d'un prototype ne doit pas s'arrêter à sa fabrication et à son essai mais tenir compte des problèmes posés par la vulgarisation et la mise en fabrication. Ces deux points doivent rester à l'esprit du chercheur jusqu'au modèle final.
- Avant la mise en route pour la recherche d'un nouveau type de matériel, il est nécessaire de définir les caractéristiques techniques recherchées et de les consigner par écrit (protocoles de recherche). Un groupe représentatif composé de personnes expérimentées de différentes disci-

plines techniques devrait se réunir pour effectuer ce travail préliminaire. Ce groupe devrait se concerter périodiquement au fur et à mesure de l'élaboration du prototype, de façon à pouvoir y apporter une contribution et le cas échéant des critiques constructives.

Condition supplémentaire

- L'atelier devrait disposer d'une certaine flexibilité dans ses approvisionnements qui lui permette d'acheter rapidement du matériel complémentaire au cours de la réalisation d'un prototype. Cette fluidité est un atout important pour tous les matériels à l'étude et surtout pour ceux qui ont une période de test relativement courte (conditions climatiques, croissance des plantes etc.).

Avantages d'une collaboration au niveau régional

Une collaboration au niveau régional ne suppose pas obligatoirement l'existence d'une organisation nationale. Dans certains cas, des canaux de relations et d'échanges d'informations techniques pourraient exister entre deux établissements ayant des intérêts communs. La collaboration régionale est également très importante au niveau de l'échange périodique de techniciens et de chercheurs. Les raisons peuvent être la formation de personnel spécialisé ou l'étude de l'organisation et de la gestion d'un atelier ou des essais. Il est souhaitable que des échanges d'informations par le biais d'une revue technique puissent servir à faire connaître les différents organismes à l'intérieur de chaque pays. Les principaux résultats et les démarches adoptées pourraient figurer dans cette revue sous forme d'articles et de photos.

L'équipement de la traction animale au niveau de l'Institut des Sciences Agro-zootechniques (I.S.A.F.)

par

Alhassane Kesso Diallo

Ingénieur Machiniste, Professeur à l'Institut des Sciences Agro-zootechniques de Foulaya, Guinée

Résumé

La Guinée est un pays à vocation agro-pastorale, avec ses régions agricoles naturelles: la Basse, la Moyenne, la Haute et la Guinée forestière. L'élevage est surtout pratiqué dans la Basse, la Moyenne et la Haute Guinée. L'introduction et la promotion de la culture attelée a depuis longtemps été au centre des préoccupations des autorités et paysans guinéens.

Historiquement, la Guinée a constitué le pôle à partir duquel la culture attelée s'est propagée vers les autres pays voisins (Mali, Sierra Leone, etc.). Mais malgré les efforts de promotion déployés, le matériel de culture attelée des paysans se limite à la charrue, la herse et la charrette. Ces équipements sont largement en deça des besoins en matériels agricoles de l'agriculture guinéenne.

Dans le souci d'assurer une plus grande diversification du matériel agricole, l'Institut des Sciences Agro-zootechniques (I.S.A.F.) expérimente plusieurs équipements agricoles pouvant efficacement contribuer à l'extension de la culture attelée. Les efforts de recherche portent essentiellement sur l'utilisation de nouvelles espèces animales, le test de nouveaux outils, l'évaluation de l'effort de traction requis et la promotion de la monotractive. Les résultats obtenus pourraient accroître l'efficacité de la traction animale et favoriser ainsi l'accroissement de la productivité de l'agriculture guinéenne.

Aperçu général

La République de Guinée est un pays à vocation agro-pastorale et se subdivise en quatre zones naturelles: Basse Guinée, Moyenne Guinée, Haute Guinée et Guinée Forestière. L'élevage est surtout pratiqué en Basse et en

Haute Guinée. Les espèces animales de trait rencontrées sont les bovins et les équidés.

La traction animale a toujours préoccupé le cadre et le paysan guinéens. Avant 1930, elle partait de la Guinée pour s'étendre aux pays voisins (Mali, Sierra Leone, etc.). De même, le gouvernement a consenti des efforts non négligeables pour la promotion de la traction animale. En 1968, la Guinée importa de la Chine un important lot de matériels agricoles à traction animale (charrues, herse, semoirs, macha-japonais, etc.). Ce matériel était destiné aux écoles, alors appelées Centres d'Enseignement Révolutionnaire (CER). En 1973, l'Usine d'Outillage Agricole (USOA) pour la fabrication sur place d'une gamme variée de matériels à traction animale (chaîne d'attelage, charrue, herse, matériels aratoires, etc.) a été construite.

Cependant, malgré les efforts déployés, l'utilisation de l'équipement de traction animale au niveau du paysan s'est seulement limitée à l'emploi de la charrue, de la herse et de la charrette. Mais dans certains centres de recherche (Institut des Sciences Agro-zootechniques de Foulaya, Centre de Recherches Agronomiques de Kilissi, Timbi-Madina), on rencontre une grande diversité de matériels.

Les paysans des grandes régions d'élevage pratiquent la traction animale selon les modalités suivantes:

Mode de traction

Traction à 2 bêtes avec un joug de tête par paire. La race généralement rencontrée est la trypanotolérante N'Dama.

Mode de dressage

Le dressage commence par le choix des tauraux de 2 à 3 ans. Après leur avoir percé la cloison nasale, les animaux sont immobilisés pendant une semaine environ. Par la suite, l'entraînement est initié avec la traction d'un morceau de bois. L'adaptation aux travaux spécifiques débute généralement par le labour superficiel. Ici on apprend à l'animal de droite à marcher dans la raie suivant une ligne droite, alors que celui de gauche est sur le guéret. Lorsque ces leçons sont assimilées par les animaux, ils sont soumis à des charges plus difficiles: labour profond, transport par charrette, etc.

Mode d'utilisation

Une fois le dressage terminé, les animaux sont attelés suivant le besoin de l'utilisateur et son équipement. Les travaux commencent généralement très tôt le matin pour finir avant midi, heure à partir de laquelle les animaux sont libérés pour le pâturage naturel. Le soir, ils sont conduits aux enclos d'où ils sont repris le lendemain pour une nouvelle journée de travail.

Matériel utilisé

La charrue

Les travaux de labour sont réalisés à l'aide des charrues simples, sans tenir compte des caractéristiques des sols. Les charrues utilisées sont d'origine chinoise, italienne et guinéenne (USOA et forgerons locaux).

La herse à dents

Elle est utilisée après le labour pour ameublir superficiellement le sol. La herse réalise à la fois la préparation du lit de semences et l'enfouissement des graines et est fabriquée à l'USOA. La suite des travaux (semis, entretien des cultures, apport d'engrais, récolte) s'exécute manuellement

Les charrettes

En Haute-Guinée les ânes et quelques rares chevaux sont utilisés dans le transport à l'aide des charrettes de fabrication locale.

En résumé, le matériel disponible est de loin en deçà des besoins du paysan guinéen. C'est la raison pour laquelle certains centres de recherche, tels que l'I.S.A.F. oeuvrent à la mise sur pied d'un équipement complet, varié et vulgarisable.

Matériel de traction animale expérimenté à l'I.S.A.F.

Les animaux utilisés sont des résultats du croisement des races étrangères (races jerseyaise et la Rouge des steppes) avec la race locale N'Dama. Le produit génétique révèle d'excellentes qualités: rusticité, résistance aux maladies, robustesse suffisante, avec un poids vif pouvant atteindre 500 kg; ceci lui permet d'évoluer sur tous les types de terrains (bas-fonds, côteaux). Le dressage du métis est beaucoup plus facile que celui de la race locale.

Les boeufs métis ont réalisé avec succès certains travaux:

- labour, hersage, binage et buttage en culture de maïs.
- labour, planage, nivellement en riziculture inondée.
- labour, hersage et semis en culture d'arachide.
- buttage et sarclage en cultures de banane et d'ananas.
- ouverture des sillons d'irrigation pour le maïs, la banane et l'ananas.
- traction des charrettes pour le transport des produits agricoles.

Compte tenu de la force de traction très appréciable de ces métis, chacune de ces opérations est réalisable par un seul animal.

En plus du matériel rencontré au niveau des paysans (charrue, herse, charrette), l'I.S.A.F a expérimenté quelques outils avec des résultats appréciables:

Le travail

Il permet d'immobiliser et d'habituer l'animal au joug et comprend:

- deux longerons reliés entre eux par des traverses robustes.
- un joug de garrot.

La corde du nez

Cette corde est fixée sur un anneau métallique placé au travers de la cloison nasale percée à l'avancé.

Le joug

Celui utilisé est un joug simple de garrot en bois présentant les avantages suivants:

- forme simple et construction plus facile.
- il s'adapte aussi aux boeufs sans corne.
- il permet la réalisation à bon escient des travaux d'entretien des cultures sarclées.
- il n'exige pas une paire de boeufs; par contre, il a comme inconvénient l'avancement moins rapide des animaux, les efforts étant appliqués au niveau des épaules.

Les chaînes et la barrette de traction

La herse en bois de fabrication locale

Elle est destinée aux travaux de nivellement et planage des casiers rizicoles et comprend:

- deux longerons de longueur égale à 2 fois celle de l'animal environ.
- un bâti transversal ayant des peignes d'une longueur de 10 à 12 cm; ces peignes effectuent le nivellement après défoncement.
- une lame en bois que l'on attache devant les peignes quand il s'agit du planage du casier. Cette opération apprête ce dernier pour le repiquage du riz.

Le semoir

D'origine chinoise et de type à canelure pour arachide, il possède deux rangs avec un écartement réglable de 60 à 90 cm.

La bincuse pour maïs

Outil destiné à l'entretien de la culture du maïs, il a été adapté à l'I.S.A.F. et comprend:

- un bâti de macha-japonais
- une section de binage qui peut supporter soit deux dents unilatérales, lors du binage, soit deux dents en flèche, lors du sarclage.
- une roue d'appui à sa partie arrière
- une roue limitatrice de profondeur avec une vis de réglage.

La monotraction constitue l'élément essentiel pour la réussite de cette opération.

Le buttoir ou macha-japonais

Cet instrument importé de la Chine peut travailler la terre jusqu'à une profondeur de 7 cm. A l'aide de cet outil, il est possible d'effectuer certaines opérations d'entretien, notamment le buttage, l'irrigation, le sarclage de l'ananas, de la banane et du maïs. L'angle d'attaque du soc-versoir est modifiable des deux côtés, permettant ainsi de verser la terre dans les deux sens.

La billonneuse

Elle réalise des billons en cultures maraichères. Son travail est parfait lorsque le terrain est bien labouré. Il est réalisé à partir de l'adjonction de deux macha-japonais. La largeur du billon est modifiable et varie de 10 à 15 cm.

Le dynamomètre

En plus de l'expérimentation de ce matériel nouveau, la chaire de machinisme s'est intéressée à la détermination de la force des animaux. A cet effet, elle a construit un dynamomètre qui comprend une tige crochet soutenant un ressort à l'aide d'un écrou; l'ensemble est introduit dans un cylindre. Pour fixer le dynamomètre une bride est soudée au cylindre. Pour graduer le cylindre il a fallu successivement charger le ressort (crochet) de contre-poids de 30 kg qui le compriment, permettant ainsi le déplacement de l'aiguille sur le cylindre. Ainsi une compression maximum du ressort a été

Tableau 1. Résistance spécifique des outils et rendement des animaux par opération culturale

Opérations Culturales	Instruments spécifiques	Résistance (kg/m)	Rendement (m ² /Jour/A)
Labour	Charrue	690	1500
Buttage	Macha-Japonais	600	1200
Binage maïs	Bineuse adaptée	292	2000
Planage (casier riz)	Herse en bois (adaptée)	180	1500

obtenue lorsqu'on a atteint 240 kg. Cette expérience a permis de déterminer:

- la force maximale d'un animal qui est de 185 kg.
- la puissance d'un animal lors du buttage qui est de 0,73 kw.

Conclusions

- La République de Guinée présente des conditions favorables à l'élevage.
- Les cultures pratiquées (riz, maïs, arachide, fonio, ananas et bananes) s'adaptent bien à l'utilisation de la traction animale dans le milieu paysan.

- Le matériel existant au niveau des paysans guinéens est très insuffisant pour une meilleure vulgarisation de la traction animale.
- Le matériel expérimenté à l'I.S.A.F en 1982/1983 pourrait servir d'exemple pour une extension de la culture attelée. L'auto-suffisance alimentaire d'un pays ne peut être assurée en grande partie qu'à travers l'aide qu'on apporte aux paysans. Une des voies les plus sûres serait la vulgarisation de la traction animale.
- La détermination de l'effort de traction et l'utilisation de la monotraction à l'I.S.A.F ont permis de mettre en valeur les boeufs métis par rapport aux animaux de race locale.

Nous suggérons que les instituts agronomiques et les cadres de l'économie rurale fassent de la traction animale une de leurs préoccupations essentielles. Les résultats obtenus à l'I.S.A.F. est un fait éloquent. Nous approuvons et encourageons les rencontres internationales pour un échange de points de vues sur un problème aussi important que la traction animale. Ainsi une aide efficace pourra être apportée aux paysans.

Animal power equipment at the farm level in The Gambia

by

Sidi M. Jarju, Dawda M. Sarr and Alphu J. Marong

*Soil and Water Management Unit & Agricultural Engineering Unit
Ministry of Agriculture, Banjul, The Gambia*

Abstract

Background information on the use of animal traction in The Gambia is provided. The use of animal-drawn implements has increased greatly since the mid-70s. The types of animal power equipment in use at farm level are described. The multipurpose Sine Hoe toolbars, imported from neighbouring Senegal, are the main implements employed by farmers. The major problems and constraints relating to the use of animal power equipment at field level are discussed and corresponding solutions suggested.

The background of animal traction in The Gambia

Oxenization started in The Gambia in the late 1940s when the *Sutlidge* single-mouldboard plow was introduced for demonstration purposes. The first real move from traditional hand cultivation methods started in the 1950s and 1960s, when some farmers started using the *Emcot* ridger, the first single purpose animal-drawn implement to be adopted in The Gambia. The ridger was imported from Britain and consisted of a robust beam and an adjustable double-winged ridging plow. This ridger can be looked upon as the second step of a "mechanical ladder" that represents a mechanization process which allows a progressive change from the use of one type of technology to another. (See diagram). The *Emcot* ridger can be used for other purposes besides ridging. Some farmers in the Western Division where ridge cultivation is still practised use the ridger to till the soil between the

rows of growing cereal crops, such as maize, millet and sorghum. This is in order to bury weeds, consolidate the base of the plants to guard against strong winds and to distribute broadcast fertilizer for more efficient utilization by the plants.

Gambian farmers, with guidance from the extension branch of the Ministry of Agriculture, thus started to follow the mechanization scheme mentioned, but three decades elapsed before the adoption of the multipurpose *Sine Hoe* implement. It is curious that such an implement was not introduced earlier. Instead, during the period from the 1960s to the early 1970s, the *Apolos* and the *Xplos* wheeled toolcarriers with pneumatic tyres were introduced. The toolcarriers were multipurpose implements, imported from Britain. They did not win farmer acceptance because their cost was too high and their components were too heavy.

In 1975/76 the *Sine Hoe* (Houe Sine) implements manufactured in Senegal by SISCOMA were evaluated (Matthews and Pullen, 1976). Through the efforts of Matthews and Pullen, the evaluation of the implements was accomplished and recommendations were made for their adoption of the following equipment:

- Sine Hoe frame, with 250-mm single-mouldboard plow, five-tine cultivator, earthing-up attachment and groundnut lifter.
- Super Eco seeder.

By the late 1970s and early 1980s there was widespread acceptance of the *Sine Hoe* imple-

ments. During these years the staff of the Agricultural Engineering Unit in the Department of Agriculture helped to promote the use of the implements through the extension branch which is responsible for training. The extension branch organized village-based farmer-training programmes. The Agricultural Engineering Unit also provided after-sales services, including the sale of spare parts. Unfortunately, the work of Matthews and Pullen did not motivate research initiatives within the Agriculture Engineering Unit that might have led to an enhanced implement package for use in potential rice-growing ecologies such as the swamp lands.

Types of animal-drawn equipment used in The Gambia

The range of animal-drawn implements in common use is as follows:

- Sine Hoe,
- Emcot Ridger,
- CFOOOP 250-mm mouldboard plow,
- Hoe Occidental,
- Ox cart
- Donkey Cart
- Horse Cart

The number of Emcot ridgers in use at the farm level is declining since these implements are no longer manufactured. The CFOOOP plow is suitable for making high ridges for the control of soil erosion. The Hoe Occidental is a small multipurpose frame to which different soil-contacting parts are attached for plowing and weeding. The CFOOOP plow and the Hoe Occidental are widely used in the Upper River Division of the country. The Sine Hoe implements have been grouped into three packages for groundnuts alone, for groundnuts and cereals, and for groundnuts, cereals and cotton. For cereals and cotton, the operations using animal power are plowing, harrowing, planting and weeding. With groundnuts an additional operation is harvesting (groundnut lifting).

The number of ox carts, donkey carts and horse carts have increased since 1977 when implement packages including these carts were provided to farmers by the Cooperative Union on medium-term loans. Since then donkey carts have greatly increased in popularity by virtue of the fact that donkeys are more readily available, and cost less than oxen or horses, and also the donkey carts themselves are cheaper.

Constraints and possible solutions

Gambian farmers have yet to be convinced that the use of animal-drawn implements can be extended to swamp areas. Trials relating to this were started in the past and abandoned, with no attempts made to reactivate them. The fact that the Sine Hoe implements are currently limited to only upland conditions has become a major constraint to the Government's attempt to increase rice production and thereby save foreign exchange. This has led to the launching of an intensive rice production project involving the smallholder farmer and the use of expensive motorized equipment. This project is currently supported by a foreign donor. Production has been raised above the subsistence level, but it is doubtful whether the income generated so far will sustain this project when it becomes autonomous or will enable the farmer to become self-sufficient. Thus the authors all consider that that the Department of Agriculture should support the enrichment of the Sine Hoe package to allow it to be used for rice production.

Gambian farmers still farm on stumpy land and do not appear to appreciate the benefits that can be derived from destumping land in terms of yield increases and the ease with which cultivations could be carried out. The efficiency of all the implements used for primary and secondary cultivations is greatly reduced

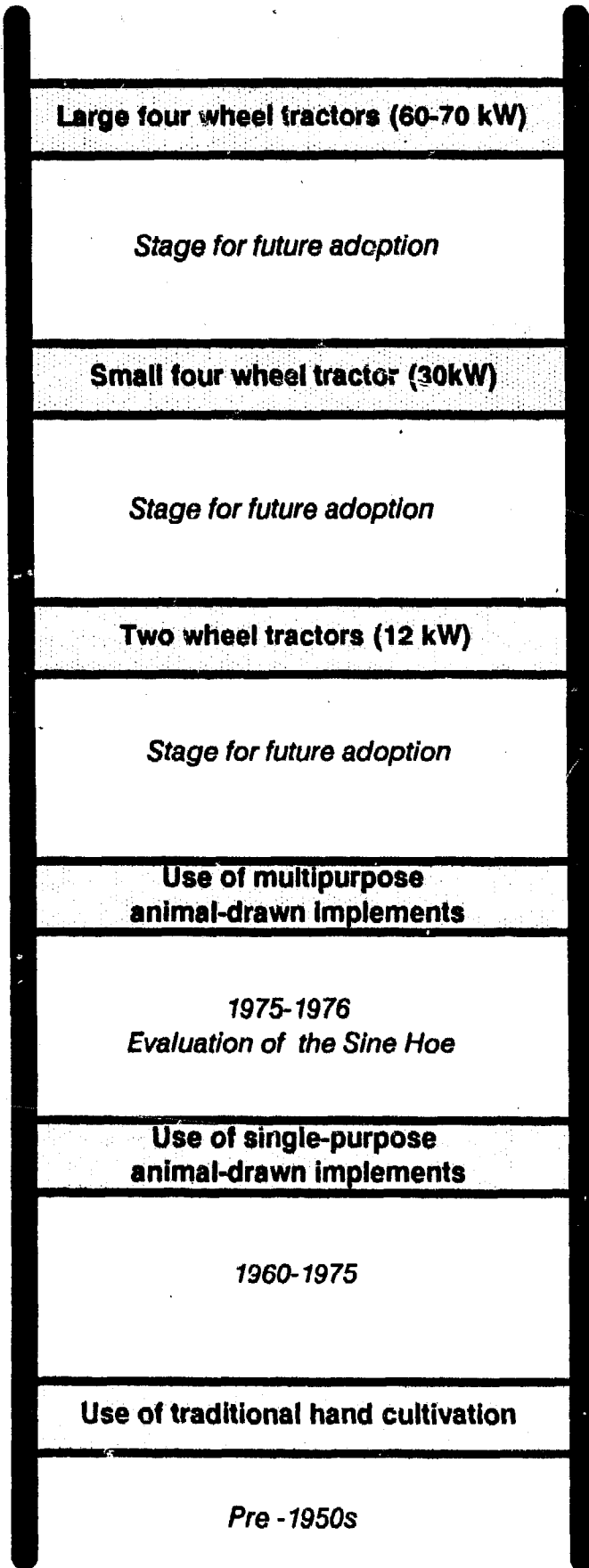

when used on land that is stumpy for crops cannot be sown in straight lines which in turn make inter-row weeding and subsequent operations difficult. In order to solve this problem the authors suggest that the Extension Unit should introduce a scheme whereby farmers could be encouraged to embark on gradual destumping of their land.

The *Open Kraal System* is still widely practised by herdsmen. This practice is looked upon by farmers as a means of increasing soil fertility. However during the dry season cattle dung is baked by the heat of the sun and becomes very hard. It thus remains on the surface and creates obstructions during planting, for as the wheels of the Super Eco seeder rise over the hard dung, the efficiency of the seeder can be impaired. One solution to this problem would be to encourage market gardening in localities where the open kraal system is practised in order that the dung could be collected and used for manure.

The use of animal-drawn implements has increased production, but this has led to the creation of new bottlenecks. The larger amounts of crops harvested cannot all be processed at the farm level. Post-harvest operations are difficult and are normally undertaken by women. The use of internal combustion engines to power processing machines often involves high costs, and spare-part problems when used at village level. One solution to this problem could be to harness animal power for such operations. Initially a search could be made for existing suitable equipment used elsewhere. Following this, prototypes could be designed,

Diagram illustrating the mechanical ladder concept

field-tested and developed provided this does not involve high costs.

Conclusions

It can be seen in the foregoing that there have been both failures and achievements concerning animal traction implements in The Gambia. However, it could be said that, on balance, more has been achieved by the Gambian farmer over the years in that:

- The Sine Hoe has been widely adopted.
- Despite the effects of the drought, production has increased.
- Through the guidance of the extension sector, the gradual mechanization system (mechanical ladder) has been followed. This has avoided the temptation to em-

bark on intensive mechanization projects. More often than not, such capital-intensive technologies have failed in Africa.

The major problems and constraints discussed above still persist. The authors feel wholeheartedly that there is a need for the creation of adaptive research initiatives aimed at broadening the use of the implements available, and also reducing their costs.

References

- Matthews, M. D. P. and Pullen, D. W. M. 1976. Cultivation and ox-drawn implements. Technical Bulletin No. 1, Department of Agriculture, Banjul, The Gambia. 42p. (E).
- Matthews, M. D. P. and Pullen, D. W. M. 1976 Cultivation trials with ox-drawn implements using N'Dama cattle in The Gambia. Report Series, Overseas Department, National Institute of Agricultural Engineering, Silsoe, UK. 49p. (E).

Unité de Production de Matériel Agricole (UPROMA)

par

L. A. Afantonou

Directeur, Unité de Production de Matériel Agricole (UPROMA), Kara, Togo

Résumé

Les activités de l'UPROMA s'inscrivent dans le cadre général de la politique de mécanisation entreprise par le gouvernement togolais. L'UPROMA a pour mandat la fabrication en série du matériel de culture attelée et d'autres équipements destinés au monde rural. Sa production se subdivise en deux groupes: les équipements de labour, d'entretien et traitement des cultures (multiculteurs, charrettes, herses, semoirs, etc.) et les équipements destinés aux communautés (des pompes, des presses, des abreuvoirs et mangeoires, etc.)

La commercialisation de la production est assurée par le Projet pour la Promotion de la Traction Animale (PROPTA). Ce projet se charge également du regroupement des commandes et de l'évaluation des marchés, particulièrement pour les équipements de labour, d'entretien des cultures et de traitement des récoltes.

L'UPROMA assure la formation de forgerons ruraux et de mécaniciens chargés respectivement de l'entretien et de la réparation du matériel agricole et des pompes.

Du fait de son objet de mettre à la disposition du monde rural des équipements aptes à faciliter le développement agricole, l'UPROMA est prête à instaurer des rapports de coopération avec des agences et structures de la sous région qui travaillent dans le même sens.

Présentation de l'UPROMA

L'Unité de Production de Matériel Agricole (UPROMA) est installée à Kara à 430 kilomètres de Lomé. L'activité de l'UPROMA a commencé en 1981. Elle s'inscrit dans le cadre général de la politique de mécanisation agricole entreprise par le gouvernement togolais et à

laquelle participent plusieurs organismes internationaux.

Elle dispose d'un espace d'environ 2 hectares dont un atelier couvrant une superficie de 1800 m² et un bureau de 200 m². Le personnel est composé d'une cinquantaine de personnes et complété, pendant les périodes de production intense, par le recrutement d'une dizaine de manoeuvres journaliers.

L'UPROMA a pour charge la fabrication en série de tout le matériel de culture attelée dont le pays a besoin ainsi que d'autres matériels destinés au monde rural. La production de l'UPROMA se subdivise en deux: les équipements de labour et d'entretien des cultures et les équipements destinés aux communautés rurales (la décortiqueuse d'arachide, l'égrénoir à maïs à main, la batteuse de riz, la pompe India-Togo Mark II, la presse à brique, la presse à huile, une tresseuse de grillage, des abreuvoirs et mangeoires, le métier à tisser, etc.)

Equipements de traction animale

Produits

Multiculteur M9^{SS}

Le multiculteur M9^{SS} types Bourguignon est identique à celui fabriqué au Burkina Faso par le Centre National d'Équipement Agricole (CNEA).

Il se compose:

- de la charrue 9^{CH9}
- du butteur BHV
- de la houe triangle avec 5 dents souples HSS

- de 5 pics fouilleurs montés à la place des dents souples pour le scarifiage profond, en option.

Ce produit constitue l'équipement de base pour le démarrage de la culture attelée.

Multiculteur M6"3S

Il est identique au M9"5S mais il est plus petit avec 3 dents souples pour la traction mono-boeuf, asine, ou pour des boeufs de petite taille.

Charrettes

UPROMA fabrique trois modèles de charrettes

GP 1000 KG

- dimension du plateau: 2 m x 1,6 m
- charge admissible: 1000 kg
- hauteur du plateau: 0,75 m

PP 1000 KG

- dimension du plateau 1,6 m x 1,3 m
- charge admissible: 1000 kg
- hauteur du plateau: 0,75 m
- idéal pour les pistes rurales.

Ces deux types de charrettes sont tractées par une paire de boeufs.

PP 500 KG

- dimension du plateau: 1,6 m x 1,3 m
- charge admissible: 500 kg
- hauteur du plateau: 0,65 m
- option brancard pour la traction asine ou mono-boeuf.

Toutes les charrettes sont équipées de roues neuves déclassées et sont livrées sans timon et sans ridelles. Le timon et les ridelles étant en bois, ils peuvent être fabriqués par le paysan même à coût réduit.

Les herses

Il en existe deux types: une à deux chassis à 15 dents chacune et une autre à un chassis avec 25 dents.

Les semoirs rotatifs

Il comportent également 2 variantes:

- SR1: semoir rotatif mono-rang manuel
- SR2: semoir rotatifs bi-rang tracté.

L'épandeur d'engrais

Son principe de fonctionnement est basé sur le battement de la base mobile de la trémie par une transmission languette roue-base mobile de trémie.

La souleveuse d'arachide

Le corps est monté sur l'age de la charrue et il est tracté par un boeuf.

Pièces de rechange et d'usure

UPROMA produit des pièces de rechange de bonne qualité. Sa disponibilité lui permet de fournir à l'avenir aux pays limitrophes et de la sous région des pièces de rechange pour:

- le multiculteur types Bourguignon
- le multiculteur types ARARA
- les pièces de rechange de charrettes
- boulonnerie

Pour les multiculteurs, les pièces fabriquées par composante sont les suivantes:

Charrue

- soc simple 10"
- soc à bec carré 9"
- soc simple 6"
- versoir 10"
- versoir 9"
- versoir 6"
- sep et palette 10"
- sep et palette 9"
- sep et palette 6"
- talon 9"
- douille 20,5 x 30 x 70
- chaîne de traction

Butteur

- coeur butteur
- ailes butteurs

- pointe butteur

Houe

- étrier complet
- soc réversible
- soc patte d'oie
- dent souple

Charrettes

- essieu 1000 kg
- essieux 500 kg
- roue complète 165 x 14
- roue complète 145 x 13.

Boulonnerie

- tous les boulons pour l'assemblage des produits et des roulements pour les essieux de charrette.

UPROMA commercialise certains de ces produits, surtout les multiculteurs et les charrettes, sous différentes formes de finition:

- en kit non assemblé
- en kit semi assemblé
- en produit fini assemblé.

Les deux premières possibilités permettent aux ateliers de montage et de réparation de certains projets du pays (FED, FED-SAVANES-GTZ SOKODE Projet Nord-Togo à Kara) d'acquérir ces produits à un prix qui leur donne la possibilité d'augmenter leur part de la valeur ajoutée au prix de revient.

La production de l'UPROMA est du type série basé sur l'utilisation des gabarits, des montages d'assemblage qui sont étudiés, fabriqués et entretenus par des agents qualifiés et expérimentés de l'usine.

Le parc machine comprend entre autres:

- la presse pour le fromage
- la cisaille poinçonneuse
- la cisaille guillotine
- la tour
- la fraiseuse-perceuse
- l'oxycoupeur
- la soudeuse à résistance
- la presse pileuse

- la rouleuse à tôle et à galets.

Tous ces équipements ont permis à UPROMA l'intégration d'une partie importante de sa production. Cela fait qu'actuellement les pièces suivantes sont entièrement fabriquées à UPROMA;

- versoir
- aile
- corps butteur
- sep-palette
- étrier
- soc réversible
- pointe butteur

Cette intégration a permis de porter la valeur ajoutée de l'entreprise à environ 60% du prix de revient.

Depuis sa création en 1981 UPROMA a produit environ:

- 5 000 multiculteurs
- 2 000 charrettes
- 300 semoirs manuels
- 500 herse
- 500 abreuvoirs et mangeoirs
- 400 pompes manuelles
- 100 presses à briques
- 300 égrenoirs à maïs à main

Dans l'avenir, à court et à moyen terme, les produits suivants sont retenus pour être fabriqués à l'UPROMA;

- moulin manuel pour céréales
- moulin manuel à manioc
- charrettes citernes
- foyer économique
- pompe éolienne
- montage de motoculteur.

L'UPROMA bénéficie d'une assistance technique et financière des agences des Nations Unies tels que le Programme des Nations Unies pour le Développement Industriel (ONUDI) et le Fonds d'Équipement des Nations Unies (FENU).

La production de l'UPROMA est commercialisée par le Projet pour la Promotion de la

Traction Animale (PROPTA) qui se charge du regroupement des commandes et de l'évaluation des marchés, surtout pour les équipements de labour, d'entretien et de traitement des récoltes. Pour les autres produits, **UPROMA** dispose d'un service commercial et d'un service après vente surtout pour l'installation et l'entretien des pompes. **UPROMA** forme des forgerons ruraux pour l'entretien et la réparation du matériel agricole ainsi que des mécaniciens villageois pour l'entretien et la réparation des pompes.

Etant donné son objectif qui est de mettre à la disposition du monde rural togolais, en particulier, et de la sous région en général, des équipements agricoles aptes à faciliter le développement agricole, **UPROMA** est disposée à collaborer avec toutes les unités du même genre opérant dans la sous région pour la création, l'entretien, et la consolidation des liens sincères d'échanges et de coopération. Dans ce contexte, **UPROMA** est disposée et intéressée pour des échanges de stagiaires avec les entreprises similaires de la sous région.

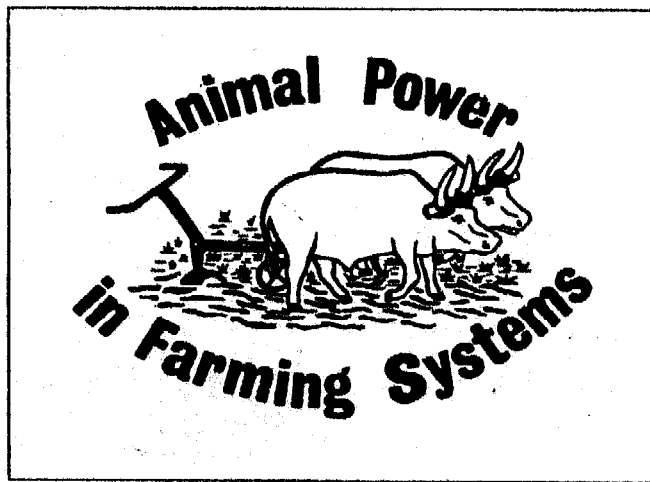

Animal Power in Mali



Title photograph (over-leaf)
Tine cultivation in dry conditions in Mali
(Photo: Bart de Steenhuisen Piters)

Traction animale au Mali

par

D. Zerbo et A. Kantao

Division du Machinisme Agricole, Ministère de l'Agriculture, Bamako, Mali

Présentation du Mali

Le Mali, pays continental de l'Afrique occidentale, couvre une superficie de 1 204 000 km² dont la majeure partie se situe dans la zone sub-saharienne de l'Afrique. Par conséquent, cette situation géographique lui confère un climat tropical sec où l'on rencontre principalement deux saisons: une saison pluvieuse s'étalant sur 4 mois, et une saison sèche s'étalant sur 8 mois.

Les moyennes pluviométriques croissent du Nord vers le Sud et varient entre 100 et 800 mm, avec un maximum de 1000 mm dans certaines zones du Sud. La graduation pluviométrique relève d'une subdivision climatique du territoire en trois zones principales: une zone saharienne, une zone sahélienne et une zone soudanienne. La dernière zone ne se prête pas tellement à l'élevage, mais plutôt à l'agriculture et elle est par conséquent encadrée par les opérations de développement rural.

Pour ce qui est de la population du Mali, d'après les enquêtes de 1976 du bureau de recensement, le Mali compte une population de 6 394 718 habitants dont 3 123 733 de sexe masculin et 3 271 185 de sexe féminin et avec une densité de 5,1 habitants au km². Cette population est en majorité musulmane; on rencontre néanmoins quelques fétichistes et chrétiens.

Les zones urbaines sont constituées de 1 076 829 habitants et la masse rurale occupe 5 318 089 habitants. Ceci révèle le caractère essentiellement rural de la population du Mali, avec un taux de 83% de ruraux. Comme autre remarque, on constate que la population

urbaine est mal répartie car la capitale, Bamako, renferme 39% de la population urbaine du pays.

Historique sommaire de la culture attelée

La traction animale fit son apparition en Afrique de l'Ouest vers les années 1900. C'est de la Guinée qu'elle a gagné le Mali, alors Soudan Français entre 1928 et 1930. Les charrettes furent suivies des houes attelées puis de l'ensemble des matériels de préparation du sol. De 1933 à 1938, le service de l'agriculture entreprit la vulgarisation de ces matériels, d'abord dans des fermes-écoles et, ensuite, en paysannat. De nombreux échecs furent enregistrés; ils étaient dus plus au manque de savoir-faire des vulgarisateurs qu'à la qualité et à l'adaptation du matériel au milieu. Seuls les cercles de Ségou et Koutiala obtinrent des résultats significatifs.

En 1958, la Loi Cadre imprima au machinisme agricole une nouvelle orientation: abandon partiel de la motorisation introduite en 1945 et priorité à la vulgarisation de la traction animale.

A l'indépendance, en 1960, le matériel de traction animale se composait d'environ 5000 charrues et 3000 houes. Une nouvelle orientation tenant compte de la vocation culturelle des zones fut donnée à la culture attelée. Il a été alors décidé d'introduire du matériel polyvalent en zones de cultures sèches, et du matériel spécialisé en zones rizicoles. Bien que le Mali mène depuis l'indépendance une politique de

promotion de la culture attelée, il ne compte que 37% de paysans équipés en matériels.

Les types de matériels de traction animale utilisés

Outils de travail du sol

Charrue type Bajac T.M.

C'est la charrue la plus vulgarisée au Mali. Elle était de construction française et était prévue à l'origine pour la traction équine. Elle est actuellement adaptée à la traction bovine et est utilisée principalement pour le labour. Elle est très appréciée dans la plupart des régions du Mali.

Charrue SISCOMA CF OOOO

C'est une charrue Huard fabriquée au Sénégal. Elle se différencie de la Bajac TM par son système de régulateur. Bien que réalisant de très beaux labours, elle n'a pu être vulgarisée. Elle ne se rencontre qu'en très petit nombre à travers le pays.

Charrue Bajac Liancourtoise B2 et B4

Les charrues B2 et B4 sont de même constitution que la TM, mais elles sont plus lourdes et sont dotées de 2 roues qui leur confèrent une grande stabilité au travail. Malgré leurs poids, elles ne sont tirées que par une paire de boeufs.

Le multiculteur type Ciwara

A l'origine multiculteur Sine, il a été revu et amélioré sur place dans nos ateliers et a pris le nom de Multiculteur Ciwara. C'est un outil polyvalent de construction simple qui permet d'effectuer la plupart des opérations culturales: labour, grattage, sarclo-binage, buttage et récolte d'arachide.

Pour réaliser ces travaux, les équipements suivants peuvent être montés sur sa barre porte-outils:

- une charrue,

- des pics fouilleurs à étauçons rigides,
- un corps butteur,
- des dents sarcleuses avec des socs coeurs ou demi-coeurs montés sur étauçon souple,
- et une lame souleveuse montée sur étauçon rigide.

Le multiculteur type Ariana

Tout comme le Multiculteur Ciwara, le type Ariana permet aussi d'effectuer plusieurs opérations culturales selon les équipements montés sur la barre porte outils. Contrairement au Multiculteur Ciwara, l'Ariana se caractérise par un bâti rectangulaire formé d'une barre transversale avant et d'une barre transversale arrière.

La Houe Asine

Anciennement appelée Houe Occidentale, elle porte aujourd'hui le nom de Houe Asine après une série de modifications et d'améliorations. D'ailleurs, elle ne ressemble actuellement en rien à son aînée, la Houe Occidentale. Elle permet d'effectuer le labour, le binage et le sarclage. La Houe Asine se caractérise surtout par sa légèreté et sa simplicité de conception que la rendent très maniable.

Les Herses à dents rigides: types zig-zag à 2 éléments

Les herse zig-zag attelées à une paire de boeufs sont beaucoup utilisées dans nos rizières pour préparer les lits de semence ou pour enfouir les semences après un semis manuel à la volée.

Les matériels de sémis (les semoirs)

Semoir type SMECMA

Il s'agit du semoir Super Eco amélioré. Il est monorang et effectue des semis en ligne et en poquets. Cet outil polyvalent a été vulgarisé en plusieurs milliers d'exemplaires.

Le Semoir Nodet Gougis (multirang)

Ce semoir, fabriqué au Sénégal à la suite d'un accord avec la maison d'origine, est utilisé dans les rizières. La vulgarisation est en ce moment freinée pour des défauts de fabrication.

Semoirs EBRA et SISOMA Super-Eco

Le semoir EBRA SAM 20 est très peu utilisé, et le semoir Super Eco SISOMA (production sénégalaise) est très peu vulgarisé.

Les charrettes

Les charrettes à traction animale employées au Mali sont généralement celles produites par la SMECMA et qu'on appelle les trains à pneus (TRP). Ces trains de roues en pneus sont d'une capacité qui varie entre 500 kg et 1 tonne; ils sont assez appréciés par le paysannat.

Inventaire du matériel de traction animale

Les données qui suivent ont été recueillies auprès des opérations de développement rural, des concessionnaires de matériels agricoles et à partir des documents de certaines institutions traitant du même sujet. Elles permettent d'avoir quelque indices d'appréciation sur le parc des matériels de traction animale au Mali.

Selon le Tableau 1, on constate que le parc de matériels de traction animale augmente en année.

La Compagnie Malienne pour le Développement des Textiles (CMDT), l'Office de Développement Intégré des Productions Arachidières et Céréalières (ODIPAC), et l'Office du Niger sont les plus gros utilisateurs de charrettes et de multiculteurs. D'ailleurs, selon l'ODIPAC et la CMDT, leurs besoins ne sont pas maintenant totalement couverts par la SMECMA si bien qu'il leur arrive d'avoir recours à l'importation de matériels des usines de la

Tableau 1. Taux d'augmentation du matériel de culture attelée de 1984-86

Désignation	Total matériels 1983-84	Placement 1984-85	Pourcentage d'augmentation	Total
Charrues	147 179	5746	3.9	152 925
Herses	14 028	191	1.3	14 219
Multiculteurs	71 216	6866	9.6	78 082
Semoirs	41 717	4644	11.1	46 361
Houes	18 248	83	0.4	18 331
Charrettes	98 643	5757	5.8	104 400
Désignation	Total matériels 1984-85	Placements 1985-86	Pourcentage d'augmentation	Total
Charrues	152 975	16 935	11	169 872
Herses	14 219	1284	9	15 503
Multiculteurs	78 082	6706	8.5	84 788
Semoirs	46 61	3309	7.1	49 670
Houes	18 331	586	3.1	18 917
Charrettes	104 400	4647	4.4	109 047

Figure 1. Graphique d'évolution des matériels de culture attelée au Mali



Tableau 2. Evolution du parc de matériels de culture attelée de 1979-86

Désignation	1978-79	1979-80	1980-81	1981-82	1982-83	1983-84	1984-85	1985-86
Charrues	129 306	134 271	137 846	142 188	143 283	147 179	152 925	169 872
Herses	12 230	12 678	13 220	13 755	13 795	14 028	14 219	15 503
Multiculteurs	58 229	60 182	62 836	65 487	67 381	71 616	78 082	84 788
Semoirs	24 264	26 604	30 282	33 296	37 102	41 717	46 361	49 670
Houes asines	16 160	17 213	17 569	17 718	18 023	18 248	18 331	18 917
Charrettes	78 373	83 937	86 473	88 999	90 672	98 643	104 400	109 047

SISMAR, au Sénégal. Quant à l'Office du Niger, il a même ouvert depuis bientôt 5 ans son propre atelier de fabrication de charrues basée sur le type Rumpstad, une charrue conçue par la coopération hollandaise. A partir des différents chiffres obtenus, on estime en ce moment qu'environ 37% des exploitations sont équipées en une chaîne de culture attelée.

matique de 1982-83, il a été constaté que l'augmentation du cheptel malien se maintenait, sauf pour les chevaux. C'est ainsi que les ovins ont augmenté de 18%, les ânes de 26% tandis que les chevaux ont diminué de 8%. S'agissant de la répartition du cheptel sur le territoire, la région de Ségou possède plus de bovin, avec 34%; pour les chevaux, Mayes vient en tête avec 30%; enfin pour les ânes, Mopti domine avec 38%.

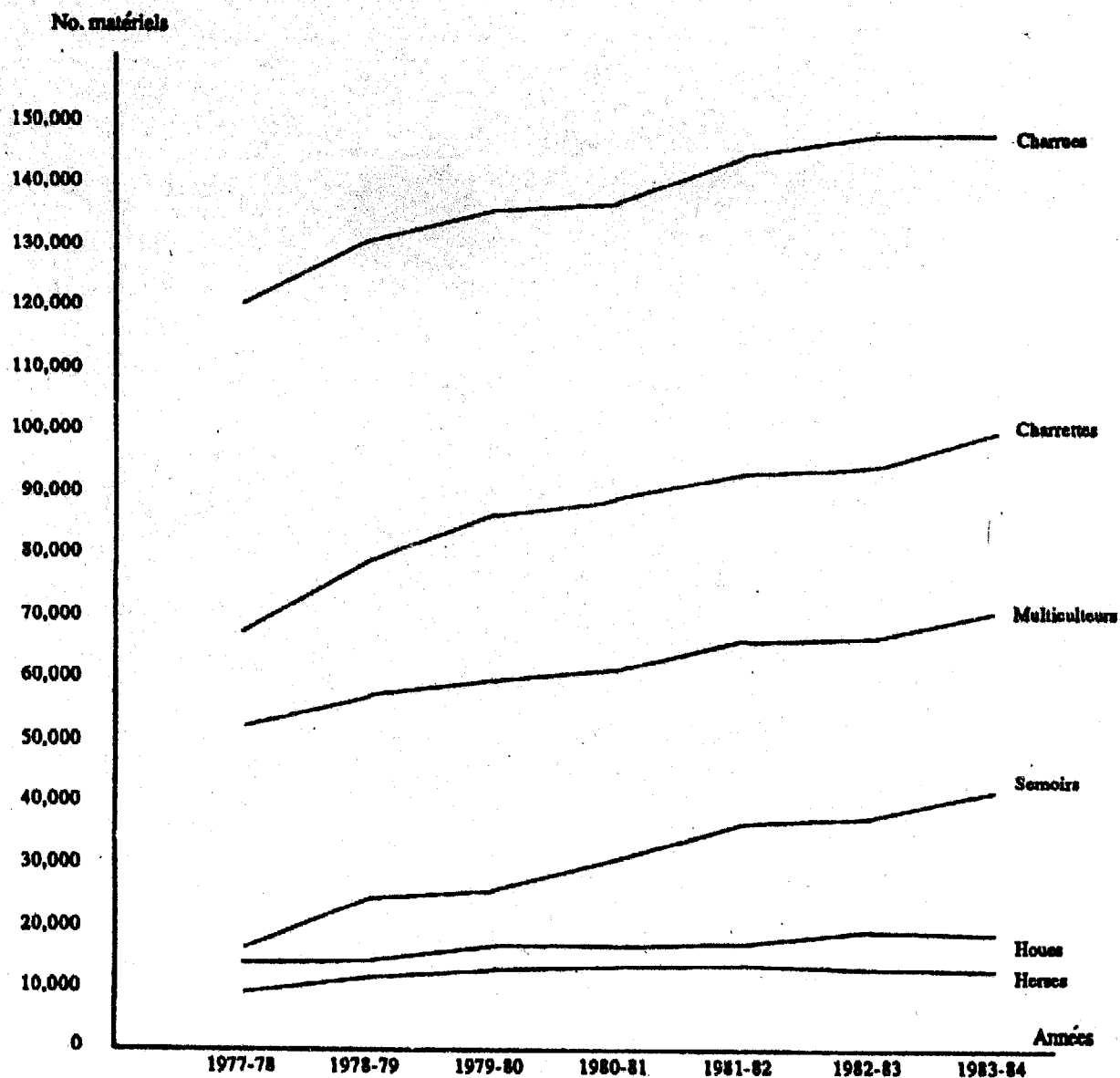
Le seul problème pour l'utilisation d'animaux de trait se situerait au niveau des prix d'acquisition pour les familles qui en sont dépourvues et à celui de l'alimentation. Cette alimentation est rendue difficile à cause de la sécheresse qui a entraîné une dégradation des pâturages naturels. C'est ainsi qu'à défaut des pâturages naturels, certains éleveurs ont recours à l'utilisa-

Aperçu sur le cheptel malien

Les différents tableaux font ressortir une assez bonne disponibilité de bétail de trait dans le pays. D'après le rapport d'enquête de la Direction Nationale de la Statistique et de l'Infor-

Tableau 3. Effectif du cheptel vivant sur les exploitations agricoles

Années:	Milliers de têtes				
	1978	1979	1980	1981	1982
Espèces					
Bovins	2084	2038	2038	2250	2661
Dont vaches	1052	1063	1063	1166	1354
Boeufs de traits	88	99	83	98	118
Cheveaux	30	28	35	44	41
Ânes	137	159	164	189	238

Tableau 4. Nombre de têtes de bétail possédées au Mali

Groupe d'exploitation	Nombre d'exploitation	Bétail bovin
Sans bétail	297 269	
1 tête	18 169	18 169
2 têtes	74 222	148 444
3 têtes	18 213	54 639
4 têtes	23 689	94 756
5 têtes	14 122	70 610
1 à 5 têtes	148 415	386 618
6 à 10 têtes	49 362	375 692
11 à 15 têtes	20 868	274 808
16 à 20 têtes	12 20	22 839
21 à 30 têtes	15 78	388 084
31 et plus	18 550	1 007 620

tion de sous-produits industriels qui sont souvent très chers.

Les charges dues au matériel de traction animale au Mali

En 1974, la Division du Machinisme Agricole a essayé d'étudier les seuils de rentabilité de certaines cultures faites avec la traction animale. A partir de méthodes de calcul simple basées sur l'amortissement du matériel, les frais réels occasionnés par les intrants (engrais, semences, etc.) on a évalué les seuils de rentabilité des cultures suivantes:

Sorgho

Le coût de production de cette culture en station était d'environ 28 000 FM par hectare, les charges se répartissent comme suit:

- main-d'oeuvre: 41 à 42%
- amortissement et entretien du matériel 17.5 à 18%
- semences engrais: 30 à 31%
- animaux de trait: 10 à 11%

Le seuil de rentabilité de la culture, avec utilisation d'engrais et de semences sélectionnées, se situe entre 1350 et 1400 kg/ha; le seuil de rentabilité de la culture, sans engrais, est de l'ordre de 900 à 975 kg/ha. On appelle ici seuil de rentabilité le rendement de la culture qui permet seulement de payer les charges sans bénéfice.

Arachide

Le coût de production à l'hectare était de 42 000 F.M. soit:

- main-d'oeuvre 73%
- matériel agricole 11%
- semences et engrais 9%
- animaux de trait 6.5%

Seuil de rentabilité, avec défrichage, engrais et semences sélectionnées: 1400 kg/ha; sans défrichage et sans engrais: 1370 kg/ha.

Riz pluvial

Coût total de production: 24 500 à 27 000 F.M. par hectare

Répartition des charges:

- main-d'oeuvre 50 à 55%
- matériel agricole 8 à 9.5%
- engrais et semences 32 à 35%
- animaux de trait 4.5 à 5%

Seuil de rentabilité, avec défrichage, engrais et semences sélectionnées: 1080 kg/ha; sans défrichage et sans engrais: 980 kg/ha.

Maïs

Coût de production: 29 000 FM par ha

Répartition des charges:

- main-d'oeuvre 43%
- matériel 15%
- engrais et semences 32%
- animaux de trait 9 à 10%

Seuil de rentabilité, avec défrichage engrais et semences sélectionnées: 1460 kg/ha; sans défrichage et sans engrais: 1440 kg/ha.

On remarque aisément que les charges liées aux matériels agricoles sont relativement faibles par rapport aux autres charges. Il convient néanmoins de souligner que les différents seuils de rentabilité indiqués proviennent d'une étude effectuée en 1974. Elle demande à être réactualisée, compte tenu des différentes augmentations des prix des intrants agricoles depuis cette période.

Problèmes liés à l'utilisation des matériels de traction animale

Les problèmes liés à l'utilisation des matériels de traction animale sont généralement d'ordre économique et organisationnel et on peut les situer à deux niveaux principalement.

Problèmes liés aux animaux de trait

- Prix d'acquisition très élevés par rapport aux revenus des paysans

- Manque (ou insuffisance) de crédits agricoles pouvant permettre aux paysans non nantis de se procurer des boeufs d'attelage
- Alimentation et entretien des boeufs de trait difficiles à cause de la sécheresse et du manque d'équipe sanitaire sur les zones intéressées.

Problèmes liés aux pièces de rechange

Vu la position continentale du pays, les transactions commerciales deviennent difficiles et conduisent à une élévation considérable des prix des matériels. En plus, de nombreux concessionnaires de matériels agricoles connaissent très mal le problème de service après vente et de calcul de prix de vente. Actuellement, le problème des pièces de rechange peut être amoindri par la formation des forgerons et l'installation des actions forgerons dans toutes les Sociétés de Développement Rural.

Conclusion

En définitive, on peut dire que l'utilisation des matériels de traction animale ne présente aucune difficulté insurmontable compte tenu de son poids très faible sur le coût de production.

Il serait souhaitable qu'elle continue à constituer une priorité compte tenu des atouts que possède notre pays. En effet:

- L'introduction de la culture attelée est relativement avancée.
- Les paysans sont maintenant très réceptifs à cette innovation.
- Le cheptel malien est relativement fourni pour cette action.
- La présence d'une unité de fabrication de matériels à traction animale, en l'occurrence la Société Malienne d'Etude et de Construction du Matériel Agricole (SMECMA).
- Enfin, l'implantation de l'action forgeron dans différentes Sociétés de Développement à travers le pays.

Use of animal power in West African farming systems: farm level problems and implications for research: perspectives from Mali

by

Sanath K. Reddy

Senior Agricultural Adviser, USAID, B.P. 34, Bamako, Mali*

Abstract

The paper examines on-farm problems related to adoption of ox-drawn animal traction technology. The problems are examined in terms of four interrelated factors: the farmer; equipment (design, efficiency, complementarity); management of work animals (feeding, housing, health) and cropping systems (production of forage crops and the harvesting, stocking and feeding of crop residues). Specific research approaches are suggested based on on-farm conditions and resources. A summary is given of the role of five different institutions working on animal traction research, development and extension in Mali, and some implications of such institutional configurations are examined. A plea is made for greater coordination and interdisciplinary effort using a farming systems approach. Problems of evaluation methodologies and technologies requiring high levels of management have been noted in recent animal traction research and development work. It is concluded there is a need for common data sets, in the design and evaluation of research, to permit meaningful comparisons within and between countries.

Introduction

In this paper, animal traction refers specifically to use of oxen for tillage and transportation within integrated crop-livestock systems. The long-term benefits of animal traction are well known, and include:

- improving timeliness of farming operations,
- augmenting family labour,
- providing manure, which together with the incorporation of crop residues, has beneficial effects on soil management,
- providing transport for farm and family needs and for generating income and savings,
- providing alternative uses of crop residues and by-products.

However in spite of over 35 years of efforts to introduce animal traction in the West African semi-arid tropics, its adoption by farmers has been slow and uneven. Even in areas where its adoption has been relatively widespread the full benefits of animal traction, in terms of overcoming seasonal labour bottlenecks, efficiency of farming operations, increased yield and income, have not generally been realized. In Mali, this is seen in the regions served by the Compagnie Malienne pour le Développement des Textiles (CMDT), the Office de Développement Intégré des Productions Arachidières et Céréalières (ODIPAC) and the Opération Haute Vallée (OHV).

Various reasons, some intuitive and some based on empirical observations, have been advanced to explain differential adoption of animal traction technology by farmers in the

*The author is grateful to USAID Bamako for authorizing and facilitating the presentation of this paper at the workshop. The views expressed in this paper are those of the author and do not necessarily represent the official views of USAID Mali.

Sahel. These are discussed later in this paper. There have been several research and extension programmes in the past designed to improve the performance of animal traction technology, to resolve farm level constraints and to assist farmers in adopting the technology. While considerable success has been noted in specific small areas within the Sahel, the level of success has not been commensurate with research and extension efforts and resources devoted to it.

This could be attributed to fragmented research efforts and the lack of a clear direction of research, combined with unrealistic policies of extension relating to farmer training, follow-up and credit. Although animal traction use involves long learning periods of 4-6 years, researchers have tended to focus on profitability on a short-term cash-flow basis. Researchers have also emphasized the return to family labour without accounting for synergetic efforts within the system. Many interventions and innovations that have been designed have not been geared to the constraints and resources of the actual farming systems. Examples of inappropriate innovations can be seen in the area of equipment, housing, and off-season feeding using excessive quantities of concentrates. Given the potential and possibilities of animal traction in large tracts of the Sahel, especially in Mali, this paper argues for well-integrated and coordinated research and extension efforts based on better understanding of farming systems.

Reasons for differential adoption

In literature dealing with animal traction research and extension in West Africa, several reasons have been advanced for low levels of adoption or non-adoption of animal traction technology. These are discussed below.

Economic reasons

High initial investment costs

Cash-flow problems in the short run, deferred benefits associated with long learning periods,

lower returns to family labour and overall lower profitability as measured by Net Present Value (NPV) or Internal Rate of Return (IRR) have been cited as reasons for non-adoption. High initial investment costs, particularly for first-time adopters, associated with severe cash-flow problems in the short run have been observed in southern Mali. Ten-year projections elsewhere in the Sahel (Barratt *et al.*, 1982) indicate 20-30% income reduction during the first four years despite an IRR of 15%. Since many Sahelian farmers sell very little of their output, to cover such deficits requires either cash income or a shift towards cash crops.

Deferred benefits

Realization of full benefits to new adopters is often deferred for many years, and this is associated with the long learning period. As many as eight years may elapse before investment in animal traction package breaks even.

Extensification

Several studies and surveys have indicated that there have been no differences in yields and output per unit area between farmers using animal traction and those not using it. However animal traction has generally led to an increase in cultivated area (BECIS, 1983).

Lower returns to family labour

In studies in Burkina Faso and Mali, animal traction provided lower returns to family labour (the primary constraint on the farm) than manual cultivation. Furthermore animal traction tended to be labour-shifting rather than labour-saving and exacerbated the labour constraint at weeding and harvest times. This was due to larger cultivated areas, which increased the area to be weeded and harvested. The weeding problem was also compounded by lack of weeding equipment, or its low level of acceptance. A survey of 21 animal traction (oxen) projects in Africa revealed that less than one fifth of those participating in animal traction programmes used weeding equipment.

Lack of mutually complementary equipment

In West Africa the general tendency has been to emphasize the plow as the main item of animal traction equipment. Weeding equipment, including blade-harrows, has received less research and development, and less extension attention. Farmers have frequently been observed using their plows as weeding tools, even though they are inefficient for this operation. However multipurpose toolbars (*multiculteurs*), with plowing and weeding attachments, are gaining acceptance.

Off-season labour requirements

The labour requirements to maintain work animals on the farm during the off-season, and the opportunity cost of off-farm work during the January-May dry-season period have often been cited as reasons for non-adoption of animal traction. This does not seem to fully explain non-adoption, because the caring of animals during grazing and browsing is generally the responsibility of children or adolescents, both in the cropping season and the off-season. Furthermore in most areas, except those bordering Côte d'Ivoire and Senegal, off-season migration of adults or active workers does not seem to be a major phenomenon.

The limited availability of forage and crop residues during the dry season has been a constraint and an off-season management problem.

High mortality rates

Where the introduction of animal traction has not been accompanied by animal health services, high rates of mortality (as high as 40%) caused many farmers to revert to manual tillage practices. However experience in southern Mali shows that animal mortality is relatively easy to control and has been brought down to an acceptable rate of 2.5 per cent.

Lack of institutional services

Credit has often not been available for the purchase of both oxen and equipment, although this involves substantial cash outlays. Very few extension agencies offer credit for animal traction. Exceptions are those promoting cash crops like cotton, maize and tobacco with programmes of marketing and some extension services supported by donor agencies.

The lack of spare parts and repair services has been considered as a main factor in explaining non-adoption, particularly in early observations. However more recently in Mali several blacksmiths (often trained by extension agencies) have been providing these services including the manufacture of plows, spare parts and carts in the villages themselves.

Farmer training in the proper use of equipment and oxen has often been severely lacking. A large majority of adopters still use two or three persons for plowing with a pair of oxen or a donkey. While the people are often one adult and two children, this work may be one of the reasons why the labour-saving advantage has not been more clear.

Lack of comprehensive and systematic approaches

The tendency has been to begin and end the animal traction programme with a plow and a pair of oxen. Several mutually related issues have not been systematically approached by multidisciplinary teams. These have included credit and equipment; animal health and housing; the harvest and conservation of bush forage and crop residues for off-season feeding; the training of farmers to improve skills in plowing and the training of animals. Thus low and uneven adoption can partially be attributed to the failure of both research and extension programmes to develop comprehensive and systematic approaches. The institutional failures may explain the lack of uptake, rather than widespread decisions by farmers not to adopt the technology. Otherwise, it is

difficult to explain why certain farmers are still demanding equipment from village-based blacksmiths in the absence of institutional credit.

It is only recently that a comprehensive pre-extension programme in southern Mali has been initiated. The programme, developed jointly by the farming systems research division (Division de Recherches sur les Systèmes de Production Rurale, Institut d'Economie Rurale: IER-DRSPR) and the extension agency (CMDT), concentrates on farmers who are not using animal traction but who meet the re-defined credit criteria (Verbeek, Sanogo and Kleene, 1986). The animal traction package consists of: a pair of oxen and a multipurpose toolbar, both provided on credit; the training of oxen and farmer over a 21-day period; an animal health care package; the inclusion of fodder crops in the recommended rotations; and technical advice on major farm operations. The programme was designed on the basis of farming systems research findings and in its first year of operation a total of 80 farmers are participating. Socio-economic and production data are being collected, but results are not yet available.

Animal traction research, development and extension in Mali

Institutional framework

There are five governmental agencies in Mali which are actively involved in research, development and extension of animal traction and related technologies to farmers (in this context the term development refers to the production of a prototype based on research which is then tested and modified, before being extended as a final product; it is not used synonymously with extension management). Each of the five agencies is specialized in its subject matter areas and has specific functions and mandates. These research and development agencies are:

- *Division du Machinisme Agricole (DMA)*. The division of agricultural engineering of the Ministry of Agriculture (MoA) is responsible for the design, development and testing of equipment such as plows, carts and weeders.
- *Ministère chargé des Ressources Naturelles et de l'Élevage (MCRNE)*. The ministry for natural resources and its national livestock research institute (INRZFH) are responsible for research on livestock including disease control and treatment, nutrition and fodder development.
- *Institut d'Economie Rurale (IER)*. The institute of rural economy under the Ministry of Agriculture is responsible for agricultural research aimed at yield-increasing technologies, such as tillage methods and practices, weed control and management, planting methods (dates, densities, planting in rows, ridges and furrows) and cropping systems using animal traction.
- *Direction Nationale de l'Agriculture (DNA)*. The national directorate of agriculture is responsible for transferring technologies developed by these three institutes to the farmers through various extension agencies under its control.
- *Direction Nationale de l'Élevage (DNE)*. The national directorate of livestock under MCRNE is responsible for ensuring the availability of field/extension services relating to the control and management of animal diseases and overall animal husbandry programmes.

Thus five agencies and two government ministries are involved in the development and transfer of animal traction-related technologies to farmers in Mali. At present the role of private agencies in stocking and distributing animal traction inputs is limited.

Interrelations and the need for coordination

The efficiency of animal traction in farming operations is a complex function of at least five interrelated factors:

- *Equipment:* its design, size, weight and flexibility to adapt to different soil types and crops.
- *The work animals:* their training, health and nutritional status.
- *Availability of animal husbandry technologies:* techniques to promote on-farm maintenance of animals such as: housing using locally available materials; system of conservation of hay, forage and crop residues; collection and disposal of dung and urine; systems of combining concentrates with roughage; cropping systems capable of producing increased quantities of nutritive crop residues and fodder.
- *Farmer characteristics:* their training in the use of equipment and animals; their management of animals; their ability to make adjustments in the technologies offered to fit their specific needs; their own resources to acquire equipment and animals in the absence of institutional credit; their capacity to produce and manage feed and fodder for livestock.
- *Institutional support:* The essential elements of institutional support include: the availability of credit; equipment repair facilities; spare parts; extension advice and its adjustment to individual situations; training; animal health services at or near the villages.

It is because of the interrelationships of these five factors that there is a clear need for coordination and collaboration between different agencies. While there has been much agreement on the need for coordination and interdisciplinary approach, evidence of all the agen-

cies coming together with a unified research plan for village level action has been sporadic at best. What is clearly needed is an inter-agency task force consisting of researchers dealing with animal traction issues. This group should then select a manageable number of equipped farmers on the basis of some key criteria (level of equipment, number of years of continuous use, farm size, family size, crops grown) in two or three regions of high potential but relatively low adoption of animal traction technology. Each of the research disciplines (agronomists, engineers, livestock specialists, economists and extension specialists) should make observations relevant to their concerns, synthesize their observations and design tests/approaches to resolve the constraints and/or to improve the performance of the system taking into account the interrelationships of the factors described earlier: farmers, equipment, animals, technologies and institutional services. This would provide common, minimum data sets on interrelated factors for several categories of farmers for comparison. Such a coordinated approach/study should be of a longitudinal nature conducted over 3-4 years.

In agricultural research in Africa in general, there have been much talk and discussion of the need for coordination. What is urgently needed is action, and a plan for implementing the action, no matter how simple, limited or crude it may be.

Farm level problems and research approaches

Observations from various animal traction projects indicate a range of farm level problems. Representative problems are enumerated below and discussed briefly suggesting approaches for testing.

On-farm feeding of draft animals

The feeding of work animals in the period July-December is not considered as a signifi-

cant problem, due to the availability of forage and grazing. However a key problem is how best to overcome the off-season feeding constraints and improve the physical condition of traction animals just before the rains come, in order to cope with the heavy work demands of July-August. Some appropriate areas for research may be the following:

Harvesting, stocking and management of crop residues

In general groundnut and cowpea crop residues are quite carefully harvested and stocked. However in general sorghum and millet crop residues are left in the field and are consumed directly by the herds returning from transhumance. A large proportion of the standing sorghum-millet stalks remaining in the field after harvest is trampled and wasted. It is possible to estimate the quantity of stover required for a pair of work oxen during the dry period (January-June). Thus a few tests could be conducted where the required quantity of stover from the top half of the residual plant is harvested and stored. This could be fed to the work oxen during the January-June period in combination with small quantities of groundnut and cowpea residues. Additional labour demands for harvesting and transporting the stover and its impact on the labour constraint at harvest time should be studied.

Improving the quality and quantity of crop residues

Cropping systems should be developed to produce enough good quality crop residues. Observations in Mali indicate that in communities which are not self-sufficient in cereals there is a strong resistance to growing crops for fodder alone. A potential solution seems to be the introduction of rampant-growing (fodder type) and high-yielding cowpeas either as pure or mixed crops. The introduction of catch crops is another potential solution. These are crops which are sown rather late in the season after all the principal crops on a farm are planted. These are leguminous in nature, such as horse gram and mung bean, and serve twin

purposes. Firstly they produce both nutritious food grains for family consumption (or sale) and plant residues for work oxen. Secondly they enrich the soil while providing plant cover to reduce erosion. These crops demand minimum management. Land that is otherwise left fallow can be put under a catch crop.

Supplementary feeding

The impact of feeding small quantities of supplementary concentrates, together with sorghum-millet stover, could be assessed during 6-7 weeks preceding the beginning of plowing/tillage operations in June. Such a practice is well established in the semi-arid tropics of southern Asia. In such areas, traction animal fodder (primarily rice, sorghum, and millet stover) is supplemented with approximately 700-800 grams of peanut cake, cotton seed or horse gram (grain) per head per day, to boost animal condition and health. Researchers in the past have often suggested the use of 2-3 kg of purchased concentrates per head per day which has usually been totally uneconomical.

Stock and storing crop residues

This is an area to which no attention has been paid by researchers. What are different stocking/storing modes? Often farmers tend to stock on the roofs of sheds (hangars) made out of locally available materials. On top of the roofs the residues are exposed to high summer temperatures, and it would be valuable to learn the effect on nutritive quality and palatability of storing in shade underneath the hangar roofs.

Competition with other livestock

Where limited quantities of groundnut and cowpea fodder are produced, it would be interesting to establish whether farmers prefer to feed it to small ruminants or to feed it to draft animals. If the preference is for the former, it might be possible to determine what other browse or forest produce could be substituted, so that in the critical weeks before the planting season, more of the available nutritive fodder could be made available to work oxen.

Animal housing

This is another on-farm problem which has received limited attention. Several structures have been tried without a follow-up of farm level acceptance. Open coralling and traditional cattle sheds (hangars) are the most common systems of housing in Mali. A third method that has been observed involves the earth being excavated up to a metre and a hangar installed. The apparent beneficial effect was that the un-eaten stover was spread as bedding which partially decomposed absorbing dung and urine. Every two months or so the compost so formed was removed to the field. Each of these structures has advantages and disadvantages. Any improvement in this area should start with a study of farmers' existing practice in areas where animal traction has been relatively well accepted. Appropriate modifications might then be identified and introduced that would make the animal housing more effective.

Training

A critical on-farm problem area is the lack of farmer training in animal traction particularly for first-time adopters. Skills of plowing, tillage in general, and the handling and training animals may need to be imparted. It is commonly observed that at least three individuals (an adult and two adolescents) operate a single plow or toolbar (*multiculteur*). This may be one reason why the labour-reducing aspect of animal traction has not been clearly demonstrated. Experience on the research stations in Mali has clearly shown that farmers and labourers can be taught the necessary skills, such that one person can operate a plow or toolbar drawn by a pair of oxen. It is more a question of extension, and perhaps research agencies should organize training sessions rather than additional research efforts.

Animal health and management

The non-adoption of animal traction is often a direct function of real or perceived mortality rates of work animals. It was observed that in one area the major reason for low levels of animal traction adoption was the recorded mortality of 40-45%. However, in the area of one extension agency in Mali, mortality has been brought down to the more acceptable level of 2.5%. This has been achieved by close linkage with veterinary services, preventive measures, farmers training and the timely treatment of affected animals. Training farmers to look out for disease symptoms is an essential step.

Labour shifting

Another key on-farm problem reported in research into the constraints to the adoption of animal traction is that animal traction in the Sahel is a labour-shifting rather than a labour-saving technology. This seems partly due to the increased labour demands at weeding time due to larger areas being sown when animal traction is employed and to increased weed populations due to row planting. It is also related to increased labour demands at harvest time due to the larger areas and greater overall yield.

The phenomenon of labour shifting is to a certain extent due to the lack of complementary and mutually supporting technologies. In this case the lack of appropriate weeding equipment or its non-adoption for some reason seems particularly important. Similarly labour demands at harvest time could be reduced by the use of ox-drawn or donkey carts, whether rented or owned, to transport the harvest. There is a severe lack of reliable information on this aspect; for example it is known that transport of the harvest from the fields to the homes is labour-consuming, but not what proportion of the total harvest labour is required for such transport.

Differential applicability of animal traction

In evaluating animal traction, it is important to bear in mind that its applicability varies with the nature of different cropping enterprises. For example, maize, cotton, rice and groundnuts require relatively better seedbed preparation than do sorghum-millet-based systems. This could lead to different strategies of adoption. Some farmers will be owner-adopters, some owner-adopter-hirers, and others renter-adopters. Farmers with excess capacity may choose to hire out their oxen and equipment, while attending to certain cultural practices manually.

Implications for research programmes

Research perspective

It is clear that researchers need to understand farmers' perspectives. Farmers alone have an integrated view of the whole system. This calls for a farming systems perspective. Researchers need to understand how the problem of adoption or non-adoption of animal traction manifests itself under different systems and conditions. Without this understanding it would be impossible to develop technologies to improve the various systems and conditions.

Coordination and collaboration between research and extension

Mali is well endowed with a farming systems research organization and this presents a great opportunity to coordinate and integrate different aspects of animal traction research and development. Institutional coordination is important where several agencies are involved in research, development and extension. The nature of on-farm problems described in earlier sections is such that unless different institutions work in unison, there will be no improved package that combines all essential elements and addresses the farmer, the equip-

ment, and the feeding, housing and health of the animals.

Clarification of concepts and concerns

In several writings on the subject of animal traction and/or integration of farming with livestock activities one cannot help observing a lack of clear concepts and concerns. In the opinion of this writer, one has to start with clear assumptions and approaches to the twin issues of farming-livestock integration and animal traction. Some illustrative ideas are suggested:

- The nature of farming-livestock integration for a range of farms should be defined and clarified. An example would be the management of one to two pairs of work oxen on a farm with a certain number of small ruminants.
- The effects of animal traction on the traditional relationship between cattle-owners and herders. In the opinion of the author existing relationships may not be disturbed given the small number of work animals that are likely to be retained on the farm. The research should focus on possible improvements to present systems. The traditional practice of cattle-owner-farmers assigning the management of animals to herders, together with the symbiotic relationship between cattle-owners and herders, is one that is likely to continue for a long time.
- Distinguishing the effects of animal traction in terms of completeness and complementarity of equipment promoted and/or used on a farm.
- Focus on animal traction practices and equipment which are feasible or have been feasible elsewhere under similar conditions and constraints. An example that comes to mind is the research effort related to deep plowing and incorporation of crop residues (primarily sorghum-millet

stubbles). It is impracticable in the Sahel and of doubtful benefit.

Clarification of methodology

Several methodological imperfections and divergencies have been noted in explaining economic reasons for non-adoption. Some examples of problem areas, taken from the study of Crawford and Lassiter (1985), include:

- failure to differentiate adequately between the quality, quantity and timing of labour required to maintain a pair of oxen
- using labour figures derived from herding range cattle and assuming that they would be similar for the maintenance of draft oxen
- giving unrealistic opportunity costs for the labour required to maintain a pair of oxen during the off-season.

In this context researchers often neglect two facts. Firstly draft animal maintenance competes minimally for the services of adult males and secondly it is assumed that non-farm employment through migration to urban centres is equally accessible to all rural communities and there is unlimited urban demand for migratory labour during this period.

High management research approach

Animal traction technology has been the victim of high expectations. It was expected to introduce certain high management practices such as deep plowing for incorporating plant residues and high level of weed control in subsistence cereal crops like maize and millet. Serious doubts exist as to the feasibility and even desirability of deep plowing in the rainfed semi-arid tropics of West Africa. Using the same high level of weed control in sorghum

and millet as used in high value cash crops such as cotton and tobacco seems unjustified. If research on animal traction is to be useful to policy-makers and extension agencies some of the methodological imperfections must be eliminated. Researchers should seek to eliminate certain high management approaches and focus more on what is feasible and practicable.

References

- Barratt, V., Gregory, L., Wilcock, D., Baker, D. and Crawford E. 1982. Animal traction in Eastern Upper Volta: a technical, economic and institutional analysis International Development Paper 4. Department of Agricultural Economics, Michigan State University, East Lansing, Michigan, USA. 118p. (E,F).
- BECIS 1983. A socio-economic survey conducted in OHV. Opération Haute Vallée, Bamako, Mali.
- Crawford, E. W. and Lassiter, G. C. 1985. Constraints on oxen cultivation in the Sahel: comment. *Amer. J. Agr. Econ.* 67: 684-685. (E).
- Delgado, C. L. and McIntire, J. 1982. Constraints on oxen cultivation in the Sahel. *Amer. J. Agr. Econ.* 64: 188-196. (E).
- DRSPR 1985. Expérience de la DRSPR en matière de culture attelée en Zone Mali-Sud. Division de Recherches sur les Systèmes de Production Rurale, Institut d'Economie Rurale, Bamako, Mali. (F).
- Norman, D. W., Newman, M. D. and Ouedraogo, I. 1981. Farm and village production systems in the semi-arid tropics of West Africa: an interpretive view of research. *Research Bulletin* 4 (1). International Crops Research Institute for the Semi-Arid Tropics (ICRISAT), Patancheru, India. 94p. (E).
- Verbeek, K 1985. Problèmes de la culture attelée: cas des exploitations à une seule paire de boeufs. Division de Recherches sur les Systèmes de Production Rurale (DRSPR), Sikasso, Mali. (F).
- Verbeek, K., Sanogo, B. and Kleene, P. 1986. The FSR & D - extension linkage: experience from Mali. pp. 152-164 in C. B. Flora and M. Tomecek (Editors): Selected proceedings of the Farming Systems Research Symposium, held 5-8 October 1986, Kansas State University, Manhattan, Kansas, USA. (E).
- Viertra, G. A. and Sanogo, B. 1985. Maintenir la condition des boeufs d'attelage pendant la saison sèche: les expériences au Mali Sud. *Volet Fonsébougou* (IRRT), Division de Recherches sur les Systèmes de Production Rurale, Institut d'Economie Rurale, Bamako, Mali. (F).

Contraintes et améliorations de la traction animale en zone Mali-Sud: l'expérience de la DRSPR

par

Moulaye I. Sangaré,¹ Christian Ladrette,²
Ruben R. Mungroop³ et Abou Berthé⁴

Division de Recherches sur les Systèmes de Production (DRSPR),
Institut d'Economie Rurale (IER), Bamako, Mali

Résumé

Le développement de la traction animale dans la zone Mali-Sud remonte aux années 1950, avec l'introduction et le développement des cultures industrielles, en général, du coton, en particulier. Ce développement a permis une amélioration sensible du niveau de vie des paysans grâce, notamment, à l'augmentation des superficies cultivées et des rendements obtenus et à la réduction des exigences de main d'oeuvre extérieure des exploitations.

Cependant, la diffusion de la culture attelée rencontre divers obstacles qui constituent les cibles des différents plans d'amélioration proposés. Les principales contraintes de la culture attelée dans ce système sont constituées par:

- la mortalité élevée par suite de maladie ou d'accidents;
- les problèmes d'alimentation des boeufs de labour, particulièrement aigus en saison sèche;
- l'approvisionnement en taurillons, du fait surtout de la faible productivité des élevages villageois et de l'absence de marchés du bétail.

Les améliorations proposées dans ce système concernent les éléments suivants:

- la production de fourrages par la culture du nièbé, principalement;
- la complémentation minérale et les traitements sanitaires;

- le dressage amélioré, complété par une formation et un suivi technique pluriannuel.
- la sélection d'animaux de race locale, à cause de leur rusticité.

Des résultats satisfaisants ont été enregistrés dans tous ces programmes d'amélioration. Il est toutefois apparu que la maîtrise de la culture attelée dans la région du Mali-Sud passe par une intégration plus prononcée des pratiques agricoles et d'élevage.

Introduction

Le Mali est un pays continental où 90% de la population est rurale. L'économie rurale et les activités qui en dépendent, représentaient 80% de la Production Intérieure Brute (PIB) en 1976. L'agriculture et l'élevage représentaient 68% de la part du PIB revenant à l'économie rurale. Cela explique pourquoi le gouvernement du Mali, dans sa stratégie d'autosuffisance alimentaire a adopté, entre autres, une politique agricole essentiellement basée sur les éléments suivants:

- la valorisation des acquis de la recherche thématique;
- une approche du développement intégré prenant en compte non seulement la production agricole d'une zone mais aussi des aspects fondamentaux tels que la santé et l'alphabétisation.

¹ Agro-zootechnicien; ² Spécialiste en culture attelée; ³ Agronome; ⁴ Zootechnicien.

Ces deux aspects sont à l'origine de la création en 1979 de la Division de Recherches sur les Systèmes de Production (DRSPR) au sein de l'Institut d'Economie Rurale (IER). La DRSPR bénéficie de l'appui financier et technique des organismes suivants:

- Le Centre de Recherche pour le Développement International (CRDI), Ottawa,
- L'Institut Royal des Régions Tropicales (IRRT), Pays Bas,
- L'Agence Internationale pour le Développement (USAID).

La promotion de la culture attelée constitue une des priorités de travail de cette nouvelle structure. La DRSPR comprend trois équipes pluridisciplinaires: l'Axe Bougouni-Sikasso, le Volet Fonsébougou et le Volet "Opération Haute Vallée" (OHV)

La première charrue a été introduite au Mali en 1928 à l'Office du Niger; mais l'essor de la traction animale ne débuta que dans les années 1950, avec l'introduction et le développement des cultures industrielles en général et du coton en particulier. La culture attelée a constitué le support sur lequel s'appuyèrent les programmes de modernisation des opérations culturales; elle en reste encore l'élément dynamique.

En effet, le système d'élevage joue un rôle très important dans la production agricole. Le travail des boeufs de labour est l'un des plus importants éléments dans l'évolution des exploitations agricoles. Les animaux de trait, en général, et les boeufs de labour, en particulier, sont une source unique d'énergie renouvelable et de puissance agricole: ils s'apprécient en valeur pendant leur période de vie utile. Ils constituent le premier stade de la combinaison entre la production agricole et celle de viande de boeuf. Le développement de la traction animale permet une amélioration du niveau de vie des paysans grâce, notamment aux augmentations de superficies cultivées, à la réduction des exigences de la main d'oeuvre extérieure et

à la maîtrise des adventrices, source d'accroissements des rendements.

La culture du coton et la culture attelée, essentiellement bovine, peuvent servir de critères à la stratification de l'agriculture dans la zone Mali-Sud, qui correspond à la 3^{ème} région administrative du pays, en deux situations agricoles majeures bien distinctes, avec des niveaux de production différents:

- une situation de production élevée où le système de production est de type intensif. Près de 75% des exploitations agricoles possèdent au moins une paire de boeufs de labour; ces animaux de trait constituent 16% du cheptel.
- une situation de faible production où les systèmes de production sont du type semi-intensif et/ou traditionnel. Environ 5% des exploitations agricoles possèdent au moins une paire de boeufs de labours; 3% du cheptel bovin évoluent dans cette situation.

Dans l'ensemble on peut estimer que 50% des exploitations agricoles de la région sont équipées. D'importants efforts sont toutefois en cours pour équiper les paysans manuels par le biais d'un crédit "premier équipement". Ils sont menés par les organismes de développement rural (ODR); la DRSPR s'intéresse également aux problèmes liés à ce type de crédit et propose des voies d'améliorations.

La première partie de ce document présente d'abord les caractéristiques essentielles de l'agriculture dans la 3^{ème} région, en mettant l'accent sur les relations agriculture-élevage; elle situe, par la suite, le rôle joué par les animaux de trait dans les exploitations agricoles. Ce rôle est tout d'abord analysé dans la situation de production élevée où la culture attelée bovine s'est développée depuis une vingtaine d'années et a été ainsi à l'origine de très importants changements sur les plans agrotechni-

que et socio-économique. Les paysans ont en effet acquis une certaine maîtrise de la culture attelée qui leur a permis d'étendre les superficies et d'augmenter les rendements. Dans certains villages, comme celui de Gladié, les paysans ont pu réaliser un niveau assez élevé d'intégration agriculture-élevage. La deuxième partie du document analyse les contraintes spécifiques à cette situation et évalue les possibilités et les voies d'améliorations.

L'analyse concerne également les villages de la deuxième situation, où pour différentes raisons, la culture attelée bovine ne s'est jusqu'ici pas bien développée en raisons de plusieurs types d'obstacles; compte tenu de la détérioration des termes de l'échange en particulier, il est devenu très difficile pour le paysan de rentabiliser le crédit "premier équipement" dès la première année, à moins qu'il n'ait acquis un bon niveau technique.

Carte 1. Sites d'intervention de la DRSPR, Zone Mali-Sud



Tableau 1.1. Importance numérique du cheptel dans la 3^{ème} région

Cercles	Total Bovin	Bœufs de labour		Ovins/ Caprins	Asins	Equins	Potentiel animaux de trait	
		Total	% bovins				Totaux	% bœufs
Sikasso ¹	66 515	25 502	38,34	22 145				
Sikasso ²	219 100	27 188	12,41	95 900	9220	130	228 450	11,90
Kolond ¹	16 134	2719	16,85	10 322				
Kolond ²	165 000	3803	2,30	74 100	5000	20	170 020	2,24
Yanfol ¹	37 862	3895	1,03	5749				
Yanfol ²	72 000	5000	6,94	26 200	460	10	72 470	6,90
Kadiol ¹	23 486	4579	19,50	6764				
Kadiol ²	64 000	043	73,88	25 100	400	10	64 410	7,83
Bougou ¹	14 188	8178	57,64	7638				
Bougou ²	215 000	21 800	10,14	79 800	3550	80	218 630	9,97
Koutia ¹	95 538	38 102	39,88	77 003				
Koutia ²	277 130	57 000	20,57	102 600	9320	360	286 810	19,87
Yoross ¹	120 494	11 715	57,16	20 318				
Yoross ²	75 500	9644	12,77	22 800	2050	430	77 980	
Total ¹	274 221	94 691	34,53					
Total ²	1 087 730	192 478	11,90	426 500	30 000	1040	1 118 770	11,57

¹ Effectif encadré par la CMDT.² Estimation du service Vétérinaire.

Sources: Rapport annuel CMDT 1984-85; Rapport annuel de la Direction Régionale Vétérinaire, 1985.

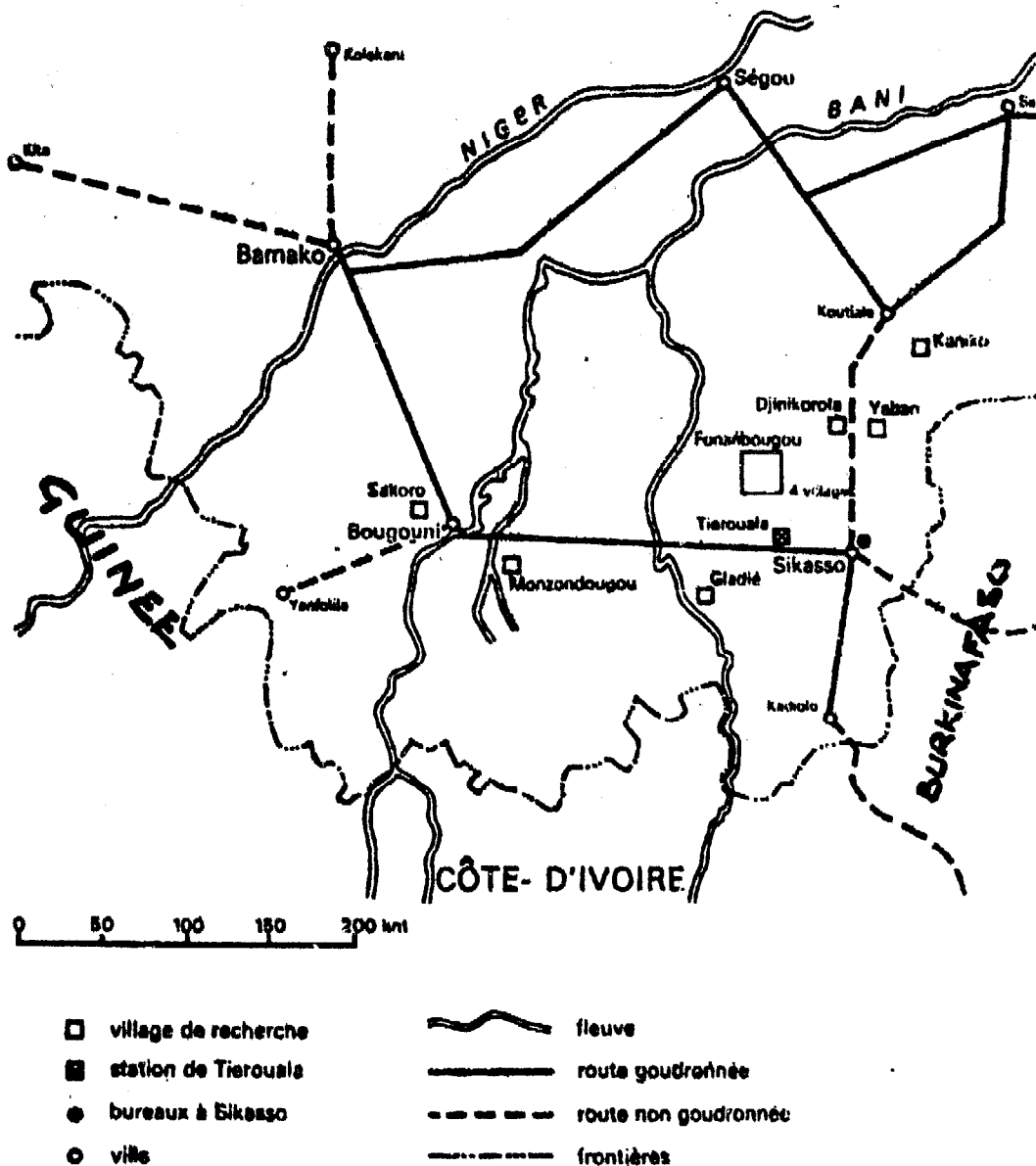
Les stages de dressage amélioré permettent non seulement une meilleure connaissance des attelages et de leur gestion, mais ils constituent également l'occasion de former les paysans sur des aspects complémentaires: techniques culturales, matériel agricole, utilisation de la matière organique, conservation des sols, etc. Les villages de Yaban et Djirikorola illustrent cette situation. Le dressage des bœufs constituant une des principales contraintes dans ces villages; la troisième partie du document traite des actions entreprises en matière de dressage. Enfin l'amélioration de l'habitat des bœufs de labour en vue d'arriver à une culture attelée plus intensive et plus rentable constitue l'objet de la quatrième partie du document.

Présentation de la zone

Environnement technique

La région de Sikasso, qui constitue le cadre de l'étude, représente 80% de la zone Mali-Sud et est comprise entre les isohyètes 850 mm au

Nord et 1400 mm au Sud. Elle couvre une superficie de 76 480 Km², soit 6% du territoire national. Située au Sud du Mali, la région de Sikasso fait frontière avec le Burkina Faso, la République de Guinée et la République de Côte d'Ivoire.

La population est estimée à environ 1 200 000 habitants dont 90% de ruraux. Cette région fournit 21% de la production agricole avec 40% de la production céréalière et 70% de la production de coton; elle renferme 20% du cheptel bovin du pays, se classant ainsi au 2^{ème} rang national, après la région de Mopti.

Les sols sont généralement de type ferrugineux et deviennent latéritiques sur les hauteurs, à l'exception des fonds de vallées qui sont constitués par des argiles hydromorphes. Le climat est soudano-guinéen au Nord et guinéen au Sud. La végétation est très variable du Nord au Sud. Elle va de la savane herbeuse où prédominent les graminées naturelles de la famille des *Andropogonae*, à la forêt, en passant directement ou indirectement par une série de

Tableau 1.2.
Superficies travaillées mécaniquement (en ha) en fonction des principales cultures et par Cercle

Cultures Cercles	Coton			Maïs			Mil/sorgho		
	Labour	Sarclage	Buttage	Labour	Sarclage	Buttage	Labour	Sarclage	Buttage
Bougouni	4435	3320	3161	3476	2378	1219	2422	2348	1494
Kolondi.	1504	1161	957	1515	852	274	1510	669	302
Yanfol.				2170	1472	116	8	8	5
Sikasso	20 639	18 595	16 138	8948	7076	3641	16 615	12 674	8985
Kadiolo	1462	1260	1308	1257	963	1023	1716	889	862
Koutiala	36 228	33 856	25 174	9277	8490	6153	30 197	42 609	20 969
Yorosso	8725	7046	5321	1443	1098	694	11 072	8391	4496
Total	72 933	65 238	52 059	28 086	22 329	14 407	63 648	67 588	37 133

Source: Rapport annuel du CMDT, 1984-1985.

transitions allant de la savane arbustive à la savane boisée; la couche herbacée du Sud est dominée par *Andropogon Guayanis*, *Hyperhenia spp.* et *Cochlospermum planchonii*. La production potentielle des pâturages varie de 2,5 à 3 t de matière sèche au Nord, et de 5 à 8 t au Sud.

La région de Sikasso renferme environ 1 100 000 bovins dont 130 000 boeufs de labour, 30 000 asins, 1000 équins et 426 000 ovins-caprins (voir Tableau 1.1.). Compte tenu de la nature des sols, les équins sont utilisés comme animaux de bât. Les asins, jadis utilisés comme animaux de bât, sont également utilisés pour le transport de l'eau, du fumier et des récoltes à l'aide de charrettes. Les ovins sont utilisés pour les cérémonies religieuses et coutumières. Les caprins sont réservés de préférence à l'acquisition du travail extérieur. Les bovins sont de plus en plus utilisés pour les besoins de la culture attelée. Les boeufs de labour représentent 80% des animaux de trait actuellement utilisés dans la région.

La pathologie du milieu est dominée par le caractère endémique des trypanosomiasés animales, beaucoup plus accentuées dans la zone guinéenne où sévit la mouche tsé-tsé. D'autres types de maladies sont rencontrés dans la région:

- maladies infectieuses: charbon symptomatique, charbon bactérien, péripneumo-

nie tuberculose, stréptothricose et heart water.

- maladies parasitaires: endo-parasitoses (Nématodes, Distomatose coccidiose), hémoparasitoses (anaplasmose-piroplasmose) et les ectoparasitoses (tiques-gales).

Environnement socio-économique

Les sociétés rurales en zone Mali-Sud ont une culture essentiellement agraire. Des relations de complémentarité semblent avoir dominé leurs rapports avec les sociétés pastorales. A cet égard Doutressoule (cité par Berthe, 1984) notait: "Cultivateurs fixés au sol, pratiquant traditionnellement une agriculture rudimentaire, ils se constituent peu à peu des troupeaux de boeufs et de moutons par échange de leurs grains contre des animaux qu'ils obtiennent des pasteurs peulhs, Maures et Touareg. C'est leur façon de placer leurs économies, non de les faire fructifier, mais de les capitaliser car leur élevage est encore plus rudimentaire dans ses pratiques que celui des nomades". La population est composée de Bambara, Bozos, Senoufo, Minianka, Bobo et de peulhs d'origine hamitique.

La terre constitue le principal moyen de production et de reproduction de la société. Sa gestion est sous l'autorité du chef de village. Ce dernier et le conseil des anciens sont les garants de l'identité culturelle du village. Théori-

quement la terre appartient à celui qui la cultive, mais elle ne peut être vendue. Ce système d'organisation répondait aux besoins de production du village et à sa survie, en rapport avec les techniques d'utilisation des ressources. Les actions de développement de la culture attelée dans le cadre des activités de la Compagnie Malienne pour le Développement des Textiles (CMDT) notamment, ont accentué la pression foncière et entraîné une différenciation croissante des systèmes agraires villageois. La culture attelée et la production de coton ont entraîné des modifications dans la régulation technique et l'organisation socio-culturelle des sociétés agraires de cette région. Les terres les plus faciles à travailler et correspondant le plus souvent à des pénélaines font l'objet d'une forte pression en fonction de l'évolution de la culture attelée.

Parmi les structures de développement de la région, la CMDT a l'impact le plus fort en raison de sa densité d'encadrement. Ses activités portent sur un modèle de développement intégré. En matière de conservation de l'environnement et de maîtrise des productions animales et sylvicoles, le service de l'élevage, et celui des eaux et forêts interviennent en même temps que la CMDT. Les résultats pratiques de ces deux structures sont cependant faibles. L'accent a été surtout mis sur la santé animale et la police forestière. En matière de recherche agricole la région de Sikasso est parmi les mieux loties. La recherche agronomique intervient à travers ses différentes sections, soit en stations ou en sous-stations, soit chez le paysan. Créée en 1979, la DRSPR a débuté ses recherches dans cette région où ses expériences lui ont valu son extension actuelle dans la région de Koulikoro.

Traits essentiels de l'agriculture dans la 3^{ème} région

L'association agriculture-élevage dans la 3^{ème} région fait ressortir deux situations bien distinctes correspondant à deux niveaux de production différents:

Une situation de production élevée

C'est le cas de Koutiala-Sikasso et de Yorosso où le taux d'occupation des sols est très élevé. Selon le Projet Inventaire des Ressources Terrestres (PIRT), 30 à 70% des terres sont aptes à l'agriculture. La densité des cultures est de l'ordre de 30 à plus de 60%. La densité de la population est relativement élevée: 18 à 28 habitants au km², contre une moyenne régionale de 15 habitants au km².

Le système de production est intensif, avec une jachère de courte durée. La culture de rente, surtout celle du coton, y est très développée; le rapport superficies des céréales sur celles du coton est de l'ordre de 1,19. La culture du coton a favorisé des transformations profondes dans l'agriculture dans la région de Sikasso. Sa coexistence avec le maïs dans l'assolement des exploitations agricoles en culture attelée explique les performances satisfaisantes réalisées en production vivrière dans les zones d'action de la CMDT.

Cette situation abrite 59% de l'effectif des boeufs de labour de la région étudiée. Les races qu'on y rencontre sont, dans l'ordre décroissant, le Méré (produit du croisement Zébu peulh soudanien-Taurin Ndama), le Ndama et le Zébu peulh soudanien. Cette zone est en partie infestée par les mouches tsé-tsé, vecteurs de la trypanosomiase. La strate herbacée constitue l'essentiel de l'alimentation du cheptel en saison des pluies. En saison sèche les espèces ligneuses et les résidus de récolte représentent les sources d'alimentation du bétail. A cette période, les agro-éleveurs font un complément aux boeufs de labour en leur apportant des sous-produits agricoles et agro-industriels (conditionnement des boeufs de labour) alors qu'une transhumance de faible amplitude est effectuée pour le reste du troupeau.

Une situation de faible production

Elle est caractéristique des localités de Yanfolila, Kolondiéba, Kadiolo et Bougouni; le taux d'occupation des sols y est faible. L'aptitude

des terres à l'agriculture varie de 10 à 30%. La densité moyenne de la population est de l'ordre de 12 à 14 habitants au km². Les inondations des rivières sont les sites les plus dépeuplés. Les densités des cultures sont faibles et varient de 10 à 30%, excepté dans les environs de Bougouni où elles dépassent 60%.

Le système de production est semi-intensif à traditionnel. Le rapport des superficies de céréales à celles du coton est de l'ordre de 1,9 pour toute la zone; il est variable d'un cercle à un autre: 1,32 à Bougouni, 2,01 à Kolondièba, 2,03 à Kadiolo et à Yanfolila où les céréales sont dominantes. Le coton, moteur du développement rural, y fait timidement son entrée. Le niveau d'autosuffisance alimentaire est variable, faible dans certains cas, satisfaisant dans d'autres. L'association agriculture-élevage y est peu développée.

Selon le service de l'élevage, seuls 2.6% du cheptel bovin de cette situation sont constitués de boeufs de labour. L'élevage sédentaire extensif est influencé de plus en plus par des formes de mouvements de transhumance (30% à Yanfolila et Bougouni et 60% à Kadiolo et Kolondièba) avec les zones voisines de la SO-DEPRA (Côte d'Ivoire). La divagation des animaux, très accentuée dans cette zone constitue un sérieux handicap pour la gestion du cheptel et du pâturage; elle dure 6 mois sur douze. Les races bovines rencontrées sont, dans l'ordre décroissant, le Ndama, le Méré et le Zébu. Il faut noter que Yanfolila constitue le berceau de la race Ndama. Cette zone est le plus grand foyer de départ à l'exode au détriment de la production agricole dans la région de Sikasso. C'est aussi une zone à trypanosomiase animale et à onchocercose, pour les humains.

Pourquoi d'une recherche sur les systèmes de production rurale

Jusqu'à très récemment la recherche agricole se faisait selon le schéma classique de création-diffusion allant de la station (milieu contrôlé)

au champ du paysan. Cette approche, essentiellement caractérisée par son aspect sectoriel (car ne s'adressant le plus souvent qu'à une culture, voire à un aspect spécifique d'une culture), ne prenait pas en compte les contraintes et les stratégies de production adoptées par les paysans.

Elle excluait du coup toutes les contraintes imputables à l'environnement socio-économique et ne permettait ni de prendre le "système" dans son ensemble, ni de faire la distinction entre différents types d'agriculteurs ayant des problèmes différents. La création de la DRSPR relève du souci de créer un maillon supplémentaire pour combler cette lacune.

La recherche sur les systèmes de production a pour attribution de mener dans un cadre pluridisciplinaire toutes les études et recherches appropriées afin de mettre au point des systèmes de production agricole adaptés à chaque zone écologique du territoire national. Par conséquent, la DRSPR a procédé au choix raisonné de ses villages de recherches en fonction de cinq critères: population, équipement, production de coton, superficies, accessibilité en toute saison. Dans le choix des villages, l'équipement a été privilégié en fonction des normes suivantes:

- Village de "niveau avancé": où plus de 80% des unités de production (U.P) sont équipées; une unité de production étant définie comme un groupe de personnes, unies ou non par des liens de parenté, qui produisent et consomment ensemble.
- Village de "niveau moyen": où 50 à 60% des unités de production sont équipées;
- Village de "niveau démarrage": où 90% des unités de production sont en culture manuelle.

Dans chaque village, les exploitations faisant l'objet des études ont été choisies en fonction de cinq critères: trois critères qui renvoient au niveau des ressources, dénommés critères d'analyse et deux critères objectifs, appelés critères de caractérisation.

Tableau 2.1 Composition de l'équipement, nombre de boeufs de trait et taille du troupeau bovine de 7 UP à Gladié

U.P	Matériel pour la Culture Attelée					Elevage	
	Charrues	Multiculteurs-	Semoirs	Herses	Charrettes	Boeufs de labour	Taille troupeau
11-25	2	1	1	1	2*	10	150
10-22	2	1	2	2	1	11	189
17-39	2	1	1	1	1	14	140
05-12	2	1	1	1	1	10	120
03-10	1					3	3
01-04	1	1			1	3	15
01-05	1	1				4	6

Note: * La 2^{ème} charette est à traction bovine et a été interdite comme prototype par la DSPR.

Tableau 2.2

Superficies (en ha), rendements (kg/ha) et temps de travaux (boeufs/jours) de 7 UP à Gladié

UP	Coton		Maïs + Petit mil		Sorgho		Superf.	Rend.	Temps
	Superf.	Rend.	Superf.	Rend.	Superf.	Rend.			
11-25	9,48	1829	18,24	9,18	2362	9,08	3,12	2465	13,28
10-22	11,73	1939	21,05	7,79	2654	15,29	3,42	570	9,59
17-39	6,66	1846	7,73	5,97	3746	12,33	3,70	1860	10,53
05-12	7,97	1422	12,43	7,71	2440	13,97	12,61		
03-10	3,34	1994	14,94	1,75	2317	5,71	2,73		
01-04	3,06	1294	4,90	2,91	908	7,83	22,23	920	6,08
01-05	2,21	907	14,34	2,05	2048	7,80	2,08	443	7,69

Source: Résultats du suivi des exploitations à Gladié (DRSPR, 1986).

Les critères ressources

Ils englobent les variables suivantes:

- le nombre d'actifs: permet de déterminer la disponibilité de main d'oeuvre au sein de l'exploitation.
- le nombre d'attelage: permet de déterminer le niveau d'équipement de l'exploitation et donne une idée du degré d'intégration agriculture - élevage,
- la taille du bétail: donne une idée de l'importance et de la structure du troupeau (bovins, ovins, caprins), donc de la disponibilité en ressources convertibles, et du potentiel d'intégration de l'agriculture et de l'élevage.

La disponibilité en terre n'a pas été utilisée car le problème se pose à la fois en termes de qualité et de quantité.

Les critères objectifs

Ils se composent des éléments suivants:

- le niveau d'autosuffisance céréalière de l'exploitation;
- le niveau du rendement coton de l'exploitation: donne une idée des possibilités d'augmentation des revenus monétaires.

La combinaison de ces critères a permis de classer les unités de production en trois catégories:

- les unités de production "traditionnelles": elles ne cultivent pas de coton et ne bénéficient pas de l'élevage.

ficient donc d'aucun encadrement technique.

- les unités de production de situation intermédiaire: elles ont des rendements de coton inférieurs à 1,3 t/ha.
- les unités de production intensives: elles réalisent des rendements de coton supérieurs à 1,3 t/ha.

L'analyse des relations entre les ressources et les objectifs a permis d'identifier les contraintes par type de système de production.

Les villages de niveau avancé: le cas de Gladié

Généralités

L'évolution de l'agriculture à Gladié se caractérise par une densification des relations agriculture-élevage. Il est possible d'y observer une forte empreinte agricole et un élevage important. La culture attelée joue un rôle important dans ce village. En effet, plus de 80% des U.P. sont en traction animale; l'étude de ce système de production de type intensif a été réalisée grâce à l'analyse des résultats obtenus sur 7 U.P. suivies en 1985/1986.

L'équipement

Le tableau 2.1 nous donne la composition du matériel de culture attelée, les boeufs de labour et la taille du troupeau bovin des 7 U.P. étudiées. Il ressort de ce tableau que toutes les 7 U.P. ont au moins une charrue (TM); 4 U.P. sur 7 ont au moins 5 paires de boeufs de labour, deux charrues, un multicultureur, un semoir, une herse et une charrette asine.

Les pratiques agricoles

Toutes les cultures, sauf le riz et le dah, sont en champs communs. Les principales spéculations végétales sont le coton et les céréales (mil, maïs/petit mil, sorgho). La riziculture est exclusivement pratiquée par les femmes dans

les bas-fonds sur des parcelles ne dépassant pas 0,15 ha.

La rotation pratiquée est de type triennal: coton- maïs/petit mil-sorgho. Le tableau 2.2. présente les superficies des cultures, les rendements et les temps de travaux en boeufs-jour par hectare (B.J/ha). L'analyse du tableau révèle les éléments suivants:

- les superficies sont allouées aux trois cultures dans les proportions suivantes: 38% pour le coton, 31% pour le maïs/petit mil et 31% pour le sorgho;
- la pluviométrie de l'année a, de façon générale, beaucoup joué sur le niveau des rendements; elle a eu un début tardif (10 juin) et une fin précoce (10 octobre), ce qui a pénalisé toutes les cultures qui sont installées après un labour. En outre, les différences de rendements entre cultures renvoient aux facteurs suivants:
- le coton en tête de rotation bénéficie de la majeure partie des fertilisants organiques et chimiques;
- le maïs/petit mil bénéficie de l'effet du précédent cultural et des apports de petite quantité de fumure organique et d'urée;
- le sorgho en fin de rotation ne bénéficie presque pas d'engrais, ce qui explique le bas niveau des rendements enregistrés.

Dans ce système, le type de rotation dominant est constitué par 10 à 20 ans de culture continue, suivis par une jachère de courte durée. L'utilisation des attelages se fait suivant un rythme de 4 heures de travail mécanisé pour une demi-journée. L'utilisation de l'énergie animale joue ainsi un rôle prépondérant dans la production du coton, du maïs/petit mil et du sorgho.

Les pratiques d'élevage

Origine du troupeau

Le troupeau bovin est d'origine essentiellement agricole (revenus du coton et surplus céréalier). Une enquête menée dans le village de

Gladié a révélé que 17% des U.P. ont accédé à l'équipement par la culture du coton; en outre, 14% des U.P. ont constitué leur troupeau à partir des revenus du coton.

Le rôle du troupeau dans les U.P. de Gladié

Les relations agriculture-élevage sont très complexes dans ce système. L'élevage bovin concerne 82% des U.P. La maîtrise de la culture attelée passe par l'utilisation des attelages et la production de fumier. A Gladié le cheptel bovin est constitué de 4% de Ndama, 11% de Zébu peulh et 85% de Méré. Cela témoigne de l'intérêt qu'accorde l'agro-pasteur à l'amélioration de la force de traction des attelages mé-rés; le "3/4-de-sang-Zébu" semble le plus recherché malgré ses charges médicales élevées. La production de fumier se fait grâce à la constitution de parcs pour les animaux pendant la saison sèche.

Les améliorations déjà proposées dans ce système

Depuis 1981 la DRSPR a initié les actions suivantes: la production de fourrages, le complément minérale, avec l'introduction de la pierre à lécher, la construction de parc mobile en fil de fer barbelé et les traitements sanitaires.

Production de fourrage

La culture du niébé fourrager a été testé de trois façons: maïs-niébé en relais, sorgho-niébé en association et niébé pur. Le maïs-niébé en relais a été testé en 1981 et n'a pas été accepté par les paysans car il rentrait en contradiction avec leur pratique d'association maïs-petit mil. Le niébé mis en association avec le sorgho n'a pas réussi en 1982 à cause du semis trop tardif du niébé par rapport au sorgho installé après le coton et le maïs-petit mil et dont les plants étaient déjà vigoureux; en outre, la culture du niébé entre les lignes de sorgho empêchait le sarco-buttage du sorgho.

Le niébé pur a été le plus apprécié parmi les trois façons de cultures du niébé dans ce système. En 1983, 1984 et 1985 les paysans l'ont installé surtout sur les nouvelles défriches, avant le cotonnier. La maîtrise technique du niébé est acquise, mais sa récolte rentre en compétition avec celle du coton et du maïs.

Complémentation minérale et traitements sanitaires

Ils ont intéressé toutes les U.P. qui ont un troupeau, quelque soit la taille de celui-ci. Le paquet comprend la complément minérale, les vaccinations, les déparasitages interne et externe, les tripanocides et les antibiotiques.

Les contraintes

Les principales contraintes de la traction animale dans ce système agraire villageois sont les suivantes:

- la mortalité par suite de maladie ou d'accident: elle est la principale cause de la disparition des attelages par suite d'hétoparasitoses (la trypanosomose et les maladies transmises par les tiques, surtout).
- l'alimentation des boeufs de labour: les pâturages naturels constituent l'aliment de base des ruminants. Le manque d'eau et de fourrage pendant la saison sèche se posent avec acuité. A cette époque les résidus de récoltes, l'aliment de bétail (concentré) et les fanes de légumineuses restent les principales sources de nutrition des boeufs de labour.
- l'approvisionnement en taurillons pour la culture attelée: il reste un problème à cause de la faible productivité des élevages villageois et de l'absence de marché de bétail dans le Mali-Sud.
- l'évolution des unités de production traditionnelles en milieu intensif: les exploitations les moins équipées utilisent la traction animale grâce à un "effet villageois" alors qu'elles n'ont pas les ressources monétaires nécessaires. Elles établissent alors des relations d'échanges avec les exploita-

tions équipées: labour contre main d'oeuvre extérieure au moment des travaux d'entretien et des récoltes; ces opérations sont en effet très exigeantes en main d'oeuvre puisqu'elles occupent 28 à 33%, pour l'entretien des cultures et 47 à 57% des temps de travaux, pour la récolte.

- l'amélioration de la culture attelée par une meilleure alimentation des boeufs de labour.
- l'amélioration de l'intégration agriculture-élevage avec l'identification et l'évaluation des différents flux.
- l'évolution et la différenciation des unités de production.

Conclusion partielle

La maîtrise de la culture attelée dans les villages de niveau avancé passe par une intégration plus prononcée des pratiques agricoles et d'élevage. Comme nous venons de le constater, il existe des liens très étroits entre le niveau d'évolution de l'agriculture et celui de l'élevage, notamment dans le cadre de la production agricole. Par conséquent, les thèmes de recherches en cours dans ce village visent à identifier et à résoudre les problèmes que pose l'évolution de l'agriculture dans un système agricole villageois en voie d'intensification avec, comme corollaires:

- la sédentarisation du système de culture, les problèmes de reproduction de la fertilité et l'amélioration de la productivité.

Dressage amélioré

Principes de base

Les villages de faible niveau de production agricole se situent généralement à un stade "moyen" ou de démarrage avec la culture attelée.

Pour trouver des solutions aux problèmes rencontrés dans ces villages, la DRSPR a élaboré un programme cohérent d'actions techniques différenciées pour chaque type d'exploitation. Une des principales parties de ce programme s'intéresse aux exploitations de type "C", jugées aptes à recevoir un crédit "premier équipement".

Figure 4. Le jougage et le guidage

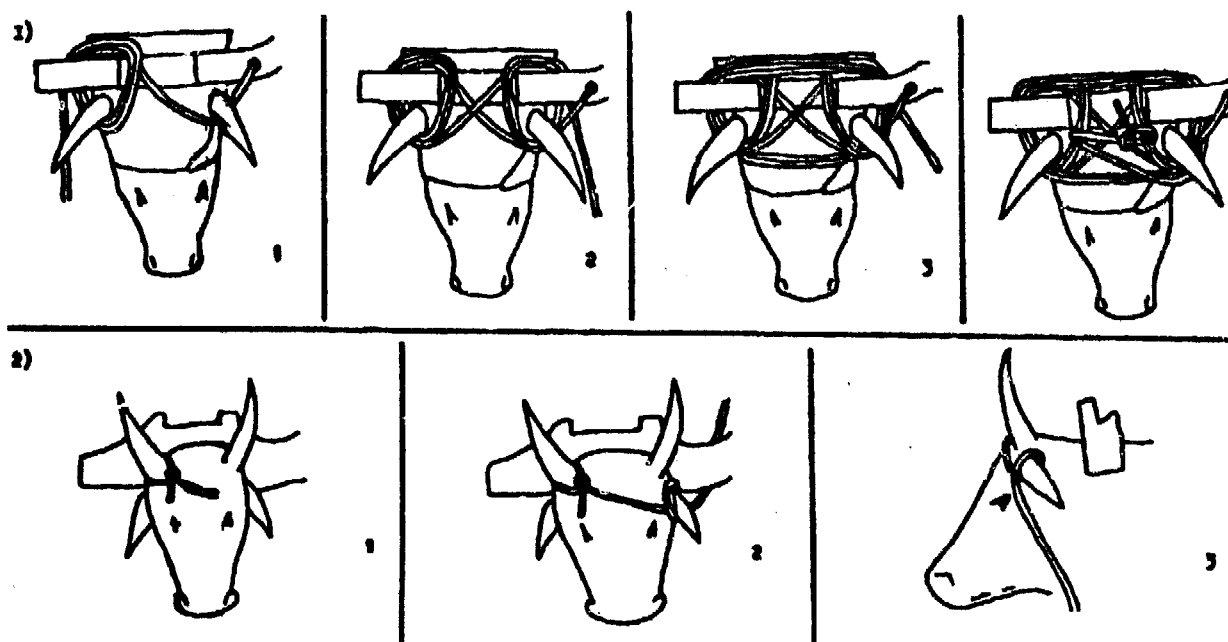

En première année d'expérimentation (1983), il s'est avéré que le manque de maîtrise de la culture attelée constituait la principale contrainte de ce type d'exploitation. Par consé-

quent, un paquet technique a été mis au point en 1984; il comprenait notamment une méthode de dressage améliorée, complétée par une formation et un suivi technique plurian-

ment, un paquet technique a été mis au point en 1984; il comprenait notamment une méthode de dressage améliorée, complétée par une formation et un suivi technique plurian-

ment, un paquet technique a été mis au point en 1984; il comprenait notamment une méthode de dressage améliorée, complétée par une formation et un suivi technique plurian-

Tableau 3.1. Matériel agricole

Caractéristiques Compositions	Prix en F. CFA (1985)
Charrue T.M.	26 500
1 Bâti + corps (20 cm) 1 chaîne de traction 1 roue	
Multiculteur CIWARA	44 400
1 Bâti, 3 étançons, 1 roue, 5 étriers 1 chaîne de traction, 1 lame coeur 2 lames demi-coeur, 1 corps buteur 1 corps carrue (30 cm)	
Charrette asine	35 000
Train de roue complet: 1 essieu, 2 roues, 2 chaises	
Charrette bovine	
Non disponible plusieurs prototypes en test par la DRSPR	
Semoir super Eco	49 000
Complet (+4 disques)	
Herse	20 000
2 éléments zig-zag à 30 dents	
Multiculteur "Ariana" (en test)	
Bâti complet.	prix à déterminer
2 roues 1 barre d'extension 1 corps charrue (ordinaire ou réversible), 1 corps buteur 6 à 9 dents de grattage, 6 à 9 dents de sarclo-binage	
Charrue "RUMPSTAD"	
complet SANDY III (20 cm, 32 kg)	prix à déterminer
complet SANDY II (25 cm, 43 kg)	prix à déterminer

Pratiques paysannes

Les paysans utilisent deux méthodes de dressage:

- la première méthode consiste à atteler deux jeunes taurillons avec un joug et à leur apprendre à marcher ensemble; par la suite, le paysan joint au joug un traineau qui, après quelques essais, est remplacé par une charrue. Suivant l'âge et le tempérament des jeunes animaux, la durée du dressage varie de 15 jours à plus d'un mois. Cette méthode présente l'inconvénient d'entraîner beaucoup d'accidents.
- la deuxième méthode consiste à atteler un jeune élève avec un ancien boeuf de labour. C'est la méthode utilisée couramment quand le paysan a d'autres boeufs de labour.

Les inconvénients de ces deux méthodes sont multiples: le dressage a lieu tardivement, après la tombée des premières pluies; par ailleurs, il n'y a pas de progression et les animaux traversent une période de stress alimentaire en raison de la

Tableau 3.2.
Travaux mécanisés effectués par des paires de boeufs en lère année de dressage traditionnel et amélioré (Villages Yaban et Djirigorola)

	Dressage traditionnel		Dressage amélioré			
	1983 (5 paires)		1984 (6 paires)		1985 (14 paires)	
	PP*	%**	PP	%	PP	%
Grattage	0,2	4	3,2	29	2,7	40
Labour	2,2	32	5,0	48	3,6	57
Semis	0,4	6	1,4	14	1,1	18
Billonnage	0,5	7	1,3	13	0,4	7
Sarclo-Binage (1)	2,7	16	5,1	49	1,8	28
Sarclo-Binage (2)	0,5	8	1,9	19	2,6	41
Buttage	1,4	20	2,2	22	3,3	52
Total*** (ha)	7,9		20,1		15,5	

Notes: *PP: Superficie réalisée par paire (ha) **%: PP/Superficie totale*100

***Total: Cumul des travaux mécaniques réalisés par paire

Organisation d'un stage de dressage

Calendrier et programme

Pour avoir des animaux prêts à travailler dès les premières pluies d'avril, le dressage doit être fait durant la période allant de mars à avril. L'exécution précoce du dressage laisse suffisamment de temps aux paysans pour continuer l'entraînement des boeufs en leur faisant effectuer des travaux de grattage à sec ou en semi-humide.

Avec une exécution trop précoce du stage, les animaux risquent d'être mis au repos et, par conséquent, de désapprendre. Cela signifie qu'il faut commencer l'organisation du stage au moins 6 mois à l'avance, compte tenu du temps nécessaire pour choisir les paysans, arrêter les dossiers de crédit, acheter les boeufs et le matériel. En 1986, la DRSPR a même décidé, en accord avec la CMDT, de commencer l'identification des paysans concernés dès le mois de mai, c'est-à-dire 10 mois avant le stage.

Le stage comprend deux parties:

- Une formation pratique aux techniques de dressage.

- Une formation aux techniques de culture, d'élevage, d'entretien et d'utilisation du matériel, ainsi qu'aux méthodes de conservation du sol. Cette partie se déroule pendant les heures chaudes de la journée, de préférence à l'ombre; elle est complétée par des applications pratiques, le matin et par des projections de diapositives, le soir.

Participants, lieu et infrastructure

Chaque stage peut regrouper 10 à 15 paires de boeufs, sous la conduite d'un seul agent de vulgarisation ou d'un paysan-dresseur. Chaque exploitation doit fournir deux bouviers par attelage; ces derniers sont tenus de participer à l'intégralité du stage. Le chef d'exploitation et les autres actifs doivent, autant que possible, assister aux séances de formation. L'encadrement regroupe les paysans concernés par le crédit "premier équipement" ou des volontaires désireux de suivre le dressage amélioré.

Le choix du village de stage est fonction des critères suivants:

- existence du plus grand nombre d'attelages à dresser
- absence de problème d'eau;

CORNES - SOLIDES, SYMETRIQUES
 A EMPHASE LARGE
 COU - COURT ET MUSCLE
 FACE ET FRONTAL - LARGES
 CORPS - LONG ET PRES DU SOL
 SQUELETTE - FORT
 MEMBRES - FORTS, MUSCLES
 APLOMBS AVANTS - REGULIERS

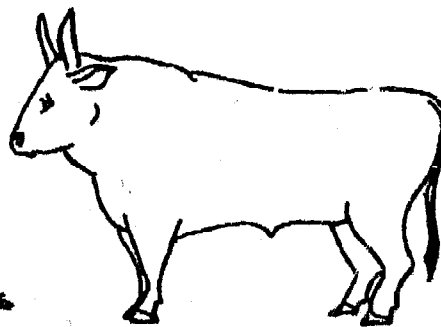

DOE - DROIT, LONG
 CUISSSES MUSCLEES
 TESTICULES CASTRATION
 BIEN EFFECTUEE
 APLOMBS ARRIERES -
 NORMAUX
 SABOTS LARGES
 SOLIDES.

CARACTERES : VIF, ENERGIQUE MAIS PAS AGRESSIF

Figure 1. Silhouette d'un boeuf de trait

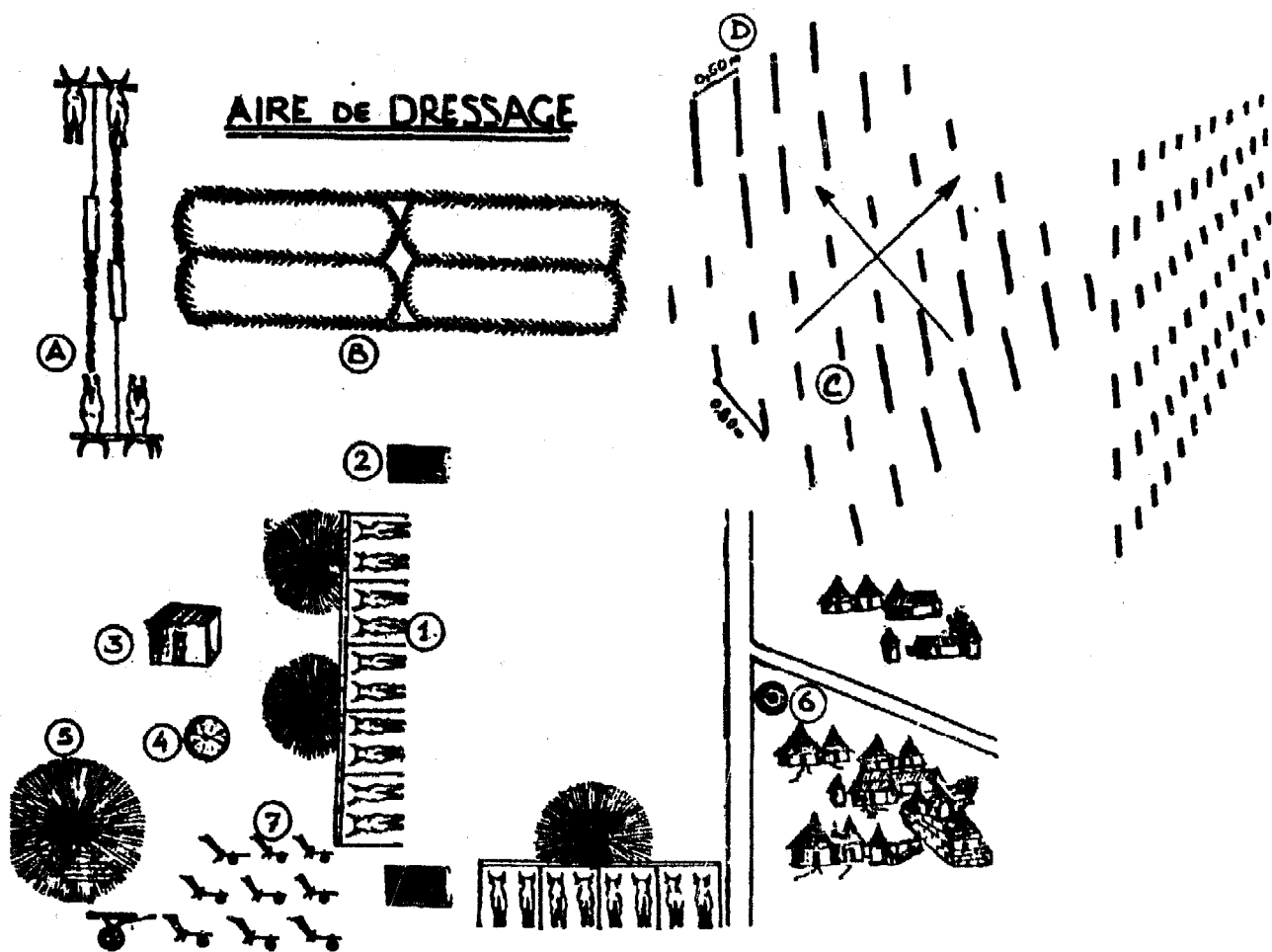

Figure 2. Aire de dressage (1. Etables. 2. Fosse fumiére. 3. Abri. 4. Silo pour réserves fourragères. 5. Emplacement pour la formation. 6. Puits. 7. Matériels. A-D Maquettes.)

Tableau 3.3. Stages de dressage des boeufs, nombre de boeufs dressés et d'agents formés

	Année	Boeufs	Dressage (Boeufs rejetés)		Formation (Agents formés)	
			Avant	Après	Recherche	Vulgarisation
Villages de Recherche ¹⁾	1984	16			3	
	1985	38	1		2	14
	1986	62	1	5		26
Villages de pré-vulgarisation	1985	34				16
	1986	306	3	4		4
Totaux		456	4	10	5	60

¹⁾ en 1986 11 paires de boeufs du Centre saisonnier CMDT de Sirakélé ont été incluses (stage de formation des agents CMDT)

Tableau 4.1. Hangar amélioré: matériaux et prix (1986) (module pour 1 paire de boeufs)

Libellé	Quantité	Montant F CFA
Grands poteaux de 4,50m	2 x	fp
Traverses de 3,50m pour la base de toiture	4 x	fp
Poteaux de 1,50m (aire de stockage)	4 x	fp
Poteaux de 3m (pente de toiture)	2 x	fp
Poteaux de 2m (construction toiture)	9 x	fp
Paille (construction toiture)	20 tas	fp
Barre de jouage 3,50m	2 x	fp
Poteaux pour le couloir de sortie	16 x	fp
Fil de fer barbelé	55 x	2475
Huile de vidange	10 l	fp
Ekafos (protection du bois)	20 ml	1000
Pointes cavaliers	0,5 kg	500
Main d'oeuvre		fp
Total		3975

fp: ces matériaux sont fournis par le paysan

- facilité d'accueil et d'encadrement des paysans;
- entente avec les autres villages;
- présence d'un chef de village dynamique et influant.

de matériaux locaux. Il s'agit d'une infrastructure légère, faite pour la durée du stage et dont le coût financier est nul (voir Fig. 3).

Aspects techniques

L'aire de dressage

Le dressage a lieu sur un terrain d'environ 1 hectare (Fig. 2), dégagé, ombragé et proche du village. Il abrite quelques constructions simples faites entièrement par les paysans à partir

Choix des animaux et méthodes de jouage

De préférence, des animaux de race locale sont choisis à cause de leur rusticité. La conformation et les caractères de ces animaux sont don-

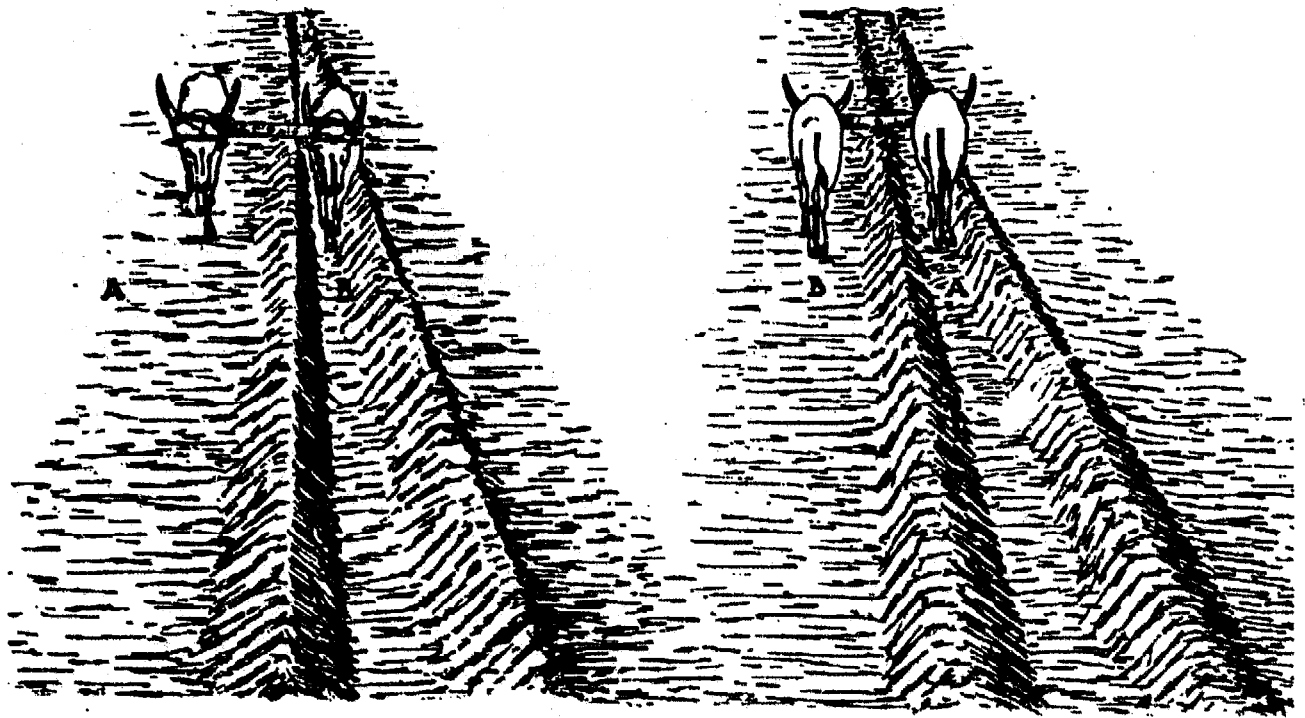

Figure 5. Paire de boeufs à l'entraînement dans le sillon maquette

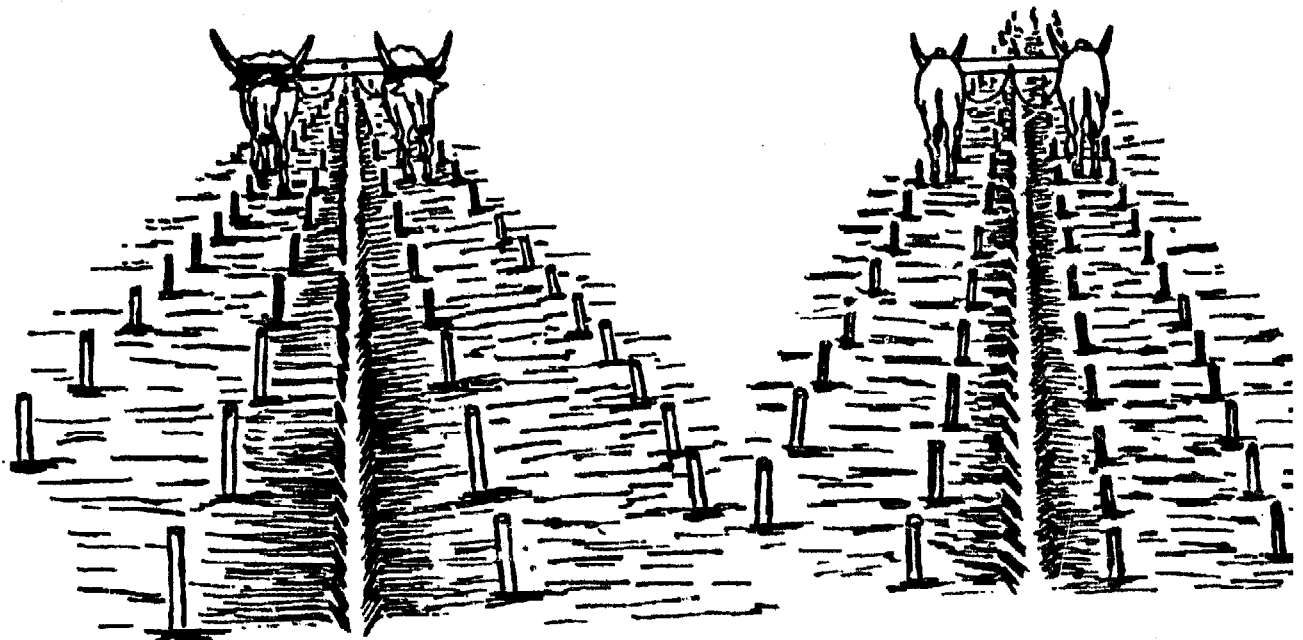

Figure 6. Paire de boeufs à l'entraînement sur maquettes

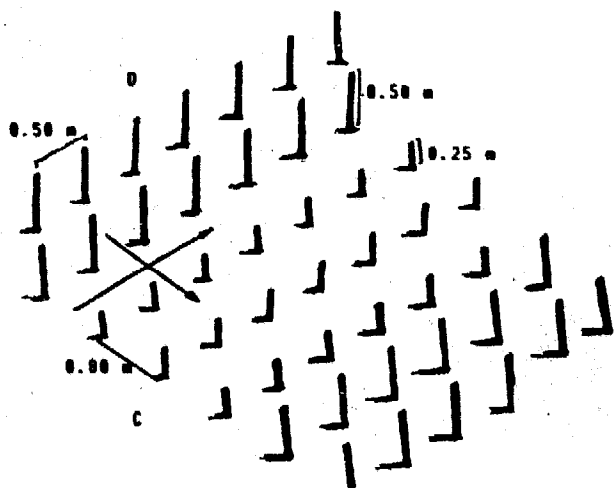

Figure 7.
Maquette apprentissage au sarclage et buttage

nés dans la Figure 1. Les animaux doivent avoir entre 3 et 4 ans et être en bonne santé. La race *méré* étant dominante dans la zone, le dressage peut se faire avec un *joug de garrot* du fait de la présence de bosse; mais le guidage est fait par l'arrière, contrairement aux pratiques existantes.

A cause de graves problèmes de trypanosomiase dans certaines zones, des animaux de race *N'Dama*, qui n'ont pas de bosses, ont été réintroduits; cela a amené les techniciens de la DRSPR à introduire en même temps le joug de tête. Pour le choix des animaux *N'Dama*, provenant de l'Opération *N'Dama* de Yanfolila (l'ONDY, à 280 km à l'ouest de Sikasso), il a fallu tenir compte de leur cornage bien implanté, symétrique et solide.

Le joug de tête exige la confection de jougs bien taillés, dont la largeur correspond aux distances recommandées entre les lignes de culture. Ainsi, en zone Mali-Sud, où les principales cultures sont semées à 0,80 m d'interligne, le paysan doit avoir un joug d'une largeur de 0,80 m pour le labour et le semis, et de 1,60 m pour le sarclo-binage et le buttage. Les paysans apprennent à coudre des bonnets à partir des sacs de jute, à attacher le joug aux

cornes avec des cordes de fabrication locale, et à fixer les deux cordes de guidage (voir Fig. 4).

Apprentissage évolutif

Il est très important de suivre les différents types de dressage indiqués. L'application rigoureuse de la méthode vise à transformer les rapports brusques et craintifs des paysans en une attitude de rapprochement où l'homme se fait obéir de façon stricte à la voix et aux gestes sans brutaliser l'animal. Le guidage par l'arrière, à l'aide d'une corde placée autour de l'oreille interne, représente l'avantage principal de cette méthode par rapport à la pratique paysanne courante consistant à tirer l'animal par le nez. Cela aboutit à une véritable maîtrise de l'attelage, tandis que le nombre d'actifs nécessaires peut être réduit à deux, voire un seul (thème: 1 homme, 1 attelage).

Les maquettes (Fig. 5, 6 et 7) permettent de simuler les champs de cultures et représentent les outils indispensables pour un bon dressage. Leur confection, à l'aide de bois local est d'une extrême simplicité.

Matériel agricole

L'équipement en matériel agricole des paysans qui passent en culture attelée peut se faire en deux phases. La chaîne de base, composée d'une charrue et d'un multicultureur, peut être complétée plus tard par une charrette, un semoir et éventuellement une herse, ou un motoculteur plus performant comme l'*Ariana*; cet équipement est actuellement testé chez 10 paysans, (voir Tableau 3.1).

Le multicultureur *Ciwara*, presque identique à la *Houe Sine* du Sénégal est un matériel polyvalent sur lequel peuvent être fixés des dents (pour un travail de sol léger) ou un corps butteur. Un corps de charrue est également livré, ce qui, normalement, devrait rendre inutile l'achat d'une charrue complète. Malheureusement le multicultureur, avec son corps de charrue, pèse 48 kg et rares sont les paysans qui s'en servent. Beaucoup de paysans abandon-

nent le corps de charrue après l'achat et d'autres l'amènent chez le forgeron pour confectionner une charrue complète.

Suite aux recommandations de la DRSPR, la version standard livrée par le CMDT ne comprend désormais plus le corps de charrue. Il en résulte une économie d'environ 10 000 F. CFA pour le paysan. Dans le cadre du crédit "premier équipement" CMDT/BNDA, le paysan doit choisir entre la charrue et le multicultureur. L'expérience montre que le multicultureur est prioritaire en vue d'assurer le perfectionnement du dressage en première année.

Jusqu'ici le paysan connaît mal l'intérêt du travail aux dents; en effet, il voit d'abord dans la culture attelée la possibilité de pouvoir labourer. C'est pourquoi, même si la charrue n'est pas incluse au crédit, le paysan fera tout pour l'acquérir. En dernière semaine de stage, donc toujours en saison sèche, les boeufs doivent apprendre à tirer le matériel agricole. Pour ce faire, la seule activité possible est le "grattage à sec" aux pics fouilleurs (étançons rigides, dents pointues). Cette technique culturale, que d'autres appellent "houage", a été introduite par la DRSPR dans le cadre du dressage depuis 1984. Outre le perfectionnement des boeufs après la fin du stage, le grattage représente un travail du sol bénéfique, car il améliore l'infiltration de l'eau des premières pluies et facilite le labour.

Dans les années qui suivent le paysan devra compléter son équipement; l'acquisition d'une charrette sera prioritaire. La DRSPR, en collaboration avec la Division du Machinisme Agricole (DMA) a développé plusieurs prototypes de charrettes bovines, actuellement testée chez les paysans; jusqu'ici, seule la charrette asine a été vulgarisée dans la zone.

Ayant observé la qualité médiocre du labour de la charrue T.M., la DRSPR a introduit la charrue "Rumtstad-Sandy" (25 cm, 43 kg) en 1984. Suite aux observations des paysans, cette charrue a été modifiée, pour aboutir à la Sandy

III (20 cm, 32 kgs) qui a été testée en 1986 et dont les résultats sont très satisfaisants.

Résultats obtenus

Il est difficile de donner des résultats détaillés de l'action "dressage amélioré" dans le cadre succinct de ce document. En ce qui concerne les villages de recherche Yaban Djirigorola, l'action a fait l'objet d'un suivi pendant trois campagnes successives. Les performances des boeufs en première année de dressage sont nettement supérieures en 1984 et en 1985 par rapport à 1983 (Tableau 3.2). Les 5 paires de boeufs suivies en 1983 avaient été dressées par les paysans de façon traditionnelle, alors que les 6 paires de 1984 et les 14 paires de 1985 avaient été dressées lors des stages de la DRSPR. Bien qu'encore insuffisante, il est possible de remarquer la progression des différents travaux réalisés avec le motoculteur: grattage, sarclo-binage et buttage.

Prévulgarisation

Au début l'organisme de vulgarisation de la zone, la CMDT, estimait que le dressage ne constituait pas un problème, malgré les difficultés rencontrées avec le crédit "premier équipement". Les résultats probants obtenus à Yaban et Djirigorola en 1984, ont suscité l'intérêt des responsables de la CMDT, et dès l'année 1985, il a été demandé à la DRSPR de former des agents d'encadrement de la CMDT. Ces derniers participaient d'abord à un stage complet de dressage, organisé par la recherche au niveau d'un de ses villages pour appliquer ces méthodes; ensuite ils conduisent eux-mêmes des stages dans d'autres villages, avec l'appui de la DRSPR (Tableau 3.3).

En 1986, la CMDT et la DRSPR ont intégré le dressage comme élément essentiel d'une action de prévulgarisation, menée conjointement avec les deux organismes dans les villages démunis en équipements et à faible niveau de production. Dans ce cadre 10 stages de dressage ont été organisés (zone de Koutiala et Sikasso) et 13 paires de boeufs ont été dressées

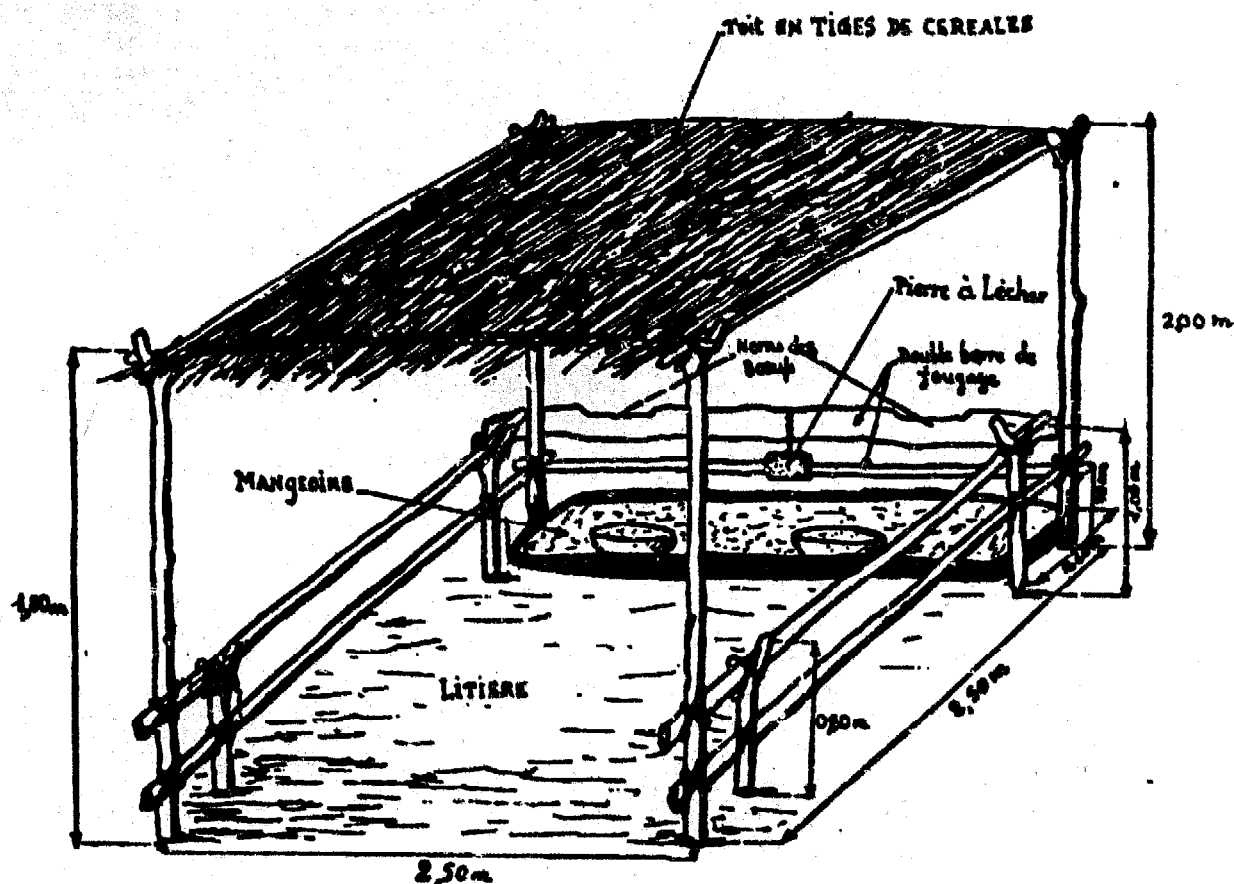

Figure 3. Hangar

suivant la méthode améliorée. Les premiers résultats indiquent qu'environ 50% des paysans retournent à la méthode traditionnelle de conduite d'attelage (guidage par le nez).

mieux de garder le joug de garrot (avec des boeufs), et de mettre tout l'accent sur le guidage par l'arrière.

Discussion

Le dressage amélioré a été introduit par la DRSPR dans une zone infestée par la trypanosomiase, parallèlement à la réintroduction de boeufs de race N'Dama pure. Ce changement complet dans la conduite de la culture attelée a permis de redynamiser l'agriculture dans les villages considérés comme retardataires. Si pour les boeufs de race N'Dama le joug de tête s'impose, avec des boeufs Méré le joug de garrot, auquel les paysans sont plus habitués, peut convenir également; l'essentiel dans ce cas est de faire le guidage par l'arrière. Compte tenu du taux élevé de retour à la méthode traditionnelle (50%), on se demande s'il ne serait pas

Habitat des boeufs de trait

Principes de base

Le problème de l'habitat s'est posé quand il s'est agi d'aborder le conditionnement des boeufs de labour. Le conditionnement est basé sur une alimentation complémentaire pendant 90 à 120 jours avant les premières pluies. Il se fait, notamment, à partir des fanes de niébé produites au niveau de l'exploitation. Aussi est-il nécessaire de disposer d'un abri pour alimenter séparément les boeufs d'attelage du reste du troupeau.

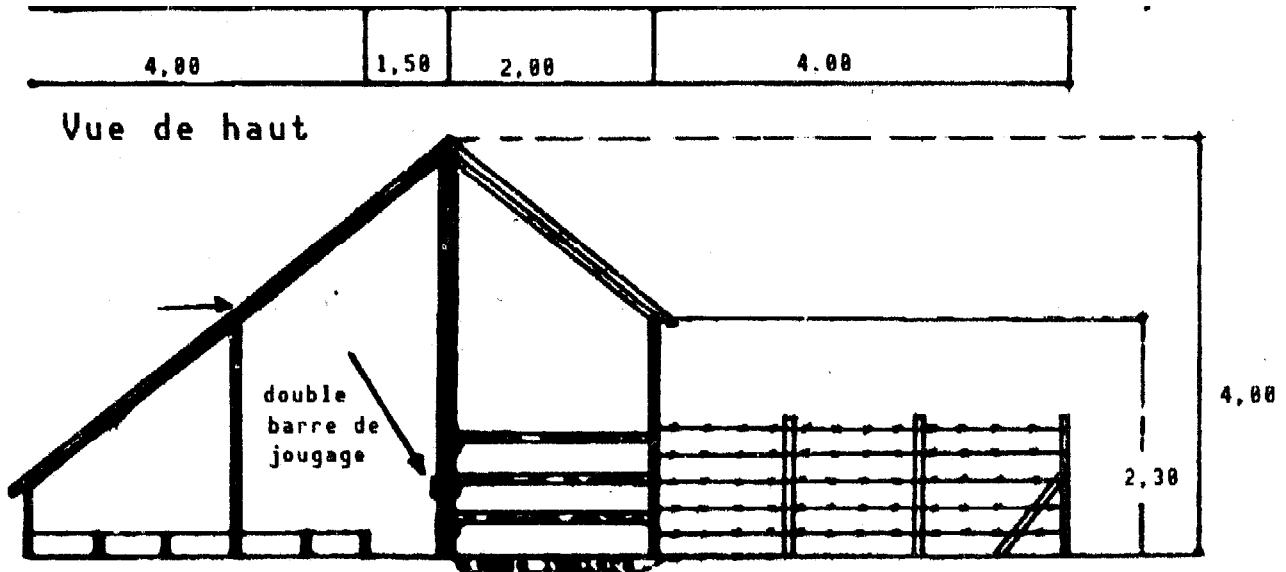

Figure 8. Etable pour une paire de boeufs avec fosse fumière

- protéger le fourrage du soleil et de la pluie;
- faciliter l'affouragement des boeufs;
- permettre la production d'un fumier de qualité;
- faciliter la contention et la manipulation des animaux.

Ce modèle est actuellement en pré vulgarisation chez les paysans bénéficiaires du crédit "premier-équipement".

Aspects techniques et économiques

Pour le modèle de base destiné à loger une paire de boeufs, une surface de 6 m² (3 m²/U.B.T.) a été retenue. L'aire de stockage du fourrage en volume (24 m³) est fonction de la hauteur des deux poteaux centraux. Ces poteaux doivent avoir au moins 4 mètres de hauteur; autrement, la pente du toit ne permet pas d'évacuer assez rapidement l'eau des pluies. Le hangar doit être bien orienté par rapport à la direction des vents dominants. Le toit (15m²) en chaume, nécessite un entretien annuel. En outre, le modèle proposé comprend un couloir de sortie, délimité par du fil de fer barbelé qui est remplaçable par du bois.

La construction de ce type de hangar nécessite essentiellement un investissement humain. En fonction du nombre de paires de boeufs, il est possible d'agrandir le hangar en rajoutant des éléments identiques dans le sens de la largeur.

Formation

L'introduction de ce type de hangar nécessite une bonne sensibilisation et une formation des paysans, faute de quoi il est peu probable que ces derniers fournissent l'effort demandé. Dans le cadre du crédit "premier-équipement", le stage de dressage de trois semaines offre une excellente occasion pour expliquer aux participants l'intérêt de bien garder,

d'alimenter et de loger leurs animaux de trait. Il est même envisageable d'inclure la construction d'un hangar parmi les critères d'octroi de crédit.

Lors des séances de formation l'accent peut être mis sur les avantages suivants:

- la production de fumier à partir d'une fosse fumièrre (fosse de stationnement des boeufs, ou compostière).
- les boeufs en stabulation sont dociles, faciles à manipuler et disponibles pour leur utilisation et les différents soins.
- le jouage est facilité
- les tentatives de vol sont amoindris
- le calendrier cultural sera respecté.

Conclusion

La construction d'un hangar nécessite une bonne disponibilité de bois local. Sa durée de vie peut être considérablement augmentée si on utilise efficacement des produits contre les termites. Des alternatives pour une construction plus aisée du toit seront recherchées. La construction demande un investissement humain important.

Bibliographie

- Berthé, A. 1984. Pratique d'élevage et fonctionnement des systèmes de production agricole dans un système agraire villageois : le cas de Gladié en zone Mali-Sud. Sikasso, DRSPR. (F).
- C.M.D.T. 1985. Rapport annuel de la campagne agricole 1984-1985 en zone Cotonnière, annexes, Bamako, C.M.D.T. (F).
- Comité Régional du Développement. 1986. Stratégie régionale de développement de la région de Sikasso. Version préliminaire, Sikasso. (F).
- DRSPR 1983. Comité technique sur les systèmes de production rurale rapport de campagne 1982-1983, Sikasso. (F).
- DRSPR 1984. Rapport de campagne 1983-1984, Sikasso. (F)
- DRSPR 1985. Rapport de campagne 1984-1985, Sikasso. (F)
- DRSPR 1986. Rapport de campagne 1985-1986, Sikasso. (F)

Evaluation rétrospective de la vulgarisation de la culture attelée au sein d'une opération de développement rural: cas de l'Opération Arachide et Cultures Vivrières (OACV)- Mali

par

G. Le Thiec

Centre d'Etude et d'Expérimentation du Machinisme Agricole Tropical (CEEMAT), Antony, France

Résumé

L'introduction de la culture attelée dans l'opération de développement intégré (l'OACV), résulte à la fois d'un choix affirmé dès l'indépendance par le gouvernement malien, et d'une volonté du paysan qui se trouve en condition de réception favorable.

Le service de vulgarisation de l'opération a tout d'abord entrepris la diffusion de thèmes de "productivité" qui sont simples à appliquer et peu coûteux, mais dont la bonne application était jugée comme un préalable indispensable à l'introduction de la culture attelée. Ceci constituait, en plus de l'essouchage d'une surface minimale, la possession d'un attelage et le versement d'un acompte, l'une des conditions de cession de l'équipement.

L'équipement proposé formait une unité indissociable composée d'un multicultureur et d'un semoir; il permettait d'assurer tous les travaux de culture arachidière.

Un crédit à moyen terme de 3 ans était octroyé, sur le matériel uniquement, avec un taux d'intérêt de 6,5%. Des techniciens spécialisés assuraient la formation de l'encadrement et des "paysans-pilotes" dont la réussite conditionne l'extension de la culture attelée. Les services d'accompagnement suivants oeuvraient au sein de l'opération à la réalisation des objectifs: le service Audio-visuel et d'Alphabétisation, le service Zootechnique et le sous-projet Forgeron; l'opération bénéficiait également de services extérieurs: la division du machinisme agricole et son centre d'essais, le service du crédit et de l'équipe-

ment rural, et enfin l'usine de construction de matériel agricole.

En 1981, 8% des exploitants étaient équipés. L'accroissement des superficies de l'exploitant et l'augmentation des rendements sont deux facteurs influençant la réussite de la culture attelée; ils exigent toutefois que tous les moyens soient mis en place et que les techniques et méthodes soient bien au point. En outre, une politique de prix incitatifs, de même qu'une bonne organisation de la commercialisation des excédents de production des paysans peuvent faciliter la diffusion de la culture attelée.

Même si tous les problèmes relatifs au système de culture avec traction animale n'étaient pas entièrement résolus, l'OACV peut déboucher sur une progression régulière de l'équipement; l'essentiel était de raisonner les problèmes dans leur ensemble; une deuxième étape destinée à orienter les paysans vers un système de production plus harmonieux, plus complet et plus équilibré devait être envisagée. Cependant ce développement nécessite du temps; cela constitue une contrainte difficilement réductible.

Présentation générale de l'opération

Genèse

L'opération a été créée en 1967 par le gouvernement malien sous le nom d'Opération Arachide; ses objectifs sont, d'une part, de relancer la production arachidière qui, depuis le début de la décennie, ne cessait de décroître et,

d'autre part, de procurer des devises à l'Etat, par l'exportation du produit.

Cette opération a été financée par le FAC pour une durée de 5 ans. A partir de 1972, la BIRD prenait le relais en élargissant encore ses objectifs vers un développement dit "intégré", avec pour but principal: l'amélioration du niveau de vie des agriculteurs par l'accroissement de leurs productions de céréales et des cultures de rente. Plusieurs sous-projets (routes et pistes rurales, santé humaine, élevage et alphabétisation fonctionnelle) venaient épauler les activités essentielles de l'opération dans tout ce qui touchait au développement de la zone concernée. Cette opération se poursuit depuis sous le nom d'ODIPAC (Office de Développement Intégré de la Production Arachidière et Céréalière), mais sans l'appui d'un financement extérieur.

Situation géographique

L'OACV s'étend de la frontière du Sénégal à celle du Burkina Faso et couvre approximativement la zone comprise entre les isohyètes 600 et 1000 mm (jusqu'à 1200 vers la frontière guinéenne). Les sols sont à dominante sableuse, mais se prennent facilement en masse en période sèche. La zone géographique de l'opération couvre environ 138 000 km² (plus de 1000 km d'Ouest en Est).

Milieu social et humain

Environ 110 000 exploitations d'une superficie moyenne de 1,5 à 2,5 ha ont été recensées dans la zone. La culture de l'arachide y occupe 100 000 ha et celle des cultures vivrières 150 000 ha. La population active y est de 4 à 6 travailleurs par exploitation. Il est bon de souligner ici le "bon sens" du paysan malien, sa relative ouverture au changement ou, tout au moins, sa bonne volonté face à une remise en cause de ses habitudes.

Il est également important de noter aussi que la toute première introduction de la culture attelée est déjà ancienne (1920); mais elle s'est

développée plus facilement au centre du pays (l'Office du Niger) et dans le Sud (zone cotonnière). Malgré tout, les agriculteurs de la région arachidière connaissent la charrue et, pour la plupart, n'ont pas de problème pour dresser et travailler avec des animaux.

Etapes dans la promotion de la culture attelée

Itinéraires techniques vulgarisés par l'OACV

Dès l'accession à l'indépendance le Mali s'est défini une politique agricole basée sur le développement de la culture attelée; cette option n'a jamais été remise en cause depuis et il faut bien reconnaître là une volonté gouvernementale qui a été le point de départ indispensable à la réussite de ce projet.

De 1967 à 1970, l'OACV a mis en place ses structures et a vulgarisé des techniques simples et applicables sans bouleversement des habitudes, car elles ne nécessitaient que peu d'investissements et permettaient, par contre, d'augmenter sensiblement les rendements. Ces techniques ont été appelées "thèmes de productivité". Ces thèmes comprennent:

- l'utilisation de semences sélectionnées
- l'emploi de fongicide-insecticide
- la pratique du semis précoce
- l'utilisation de l'engrais (dose minimale)

Le service de vulgarisation-formation a tout d'abord diffusé ces thèmes et s'est assuré de leur application correcte avant de développer les "thèmes de modernisation" qui, par opposition aux premiers, entraînaient un changement profond des mentalités et des investissements relativement élevés. Il s'agit de:

- l'essouchage de toutes les parcelles avec pour corollaire la sédentarisation
- le travail en culture attelée
- le respect de l'assolement
- l'emploi optimal d'une fumure organique et chimique

- l'aboutissement à l'intégration agriculture-élevage.

Deux des préoccupations principales de la direction de l'opération ont été:

- d'obtenir des autorités un prix d'achat à la production rémunérateur, afin d'intéresser les agriculteurs à cette spéculation.
- de réorganiser la commercialisation avec un paiement direct en espèces, afin de redonner confiance aux producteurs.

Durant les premières années d'existence de l'opération, différents matériels sont testés et adaptés aux conditions locales et aux besoins de la vulgarisation. Ainsi le choix s'est porté sur le multiculteur *Sine*, le semoir *Super-Eco* et la souleuse d'arachide adaptée au multiculteur. Des disques distributeurs pour arachides, sorgho, mil ont été également mis au point afin de mieux répondre aux exigences locales.

Un réseau d'encadrement serré a été mis en place: 1 encadreur pour 5 à 6 villages, soit environ 150 à 200 paysans; le réseau dépendait d'un service de vulgarisation-formation.

Contraintes

Sous cet aspect il faut surtout souligner les délais d'approvisionnement trop longs, à cause de la situation continentale, imposant des commandes 18 mois à l'avance; cette situation a prévalu tout au moins jusqu'à l'avènement, en 1974, de la SMECMA, usine de construction de matériel agricole située à Bamako.

Avant 1974, le service de crédit agricole et d'équipement rural (SCAER) assurait le monopole de l'approvisionnement des intrants: engrais, pesticides et matériels. Du fait des difficultés d'acheminement (transports ferroviaires sursaturés) et des problèmes financiers, les livraisons de matériels se faisaient souvent en cours de campagne agricole, donc trop tard pour la mise en place dans les villages, vu l'état des pistes à cette époque. Cet état de fait a conduit les ODR. et l'OACV, en particulier, à

surévaluer leurs commandes afin de disposer d'un stock en début de campagne et assurer ainsi un service minimum. Evidemment ceci n'a fait qu'accentuer gravement les problèmes financiers de la SCAER jusqu'à la création de l'usine de construction de matériel (SMECMA).

Les zones à climat soudano-guinéen très boisées nécessitaient un très gros effort d'essouchage pour la mise en culture de nouvelles terres. Dans ces mêmes régions, les déplacements étaient rendus difficiles, parfois impossibles, en saison pluvieuse, compromettant ainsi le suivi permanent des paysans équipés.

Les paysans connaissaient la charrue depuis plusieurs années; les quelques paysans qui en possèdent n'en tirent toutefois pas de revenu supplémentaire important sur leurs propres cultures et ceci pour deux raisons:

- la tendance était de labourer un maximum de superficie qu'il ne leur était ensuite pas possible de désherber à temps, d'où une forte diminution des rendements.
- dans l'optique d'un meilleur contrôle des adventices, les paysans labouraient tardivement et semaient avec parfois 3 à 4 semaines de retard après la date optimum entraînant, là aussi, un manque à gagner très important: (1 à 2% par jour de retard).

Stratégie adoptée

Principes généraux

Considérant qu'il est tout aussi ridicule de vulgariser des méthodes sans mettre à la disposition des paysans les moyens de les appliquer, qu'il est néfaste de diffuser ces moyens sans les avoir préparés à les utiliser, la stratégie adoptée tenait compte de l'ensemble des problèmes liés à la traction animale.

L'introduction du système de culture avec traction animale était basée sur le développement

d'un réseau de paysans d'élites, appelés "paysans-pilotes", lesquels se démarquaient de l'ensemble par:

- une plus grande ouverture aux nouveautés;
- la capacité de supporter des investissements relativement lourds;
- une notoriété certaine, leur conférant une influence plus ou moins forte auprès des autres villageois.

Une structure spécialisée dans la culture attelée a été créée au sein de la direction de l'opération; cette section, qui se composait de deux ingénieurs, dont un expatrié, et d'un technicien spécialisé dans chaque secteur de développement, était devenue opérationnelle dès 1970. Cette section avait en charge l'approvisionnement, la gestion des stocks, les problèmes de maintenance et surtout la formation de l'encadrement de base et des paysans-pilotes.

La formation

Le type de formation dispensé est celui dit "en cascade". Les ingénieurs, responsables de la section, forment les techniciens spécialistes, qui forment eux-mêmes les encadreurs de base; ces derniers transmettent les acquis aux paysans. Des séminaires d'une semaine sont tenus à l'intention des techniciens, avant la campagne agricole. Des journées d'apprentissage sont organisées pour l'encadrement de base, au début de chaque période de travaux: préparation du sol, semis, entretien des cultures, etc.

Durant les premières années, les paysans-pilotes sont regroupés pour des mini-stages de deux jours en vue d'un recyclage mais aussi afin de mettre en commun leurs expériences avec les réussites et leurs difficultés. Ces mini-stages sont du plus grand intérêt pour les intéressés mais aussi pour les vulgarisateurs, qui peuvent en tirer des enseignements fort utiles pour améliorer leur efficacité dans la diffusion des thèmes.

Le crédit

Il s'agit d'un crédit à moyen terme de 3 ans uniquement octroyé sur le matériel, avec des annuités payables au moment de la commercialisation. Afin d'alléger au maximum la première échéance, alors que le paysan n'a pas encore tiré profit de son équipement, l'annuité est scindée en 2, une moitié est payable au comptant et l'autre moitié à la commercialisation. Malheureusement il n'est pas institué de crédit sur l'attelage, faute de garanties suffisantes et de suivi sanitaire. Le taux d'intérêt pratiqué était de 6,5%.

Aspects techniques

Les matériels diffusés

La chaîne d'outils de culture est composée des éléments suivants:

- multiculteur Sine avec ses équipements obligatoires: canadien, sarcler et souleveuse;
- multiculteur Sine avec ses équipements en option: pics fouilleurs, corps de charrue.
- semoir monorang à disque distributeur type Super Eco. (Plusieurs distributeurs sont mis au point par l'OACV: disques à 27 ou 30 crans pour arachides selon les variétés et disques à trous pour mil et sorgho.
- charrettes d'une capacité de 500 ou 1000 kg à roues pneumatiques.

Dans la plupart des cas (90%), la traction bovine est utilisée, sauf pour les transports où l'âne domine même pour les charrettes de 1000 kg, dites bovines.

Les conditions de cession du matériel

La chaîne de culture n'est pas remise à l'agriculteur sur simple demande; son attribution est plutôt soumise à certaines conditions. Le paysan doit:

- adopter au préalable les thèmes dits de productivité;

Tableau 1. Mises en place de matériels

Années	Matériels			
	Multiculteurs	Semoirs	Houes asines	Charrettes
l'OACV				
1967/68	16	17		26
1968/69	29			35
1969/70	79			132
1970/71	89	81		156
1971/72	466	213		395
1972/73	694	523		599
1973/74	1098	1136		120
1974/75	905	887		180
1975/76	1208	1169		980
1976/77	940	928		1136
1977/78	1142	1149	70	1564
1978/79	1330	1913	2051	1451
Sous Total	7996	8016	2121	6773
l'ODIPA				
1979/80	842	1016	670	1253
1980/81	711	816	299	846
Totaux	9549	9848	3090	8872

Tableau 2. Parc actuel en service au Mali

Matériels	Années		
	1975/76	1980/81	1983/84
Charrues	106 704	137 846	147 179
Multiculteurs	40 555	62 838	71 216
Semoirs	9707	30 228	41 717
Charrettes	52 204	86 473	98 643
Houes asines	14 058	17 569	18 248
Herses	10 739	13 220	14 028

Source:

Recensement fait par la Division du Machinisme Agricole (D.M.A.)

- essoucher un minimum de 2 ha;
- disposer d'une paire de boeufs dressés;
- verser un acompte égal à 1/6 du montant.

L'opération a offert, pour favoriser le démarrage de l'action "essouchage", une prime de 1500 F.CFA/ha; cette prime se déduisait du montant du prêt pendant les 3 premières années.

Des pioches-haches sont mises à la disposition des demandeurs pour ce travail d'essouchage. Mais très rapidement la prime d'incitation n'a plus eu de raison d'être et il a fallu même exercer un contrôle sévère sur les surfaces essou-

chées afin d'éviter la création de grandes parcelles sans dispositifs de protection des sols.

Le corps de charrue initialement fourni avec les autres équipements du multiculteur a été ôté de la première dotation et proposé seulement en option. En effet, celui-ci est l'élément le plus onéreux des différents outils et, en l'éliminant, on abaissait d'un tiers le coût du multiculteur. En outre, le corps de charrue ne permettait pas aux propriétaires d'effectuer des semis précoces pour les raisons évoquées plus haut; or cette précocité est primordiale pour réussir une culture arachidière en zone soudano-sahélienne. Le corps de charrue était donc proposé en option, en seconde priorité pour la vulgarisation des labours de fin de cycle chez les paysans-pilotes.

La préparation du sol préconisée (simple scarifiage en passages croisés) avait l'avantage d'autoriser des semis précoces puisque cette pré-

paration pouvait se faire à sec, permettant une meilleure infiltration des premières pluies. Dans le cas de terres compactes, l'équipement "pics fouilleurs" (étançons rigides et socs étroits) était aussi proposé, mais en option.

Nous avons également insisté particulièrement auprès des agriculteurs pour associer systématiquement le semoir au multiculteur. En effet, en culture arachidière, le semoir apportait une solution idéale au problème de vulgarisation: le respect de la densité optimum. Cette densité était approximativement le double de celle pratiquée traditionnellement; les paysans hésiti-

taient à "dépenser trop de semences" et ce thème était donc très difficile à faire admettre en culture manuelle. La mise au point de disques appropriés à chaque variété a permis de semer à bonne densité et, dans certains cas, de doubler les rendements. En semis de céréales, le semoir ne permet pas un réel gain de temps, mais le fait de semer en lignes facilite le sarclage attelé; c'est sur cette opération culturale qu'il faut reporter le bénéfice du semis au semoir. Un autre avantage tiré du semis mécanique, et observé par les paysans eux-mêmes, est une meilleure dissimulation des graines aux attaques des oiseaux qui, dans le cas de semis manuels, picorent à l'emplacement du coup de talon et déterrent les semences à coup sûr; la longue trace laissée par la roue plumbeuse, par contre, les désoriente.

L'équipement de sarclage, composé de trois étançons souples de type canadien avec socs coeurs et 1/2 coeurs, a donné entière satisfaction. La forme cintrée de l'étançon de 40 x 8 assure l'accompagnement de la motte de terre et d'herbes dans son effort de retournement, car les paysans attendent toujours que la végétation soit très avancée pour se décider à sarcler; c'est ce matériel qui a donné les meilleurs résultats dans ces conditions.

En préparation du sol avec des socs 45 mm, les étançons se sont montrés également supérieurs aux étançons en carré de 16 mm qui, de plus, semblent être d'une qualité d'acier plus médiocre (effet "ressort" moins marqué). La souleuse d'arachide, qui permet de récolter rapidement avant que le sol ne soit trop dur, réduisant ainsi les restes en terre, constituait un complément indispensable à cet équipement de base.

Les charrettes de 500 ou 1000 kg de charge utile, le plus souvent tractées par des ânes, en attelée de 2 ou 3, ont permis à bon nombre de paysans d'accéder aussi à la culture attelée et leur procurent, des revenus importants grâce à la location de leur attelage ou l'exécution de transports pour des tiers; ces revenus pouvaient leur permettre d'acquérir le matériel de

travail du sol et la paire de boeufs convoités. Les charrettes sont de type à roues pneumatiques de dimensions courantes, fusées coniques et roulements à billes à rattrapage de jeu; le plateau de la charrette est toujours fait par le forgeron du village.

Une petite houe à traction asine a été vulgarisée dans le but d'élargir les possibilités d'accès à la culture attelée à un plus grand nombre de paysans, notamment à la suite des années de sécheresse où les prix des attelages devenaient, pour la plupart, inabornables; l'accent a d'abord été mis sur la houe occidentale puis sur la houe SMECMA qui, associée au semoir, entraînait une augmentation sensible de la productivité de l'exploitant tout en n'exigeant qu'un investissement minimal, surtout au niveau de l'attelage. Cette houe a obtenu très rapidement un très gros succès: plus de 2000 unités ont été placées dès la 2^{ème} année.

Services opérationnels d'appui

Service de l'audio-visuel et de l'alphabétisation

Ce service a apporté son soutien à la vulgarisation de la culture attelée de trois manières:

- la diffusion d'émissions radiophoniques quotidiennes, basées sur des interviews de paysans-pilotes
- l'organisation de tournées de ciné-bus dans les villages avec des projections de films sur la culture arachidière en traction animale et sur d'autres thèmes techniques.
- la publication d'articles et de fiches techniques d'utilisation du matériel dans un périodique édité en langues vernaculaires dans le cadre de l'alphabétisation fonctionnelle.

Service zootechnique

Ce service a été installé tardivement au sein de l'opération, par manque de financement; il n'a pu apporter son concours que vers les années 1977-1978. Il a aussitôt entrepris des actions

de vulgarisation sur l'embouche des animaux à la réforme, de formation des agriculteurs à un meilleur affouragement et de pratique des soins élémentaires à donner aux animaux. Ce service a également organisé la distribution de compléments (graines de coton, mélasse et composé minéral).

Sous-projet "artisans"

Un réseau de 150 forgerons de village a été équipé en outillage de forge moderne et a été formé à de nouvelles techniques de fabrication et de réparation. Une enquête exhaustive a permis le recensement de l'ensemble des personnes qui exercent la profession; les meilleurs d'entre eux ont été sélectionnés en fonction des critères suivants:

- âge;
- présence d'un jeune à la forge (fils ou apprenti);
- notoriété dans le village;
- construction d'un nouvel atelier.

L'équipement était remis en 3 étapes correspondant à 3 niveaux de technicité. Des stages de formation menés par des instructeurs rassemblaient les forgerons chez l'un d'entre eux, donc dans les conditions réelles de travail quotidien, et étaient programmés sur 2 fois 10 jours. Cette formation, évidemment incomplète, était poursuivie par les instructeurs tout au long de l'année par des visites systématiques. Après 5 années de cette action, le réseau d'artisans fabriquait la totalité des pièces détachées nécessaires et déchargeait ainsi l'opération d'une tâche lourde et difficile.

Il convient de mentionner également le service de Crédit Agricole en tant que service d'appui, car en assurant le recouvrement des échéances par ses propres agents, il permettait ainsi aux vulgarisateurs de mieux jouer leur rôle de conseiller auprès des paysans.

Services d'appui extérieur à l'OACV

L'OACV était en relation permanente avec la division du machinisme agricole qui dépend du Ministère de l'Agriculture et est rattachée au service du génie rural. Les techniciens de cette division ont toujours été associés aux tests et mises au point faits sur le terrain et ont également procédé à des essais du matériel à vulgariser, notamment les derniers introduits pour le compte de l'opération (houe asine).

Le Service de Crédit et d'Équipement Rural (SCAER), de par ses fonctions d'octroi de crédit agricole avait naturellement des relations privilégiées avec les ODRs. Du fait des difficultés financières, des lourdeurs de gestion et des problèmes d'acheminement des intrants ces relations ont été parfois quelque peu tendues mais, bon an mal an, ce service a toujours répondu à toutes les sollicitations des opérations dans la mesure de ses moyens.

L'usine de construction de matériel agricole (SMECMA) a, dès sa première année de mise en service, apporté une plus grande souplesse dans la gestion des approvisionnements des ODRs en matériels. Les contacts directs entre les techniciens des opérations agissant au nom des utilisateurs de matériels, les spécialistes de la DMA et le constructeur permettaient d'apporter rapidement des modifications et des améliorations sur les divers matériels. Ce sont là trois appuis extérieurs, qui de toute évidence, doivent être associés à la réussite de l'implantation de la culture attelée au Mali.

Evaluation de la vulgarisation

Les acquis

En 1981, 8% des exploitations étaient mécanisées. Considérant le tableau de mise en place des matériels, il est possible d'admettre que la réussite de l'introduction de la culture attelée dans la zone arachidière est la conséquence des éléments suivants:

Augmentation des superficies

Elle se situe, en moyenne, entre 1,5 ha et 5,5 ha pour toutes les exploitations en traction animale, à l'exception de celles opérant dans des régions proches des centres urbains. En gros, l'adoption de la traction animale a permis de multiplier par quatre la surface de l'exploitation. Une superficie de 14 ha (7 en arachide + 7 en céréales) était fréquente chez les paysans-pilotes.

Augmentation des rendements

Une enquête de la cellule d'évaluation a chiffré les augmentations de rendements à 40% pour les céréales et 8% pour l'arachide; elles sont dues à trois techniques:

- préparation du sol plus rapide et semis plus précoce;
- meilleur contrôle de la densité pour l'arachide;
- sarclages plus fréquents et effectués en temps opportun sur toutes les cultures.

Ces trois techniques ont donné des résultats particulièrement remarquables durant les années de sécheresse. Une productivité et un rendement plus élevés sont donc deux facteurs à la base de l'adoption et de l'utilisation réussie de la traction animale.

On notera également une bonne rentabilisation de l'équipement et des attelages par l'exécution des travaux à façons, notamment en matière de transport et plus particulièrement pour le regroupement des récoltes au point d'achat pendant la campagne de commercialisation.

Mais ce développement de la culture attelée n'a été possible que grâce à une politique incitative de prix au producteur. Le relèvement des prix intervenait régulièrement, pas toujours avec une marge suffisamment importante, mais il opérait malgré tout un réajustement par rapport au coût de la vie et encourageait les paysans à poursuivre leurs investissements.

La bonne prestation des services de commercialisation et de crédit a également contribué à la réussite du programme car elle conditionne l'état d'esprit et la confiance des agriculteurs dans tout le système d'encadrement chargé de leur développement.

Les difficultés

L'extension des superficies et l'augmentation des rendements ont, dans une certaine manière, déplacé un problème de manque de main-d'oeuvre. Alors qu'avant l'adoption de la culture attelée le goulot d'étranglement dans le calendrier cultural se situait à la période des sarclages, avec le système de culture à traction animale il y a un surcroît de travail au moment et après la récolte. Une enquête réalisée à l'OACV sur les temps de travaux des opérations de traitement de récolte a donné les résultats suivants:

Battage-vannage de l'arachide:

220 heures/tonne;

Battage-vannage du sorgho/mil:

123 heures/tonne.

Ainsi donc dans une exploitation moyenne de 6 ha de superficie (3 ha d'arachides + 3 ha de céréales) sur lesquels sont obtenus des rendements de 2 t/ha sur l'arachide et de 1,5 t/ha sur le sorgho, les temps nécessaires aux travaux d'après récolte sont de:

- 1 320 heures/homme pour l'arachide;
- 553,5 heures/homme pour les céréales.

Cela correspond à un total de 1873,5 heures, soit 235 homme/jours. Le nombre d'actifs par exploitation étant de 5, il faudra 47 jours de travail à cette exploitation pour mener à bien ces travaux.

Du fait de la sécheresse, nous avons enregistré une élévation brusque du coût des animaux, limitant l'accession à la culture attelée aux plus aisés. Afin de contourner cette situation, l'opération s'est orientée vers l'équipement à traction asine, en proposant une houe légère qui par ses diverses possibilités de changements d'outils était en fait un vrai petit multicultureur.

Si l'essouchage exigé pour l'obtention d'une chaîne de culture attelée n'a pas posé de problèmes tant que les paysans-pilotes restaient peu nombreux, il n'en a pas été de même par la suite. Deux tendances sont alors apparues:

- parmi les paysans convaincus de la nécessité de l'essouchage, certains ont travaillé sur des parcelles atteignant jusqu'à 20 ha d'un seul tenant. Une action de vulgarisation particulière a dû être menée afin de limiter les parcelles et engager la lutte anti-érosive.
- d'autres, au contraire, moins courageux, ont réussi à se procurer du matériel sans avoir essouché soit en trompant la vigilance de l'encadrement, soit parfois en toute complicité avec celui-ci. Des casses importantes ont alors été signalées, surtout au niveau des équipements canadiens, le sarcléur et le semoir.

Dans les zones proches des centres urbains, les terres cultivables étant toutes appropriées, nombre d'agriculteurs n'ont pu étendre leur superficie et leur capacité de remboursement s'en est trouvée fragilisée, car l'augmentation des rendements doit alors assurer la rentabilisation de l'équipement, ce qui n'est pas toujours évident.

L'affouragement des animaux

Ce problème s'est toujours posé et de façon d'autant plus cruciale que l'on s'approche des zones sahéliennes. Des réserves fourragères de résidus de récolte, des fanes d'arachide principalement, étaient constituées, mais toujours en trop faible quantité. La constitution de réserves fourragères suffisantes nécessite de la part de l'agriculteur une très bonne organisation du travail; les travaux supplémentaires venant en surcroît à la période déjà bien chargée de la récolte.

La technique de fauchage de graminées en début de floraison a été testée et vulgarisée mais sans grand succès. La culture de niébé en association avec le sorgho a été mieux acceptée.

Mais on se heurte là à un problème de fond plus complexe qu'il n'y paraît, car on débouche sur un ensemble de difficultés liées à l'association agriculture-élevage; cela correspond à un second bouleversement des traditions après le passage à la culture attelée. On ne peut donc traiter ce problème seul. Il faut, au contraire, considérer ce deuxième niveau de culture avec traction animale en adoptant une stratégie globale, bien dégager les techniques recommandées en matière de conservation des sols, d'assolements de cultures, de fumure organique et de cultures fourragères, pour l'essentiel.

Conclusion

L'introduction et le développement de la culture attelée à l'OACV ont pu se faire de façon harmonieuse et irréversible grâce à plusieurs facteurs:

- le besoin et l'attente ressentis par les paysans d'augmenter leur capacité de production et donc leur disposition bienveillante à l'égard des propositions de matériels et de techniques nouvelles qui leur étaient faites;
- le soutien des responsables administratifs et techniques qui ont su mener une politique de développement rural dynamique et cohérente;
- les services d'accompagnement "assistant" la vulgarisation ont permis de traiter tous les aspects de la traction animale;
- un matériel et des techniques simples, mais éprouvés, testés et mis au point dans le contexte réel et donc bien adaptés aux conditions locales.
- une volonté gouvernementale de développement agricole définie clairement et faisant du système de culture à traction animale, un moyen prioritaire pour atteindre les objectifs de développement; cette volonté s'est traduite par la création des services nécessaires et adéquats: Division du Machinisme Agricole et Centre d'Essais, Service du Crédit Agricole et d'Equipe-

ment Rural, Usine de Construction de Matériels Agricoles.

Ainsi, en 1981, 8% des exploitations étaient équipées. C'est peu et beaucoup à la fois: c'est peu si l'on considère les 75 ou 80% qui restent à équiper (on peut estimer à 20% les intouchables!); c'est beaucoup au regard de la progression réalisée durant la décennie 1970 qui permet d'espérer un développement continu et qui devrait avoisiner les 30% d'exploitations mécanisées à l'horizon de 1990.

Mais en même temps qu'un plus grand nombre d'agriculteurs accèdent à la culture attelée, il ne faudrait pas oublier de proposer à tous ceux qui maîtrisent la première étape la possibilité de franchir les niveaux suivants, en les orientant vers un système de production plus équilibré incluant la résolution de facteurs influant sur le long terme tels que: la fumure organique, l'assolement, les cultures fourragères et donc la sédentarisation.

On doit considérer, dans cette rétrospective, que le facteur temps, nécessaire à l'introduction d'une nouvelle technique dans le milieu rural (pourtant favorable a priori), est très important et, d'une certaine manière, difficilement compressible. En effet, même lorsque tous les moyens sont en place, les méthodes bien au point, il faut malgré tout laisser au paysan le temps:

- d'observer, tout d'abord, les premiers d'entre eux qui adoptent la traction animale et d'avoir leur opinion;

- d'assimiler les nouveautés proposées;
- et finalement de maîtriser les techniques.

Ainsi, de ce point de vue, on peut estimer que les résultats obtenus en une décennie par l'OACV, sont une performance remarquable surtout en période de sécheresse.

On a pu remarquer que de nombreux projets s'imposent des objectifs trop optimistes sans tenir compte de ce facteur temps. Ces objectifs, non réalisés dans le temps prévu, parce qu'irréalisables, sont considérés comme des échecs ou des demi-échecs. Les organismes de financement, tenus de réaliser des objectifs de rentabilité économiques positifs à moyen terme oublient bien souvent ce *facteur temps* en exigeant des plans programmes trop ambitieux à court et moyen terme.

Sigles et abréviations utilisées

O.A.C.V.	Opération Arachide et Cultures Vivrières
O.D.I.P.A.C.	Office de Développement Intégré de la Production Arachidière et Céréalière.
D.M.A.	Division du Machinisme Agricole (rattachée à la Direction du Génie Rural).
S.C.A.E.R.	Service de Crédit Agricole et d'Équipement Rural.
F.A.C.	Fonds d'Aide et de Coopération (Ministère Français de la Coopération).
B.I.R.D.	Banque Internationale pour la Recherche et le Développement.
S.M.E.C.M.A.	Société Malienne d'Équipement et de Construction de Matériels Agricoles.

Title photograph (opposite)
Work oxen near the border between Nigeria and Niger
(Photo: Paul Starkey)

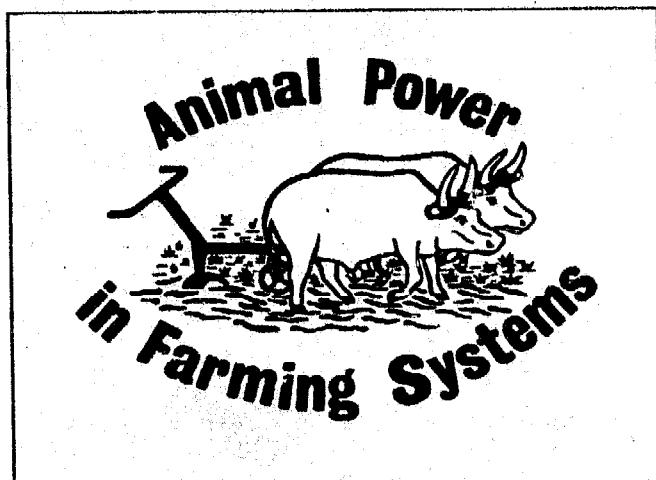

Animal Power in Nigeria

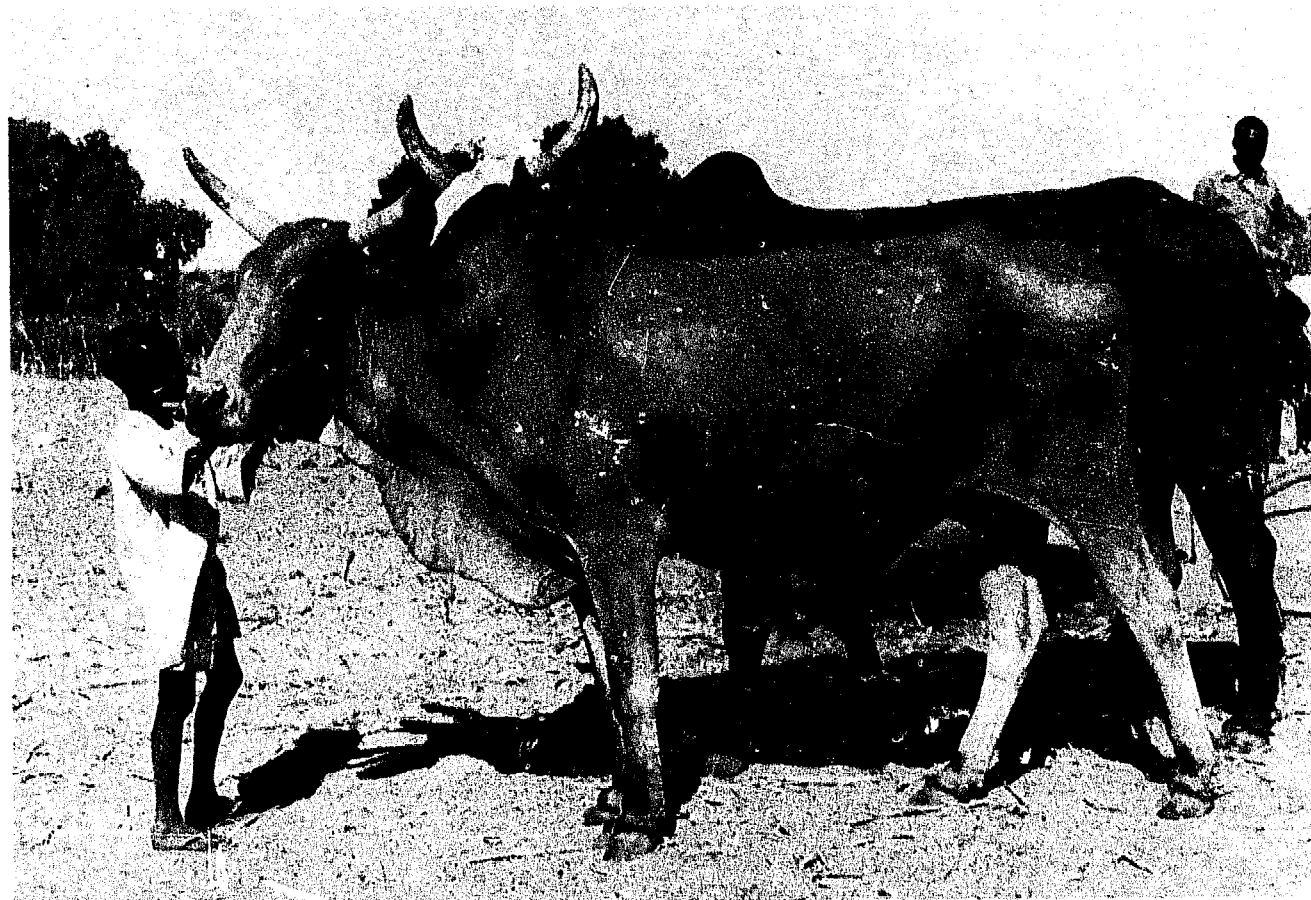

Economic implications of animal power at the small-scale level in the savannah zone of northern Nigeria: a linear programming simulation of farmer circumstances

by

D.O.A. Phillip, G.O.I. Abalu and S.A. Ingawa

Institute for Agricultural Research, Ahmadu Bello University, Zaria, Nigeria

Abstract

Aspects of the farming systems in northern Nigeria are briefly described. Farming is undertaken largely by small-scale operators. Most labour, management and capital come from household sources. Only a fraction of total production is marketed by the household, and despite agronomic and extension efforts to the contrary, farmers have persisted with mixed cropping. Labour is the major constraint particularly during the June-August period. Animal traction is an option for removing the labour constraint, yet only 5.5% of the area is cropped using animals, while 86% is cultivated by hand hoe. Data suggests area increases would be possible using animal power for cultivation.

Working with sole crop enterprises and a set of representative farmer situations, linear programming (LP) techniques are used to determine the optimal enterprise combination if animal traction were introduced on a hiring-in or borrowing basis. The LP model was varied over farm sizes, hourly costs of hiring oxen, hourly costs of hiring May-August labour, and different levels of non-cash oxen borrowing. The LP model included six sole crop enterprises and limits were placed on farm size and labour availability.

In the model only maize and groundnut appeared in the optimal solutions, although Guinea corn, millet, cowpea and cotton were options. Increase in farm size enhanced gross farm income but when the farm size was doubled from 2 ha to 4 ha, only 2.9 ha could be used because of the limits imposed by May-August hired la-

bour. Production and income possibilities shrank as the cost of hiring oxen increased. January-April and May-August continued to represent labour surplus and labour shortage periods respectively. Even when oxen were readily available at low cost, labour constraints dominated the model. This model suggests that oxen cannot fully replace manual labour at critical times.

There is a need to refine the model to investigate animal traction in mixed cropping systems, and incorporate credit constraints, purchasing oxen and implements, and oxen maintenance requirements.

Introduction

The farming system in northern Nigeria comprises crop, livestock and off-farm subsystems, each with a complex interaction of interdependent component parts. Quite often each of the sub-systems is location-specific in terms of sets of elements that come to play in the achievement of the objectives of the farmer. As a consequence the farming system may be seen as consisting of a cropping system involving production of one or more commodities, a livestock subsystem involving the production and rearing of one or more species of livestock, and an off-farm subsystem involving activities carried out outside the farm.

Farming systems assume their identity from the operating cropping and livestock subsystems. However, in northern Nigeria livestock

appears to be a minor component of the farming system. The cropping subsystem is dominant as the main source of livelihood of the peasants in the area whose main economic activities involve the growing of staples and cash crops. The livestock subsystem performs the secondary role of occasionally providing farm power and transport and is a ready source of liquid assets which the family can dispose of for cash during times of need.

Rainfed agriculture is the predominant form of crop husbandry in the area. Most farmers are smallholders with total farm sizes averaging about 2.5 hectares. The zone has a growing season of 160-200 days and this makes possible the production of a wide variety of crops with many of them being produced in mixtures. Farmers in the area prefer to grow their crops in mixtures because a mixture of two or more crops which grow most rapidly at different times during the growing season almost always produces more total output than the same area of sole crops, whatever the level of management (Abalu and Etuk, 1986).

Most cropping operations are done manually and there is a peak labour demand period between June and August when land preparation and weeding are taking place. Consequently, the amount of land that can be brought into cultivation each year per farming household is determined largely by the availability of family and/or hired labour during the peak labour demand period to handle land preparation and weeding. The present system of cultivation relies heavily on traditional hand tools such as hoes and cutlasses.

Most studies in the zone have identified labour as the major constraint within existing levels of technology. There is also well-documented evidence about the seasonality of labour and the serious bottlenecks it causes during the June-August period (Norman, 1972).

Farmers have responded to the labour bottlenecks in land preparation and weeding activities in a number of ways including: working

more days and longer hours per day on farm activities; reducing time spent on on-farm activities; using more labour of women and children; when possible hiring labour; growing crops in mixtures; and planting cash crops after food crops.

Most of these strategies have serious limitations in northern Nigeria. Land preparation and weeding are the most tedious of farming activities and there is a limit to the amount of land a farmer can cultivate. Because the area is predominantly Moslem and seclusion of women is practised, the availability of women for farm work is greatly reduced. The compulsory, Universal and Free Primary Education system in operation in Nigeria effectively removes the availability of children from farm work. Hiring labour requires cash but the period of June-August when hired labour is needed most coincides with the period when farmers' cash reserves are at their lowest ebb.

However, these strategies do provide useful clues as to how farmers in the area might maximize yields per unit area or increase the area cultivated by relaxing the labour bottleneck during the June-August period.

Tractor use as a means of ensuring that the two key agricultural operations are appropriately and timely carried out has considerable limitations as of now. The tractors are often ill-suited to the soil and environmental conditions prevailing in the area, they break down frequently, and spare parts for their repairs are hard to come by. In short, there are still a number of technical problems with tractor use in the area to be sorted out and even if these problems were successfully addressed, the economics of tractor use are very questionable in the area (Ukpabio, 1978). The high failure rates of the various Tractor Hiring Units that were set up in the area provides corroborating evidence.

In addition, the existing literature on technical change in the agricultural sectors of developing countries would appear to suggest that

even if tractorization could be labour-saving, it would most likely not be accompanied by much impact on yield in Africa (Binswanger, 1984). It is in this regard that animal traction suggests itself as a potentially useful and appropriate means of improving upon the efficiency of the hoe system in northern Nigeria.

Animal traction provides a well-tested and proven option for removing the farm constraints of non-availability and/or timelines of labour in the area. As a substitute for hoe cultivation it has the potential of permitting the farmer to expand his acreage and improve upon his yields. However, despite the fact that it is a farmer-generated and farmer-adapted technology with a successful history of adoption elsewhere, it has not been widely adopted by Nigerian farmers.

In this paper, we examine the potential of animal traction as a means of increasing the efficiency of peasant farming in the savanna ecological zones of Nigeria through timely agricultural operations and we explore the economic implications thereof. Our interest in this regard is based on the hope that intensification of animal traction, and intermediate-level technology will not only ease the labour bottlenecks of the peak work season, but may also pave the way for the enhancement of farm income and living standards of rural households in northern Nigeria.

Improving farming efficiency through animal power

Agricultural production in northern Nigeria is characterized by the following (Norman, 1975, 1972 and Abalu, 1976):

- It is undertaken largely by small-scale operators.
- The bulk of the labour, management and capital resources comes from household sources.
- Given its subsistence needs, only a fraction of total production is marketed by the household.
- Despite agronomic and extension efforts to the contrary, farmers have persisted in growing their crops in mixtures.

The use of animals, particularly oxen, in agriculture is relatively recent in northern Nigeria, dating back to only the mid-1920s. Ox farming was introduced in northern Nigeria through

Table 1. Estimates of area under different cultivation systems

	<i>Cultivation systems</i>		
	hoe	animal power	tractor
Number of farmers (million)	7.5	0.1	0.015
Area cultivated (ha/farmer/year)	1	5	50
Total area cultivated annually (million ha)	7.5	0.5	0.75
Per cent of total area (%)	86.0	5.5	8.5

Source: Dunham (1980)

“mixed farming” for obtaining cash crops such as groundnut and cotton and also for improving soil fertility (Kalkat and Kaul, undated). Animal traction, as an alternative source of farm energy, has been recognized many centuries ago in southeast Asia, the Middle East and Mediterranean countries (FAO, 1972).

Several benefits, actual and potential, have been identified with the use of animal power at the farm level in an environment such as that prevailing in northern Nigeria. First, while the area under animal cultivation is only about 5.5% of total cultivated area, recent evidence (Table 1) suggests that a man and his family with a pair of workbulls can handle 4 to 5 times the area of a hand-cultivated farm. This result had earlier been independently obtained by Haswell (1979). Second, all the known

Table 2.
Total operational hours per hectare for growing different crops under trial

Crops	Oxen	Manual
Guinea corn	58	225
Groundnut	32	1200
Maize	42	285
Millet	44	203
Cotton	46	565
Cowpea	77	210

Source: IAR (1974)

operations that are involved in each crop production cycle (seedbed preparation, ridging, fertilization, planting, irrigation, weeding, crop protection, harvesting, threshing and carting) are generally possible with animal-drawn equipment (Kalkat and Kaul). Third, not only is animal traction reasonably affordable, it is made attractive by the fact that the household has the option of selling the workbulls for meat, after the bulls are considered to have exhausted their work life. Fourth, a complex, almost symbiotic relationship could develop in the event of an intensive use of animal power. While the workbulls are fed on the grains and greens of the cultivated fields, the bulls contribute in the form of enriching the soil fertility with their wastes, in addition to being used to perform the farm operations for which they were primarily intended. Thus this relationship is akin to the beneficial coexistence known to have developed between pastoral and sedentary people of northern Nigeria (see Van Raay, 1973). Fifth, recent field evidence

Table 3. Measures of the net price row

Activity	Yield (kg/ha)	Price (N/kg)	Labour cost (N/hour)
Guinea corn	1007	0.48	
Groundnut	2006	0.75	
Cotton	752	0.56	
Maize	2237	0.56	
Cowpea	45	1.00	
Labour hiring			
January-April			0.60
May-August			0.85
September-December			0.70

(Table 2) suggests that the total operational hours required for growing one hectare of crop are considerably fewer under animal traction when compared to manual labour. Thus, animal-drawn implements when utilized for farm operations can constitute a potential labour-saving strategy.

On the other hand, the introduction of animal traction is not without its limitations (Barratt *et al.*, 1982). For it to be successfully implemented farmers have to: learn to manage large animals; use new implements and agronomic techniques; intensify land use; change their cropping patterns; and borrow to finance the purchase of the animals and equipment.

Farm plans incorporating animal traction

A considerable amount of research effort has been devoted over the past one-and-half decades to the rationale and modalities of farm level operations among the farming families of northern Nigeria. Studies have already focused on such issues as the economic, social and cultural rationale of mixed cropping (Norman, 1975; Abalu, 1976), and the feasibilities of alternative levels of technology for growing sole crops (Abalu and Etuk, 1986). Linear programming techniques have also been applied to determining the optimal enterprise mixes under indigenous conditions of northern Nigeria (Ogunfowora, 1972).

Linear programming (LP) techniques were applied in this study to determine the optimal enterprise combination for the average northern Nigerian household when animal traction was introduced into a system of sole cropping. While mixed cropping is largely prevalent among farmers of northern Nigeria, non-availability of relevant coefficients with regard to animal traction invariably restricted the scope of our investigations.

The basic LP formulation consisted of six sole crop enterprises: Guinea corn, groundnut, cotton, maize, millet and cowpea. The typical

household was constrained to face the following situation: a maximum farm size of 2 hectares (ha); a maximum of 500 person-hours (hr) of family labour, available during each of the periods January-April, May-August, and September-December; a maximum of 100 person-hours available for hire during each of the above periods; and the household had no oxen team of its own, thus requiring it to hire each additional hour of animal traction utilized. Table 3 shows some of the information used in the construction of the net price row.

The resource levels indicated above, while potential in nature, are not empirically far-fetched. For example, in the Funtua area of Kaduna state, about 75% of all households surveyed possessed less than 4 hectares of cul-

tivable land (Balcet and Candler, 1981). Note also that the monthly labour requirements of the sole crop enterprises have been regrouped into sub-periods of four months each to avoid the so-called work-overlapping problem (Mbonda, 1983). The set of LP simulations obtained, using the basic formulation, largely revolved around certain questions, for which we were seeking answers. For example, what were the effects on the optimal enterprise mix, labour and oxen team requirements and farm income, of varying (a) the farm size, (b) the hourly costs of hiring an oxen team, and (c) the hourly costs of hiring the May-August labour? Furthermore, if the household had access to additional hours of oxen usage, which it did not necessarily pay for in cash, what were the implications for its enterprise mix, labour requirements, ox hiring and gross farm income?

Information on resource levels, resource requirements of each activity and the measures of net prices were obtained, not unexpectedly, from multiple sources: interpersonal communications, published work and unpublished survey data on farm level operations in northern Nigeria.

Discussion

This study has the broad objective of determining the best enterprise mix for the average northern Nigerian household, given the set of conditions assumed to face it. A more specific objective was to assess the feasibility of introducing and intensifying animal traction within a sole cropping system.

Variation in the farm size

Table 4 presents the results of varying the household's farm size over two levels (2 ha; 4 ha). At 2 ha, all the available land was planted to only groundnut and maize. When the farm size was doubled (4 ha), only 2.91 ha was used because of the limits imposed by May-August and September-December hired labour and hired oxen team. Note the require-

Table 4. Effect of varying the farm size

Farm size (ha)	Activities in the plan	Unit	Level	Objective function	
2.0	Groundnut	ha	0.656	N2340	
	Maize	ha	1.344		
	Ox hiring	hr	110		
4.0	Groundnut	ha	0.164		N3149
	Maize	ha	2.746		
	May-August labour hiring	hr	100		
	September-December labour hiring	hr	100		
	Ox hiring	hr	127		

Table 5. Effect of varying the hourly cost of hiring oxen team

Oxen hire cost hr ⁻¹	Activities in the plan	Unit	Level	Objective function
0.0	Groundnut	ha	1.276	N2741
	Maize	ha	0.724	
	Labour hire	hr	100	
	Ox hiring	hr	135	
3.0	Groundnut	ha	0.656	N2340
	Maize	ha	1.344	
	Ox hiring	hr	109	
6.0	Groundnut	ha	0.656	N2010
	Maize	ha	1.344	
	Ox hiring	hr	109	
9.0	Maize	ha	2.0	N1757
	Ox hiring	hr	83	

ment for more oxen team hours as the farm size increased.

Variation in the hire cost of oxen team

In Table 5, we present the results of parameterizing over alternative hourly costs of hiring an oxen team. We included a zero hire cost merely to assess the technical limit, if one exists, to ox hiring, given the conditions assumed to prevail.

The overall pattern emerging from Table 3 is that the production and income possibilities of the household shrank as the hourly costs of hiring an oxen team increased. Furthermore, an approximately well-behaved normative demand relationship was established for ox hiring (see Table 5).

Variation in the hire costs of May-August labour

As indicated earlier, we investigated the likely impact on the optimal plan of varying the hourly costs of hiring the May-August labour. The choice of the May-August labour out of the three labour subgroups was based on the common knowledge that labour is most limiting during the peak work seasons (May-August) in northern Nigeria.

As the cost/hour of hiring the May-August labour was increased from N0.25 to N0.85, the optimal mix of the enterprises changed from 1.28 ha of groundnut and 0.72 ha of maize, to 0.66 ha of groundnut and 1.34 ha of maize. In the process, labour hiring dropped out of the optimal plan at N0.85 h⁻¹, while ox hiring remained in the plan. Also, note the drop in the level of ox hiring at N0.85 h⁻¹ for the May-August labour, perhaps suggesting that ox hiring and labour hiring during the May-August period are likely to be complementary in the performance of certain farm operations.

Variation in available "non-cash" oxen hours

At least three options face a potential user of animal traction in northern Nigeria. The first option, which is still very much constrained by credit availability, is for households to buy and own their oxen team and implements. The second choice, the most common, is to hire the oxen team at mutually agreed cost either per hectare or per hour. The third option is for a household to "borrow" the oxen team and implements from a neighbour who has one. The last arrangement ranges from getting to use the oxen team free of charge (provided the actual owner was not in-need of the team at the time of borrowing), to some prearranged pay-

Table 6. Effect of varying the hourly cost of hiring the May-August labour

Labour hire (N hr ⁻¹)	Activities	Unit	Level	Objective function
0.25	Groundnut	ha	1.276	
	Maize	ha	0.724	
	Labour hire	hr	100	
	Ox hiring	hr	135	N2396
0.50	Groundnut	ha	1.276	
	Maize	ha	0.724	
	Labour hire	hr	100	
	Ox hiring	hr	135	N2371
.85	Groundnut	ha	0.656	
	Maize	ha	1.344	
	Ox hiring	hr	109	N2341

Table 7. Effect of varying the available non-cash oxen hours

Non-cash oxen (hrs)	Activities in the plan	Unit	Level	Objective function
zero	Groundnut	ha	0.656	
	Maize	ha	1.344	
	Ox hiring	hr	109	N2340
50	Groundnut	ha	0.656	
	Maize	ha	1.344	
	Ox hiring	hr	60	N2490
100	Groundnut	ha	0.656	
	Maize	ha	1.344	
	Ox hiring	hr	10	N2640
200	Groundnut	ha	1.276	
	Maize	ha		0.724
	Labour hire			
	May-Aug	hr	100	N2741

ment in kind at a future date. In some variations of this arrangement, the oxen team borrower is obliged to contribute forage and grain towards the feeding of the oxen team. This study assumed the case in which the household acquired additional oxen hours via the third option above. We referred to this as "non-cash" oxen hours to distinguish it from option two, the ox-hiring case.

From Table 7, increasing the level of non-cash oxen hours available to the household not only decreased the level of ox hiring, it enhanced the farm income. At 200 hours of non-cash oxen usage, the May-August hired labour became highly limiting, possibly suggesting that availability of large oxen hours, at paltry or significant costs, does not adequately replace the need to perform some of the farm operations by manual effort.

Finally, note that the 2 ha of land, continuing to be limiting, was fully planted to only groundnut and maize, with a clear switch in the optimal enterprise mix at 200 hours of non-cash oxen usage.

Summary and implications

We have attempted, within the limits imposed by the available data, to determine the implications of introducing and intensifying animal traction in northern Nigeria. Working with sole crop enterprises and a set of fairly representative farmer situations, the basic LP model was parameterized over different farm sizes, hourly costs of hiring oxen team, hourly costs of hiring the May-August labour; and different levels of additional oxen hours acquired by the household, which it did not necessarily pay for in cash. From the alternative sets of the LP simulations, the following patterns of results appeared to have emerged:

- January-April and May-August continued to represent labour surplus and labour shortage periods respectively.

- Increase in the average farm size substantially enhanced the gross farm income. However, land was underutilized, even at 4 ha, because of the limitations imposed by the May-August hired labour, hired oxen team, etc.
- The production and income possibilities of the household shrank as the hourly costs of hiring oxen team increased. Also an approximately well-behaved normative demand relationship emerged for ox hiring.
- As the wage rate for the May-August labour was increased from N0.25 h⁻¹ to N0.85 h⁻¹, the concurrent results were for the May-August labour hiring to drop out of the optimal plan, while ox hiring, though dropped in its entry level, remained in the optimal plan. Also, an increase in the wage rate for the May-August labour resulted in successive, though slight, penalty of the gross value of the plan.
- Increasing the level of "non-cash" oxen hours available to the household not only decreased the level of ox hiring, it enhanced the gross farm income. But the May-August hired labour became limiting.

The last two of the foregoing results appeared to suggest that availability of a large amount of oxen hours, from whatever source, does not fully substitute for the performance of certain farm operations which traditionally call for the employment of manual labour.

Over the range of conditions for which the basic model was simulated, only groundnut and maize alternately or concurrently entered the optimal plans. These results obviously generate an unquiet concern, especially considering that some 70% of all cultivated land goes into food production (Norman, 1972). However, on a more optimistic note, the prevalent cropping pattern in northern Nigeria is one in which crops, especially millet and

Guinea corn, are grown in mixtures (Abalu, 1976). Thus, with millet- and Guinea corn-based crop mixtures constituting 50% or more of all documented enterprises, and with the establishment that gross returns per hectare are higher under mixed cropping (Norman, 1975), there is a need to further investigate the technical and economic feasibilities of introducing and intensifying animal traction with a mixed cropping system. The urgency for such an investigation partly derives from the recurrent entry of the May-August labour hiring activity into the optimal plans, in this study. There is a need to establish the nature of the relationship between the May-August labour and oxen team utilization (are they strict complements, strict substitutes or some combination of these two relationships?).

Finally, we were mindful of the need to construct our basic LP tableau to incorporate such considerations as credit constraints to purchasing an oxen team and implements; and allowing for the oxen team maintenance (feeding, housing, veterinary services, etc.). We believe that these considerations would prove invaluable as relevant coefficients on them become available in the future.

References

Abalu, G.O.I. 1976. A note on crop mixtures under indigenous conditions in Northern Nigeria. *J. Devpt Studies* 12: 2.

Abalu, G.O.I. and Etuk, E.G. 1986. Traditional versus improved groundnut production practices: some further evidence from Northern Nigeria. *Experimental Agriculture* 22: 33-38.

Balcet, J. and Candler, W. 1981. Farm technology adoption in Northern Nigeria. Vol. 1, Preliminary report. (unpublished).

Binswanger, H.P. 1984. Agricultural mechanization: a comparative historical perspective. Staff Working Paper 673, World Bank, Washington DC, USA. 80p. (E).

Barratt, V., Lassiter, G., Wilcock, D., Baker, D. and Crawford, E. 1982. Animal traction in Eastern Upper Volta: a technical, economic and institutional analysis. International Development Paper 4. Department of Agricultural Economics, Michigan State University, East Lansing, Michigan, USA. 118p.

Dunham, R.J. 1980. Tractor and the soil. Seminar paper, I.A.R. Samaru, Zaria.

FAO 1972. The employment of draught animals in agriculture. FAO, Rome, Italy. 249p.

I.A.R. 1974. Report to the board of Governors on the Institute's work in 1973-74, Samaru, Zaria, Nigeria.

Haswell, M. 1979. Economic choice of appropriate technology by peasant farmers. Report of the West African Rural Technology meeting at Yundum, The Gambia, and Dakar, Senegal, May 14-22. Commonwealth Secretariat, London, U.K.

Kalkat, H.S. and Kaul, R.N. (undated). Interim report on the assessment of animal-drawn toolbars in local farming systems. Agricultural Mechanization Research Programme, I.A.R., Samaru.

Mbonda, S.A. 1983. Optimum organization of farm enterprises in smallholder agriculture: a linear programming analysis of farm operations in Zaria area of Northern Nigeria. M.Sc. Thesis, Ahmadu Bello University, Zaria, Nigeria.

Norman, D.W., 1975. Rationalizing mixed cropping under indigenous conditions: the example of Northern Nigeria. *J. Devpt Studies* 11:1.

Norman, D.W. 1972. An economic survey of three villages in Zaria Province.

Ogunfowora, O. 1972. Derived resource demand, product supply and farm policy in the North Central State of Nigeria. Ph.D. Thesis, Iowa State University, Ames, USA.

Ukpabio, G.E. 1978. Productivity differentials between small and large scale farmers: a case study of the Fun-tua Agricultural Project area. M.Sc. Thesis, Ahmadu Bello University, Zaria, Nigeria.

Van Raay, J.G.T. 1975. Animal husbandry in the Zaria area. Samaru Research Bulletin 179, Nigeria.

Utilization and management of work oxen in a Guinea-savanna environment in Nigeria: initial survey results

by

E. O. Otchere, H. U. Ahmed, S. A. S. Olorunju and M. S. Kallah

Livestock Systems Research Project, National Animal Production Research Institute, Ahmadu Bello University, Shika, P.M.B. 1096, Zaria, Nigeria

Abstract

The results of a preliminary survey on work oxen utilization and management in 300 farming households that use animal traction are presented. Results showed that all respondents use the Bunaji (White Fulani) breed for the following reasons: ability to work (60%), availability (23%), large size/weight (12%), other (5%).

Animals are purchased when young (often after weaning) and 90% are put to field work when 3-4 years old. Animals are used in pairs and in the following combinations: bulls only (84%), castrates only (8%), bulls and castrates (8%). No cows are used for plowing.

Most respondents (96%) used animals for four or more planting seasons before replacing them. The training of animals for field work takes 1-3 months (73% of respondents), and in some cases 6 months (16%). All farmers train their own animals.

Respondents indicated that during the rainy season work oxen were tethered in fallow fields generally around the house while not at work. Work oxen received mostly crop residues from sorghum, millet, groundnuts, and cowpeas in the dry season. Contribution from purchased feeds like cottonseed cake and wheat bran was said to be negligible because of shortage and cost. Dry season feeding problems were stressed by respondents who indicated their willingness to cooperate with the LSR team to identify suitable packages to ameliorate the situation.

Introduction

Soil and climatic factors are crucial and determine the relative importance of different cropping operations and the consequent labour bottlenecks which animal traction could help alleviate. In areas where rainfall is low or of an erratic pattern, the growing season can be short and therefore sowing has to take place soon after the first rains. Rapid but superficial soil preparation here is therefore generally advantageous.

Where the growing season is prolonged by higher rainfall, and early sowing is not very urgent, plowing is generally beneficial because (1) it improves soil tilth; (2) it leads to clean seedbeds so that plants have an early advantage over weeds and the interval between sowing and first weeding is prolonged; (3) organic matter growing on the surface at the time of soil preparation is buried.

Farming conditions vary widely in Nigeria. Smallholder crop-based agriculture is predominant. Most farms are not mechanized and therefore manual labour is used for all weeding cultivations.

If animal traction were to be promoted in the farming systems it would make a positive contribution to agricultural development in Nigeria. This cannot be overemphasized. The advantage is the low cost of the technology which puts it within reach of the majority of farmers who are poor and have limited cash. It

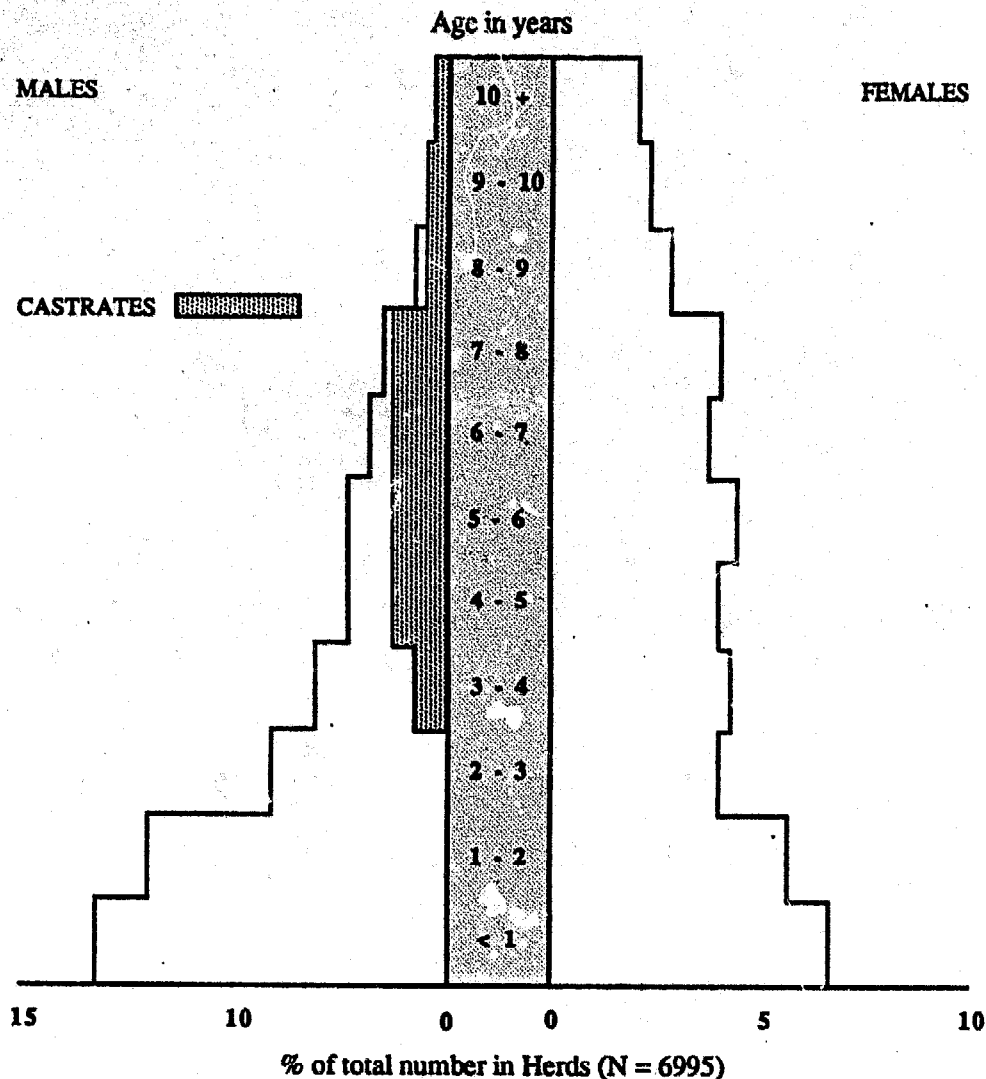

Figure 1. The herd composition in 157 Fulani herds in Giwa District (Source: Data of Livestock Systems Research Project, NAPRI/ABU, 1986)

will conserve foreign exchange because the animals are from local sources, while equipment and spare parts could be manufactured locally (as is being done by John Holts in Zaria, Kaduna State, and by local blacksmiths). This should lead to domestic industrial growth and an enhancement of crop and livestock production.

According to Alkali (1969) the use of cattle as a source of power in Nigeria was first demonstrated in 1922. By 1939 there were 1959 farmers who owned work oxen and the number of farmers had increased to 36,000 by 1965. According to a recent survey reported by Umoh and Starkey (undated), there appeared to be

no up-to-date estimates of the national population of work oxen.

In a diagnostic survey of 157 Fulani agropastoral households and 6995 head of cattle carried out by NAPRI's Livestock Research (LSR) team (Otchere *et al.*, 1986), it was observed from the herd structures that young bulls start to leave the herds soon after weaning (Fig. 1). This observation is contrary to data reported by Otchere (1986) from agropastoral Fulani herds in the International Livestock Centre for Africa (ILCA) case study areas, some 300 km south of NAPRI's study area. The NAPRI study area appears to be within a transitional

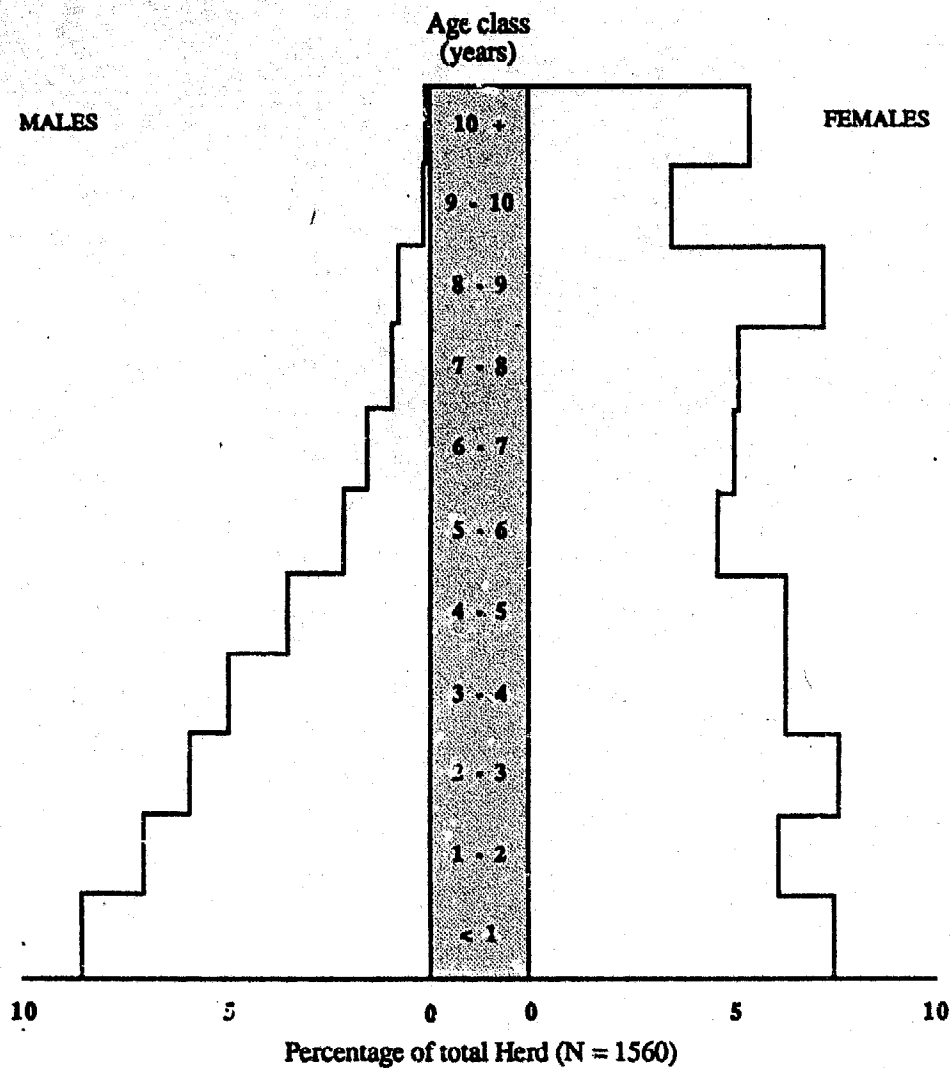

Figure 2. The herd composition in thirty-four agropastoral herds in Kurmin Biri, Abet and Madauchi (Source: ILCA Sub-Humid Zone Programme: Otchere, 1986)

zone for animal traction in the Kaduna State of Nigeria.

Methodology

The data for this report form part of baseline information for NAPRI's LSR Project. The study was to find out if the early disappearing young males from the Fulani herds in the case study area went into the animal traction system. Data were obtained from 300 respondents who owned work oxen through a questionnaire and participant observation. The study was in the period May-July 1986, which is the cropping season.

Results and discussion

About 73% of respondents indicated that they were residents within the case study area while the remainder were migrants. Ten per cent of the respondents indicated they had come to stay in the area and so would not go back to their original homes after the cropping season. This suggests that some respondents use work oxen on a commercial basis. They move into the area, plow and charge cash from clients. Some 87% of respondents indicated that they own work oxen because it is profitable. Studies by Laurent (1968) had indicated that owning work oxen in northern Nigeria was a profitable venture.

Table 1. Reasons given for using the White Fulani breed

Reasons	No. of Respondents	%	Cumulative %
Docility	12	4	4
Big/heavy	5	12	16
Ability to work	180	60	76
Availability	70	23	99
Cheapness	3	1	100

Table 2. Animal sex used

Combinations	No. of Respondents	%	Cumulative %
Bulls only	252	84	84
Castrates only	24	8	92
Bulls/castrates	24	8	100
Bulls/cows	0	0	100
Cows only	0	0	100

Breed and sex of cattle used

All respondents indicated that they used the Bunaji (White Fulani) cattle. This *Bos indicus* or zebu breed is predominant in Northern Nigeria.

Some 83.3% of respondents (see Table 1) pointed out that their choice for this breed was due to its ability to work and availability. Only 4% of respondents said they use this breed because of its docility. However, it is important to emphasize that this breed is known to be very docile and is probably the reason why 78% of respondents use entire males for traction and the remaining 22% use steers or castrates. No cows are used for traction. While 84% of respondents paired up bulls only, 8%

Table 3. Number and sex of cattle owned

No. of Cattle	Bulls		Castrates		Cows	
	No. of respondents	%	No. of respondents	%	No. of respondents	%
None	-	-	240	80.0	280	93.3
1	-	-	30	10.0	15	5.0
2	182	60.3	15	5.0	2	0.7
3	80	26.7	6	2.0	2	0.7
4	20	6.7	5	1.6	1	0.3
5	16	5.3	2	0.7	-	-

used castrates only and the remainder used bull/castrate pairs. This is shown in Table 2.

Source of animals and age at entry

The majority of respondents procured their work animals from the open market, while some obtained their animals directly from Fulani herds. As indicated in Table 3, only 7% of respondents kept cows and produced their own replacement bulls for work. Animals were generally bought when under two years of age and not fully grown. They were therefore not used for field work until they were about 4 years old (90% of respondents). Respondents did not take any loans for the purchase of their animals.

Length of training and useful life of work oxen

All respondents indicated that training is done by themselves. There were differences in opinion as to the length of time required for training animals for work. Some 50% of the respondents indicated that training took one to two months while an additional 30% said it took three to four months (Table 4).

The majority of respondents (76%) indicated that they used trained animals for five or more cropping seasons before disposing of them. The rest used their animals for three to four seasons (Table 5). After the useful life of an animal, it was sold at current market price.

From all indications the value of work animals appreciated rather than depreciated.

During the cropping season, animals started work at about 6.00 a.m. and stopped at about 11.30 a.m. Animals were allowed to rest for 15 minutes

Table 4. Training time of animals (in months)

Months	No. of Respondents		Cumulative %
	No.	%	
1	67	22	22
2	84	28	50
3	72	24	74
4	17	6	80
5	12	4	84
6	48	16	100

Table 5. Number of seasons (years) animals are used

Seasons (yrs)	No. of Respondents		Cumulative %
	No.	%	
3	14	5	5
5	8	19	24
5	110	37	61
Over 5	118	39	100

after working for about two hours. Animals were returned to the field to work further from about 3.00 p.m. to 6.00 p.m.

Maintenance of work oxen

Generally, there are no cash costs involved in the keeping of work oxen. During the period of peak use (from May to August), there is abundant forage for grazing. Animals are normally tethered on fallow land to graze (84% of respondents) and then kraaled during the night within the compound or very near to the house.

After harvesting, most respondents feed millet and Guinea corn residues in addition to cow-peas and groundnut hay. Purchased feeds like cottonseed cake and groundnut cake were not fed because they were expensive and/or not readily available.

Respondents indicated that their major problem is adequate feeding of their animals towards the end of the dry season. As a result there is generally a slight delay in the start of the use of animals for field work at the beginning of the rainy season. A potential intervention point therefore is the planting of forage legumes on fallow lands to be harvested, stored and fed during the peak of the dry season so as to get animals into good condition for work soon after the first rains. Respondents indicated their willingness to cooperate with the LSR team in this regard. The team will use a systems approach with an integrated and problem-oriented strategy with emphasis on on-farm technology testing and appraisal. This will be complemented where necessary by relevant on-station research.

References

- Alkali, M. 1969. Mixed farming: need and potential. In: *Livestock development in the dry and intermediate savanna zones. Proceedings of conference held 16-18 June, 1969, Zaria. Institute of Agricultural Research, Ahmadu Bello University, Samaru, Zaria, Nigeria.* (E).
- Laurent, C. K. 1968. The use of bullocks for power on farms in Northern Nigeria. *Bull. Rural Economics & Sociology* (1968): 1-13. Reprint No. 61. Nigerian Institute of Social and Economic Research, Ibadan, Nigeria. (E).
- Otchere, E. O. 1986. Traditional cattle production in the sub-humid zone of Nigeria. In R. von Kaufmann, R. Cater and R. Blench (Editors). *Livestock system research in Nigeria's subhumid zone. Proc. 2nd ILCA/NAPRI Symposium held 29 Oct.- 2 Nov. 1984, Kaduna, Nigeria. International Livestock Centre for Africa, Addis Ababa, Ethiopia.* (E).
- Otchere, E. O., Ahmed, H. U. and Taiwo, B. B. A. 1986. Livestock systems at NAPRI: Initial results. Paper presented at the 3rd On-Farm Adaptive Research Networkshop, held 24-25 June, 1986, at I.A.R., Ahmadu Bello University, Zaria, Nigeria. (unpublished). (E).
- Umoh, J. E. and Starkey, P. H. undated. The use of draught power in three West African countries. Commonwealth Secretariat, London. (unpublished). (E).

Title photograph (opposite)
Groundnut lifting with a horse near Koalack, Senegal
(Photo: Paul Starkey)

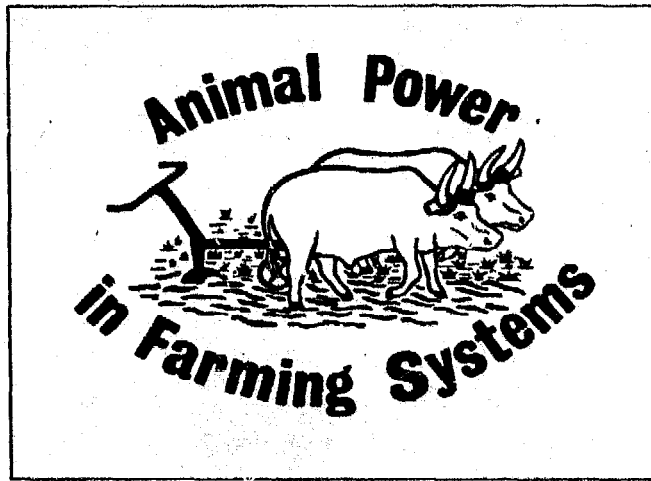

Animal Power in Senegal



Eléments d'analyse de la situation actuelle de la culture attelée au Sénégal: perspectives d'études et de recherches

par

Michel Havard¹ et Adama Faye²

Institut Sénégalais de Recherches Agricoles (ISRA), Dakar, Sénégal.

Résumé

Le développement de la culture attelée, très important lors du programme agricole, est arrêté depuis 5 ans. Ce blocage est dû à l'arrêt du crédit, provoqué par les dettes des coopératives (31 milliards FCFA en 1981). Le parc de matériels comprendrait aujourd'hui 200 000 houes, 150 000 semoirs super-éco, 100 000 charrettes, 70 000 souleveuses et 50 000 charrues. Le cheptel de trait se répartirait en quelque 400 000 équidés (chevaux et ânes) et près de 60 à 70 000 paires de bovins.

On peut distinguer 8 zones de répartition de la culture attelée sur le pays: 5 zones au-dessus de la Gambie où dominent les matériels légers (houes sine et super-éco) et la traction équine (les zones du bassin arachidier représentent les plus fortes densités de matériels) et 3 zones au Sud de la Gambie où dominent les matériels de travail du sol (charrues, butteurs) et la traction animale avec des bovines trypanotolérants. Les charrettes sont présentes sur l'ensemble du pays.

De cette analyse, il ressort qu'il faut conduire en priorité des études détaillées de connaissance du parc matériel et du cheptel pour affiner le zonage existant. Parallèlement, il faut conduire en amont une analyse détaillée sur les filières de distribution du matériel et en aval des études sur les possibilités d'adaptation du réseau de maintenance au volume actuel du parc. Les recherches sur la traction doivent viser en premier lieu l'amélioration de l'alimentation et de la

couverture sanitaire du cheptel de trait, puis l'amélioration des performances de la traction équine (zones 2, 3, 4 et 5) et de la traction bovine (zones 4, 6, et 7). Les recherches sur le matériel doivent être régionalisées et surtout axées sur la Casamance et le Sénégal Oriental.

Introduction

Le développement de l'agriculture sénégalaise entre 1945 et 1980 a été étroitement lié aux efforts et aux résultats obtenus sur l'accroissement de la production arachidière. Cette culture de rente a ainsi favorisé l'introduction et la diffusion de la culture attelée et une plus grande utilisation des semences sélectionnées et des engrais. L'influence du coton, culture de rente assez récente (1967) concerne des superficies limitées, principalement localisées au Sénégal Oriental et en Haute Casamance.

A partir de 1980, la suspension du Programme Agricole (P.A), qui avait pour principales caractéristiques le crédit et les subventions, a entraîné l'arrêt des distributions de matériels de culture et la chute de la consommation d'engrais minéral. Aujourd'hui, les nouvelles orientations en matière de politique agricole accordent une attention particulière au développement des céréales et à la conservation du patrimoine foncier.

1 Ingénieur de Recherche, Centre de Coopération Internationale en Recherche Agronomique (CIRAD), France, détaché à l'ISRA.

2 Zootechnicien, Département Systèmes, ISRA.

Cette note présente, en premier lieu, les principales étapes et les conditions qui ont favorisé le développement de la culture attelée. Elle donne ensuite, une tentative de zonage à l'échelle nationale sur la base des différents matériels et modes de traction utilisés. Elle termine par une ouverture sur les besoins actuels de connaissances et les nouvelles voies de recherche à entreprendre en matière de culture attelée.

Principales étapes et conditions du développement de la culture attelée

Introduction

Cette étude s'appuie sur les données chiffrées des mises en place annuelles pour chaque catégorie de matériels (Tableau 3). La prise en compte des animaux de trait s'est heurtée à des difficultés liées au caractère ponctuel et fragmentaire des informations existantes ainsi qu'à leur fiabilité.

Figure 1. Courbes de distribution des matériels les plus utilisés (Source: Havard, 1985a)

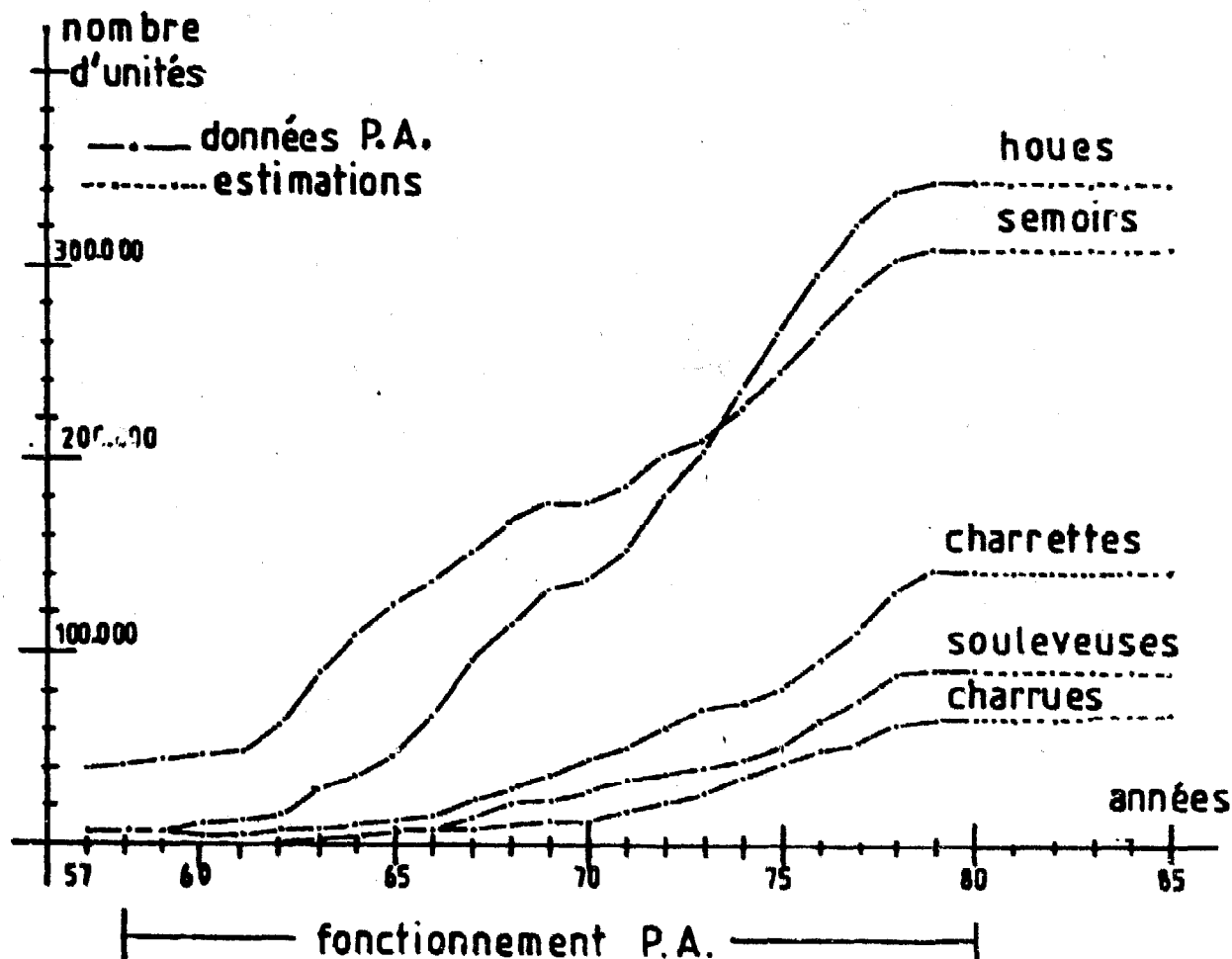

A partir des courbes de distribution des mises en place cumulées de matériels, il a été distingué trois grandes périodes (Fig. 1).

La période de vulgarisation du semis mécanique (avant 1958)

Les tentatives de lancer la traction bovine sont antérieures à la deuxième guerre mondiale. Cependant elles ont enregistré de nombreux échecs alors que se développaient les tractions equines et asines. En effet à cette époque les conditions favorables à l'adoption de la traction bovine n'étaient pas réunies.

La Figure 1 montre que jusqu'en 1958 le parc matériel se composait essentiellement de semoirs (semoirs super-éco d'Ulysse-Fabre) et quelques rares houes légères type houe occidentale du même constructeur. Le semis de l'arachide était pratiquement la seule opération dont la mécanisation se trouvait en pleine expansion dans les exploitations agricoles paysannes.

Par ailleurs, alors que l'usage traditionnel du cheval et de l'âne pour le transport (monture, bât) rendait leur adaptation aux travaux agricoles plus facile, il n'en était pas autant pour les bovins.

La période du Programme Agricole (1958-1980)

Cette période se caractérise par un vaste processus de transfert de technologies vers le

monde rural. Le programme agricole (P.A) a été l'un des instruments qui ont le plus soutenu et favorisé cette option marquant profondément l'évolution de l'agriculture en général et de la culture attelée en particulier. Son élaboration, sa gestion et son contrôle ont entraîné la mise en place de diverses structures:

- de fabrication locale des matériels (SISCOMA),
- d'approvisionnement des paysans en facteurs de production et de commercialisation des arachides (ONCAD et Coopératives),
- de formation et vulgarisation (SATEC puis SODEVA, CFDT puis SODEFITEX, SOMIVAC, etc.).

Quelques projets de recherche-développement ont été également mis en oeuvre (Unités Expérimentales du Sine Saloum, SEMA de Boulel, CGOT puis SODAICA et PRS en Casamance, etc.). L'ensemble a été orchestré par un crédit à court terme (1 an) sur les engrais et les semences et à moyen terme (5 ans) sur le matériel de culture attelée et la traction bovine. A certains moments des subventions ont été accordées sur des chaînes de matériel.

Dans son essence, le Programme Agricole était l'instrument privilégié pour l'accroissement de la production arachidière et celle des céréales. Cette option s'est radicalisée avec le "Programme de développement accéléré de la productivité d'arachide et de mil dans le bassin

Tableau 1. Nombre de paires de boeufs placées

Année	Casamance	Diourbel	Fleuve	Sénégal Oriental	Sine Saloum	Thiès	Total
1965	100	300	42	-	-	133	575
1966	355	184	2	57	192	172	962
1967	370	108	-	15	100	77	670
1968	940	96	-	20	76	37	1169
1969	353	116	-	62	89	28	648
1970	447	64	-	157	63	-	731
Total	2565	860	44	291	520	447	4735

Figure 2. Jougs de nuque (type Bambey et type Boulel)

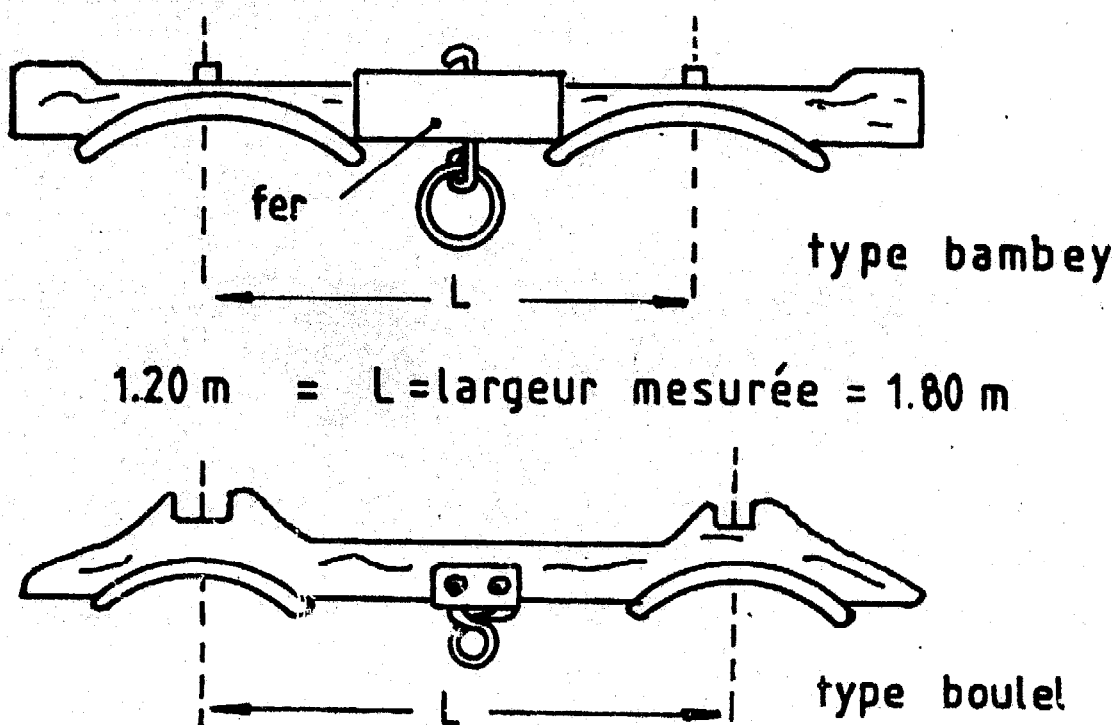

arachidier" confié à la SATEC entre 1964 et 1968.

Ce programme concernait les actuelles régions Diourbel, Fatick, Kaolack, Louga et Thiès, c'est-à-dire la zone qui fournissait 80% de la production arachidière à cette époque, d'où le

terme bassin arachidier pour désigner cet ensemble. Le but visé était d'atténuer le choc économique résultant de la suppression des tarifs préférentiels du marché français de l'arachide à partir de la récolte de 1967 (Accord de Yaoundé).

Tableau 2. Situation du cheptel de trait à l'arrêt du Programme Agricole

Animiaux	Casamance	Diourbel	Thiès	Louga	Sine Saloum	Sénégal Or.	Total
Bovins (paires)	7032	3446	2181	1068	26 610	4472*	44 809
% UT Total	45	7	4	1	13	-	
Chevaux	1500	30 000	30 000	50 000	104 600	6300	222 400
% UT Total	10	57	57	38	52	-	
Anes	7000	19 000	20 000	80 000	72 000	8700	206 700
% UT Total	45	36	39	61	35	-	
Bov.trait/tot.Bov (%)	3	6	4	1	11	-	
Ha cult./UT (ha)	15 549	5	5.8	2.5	4.5		

*Zone Cotonnaire (Départements de Tambacounda et celui de Kédougou, hors Bandafassi).

**Unités de Traction.

Source des données de base: Rapports DSPA, SODEVA, SODEFITEX.

En 1968 lorsque le programme s'est achevé, le monde rural du bassin arachidier était assez profondément sensibilisé aux techniques proposées. Mais jusque là, avec la vulgarisation de techniques légères recommandées par la recherche agronomique, c'est le matériel léger (houes occidentales, houes sine et semoirs super-éco) qui s'est fortement accru. La puissance de traction provenait encore pour l'essentiel de l'exploitation du cheval et de l'âne. La SATEC évoque qu'à la fin du programme le cheptel équin et asin existant était saturé en semoirs et houes.

De son côté la recherche agricole avait travaillé sur la mise au point:

- de chaînes de matériels polyvalents adaptés à la traction bovine (houe sine gréco, ariane, arara et polyculteur). Ces recherches ont été menées en étroite collaboration avec des constructeurs locaux (SISCOMA) et étrangers (ARARA, NOLLE, ULYSSEFABRE, etc.);
- de techniques d'exploitation du cheptel bovin national par la traction (types d'animaux, capacités de travail, conditions

Tableau 3. Mises en place annuelles de matériels

Années	Semoirs	Houes	Charrettes	Souleveuses	Charrues	Butteurs	UCA*
Avant 58	39800	3150	4600	-	1100	-	-
1958	1294	748	3100	120	500	-	230
1959	2000	2000	200	-	500	-	170
1960	3333	4118	200	-	794	-	100
1961	4589	1061	992	300	200	-	83
1962	12001	6827	2266	1200	578	-	3151
1963	24906	12335	1542	1600	1487	-	2026
1964	19629	7414	2523	892	746	-	1311
1965	16650	9000	3515	1792	1729	-	291
1966	14127	21500	6997	1336	1006	-	104
1967	17215	28121	8582	9421	985	-	72
1968	12975	19292	7433	4465	2216	22	159
1969	7670	16706	5828	2065	1995	139	116
1970	2836	6311	3674	2797	1704	247	24
1971	9086	16469	6971	1849	2977	157	51
1972	12484	26327	10147	6677	4084	162	180
1973	11461	22902	8566	4912	3271	570	262
1974	16478	26140	4129	4750	12178	1514	15
1975	17490	31922	4302	6220	5063	765	203
1976	23913	33397	16817	14433	6693	1556	92
1977	20882	24746	13693	12202	5232	1861	221
1978	16166	17642	18693	8673	6284	1522	550
1979	5252	4606	8489	2556	3131	400	50
1980-85	-	-	-	-	-	-	-
Total							
1958-85	272077	339764	138659	88460	63353	9115	9587
Total							
Général	311877	342914	143259	88460	64453	9115	9587

* 2 périodes de distribution des Unités de Culture Attelée (UCA):
 avant 1958: chaînes de matériels (houes + semoirs + souleveuses)
 après 1958: matériel de traction bovine lourde (arianas, polyculteurs).

Source: Rapports annuels des services de l'Agriculture, Archives de l'ONCAD

d'alimentation, amélioration génétique en vue de la résistance à la trypanosomiasc et d'accroissement du gabarit);

- de jougs adaptés aux conditions de culture du pays (Fig. 2, type Bambey et Boulel).

Ainsi il apparaissait possible et indispensable de développer la traction bovine. Le "Projet de développement de la traction bovine au Sénégal" vit donc le jour en 1971 avec une durée de cinq ans. Son objectif était d'insérer la traction bovine dans l'exploitation paysanne préparant par cette voie l'intégration agriculture-élevage.

Au début de ce projet, la situation de la traction bovine dans les régions concernées est présentée au Tableau 1.

Sachant qu'à cette époque le placement des animaux par le biais du Programme Agricole était la seule source significative de bovins de trait, il apparaît que l'utilisation de cette forme de traction était marginale pour l'ensemble des six régions. La Casamance se distinguait déjà avec plus de la moitié des paires placées, ce qui s'explique par la non adaptation des chevaux dans cette région et la nature des terres.

Le résultat de toute cette politique est que plus de 80% des mises en place de matériels ont été effectuées pendant le programme agricole et principalement dans le bassin arachidier (90% des mises en place du pays sauf pour les charrues et les butteurs).

La traction bovine a été introduite dans de nombreuses exploitations sans aucune concurrence avec la traction légère, équine en particulier. La mécanisation de la quasi-totalité des opérations culturales était réalisée dans certaines zones (bassin arachidier) corrélativement à l'accroissement et à la diversification des matériels et des unités de traction. L'importance du cheptel de trait dans les principales régions d'extension de la culture attelée pendant le programme agricole est présentée au Tableau 2.

L'après Programme Agricole (1980 à nos jours)

La suspension du programme agricole a été provoquée par l'endettement cumulé des coopératives (31 milliards de F. CFA en 1981). De mauvaises récoltes d'arachide dues à la sécheresse et le blocage des prix ont été les principales causes de l'incapacité des paysans de rembourser leurs dettes.

L'arrêt du crédit a entraîné l'arrêt des distributions de matériels agricoles et la chute de la consommation d'engrais minéral. Les structures fortement dépendantes du programme agricole dont on a parlé précédemment ne lui ont pas survécu: la SISCOMA dépose son bilan fin 1980 et l'ONCAD est dissoute la même année.

Pendant cette période, seuls des projets ponctuels comme le PIDAC, en Basse Casamance, la SODEFITEX, au Sénégal Oriental et en Haute Casamance, ont pu distribuer des matériels de culture attelée et en nombre limité (quelques milliers d'exemplaires sur 5 ans).

Aujourd'hui, en dépit de la mise en place de nouvelles structures (la SISMAR créée en 1982 en remplacement de la SISCOMA, la SONAR créée en 1980 en remplacement de l'ONCAD et dissoute en 1984) et la prise en charge de la commercialisation de l'arachide par les huiliers on peut considérer que la situation des mises en place est identique à 1980.

Pour les animaux de trait, les équins et les asins semblent s'être stabilisés autour de 200 000 pour chaque espèce (DSPA, 1982). Concernant les bovins de trait, les aspects élevage pour les femelles et embouche pour les mâles leur confèrent un intérêt particulier et justifient leur évolution au cours de cette dernière période dans certaines zones. On estime leur effectif à quelque 70 000 paires essentiellement localisées au Sud du bassin arachidier en Casamance et au Sénégal Oriental.

Repartition des matériels et des moyens de traction

Estimation du parc de matériels et de la traction utilisés

Des statistiques régionales précises n'existant pas dans ce domaine, nous avons donc procédé à un certain nombre d'estimations à partir des chiffres régionaux de mises en place et des données ponctuelles fournies par les sociétés de développement et les services agricoles.

Sur les chiffres de mises en place (Tableau 3), nous appliquons la formule suivante à chaque catégorie de matériels:

$$PS(N) = PC(N) - PC(N - 15)$$

ou:

PS (N) représente le parc en service l'année *N*, et *PC (N)* et *PC (N - 15)*, les placements cumulés des années *N* et *N-15*.

Nous considérons un âge moyen de réforme de 15 ans qui intègre les données enregistrées par la SODEVA (10 ans pour les houes et 17 ans pour les semoirs).

En 1983, cette formule nous donne 145 000 semoirs, 230 000 houes, 100 000 charrettes, 70 000 souleveuses, 52 000 charrues et 8 200 butteurs. Ceci représente entre 45 et 75% des mises en place suivant les catégories de matériels. Cette même formule nous montre que le maximum d'utilisation aurait été atteint en 1979 avec 230 000 semoirs, 310 000 houes, 130 000 charrettes, 85 000 souleveuses, 58 000 charrues et 9 000 butteurs.

En pratique, il semble que la chute dans l'utilisation des matériels ne soit pas aussi importante; en effet, les paysans ont tout mis en oeuvre pour maintenir, avec l'aide des artisans locaux, leurs matériels agricoles en état de fonctionnement. Ainsi, les résultats enregistrés dans le cadre d'une étude portant sur l'Unité Expérimentale de Thyssé Kaymor montrent que le niveau d'utilisation du parc de matériel

de culture attelée s'est stabilisé depuis 1979-1980, mais avec des difficultés croissantes de maintenance (Havard, 1985b).

Les données disponibles pour les animaux de trait sont à la fois très incomplètes et peu précises. En fonction du taux d'utilisation du matériel agricole et de quelques données des sociétés de développement (SODEVA et SODEFITEX), la composition du cheptel de trait pourrait être la suivante: 200 000 équins, 200 000 asins et 60 à 70 000 paires de bovins.

Caractéristiques des zones de culture attelée

Nous avons représenté schématiquement 8 grandes zones d'utilisation de la culture attelée (voir Carte). La distinction entre ces zones est liée aux matériels et aux modes de traction dominants, ce qui n'exclue absolument pas la présence d'autres matériels et modes de traction, mais à un échelon moindre. Les charrettes, très utilisées dans toutes les zones et même dans les villes, ne sont pas considérées comme un critère de zonage. Cette répartition, qui n'est pas figée, pourra être revue et détaillée si le besoin s'en fait sentir.

La zone 1







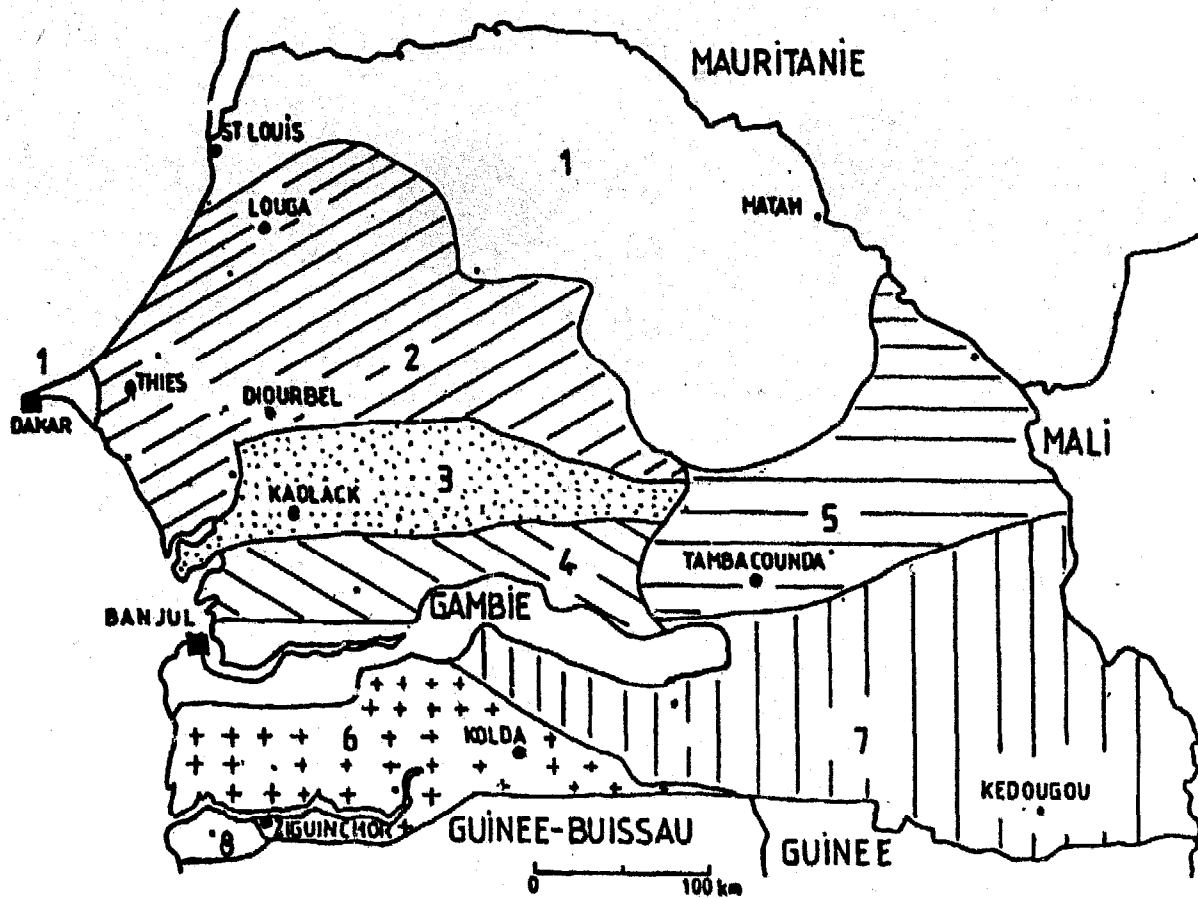

Il n'y a pratiquement pas de cultures pluviales. Elle comprend le bassin du Fleuve Sénégal jusqu'à Bakel environ, et la région de Dakar où la traction animale (équine et asine) est utilisée pour le transport (charrettes), et le Ferlo (zone sylvo-pastorale) où le transport est effectué à dos d'animaux (ânes) et rarement avec des charrettes.

Les zones 2, 3 et 4

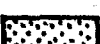
Elles correspondent au bassin arachidier où la densité de matériels de culture attelée et d'animaux de trait est supérieure au reste du pays. La zone 2 correspond approximativement aux régions de Louga, Thiès et Diourbel, où le travail du sol est inexistant. On y rencontre les semoirs, les houes (occidentales surtout, mais

Carte 1. Les différentes zones de culture attelée en fonction des types de traction et des matériels agricoles les plus utilisés



- 1  transport – équins et asins
- 2  superéco-houe occidentale-souleveuse arara – équins et asins
- 3  super éco-houes occidentales et sine-souleveuses arara et firdou –équins
- 4  super éco-houe sine-souleveuse firdou – équins et bovins
- 5  super éco-houe sine-butteur arara – équins et bovins
- 6  charrue ucf-butteurs arara et gambien – bovins
- 7  charrue ucf-houe sine et chaine arara – bovins
- 8  pas d'utilisation de la traction animale

REMARQUE. la charrette non spécifique à une zone fait partie des matériels les plus utilisés

aussi des houes sine) et les souleveuses sur bâti arara. Les tractions dominantes sont les chevaux et les ânes: en 1982, sur Diourbel, la SO-DEVA annonce 75% de chevaux, 23% d'ânes et 2% de paires de bovins. La zone 3 est une zone transitoire entre la 2 et la 4. Elle s'étend de Fatick à Kounghoul, de part et d'autre de Kaolack sur une bande de 60 km de large environ. On y rencontre beaucoup de semoirs et de houes (occidentales et sine à égalité); les souleveuses se répartissent entre les firdou et les arara. Les équins sont légèrement plus nombreux que dans la zone 2, et les asins diminuent au profit des bovins. La zone 4, correspond au Sud Sine Saloum; elle est surtout caractérisée par un fort développement de la traction bovine (paire de boeufs et de vaches), mais le nombre de paires est encore inférieur au nombre de chevaux. On y rencontre beaucoup de semoirs, de houes sine, de souleveuses firdou et quelques souleveuses artisanales. Le travail du sol, avant semis, demeure très limité (grattage en sec et en humide); le labour, malgré l'existence de charrues, est presque inexistant. La forte densité d'ariana enregistrée sur les Unités Expérimentale est une exception.

Les zones 5 et 7

On peut les assimiler au Sénégal Oriental et à la Haute Casamance, c'est-à-dire à la zone d'emprise de la SODEFITEX. La densité en matériels est très inférieure à celle des zones 2, 3 et 4. La distinction entre la zone 5 et la zone 7 provient des techniques culturales et des modes de traction différents (la zone 7, pour des raisons sanitaires, est pratiquement réservée aux bovins). Ainsi, en zone 5, le travail du sol est limité; le matériel rencontré dans cette zone comprend des semoirs super-éco (les tentatives d'introduction du semoir à coton "Tamba" ont échoué car la SODEFITEX trouve que les densités semées sont trop faibles), des arara (canadiens et butteurs) car le butteur arara était le matériel vulgarisé par la CFDT dans les années 60-70, et maintenant des houes sine, sur lesquelles on peut aussi monter un corps butteur. Les tractions équines et asines

dominent largement la traction bovine. La zone 7, plus humide, est équipée en UCF pour les labours de début de cycle destinés à enfouir l'herbe, en butteurs arara, et maintenant en houes sine; les semoirs existent aussi, mais en nombre réduit. Les bovins sont largement dominants, mais la sécheresse a amené quelques équins et asins pour le transport.

La zone 6

Elle s'étend sur la Basse et la Moyenne Casamance. Pour des raisons sanitaires, la traction bovine est largement dominante, mais avec la sécheresse les chevaux et surtout les ânes apparaissent au Nord de cette zone. On y pratique le travail du sol avant semis (labour d'enfouissement d'herbes) à plat ou en billons, mais la culture sur billons condamne l'emploi d'un super-éco. Les matériels diffusés sont la charrue UCF, les butteurs arara et Gambien, ce dernier étant surtout répandue près de la frontière (Fall, 1985). Le semoir super-éco existe surtout au Nord, et il est quelquefois utilisé pour semer le riz. La traction bovine est très peu utilisée dans la riziculture de bas-fond.

La zone 8

Elle correspond pratiquement au département de Oussouye, où l'on fait presque exclusivement de la riziculture. La traction animale est pratiquement inexistante, même au transport, effectué à pied ou à bicyclette.

Les études et recherches à mettre en place

Principes généraux

Il ressort des analyses menées aux deux paragraphes précédents les conclusions suivantes:

- un effort considérable de promotion a été mené sur la culture attelée pour satisfaire, dans un premier temps, l'objectif d'accroissement de la production arachidière. Pour ce faire, la mise en place du Pro-

gramme Agricole s'est traduite par une large diffusion de matériels et un développement de la traction animale en générale, bovine, en particulier;

- dans l'ensemble, la traction animale s'est considérablement insérée en milieu rural avec d'importants effectifs d'animaux;
- la situation actuelle de blocage (5 ans) entraîne une dégradation du parc matériel, peu sensible aujourd'hui car les artisans arrivent, tant bien que mal, à maintenir ce parc en service; mais avec les moyens dont ils disposent aujourd'hui, ils ne pourront pas le faire encore très longtemps. On voit donc qu'en matière d'équipement agricole, le Sénégal est confronté à d'énormes problèmes de logistiques (maintenance, approvisionnement, etc...) dont les solutions se traduiront par des coûts très importants;
- les caractéristiques de la culture attelée ne sont pas identiques dans toutes les régions du pays. Dans l'ensemble, on constate un très net engouement pour les matériels légers (houes sine) et la traction équine, malgré les efforts considérables effectués par la recherche et le développement pour faire passer la traction bovine.

Ces conclusions nous amènent à formuler quelques idées et recommandations sur les études et recherches à mettre en oeuvre en matière de culture attelée.

Les études

Mener des études en vue d'acquérir des connaissances précises sur le parc matériels et sur le cheptel, semblent constituer les actions les plus urgentes à conduire. Les résultats obtenus contribueront, dans le cadre des analyses systématiques, à la révision et à la précision du zonage établi, au recensement des contraintes et des opportunités spécifiques à chaque zone en matière de culture attelée. Il sera ainsi plus facile d'orienter efficacement le crédit agricole

dont les interventions seront désormais régionalisées.

Il est, en plus, indispensable de travailler parallèlement sur l'amélioration des circuits de distribution de matériels et de pièces et sur l'analyse du réseau de maintenance existant en vue de son adaptation au volume et aux caractéristiques du parc en service.

Les recherches sur la traction

L'alimentation correcte du cheptel de trait a depuis longtemps été et reste encore un des principaux facteurs limitant l'exploitation optimale de la traction animale (Tourte, 1961).

Les modes de gestion des sous-produits de récolte d'une part, celles des animaux de trait, d'autre part, ne permettent pas, dans la plupart des cas, d'assurer la couverture des besoins alimentaires de ces animaux, notamment au moment de la mise en place des cultures. En effet, seule une partie des résidus de récolte de l'exploitation revient au cheptel de trait pour deux raisons essentielles:

- le ramassage des sous produits est encore partiel; dans la grande majorité des cas, il se limite aux fânes de légumineuses, arachide notamment;
- pour cette même fâne d'arachide, seules les productions du gestionnaire des animaux de trait peuvent être systématiquement destinées à leur alimentation si elles ne sont pas vendues.

Les recommandations de la recherche et du développement pour la constitution de stocks fourragers incluant du foin de brousse sont en général peu suivies. En outre, la tendance d'aujourd'hui consistant, conformément à la volonté de réaliser l'auto-suffisance alimentaire, à réduire les superficies arachidières entraînera une baisse des disponibilités de fânes qui seront de plus en plus demandées par les élevages péri-urbains et urbains en augmentation.

Il s'avère ainsi indispensable de mettre au point des systèmes fourragers et de gestion des ressources fourragères qui puissent résoudre le problème posé tout en restant applicables par les agro-pasteurs.

Sur les animaux, un travail important mérite d'être effectué sur la traction équine dont la diffusion en justifie l'intérêt. La connaissance des capacités productives (reproduction, croissance, etc.) et des particularités alimentaires et nutritionnelles de nos chevaux est un préalable qu'on ne peut pas continuer à ignorer.

Dans l'ensemble, l'aspect alimentation-nutrition de nos animaux de travail reste un problème essentiel dont les conséquences sur leur productivité ne sont pas cernées. Beaucoup de paysans voient leurs chevaux mourir de sous-alimentation et d'épuisement à la fin de la saison sèche ou au cours des premiers travaux d'hivernage (semis). Les répercussions sur les chantiers de travail ne sont pas négligeables.

La recherche d'harnachements permettant de mieux utiliser la puissance des animaux est à entreprendre.

Sur le plan sanitaire, l'absence d'une assistance à la dimension des besoins relève davantage du développement que de la recherche. En effet le taux de mise en place d'agents de santé et leurs moyens de travail ne permettent pas de répondre à la demande de service des détenteurs d'animaux. L'orientation des services vétérinaires traditionnels vers une prophylaxie collective (vaccinations de masse localisées dans le temps) doit être revue et élargie vers des interventions plus individualisées en rapport avec le caractère actuel de la demande des éleveurs en services et médicaments.

Les recherches sur le matériel

A partir de ce premier zonage, nous voyons très aisément que ce volet doit être traité régionalement. Ainsi, les recherches conduites jusqu'à maintenant visaient le bassin arachidier; d'ailleurs, nous nous rendons aisément

compte que les résultats sont très concluants. Par contre les tentatives de diffusion de ces matériels dans d'autres régions ne semblent pas entièrement satisfaisantes.

La majeure partie des travaux sont à mener en Casamance et sur la zone SODEFITEX (zones 6, 7, 8). Il s'agit de tester des matériels pour les techniques culturales sur billons, pour les labours à plat d'enfouissement d'herbes en début de cycle, le travail du sol et le semis en rizières. Sur le bassin arachidier (zones 2, 3, 4), les problèmes de récolte et de post-récolte semblent prioritaires, mais pas forcément avec des solutions en culture attelée. Sur le Fleuve (zone 1), la culture attelée a très peu de chance de s'implanter, en dehors de la zone Matam-Bakel, si on exclue le transport.

Bibliographie

- Fall, A. 1985. Situation actuelle de l'environnement et de l'utilisation du parc de matériels de culture attelée en Basse Casamance. Mémoire de confirmation, Département Systèmes, ISRA, Dakar, Sénégal. (Unpublished). 145p. (F).
- Havard, M. 1985a. Principales caractéristiques et contraintes de gestion du parc de matériels de culture attelée au Sénégal. Document de travail 1985-2, Département Systèmes, ISRA, Dakar, Sénégal. 89p. (F).
- Havard, M. 1985b. Les caractéristiques, la gestion et la maintenance des outils manuels et de culture attelée sur l'Unité Expérimentale de Thysé Kaymor - Résultats de l'enquête effectuée en 1984. (A paraître). Département Systèmes, ISRA, Dakar, Sénégal. 73p. (F).
- SODEVA 1979. Propositions pour le développement des exploitations agricoles du Sine Saloum. Tome II: Situation actuelle et axes de développement. (F).
- SODEVA 1971. Projet de développement de la traction bovine au Sénégal. Document de travail. (F).
- Tourte, R. 1961. Le bétail de trait et son alimentation. Un tel élevage est rentable dans les conditions écologiques de Bambey. Bulletin Agronomique 20. 7p. (F).

Sigles et abréviations utilisés

CFDT	Compagnie Française de Développement des Textiles, Paris
CGDT	Compagnie Générale des Oléagineux Tropicaux, Paris
DSA	Direction des Services Agricoles, Dakar
DSPA	Direction de Santé et des Productions Animales
ONCAD	Office National de Commercialisation et d'Assistance au Développement, Dakar

PIDAC	Projet Intégré de Développement Agricole de la Casamance	SISMAR	Société Industrielle Sahélienne de Matériels Agricoles et de Représentations, Pout
PRS	Projet Rizicole de Sédhiou, puis Projet Rural de Sédhiou	SODAICA	Société de Développement Agricole et Industriel de la Casamance
SATEC	Société d'Assistance Technique et de Coopération, Paris	SODEFITEX	Société de Développement des Fibres Textiles
SEMA	Secteur Expérimental de Modernisation Agricole, Boulel	SODEVA	Société de Développement et de Vulgarisation Agricoles
SISCOMA	Société Industrielle Sénégalaise de Constructions Mécaniques et de Matériels Agricoles, Pout	SOMIVAC	Société de Mise en Valeur de la Casamance
		SONAR	Société Nationale d'Approvisionnement Rural.

Animal traction in Lower Casamance: technical aspects and socio-economic implications

by

Fadel Ndiamé *

Agricultural Economist, Département Systèmes, ISRA/Djibelor, Senegal

Abstract

Animal traction remains unequally developed in the different production zones of Lower Casamance. Its use rarely goes beyond land preparation. Farmers' reasons for using animal traction are mainly reduction of drudgery, better timeliness and extension of upland cultivation.

With decreases in annual rainfall and shortening of the rainy season in the region, animal traction may allow the timeliness required to secure production in the time available. However the impact of animal traction on labour productivity remains low, and this is associated with low use of existing equipment and only partial adoption of the technological options available.

From cash flow and cost-benefit analyses necessary conditions have been identified to ensure better utilization of the technology and make investments in this area profitable.

Introduction

The promotion of animal traction in Lower Casamance is part of an agricultural development strategy designed to intensify production and increase farmers' standard of living in the region. To implement this policy, the Programme Agricole (P.A.) and the Special Credit Program of PIDAC (The Casamance Integrated Agricultural Development Project) were established in the 1970's and in 1981 respectively, to facilitate the acquisition of farm equipment through credit.

This paper analyses the role played by animal traction in Lower Casamance. It draws heavily on several studies conducted by the Djibelor Farming Systems Research team (Fall, 1985; Sonko, 1985; Ndiamé, 1986). The first section describes Lower Casamance and the role of animal traction in farmers' strategies. The second section analyses the socio-economic effects of this technology in the region. The final section contains the conclusions and offers some recommendations for improving the efficiency of animal traction in the region.

Role of animal traction in farmers' strategies

Lower Casamance is located in the southwestern part of Senegal and corresponds to the administrative region of Ziguinchor. The region is very heterogeneous in terms of ethnic group, climatic conditions and soils. Several different types of production systems, characterized by differences in the division of labour and the organization of production, are found throughout the region.

The Djibelor Farming Systems Research (FSR) team began its programme in 1982. In order to identify technologies adapted to farmers' conditions and the needs of farmers in the region, the FSR team divided the area into five different zones (recommendation domains) with respect to three agro-socio-econ-

* The assistance of M. L. Sonko, A. Fall, J. Bingen and M. B. Diouf in the preparation of this paper is gratefully acknowledged.

Map 1. Lower Casamance and its agricultural areas (Source: *Equipe SPT de Djibélor, 1985*)

Key to Zones

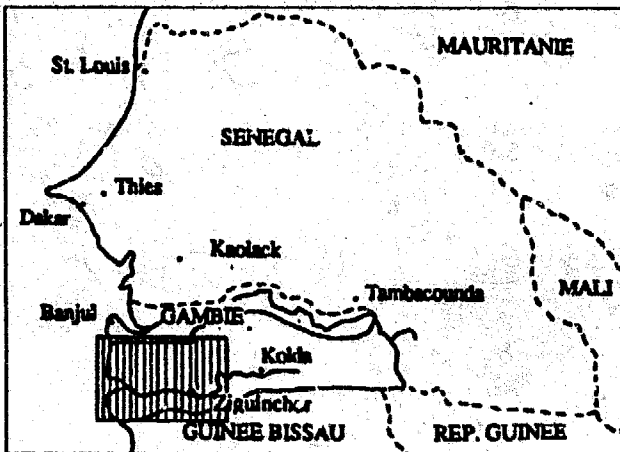

1. Diola social organization; farming systems based on transplanted swamp rice; no animal traction.
2. Diola social organization; farming systems based on transplanted swamp rice and direct seeding of other cereals; no animal traction.
3. Mainly Mandingo social organization; farming systems based on direct seeding of cereals; little animal traction.
4. Mandingo social organization; farming systems based on direct seeding of cereals; significant use of animal traction.
5. Mainly Diola social organization; farming systems based on transplanted swamp rice and direct seeding of other cereals; intermediate level of animal traction.

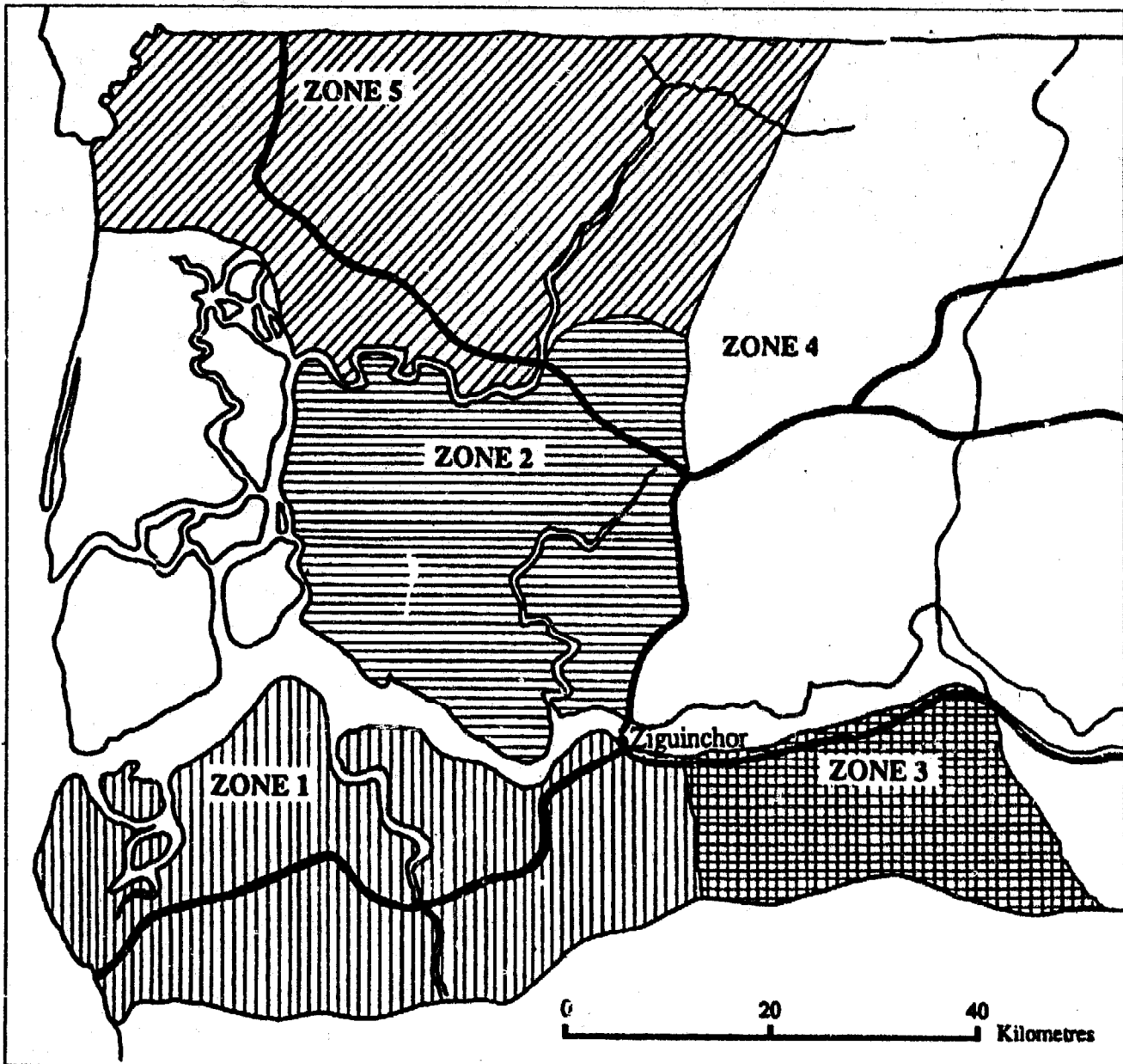

omic criteria: the irrigated/rainfed crop ratio, the sexual division of labour and the importance of animal traction (see Map 1). Animal traction is used mainly in the Sindian-Kalounayes (4th) and the Diouloulou (5th) zones. Upland crops dominate the area cultivated in both zones, and each differs notably with respect to the division of labour and the organization of farm production. A Mandingo-type of organization prevails in the 4th zone while the 5th zone is characterized by a Diola system (Equipe Systèmes, 1983, 1984). In the Mandingo systems, men work in uplands while women work the lowlands. Such a spatial division of labour implies a specialization of women in rice production while men specialize in the production of peanuts, millet and maize. In this system oxen cultivation is almost exclusively limited to uplands. In the Diola system on the other hand, men and women work together on both rainfed and irrigated crops with a complementary distribution of tasks: men plow the land, and women seed and transplant rice. Animal traction is widely used but is limited largely to land preparation.

Animal traction users

Recent surveys on a sample of 48 farms in the 4th and 5th zones reveal that the heads of residential units or chiefs of autonomous production units are the majority (79%) of animal owners in Lower Casamance. The users' status has important implications for the organization of production in the two systems. Among the Mandingoes, a residential unit coincides with a decision making unit concerning production activities and, specifically, the management of farm equipment. The family elder centralizes and manages family resources. Among the Diola, on the other hand, members of an extended-family group may live in the same residential area, but each nuclear family constitutes an autonomous production unit (Diouf, 1984). The average age of animal traction users is 53 years; the youngest is 24 and the oldest is 75. Experience with oxen cultiva-

tion varies widely from 0 to 25 years but averages 8 years (Ndiamé, 1986).

Reasons for animal traction use

A majority of farmers (79%) use animal traction for plowing because it is easier and faster than land preparation with hand tools. Only a minority of the farmers mention the opportunity to increase the area cultivated as the main reason for using animal traction. Ease and timeliness also motivated 42% of the farmers to use oxen-drawn seeders; (a similar percentage did not use seeders). Furthermore a high percentage (59%) of the farmers do not use weeding equipment, even though its use offers benefits. Finally, 59% of the farmers use carts for transporting equipment supplies and harvested crops (Ndiamé, 1986).

In summary, timeliness in production activities, and an effort to ease the workload constitute the most frequent reasons for the acquisition of animal traction equipment in Lower Casamance. Given the declining rainfall and the shorter rainy seasons in the region, a farmer's success for a cropping season depends on the speed of cultivation (plowing and seeding). In addition, previous studies undertaken on a larger sample have shown that Lower Casamance farmers increasingly seek to extend the area under upland cultivation and to shift from transplanting to direct seeding in lowlands (Posner *et al.*, 1985). Farm equipment plays a crucial role in these production strategies.

Farm equipment

The farm equipment used in the Lower Casamance consists principally of tools for land preparation (55%). These tools include:

Mouldboard Plows: the UCF or Arara types built by SISCO/MA/SISMAR in Senegal comprise 28% of the equipment and are generally found in the 4th zone.

Ridgers: include the SISCOMA/SISMAR type plus the Emcot type from The Gambia. They comprise 27% of Lower Casamance farm equipment and are found principally in the 5th zone.

One-Row Seeders: represent 10% of the region's farm equipment. The SISCOMA-SISMAR seeders were widely distributed through different credit programmes. The use of ridges, which is frequent in the region, limits the more widespread use of seeders.

Weeding Equipment: especially the SISMAR-made Sine cultivator, is also limited by the use of ridges.

Transport Equipment: represents 34% of the total equipment used and is the most frequently used after mouldboard plows and ridgers.

The credit programmes (P.A. and PIDAC) have been the major sources for farm equipment acquisition in the region. Purchases of used equipment and inheritance are the other principal sources of acquisition. Because of the heavy use of equipment and frequent renting, 50% of the equipment has been found to be in very poor condition. Many implements are used to the point where they are beyond repair and local blacksmiths generally lack the appropriate training and tools to provide proper repair services. Nevertheless farm equipment is being used and the most utilized equipment (UCF mouldboard plows and Gambian ridgers) has a life expectancy ranging from 8 to 10 years (Fall, 1985).

Draft animals

Draft animals used in the Lower Casamance include trypanotolerant N'Dama cattle (87% of total livestock), donkeys (10%) and horses (3%). There are several modes of acquisition: purchases from other farmers; removal from extensive herds; exchanges against small ruminants; and gifts. Purchases are most common

(49% of regional livestock), whereas only 29% of the draft animals come from the farmers' own herd. Most purchases are from other farmers (73% of the animals purchased) while 17% are purchased from traders.

The average starting age for a draft animal is 3 years 9 months (with the youngest recorded at 2 years and the oldest at 6 years). Donkeys and horses, however, are used for transport when they are 2 years old. Training takes place one month before the cropping season (June), if

Table 1:
Reasons for removing animals from service

Reason (ranked)	Number	%
Sales	93	46.5
Death	52	26.0
Trade	14	7.0
Slaughter	13	6.5
Theft	8	4.0
Rented out	7	3.5
Out for training	4	2.0
Return to herd	4	2.0
Marital gift	2	1.0
Unknown	3	1.5
TOTAL	200	100.0

Source: Sonko, 1985

the animal has been acquired at the end of the dry season, or during the off-season (December, January) if the animal was obtained at the end of the rainy season. About 70% of draft animals surveyed in 1984 were found to have been working for more than 6 years (Sonko, 1985). The reasons for removing animals from service are diverse. Table 1 presents a relative ranking of reasons.

The management and use of farm implements and draft animals

Farm implements and draft animals are acquired by the head of the farm unit who deals directly with the representatives of the various credit programmes. The management of the

implements is controlled by the head of the production unit, but involves several other family members.

A guide, generally a 10- to 14-year-old child, is in charge of livestock feeding. A work leader deals with equipment maintenance and organizes the use of teams on different fields. This individual also organizes the work schedule according to labour and seed availability, rainfall pattern, etc. (Sonko, 1985; Fall, 1985).

Plowing and ridging with oxen, scarifying with donkeys and horses, seeding and to some extent weeding are the main tasks undertaken by animals in the Lower Casamance. The use of different animals for different tasks varies by the size and composition of a farm herd and the work to be done.

As Table 2 shows, in the case of a typical farm unit in the studied area, oxen are used mainly for land preparation and seeding (74% of oxen working time). The relative importance of work done under rental agreements and/or for exchange labour should also be noted. Donkeys are not in heavy demand during the cropping season and their role in transporting supplies, farm implements and drinking water to the field is relatively limited.

In summary, the use of animal traction in the Lower Casamance remains limited to land preparation and seeding. Such limited use of draft animals is due in part to the lack of equipment on farms in the region. In addition, previous studies have shown that an animal's experience plays an important role in its use. For horses and donkeys transport is their main

activity until they acquire three years of experience; afterwards, they become more involved in seeding and weeding. For cattle, the youngest are used for plowing and seeding; after three years, ridging becomes their major activity.

Surveys conducted during the 1984 cropping season (Sonko, 1985) suggest that the strategy of farmers involves systematically using animals in maize and millet plots. Ridging and manual seeding are common and animals are paired according to their experience. In peanut fields, however, animals with unequal experience are harnessed for plowing and seeding.

In summary, the use of animal traction in the Lower Casamance varies widely by zone. The strategy for using animals is linked to several factors including the cropping pattern, the type and size of draft animals available, equipment availability and experience with animal traction. In comparison to their potential, the use of draft animals is limited. The optimum use of animal is associated with several factors not the least of which is the type of equipment available to farmers.

Socio-economic aspects of animal traction

Changes induced by animal traction

This analysis is based on several hypotheses about the potential positive effects of animal traction: increases in area cultivated, higher yields, savings in time. The analysis, however, takes into account the need to assure the tech-

Table 2: Animal use (Working hours from June 3 to August 21, 1984)

Animal	No. of days	Total hours	Ridging (%)	Plowing (%)	Seeding (%)	Weeding (%)	Transport (%)	Renting (%)
Cattle	32	154	32	21	21			26
Horses & Donkeys	22	62			64	23	13	

Source: Sonko, 1985

nical coherence of the package, for example the use of complementary inputs and appropriate cultivation techniques. The farmers' specific contingencies and problems related to the production environment are also accounted for as background in the analysis. The results discussed here were obtained from surveys conducted in the region and specifically from a comparative analysis of two types of farms, those with and those without animal traction.

A survey was conducted by the author on a sample of 48 farm households in the Ziguinchor Region. This revealed that the majority of farmers in the sample have started using fertilizers, improved seeds and insecticides when they adopted animal traction. Moreover, the use of manure, plowing and seeding in line became more frequent. The majority of farmers also said they increased the area of upland crops under cultivation: 90% of the sample on peanuts, 65% on millet and maize. Further-

more 59% and 52% of the farmers feel that their peanut and maize yields have increased because of the more timely techniques practised with animal traction. Finally, almost all farmers gained time with the adoption of animal traction, which has been used principally by most farmers to rest, to weed or to help women in low lands (Ndiame, 1986).

Although farmers have some clear perceptions about the effects of animal traction on their production system, it is commonly difficult for them to perceive certain aspects, such as yield effects, which can be assessed more accurately through cross-sectional analysis.

Results of a cross-sectional analysis

The following information is based on an analysis of data collected in 1983 by members of the Djibelor Production System team. Data collected in the Sindian-Kalounayes (4th zone) show a net income per person-workday of 761

Table 3: Cash-flow analysis on two groups of farm households

	GROUP 1	GROUP 2
	(Manual farmers)	(Animal traction users)
	CFA	CFA
1. Value of sales ^a	112 393	176 457
2. Off farm incomes	41 596	5 694
3. Purchase of inputs	4 441	9 574
4. A.T. expenses	0	2 000
5. A.T. income ^b	0	15 000
6. Net income (1+2-3-4+5)	149 549	238 798
7. Food purchases ^c	76 555	72 296
8. Other expenses ^d	7 462	15 129
9. Cash balances (6-7-8)	65 533	151 371
10. Loans received	0	0
11. Reimbursements	0	55 868
12. Net cash-flow (9+10-11)	65 533	93 503

^a Peanut sales.

^b Average income from renting out equipment.

^c Each farm household is assumed to purchase imported rice to fill its production gap.

^d Calculated on the basis of 1000 CFA francs per capita. A 500 CFA per capita tax is paid by each household; the remaining 500 CFA cover clothing and purchase of medicines.

Source: Computed from data collected by the Djibelor Farming Systems Research Team, 1984

CFA for farmers using animal traction versus 551 CFA for those without animal traction. Similar results were found in the Diouloulou (5th zone) area: 774 CFA versus 634 CFA (Sall *et al.*, 1985).

Statistical analyses were carried out on several performance variables of farm households with different levels of animal traction adoption. These show that besides total cultivated area, peanut yields and seeding time, there was no significant difference between farm households with weeders and those limited to seeders. It is worth noting here that because of the additional expenses which arise from the acquisition and maintenance of animal traction implements, their use must generate additional revenues at least equal to the expenses incurred. Otherwise, the adoption of animal traction risks impoverishing farmers or, at the very least, jeopardizing the latter's capacity to repay the equipment loan.

Cash-flow analysis

Table 3 shows the results of the analysis of one group of farm households with animal traction and another group relying on manual cultivation. The two groups have positive cash balances amounting respectively to 93 500 CFA and 65 300 CFA. However, adopters would have serious cash flow problems because of the need to purchase a pair of oxen during the first year of adoption. Therefore, unless they obtain draft animals from their own herd or on credit, animal traction would be out of their reach.

The provision of credit, however, is justified only if the investment can be profitable in the medium term. In the Lower Casamance the relatively small economic contribution of oxen cultivation reflects the transitory situation of farmers who have only partially adopted the technical package. It is possible that larger benefits will flow as farmers gain more experience and adopt the complete package. Budget analysis over several years should allow the in-

tegration of the dynamic effects of animal traction.

The profitability of an investment in animal traction

The analysis in this section is based on simulations of actual and possible farmer situations in the region. An emphasis is given to elements that farmers and policy-makers can control so that quick and stable improvements can be made in the use of animal traction. A cost-benefit analysis was carried out using the method described by Gittinger (1982). The elements on which the analysis is based are presented in Appendix 3. Table 4 summarizes the results of the analysis. The first scenario assumes a learning period of 5 years. After this period a 5% annual increase in area cultivated is assumed for peanuts. The internal rate of return (IRR) is 8%, which is much smaller than the interest rate paid on credit, or what is considered as the opportunity cost of capital.

When some of the hypotheses are relaxed, different scenarios or possibilities can be examined. In scenario 6, (see Table 4) the IRR (14%) exceeds the interest rate (12%). This assumes that area cultivated in maize, millet and sorghum is increased by 10% per year, starting in the 6th year. In addition, a 10% increase in the area allocated to peanuts, and a 5% per year increase in peanut yields are assumed. The IRR increases to 18% in Scenario 7 when a larger rate of increase in area devoted to peanuts (20%) is assumed.

Scenarios 1, 2 and 4 were estimated with a shorter learning period (3 years instead of 5). In scenario 8, IRR changes from -8% (scenario 1) to 2%. From scenario 2 to scenario 9 the IRR increases by a factor of 14. Finally, the IRR increases by a factor of 2 from scenario 4 to scenario 10.

If we assume that resources are not diverted when farmers use animals owned by the farm

Table 4: Financial profitability of investment under several scenarios

Scenario	Year	Crops	Increases in area cultivated (%)	Yield increases (%)	Increases in off-farm income (CFA)	Credit for animal purchase	Use of farmer's own draft animal	Value of animal resale (CFA)	Internal rate of return (%)
1	6	Peanuts	5	2	0	No	No	0	8
2	6	Peanuts	10	2	0	No	No	0	1
3	6	Peanuts	5	2	0	No	No	0	
		Millet	5	0					
		Maize	5	0					
		Sorghum	5	0					-6
4	6	Peanuts	5	5	0	No	No	0	
		Millet	5	5					
		Maize	5	5					
		Sorghum	5	5					
		Rice	0	5					7
5	6	Peanuts	10	5	0	No	No	0	
		Millet	5	15					
		Maize	5	15					
		Sorghum	5	15					
		Rice	0	15					9
6	6	Peanuts	15	5	0	No	No	0	
		Millet	10	10					
		Maize	10	10					
		Sorghum	10	10					
		Rice	0	10					18
7	6	Peanuts	20	5	0	No	No	0	
		Millet	10	10					
		Maize	10	10					
		Sorghum	10	10					
		Rice	0	10					
8	4	Peanuts	5	2	0	No	No	0	2
9	4	Peanuts	10	2	0	No	No	0	14
10	4	Peanuts	5	5	0	No	No	0	
		Millet	5	5					
		Maize	5	5					
		Sorghum	5	5					
		Rice	0	5					14
11	1	Peanuts	5	2	0	No	Yes	0	-1
12	1	Peanuts	5	2	0	Yes	No	0	-9
13	1	Peanuts	5	2	0	No	No	80 000	
	1-5				+ 5 000				2
14	6	Peanuts	5	2	0	No	No	0	
	6-10				+ 10 000				

Source: Ndiame, 1986

unit, the IRR is improved, in absolute value, by 7% (scenarios 1 and 11). However, when credit is provided to buy animals the IRR falls (-9% versus -8%). Finally, if after purchasing animals farmers can resell them, even for less than the acquisition price (80000 versus 100000 CFA francs), the IRR increases in absolute terms by 6% (scenarios 1 and 13).

It follows from the analysis that under the conditions of scenario 1, which reflect the current situation, most Lower Casamance farmers could not realistically adopt animal traction without a subsidy. Most of the farm implements owned in the region were distributed through the government-run equipment programme (Programme Agricole) and the debts

incurred by farmers in this programme were cancelled in 1980. It is unlikely that similar decisions will be taken in the future.

Moreover, even if in the next 10 years farmers could increase the area in peanuts by 100% and that of the major rainfed crops (millet, maize, and sorghum) by 25%, investment in animal traction will still be unprofitable. Only when increases in the area cultivated are matched with simultaneous increases in yields will the IRR exceed the interest rate. Thus, there is a need for a progressive intensification of farming systems in the Lower Casamance. In this respect, reducing the learning period with animal traction can play a major role. Better performances can be expected if farmers can combine a higher degree of technical mastery of equipment to a more complete adoption of the package: improved seeds, fertilizer and cultivation techniques. However, for most farmers in Lower Casamance, the level of initial investment and financial risk associated with these changes could jeopardize the adoption of the complete package. The achievement of rapid benefits can provide more incentives to make further investments. Appropriate institutional incentives can play a crucial role.

The resale of older animals could be an interesting possibility since the cattle market price increases as the animal gains weight. This option requires, however, certain cultural, technical, and institutional prerequisites that do not exist yet in the Lower Casamance, for example pasture availability, and outlets for the greater integration of livestock in farming. Moreover, research should not seek simply to improve the available technologies, but should also seek their progressive extension by accounting for the farmers' learning curve and their repayment capacity. Such an approach would involve an effort to coordinate the most important investments with the adoption of the first component of the package that increase agricultural productivity and provide farmers with higher net income.

Conclusions and perspectives

Animal traction constitutes a means by which decision-makers try to encourage intensification of agricultural production. It also plays a major role in new strategies adopted by farmers in the Lower Casamance in relation to decreases in the amount of rainfall and the shortening of the rainy season in the region.

The use of animal traction has induced changes in farmers' agricultural practices and it has positive effects on performances achieved by users: timeliness, reduced labour, and increases in area cultivated. However, the adoption of the technology generates, among other things, additional expenses that most Lower Casamance farmers could not meet. Furthermore, adoption in the region is only possible if animal traction induces in the medium run a greater intensification of agricultural production, higher yields and higher net income for farmers. For this, there is a need for important logistic institutional support, for example for inputs, equipment maintenance and extension advice.

The research programme conducted by the Production System Research team emphasizes the possibilities of intensifying production through animal traction. Trials are under way on type of equipment, land preparation, seeding and weeding techniques, manure and fertilizer applications. Research is also being carried out on meat and livestock marketing, and the role of blacksmiths in the farm implement maintenance. Other studies aimed at improving the nutritional and health status of livestock will be started very soon. Results from these studies could provide the basis for improving the technical and economic efficiency of animal traction in the region. From these studies, it is expected that the Production System team will be able to make useful recommendations to the Lower Casamance farmers and to decision-makers.

References

- Diouf, M. B. and Sonko, M. L. 1985. La recherche sur les systèmes de production en Basse Casamance: campagne agricole 1983/1984. Rapport annuel. Département Systèmes et Transfert, ISRA, Dakar, Sénégal. 149p. (F).
- Fall, A. 1985. Situation actuelle sur l'environnement et l'utilisation du parc de matériel de culture attelée en Basse Casamance. Mémoire de confirmation, Département Systèmes, ISRA, Dakar, Sénégal. (unpublished). 145p. (F).
- Gittinger, J. P. 1982. Economic analysis of agricultural projects. The Economic Development Institute of the World Bank. The Johns Hopkins University Press, Baltimore, USA. (E).
- Ndiame, F. 1986. Aspects économiques de l'utilisation de la traction bovine et de sa promotion par le biais du Crédit Spécial du PIDAC pour le matériel agricole: étude préliminaire dans la région de Ziguinchor. Mémoire de confirmation, Département Systèmes, ISRA, Dakar, Sénégal. (unpublished). 142. (F).
- Posner, J. L. 1985. Contribution à la connaissance agronomique de la Basse Casamance (synthèse bibliographique). Document de Travail 1985:3, Département Systèmes et Transfert, ISRA, Dakar, Sénégal. 43p. (F).
- Posner, J. L., Kamuanga, M. and Sall, S. 1985. Les systèmes de production en Basse Casamance et les stratégies paysannes face au déficit pluviométrique. Document de travail. Equipe Systèmes de Djibélor, ISRA, Sénégal. (F).
- Sall, S., Posner, J. L., Kamuanga, M. and Lo, M. 1983. La recherche sur les systèmes de production en Basse Casamance: campagne agricole 1982/1983. Rapport annuel. Département Systèmes et Transfert, ISRA, Dakar, Sénégal. 109p. (F).
- Sall, S., Posner, J. L., Kamuanga, M., Lo, M., Diouf, M. B. and Sonko, M. L. 1985. La recherche sur les systèmes de production en Basse Casamance: campagne agricole 1983/1984. Rapport annuel. Département Systèmes et Transfert, ISRA, Dakar, Sénégal. 149p. (F).
- Sonko, M. L. 1985. Les systèmes d'élevage en Basse Casamance: bilan des connaissances acquises et étude monographique des systèmes d'élevage à Boulandor (Kalounayes). Mémoire de confirmation, Département Systèmes, ISRA, Dakar, Sénégal. (unpublished). 149p. (F).
- Sonko, M. L. 1985. La traction animale et le travail animal au Sénégal: le cas du Nord-Est de la Basse Casamance. Document de Travail, Département Systèmes et Transfert, ISRA, Dakar, Sénégal. 18p. (F).
- Sonko, M. L. and Fall, A. 1986. L'utilisation des animaux de trait en Basse Casamance. ISRA/Département Systèmes. (under preparation). (F).
- Sonko, M. L. 1986. Les contraintes zootechniques de la traction animale en Basse Casamance. ISRA/Département Systèmes. (under preparation). (F).

La culture attelée dans les systèmes de production de la Basse Casamance: Aspects techniques et implications socio-économiques

par

Fadel Ndiamé *

Economiste Agricole, Département Systèmes, ISRA/Djibélor, Sénégal

* (Avec la collaboration M. L. Sonko, A. Fall, J. Bingen et M.B. Diouf)

Résumé

La culture attelée reste inégalement développée dans les différentes situations agricoles de la Basse Casamance. Son utilisation, qui dépasse rarement le stade de la préparation du sol, est principalement motivée par le désir des paysans de réduire la pénibilité du travail, de réaliser des gains de temps et/ou des extensions de superficies sur le plateau.

Avec la baisse de la pluviométrie et le raccourcissement des saisons de pluie en Basse Casamance, la sécurisation de la récolte peut dépendre de la rapidité d'exécution des opérations culturales permise par la culture attelée. L'impact de la traction animale sur la productivité du travail est cependant amoindri par l'adoption partielle du paquet technologique et la sous-utilisation des équipements.

L'analyse de trésorerie et celle des budgets pluriannuels ont permis de dégager les conditions d'une utilisation plus efficace de la technologie et celles d'une rentabilisation de l'investissement dans la culture attelée.

Introduction

La promotion de la culture attelée en Basse Casamance relève d'une stratégie par laquelle les responsables de l'agriculture visent à intensifier la production locale et par là, élever le niveau de vie des paysans de la région. Cette politique s'est traduite par la mise sur pied successive du Programme Agricole (P.A.) dans

les années 1970, du Crédit Spécial du PIDAC en 1981. Ces deux structures étaient chargées d'assurer l'équipement du monde rural en matériel agricole grâce à l'octroi de crédit.

Ce document analyse le rôle joué par la culture attelée dans les systèmes de production de la Basse Casamance. Il repose essentiellement sur des études réalisées sur la question par des chercheurs de l'Equipe de Recherche sur les Systèmes de Production et le Transfert de Technologie en Milieu Rural de Djibélor (Fall, 1984; Sonko, 1985; Ndiamé, 1986). Dans la première section nous faisons une brève présentation de la Basse Casamance et analysons le rôle joué par la culture attelée dans les stratégies paysannes. Dans la deuxième section nous analysons les incidences socio-économiques de la culture attelée dans notre zone d'étude. Finalement, la dernière partie contient nos conclusions et des recommandations pour une amélioration de l'efficacité de la culture attelée en Basse Casamance.

Rôle de la culture attelée dans les stratégies paysannes

Situation

La Basse Casamance est située dans la partie Sud-Ouest du Sénégal et correspond, dans le découpage administratif actuel, à la région de Ziguinchor. Elle présente une grande diversité

Carte 1. La Basse Casamance et ses situations agricoles (Source: Equipe SPT de Djibelor, 1985)

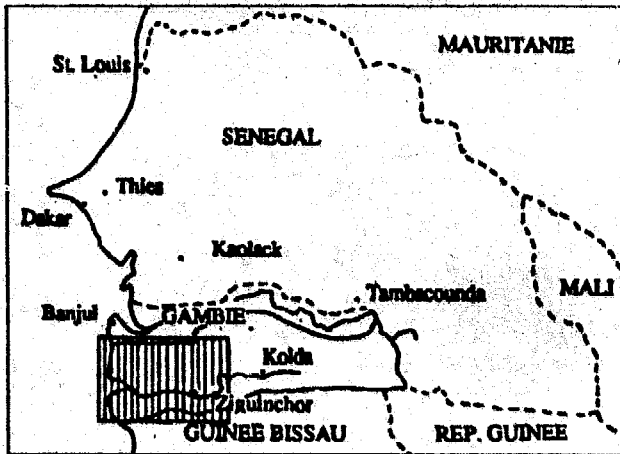

Légende

Zones

1. Organisation sociale type Diola; riz repiqué dominant; pas de traction bovine.
2. Organisation sociale type Diola; riz repiqué et semis direct des céréales important; pas de traction bovine.
3. Organisation sociale type Mandingue dominant; semis direct des céréales dominant; peu de traction bovine.
4. Organisation sociale type Mandingue; semis direct des céréales dominant; bien équipée en traction bovine.
5. Organisation sociale type Diola dominant; riz repiqué et semis direct des céréales important; moyennement équipée en traction bovine.

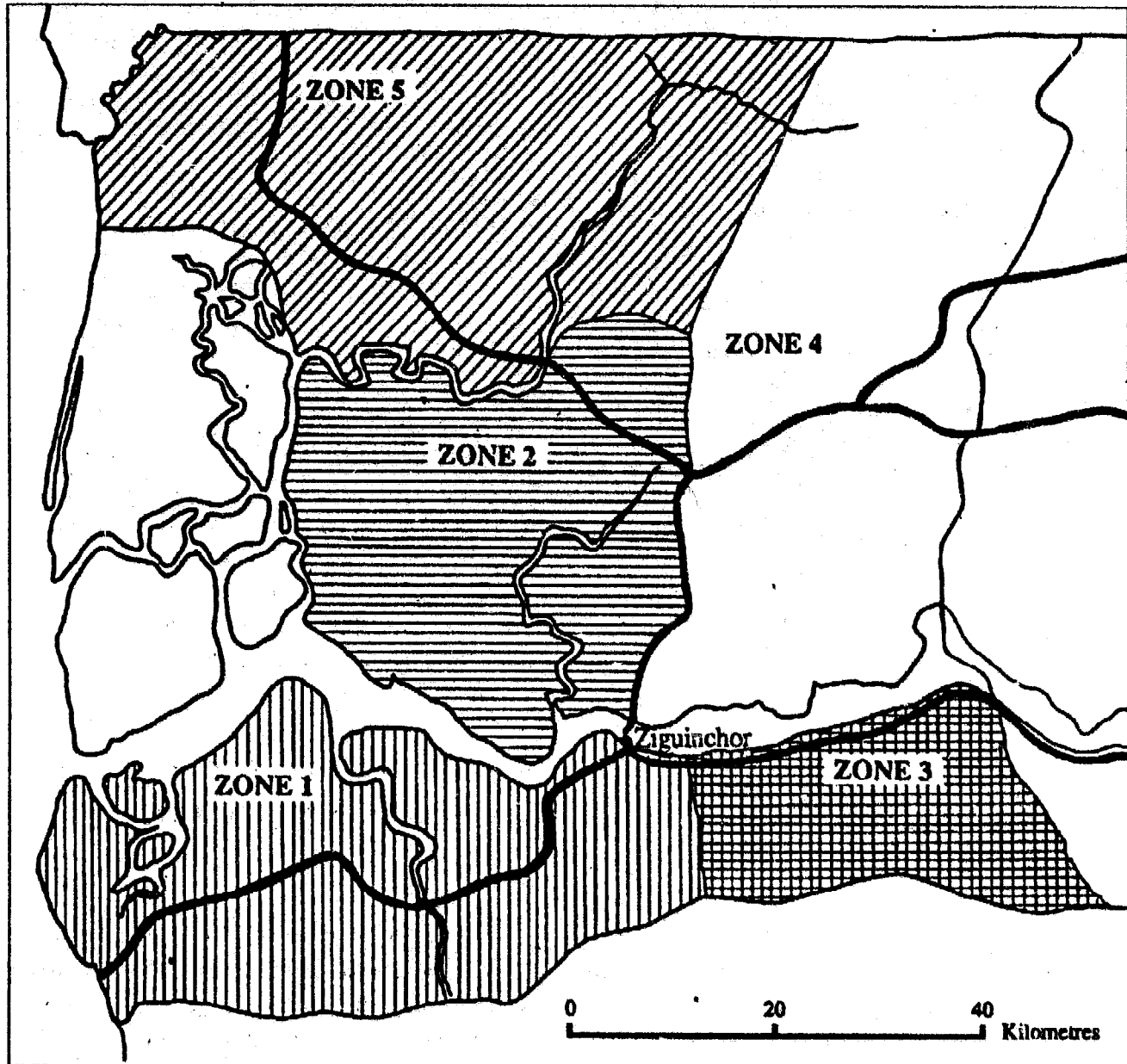

par rapport au peuplement, au climat, aux types de sol et au profil pluviométrique (Posner, 1985). De même, la région se caractérise par l'existence de systèmes de production se distinguant, entre autres, par des différences dans l'organisation de la production. C'est dans ce cadre que se déroule le travail de l'Equipe Systèmes depuis 1982.

Dans le but de mettre au point des itinéraires techniques adaptés aux besoins des paysans de la Basse Casamance, l'Equipe Systèmes a découpé la région en cinq zones homogènes par rapport à des critères agro-socio-économiques. Les trois critères utilisés pour le zonage sont le rapport cultures inondées/cultures exondées, la division sexuelle du travail et l'importance de la culture attelée (cf. carte).

Ce sont dans les zones du Sindian-Kalounayes (IV) et de Diouloulou (V) que la culture attelée est pratiquée. Les deux zones sont également caractérisées par la prépondérance des cultures de plateau en termes de superficies cultivées. Par contre, elles présentent des différences significatives par rapport à la division sexuelle et à l'organisation de la production. En effet, si dans la zone IV c'est une organisation de type Mandingue qui prévaut, dans la zone V nous retrouvons une organisation de type Diola (Equipe Systèmes, 1983; 1984).

De manière schématique, l'organisation Mandingue se distingue par une division du travail suivant la toposéquence: les hommes travaillent sur le plateau tandis que les femmes s'occupent de la vallée. Cette division du travail dans l'espace implique une spécialisation des femmes dans la production du riz, tandis que les hommes se spécialisent dans la production des cultures de plateau: arachide, mil, maïs, etc. Dans ce système, la culture attelée concerne presque exclusivement le plateau. Par contre, dans le système Diola les hommes et les femmes travaillent ensemble sur toute la toposéquence, avec une distribution complémentaire des tâches: les hommes effectuent le labour et les femmes s'occupent du repiquage et du sarclage. L'utilisation de la culture atte-

lée dans ce cadre est plus étalée sur la toposéquence; mais elle dépasse rarement le stade de la préparation du sol.

Les utilisateurs de la culture attelée

Profil des utilisateurs

Des enquêtes menées récemment sur un échantillon de 48 exploitations des zones IV et V ont révélé que la majorité (79%) des utilisateurs de la culture attelée en Basse Casamance ont le statut de chef de concession ou chef de ménages indépendants. La concession correspond à une unité de résidence comprenant un ou plusieurs ménages. Les ménages indépendants correspondent généralement à des cadres de prise de décisions de production et de consommation.

Cette distribution relative du statut des utilisateurs reflète la délimitation des contours des unités de production. En zone Mandingue, la concession correspond à une unité de prise de décisions par rapport aux activités de production en général, de gestion du matériel agricole en particulier. L'aîné du groupe patrilinéaire a un rôle prépondérant en matière de centralisation et de gestion des ressources. Dans le système Diola, par contre, les membres des groupes familiaux se retrouvent librement dans une même enceinte; mais chaque ménage constitue une unité autonome sur le plan agricole, les différents ménages disposent d'une grande autonomie agricole (Diouf, 1984). Les mêmes enquêtes révèlent que l'âge moyen des utilisateurs est de 53 ans, avec un éventail assez large (24 à 75 ans). Le nombre d'années d'expérience avec la traction animale varie de 0 à 25 ans avec une moyenne de 8 ans (Ndiame, 1986).

Les raisons de l'utilisation de la culture attelée

Une majorité de paysans de l'échantillon (79%) effectue la préparation mécanique du sol en raison de sa moindre pénibilité et de la rapidité qu'elle permet. Seule une minorité de

Tableau 1. Circonstances de sortie des animaux de trait

Circonstances	Effectifs(n)	%
Ventes	95	4
Mortalités	52	26
Echanges	14	7
Abattages traditionnels	13	7
Vols	8	4
Retours en confiage	7	3
Départs en confiage (pour dressage)	4	2
Remise au troupeau	4	2
Douaires	2	1
Inconnue	3	2
Total	200	100

Source: Sonko, 1985.

paysans (17%) évoque les possibilités d'accroissement des superficies comme raison de la culture attelée. La moindre pénibilité du travail et la rapidité motivent une proportion importante de l'échantillon (42%) à utiliser le matériel de semis; cependant une proportion équivalente de l'échantillon n'a pas effectuée de semis mécanique. D'ailleurs, un pourcentage plus élevé de l'échantillon (59%) n'a pas utilisé de matériel de sarclage dont l'utilisation reste liée aux mêmes raisons que celles évoquées précédemment. Finalement, la majorité des paysans de l'échantillon (59%) utilise les charrettes en vue de résoudre les problèmes que leur pose le transport du matériel, des intrants et de la récolte (Ndiame, 1986).

En résumé, la quête d'une exécution rapide des opérations culturales et le désir de réduire

Tableau 2. Utilisation des animaux de trait (du 03/06 au 21/08/84)

Espèce	Bovins	Asines
Jours de travail (jours)	32	22
Heures de travail (hrs)	154.5	62
Utilisation (% heures)		
Billonage (%)	31.7	-
Labour (%)	21.2	-
Semis (%)	20.7	64.0
Sarclage (%)	-	22.6
Transport (%)	-	13.4
Hors expl (%)	26.4	-

Source: Sonko, 1985

la pénibilité du travail constituent les raisons les plus fréquentes de l'acquisition du matériel par les paysans de la Basse Casamance. Dans le contexte du déficit pluviométrique et du raccourcissement des saisons de pluie dans la région, la sécurisation d'une production et la réussite de la campagne agricole peuvent dépendre de la rapidité avec laquelle les opérations culturales sont effectuées. Par ailleurs, des études menées sur un échantillon plus large de producteurs de la région ont montré que les nouvelles stratégies de production adoptées par les paysans reposent, en particulier, sur les extensions de superficies sur le plateau et le passage du repiquage au semis direct (Posner *et al.*, 1985). Le matériel agricole joue dans ce cadre un rôle déterminant.

Le matériel agricole et les animaux de trait

Le matériel agricole

Le parc de matériel agricole en Basse Casamance est largement dominé par les matériels de préparation du sol (55%). Ils comprennent:

- *les charrues*: UCF ou ARARA fabriqués par la SISCOMA/SISMAR au Sénégal. Ce type de matériel représente 28% du parc et est généralement localisé dans la zone IV.
- *les butteurs billonneurs*: englobent les butteurs ARARA de la SISCOMA/SISMAR et les butteurs Gambiens. Ils représentent globalement 27% du parc de matériels et constituent le matériel dominant en zone V.
- *Les semoirs*: sont faiblement représentés (10%); le semoir SUPER ECO de la SISCOMA/SISMAR est le type dominant qui a été vulgarisé à travers les différents programmes de crédit. La préparation du sol en billons, couramment effectuée dans la région, limite la diffusion de ce matériel.

- *Les matériels de sarclage*, notamment les houes SINE fabriquées par la SISMAR, existent en nombre très limité et leur progression est également gênée par le mode de préparation du sol en billons. Enfin le matériel de transport, avec 34% du parc représente le type d'équipement le plus fréquemment utilisé après les matériels de préparation du sol.

Les différents programmes de crédit (P.A. et Crédit Spécial du PIDAC) sont les principales sources d'approvisionnement en matériel de culture attelée dans la région; les achats en occasion et l'héritage représentent les autres modes d'acquisition. En raison de leur forte utilisation dans l'exploitation et lors des prestations de services, 50% du matériel de préparation du sol sont potentiellement réformables. Les matériels sont utilisés jusqu'à l'usure de pièces telles que le soc, le contresep, le talon pour la charrue. Les forgerons locaux, qui assurent la maintenance du matériel, sont généralement d'un faible niveau de technicité et ne disposent ni d'outils de travail performants, ni de matières premières de bonne qualité. Néanmoins, le parc ne s'est pas totalement effondré et les matériels les plus utilisés (charrues UCF et butteurs billonneurs) ont des durées de vie allant de 8 à 10 ans (Fall, 1985).

Les animaux de trait

Les espèces animales pour le trait en Basse Casamance sont constituées par:

	(% du cheptel de trait)
Bovins N'Dama trypanotolérants:	91%
Asins	7%
Chevaux	2%
	100%

Les modes d'acquisition des animaux sont divers (achat auprès de tiers, retrait du troupeau extensif, échange contre les petits ruminants, arrivée en confiage, dons, etc.); cependant l'achat des animaux reste dominant (49% du cheptel régional) alors que seuls 29% proviennent du cheptel de l'exploitant. Les animaux sont achetés auprès d'autres agriculteurs (73%

des animaux achetés) et des commerçants Dioula (17% des achats).

L'âge moyen des bovins de trait à l'entrée est de 3 ans et 9 mois (minimum de 2 ans et maximum de 6 ans). Pour les équidés, à 2 ans révolus ils sont utilisés pour le transport agricole. Le dressage est pratiqué environ un mois avant la période de culture (mois de juin) si l'animal est acquis en fin de saison sèche, ou en début de contre-saison (décembre, janvier) si l'animal arrive en fin d'hivernage. On estime qu'environ 70% des animaux enquêtés en 1984 sont en service depuis plus de 6 ans.

Les circonstances dans lesquelles les animaux sont réformés sont diverses et leur importance relative est présentée au tableau 1.

Gestion et utilisations du matériel agricole et des animaux de trait

Gestion

L'acquisition du matériel agricole et des animaux de trait est généralement du ressort du chef d'exploitation qui est l'interlocuteur des institutions de crédit. Leur gestion est placée sous l'autorité du chef de l'exploitation agricole et fait intervenir différents membres de l'unité de production. Le guide, généralement un jeune enfant de 10 à 14 ans, est chargé d'assurer la conduite alimentaire des animaux de trait. Le chef de chantier s'occupe de la maintenance du matériel et décide de l'utilisation des attelages sur les parcelles de cultures. Il organise les différents travaux et détermine les techniques culturales à utiliser en tenant compte de facteurs tels que la main d'oeuvre et la quantité de semences disponibles, le profil pluviométrique, etc. (Sonko, 1985; Fall, 1985).

Utilisations du matériel agricole et des animaux de trait

Les travaux réalisés par les attelages sont constitués par la préparation du sol (labour et/ou billonnage par les bovins, grattage par les équidés), le semis et, dans une moindre proportion,

le sarclage. La stratégie d'utilisation des attelages est fonction de la taille du cheptel en place, de sa composition (bovins, asins, équins) et de l'importance des travaux à exécuter.

Comme indiqué ci-dessus dans le cas d'une exploitation typique opérant dans la zone de l'étude, les bovins sont surtout utilisés pour la préparation du sol et la mise en place des cultures (74% du temps de travail des bovins). On note également l'importance des travaux réalisés hors de l'exploitation dans le cadre des prestations de service et/ou des travaux collectifs. Les asins sont faiblement sollicités durant la campagne agricole, par rapport aux bovins. Leur affectation pour le transport agricole reste très limitée durant cette période pendant laquelle les seules activités de transports consistent à transporter aux champs des semences, le matériel de culture et l'eau pour se désaltérer.

En définitive, la culture attelée reste particulièrement limitée à la mise en place des cul-

tures (préparation du sol et semis). La faible utilisation de l'énergie animale pour le nettoyage est à lier, entre autres, au sous-équipement des exploitations agricoles. Par ailleurs, l'expérience avec la culture attelée constitue un critère important d'utilisation d'une espèce d'animal donnée:

- Pour les équidés, le transport reste leur activité dominante jusqu'à trois ans d'expérience avec les travaux agricoles. Par la suite, ils sont beaucoup plus impliqués dans les travaux de semis et de sarclage.
- Pour les bovins, les plus jeunes sont surtout utilisés pour le labour à plat et le semis; dès leur troisième année, le billonnage devient l'occupation agricole pour laquelle ils sont le plus sollicités.

Le calendrier agricole et l'assolement à mettre en place influencent la stratégie d'utilisation et le mode de constitution des paires. Les figures 1 et 2 (annexe) présentent le schéma de travail déployé au sein de deux concessions au cours de la saison des cultures de l'année 1984. La

Tableau 3 : Analyse des liquidités de deux groupes d'exploitations

PRODUCTIONS AGRICOLES	GRUPE 1 (en culture manuelle)	GRUPE 2 (en culture attelée)
1. Valeur des ventes ^a	112 393	176 457
2. Revenus non agricoles	41 596	56 914
3. Intrants	4 441	9 574
4. Dépenses liées à la T.A. ^b	0	2 000
5. Revenus de la T.A. ^c	0	15 000
6. Revenus nets de la production, (1+2 - 3 - 4+5)	149 549	238 798
7. Achats de nourriture ^d	76 555	72 296
8. Autres dépenses ^e	7 462	15 129
9. Surplus monétaires nets(6-7-8)	65 533	151 371
10. Prêts obtenus	0	0
11. Remboursements	0	55 868
12. Liquidités nettes (9 + 10 - 11)	65 532	93 503

^a Il s'agit des ventes de l'arachide.

^b Cette catégorie se réfère exclusivement aux flux monétaires. Une analyse plus complète des dépenses liées à la traction animale est menée au Point 4

^c Revenus moyens des locations de matériels agricoles.

^d Il est supposé que chaque exploitation-type achète du riz pour combler son déficit céréalier.

^e Calculé sur la base d'un montant de 1.000 Frs par tête. Le montant de la taxe rurale étant de 500 F.CFA par tête, les 500 Frs restants pourraient servir à acheter des médicaments ou des habits.

Source: Ndiarné, 1986

stratégie déployée consiste à utiliser les animaux systématiquement sur

les parcelles de maïs et de mil. Le sol y est préparé en billons et le semis effectué manuellement. Pour ce, les animaux sont associés en paires ayant la même expérience, alors que pour le labour à plat et le semis de l'arachide la constitution de paires avec des animaux d'expériences inégales est largement pratiquée dans les exploitations suivies (Sonko, 1985).

En résumé, l'utilisation de la culture attelée en Basse Casamance reste très inégale dans les différentes zones agricoles. En outre, la stratégie d'utilisation des attelages est liée à divers facteurs dont l'assolement à mettre en place, la composition et la taille du cheptel de trait, l'équipement disponible et l'expérience avec la culture attelée. La durée d'utilisation réelle des animaux reste très faible compte tenu de leurs potentialités; toutefois, la valorisation optimale de l'énergie animale reste liée à divers facteurs internes, dont la cohérence des équipements agricoles.

Incidences socio-économiques de la culture attelée

Les changements induits par l'adoption de la culture attelée

L'analyse est soutenue par des hypothèses sur les effets potentiellement bénéfiques de la technologie sur les performances des exploitations utilisatrices: extension des superficies, augmentation de rendement et gains de temps. Cependant, elle prend en compte la nécessité d'assurer la cohérence technique du paquet technologique qui englobe la culture attelée: utilisation d'intrants complémentaires et pratiques culturales. Elle intègre finalement les contingences particulières des paysans et les problèmes liés à l'environnement de production. Les résultats présentés ici découlent d'enquêtes effectuées en 1985 par l'auteur sur un échantillon de 48 exploitations de la région et de l'analyse comparée des performances de

deux groupes d'exploitations avec et sans traction animale.

La majorité des paysans de l'échantillon ont commencé à utiliser de l'engrais, des semences améliorées et des insecticides avec l'adoption de la traction animale. De même, l'utilisation de la fumure organique, la pratique du labour à plat et du semis en lignes sont devenus plus fréquentes. Par ailleurs, la majorité des paysans enquêtés déclarent avoir augmenté les superficies allouées aux cultures principales du plateau: 90% de l'échantillon pour l'arachide, 65% pour le mil et le maïs. De même, 59 et 52% de l'échantillon estiment qu'il y a eu des augmentations de rendement sur l'arachide et sur le maïs respectivement, du fait surtout de l'exécution rapide des opérations culturales. Enfin, la quasi-totalité des paysans de l'échantillon estiment qu'il y a eu une diminution globale des temps de travaux avec l'adoption de la culture attelée; les gains de temps permettent principalement à la plupart des paysans enquêtés de se reposer, de sarcler ou d'aider les femmes dans les rizières. Les utilisations secondaires sont constituées dans l'ordre décroissant par le sarclage, le repos et les voyages (Ndiamé, 1986).

En résumé, il ressort de ce qui précède la perception qu'on les exploitants de l'impact de la culture attelée sur le système de production. En raison des difficultés à percevoir certaines évolutions (effet-rendement, par exemple) il est utile de compléter les résultats du sondage d'opinion par ceux de l'analyse transversale.

Résultats de l'analyse transversale

L'analyse transversale repose sur des données collectées en 1983 par les chercheurs de l'Equipe Systèmes de Djibélor. Les résultats obtenus dans la zone du Sindian-Kalounayes (IV) montrent que le revenu agricole net par homme-jour s'élève à 761 F.CFA pour les exploitations en culture attelée contre 551 F.CFA pour celles en culture manuelle. Des résultats similaires sont également trouvés pour les

Tableau 4. Rentabilité financière de l'investissement sous différents scénarios

Scénario	Année	Culture	Accroissement de superficie (%)	Accroissement de rendement (%)	Accroissement de revenus F.CFA	Crédit pour animaux de trait	Utilisation de boeufs de trait	Valeur de réforme des animaux de trait	Taux de rentabilité interne (%)
1	6	Arachide	5	2	0	Non	Non	0	-8
2	6	Arachide	10	2	0	Non	Non	0	1
3	6	Arachide	5	2	0	Non	Non	0	
		Mil	5	0					
		Mais	5	0					
		Sorgho	5	0					-6
4	6	Arachide	5	5	0	Non	Non	0	
		Mil	5	5					
		Mais	5	5					
		Sorgho	5	5					
		Riz	0	5					7
5	6	Arachide	10	5	0	Non	Non	0	
		Mil	5	15					
		Mais	5	15					
		Sorgho	5	15					
		Riz	0	15					9
6	6	Arachide	15	5	0	Non	Non	0	
		Mil	10	10					
		Mais	10	10					
		Sorgho	10	10					
		Riz	0	10					14
7	6	Arachide	20	5	0	Non	Non	0	
		Mil	10	10					
		Mais	10	10					
		Sorgho	10	10					
		Riz	0	10					18
8	4	Arachide	5	2	0	Non	Non	0	2
9	4	Arachide	10	2	0	Non	Non	0	14
10	4	Arachide	5	5	0	Non	Non	0	
		Mil	5	5					
		Mais	5	5					
		Sorgho	5	5					
		Riz	0	5					14
11	1	Arachide	5	2	0	Non	Oui	0	-1
12	1	Arachide	5	2	0	Oui	Non	0	-9
13	1	Arachide	5	2	0	Non	Non	80 000	
	1-5				+ 5000				2
14	6	Arachide	5	2	0	Non	Non	0	
	6-10				+ 10 000				1

Source: Ndiame, 1986.

deux catégories d'exploitations dans la zone de Diouloulou (V): 774 F.CFA versus 634 F.CFA (Equipe Systèmes, 1984).

Des tests statistiques effectués sur certaines variables caractéristiques d'exploitations de ni-

veaux d'équipement différents ont cependant montré, qu'hormis la superficie totale cultivée, le rendement d'arachide et les temps de travaux au semis, il n'y avait pas, au seuil de 10%, de différences statistiquement significatives entre les unités de production équipées jus-

qu'au sarclage et celles équipées jusqu'au semis. Du fait des coûts entraînés par l'acquisition et la maintenance du matériel de culture attelée son utilisation doit toutefois se traduire par une augmentation de revenus au moins égale aux dépenses induites; autrement l'adoption de la culture attelée pourrait appauvrir les paysans concernés. Par ailleurs si, comme en Basse Casamance, le matériel est fourni à crédit aux paysans, ce sont les performances réalisées qui déterminent leur capacité à rembourser leurs dettes.

Analyse des comptes de trésorerie

Les résultats de l'analyse menée sur un groupe d'exploitations en culture manuelle et un autre en culture attelée sont présentés au Tableau 3. Les deux groupes d'exploitations ont des liquidités nettes positives de 65 533 et 93503 F.CFA. Cependant les candidats à l'adoption du groupe 1 connaîtraient de sérieux problèmes de trésorerie du fait de la nécessité d'acquérir une paire de boeufs de trait dès la première année. Par conséquent, à moins que ces paysans ne puissent obtenir les animaux autrement (sortie de troupeau, crédit), la culture attelée serait hors de leur portée.

Cependant la provision de crédit ne constitue pas une fin en soi et ne se justifie que si l'investissement dans la culture attelée est financièrement rentable dans le moyen terme. En Basse Casamance, la faiblesse relative des incidences économiques de la culture attelée reflète probablement la situation transitoire des exploitations qui n'ont que partiellement adopté le paquet technologique qui accompagne l'utilisation de la traction animale. Il est donc possible que les avantages maximums apparaissent au fur et à mesure que les paysans acquièrent de l'expérience et adoptent les autres composantes du paquet. L'analyse des budgets pluriannuels permet d'intégrer ces aspects dynamiques de la culture attelée.

Analyse de la rentabilité financière de l'investissement

L'objectif de l'analyse est de présenter des résultats sur la rentabilité financière de la culture attelée en Basse Casamance. L'analyse repose sur une simulation des situations réelles ou possibles des paysans de la région. L'accent est mis sur des éléments plus ou moins contrôlables par les paysans et les responsables de la politique agricole, de manière à isoler des moyens d'améliorations rapides et stables dans l'utilisation de la culture attelée.

La méthode d'analyse coût-bénéfice préconisée par la Banque Mondiale a été utilisée (Gittinger, 1982). Les éléments qui sous-tendent l'élaboration du scénario de base sont présentés en annexe 3. Les résultats de l'analyse sont résumés au tableau 4.

Le premier scénario repose sur une période d'apprentissage de 5 ans au terme duquel des accroissements de superficie et de rendement de 5 et 2% sont supposés sur l'arachide. Il en résulte un taux de rentabilité interne (T.R.I.) de -8% qui est de loin inférieur au taux d'intérêt payé sur les prêts (12%), considéré ici comme une approximation du coût d'opportunité du capital.

Par la suite, certaines hypothèses du scénario de base sont changées en vue de noter les éléments d'amélioration. Sous le scénario 6 le T.R.I. (14%) dépasse le taux d'intérêt (12%); ce cas suppose que les superficies cultivées en maïs, mil et sorgho soient accrues de 10% l'an et que les rendements de ces cultures ainsi que ceux du riz augmentent annuellement de 10% à partir de la 6^{ème} année. En outre, en plus des 10% d'accroissement des superficies cultivées en arachide, les rendements de cette culture sont supposés augmenter de 5% l'an. Le T.R.I. atteint 18% sous le scénario 7 qui ne diffère du précédent que par le plus grand taux d'accroissement des superficies d'arachide (20% contre 15% sous le scénario 6).

Le scénario 1, 2 et 4 ont été réévalués avec l'hypothèse d'une période d'apprentissage de 3 ans au lieu des 5 ans des cas précédents. Pour la première comparaison, le T.R.I. passe de -8% (scénario 1) à 2% (scénario 8). Dans le deuxième cas (scénarios 2 et 9) le T.R.I. est multiplié par 14. Enfin, il passe de 7% à 14% du cas 4 au cas 10. En supposant que l'utilisation d'animaux appartenant à l'exploitation n'entraîne aucun "détournement" de ressources, elle permet une amélioration du T.R.I. de 7% en valeur absolue (scénarios 1 et 11). Par contre, l'octroi de crédit pour l'acquisition d'animaux entraîne une réduction du T.R.I. (-9 contre -8%). Enfin, si après l'achat des animaux le paysan peut les revendre, même à un montant inférieur à leur valeur d'acquisition (80 000 contre 100 000 F.CFA), le T.R.I. est augmenté, en valeur absolue, de 6% par rapport au scénario de base.

Implications sur les améliorations possibles dans l'utilisation de la traction animale

Il ressort de l'analyse que sous les conditions du scénario 1, qui traduisent assez bien la situation actuelle, la plupart des paysans de la Basse Casamance ne pourraient adopter durablement la culture attelée que s'ils bénéficient de subventions. L'essentiel du matériel agricole aujourd'hui présent dans la région avait été mis en place dans le cadre du P.A. dont les dettes étaient épongées en 1980. Il est improbable que des circonstances analogues se présentent dans le futur.

Par ailleurs, même si les superficies cultivées en arachides augmentaient de 100% et que celles des autres cultures de plateau (mil, maïs, sorgho) étaient accrues de 25% chacune au bout de 10 ans, l'investissement dans la culture attelée ne serait toujours pas financièrement rentable. Ce n'est que lorsque les extensions de superficies s'accompagnent d'augmentations de rendement sur les principales cultures que le T.R.I. dépasse le taux d'intérêt. Cela montre l'intérêt d'une intensification progressive des systèmes de cultures en Basse Casamance.

Dans ce cadre, le raccourcissement de la période d'apprentissage a un impact décisif. De meilleures performances sont envisageables si à une plus grande maîtrise technique du matériel les paysans combinaient l'adoption des autres composantes du paquet technologique: semences améliorées, engrais, pratiques culturales, etc. Cependant, pour la plupart des paysans de la Basse Casamance, le niveau relativement élevé des dépenses initiales et les risques financiers qui lui sont associés constitueraient de sérieuses entraves à une adoption globale. Il est toutefois possible que l'obtention de gains financiers rapides et perceptibles augmente l'acceptabilité des dépenses ultérieures. L'existence de supports institutionnels adéquats pourrait être déterminant dans ce cadre.

La réforme des animaux dans des conditions intéressantes constituerait à cet égard une perspective intéressante, d'autant plus que la valeur marchande des boeufs de trait augmente avec leur engraissement au fil des années. Cette option exige cependant certains préalables culturels, techniques et institutionnels pas tout à fait garantis en Basse Casamance: disponibilité régulière et en quantité suffisante d'aliments pour le bétail, soins sanitaires, débouchés, plus grande intégration des troupeaux extensifs dans la production agricole, etc.

Par ailleurs, la recherche et le développement doivent non seulement mettre au point des paquets performants, mais opter pour une vulgarisation progressive, tenant compte de la courbe d'apprentissage et de la capacité des paysans à investir. Une telle démarche permettrait de faire coïncider les investissements les plus importants au moment où l'adoption des composantes de base de la culture attelée augmente la productivité agricole et procure aux paysans des revenus nets plus élevés.

Conclusions et perspectives

La culture attelée constitue un moyen privilégié par lequel les responsables de l'agriculture

régionale cherchent à favoriser l'intensification de la production agricole. Elle joue également un rôle central dans les nouvelles stratégies de production déployées par les paysans de la région en réaction à la baisse de la pluviométrie et au raccourcissement des saisons de pluies survenus en Basse Casamance.

L'utilisation de la culture attelée a favorisé des évolutions dans les techniques et pratiques culturales des paysans de la région et induit certains effets bénéfiques sur les performances des utilisateurs: gains de temps, réduction de la pénibilité du travail, accroissements de superficie, etc. Cependant, son adoption entraîne, entre autres, des charges monétaires que la plupart des paysans en culture manuelle ne pourraient pas assurer. Par ailleurs l'adoption de la culture attelée ne sera viable en Basse Casamance que si elle favorise dans le moyen terme une plus grande intensification de la production et l'augmentation des revenus nets des paysans concernés. Pour cela d'importants soutiens logistiques sont nécessaires (approvisionnement en intrants, maintenance du matériel, entretien des animaux, débouchés, vulgarisations, etc.).

Les recherches menées en Basse Casamance par l'Equipe Systèmes réservent une place importante aux possibilités d'intensification de la production grâce, en particulier, à la culture attelée. Entrent dans ce cadre les actions menées sur les tests de matériel, les modes de préparation du sol, le semis, le saclage, la fertilisation organique et minérale, etc. (Equipe Systèmes, 1983, 1984, 1985). En outre, des études sont en cours sur les circuits de commercialisation de la viande et du bétail, le rôle des forgerons locaux dans la maintenance du matériel. D'autres études visant à améliorer l'état sanitaire et alimentaire des animaux destinés à la vente seront entamées incessamment. Les résultats de ces différentes études pourront fournir des éléments susceptibles d'accroître l'efficacité technico-économique de la culture dans la région. L'équipe sera ainsi en mesure de fournir des recommandations utiles aux

paysans et aux responsables de l'agriculture en Basse Casamance.

Références bibliographiques

- Diouf, M. B. 1984. La Basse Casamance: organisation sociale, système foncier et migration (synthèse bibliographique). Mémoire de confirmation, Département Systèmes, ISRA, Dakar, Sénégal. (unpublished). 91p. (F).
- Fall, A. 1985. Situation actuelle sur l'environnement et l'utilisation du parc de matériel de culture attelée en Basse Casamance. Mémoire de confirmation, Département Systèmes, ISRA, Dakar, Sénégal. (unpublished). 145p. (F).
- Gittinger, J. P. 1982. Economic analysis of agricultural projects. The Economic Development Institute of the World Bank. The Johns Hopkins University Press, Baltimore, USA. (E).
- Ndiamé F. 1986. Aspects économiques de l'utilisation de la traction bovine et de sa promotion par le biais du Crédit Spécial du PIDAC pour le matériel agricole: étude préliminaire dans la région de Ziguinchor. Mémoire de confirmation, Département Systèmes, ISRA, Dakar, Sénégal. (unpublished). 142p. (F).
- Posner, J. L. 1985. Contribution à la connaissance agronomique de la Basse Casamance (synthèse bibliographique). Document de Travail 1985:3, Département Systèmes et Transfert, ISRA, Dakar, Sénégal. 43p. (F).
- Posner, J. L., Kamuanga, M. and Sall, S. 1985. Les systèmes de production en Basse Casamance et les stratégies paysannes face au déficit pluviométrique. Document de travail. Equipe Systèmes de Djibélor, ISRA, Sénégal. (F).
- Sall, S., Posner, J. L., Kamuanga, M., and Lo, M. 1983. La recherche sur les systèmes de production en Basse Casamance: campagne agricole 1982/1983. Rapport annuel. Département Systèmes et Transfert, ISRA, Dakar, Sénégal. 109p. (F).
- Sall, S., Posner, J. L., Kamuanga, M., Lo, M., Diouf, M. B. and Sonko, M. L. 1985. La recherche sur les systèmes de production en Basse Casamance: campagne agricole 1983/1984. Rapport annuel. Département Systèmes et Transfert, ISRA, Dakar, Sénégal. 149p. (F).
- Sonko, M. L. 1985. Les systèmes d'élevage en Basse Casamance: bilan des connaissances acquises et étude monographique des systèmes d'élevage à Boulador (Kalounayes). Mémoire de confirmation, Département Systèmes, ISRA, Dakar, Sénégal. (unpublished). 149p. (F).
- Sonko, M. L. 1985. La traction animale et le travail animal au Sénégal: le cas du Nord-Est de la Basse Casamance. Document de Travail, Département Systèmes et Transfert, ISRA, Dakar, Sénégal. (F).
- Sonko, M. L. and Fall, A. 1986. L'utilisation des animaux de trait en Basse Casamance. ISRA/Département Systèmes. (Etude en cours) (F).
- Sonko, M. L. 1986. Les contraintes zootechniques de la traction animale en Basse Casamance. ISRA/Département Systèmes. (Etude en cours). (F).

Title photograph (opposite)
Farmers plowing "boliland" at Karina, Sierra Leone, with N'Dama oxen pulling an old "Victory" plow
(Photo: Paul Starkey)

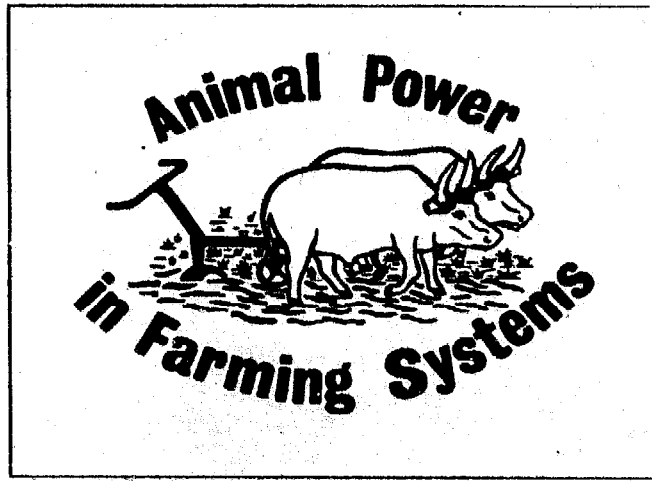

Animal Power in Sierra Leone and Liberia



Animal traction development strategies in Sierra Leone

by

Bai H. Kanu

Project Coordinator, Sierra Leone Work Oxen Project

Abstract

Farmers started working with work oxen in Sierra Leone in 1929. Limited animal traction extension schemes were developed from 1930-1956. Small numbers of farmers continued to use oxen for plowing for many years without government inputs. This encouraging persistence is attributed to the services of village blacksmiths and traditional animal health practices.

Constraints to the development of work oxen in Sierra Leone include the uneven ownership and distribution of cattle, disease, the presence of stumps in most cultivated land, low farm incomes relative to the cost of animals and implements and the general economic situation. Agricultural labour is limited and cannot easily absorb the labour shifts related to ox plowing.

Renewed interest in draft animals led the Ministry of Agriculture, Natural Resources and Forestry (MANR&F) to set up the Sierra Leone Work Oxen Project in cooperation with the Njala University College. For the past six years the Project has received support of British and French sources. It now comprises a Coordinator, seven field officers (assisted by six expatriates) and sixty intermediate and junior staff. It is shortly to be incorporated as a permanent programme of the Ministry.

The Work Oxen Project is working to develop animal traction through research, training, publicity, equipment testing and implement production. About 500 plows have been fabricated at the Rolako Oxen Centre. Most have been of the Pecotool type which provides efficient soil inversion and can act as a multipurpose toolbar. The project has been carrying out on-station and on-farm research on animal traction. Socio-economic studies in the Mabole Valley indicate there

are 150 pairs of oxen, which work about 40 days each year, mainly for plowing. 70% of their time is for rice production, and 28% for millet and groundnuts. Data suggests oxen lead to a reduction in labour input per unit area and an increase in the area cropped.

The Project has assisted the establishment of farmers' associations for using work oxen. One of the schemes experienced relatively high mortality, which was attributed to poor husbandry, limited supervision, inadequate health services, limited grazing hours, and the fact that farmers gave priority to other enterprises. In the more successful schemes farmers have started buying oxen for themselves and village ox carts are increasing, but no farmer has started to use oxen for planting or weeding.

The project has assisted the Integrated Agricultural Development Projects (IADPs) and other organizations to develop their own work oxen programmes. One of the more successful has been Koinadugu LADP where numbers of oxen have increased from 74 to 250 pairs. They are used mainly for plowing, working only 34 days per year. Success is attributed to a study of the farming systems and a pace slow enough to allow careful selection of loan farmers and full extension back-up. Other programmes include Magbosi and North Western LADPs, Tikonko Agricultural Extension Centre and the Swamp Rice Project. As a result of the various schemes, numbers of work oxen in Sierra Leone have increased from 30 pairs in 1980 to 500 pairs in 1985.

Background

Farmers started working with work oxen in Sierra Leone in 1929. This was due to the abolition of the domestic slave practice which

created an acute agricultural labour shortage. The then colonial government decided to send trainees to neighbouring Guinea for them to be trained in animal power techniques. These trainees then returned and were distributed to the various stations of the agricultural department to train farmers and to develop animal traction. Limited animal traction extension schemes were developed from 1930-1956. The use of work oxen in rice cultivation was found to be successful, but the potential for animal traction was never properly developed due to emphasis on tractor hire schemes, unavailability of ox-implements, poor animal health services, and other constraints. However ox traction programmes have continued with very little government input. The persistence of animal traction was possible due to the services of village blacksmiths, who maintained and repaired plows, and to the farmers' use of traditional animal health practices to cure the oxen.

Renewed interest in the potential of draft animals led the Ministry of Agriculture and Natural Resources to set up a national programme to investigate and develop the use of work oxen in the country (Starkey, 1981). For the past six years, the Sierra Leone Work Oxen Project in cooperation with the Njala University College and with the support of British and French Technical Assistance has been carrying out research on the potential for using draft animals in Sierra Leone. In cooperation with the Integrated Agricultural Development Projects (IADPs) and non-governmental organizations (NGOs) it has initiated and coordinated the development of pilot extension programmes. The results of the on-station and on-farm research and socio-economic studies, together with the success of pilot extension programmes and the persistence of the use of draft animals for over 30 years in the Bombali and Koinadugu Districts, have led to the conclusion that animal traction has a distinct role to play in the agriculture of Sierra Leone. In particular oxen can be used for plowing in various soil types and ecological conditions. They

can also be used for weeding, for ridging and for transport, and work oxen are a valuable means of encouraging integrated farming and good animal husbandry among crop farmers (Starkey and Kanu, 1985).

Animal traction potential in Sierra Leone

Through on-station and on-farm trials at Njala and Mabile Valley, it has been shown that work oxen can be successfully used in upland soils for the cultivation of rice, groundnuts, millet and cowpeas. They can also be effectively used for growing rice in swamps and in bolilands (bolilands or bolis are flat grasslands with poor soils that flood for one to four weeks every year). Work oxen can be used for primary cultivation (plowing) and for harrowing, seeding, weeding and groundnut lifting. They can also be used for the plowing, puddling and levelling of rice swamps and for making ridges for tuber crop production. In addition, work oxen can give the Sierra Leonean farmer the opportunity to earn non-agricultural income through transport and hiring out. Finally, given an appropriate animal-powered gear system, oxen may be able to perform other important activities such as water pumping, threshing, cassava grating and milling.

About 333,000 N'Dama cattle are found in Sierra Leone. In addition about 34,000 cattle a year are brought across the frontiers into Sierra Leone to the cattle markets. The N'Dama is the most appropriate breed for the Sierra Leone conditions, particularly as it has trypanotolerant characteristics. N'Dama cattle can be utilized for draft purposes with little or no adverse effects on the local meat industry.

Work oxen afford the opportunity to integrate livestock and crop farming, allowing the farmer to appreciate the reciprocal advantages of both, for example the use of crop residues for animal feed and the use of dung to manure the crops. The integration of crops and livestock implies the management of grazing areas

at village level. In view of the often hostile relationship between livestock and crop farmers, such integration could help to facilitate agreements on grazing arrangements, a subject which has previously inhibited the integration of crop and livestock systems.

Previous experience of ox traction (largely for plowing) in both the Koinadugu District and in the Mabole Valley has been favourable. Farmers have increased their cultivated area and hired out their oxen to neighbouring farms. The oxen are appreciating assets through live-weight gain and their subsequent sale for meat. Previously introduced implements have had a long, useful life and local blacksmiths have shown some capacity for repair and replacement of worn plow shares (Metianu and Vose, 1986).

Constraints to animal traction

Cattle distribution in Sierra Leone is such that the majority of the cattle (more than 80%) are located in the north and tend to be owned by the pastoral Fulah ethnic group, who perform only limited cropping. Although they are trypanotolerant, N'Dama oxen are prone to disease if put under stress. Health risks appear greater towards the south of the country, and if oxen are exposed to poor animal management practices.

The use of oxen is presently limited to plowing largely on swamp land with some upland plowing and harrowing and some use of ox carts. Most upland areas, however, are not currently suitable for ox plowing due to stumps and rocks which are not removed under existing farming systems. Use of oxen for other operations remains largely untested by farmers due to the major changes required in farming systems, including row planting, row weeding or ridge cultivation.

Labour is a limiting factor in Sierra Leone agriculture, because of the movement of many able-bodied people to urban and mining areas. As a result, in the villages the farmers are

generally quite old. Using work oxen for plowing releases labour at this stage but shifts the labour bottleneck to the weeding stage, and subsequently to harvesting (Kanu, 1984).

The adoption of animal traction is constrained by the state of the rural economy. Average farm incomes are small and very low relative to the initial investment required to purchase implements and oxen. Implements at present available in Sierra Leone are either imported or largely constructed of imported raw materials, and the foreign exchange required for these is in very scarce supply. This is exacerbated by the currency exchange rates, which have effectively depressed farm incomes through low farm produce prices.

The role of the Work Oxen Project

The Sierra Leone Work Oxen Project, in its effort to develop animal traction, has been performing the following activities:

- Organization of village associations for the keeping of work oxen.
- Carrying out on-station and on-farm demonstration trials.
- Training of work oxen and farmers in the villages.
- Catalysing the Integrated Agricultural Development Projects (IADPs) and other institutions and NGOs to develop their own work oxen programmes.
- Participating in agricultural shows and organizing national ox-plowing competitions.
- Equipment production and testing.

The Work Oxen Project is under the leadership of a Project Coordinator responsible for project management and administration. In the project there are seven field officers, assisted by six expatriates. There are sixty junior and intermediate workers in the field and on various stations. Some IADPs have trained their staff in collaboration with the WOP. In the near future, Work Oxen Project staff

should be incorporated into the National Work Oxen Programme of the Ministry of Agriculture, National Resources and Forestry. To ensure project staff are confident at handling animals and familiar with the practicalities of using work oxen, even senior project staff must train a pair of oxen before they are confirmed as full officers (SLWOP, 1986).

The British Overseas Development Administration (ODA) has for several years provided Technical Cooperation Officers (TCOs), together with supporting facilities. At the moment there is one TCO in the project helping in extension and management. Much of the capital assistance and equipment for the project comes from ODA. The French organization AFVP (Association française des volontaires du progrès) has provided the services of four technical volunteers, together with supporting facilities. The French organization CFCF (Comité français contre la faim) has been providing the project with funds and equipment for organizing village associations. The German organization GTZ has provided funds and a consultant for the installation of prototype animal-powered gear systems for water pumping and crop processing.

Through the catalytic role of the Work Oxen Project with the IADPs and other organizations and institutions, several work oxen schemes have been organized and these have helped to develop ox traction in the country. This is evident by the increase in the numbers of work oxen in the country from 30 pairs in 1980, to 500 pairs by the end of 1985. A description of these various schemes follows.

Work oxen schemes: problems and achievements

Mabole Valley Scheme

The Mabole Valley is situated within a transitional area of interior plains with bolilands and savannah mountains and plateaux. The major farming systems include the cultivation

of a combination of upland, boliland and inland valley swamp rice varieties and also some groundnuts.

Some ox plowing has continued since it was first introduced in the 1930s. The area is the major extension target of the WOP, being located close to Rolako Oxen Centre. There are approximately 150 sets of oxen in the area. A survey carried out by a French volunteer in 1984 reported that the 44 oxen sets studied were used for an average of just over 40 days each year (Allagnat and Koroma, 1984). 45% of this time was spent plowing inland valleys for swamp rice, 22% was spent on boliland rice and only 4% on upland rice. Other crops for which oxen were used for plowing included millet (15% of their time) and groundnuts (13%). Responsibility for the oxen was mainly given to young boys. The major result of using oxen was to reduce the labour input per unit area and increase the area cropped (up to 1.2 hectares). Land is not limiting, being available to farmers on payment of a nominal rent of up to Le2 ha⁻¹. (Note: the local currency, the Leone, has changed greatly in value in recent years, so that international comparisons are difficult. At the time of the survey in 1983/4, Le1 = US\$0.17. At the time the Networkshop for which this paper has been prepared, Le1 = US\$0.05.)

The survey also made an in-depth analysis of five farm households, two of which owned oxen. The major cost input for crop production was hired labour, which accounted for up to 80% of total costs. Farmers using oxen were able to meet all their labour requirements for land preparation without hiring labour. Farmers hiring oxen were able to reduce their land preparation costs per hectare by about 35% (from Le267 to Le178). However in all farms the overall gross margins and net farm incomes were small. A large farm of 13 hectares produced a gross margin of only Le2,750 from crop production. Its net farm income was Le4,500, including sales of palm wine and cattle (Allagnat and Koroma, 1984).

Farmers' associations for work oxen

The French organization CFCF has been funding various farmers' associations throughout the country. About twelve of these associations have already been organized. Funds from the CFCF are allocated to the associations according to certain criteria such as the animal traction experience in the area, the economic status of the farmers in the association and the philosophy of the project officer organizing the associations. In some cases, for example where farmers have no knowledge of animal traction but it seems to have great potential, the initial cost of funding the association to allow the purchase of oxen and equipment is provided free, with very little financial contribution by the farmers. In other cases farmers contribute one half of the initial cost.

The associations are organized with two main objectives:

- to introduce oxen in the area through group ownership, so that individual farmers when convinced about the economic importance of the technology can easily buy oxen and equipment for themselves.
- to introduce the use of work oxen for additional farm operations, such as row planting, weeding, groundnut lifting, ridging and transport.

After two years of existence of these associations, results so far have shown:

- Some farmers from the associations have started buying oxen for themselves.
- No farmer has yet started to use oxen for the new cropping operations such as planting and weeding.
- Village transport using oxen is becoming increasingly important and the demand for ox carts is quite high. In one of the villages, the ox cart is used as an ambulance to transport sick people to the nearby clinic; it is also used to transport the chief to nearby villages.

The constraints experienced so far in organizing these associations include:

- Some farmers tend to depend too heavily on the project to provide them with the oxen and equipment.
- There is sometimes poor management of the animals and equipment, and this is especially a problem if somebody with high village status does not participate fully in the association's activities.
- Associations have found it difficult to assign or employ permanent ox-handlers who could then be fully responsible for the day-to-day management of the oxen.

Rolako Station and Oxen Centre

Rolako Rice Station is an establishment of the Ministry of Agriculture, Natural Resources and Forestry (MANR&F) located among bolidays near the centre of the country. It is situated about 200 kilometres along the main road from Freetown (the capital) to the Sierra Leone hinterlands. The station was constructed in 1974 by the Chinese, with a workshop equipped for the maintenance of agricultural machines and adjacent buildings with extensive storage facilities. The facilities at Rolako were underutilized for many years, until it became clear that the station was well suited to become a national work oxen centre. It is situated near the Mabile Valley, an area with great potential and where oxen are quite widely used. Rolako is also on the main road to Kabala, headquarters of the EEC-funded Koinadugu Integrated Agricultural Development Project (KIADP) which is firmly committed to the development of ox-traction programmes.

Thus the Rolako Oxen Centre was set up in 1982 at Rolako Station and it became the professional headquarters of the Sierra Leone Work Oxen Project. A senior Project Officer responsible for extension and training is in charge of the station. Present activities in the station include:

- Equipment production and testing.

- Training for project staff, extension workers and ox-farmers.
- The demonstration of work oxen operations with various crops, including rice, groundnuts, maize and cowpeas. Also the evaluation and demonstration of animal-powered gears for rice milling, cassava grating and water pumping.

In order to allow the existing facilities to be utilized for the production of animal traction equipment, the workshop was partially re-equipped in 1982, with funds made available from the European Development Fund (EDF). The objective was to enable the workshop:

- to produce plows and other ox-drawn equipment to meet local demand
- to maintain existing plows by ensuring the availability of spare parts and repair facilities
- to modify and design new ox-drawn equipment for testing and evaluation.

The ox equipment workshop was initially set up to assemble plows imported in kit form, or to fabricate them from steel supplied in partially cut form by an overseas manufacturer. The workshop has been equipped with a press, profile-cutter, lathe, grinders, drills and blacksmith forges. The power supply has been from 50-kW and 10-kW generators, and a stand-by portable generator is also available. To date, all imported materials have been provided by aid donors. Table 1 shows the origin, date and type of plow assembled at the workshop.

Table 1. Numbers and origin of plows assembled at Rolako

Year	Donor agency	Plow type	No.
1983	EDF & KIADP	Pecotool	100
1983	France	Bourguinon	40
1984	Plan International	Pecotool	150
1984	Canada	Pecotool	100
1984	FAO	Victory	20
1986	ODA	Pecotool	100
TOTAL			510

On the basis of the research at Njala University College and on-farm testing in several villages, the Pecotool was selected as the most appropriate implement to be made available to farmers. This was because of its simplicity in terms of adjustment and handling and efficiency in soil inversion. Its helicoidal mould-board was found to invert the soil well. It could be used as a 6" (15 cm) or 9" (22 cm) plow and could function as a multipurpose toolbar since a seeder, weeding tines or a ridger could be used in place of a plow body. Farmer reaction had suggested that implement efficiency and quality were more important than price, so that costs were not considered as the major criterion for equipment selection.

The Cows and Plows Scheme

Since 1983, the Work Oxen Project has provided technical advice to the charitable organization Plan International, which has been funding the introduction of work oxen into new villages in the Bombali District. Thirty-two sets of oxen were introduced to thirty village groups within a twenty-mile radius of Makeni in the Plan International operational area.

The objectives of the scheme were:

- To introduce work oxen technology to the Plan-supported villages.
- To train farmers in work oxen technology.
- To organize the Plan villages into committees (associations) in order to manage the ox unit and other agricultural inputs.
- To cultivate 160 ha of swamps and upland fields with oxen within the Plan communities.
- To demonstrate the economics of using work oxen technology.

30 village committees (associations) were organized. Each committee appointed an executive comprising a chairman, secretary, treasurer and an overseer and also provided three ox-handlers to take care of the oxen. The first

set of 20 ox-trainers were trained at Rolako Station and the rest were trained in their respective villages. The philosophy of Plan International involves its endeavouring to help the very poor by providing free assistance. Therefore work oxen and equipment were provided during the first year free of charge, and the association members only had to pay a modest plowing fee for two days (this was Le10/00 per day's work in 1984).

The scheme encountered some problems. In particular some committees lacked the ability to manage their work oxen units, and this led to a relatively high mortality rate, involving ten sets out of the total 32 pairs of oxen distributed in the various Plan villages. Reasons for the deaths were generally related to poor husbandry practices such as limited grazing hours, overworking of the oxen, and provision of poor living conditions in the paddocks. Reasons for these may have been attributable to:

- The Plan International philosophy of giving freely to the very poor meant that some of the committees could not cope with the responsibility of taking care of the oxen, especially during the off-farming season. In some cases it was lack of management skills and in other cases farmers (who had not invested their own money in the oxen) gave priority to other activities.
- In some villages, other socially or economically important activities clashed with the need for supervising the work oxen, and the oxen did not have sufficient time to graze. For example some ox-handlers neglected the care of their oxen during the period when the traditional secret societies were most active. In other cases the key morning hours (from 07.00 to 10.00) were required for tapping palm trees for palm-wine, which provides Limba farmers with a very important source of income.
- The supervision by the Work Oxen Project staff was not very efficient, as indicated by the poor state of some paddocks and the overworking of some animals. Part of this

Table 2. Growth in work oxen activities in KIADP from 1983-1985

Year	Pairs of Oxen	Area plowed
1983	74	450 ha
1984	154	935 ha
1985	250 (estimated)	1518 ha

Source: *KIADP Monitoring and Evaluation Unit (1985)*

could be attributed to the limitations of transport and fuel.

- Animal health services were poor. Some of the oxen died (or the farmers were advised to slaughter them) simply because the Veterinary Department lacked the drugs or equipment to rescue the situation.

The Integrated Agricultural Development Projects (IADPs)

The Integrated Agricultural Development Projects (IADPs) are major rural development programmes and the Work Oxen Project assists them by playing a catalytic role. In particular the Work Oxen Project provides technical information on animal traction and animal-drawn implements and helps the IADPs set up their ox-units through advice and staff training.

Koinadugu IADP and Musaia Ox Unit

The Musaia Ox Unit is part of the Livestock Division of the Koinadugu Integrated Agricultural Development Project (KIADP). The ox unit performs the following activities:

- Extension and the training of oxen and farmers in the villages.
- On-station demonstrations using work oxen to perform various cultivation operations for crops such as rice, cassava, maize and cow-peas.
- Socio-economic surveys on animal traction farmers.

- Monitoring and evaluating the work oxen scheme.
- Providing animal health services for oxen owners.

Work oxen technology has rapidly developed in the KIADP area, as illustrated in Table 2.

Oxen in the KIADP area are used mainly for primary cultivation (plowing) and for harrowing. Oxen are used for the cultivation of rice (swamp and boli varieties), millet, groundnuts and maize. Monitoring and evaluation reports show that, on average, oxen are used for work only 34 days per working season, including 15 days when they are hired out to other farmers. The average hiring fee is Le30 per day, and the ox-owners consider such income to be very significant. The 34 working days include work on two or three different crops, and the reason reported by most farmers for the low usage of the oxen is that they do not have more land that is suitable for plowing with their oxen.

In comparison with other animal traction programmes in the country, the Musaiia Ox Unit is very successful, especially in terms of increase in numbers of oxen per year. The farmers have received the technology with great enthusiasm, but there is a lot to be done by the KIADP work oxen extension personnel to ensure that the technology is used more efficiently and economically. At the moment, the use of oxen

is limited almost entirely to plowing and harrowing. Other recommended uses of work oxen in the KIADP area include transport, ridge making, and the use of animal-powered gears for rice milling or for water pumping to allow irrigated swamp cultivation in the dry season.

Since 1984, KIADP has been involved in plow supply, and credit has been given for plow purchase, for oxen or for both. The terms of the loan include interest at 15% and a repayment period of four seasons. Repayment rates were very high for 1984 (97%) and apparently high for 1985 (loans are still being collected). The project placed considerable emphasis on careful choice of loan recipients with prior approval from village elders. A summary of some of the loans is given in Table 3.

The Musaiia Ox Unit has been successful for two main reasons. Firstly the programme was based on a comprehensive study of the techniques used in the local farming systems, so that its recommendations satisfy the requirements of the farmers and their crops. Secondly it has had a relatively slow pace of development. This has allowed careful selection of the loan farmers, detailed training and the provision of proper extension follow-up.

The KIADP has room for improvement, and it is recommended that the KIADP management

Table 3. Summary of KIADP Work Oxen Loan Scheme 1984-1986

Year	Loan ¹ (Le)	Plow cost ² (Le)	Oxen cost ³ (Le)	No. of recipients ⁴			Total
				Cash only	Plow only	Both	
1984	1500	250	1400	12	14	24	50
1985	1800	500	1400	15	4	33	52
1986	2800	850	2100				

Notes:

1. Maximum loan available per recipient.

2. Plow prices are those quoted by Work Oxen Project for the Pecotool.

3. Oxen costs in the Koinadugu District are based on a pair purchased at 160 kg each at a price of Le4.40 kg⁻¹ in 1984-5 and Le6.60 kg⁻¹ in 1986.

4. 1986 loan yet to be implemented.

Table 4. Distribution of oxen in Sierra Leone (January 1986)

Location	Project	Number of pairs	Ownership
NORTHERN PROVINCE			
Koinadugu	IADP	250	Individuals & groups
Koinadugu (Fadugu)	WOP	18	Individual
Mabole Valley (Bombali)	WOP	150	Individuals & groups
Seed Multiplication (Bombali)	SMP	1	Project
Cows and Plows (Bombali)	PLAN/WOP	25	Groups
Rolako (Bombali)	WOP	3	Station
Port Loko	WOP	3	Groups & station
Bumbuna/Mapaki	Catholic Mission	3	Mission
Magbosi	IADP	9	Groups & project
North West	IADP	2	Project
Rice Research Station	Institution	2	Institution
Seed Multiplication (Kobia)	SMP	2	Project
Gbendembu School	Institution	1	Institution
Lunsar School	ARCB	2	Institution
Bafodia	Mission	5	Mission
Subtotal: Northern Province		478	
SOUTHERN PROVINCE			
Njala	WOP/NUC	9	Various
Moyamba	FAO	3	Project
Tikonko	Methodist Church	5	Project
Pujehun	SAIDAC	6	Institution
Subtotal: Southern Province		24	
EASTERN PROVINCE			
Kenema	SMP	2	Project
Foindu	WOP	1	Group
Subtotal: Eastern Province		3	
WESTERN AREA			
Newton	WOP	2	Individuals
Pa Lokko	PLAN/UMC	2	Institution
Subtotal: Western Area		4	
GRAND TOTAL (SIERRA LEONE)		509	

should put more resources (notably transport) at the disposal of the ox unit. The ox unit should adopt a staffing policy in line with the national programme, so that expatriates should have counterparts of a comparable level of training. Finally more on-farm and on-station demonstrations should be organized to encourage diversification of work oxen oper-

ations. This would enable draft animals to be efficiently and economically used by the farmers.

Magbosi IADP

Magbosi IADP started its draft animal programme in 1984 with great enthusiasm, and in

close cooperation with the Work Oxen Project. Six pairs of oxen have been trained for village demonstrations, and a pilot hire scheme has been started in the various chiefdoms in the project area. Six of its extension workers were given specialized training by the Work Oxen Project, both at Njala University College and in ox-using villages in the Bombali District. A large-scale ox-programme is to be started in early 1987 by the Project through funds from IFAD.

North Western IADP

The NWIADP based at Kambia has started a pilot draft animal programme in cooperation with the Work Oxen Project. The Work Oxen Project sent two of its field staff to train the NWIADP field staff in work oxen techniques and to assist the training of two sets of oxen. The programme at present is on an experimental basis comparing work oxen to power tillers for working in inland valley swamps. There are now funds available for training and distribution of 25 sets of oxen and equipment to farmers' groups and individuals. The NWIADP project area has been extended into the Port Loko District with finance from the EEC. An ox-unit component proposal has been incorporated into the project document, and its implementation is to start at any time. In the first year, twelve sets are to be trained and distributed to farmers' groups and twenty-four sets in the following year.

Tikonko Agricultural Extension Centre (TAEC)

TAEC is based in Bo in the Southern Province and it is developing animal traction in the villages around Tikonko. Six sets of oxen are working in the centre and the surrounding villages. The centre has developed a wooden ox cart that has both wheels and its bearings made of wood. The cart has been tested in the TAEC operational areas and the Work Oxen Project

has ordered one for trial at the Mabile Valley. TAEC is also training oxen and staff for SAIDAC (Southern Agro-Industrial Development and Agricultural Centre). This institution has distributed six sets of oxen in the Pujehun District on a hiring basis to farmers. There is great potential for ox-traction in the Pujehun District since there are a number of large but widely separated cattle ranches in the area and extensive bolilands and inland valley swamps.

Other projects and organizations

MANR/FAO Swamp Rice Project started an ox unit this year in the Moyamba District in the Southern Province. A Peace Corps volunteer is responsible for the ox unit with two Work Oxen Project field staff. The project is organizing farmers' associations for using work oxen for swamp cultivation. A demonstration pair of oxen at Waterloo Village is doing well and this has boosted the interest of farmers' and the project. For the next two years the project will introduce seven sets of oxen through the farmers' associations. Thirty farmers associations are expected to be organized using both work oxen and power tillers. Comparisons of both work oxen and power tillers will be made, considering aspects such as adaptability, economics, availability of spare parts and social aspects. Farmers in this area are not used to cattle husbandry, although they have been working with power tillers for some time. Useful reports are to be expected from this project.

Other organizations using work oxen are the Seed Multiplication Project and the Rice Research Station at Rokupr. These institutions use work oxen in their respective centres for the cultivation of inland valley swamps. The staff of these institutions were trained by the Work Oxen Project.

Table 4 provides a summary of the distribution of work oxen by location, together with an indication of the promoting organizations.

References

- Allagnat, P. and Koroma, B. 1984. Socio-economic survey of the use of ox traction in the Mabole Valley, Bombali District. Sierra Leone Work Oxen Project and Association française des Volontaires du Progrès, Freetown, Sierra Leone. 119p. (E,F).
- Kanu, B. H. 1984. The economics of work oxen in Sierra Leone. Sierra Leone Work Oxen Project, Freetown, Sierra Leone. (unpublished). (E).
- KIADP 1985. Monitoring and Evaluation Reports of Musaia Ox Unit. Koinadugu Integrated Agricultural Development Project, Kabala, Sierra Leone. (unpublished). (E).
- Metiane, A. A. and Vose, D. 1986. Report of visit to Sierra Leone in January 1986 to study the viability of the Work Oxen Project. Overseas Division, National Institute of Agricultural Engineering (NIAE), Silsoe, UK. (unpublished). (E).
- SLWOP 1986. Report of the Project Coordinator. Sierra Leone Work Oxen Project, Freetown, Sierra Leone. (unpublished). (E).
- Starkey, P. H. 1981. Farming with work oxen in Sierra Leone. Ministry of Agriculture, Freetown, Sierra Leone. 88p. (E).
- Starkey, P. H. and Kanu, B. H. 1985. Animal traction in Sierra Leone. pp. 35-36 in: Poats, S. et al. (Editors), Animal traction in a farming systems perspective. Proceedings of Networkshop held March 1985, Kara, Togo. Network Report 1, Farming Systems Support Project, University of Florida, Gainesville, USA. 187p. (E,F).

EEC	European Economic Community
FAO	Food and Agricultural Organization of the United Nations
IADP	Integrated Agricultural Development Project
IFAD	International Fund for Agricultural Development
KIADP	Koinadugu Integrated Agricultural Development Project
MANR&F	Ministry of Agriculture, Natural Resources & Forestry
MIADP	Magbosi Integrated Agricultural Development Project
NGO	Non-governmental organization
NUC	Njala University College
NWIADP	North Western Integrated Agricultural Development Project
ODA	Overseas Development Administration (UK)
SAIDAC	Southern Agro-Industrial Development and Agricultural Centre
SMP	Seed Multiplication Project
TAEC	Tikonko Agricultural Extension Centre
TCO	Technical Cooperation Officer
UK	United Kingdom
UMC	United Methodist Church
WOP	Work Oxen Project
Bolis	Bolilands are flat grasslands with poor soils that flood for one to four weeks every year.
Le	Leone, the local currency. The Leone has changed greatly in value in recent years, so that international comparisons are very difficult. In 1983/4 (a period to which some of the figures refer), Le1 = US\$0.17. At the time of the Networkshop in 1986, Le1 = US\$0.05.

Abbreviations and local terms

AFVP	Association française des volontaires du progrès
ARCB	Agricultural Rehabilitation Centre for the Blind
CFCF	Comité français contre la faim
EDF	European Development Fund

The role of work oxen in swamp development in Sierra Leone

by

Scott Leaman

Peace Corps Volunteer, FAO Swamp Rice Development Project, Moyamba, Sierra Leone

Abstract

Sierra Leone is a net importer of its staple food, rice. Many programmes to increase rice production have been implemented with limited success. Present policies emphasize the development of inland valley swamps. Most farming in Sierra Leone is based on upland soils, with some cultivation of small portions of rain-fed swamps. The traditional methods of swamp rice farming have evolved over centuries, using no fertilizers, low management, long-duration rice varieties and minimal soil preparation. Some systems are based on transplanting, others on broadcasting.

Development agencies in Sierra Leone have tried to raise yields using an "Asian model" of swamp development designed to allow 2-3 crops per year. This system requires constructing a main drain, peripheral canals, regular plots, the complete levelling of the soil, very good water control, a steady supply of mineral fertilizers, high labour inputs, and a high level of management. The anticipated increases in yields in "developed" swamps have seldom been obtained by farmers, and reports are cited of local systems out-yielding improved swamps. "Asian model"-developed swamps are highly labour-intensive and labour shortages restrict efficient levelling and water management. Development agencies now consider that where swamp land is plentiful, increasing rice production by extending and improving traditional methods may be preferable to higher levels of development.

Traditional systems are not dependent on fertilizer and use local seeds, and as swamp land is readily available, labour is the main limiting resource. The use of work oxen could relieve the labour constraint. This would allow an increase in the area planted and also enable earlier planting, which has been shown to increase yields. Ox-

carts could be used for transporting produce. Work oxen are appropriate for achieving improvements in traditional swamp cultivation because they are not dependent on fossil fuels, they appreciate over their working life, provide dung as a fertilizer, plows can be maintained by village blacksmiths and oxen can be successfully hired out within villages. In "Asian model" swamps work oxen can be also be utilized for plowing, levelling and puddling.

The utilization of work oxen in swamp farming exemplifies a technology that may be realistic, challenging, technically sound and appropriate. Techniques should be designed around the traditional farming system with the participation of farmers.

Introduction

The staple diet in Sierra Leone is rice. The country, once an exporter, now has an annual shortfall of 150 000 tonnes of clean rice. An increase of 270 000 tonnes of paddy rice would be required to meet this domestic demand.

Many rice farming programmes designed to increase rice production have been implemented in the past: the mangrove development (1930s - 1950s) and mechanical cultivation of the bolis and riverain grasslands (1950s - 1960s) are two examples. Since the 1960s, the Ministry of Agriculture, Natural Resources and Forestry has emphasized the development of inland valley swamps for rice production. Many aid agencies have participated in schemes designed to increase swamp rice production. These have included some large-scale initiatives funded by the Taiwanese and Chinese, and the small-scale inland valley

swamp development schemes of the 1970s, sponsored by the Integrated Agricultural Development Projects, the Peace Corps/Small Farmers Project and the World Food Programme.

At the request of the Ministry of Agriculture, Natural Resources and Forestry, the United Nations Development Programme (UNDP) and the Food and Agricultural Organization (FAO) of the United Nations initiated the "Inland Valley Swamp Rice Development Project" in September 1982. FAO is the implementing agency in conjunction with the Ministry of Agriculture, Natural Resources and Forestry. The project is now based at Moyamba town, in the Moyamba District of Sierra Leone and is operational in swamp development throughout the Moyamba District. Current activities include swamp development, agronomic rice trials, irrigation and soils analyses, vegetable production, World Food Programme, work oxen and power tiller programmes, and extension services.

Traditional rice farming and the introduction of the "Asian model"

Although conditions vary, traditionally the mixed upland farm is central to the local farming systems. A mixed approach is used to minimize the potential disaster of a crop loss. In addition to their upland farms, 20-30% of the farmers work a portion of a rain-fed swamp for rice production (Knickel, 1984). The swamp farm is secondary to the upland farm, and is usually planted after the upland is completed.

The traditional method of swamp rice farming by hand involves brushing and clearing of the swamp in May or June. From this point, one of three methods of soil preparation and planting can be used:

- In the dry season the farmer may use a swamp hoe to make large mounds that incorporate weeds as green manure. These are planted with cassava or sweet potato

during the dry season. After the first heavy rains, the mounds are dispersed and the soil is puddled for rice transplanting.

- The farmer may simply turn the soil with a swamp hoe, puddle roughly, and then transplant the swamp rice.
- The farmers may use little soil preparation, and simply broadcast their dry or pre-germinated rice seeds.

Soil preparation and planting are usually completed by August, with all operations being done manually. Weeding takes place in September or October, with bird scaring in November and December. Manual harvesting, by the stem or panicle method, takes place in December or January. This traditional method of swamp farming uses little or no fertilizer, low management, long-duration, photo-sensitive rice varieties and minimal soil preparation. These farming systems with their particular methods of using swamps have evolved over centuries, and are based on the experiences of the farmers at their village level.

In the past, development agencies in Sierra Leone have attempted to raise yields through the exclusive use of the "Asian model" of swamp development. This model is based on maintaining strict water control. It involves a great deal of planned work in constructing a main drain, peripheral canals to redirect water flow, the formation of regular plots divided by bunds, and the complete levelling of the soil inside these plots. With good water control, short-stalked varieties can be used with mineral fertilizers, with the goal of two and possibly three crops of rice per year. This system requires very good water management, a steady supply of mineral fertilizers, high labour inputs, and a high level of management.

In theory, increased rice production would offset the high initial cost of the "Asian model", so that over a period of years the higher yields would make it economically attractive. The problem with the past use of the "Asian model" in Sierra Leone is that the anticipated increases in yields have not always been ob-

tained by farmers, because the development has often not been well carried out. Knickel (1984) reported that in the Moyamba area, slightly *higher* yields were found in traditional swamps (1.49 t ha^{-1}) than in "developed swamps" (1.37 t ha^{-1}). A variety of reasons can be given for this happening:

- The most significant difficulty faced by water-controlled farming methods is labour shortage. Sierra Leone is not densely populated, compared to many parts of South and South-East Asia. There is no large pool of landless or unemployed peasants willing to work as hired labourers (Richards, 1984).
- The design, layout and construction of "developed" swamps have often been carried out to inadequate standards (Richards, 1985).
- The improved technology of swamp rice cultivation requires timely and adequate supply of essential inputs to the farmers. Unfortunately, these inputs are frequently lacking or supplied late (Dingle, 1984).
- Farmers are not introduced to water management when swamps are developed (Knickel, 1984).
- Levelling is not sufficient in most developed swamps; it is highly labour-intensive, particularly where top soil is removed temporarily (Knickel, 1984).
- Emphasis in the past has been placed on rapid development rather than consolidation and maintenance. Practical or financial assistance has been provided for initial development, but no credit has been available to assist with the problems of maintenance.
- Sandy soil regimes are not conducive to intensive rice production. Their lack of water-holding capacity and their low clay content make fertilizer retention poor.
- One type of design (the "Asian model") has been used for all swamp types, whether they be perennial or seasonal.

Clearly the Asian model is not suitable for all conditions. In sandy soil regimes or seasonal

types of swamps, the model has not performed as had been planned. For this reason, development agencies are now looking at different levels of development matched to the characteristics of each swamp.

Extending improved traditional practices

An FAO workshop on small-scale swamp development held in 1984 gave the following as one of its recommendations:

- Clearly where plenty of swamp land is available (and only 80 000 ha out of the potential 3 000 000 ha in Sierra Leone is cultivated) there are strong arguments in favour of increasing rice production by extending and improving indigenous, traditional methods rather than proposing higher levels of development (FAO, 1985).

To increase production in this manner, more swamp land should be planted instead of increasing input and management levels. Reasons for this are as follows:

- Farmers will not be dependent on acquiring fertilizer and newer high-yielding seed rice.
- Farmers already have much knowledge of the traditional type of swamp rice farming.
- The traditional systems are less labour-intensive than those of the "developed" Asian model.
- With the traditional swamp systems, no permanent structures such as drains and bunds are developed, so that the traditional lack of secure land tenure is less of a problem.

Swamp land is not yet in short supply, and to extend the area planted in the traditional manner little or no fertilizer is used and seed rice is usually available. Thus labour is the only limiting resource, and so the use of work oxen may be encouraged to assist in the labour requirements.

Studies carried out at Njala University College demonstrated that human labour for plowing, harrowing and levelling was reduced from 567 hours per hectare for hand cultivation to 147 hr ha⁻¹ using oxen (Starkey, 1981). This is a substantial saving in labour and would assist in increasing the area planted, thus increasing production. In addition, the oxen would assist in the following areas:

- By helping to relieve labour constraints during the planting season, the use of oxen should allow more timely planting of swamp rice (in June and July) after the upland rice has been planted (in May and June). Early planting of traditional rice varieties in June and July yielded an average 1.47 t ha⁻¹ compared to 1.18 t ha⁻¹ for rice planted in August or September (Knickel, 1984).
- Possible assistance could also be provided to the traditional mixed upland farm for plowing, harrowing, weeding and seeding.
- Transportation of products using an ox-cart.
- Regular plowing aids water retention, by creating a "pan" in the sandy swamp soils.

Production can be increased by planting more swamp land in an improved traditional manner, rather than increasing management inputs. Constraints to production at all levels are more often due to labour than land (FAO, 1985). Labour, the biggest obstacle, is reduced by the use of work oxen.

The merits of work oxen

In September 1985, an FAO seminar was held at Njala University College to explore the issues surrounding the use of work oxen and power tillers. It was considered that work oxen were more appropriate because:

- The oxen are not dependent on fossil fuels for operation. Availability of fuel, together with its cost, presents a problem for operation of power tillers.
- Spare parts for ox plows are manufactured in the country and are available, while

power tiller spares must be ordered from overseas using foreign exchange.

- Many village blacksmiths can repair plows, while the power tillers need special attention by trained mechanics.
- Work oxen have a much lower running cost ratio than power tillers (Kanù, 1984).
- Work oxen appreciate over their working life while power tillers depreciate.
- With the high price and unsteady supply of mineral fertilizer, the use of oxen dung as a fertilizer can be of great assistance.
- Additional income can be earned by the hiring out of oxen at the village level.

Certainly the debate concerning animal traction and mechanization will continue, but the point must be made that they are not mutually exclusive. In some areas power tillers may be appropriate. However in the current economic situation and considering long-term national development goals, work oxen seem more appropriate for achieving the desired improvements in traditional swamp cultivation at the village level.

Conclusion

Swamp development is continually evolving in Sierra Leone. We have learned from the past, and as a result, we are now targeting levels of development to each unique swamp. The "Asian model" can be implemented in appropriate swamps through the techniques of contour bunding, and additional knowledge of the soil regime. In the "Asian model" work oxen can be utilized for plowing, levelling and puddling. However, in areas where the swamp does not lend itself to full development, an improved traditional method of swamp farming can be used.

A recent FAO report stated that an improved technology has to be realistic and challenging. It has to be technically sound and appropriate under the given conditions. It should be designed around the farmers and their traditional farming systems, ideally with the participation of the farmers themselves (Knickel, 1984). The

utilization of work oxen in swamp farming exemplifies such a technology.

References

- Dingle, R. 1984. Swamp development in Sierra Leone: observations and recommendations. FAO Rice Project, Ministry of Agriculture and Natural Resources, Freetown, Sierra Leone. (unpublished). (E).
- FAO 1985. Report on the Workshop on Small-Scale Swamp Development, held in 1984. FAO, Rome, Italy. (E).
- Kanu, B. 1984. The economics of work oxen in Sierra Leone. Work Oxen Project, Freetown, Sierra Leone. (unpublished). (E).
- Knickel, K. W. 1984. Swamp Rice Development, Sierra Leone. Technical Progress Report (9/85-3184). FAO, Rome, Italy. (unpublished). (E).
- Richards, P. 1984. Coping with Hunger. Allen and Unwin, London, U.K. (E).
- Richards, P. 1985. Indigenous agricultural revolution: ecology and food production in West Africa. Hutchinson, London, U.K. 192p. (E).
- Starkey, P. H. 1981. Farming with work oxen in Sierra Leone. Ministry of Agriculture and Forestry, Freetown, Sierra Leone. 88p. (E).

The utilization and management of draft animals at farm level

by

Abu B. Bangura

Sierra Leone Work Oxen Project, Sierra Leone

Abstract

Draft animal technology fits well into the socio-economic structure of rural people. In West Africa, crop farmers are a target for the animal power technology. Since their knowledge in cattle husbandry is often limited, improvement of their animal management skills is essential and socio-ethnological aspects must be considered. Animal management determines the work potential of draft animals and should be of serious concern to all draft animal programmes. Most draft animal programmes underestimate the importance of the veterinary component until casualties occur.

In Sierra Leone, draft animal technology was introduced in 1927. Despite lack of promotion it persisted, mainly for primary cultivation. Farmers have developed a double plowing technique that increases soil organic matter and reduces weed growth. On-farm surveys have shown that N'Dama oxen averaged 41 working days a year on plowing and 3 days a year on harrowing, cultivating 6.7 hectares, with other operations being of negligible importance.

Sweet potatoes and cassava are grown on mounds and the normal ox-plow makes suitable ridges more quickly and effectively than a conventional ridger.

The use of draft animals increases the area of cultivation and the area to be weeded. Seeders are expensive, complicated and sensitive to soil conditions, but their advantages are realized at the time of inter-row weeding. Animal-drawn weeding leads to 40-50% cost saving compared with hand weeding. The acceptance of work oxen weeding techniques is very low due to seeder problems, the fact that weeding is mainly done by women and the reduced potential for traditional

mixed cropping if seeders are used. Few farmers use groundnut lifters. Animal gears are being tested on station. The use of ox carts is increasing and such rural transport keeps animals utilized throughout the year.

In Sierra Leone natural pasture is the basis of the nutrition of draft animals as it is available throughout the year. If animals lose condition work is reduced and grazing time increased. Herdsmen prepare mineral supplements from a mixture of leaves, termite hill soil and salt. Agroforestry feed supplements requiring little work may have potential.

Introduction

The use of draft animals as a source of farm power dates back some thousands of years but in sub-Saharan Africa with the exception of Ethiopia the introduction of draft animals for crop cultivation occurred between 1905 and 1935, particularly for the production of export crops like cotton and groundnuts (Starkey, 1986).

It is worth recalling that European agriculture relied on animal traction until after the second world war when tractors increasingly replaced draft animals. By this time a permanent infrastructure had been developed for the maintenance and repair of machines and farmers had become well skilled and business-orientated. In contrast to European farmers, the majority of the farmers in sub-Saharan Africa still depend on human labour, using rudimentary tools like hoes and cutlasses. Therefore the utilization of draft animals in farming in sub-Saharan Africa must not be viewed as a step

backward but rather as a technology appropriate to the prevailing socio-economic conditions and moreover an intermediate technology from human power to conventional mechanization.

In Sierra Leone the draft animal technology was introduced in 1927 on a very small scale in the Mabile Valley and part of the Koinadugu District. Although the authorities neglected to promote the technology, it persisted. Plows bought in 1950 are still in use today, the technology having passed on from one generation to the next. Though the technology was appropriate and viable, it never expanded beyond the areas into which it had been introduced because of lack of infrastructure for repairs and maintenance.

In Sierra Leone, cattle husbandry and management are exclusively practised by the Fulani tribe. The non-Fulani groups concentrate mainly on crop farming and raising of small ruminants and they therefore have little or no knowledge of cattle husbandry and management. The crop farmers generally regard livestock particularly cattle farming as an inferior occupation. Since crop farmers are now the target for the animal power technology, socio-ethnological aspects must be reckoned as a constraint to the acceptance, use and management of draft animals. The degree of acceptance varies among ethnic groups. For example the Madingoes, the Yalunkas and the Korankos in Sierra Leone are more receptive to animal power technology than other ethnic groups.

Like several draft animal programmes, the Sierra Leone Work Oxen Project has focused mainly on equipment development, and has tended to neglect socio-ethnological factors that affect village level animal management. This neglect has resulted in the slowdown of draft animal programmes among certain ethnic groups, novices in cattle husbandry.

The utilization of draft animals

Primary cultivation

Plowing has been the oldest and the principal farming operation using work animals. In much of Africa and Asia plowing is the only operation performed by draft cattle, although plowing may be followed by harrowing or levelling in order to obtain a good seedbed. In Sierra Leone, plowing is done in swamps, riverain grasslands, bolis and stump-free uplands. Plowing is a major constraint in subsistence agriculture. In 1986 a farmer in Sierra Leone wishing to cultivate a hectare of farmland might have to pay an average of Le500 to hire manual labour, Le375 for the service of a tractor, but only Le100 for the hire of work oxen. Thus there are substantial savings to be made through hiring work animals.

Farmers in Mabile Valley in Sierra Leone have developed a double plowing technique with work oxen. This involves plowing at the beginning of the rains and the second plowing towards planting. This practice has been observed to increase yield due to increase in soil organic matter and reduction in weed growth.

Secondary tillage or seedbed preparation is considered as a light operation and is usually performed by women and children. However it is time- and labour-consuming and the use of draft animals for harrowing would relieve women and children. Therefore harrowing with draft animals could become important in peasant agriculture. Farmers in Sierra Leone are being introduced to a triangular wooden harrow which can be made by village artisans and this implement is being promoted by the Work Oxen Project. Besides upland harrowing, the triangular wooden harrow can be used for puddling in swamps and levelling in both swamps and upland.

On-farm surveys have shown that a pair of N'Dama oxen averaged 41 working days a year on plowing and 3 days a year on harrowing, with other operations being of negligible im-

portance; an average of 24-30 ox-team-hours per hectare was recorded, representing an average of 6.7 hectares a year. There are individual teams recorded to have plowed 18 hectares in a season at the rate of 0.5 hectares per working day (Allagnat & Koroma, 1984). On-station trials in developed swamps gave figures of 33 ox-team-hr ha⁻¹ for plowing and 38 ox-team-hr ha⁻¹ for harrowing and levelling (Starkey, 1981).

In Sierra Leone, the Work Oxen Project has promoted the practice of two-person control of animals instead of the traditional several-person control. In neighbouring Guinea control by one person is practised which is more efficient in terms of human labour.

Ridging

Tuber crops like sweet potato and cassava are traditionally grown on mounds or heaps prepared by using the local broad hoes. The operation is almost similar to traditional plowing in terms of labour requirement. The use of work oxen for such operations can substantially reduce the labour requirement and time spent compared with the traditional method.

In Sierra Leone, the ridger has not proved to be a better implement than the plow, for in heavy soils the plow itself makes good ridges more quickly and effectively than a conventional ridger. The ridger requires several passes on a well-plowed and harrowed area to make a ridge, whilst by using the plow, two passes on either side produce a standard ridge even in unplowed land. The use of the ridger is restricted to upland but the plow can ridge in all the three ecologies: upland, riverain grassland and swamp. Farmers are therefore not very keen on the use of the ridger.

Seeding

In West Africa seeding with draft animals is only common in certain dry upland ecologies. This practice is much more popular in the Sahelian zone than in the forest zone where

the soil is heavy and stumping is a difficult operation for farmers. In Sahelian countries seeding with animal-drawn seeders is common among cotton and groundnut farmers. For example in 1977, Senegambia had 233,000 seeders (Sargent *et al.*, 1981). The advantage of seeding with draft animals using a single row seeder is only realized at the time of inter-row weeding, which is a very big constraint in peasant farming. Animal-drawn weeding leads to 40-50% cost saving compared with hand weeding.

Trials carried out in Sierra Leone showed that oxen working 5-6 hours a day could seed an area of 0.4 to 0.5 hectares. A single ox can also be used in seeding since it is a light operation. In the villages seeding with oxen is still at a demonstration stage and the demand for seeders is not as high as the plow, the ox cart or the harrow. Generally seeders are expensive, complicated and sensitive to the quality of seedbed preparation and soil moisture.

Weeding

Weeding with oxen has a high potential for saving labour and time as compared with the traditional method. For example, with trials in Sierra Leone, hand weeding of groundnuts required 403 person-hours ha⁻¹, while the use of oxen reduced it to 76 person-hours ha⁻¹ (Starkey, 1981). As in many places, the acceptance of work oxen weeding techniques among peasant farmers in Sierra Leone is very low and this is attributed to:

- The disadvantage of a seeder which is complex, costly and sensitive to soil conditions.
- Weeding is mainly done by women and unfortunately only males work with the animals who consider weeding as a very light operation.
- The potential for traditional mixed cropping is greatly reduced if a seeder is used.

The use of draft animals implies increases in the area of cultivation and therefore the area to be weeded. Weeding being a major limiting

factor to crop production, the adoption of ox-weeding techniques by peasant farmers through effective extension will be a major step forward in agricultural development.

Another means of reducing weed growth is practised by experienced farmers in the Mabolé Valley of Sierra Leone. They practise double plowing to avoid pre-planting weed clearance and to reduce subsequent weed growth on uplands and in swamps. Farmers also claim to have increased yields with double plowing compared with single plowing because of the additional green manure.

Harvesting

Unlike Senegambia where there are about 90,000 lifting implements for uprooting groundnuts, in Sierra Leone hardly any farmers use groundnut lifters. This is mainly due to the practice of scattered planting, the fact that groundnuts are not a major crop and because most of the operations are done by children and women.

Harvesting of rice is a big constraint in rice production. Farmers can lose a high proportion of the yield of the rice if harvesting is not done in a very short period from the point of complete maturity. Should it be possible, the development of an ox-drawn rice harvesting implement would be much more appreciated than groundnut lifters.

Animal-powered gears

Animal draft force can be converted to mechanical energy to operate water pumps, rice hullers, maize grinders and cassava graters through gear systems. The animals are attached to a horizontal pole and as they walk in a circle the gear system is operated.

In Sierra Leone, this technique is fairly recent and it is currently only undergoing on-station trials at Rolako. If it works, and is accepted by farmers in Sierra Leone, the processing of agricultural produce at village level will be facili-

tated and by adding value in the villages, a greater proportion of high consumer prices will remain with the farmers. It will therefore reduce the powers of the shrewd middle-men who reap more profit from farm produce than the farmers themselves.

Irrigation can be a constraint in the farming systems in the dry season. Farmers are willing and able to cultivate crops right through the year but lack of rains for six months prevents this. Therefore the use of animal power for irrigation purposes could increase annual food production and lead to self-sufficiency in the staple food, rice.

Transport

Transport is a major constraint at village level. Substantial quantities of agricultural produce are transported on the heads of the people, mainly women and children. Inadequate transport can be a limiting factor to the production of crops like fruits and vegetables. The use of draft animals to pull carts leads to a convenient form of rural transport and keeps the animals utilized throughout the year. The technique is fairly recent in Sierra Leone but the demand for it is very high among farmers.

The work achieved by draft cattle in transport operations is very variable, depending on animal size and conditions, cart design and the nature of the terrain. In Sierra Leone, the metal-wheeled ox carts manufactured at Rolako carry about one tonne using 4-5-year-old animals.

The management of draft animals

General

Management is invariably the most important factor that determines the work potential and working life of draft animals. In West Africa cattle rearing is a tradition of the Fulani tribe and the non-Fulani tribes are crop farmers

whose traditional skills in cattle management are few. Animal management should be of serious concern to all draft animal programmes in West Africa since most farmers involved tend to be non-Fulani. Draft animal management includes feeding, housing and health.

Nutrition

In sub-Saharan Africa the natural pasture is the basis, and in most cases the only component, of the nutrition of draft animals. Minerals and farm residues such as groundnut hay, rice straw and maize stover are seldom made available to animals in the more humid areas like Sierra Leone. During the dry season, farmers leave their animals to range widely in search of grazing. In the Sahel areas the effect of the dry season is to reduce the animals to a very poor state by the time they are required for work at the beginning of the rainy season. In Sierra Leone, the availability of green pasture for work oxen throughout the year makes it possible for most farmers to keep their animals in the dry season and apparently the animals are in a better state during the dry period when there is less work and less of a health problem.

The natural pasture in Sierra Leone tends to be inadequate in legumes, as they are dominated by fire-climax grasses like *Imperata*, *Pennisetum* (elephant grass) and *Panicum* (Guinea grass). In non-savannah areas like the southern and eastern part of Sierra Leone, shifting cultivation permits the growth of fresh, succulent grasses in the newly abandoned fields. Starkey (1984) recommended a low input/low output system for Sierra Leone, implying that free grazing fitted well into the traditional socioeconomic system and that the output of the draft oxen should be made commensurate with the traditional low feed quality. Under such a system, if animals appear to be losing condition, their work is reduced and their grazing time increased. The overall work may be four hours a day for five days a week as this can

generally be maintained on the available pasture.

At farm level it is generally difficult to preserve forage either in the form of hay or silage. For hay, the major problem involved is the unavailability of extra labour at labour peak periods, and in the humid tropics, the high humidity and rainfall makes drying difficult. The idea of silage has never extended beyond the confines of the university and livestock stations in Sierra Leone. It is labour-intensive and a costly operation at farm level. With all the difficulties in providing better feed quality at farm level, it could be more effective to use agro-forestry crops requiring little work. Certain *Acacias* or *Leucaena leucocephala* are cheap and effective means of improving draft animal nutrition at village level.

It is a good practice to ensure that working animals are provided with clean water once a day to compensate for the loss in water through sweating and salivation and to complement the increase in dry-matter intake associated with the energy requirement for work. In the dry season the provision of 30-40 litres per day/per animal is considered reasonable.

Herdsmen in Sierra Leone are aware of the importance of minerals and vitamins for their animals. They therefore prepare mineral supplements known as *tupal* from a mixture of selected leaves, termite hill soil and common salt. This is also associated with traditional ceremonies to protect the animals from supernatural forces. Work oxen farmers generally provide the animals with some common salt on a regular basis for nutritional purposes and to encourage close human contact with the animals.

Housing

The health, strength and lifespan of draft animals are of crucial importance for ensuring the viability of animal power technology. Therefore the protection of draft animals from harsh weather conditions through the provision of a

cheap form of housing is advisable. In Sierra Leone farmers generally bring their animals close to their homes at night. Some farmers provide a shed while others even allow them into their houses. The shed or paddock should have a sloping floor to allow runoff. To reduce the problem of flies, the shed should be dung-free and not muddy. Below the roof residues such as groundnut hay or rice straw can be stored for the dry season. It is advisable for each shed to have a crush and stock to facilitate yoking of the N'Dama animals and veterinary examination.

Health

For farmers unused to cattle rearing, animal health is a big problem at village level. The success of any draft animal programme depends greatly on the effectiveness of the veterinary service. However most draft animal programmes underestimate the importance of the veterinary component until casualties occur. For example, the Sierra Leone Work Oxen Project once experienced an animal mortality rate of about 25% which was associated with a heavy infestation of the fly *Stomoxys* and a shortage of insecticidal chemical in the country. Despite the hardiness of N'Dama to diseases like trypanosomiasis, they are still prone to certain endemic diseases and endo- and ecto-parasitic infestations including worms, liverflukes, ticks and flies. Bloat is not very frequent but if it does occur, farmers treat it by giving half a litre of palm oil to the animal.

Conclusions

In sub-Saharan Africa, with the exception of Ethiopia, the utilization of draft animals in farming is relatively recent. Farmers still rely greatly on human power for the cultivation of their farms. Draft animal technology is not a

backward technology but an intermediate technology to tractorized mechanization that fits well into the socioeconomic structure of the rural people.

In Sierra Leone the utilization of draft animals is mainly for primary cultivation at farm level. Other operations are being demonstrated and assessed on-farm. The demand for ox carts is increasing since transport is a constraint in rural areas. The animal-powered gear system is at a trial stage but if it succeeds in processing agricultural produce and in irrigating crops during the dry season, the overall annual agricultural production could be boosted towards self-sufficiency.

The management of draft animals should be an area of concern because the viability of the technology depends to an extent on the health, strength and working life span of the animals. In West Africa draft animals are mainly used by crop farmers whose knowledge in cattle husbandry is very limited. The improvement of the animal management skills of such farmers is essential in sustaining animal power technology at farm level.

References

- Allagnat, P. and Koroma, B. 1984. Socio-economic survey of the use of ox traction in the Mabole Valley, Bombali District. Sierra Leone Work Oxen Project and Association Française des Volontaires du Progrès, Freetown, Sierra Leone. 119p. (E,F).
- Sargent, M. W., Lichte, J. A., Matlon, P. J. and Bloom, R. 1981. An assessment of animal traction in francophone West Africa. Working Paper 34. Department of Agricultural Economics, Michigan State University, East Lansing, USA. 101p. (E,F).
- Starkey, P. H. 1981. Farming with work oxen in Sierra Leone. Ministry of Agriculture, Freetown, Sierra Leone. 88p. (E).
- Starkey, P. H. 1984. N'Dama cattle: a productive trypano-tolerant breed. *World Animal Review* 50: 2-15. (E,F,S).
- Starkey, P. H. 1986. Draught animal power in Africa: priorities for development, research and liaison. Networking Paper 14, Farming Systems Support Project, University of Florida, Gainesville, USA. 40p. (E).

The economics of animal power in Koinadugu District, Sierra Leone: a case study of the work oxen introduction and credit programme

by

H. Corbel

Koinadugu Integrated Agricultural Development Project, Kabala, Sierra Leone

Abstract

Information on animal power and farming systems was obtained through an economic survey of three villages and by monitoring the Loan Scheme of the Koinadugu Integrated Agricultural Development Project (KIADP), Sierra Leone.

The area is very hilly. Swamp farms averaging 1.3 ha are used for rice in the rainy season, and for vegetables and sweet potatoes in the dry season. There is no water control in swamps and rice yields average 1000 kg ha⁻¹ (range 335-2020 kg ha⁻¹). Upland farms averaging 1.6 ha are used in the rainy season for upland rice and groundnuts, and small areas of tomatoes, maize, millet and cassava. Groundnuts yield 500 kg ha⁻¹ (range 110-980 kg ha⁻¹). Men and women have different responsibilities for crop cultivation. Family labour is a limiting resource and hired or exchanged labour is required for 60-80% of farm work.

The Loan Scheme has provided 167 loans to purchase oxen and/or plows. The oxen loan is below the cost of suitable animals, so farmers buy young, small animals. Oxen are branded with project marks to reduce fraud and theft. Village level training created logistical problems so training is being centralized. The Pecotool toolbar is expensive and is not used as a multipurpose implement. Traders sell cheaper, less complex plows smuggled in from Guinea. There is no insurance against mortality. Veterinary drugs are not available to farmers. Ox mortality is 8% (4% disease, 4% accidents) and 6% of oxen have to be changed due to sickness or injury. The animal health services in Koinadugu urgently need strengthening.

Average annual use of oxen is 41 days' plowing for swamp rice (41%), millet (19%), upland rice (17%), groundnuts (15%), maize (4%) and cassava (3%). Increased use is constrained by lack of flat or cleared land. Most (78%) farmers hire out their animals, for an average of 11 days a year. Grazing is supervised by young boys belonging to the family. Most farmers have to pay compensation payments for damage caused by their draft animals.

Economic data on the costs of maintaining oxen are provided. The cash needed to adopt animal power with a KIADP loan is equivalent to the annual sales of farm products, and is twice the annual labour expenditure. Thus investing in ox cultivation is difficult. Existing farms are small and could be plowed in just 15 days, if they were level. Most upland farms are steep, rocky and full of stumps. Farming is risky and yields erratic due to pests. Most dry season crops are grown on raised beds and alternative systems using animal power are unproven. However labour constraints and the appreciating value of oxen make animal traction potentially attractive, if it can be combined with increased farm size, diversified operations (ridging for tuber crops) and hiring out animals.

Introduction

This is a condensed version of two detailed papers that were prepared for the Networkshop and circulated in both English and French (Corbel, 1986a, 1986b, 1986c and 1986d). The information contained in this paper was obtained through the regular monitoring and evaluation of the Work Oxen Loan Scheme of the Koinadugu Integrated Agricul-

tural Development Project (KIADP) based at Kabala, in the north of Sierra Leone. It also includes the results of a one-year economic survey in three villages in the vicinity of Kabala.

Being an economic study, many figures are provided in the local currency, the Leone (Le). The Leone has changed greatly in value in recent years, so that international comparisons are difficult. During the period covered by the survey the Leone was effectively devalued by about 350% (Le1 = US\$0.17 in 1984 to Le1 = US\$0.05 at the time of the networkshop in 1986). A further complication is that during the period covered by this survey, much of the economy was influenced by parallel exchange rates (black market) up to twice those of the official rates, a problem which was greatly reduced when the Leone was officially "floated" and effectively devalued. These forces have fuelled inflation and so comparisons of figures in Leones between years are difficult. In these circumstances, Leone figures are quoted mainly to allow a comparison of *relative* costs and prices for farm inputs and outputs during the same season. The absolute value of the figures quoted is now mainly of historical interest!

The prevailing farming systems

Cropping systems

The Kabala area is noted for its hilly terrain. It has two main agro-ecological conditions: upland (level land, slopes or steep hills) and inland valley swamp. During the rainy season, which lasts from mid-April to mid-November, these ecologies are planted with rice in the swamps and with groundnuts, tomatoes, cassava, millet and maize in the upland. During the dry season a second rice crop may be grown in the swamps. More commonly the swamps are used in the dry season to grow groundnuts and sweet potatoes, together with vegetables such as okra, cabbage, onions and aubergines.

Each village has its particular cropping patterns. However, on average, swamp farms ac-

count for 31% of the overall area cultivated during the rainy season, and upland farms account for the remaining area. Since swamps are also cultivated in the dry season, swamp farms represent 44% of the area cultivated during the whole year. Swamp farms average 0.8 ha during the rainy season and 1.3 ha over a full year, while the upland farms average 1.6 ha. During the rainy season the major crops cultivated in terms of area are swamp rice (31% by area), upland groundnuts (28%) and upland tomatoes (10%). While all farmers grow significant quantities of swamp rice and groundnuts, crops like maize, millet and cassava are not universally grown.

Swamp rice farms, as well as upland millet and cassava farms, are generally under the control of the head of the household, although some swamp rice farms can be allocated to the wives. Upland groundnut and okra farms are under the control of women, while such cash crops as tomatoes, carrots and sweet peppers are cultivated by both men and women, whatever their position in the household. Maize is also cultivated as a cash crop by the head of the household and women often have their own small backyard plots for home consumption.

During the dry season, the major crops in terms of area grown are sweet potatoes (0.1 ha) and groundnuts. The area planted with onions, cabbage and sweet peppers is quite small.

Land suitability for ox traction

The ecology, size, shape and location of the farms often make it difficult to contemplate the introduction of animal traction. Most upland farms are totally unsuitable for ox cultivation due to the gradient and the presence of rocks and stumps. The swamps are not developed, so that lack of water control combined with swamp vegetation prevents farmers from plowing all their swamp. A survey of 14 farms suggested that between 30-80% of the farm-land was unsuitable for animal traction.

The average area of land suitable for ox plowing was just 1.1 ha per farm.

During the dry season, most crops are grown on raised beds and large heaps. Unless farmers consider that ox ridging could be appropriate to their conditions, they are likely to continue to employ external labour to prepare these high heaps.

With farms of their present size and crops, oxen could achieve most of the plowing in just 15 days. With such low utilization, the daily cost of the oxen would be prohibitive, even compared to relatively expensive hired labour. Thus if animal traction is to be profitable and adopted, farmers would have to increase the annual utilization by:

- increasing the total area of the farm with suitable land,
- increasing the area cropped in the dry season,
- making use of oxen for more operations (ox ridging and weeding),
- hiring out animals to other farmers.

Household labour

In the present system, labour is the main productive resource. It is also the main input since both hired and exchanged labour are frequently used to perform farm operations. Family labour alone cannot cope with the overall amount of work needed and "companies of work" have developed as one social custom designed to alleviate the labour constraint. In the area of the survey, most of the farmers are men with two wives. 25% of farmers have three or more wives. There are large numbers of children in families and one third of household members are not engaged in farming activities due to their young age. Teenagers of 15 years or more have their own farms. The average land cultivated per full-time farmer is 0.4 ha.

Farm operations are allocated to different gender groups. Men perform most primary cultivation. Men also control most of the land suitable for ox plowing. Thus if draft animals are

adopted, the main beneficiaries will be men. In the first instance, women would be unlikely to use animal traction since they are not involved in swamp plowing and most of their farming is performed on upland terrain that is unsuitable for ox cultivation.

External labour

External labour is regularly used on most farms in the area. *Hired labour* is paid with cash plus daily meals. *Exchanged labour*, derived from the informal labour organizations, receives meals but no fee. Only 6% of the farms surveyed were cultivated entirely by family labour. Data collected on 21 swamp rice farms indicated that on all farms 81% of the work-days recorded by farmers for brushing (farm clearance) was done by external labour (both hired and exchanged), as was 73% of the soil tillage. Data collected on 31 upland groundnut farms indicated that hired labour was used for 78% of the overall amount of work necessary for brushing and 72% for primary tillage. Exchanged labour was used in 87% of the farms to perform 74% of the overall work for planting and weeding. During the dry season, less external labour (particularly exchanged labour) is used. However of 102 farms belonging to 21 households, 51% had been entirely brushed with hired labour and 48% had been cultivated with hired labour.

Since external labour is systematically used for primary cultivation whatever the crop, the ecology, the season, or the size of the farm, the introduction of animal power would seem appropriate. The major constraint therefore would seem to be that of land suitability.

The KIADP Work Oxen Loan Scheme

The Musaia Ox Unit was set up within the livestock department of KIADP, based at the Musaia Livestock Station. During 1980 and 1981, extension agents were recruited and trained under the guidance of a British volunteer, as-

sisted by a Sierra Leonean. By 1982 14 ox-trainers were trained and sent to various stations in Koinadugu including Mongo, Falaba, Koindu, Gbentu, Sinkunia, Gbenikoro, Dogolaia and Ganya. Four ox-trainers remained at the Musaia Station and among other activities provided an ox-hiring service for local farmers.

From the early stages it was clear that there was significant interest in the adoption of draft animals in Koinadugu, but that unless credit could be made available, the training programme would only be able to reach the richer farmers who already owned cattle. Thus a loan scheme was devised and implemented by KIADP, with the Musaia Ox Unit providing technical advice.

The Musaia Ox Unit has been responsible for arranging two types of loan. A loan to purchase oxen (which stood at Le2200 in 1986) and a loan to purchase ox plows (Le800 in 1986). Both loans attract interest rates of 15% and are repayable in four annual instalments. Between 1984 and 1986 a total of 167 loans were dispersed, at a rate of about 55 per year. Half of the loans (85) have been for both animals and plows, and a quarter each (41) for equipment only or animals only. The demand for work oxen loans has been increasing, so that in 1985, 250 applicants were registered, and in 1986, 396 were registered.

Selection of loan recipients

At the start of the loan scheme, it was decided to work in close co-operation with paramount chiefs at the chiefdom level, and it was directly through them that the selection was made in 1984. Subsequently other people also assisted in the selection of suitable individuals, including the ox-trainers and the KIADP extension agents. Each applicant has to complete a form giving details of their experience (if any) of oxen, cattle and traditional animal health practices, and also the characteristics of the farm(s) and the present sales of agricultural products. Priority is given to full-time farmers whose

main income originates from agriculture and who spend most of their time on farming.

On the basis of this written information, and any comments of the extension agents, the commercial agents, the ox-trainers and the paramount chief, a first selection is made. During the second stage of selection, one or more visits are made to the applicants' farms, in order to assess their level of production and land suitability for ox cultivation. All KIADP farmers are organised into credit groups and loan applicants must not have any debts outstanding to KIADP. All loan agreements are countersigned by the paramount chief and the KIADP credit group leader.

Characteristics of the loan recipients

Studies carried out in 1983 showed that 59% of the private ox-owners in the KIADP area were Fulahs. Another 11% were Mandingoes and 11% were Yalunkas. Most of the private ox-owners were to be found in Sinkunia chiefdoms where several previous ox-traction schemes have taken place since 1928. During the three years of the KIADP loan scheme 40% of the oxen and plow loan recipients have been Yalunkas. The Yalunka is a minor tribe in Koinadugu District, and only 11% of traditional ox owners have been Yalunka. Thus the animal traction programme has had a major impact with this tribal group. In contrast, Limba farmers, who according to the 1974 census represent 20% of the Koinadugu population, are almost absent among recipients. These people are not cattle owners by tradition. As a tribe, Fulahs comprise 18% of the population, but 59% of the long-standing oxen users. Almost all loan applications from people wanting only to purchase a plow (and not animals) were Fulahs and a total of 26% of the loans went to Fulahs. 22% of the loan recipients are Korankos, a figure in keeping with the representation of Koranko chiefdoms in the KIADP area.

One of the conditions favouring the success of the loan scheme is the small but significant

numbers of former owners and users of work oxen. These people, together with cattle herd owners, have the knowledge and capability to ensure good care of the work oxen. The majority (59%) of loan recipients have had previous experience with oxen. Of the 41% of recipients completely new to animal traction, many already own cattle, or have previously owned cattle. Such a high percentage of former ox-owners and ox-users among loan recipients reduces the likelihood of the loans being misused. In addition a knowledge of cattle and traditional animal husbandry is important since no veterinary drugs are available on a regular basis in the KIADP area.

Loan disbursement, bull acquisition and animal training

The cash provided for purchasing oxen (Le2200) was deliberately set below the market price of animals to make the loan recipients commit themselves financially from the beginning. Unfortunately this has caused delays in the purchasing of animals, resulting in delayed training. It may be wise in the future to include a statement within the loan agreement concerning the personal financial commitments required of recipients, as well as a clause preventing delays between cash disbursement and purchase of oxen.

The best time for loan disbursement is January, as this allows recipients to use their oxen from the onset of the rainy season in April. In 1984 most (74%) of the loans were dispersed in January and February. In 1985 most (86%) were dispersed in May, while in 1986 no loans were made available before July. The delays have been due mainly to internal constraints within KIADP and represent one of the weaker aspects of the loan scheme.

The Musaia Ox Unit advises its farmers to purchase bulls that are two and a half years old, which can be castrated before the onset of the training programme. Due to the sharp increase in the price of cattle, farmers have a tendency to buy younger bulls (just two years old) to

avoid having to meet the difference between the loan (Le2200) and the cost of recommended animals (Le3000). Although it is stated in the loan agreement that the borrower is responsible for identifying the bulls which would be purchased on his behalf by the Musaia Ox Unit, this procedure was abandoned in 1985 as being too tedious and time-consuming. This lack of control has allowed farmers to opt for younger, less expensive animals.

Each pair of animals is castrated and branded with marks specific to oxen for whom loans were supplied. Animals with the loan scheme branding marks may not leave the District without permission, and the brands have proved valuable in tracing stolen oxen. Nose rings are inserted to facilitate control from behind. At present yokes are not provided by the unit, but in future a carpenter will be employed to manufacture them.

A few weeks after the oxen have been castrated, training starts at the village level, on the farm of each recipient, under the guidance of the ox-trainer. Training lasts four weeks and each recipient must provide two ox-handlers who will be taught how to train oxen. Training at the village level has created many problems for the ox-trainers who do not have transport. Thus it has been decided to centralize future training at the seven Livestock Centres in the KIADP area.

Equipment used

There are three main types of plow. The Pecotool is a toolbar of British design that has both 6" (15 cm) and 9" (23 cm) plow bodies. It was first tested in Sierra Leone in 1979, and following a series of trials and modifications it was found to be appropriate to local conditions. It is now assembled from imported components by the Work Oxen Project at the Rolako Workshop. It is presently subsidized by the KIADP which buys the set at Le1000 and sells it to farmers at Le800. In principle, several working bodies could be attached to the Pecotool frame to allow a farmer to weed, make

ridges or lift groundnuts. However there have been no demonstrations of these at chiefdom level since the beginning of the loan scheme and none has been introduced at the farm level. Due to the economic situation, the price charged for the Pecotool is well below its current production cost, which in August 1986 was estimated to be as high as Le5500. In the Koinadugu District, where cheaper and less complex plows smuggled from Guinea can be purchased from traders, the spread of the Pecotool may stop when prices are raised.

To satisfy the demand for the lighter, cheaper plows, the Musaia Ox Unit has contacted local traders to try to obtain a batch of "Guinea" plows. These include the plows of Chinese design made by USOA (Usine des Outillages Agricoles, Mamou, Guinea) and the large "Otma" plows made in Italy. In 1986 the price for an Otma plow was Le500, whilst second-hand USOA Guinea plows were bought at Le400 by farmers. These prices do not represent the true value of either plow, since both are subsidized by the Guinean authorities.

The Unit is thus facing a difficult situation. On the one hand there is the expensive Pecotool whose components are imported officially from England, and over which the Unit has control in terms of availability, delivery dates and supply of spare parts. On the other hand there are two simpler plows, very attractive because of their price, but smuggled into the country without spare parts and over which there can be no control to allow forward planning. Since the project receives funding from the EEC, it might be possible to order simple plows from overseas for local assembly.

The Ox Unit has decided to promote the use of wooden triangular harrows, since harrows are frequently requested by farmers. To a lesser extent, ox carts will be introduced.

Animal health

There is no insurance in the credit package against mortality. According to the loan agree-

ment, "the project undertakes to vaccinate bulls against haemorrhagic septicaemia, anthrax and black-quarter before training, and subsequently each year at least for the period of the loan, free of charge, given the availability of drugs". In practice, drugs have not been available for farmers since the beginning of the 1985 rainy season. In 1986 it was decided that all drugs (previously provided free of charge) should be sold to the farmers, but as yet they are still unavailable.

It is clearly of great importance that oxen are well looked after, particularly as it is the increasing value of the oxen which makes investment in animal traction worthwhile. Survey data relating to the farmers who received loans in 1984 and 1985 are available. In general, apart from the common problems of irritation by ticks and flies, the health status of the oxen during that year was quite good, and 37% of recipients reported that they had had no trouble that prevented them from using their oxen. However animal health problems did adversely affect work programmes so that 32% of the recipients had to stop work for periods ranging from less than one week to more than one month. Furthermore, during the past year, 4% of the oxen have died of disease and another 4% have died from accidents. It would appear that the launching of a loan scheme in a situation where disease control is minimal and where there is no insurance in the case of animal death should have been a cause for concern. For this reason the failure of the KIADP to procure and distribute adequate drugs appears to be the weakest aspect of the work oxen loan scheme.

Present use of work oxen

The survey recorded 1425 ox-pair working days for the loan scheme recipients and showed that oxen are used mainly for plowing for swamp rice production (41%), and also for cultivation of upland or boliland soils for growing millet (19%), rice (17%), groundnuts (15%), maize (4%) and cassava (3%). The average perfor-

mance per set of oxen was 30 days of household farm work for the farmers who had bought their animals in 1984. For more recent adopters (those who had received loans in 1985), only 17 days of household farm work were achieved, the bulk of this being performed during the rainy season. Among the 1984 loan recipients, the highest performance was obtained by oxen who worked on household farms during both the rainy and the dry season and which were also hired out during the rainy season. The average performance was 41 working days.

It appears that most recipients are already plowing all their suitable land at the household level, since the main reason cited for the non-use of oxen (for each crop) was land unsuitability. For the future it will be important for each farmer to have access to new unfarmed land that is suitable land for ox cultivation. The survey suggests that with the latest loan recipients, this is indeed the case.

Economic implications of introducing animal traction

In order to assess the financial implications of animal power introduction, some of the major cash flows within the present farming systems will be briefly discussed. It is not intended that a detailed economic model of the complete farming systems will be presented. Rather information will be presented to indicate whether animal power should be considered a viable investment, worthy of a loan.

Labour costs

In 1985, the average daily wage for a hired man was Le4 for brushing, tilling and making heaps. For women the wage was Le2 for planting and weeding and Le4 for uprooting the seedlings of swamp rice for transplanting. During 1986 daily wages rose to Le6 for a woman and Le8-10 for a man. In some cases labourers will not be paid on a daily basis but will establish contracts for working particular areas. The

payment in kind for both hired and exchanged labour comprises a meal, plus cigarettes and kola nuts. The cost per labourer will depend on gender, since women eat less rice and seldom smoke or eat kola nuts. Men are allocated up to two cups of rice, while a woman is provided with only one. Five to ten cigarettes must be attributed to each smoker, as well as a kola nut. Those who do not enjoy these may receive a small cash compensation. Thus the daily cost of employing a hired man may be as much as Le10, while it may be as little as Le3 for a woman.

Among the villages surveyed, it was reported by farmers that an average of 51 days ha⁻¹ of work was necessary for tilling swamp rice farms. Family labour could provide (on average) only a third of the overall work needed, so that much was done by exchanged labour (44%) and hired labour (25%). The average cost in 1985 was Le170 ha⁻¹.

A survey of 14 swamp rice farms where ox cultivation is used to plow some of the farm showed that labour input for plowing was only 25 man-days ha⁻¹ of work. Much of this was still performed by exchanged (43%) and hired labour (24%), giving a total labour expenditure of Le105 ha⁻¹.

Similar surveys on upland groundnut farms showed that the average cost of tillage was Le194 ha⁻¹, since most (85%) of the work was done by external labour. The labour cost for primary tillage represented about 30% of the overall labour expenditure for this crop. On average 42 women-days ha⁻¹ were necessary to weed groundnuts, with family labour providing 30% and exchanged women providing 66% of the work. The low rates paid to women explain the relatively low labour cost of Le90 ha⁻¹.

The main characteristic of dry season farming is that most crops are cultivated on circular heaps or longitudinal raised beds. Among 21 households, 84% of the dry season farm was cultivated in raised beds, while only groundnuts and rice (16% by area) were tilled on the

flat. Sweet potato farms were cultivated by 18 households (out of 21 surveyed) and the average farm size was 0.1 ha. It is assumed that a man can make 15-20 longitudinal heaps per day. Most (80%) of the work is done by hired labour, whatever the size of the farm, leading to the high cost of Le710 ha⁻¹ for heap making. If sweet potatoes could be grown on ridges made by oxen, it could greatly increase the profitability of this important cash crop. However farmers are not yet convinced that the small and low ridges made by oxen are appropriate to their conditions.

Labour expenditure per household

It is useful to determine the total labour costs per household per year to assess the potential savings that could be made using ox cultivation; assuming that more crops could be grown on suitable land. This data would indicate if the cost of animal power introduction would be marginal or important compared to other farm costs.

The survey indicated that in the rainy season the overall expenditure per household was Le300 for swamp farms and Le700 for upland farms, leading to an average overall labour expenditure per household during the rainy season of Le1000. These figures represent average costs of Le375 ha⁻¹ for swamps and Le600 ha⁻¹ for upland farms. In villages where oxen are already used, the overall labour expenditure per household was Le273 on swamp farms, while the labour cost was Le320 ha⁻¹. In these villages only one quarter of the labour cost was attributed to primary tillage since oxen were performing much of this work, while in the other villages almost half of the labour cost goes on tillage.

During the dry season, average overall labour costs per household were Le466, with costs varying between Le725 ha⁻¹ and Le1120 ha⁻¹ depending on the proportion of crops cultivated on heaps. In most cases 60% of this was spent simply on making heaps, which shows the potential savings that could be achieved by

using oxen to make ridges for cassava and sweet potato.

The overall annual labour costs at the household level varied from Le648 to Le2388, according to the size of the farms and the management of the farmer.

Costs of equipment, seeds and fertilizers

Farm tools are a capital resource. Hoes, cutlasses and harvesting knives were the most commonly owned tools, many of them locally produced and repaired. The estimated lifespan of these farm tools is: 3-5 years for hoes, 2-4 years for swamp cutlasses and 8-10 years for forest cutlasses. The present value of these implements for an average household can be estimated at Le400. Thus the annual replacement cost can be assumed to be about a quarter of this amount, that is Le100.

None of the farmers surveyed used fertilizer, except for cabbages grown during the dry season. No chemicals were applied on any of the farms to protect against pests and rodents. For most crops, seeds and cuttings are systematically kept from the previous year and thus seeds do not generally require an outlay of cash. The exceptions are cabbages and sweep peppers, for which farmers purchase seeds. To buy seeds for rice, groundnuts and tomatoes, the major crops of the rainy season, would be expensive, perhaps Le270 ha⁻¹ for swamp rice and Le620 ha⁻¹ for groundnuts. This is in comparison with overall labour expenditure of Le375 ha⁻¹ for swamp rice and Le625 ha⁻¹ for groundnuts. Thus the management of the farmer in keeping seeds and cuttings from previous harvests is crucial in terms of keeping costs minimal.

Crop yields and sales income

The survey indicated great variations in yields. In a few cases farmers may have deliberately underestimated their yields. However it is evident that very low yields are quite possible

since rodents, monkeys and birds can destroy a great deal of the harvest. During the dry season sweet potato yields are very low due to lack of water. Yields on swamp rice averaged 1000 kg ha⁻¹ and varied from 335-2020 kg ha⁻¹. Previous studies had indicated that yields in such conditions averaged 1170 kg ha⁻¹. Yields of upland groundnuts averaged 500 kg ha⁻¹ (range 110-980 kg ha⁻¹), while previous studies in the area had estimated them at 860 kg ha⁻¹. Yields for upland tomato farms varied from 960 kg ha⁻¹ to 1700 kg ha⁻¹.

Using these figures it can be shown that upland groundnuts can provide an average farm household with a harvest worth Le1700. However only a fraction of the harvest is ever sold and no farmers whatsoever reported selling rice. In fact none of them was self-sufficient in this staple food, and all farmers reported they had to buy rice for home consumption.

The average value of sales per household was Le1359 during the rainy season and Le1351 during the dry season. Dry season farming is an intensive period of vegetable growing in the swamps. Animal power could make it even more profitable if ox ridging and weeding were shown to be practicable in this situation.

The costs of animal power introduction at the farmer level

The cost of animals

The cost of owning and using a pair of oxen and a plow in 1986 will now be estimated, assuming a farmer is a loan recipient during the first year of use. The price of bulls ranges from Le2900 to Le3300 per pair of animals 2-3 years old. As noted above, price increases have encouraged farmers to purchase younger bulls since the animal loan package of Le2200 is not sufficient to meet the full cost of the animals. Under present loan conditions, farmers have to repay capital of Le550 every year for four years. In the first year the farmer must find about Le500 to cover the additional cost of the

cattle, over the loan amount. This implies that about Le1000 will be needed in the first year. The loan has a 15% interest on the reducing balance which means that the first year the recipient will pay Le330 (Le2200 x 0.15).

Under the present system there is no insurance against death or loss of oxen. The survey indicated that over a period of a year, 4% of oxen died of disease, while another 4% died of accidents and 6% were changed following disease or other trouble. Thus the risk of death could be considered to be covered by a theoretical insurance cost of 8% of the mean value of oxen over a year, which would be about Le250. Since this is a theoretical cost, it will not be included in the present calculations.

Feeding and health

Grazing supervision is invariably performed by young boys belonging to the family. These boys are also the ox-handlers in most cases. It is difficult to ascertain the cost of such labour, since it does not require outlay of cash, and the opportunity costs for the boys will be limited, in financial terms. The head of the household may occasionally compensate his sons with a few Leones. Some authors recommend accounting for this supervision with some daily cost, but this leads to a severe overestimate of the real cash expenditure. In this paper, an annual cost of Le40 will be assumed.

Provision of salt varies considerably. Here it can be assumed to be a fixed cost of one cup of salt per week when oxen are not working, with a smaller cup every day during working periods (a variable cost).

Expenditure on health can be considered variable costs since it may be related to the stress of work. Although no imported drugs are currently available in the Koinadugu District, it is worth estimating what the cost of possible medicaments. According to the survey, the main health troubles are flies, ticks, worms and wounds. A budget can therefore be assumed for a chemical spray/dip against flies and ticks

("Supona" at Le40), a worming agent ("Coopane" at Le30), some wound powder ("Negasunt" at Le35) and some vaccines against major diseases (say Le30). These animal health items together cost about Le135. However in the present situation none of these drugs is available and farmers are buying traditional medicines or chemicals intended for other purposes from the local market; the survey indicated that 53% of loan recipients spent money for animal health reasons, with average figures of about Le10 per month. Thus an annual health budget of about Le120 per year seems realistic.

Housing and damage compensation

During working periods oxen are tied up at night, generally in the open in the backyard but sometimes in a room of an existing house. The building of a paddock is unusual and therefore the cost of housing is presently almost nil. During periods of inactivity (often the whole dry season) oxen may be sent to a large herd (warreh). In the survey, 32% of loan recipients did this. These people will pay Le10-40 per month, while the others will not have such charges. For the purposes of an illustrative budget, housing costs can be estimated at Le40.

Compensation payments for damage is an important cost identified during the monitoring and evaluation survey. If the animals cut their

ropes while grazing they may damage crops, and possibly hurt people. It was found that 27% of farmers obtaining a loan to buy oxen had to pay damages, with an average payment of Le67. An annual figure of Le50 should therefore be anticipated.

Cost of equipment

Most farmers have purchased Pecotool plows from the KIADP. Some plows are smuggled into the country from Guinea, but since these transactions involve black-market dealings, it is difficult to obtain realistic figures for the prices of such equipment. Only 19% of the loan recipients have a harrow and these implements will not be considered here. The value of a Pecotool equipment set in 1986 was Le800. Every year a farmer has to refund Le200 capital and the interest for the first year is Le120. Farmers may purchase at least one plow share a year costing Le40.

A farmer will have to buy ropes to control the oxen during grazing, whether they work or not. According to the survey, some farmers purchased thick nylon ropes costing Le40-60 which lasts one year, while others buy locally made ropes costing Le10-20 and lasting only 2-4 weeks. A realistic annual cost may be Le100. Yokes are bought from local blacksmiths at prices of Le10-20, with an expected life of three 3 years.

Total overhead costs

Using the figures discussed, the overall cost of introducing a pair of oxen and a plow can be estimated, as illustrated in Table 1.

Variable costs

The use of family labour (generally the young sons or brothers of the ox-owner) is normal for looking after oxen. The involvement of the head of the household as ox-handler is not common, and the hiring of labour to handle the oxen is rare. It is still worth including some value for this operation since family labour

Table 1. Estimated cost of introducing oxen

	Leone (Le)
Purchase of oxen	1050
Interest	330
Ropes and reins	165
Damage and compensation	50
Housing and keep	40
Grazing supervision	40
Salt	40
Health	120
Plow	360
TOTAL	2195

used to do ox plowing at a period of intensive farm operations could be used to perform manual work instead. Only one ox-handler is likely to be capable of much work, since the boy in charge of the control rope is often only 10 years old. A daily cash wage of Le6 without food can be included in the estimates.

During working periods ropes for grazing control and harnessing must be purchased regularly. According to farmers, harnessing ropes must be changed almost every week while grazing ropes last longer. A realistic budget for ropes could be a daily cost of Le1. The consumption of salt during working periods can be estimated at one small cup, costing Le0.50 a day. This gives a total variable cost of about Le8 per day. Thus employing oxen for 40 days a year might incur variable costs of Le300.

The costs of work oxen relative to the farm budget

The cash needed to support the introduction of animal power at the household level based on 1986 loan terms can therefore be estimated at about Le2500 during the first year. This is twice the overall annual labour expenditure at the household level in the area (Le1185). It is almost as much as the overall annual sales of agricultural products at the household level (Le2700). The cost of the Pecotool plow set at the beginning of 1986 represents 8 years of normal annual investment in farm tools. It is clear that investing in ox cultivation in an area where yields fluctuate greatly and where entire farms can be damaged by uncontrolled pests is likely to require a major financial effort.

Other sources of income will therefore be important for loan recipients, for example farmers may have additional income from trading, employment or chiefdom administration. The keeping of goats and sheep can be profitable, and these can be rapidly sold to meet the cost of loan repayments. For example the present value of a small herd of goats (one male, two females and three kids) is Le800, while sheep are even more valuable.

Potential benefits from animal power

The interesting question now is what kind of benefits a farmer introducing animal power can expect in the face of such an increase in fixed costs and operating risk. The potential savings using oxen for plowing will be considered here, since plowing is the operation most commonly performed by oxen at the farm level. In addition the bulk of present labour expenditure is incurred by primary tillage, as well as brushing (an operation which oxen will not perform).

During the rainy season, it was found that the average labour expenditure for swamp rice was Le170 ha⁻¹ or Le124 per household. During the dry season, labour expenditure (mainly for raised beds) was Le710 ha⁻¹ or Le300 per household. Thus in the present cultivation systems, there is certainly scope for savings in labour costs, particularly since ox-handlers are generally family labour. Savings with cash crops such as sweet potatoes, sweet peppers, tomatoes and groundnuts could alone be Le424 per household, or 35% of the overall annual labour expenditure.

Nevertheless for animal power to be economically viable, farmers will have to increase their farm area. According to the survey, the great majority of farmers do have access to suitable, uncultivated land, which they do not currently farm due to lack of money and/or labour. The cost of tilling additional swamp land by hand would be high (perhaps Le460 ha⁻¹), since family labour is already fully employed. Animal power could become more competitive with intensive use, and make additional farming more profitable, as long as new labour bottlenecks do not hinder the process.

Income from hiring

Hiring out oxen is already done by a majority (78%) of the loan scheme recipients after their preliminary year of use. The average hiring is for 11 days a year. Income from hiring during the year following animal power introduction is not high because the owner is not yet famil-

iar with the oxen and tries only to assist family and relatives. The survey indicated that most (63%) of the days worked during the first year of operation were for relatives, without cash payment. Hiring for cash was done only for an average of five days per set, for daily cash payments of Le27 in 1985, rising to Le50 in 1986. At the new rate, only 25 days of work would be needed to meet the first annual loan repayment for oxen and plow.

Appreciation of oxen value

In the present economic situation, it is difficult to quantify the real appreciation of oxen over a period of years, but it is clear that the increase in value of oxen makes ox cultivation a very attractive investment. Due to the combined effects of inflation and increase in weight, a two-year-old bull purchased for Le800 in 1985 could be sold for Le1450 in 1986. Provided oxen remain alive and are not stolen, farmers purchasing animals in 1985 have already made a theoretical profit in the region of Le1300. When compared with the overall expenditure incurred by the oxen and plow during the first year of Le2195, this appreciation indicates the importance of looking after the animals well. The simple fact that oxen are well looked after and stay alive will have as much economic effect on the farmer, as whether they are used for 10 or 60 days each year.

Conclusions

From the foregoing discussion, there is a clear need to make investment in animal power more viable and farming more profitable. One major way this could be achieved would be to promote the use of ox power for expanding farm size and for undertaking more farm operations. There are also important implications for the extension services. The animal health services in Koinadugu need urgent strengthening if they are to assist in the success of the credit scheme.

In conclusion, the future development of animal traction in the area will greatly depend on:

- The provision of an appropriate animal health service. This should be responsible for veterinary advice and drugs and also for disseminating information on proven traditional animal health practices. With problems of disease and injury, ox traction is a speculative investment and it is of paramount importance that oxen under work stress are well looked after so that they increase their weight every year.
- The provision of demonstrations of alternative uses of animal power, notably for ridging, so that farmers can assess the value of these practices.
- The provision of credit to individual farmers that have access to suitable land in order to allow them to invest in animal power. For maximum rate of reimbursement, farmers should offer strong assurance of repayment ability, and favourable criteria would include farmers who have previously owned cattle or oxen and farmers currently owning small ruminants.

References

- Corbel, H. 1986. Economic implications of animal power introduction at the farmer level: a case study. Paper prepared for the workshop "Animal power in Farming Systems" held 19-26 September, Freetown, Sierra Leone. Koinadugu Integrated Agricultural Development Project, Kabala, Sierra Leone. 29p. (E).
- Corbel, H. 1986. Introduction de la culture attelée au niveau du paysan: implications économiques. Paper prepared for the workshop "Animal power in Farming Systems" held 19-26 September, Freetown, Sierra Leone. Koinadugu Integrated Agricultural Development Project, Kabala, Sierra Leone. 27p. (F).
- Corbel, H. 1986. A few considerations about the work oxen loan scheme in the district of Koinadugu. Paper prepared for the workshop "Animal power in Farming Systems" held 19-26 September, Freetown, Sierra Leone. Koinadugu Integrated Agricultural Development Project, Kabala, Sierra Leone. 12p. (E).
- Corbel, H. 1986. Quelques considérations à propos du programme de crédit pour la diffusion de la culture attelée au Koinadugu. Paper prepared for the workshop "Animal power in Farming Systems" held 19-26 September, Freetown, Sierra Leone. Koinadugu Integrated Agricultural Development Project, Kabala, Sierra Leone. 14p. (F).

Farmer social variables influencing the adoption of agricultural innovations in Sierra Leone

by

M. L. S. Gboku

Department of Agricultural Economics, Njala University College, Sierra Leone

Introduction

Gabriel Tarde, an eminent rural sociologist who has devoted most of his intellectual career to the study of innovation diffusion, once said:

Our problem is to learn why given one hundred innovations conceived at the same time, ten will spread abroad, while ninety will be forgotten.

Another prominent scholar in this field stated that:

The advantages of modern agricultural science and technology have yet to effectively reach at least a billion small farmers throughout the world.
(Leagans, 1985)

These statements are very pertinent today. In order to find answers to these and similar issues, an increasing number of rural sociologists in many countries of the world have continued to expand the frontiers of knowledge in the field of innovation diffusion and adoption. The aim of this presentation is to share with you our understanding of this problem as it relates to Sierra Leonean farmers.

Adoption of innovations is a function of inter-related dimensions of the farmers' environment. This comprises many related factors including those that are technical, political, educational, institutional, social, physical, industrial, economic, religious, infrastructural and those which relate to communications. The

cause of low productivity in agriculture may be traced to a combination of these factors. However, the main concern of this paper is to explore the effect of one of these essential elements, namely the social dimension. This paper therefore aims at outlining some of the social factors that could be associated with the behaviour of Sierra Leonean farmers to the adoption of agricultural innovations in general, and the use of ox traction in particular. The paper focuses on the following specific aspects:

- The historical background of ox traction and its development to the present time in Sierra Leone.
- The role and importance of ox traction in agricultural/rural development.
- The potential challenges of ox traction.
- Some of the highlights of empirical research results on the adoption of agricultural innovations.
- Summary implications and recommendations for future research efforts.

In preparing this paper, I have drawn heavily on my experiences about the social characteristics of oxen farmers in Sierra Leone and how these relate to the use of ox traction and its associated agricultural innovations. Reference is made to research findings in other countries also. The reason for the strong bias for Sierra Leonean farmers' characteristics is that it makes it possible for me to narrow down the discussion of the problem and provide useful learning experiences relevant to this workshop.

History and development of ox traction in Sierra Leone

Plowing with oxen was first introduced into Sierra Leone around the Mabole valley in 1928 and has continued ever since. The influential Mandingo people who had settled in this part of the country for over seventy years had shown great interest in the use of ox plows since they were introduced into the area by some Mandingo migrants from Guinea about 55 years ago. In order to extend the area under cultivation on the Mabole valley and to introduce improved plows and promote farming among the Mandingoes, the Department of Agriculture initiated the whole Mabole valley plowing scheme in 1950. The scheme which included the supply of plows and oxen on loan to some members of a progressive farming community was frequently stated by official sources in Sierra Leone to result in increases in farm size (Gboku, 1983). In fact, in 1950, the Director of Agriculture categorically stated that all ox traction operation were successful. Unfortunately, it is not clear what specific information led to the assumptions of success and profitability.

Apart from the Mabole Valley plowing scheme, ox plowing schemes have also been tried in other parts of Sierra Leone including Bonthe, Rokupr and Koinadugu. Most of these latter schemes failed because of two major factors. Firstly there were general apathy and a lack of interest on the part of the farmers. Secondly there were mounting arrears of loans to the District Council which the farmers could not repay (Gboku, 1983).

The success of the Mabole valley scheme on the other hand depended to a large extent on the following factors:

- The suppression of the domestic slaves of the Limba tribe by the Mandingo tribe with consequent shortages of labour for agricultural activities.

- The Mandingoes were a cattle-owning tribe who understood how to look after their animals.
- Most of the inhabitants of the Mabole valley made their livelihood by trading in diamonds rather than farming. This caused labour shortages on the farms as youths migrated to mining areas.

Notwithstanding the above determining factors of the success of the Mabole valley scheme, the Mandingo ox owners faced practical problems among which were:

- Lack of suitable animals for draft purposes.
- Lack of plows that combined suitability and durability.
- Lack of knowledge among non-cattle farmers of how to take proper care of their oxen.
- Lack of training facilities for oxen farmers.
- Lack of adequate finance to support the scheme.
- Attack of animals by diseases. (Gboku, 1983).

With the establishment of the Work Oxen Project, many of the above problems have been eradicated while efforts are under way to combat the others. From 1977/78 to the present, the Ministry of Agriculture and Forestry Work Oxen Project has been working in cooperation with Njala University College and, with the support of British and French technical personnel, has carried out research on the use of draft animals and ox-drawn equipment. It has published its findings and initiated pilot extension programmes in cooperation with other projects and institutions (Starkey, 1981; Allagnat and Koroma, 1984). For instance, the Pecotool plows which combine durability and efficiency are now manufactured in the Project's workshop at Rolako while the Project's extension agents currently assist farmers in the training of their oxen teams.

The role and importance of ox traction in rural development

The importance of ox traction as a means of accelerating social and economic development in less developed countries is too well known to require much elaboration here. With the recent inception of the Work Oxen Project in Sierra Leone for instance, animal traction has gradually re-emerged as a topic in development policy and technical discussion after a long time of neglect as a relic of bygone days. With the present increase in the cost of conventional types of oil-based energy already having disastrous consequences for Sierra Leone, it could be speculated that the use of animal traction as an alternative source of energy in the future will continue to be of enormous importance for many agricultural holdings in the country.

While animal traction has been gradually replaced by engine power in most industrialized nations, it cannot be neglected in countries which are less developed in economic terms. Agricultural mechanization involving engine power farming has always been under severe criticism in developing countries. Some of the objections may be listed as follows:

- The nature of the tropical environment which has not lent itself in most areas to mechanical cultivation.
- High initial and running costs.
- High foreign exchange cost.
- Poor maintenance facilities as a result of lack of trained personnel.
- Dependence on fossil fuel.
- Farmers' inability to hire tractors.
- Mechanization is not suitable for fragmented and inaccessible holdings. It is conducive for use only on big farms.
- Mechanization increases productivity of labour but not necessarily farm productivity per unit of land area.
- Mechanization may be profitable for individual landowners but not for society.

- Appropriate technology is not available for developing countries to allow them to benefit fully from mechanization.
- Mechanization may lead to erosion problems thus rendering opened land unproductive within a very short time.
- Mechanization displaces labour and destroys employment. It encourages migration of labour from rural areas. Agriculture must be a reservoir to absorb the growing population, and thus mechanization must not be introduced as it reduces the job opportunities in agriculture. (Makajuola, 1977).

It would be frivolous to brush these criticisms aside since they contain elements of truth in varying degrees. However, few people would deny that the agriculture programmes in many developing countries, whatever the degree of mechanization, have been largely ineffective in terms of economic growth and social welfare. Against the background of this dilemma, the main concern should not be whether mechanization or the absence of it provides a more viable approach to agricultural development. More relevant is the problem of how to achieve a type of mechanization that has both real and widespread social and economic impact.

The potential and challenges of ox traction

Considering this complex mixture of problems and conflicting arguments connected with engine power farming, the use of animal power is one of the more attractive alternative energy sources. Work bulls can be used on small farms by peasant farmers who constitute over 70% of the population. The utilization of animal power is less taxing and perhaps more effective when compared with the use of human muscles. The power source is particularly applicable to the needs of small farmers in the Northern Province of Sierra Leone. This is because the power requirements are suitable for their small-sized farms and the technology is

adapted to the technical skills of farmers. Moreover there is easy access to work bulls and the accompanying equipment, and farmers in that part of the country have a tradition of keeping cattle.

The use of animal power, however, has its limitations. The major ones can be summarized as follows:

- It is limited to tsetse-free areas like the Northern Province of Sierra Leone.
- The cost of buying and maintaining the work bulls is becoming prohibitive. If the feeding of the work bulls is done properly, the value of work output may be barely enough to pay for the cost of feeding (Makajoula, 1977). This makes it uneconomical for the farmer to keep work bulls properly fed.
- The peak of the season's work with respect to the use of animal power comes at the end of the dry season. The dry season is usually a period of shortage of food for livestock consumption. In practice, the animals are not usually well fed during the dry season and are therefore weak and ill-prepared for the heavy work which follows the beginning of the rainy season. During the rainy season and harvest period when the animals get better food there is little work for them to do.
- There is a shortage of beef animals in the country and butchers have to compete with farmers for the available animals that can otherwise be trained for use as agricultural work bulls.
- Animal-powered equipment for various harvesting and post-harvest handling and processing separations is not easily available. There is, therefore, the need to use other power sources for these operations.
- High cost for draft animals usually goes far beyond the means of the average farmer.
- Smallholdings are scattered over large areas without adequate access to the road system.

- Poverty, low level of production, shortage of capital, and insecurity of income make agricultural investment difficult.
- Difficult land tenure systems resulting in fragmentation of holdings into irregular-shaped individual farms.
- The practice of mixed cropping in which different types of crops are grown on the same plot simultaneously, making the use of some agricultural equipment difficult.
- The traditional hand hoe technology is not easily adapted to the use of animal traction.
- Prevalence of cattle diseases makes the use of work animals risky.
- There is a need for a breed of cattle that is adapted to local conditions which can be used for milk and beef production as well as for draft purposes.

In the light of these problems, it would appear that animal power may soon become unsuitable and uneconomical to use. Consequently, one can only see animal power serving a transitory role as an introduction to the more suitable mechanical power which will put agriculture in this country in a better state. However, the criticisms advanced against engine power with regard to developing countries are even more difficult issues to face than those problems highlighted under animal traction. Hence the improvement of the limitations of ox traction constitutes the supreme task that should be taken up by the Work Oxen Project, if any meaningful increase in the output of food crop production is to be realized in the near future. Thus it is advisable to formulate future objectives in line with the issues raised, and to examine extension methods that can meet such objectives.

Social features of farmers and the adoption of innovations

The social characteristics of farmers influence the acceptance and use of agricultural innovations. Agricultural innovations can be taken to mean new ideas, methods, practices and tech-

nological improvements in agriculture which confer on it relative advantages over those ideas, methods and practices which are replaced (Alao, 1980). Ox traction and its associated technologies fall under this definition and in the following sections research findings on farmers' social features relating to the adoption of animal power in Sierra Leone will be reviewed.

An overwhelming proportion of adoption studies have used a bivariate analytical approach in predicting adoption behaviour of farmers. This involves the use of several independent variables to predict adoption of a given agricultural innovation. The focus of such studies centres on farmers' attributes as a major predictor or determinant of their adoption behaviour. Among the studies conducted in Sierra Leone are those of Gboku (1981, 1983, 1985) and Bangura (1983).

Age

All the above studies have shown that the mean age of Sierra Leonean farmers is between 45 and 55 years. Within the Work Oxen Project zone, the majority (56%) of the farmers were between 36 and 55 years. Only 18% of them were between 26 and 35 years, while few (13%) were of advanced age (about 65 years). This has serious implications for the adoption of agricultural innovations. In the first instance, those farmers of advanced age who may be willing and ready to accept new ideas do not have the physical ability to sustain the rigorous and arduous tasks required by the agricultural profession. On the other hand the younger farmers by tradition regard the older ones with respect because the latter possess and control most of the family resources that can be converted into economic units on the farm. Since the older farmers fear taking the risk of investing the available resources in farming, and because the younger ones could not afford these resources, the latter are often tempted to migrate to mining and urban areas to seek a livelihood thereby leaving the farm

base weak. Studies in Sierra Leone have however discovered no association between age and adoption behaviour of farmers. This finding is peculiar to Sierra Leone and a few other developing countries.

Education and literacy

A high proportion of our farming population is illiterate as very few have received formal education. Over 90% illiteracy was encountered among the farmers of the Mabole Valley area during an exploratory survey (Gboku, Allagnat and Koroma, 1983). Because of this, formal education during the subsequent survey was measured in terms of whether farmers ever went to school, rather than quantifying their years of schooling. Using this measure only 3% of farmers ever went to school. One possibility is that since the adoption of farm practices requires certain managerial skills which are often gained through education, it might be expected that as the educational level of the family increases, adoption of innovative farm practices will increase. However among the Mabole Valley farmers, no significant relationship was discovered between adoption and education (Gboku, 1983).

Family size

It is ironical that in the rural settings of developing countries farmers produce large families in their efforts to assure themselves food, but this hampers the very solution they seek. Among the Mandingo ox owners an average family size of 19 was recorded. Family size which is defined to include the number of wives and the number of children that are available to contribute to family labour has a positive relationship with the adoption of agricultural innovations by farmers (Gboku, 1983).

Social participation

Sierra Leonean farmers who participate actively in the life of the community through mem-

bership and leadership of social organizations such as farmers' cooperatives, thrift and credit societies and rotary credit (osusu) adopt more agricultural innovations than those who do not. This assertion is supported by the findings of Gboku (1983, 1985) and Bangura (1983).

Farm size

Agricultural production in rural Sierra Leone is based on smallholder farming. The average farm size of the farmers is in the range of 1.2-2.8 hectares. The implication here is that since holdings appear very small, farm production will not be high. This means that average farm income will be quite low and most individuals in farm families will live on the low incomes from these farms. Based on the average family size of 19 among the Mandingo ox owners and the mean farm area of 3.1 ha, the mean area per individual in the family is 0.16 ha. Assuming these individuals contribute some work to the farm operations, the areas actually cultivated by the individuals are very small, which makes one wonder whether farming of this kind can take up most of people's time. Farm size was found to be significantly related to the adoption of agricultural innovations by farmers (Gboku, 1983, 1985). This implies that larger farm size means more resources and a greater ability to take the risk involved in the adoption of innovations.

Dependence on farming

Almost all subsistence farmers engage in activities secondary to agriculture such as trading, tailoring, teaching, blacksmithing or local administration (including chieftom duties). This makes it obvious that the kind of farming practised by the farmers does not take up all of their time. Research findings in Sierra Leone (Gboku, 1983, 1985) discovered no significant relation between adoption and degree of dependence on farming.

Extension contact

One of the most important institutions created to serve the needs of farmers is the agricultural extension service. The main function of this service is to serve as a linkage between research agencies and farmers. In spite of the relatively small ratio of trained extension staff to farmers in Sierra Leone which is estimated at 1:1400 farm families, the extension agents are the most important source of information to farmers on agricultural innovations. However, research findings in Sierra Leone have reported low contacts between farmers and the extension agents (Lakoh, 1978; Gboku, 1985). Even where agent-farmer contacts were reported, such contacts in most cases were not for agriculturally related discussions (Gboku, 1983; Lakoh, 1978). A significant relationship between extension contact and adoption of agricultural innovations by farmers has been reported (Gboku, 1985; Bangura, 1983).

Social structure

What people do by tradition is mainly determined by the organization of the society and its culture. Social structure as used here is the way society is organized into families, clans, tribes, communities, clubs, etc. It is important to understand the structure of the society in which one is working, to know who makes the decisions; who are the people of real influence who deal with land allocation and what are the factors causing the division of people into groups. Many mistakes have been made in implementing development programmes in the past through lack of knowledge of village social structure or through ignoring its existence. According to the views of Linton in the 1950s, if we know what a society's culture is including its particular system of values and attitudes, we can predict with a fairly high degree of probability whether the bulk of its members will welcome or resist a particular innovation. The position of the above statement has been backed by many researchers. For instance, in a

study of the influence of locality groups on the adoption of new farm practices in 47 Washington townships in USA, it was concluded that the social structure of culture of locality groups is the major factor influencing the adoption of new farm practices (Ven Den Ban, 1960). This study discovered that a farmer with a high level of education, on a large farm with high net worth, but living in a township of low level adoption, adopted fewer new agricultural practices than a similar person living in a high level adoption township. The differential rate in the level of adoption was attributed to religious differences.

In more recent times, Fliegel's study of agricultural innovations in Indian villages also showed that high adoption villages have the following characteristics: relatively high level of living; lack of factionalism and disputes; presence of formal social organizations; several religious structures and a diversity of religious tradition in the village; and the presence of a number of voluntary organizations. In Nigeria, several village factors such as absence of major personal, political and tribal conflicts, presence of peace-loving tribes and agriculturally orientated people, participation in social activities, availability of social amenities as well as access to roads and market facilities have been considered to be positively related to adoption (Clark and Akinbode, 1968). Another study in Nigeria has also concluded that community structure exerts contextual influence on all other dimensions of explanatory variables in adoption study such as size of farm, innovation proneness, social participation, mass media exposure, and cosmopolitan influences (Alao, 1980).

It is unfortunate that adoption research is still at its embryonic stage and hence has not focused on structural and contextual variables as recognized dimensions of study. However, the following learning experiences among the Mandingo ox owners is worth presenting to members of this workshop.

Important findings from the Mabole Valley of Sierra Leone

Role of women in ox traction

Traditionally, some jobs are carried out by men and some by women. Each sex has customary duties in village life and agriculture. In the Mabole valley, virtually all the women had small farm plots of their own as well as providing much agricultural labour on the general farm at all times of the farming season. Women never owned oxen and neither did they operate ox teams. However they showed great interest in using oxen. All the wives of oxen owners reported using oxen on their own personal plots. The services were not on a hired basis even though they paid some compensation to the operators in kind (food, kola nuts, cigarettes) as most of the oxen operators were the husbands or children of the women. On the other hand, wives of non-oxen owners hired oxen teams for their personal plots just like their husbands did for the general farms.

Role of blacksmiths in ox traction

In any typical African rural setting, the blacksmith has always maintained his position as the main source of agricultural tools and weapons such as cutlasses, hoes, knives, axes and guns. In the Mabole valley, all the farmers contacted said they obtained their tools from the blacksmiths. In addition, 100% of the oxen owners reported the blacksmith as repairer of all major damage done to their plows. Because of the indispensable services of the blacksmiths, all operations on their farms are done by the farmers within reach of the blacksmith services. In addition to the agricultural labour offered, the farmers also construct the blacksmith's forge building and pay minimal charges for the repair of old tools and the manufacture of new ones such charges are negotiable.

The general position of farmers towards ox traction

Using the categories of households for ox owners, non-ox owners in ox villages, and non-ox owners in oxen villages, some differences in their characteristics were identified in the Mabo Valley:

- The oxen owners are all Mandingoes. They are generally more engaged in farming activities, and they have bigger farms often about 2.5 hectares with some of them owning very large farms of more than seven hectares. Among the ox owners the main differences between the two categories (those in ox villages and those in non-ox villages) are due to their origin within the Mandingo or Limba communities.
- The Mandingo non-ox owners have the same cultural and social background as the ox owners but due to lack of credit facilities, the former cannot afford to acquire their own oxen. They have smaller households and farms compared to the ox owners. Their family members are usually less actively involved in farming activities.
- The Limba non-ox owners, which includes in fact all the Limba farmers in the area, are characterised by their own cultural background, different social settlements, different customs and religions. They usually have small farms (1.2 ha), but the few of them who can get more labour have bigger farms (up to 4 ha).

Implications and suggestions for future research efforts

The importance of social factors among farming families for rural development and animal traction is quite clear. Each of the variables discussed in this paper has a direct effect on increased primary agricultural production and agriculturally related enterprises which may be of concern to rural development practitioners. Thus a clear understanding of each of these

factors is essential in the formulation of policies aimed at achieving major objectives of agricultural and rural development.

Family size is a factor that has to be considered when comparing household incomes, farm sizes and labour supply for agricultural production in different parts of rural areas. The size of the family indicates the potential labour force per farming family and the expected number of people to be fed.

Average age and age distribution of both the household heads and their families affect the level of productivity. The labour supply for agricultural production purposes is mainly from the rural farming families or household heads. Studies of traditional agriculture indicate that average age and age distribution among farming families have a direct bearing on the following:

- Availability of able-bodied persons for primary agricultural production.
- The level of risk aversion and ease of adoption of innovations.
- The degree of mobility of farmers, which determines the ease with which farmers can migrate from rural to urban areas or from high population density areas to low population density areas and apparent land surplus areas.
- The size of the farm, as the farmers tend to reduce area to what they can cope with in the event of diminishing family labour and either scarce, or costly, non-family labour. (Kireta-Katewu *et al.*, 1983)

Educational status of the farmers has a significant effect on their adoption of innovations since education sharpens the farmers' managerial abilities. Since the majority of the farmers have had no formal education, rural development programmes have to be careful in developing technological packages of agricultural transformation that are simple enough to be understood, accepted and put to use by the farmers. Nevertheless, farmers are likely to adopt

whatever technology is introduced if it proves profitable.

Since knowledge about recommended farm practices and evidence of their utility are available in the environment, adoption is expected to increase as contact with the environment increases. In this regard, the organization and participation of farmers in formal social groups such as group farms, farm cooperatives and farmers' credit unions are crucial for rural development programmes. Such social organizations, it is envisaged, will expose the farmers to contact with extension staff and other personal sources of farm information. Social organizations could also enhance the exchange of relevant ideas and so put farmers in a favourable position to accept and adopt innovations.

References

- Alao, J. A. 1980. Understanding small farmer adoption behaviour: the Nigerian experience. Inaugural lecture series No. 44. University of Ife Press, Ile-Ife, Nigeria. (E).
- Allagnat, P. 1984. Methodology for on-farm research: the case of a socio-economic survey of the use of ox traction in the Mabolé Valley of Sierra Leone. Sierra Leone Work Oxen Project, Freetown, Sierra Leone. 91p. (E).
- Allagnat, P. and Koroma, B. 1984. Socio-economic survey of the use of ox traction in the Mabolé Valley, Bombali District. Sierra Leone Work Oxen Project and Association française des Volontaires du Progrès, Freetown, Sierra Leone. 119p. (E,F).
- Bangura, A. M. 1983. Farmer motivation patterns in participating in adaptive crop research trials in Sierra Leone. Iowa State University, Ames, Iowa, USA. (unpublished). (E).
- Clark, R. C. and Akinbode, I. A. 1968. Factors associated with the adoption of three farm practices in the Western State of Nigeria. Research Bulletin No. 1, Faculty of Agriculture, University of Ife, Ile-Ife, Nigeria. (E).
- Duncan, E. R. 1974. A role for the University of Ife in the adoption of three farm practices in the Western State of Nigeria. Inaugural Lecture Series No. 23, University of Ife Press, Ile-Ife, Nigeria. (E).
- Fliegel, F. C. *et al.* 1968. Agricultural innovations in Indian villages. National Institute of Community Development, Hyderabad, India. (E).
- Gboku, M. L. S. 1981. The relationship of farmer characteristics to the adoption of recommended farm practices in the Luawa Chiefdoms. B.Sc. Thesis, Faculty of Agriculture, Njala University College, Sierra Leone. (E). (unpublished).
- Gboku, M. L. S. 1983. An investigation into the historical and socio-economic background of oxenisation in the Mabolé valley. Work Oxen Project, Freetown, Sierra Leone. 100p. (E). (unpublished).
- Gboku, M. L. S. 1985. Evaluation of the extension programme of Njala University College, Sierra Leone. M.Phil Thesis, University of Ife, Ile-Ife, Nigeria. (E). (unpublished).
- Karimu, S. and Richards, P. 1980. The social and economic impact of planning for rural changes in Northern Sierra Leone. Occasional Paper 3, School of Oriental and African Studies, University of London. (E).
- Kireta-Katewu, P. R. *et al.* 1983. Baseline socio-economic survey report of agriculture in Sierra Leone. (E). (unpublished).
- Lakoh, A. K. 1978. Analysis of communication patterns within agricultural development systems in Sierra Leone. M.Phil Thesis, University of Ife, Ile-Ife, Nigeria. (E). (unpublished).
- Leagans, P. J. 1985. Adoption of technology by small farmers: a model for strategy builders. *Journal of Extension Systems* 1: 1-22. (E).
- Makajuola, G. A. 1977. Agricultural mechanization in Nigeria: The prospects and promises. Inaugural Lecture Series No. 25, University of Ife Press, Ile-Ife, Nigeria. (E).
- Starkey, P. H. 1981. Farming with work oxen in Sierra Leone. Ministry of Agriculture, Freetown, Sierra Leone. 88p. (E).
- Ven Den Ban, A. W. 1960. Locality group differences in the adoption of new farm practices. *Rural Sociology* 25. (E).

An assessment of some aspects of work oxen use in Sierra Leone

by

R. D. Bell and D. C. Kemp

AFRC-Engineering (formerly NIAE), Silsoe, UK

Abstract

The paper is based on a study of the viability of the Work Oxen Project made by A. A. Metianu and D. Vose in January 1986.

The use of ox power in Sierra Leone decreased from the 1950s to the 1970s. Some of the circumstances contributing to this decline have changed in recent years. The Work Oxen Project, based originally at Njala University College, has successfully identified and alleviated some of the constraint to ox use, notably by the provision of satisfactory implements and by training and extension activities.

Inland valley swamps are potentially the best areas in which crop production may be increased and it appears that replacement of hand work by ox draft for primary cultivation typically doubles the area cropped. Although such a change may increase the hired labour requirement on the extra land there is a net cash benefit. A significant part of the income is due to the appreciation in the value of the oxen over their working lives. Additional benefits could be derived by the use of ox power for other farm operations or for transport. The cost of the implements could be reduced by changes in manufacture or procurement or by the introduction of alternative equipment.

There is potential to increase rice production by expansion of the use of ox power but its realization depends on technical and social changes for which a major programme of trials, development and extension is needed.

Introduction

Ox plowing was introduced in Sierra Leone in the 1920s. During the 1950s to 1970s the use of

work oxen decreased until only in Koinadugu District and the Mabole Valley were oxen still worked. The reasons for this decline are not fully known but contributory factors may have been:

- Low profitability of arable crops.
- Availability of tractor hire at subsidized rates.
- Unsuitability of ox plowing for poorly stumped land (slash and burn shifting cultivation is the dominant upland system).
- Cultural factors - most of the oxen are owned by pastoralist Fulah who have little activity in crop production.
- The high value of cattle relative to arable production.
- Non-availability of plows for animal traction.
- Exchange rates and controls which depressed commodity prices and limited imports of equipment and spares.

In the late 1970s Sierra Leone was not self-sufficient in rice (the principal cereal), the public sector tractor hire scheme was inadequate and uneconomic, production on the 350,000 small farms was limited mainly by labour availability and there was no large landless labour force available. Land appeared to be in surplus with only 10% of potential arable land under cultivation. The national herd of approximately 330,000 cattle was almost entirely of the trypanotolerant N'Dama breed, well-suited to plowing and light cultivation (Kanu, 1984).

The Work Oxen Project

From the foregoing it appeared that conditions were favourable for much wider use of animal draft but constraints included:

- availability and cost of oxen in areas where required;
- availability and cost of implements;
- need for training of oxen and operators.

The Work Oxen Project (WOP) was established at Njala University College in 1979 to investigate these problems and to promote the use of work oxen by dissemination of technical information and by collaboration with existing organizations and departments. A research, development and equipment evaluation programme was initiated in 1979, and crop production trials using work oxen began in 1980 (Starkey, 1981).

In 1980 the Koinadugu Integrated Agricultural Development Project (KIADP) implemented a work oxen component providing ox-training at Musaia and, subsequently, a credit facility. It is anticipated that soon four of the six current IADPs will have work oxen components.

In 1982 the Rolako equipment centre was set up to manufacture and service plows and other equipment, and to develop equipment suited to local needs. The Work Oxen Project grew from an informal initiative and marshalled substantial support from a number of aid agencies. By January 1986 about 350 plows had been produced at Rolako using components supplied under aid programmes.

In January 1986 there were approximately 200 pairs of working oxen in Koinadugu District and 70 pairs in the Mabile Valley. An additional 30 pairs were in use, mainly by projects in other areas. The number of oxen pairs in Koinadugu District appears to have increased substantially over recent years (KIADP, 1985).

Initially the Work Oxen Project (WOP) concentrated on identification and selection of suitable equipment, supply of equipment and investigation of the technical aspects of the use

of work oxen. Later, WOP demonstrated that by using oxen, farmers who had previously relied on manual cultivation with machete and hoe could substantially increase the area cropped. In Koinadugu they appear to have doubled the area of swamp and boliland cultivated per family. The project is now in an extension phase.

Economic and technical assessment

As the Work Oxen Project entered a new phase in 1986, an assessment of the economic and technical potential of using work oxen was made by Metianu and Vose (1986). Their major conclusions were:

Potential in upland farming systems

Approximately 80% of the potentially arable land is upland of relatively low fertility currently cultivated under a slash and burn shifting cultivation system. The land is not clean stumped and so is better suited to manual cultivation than to ox cultivation. Although only 10% is cultivated at any time, reduction of the fallow period could lead to a reduction of soil fertility.

Potential in inland valley swamps

The inland valley swamps are relatively fertile but are less attractive to the traditional farmer because of the problems of initial clearance of swamp vegetation and because of unhealthy working conditions. The present land tenure system grants rights to the use of land but does not provide security of tenure. These swamps offer the greatest potential for increase of crop production by use of draft animals but there is need for land development and water control also. However these developments are unlikely to be made without security of tenure to farmers.

Potential in bolilands

Bolilands are poorly drained areas, generally of low fertility. They appear physically suited to mechanized or animal draft cultivation but a financial and economic analysis indicates that

Table 1. Simplified economic analysis of swamp and boliland rice production with or without oxen

	Swamp Le/ha	Boliland Le/ha
<i>Without oxen</i>		
Gross output	7499	3659
Seeds	272	272
Labour	3705	3705
Gross margin	3522	(-318)
<i>With oxen</i>		
Gross output	7499	3659
Seeds	272	272
Labour	2717	2717
Oxen	84	207
Gross margin	4303	440

Notes:

Major assumptions: Yields: swamp 1850 kg ha⁻¹; boli 900 kg ha⁻¹. Prices: Le2.55 kg⁻¹ husked rice at farm gate. Farm sizes: without-oxen farm is 2.8 ha, with 1.4 ha upland rice, 0.7 ha swamp and 0.3 ha boli; with-oxen farm is 3.8 ha, with 1.4 ha upland rice, 1.4 ha swamp and 0.6 ha boli. Fuller details of economic analysis can be found in the report of Metianu and Vose (1986).

The local currency, the Leone, has changed greatly in value in recent years, so that international comparisons are difficult. At the time of the report of Metianu and Vose, Le1 = US\$0.17. At the time of the Net-

at prices prevailing in January 1986 the farmer had no financial incentive to cultivate more rice in the bolilands.

Technical performance

Monitoring of farms suggests that farmers using oxen are likely to grow double the area of lowland rice (both swamp rice and bolilands) compared to farmers relying on hoe cultivation (Allagnat and Koroma, 1984). Typically household labour provides up to 75% of total labour on manually cultivated farms. Although ox plowing can reduce labour demand for cultivation, the additional area of rice will require more labour for other operations unless these too are modified to facilitate the use of oxen for planting, weeding and at harvest.

Table 2. Annual cost of oxen and implements

	Le
a) Oxen	
Purchase cost of pair (160kg, Le6.50/kg)	2100
Sale price after 5 years (340kg, Le6.50/kg)	4500
Capital gain over 5 years	2400
Capital gain per year	480
Ownership costs (per year)	
Risk of loss, 2% of average value	70
Repayment of loan and interest	580
Salt and medicines; housing	40
Total annual costs	690
Net annual cost	210
b) Implement and Harness	
Cost of Pecotool	1100
(imported cost Le 7.8 = UK £1)	
Annual depreciation (over 10 years)	110
Interest @ 15% of 1/2 cost	82
Ropes and yoke	58
Total annual cost	250
c) Total Annual Cost of Oxen and Implements:	460

Economic performance

By increasing the area cultivated the farmer increases his gross return and gross margin on the inland valley swamp. However, on the boliland where yields are low it appears that extra production on an area beyond that for which household labour is available is not financially attractive. Nevertheless it must be noted that in economic terms even the bolilands show a positive gross margin (Table 1). (Note: the local currency, the Leone, has changed greatly in value in recent years, so that international comparisons are difficult. At the time of the report of Metianu and Vose, Le1 = US\$0.17. At the time of the Networkshop for which this paper has been prepared, Le1 = US\$0.05.)

Cost of ox plowing

Major components of the cost of ox plowing are the costs of owning and maintaining animals and equipment (Tables 2 and 3).

Oxen costs (figures in Leones at 1986 values)

Oxen for plowing are purchased at about 160 kg and if used for 5 years should attain a weight of about 340 kg. At a price of Le6.50

Table 3.
Cost of oxen and implement per work day

Days worked per year	10	20	30	40	50
Annual cost	460	460	460	460	460
Variable cost	70	140	210	280	350
Cost per day	52	30	22	18	12

Notes:

Variable costs per day:

Ox handler Le 6.50, salt Le 0.50, Total Le 7.00.

Typically oxen work 20-40 days per year.

Typically oxen are hired out to other farms for about 10 work days, at a rate of about Le 30 per day.

See note on Table 1 concerning the value of the Leone.

sumed that this is by unpaid family labour. When working, extra salt and labour for driving oxen add a cost per work day of Le7. Typically oxen are used for 30-40 days per year of which 20-30 are in hire service to other farmers. Hire rates are Le 20-40 per day. The risk of loss or death of oxen has been assumed to be 10% over 5 years or 2% of average value per year but there is little firm data concerning the health and weight gain of work oxen away from the main pastoral areas.

per kg a pair of oxen is purchased at Le 2100 and sold at Le 4500, an annual increase of Le 480. There is some risk of loss by accident or theft, and if purchased on credit at 15% interest, the net annual appreciation of the oxen pair will be about Le 210.

For maintenance and security the oxen will need salt, medicines and simple nousing, resulting in annual costs of about Le 40. The animals must also be herded. In this paper it is as-

Implement costs

The Pecotool was selected early as technically the most appropriate tool for Sierra Leone. It is a versatile toolbar which can be fitted with 6" or 9" plow or tools for inter-row cultivation. It is made of good quality steel; it is light and easy to handle. It is however expensive, costing Le 1100 as an imported item assembled at Rolako. If supplied as a plow only, the cost could be reduced to Le 850. Local manufacture using imported material and local labour has so far

proved more expensive but a simplified version might cost only Le 642. Alternative simpler plows, or plows of lower quality are available at prices of Le440 - Le820 landed in Freetown (Metianu and Vose, 1986). It appears preferable therefore to use the resources of Rolako for service and repair of plows, for extension, and for the development of ox equipment. The annual cost of the Pecotool plow (depreciated over 10 years and with interest at 15%) is Le 200.

Table 4. Change in cash flow due to use of oxen

	Yrs 1-4	Yr 5	Yrs 6-9	Yr 10
Extra crop income with oxen (Table 1)	4190			
Extra income by hiring out oxen	300			
Extra costs of seed and labour	-2670			
Extra gross margin due to oxen	1820			
Extra costs of working oxen (excluding herding cost)	-320			
Net extra income	1500	1500	1500	1500
Capital				
Repayment on ox loan (2100/5)	-420	-420		
Repayment on implement (1200/5)	-240	-240		
Interest on ox loan	-160	-160		
Interest on implement loan	-80	-80		
Sale of 2 oxen @ 340 kg	4500	4500		
Purchase of 2 oxen @ 160kg	-2100		-2100	
Purchase of new implement				-1200
Capital income (+) or payments (-)	-900	+1500		+1200
NET cash flow due to oxen per year	600	3000	1500	2700

Average extra income: Le 980 during first 5 years, Le 1410 during first 10 years

Notes:

See note on Table 1 concerning the value of the Leone.

Assumes typical farm in Northern Region.

If risk of loss or death of oxen is 2% per annum this represents an annual cost of Le 70.

Conclusions

By using oxen the farmer may increase the area his family cultivates and so increase his net income. However, the capital investment is more than his total present annual gross margin. If credit is available at 15% then by using oxen he may double his area of swamp rice and increase his gross margin by 15%. At present hire rates for oxen, it is also financially attractive for the farmer who does not own work oxen to hire them when required (Table 4).

Widespread use of ox plowing could result in an increase of rice production sufficient for national needs. Such an increase is however unlikely unless credit is available for purchase of oxen and plows and unless farmers have security of tenure so that they can develop their land and introduce more continuous cropping. A major programme of evaluation and development and of extension to introduce ox power for all farm operations is necessary before such social changes occur. The cash flow benefit from owning oxen is low for the first 4-5 years and is sensitive to crop yield on

the additional area cultivated. Major cash benefits depend on sale of oxen at the end of their working lives and this is very sensitive to any failure to gain weight at the predicted rate. It is likely that some form of staged replacement would provide a satisfactory return in practice.

References

- Allagnat, P. and Koroma, B. 1984. Socio-economic survey of the use of ox traction in the Mabole Valley, Bombali District. Sierra Leone Work Oxen Project and Association française des Volontaires du Progrès, Freetown, Sierra Leone. 119p. (E,F).
- Kanu, B. H. 1984. The economics of work oxen in Sierra Leone. Sierra Leone Work Oxen Project, Freetown, Sierra Leone. (unpublished). (E).
- KIADP 1985. Monitoring and Evaluation Reports of Musaia Ox Unit. Koinadugu Integrated Agricultural Development Project, Kabala, Sierra Leone. (unpublished). (E).
- Metianu, A. A. and Vose, D. 1986. Report of visit to Sierra Leone in January 1986 to study the viability of the Work Oxen Project. Overseas Division, National Institute of Agricultural Engineering (NIAE), Silsoe, U.K. (unpublished). (E).
- Starkey, P. H. 1981. Farming with work oxen in Sierra Leone. Ministry of Agriculture, Freetown, Sierra Leone. 88p. (E).

Preliminary observations on the effect of draft work on growth and trypanotolerance of N'Dama oxen

by

S. Ravindran

*Veterinarian and Leader of the Animal Traction Research Programme,
Central Agricultural Research Institute, Suakoko, Liberia*

Introduction

There is a general feeling among many farmers, livestock owners and agricultural technicians that the utilization of N'Dama for draft work can adversely affect the growth performance and disease tolerance of the animal. This feeling is based mainly on the slow growth characteristics, small size and the close genetic association of N'Dama with other beef breeds. The belief is also probably due to the general concept that draft work can break down the *trypanotolerance* of N'Dama in areas of tsetse infestation. The prevalence of this belief in Liberia prompted the Central Agricultural Research Institute (CARI), Suakoko, to investigate the actual situation in a very limited way. Animal traction technology is currently only at an experimental stage in Liberia and the only work animals in the country are at CARI. Therefore information gathered here may only relate to N'Dama draft oxen managed on-station.

Materials and methods

Tsetse population (*Glossina palpalis*, *G. pallicera pallicera* and *G. fusca*) and their challenge are considered medium at Suakoko where this investigation was carried out. Tsetse sampling was carried out in the area with biconical traps by the Bong Mine Trypanosomiasis Research Unit of the Tropical Institute, Hamburg, in 1984-1985. Although *Trypanosoma vivax* and *T. brucei* were revealed from blood samples examined in the area, the most

common species generally encountered was *T. congolense*. Positive serological reactions were observed for 80% of the untreated N'Dama cattle examined in 1984.

On August 20, 1984 sixteen young apparently healthy N'Dama castrates aged between 2 to 3 years were selected by draft characteristics to take part in this trial. Initial selection of all animals was also based on the negative findings of trypanosomes in blood samples examined. However, sera from the experimental animals were not checked for antibodies to trypanosomes. Faecal samples from all animals were also screened for parasitic eggs and those found positive were treated with *Thiabendazol* (Merk Sharp Dhome) at the rate of 110 mg per kg body weight ten days prior to the actual starting of the experiment. After the initial body weights for all animals were recorded, they were divided into two equal groups having approximately the same body weights (1/9/84).

Twenty-five acres of signal grass (*Bracharia brizantha*) pasture intercropped with legumes (*Centrocema* and *Stylosanthis*) were used for pasturing the animals. Both groups were managed together in the same field and were allowed free grazing. Animals were permitted to remain in the pasture day and night. They were not sheltered but had access to the barn during rain at their free will. The working group was naturally deprived of grazing for about two hours a day during the training period of 5 weeks and approximately 4 to 5 hours a day for six days a week during the working period of approximately one year. All animals

Table 1. Growth rate of working and non-working N'Dama oxen at CARI 1984-85

Date	WORKING GROUP (N=8)				NON-WORKING GROUP (N=8)			
	Live-weight (kg)		Monthly gain (kg)		Live-weight (kg)		Monthly gain (kg)	
	Total	Mean	Total	Mean	Total	Mean	Total	Mean
Sept 84	1456	182			1440	180		
Oct 84	1460	183	4	0.5	1528	191	88	11
Nov 84	1504	188	44	5.5	1568	196	40	5
Dec 84	1592	199	88	11	1616	202	48	6
Jan 85	1704	213	112	14	1696	212	80	10
Feb 85	1808	226	104	13	1768	221	72	9
Mar 85	1920	240	112	14	1856	232	88	11
Apr 85	2046	256	126	16	1912	239	56	7
May 85	2136	267	90	11	1960	245	48	6
June 85	2248	281	112	14	2032	254	72	9
July 85	2368	296	120	15	2096	262	64	8
Aug 85	2464	308	96	12	2176	272	80	10
TOTAL GAIN		1008			736			
PERCENTAGE GAIN		69%			51%			

had access to clean drinking water and mineral licks at all times. Animals in both groups were not provided with supplementary feeds or fodder until the end of the experiment.

The working group of eight animals were trained for agricultural traction as described by Starkey (1981). Ox plowing and harrowing equipment for work was purchased from the Sierra Leone Work Oxen Project. Working of animals was 4 to 5 hours per day, six days a week, and continued till the end of the experimental period of one year. Oxen were always used in pairs and were pulling implements that had a weight of 40 kg at an approximate speed of 2.5 km/hour. Plowing and harrowing of well developed and partially developed upland and swamps were the only work performed by the group.

Animals in both groups received hand spraying of 0.1 to 0.2% *Asuntol* (diethyl phosphorothioate manufactured by Bayer) once every 2 to 3 weeks for external parasites (mainly ticks) and a drench of *Thiabendazol* at the rate of 110 mg/kg body weight once every two months for intestinal nematodes. Animals in both groups

were weighed once every month and their body weights recorded. Blood samples from all animals were collected once every month (before 8 a.m.) for detection of trypanosomes and determination of Packed Cell Volume (PCV) percentage. Examination of blood for trypanosomes was carried out both by Haematocrit Centrifugation Technique (HCT) and by miniature Anion Exchange Centrifugation Technique (mAECT).

During the course of the experiment chemotherapy was not employed for those that developed parasitaemia. This was to help measure the natural duration of parasitaemia, and to observe the animals' ability to overcome anaemia and to eliminate the parasite.

The effect of agricultural traction on the growth rate of the working group was determined by comparing their average weight gain percentage for one year with that of the non-working group. The effect of work on the trypanotolerance of work animals was determined by comparing the intensity of anaemia and the intensity and duration of parasitaemia in natural infections with that of the controls.

Anaemia was estimated by measuring the PCV.

Results and discussion

Reports indicate that N'Dama draft animals can work and thrive under village conditions and that they can sustain an average traction of 14 per cent of their body weight, while the figure for other breeds is 10 to 12 per cent (Starkey, 1984). However, the natural tsetse challenge in such areas is not mentioned.

The management and nutritional requirement of N'Dama draft animals in tsetse-infested areas for varying levels of tractive effort and speed is not clear. In our trial at CARI where the tsetse challenge is medium, the N'Dama oxen aged 2.5-3 years and managed under a good pasture grazing system without supplementary feeds when used for moderate agricultural traction had gained significantly higher body weights in one year compared to non-working animals managed under the same conditions (Table 1).

It was noticed during the initial period of weight recording that the growth rate of draft animals was slower than that of the controls (October, November 1984). This may have been due to the sudden exposure of the animals to training and work, which their subsequent faster weight gains suggests. Weight recordings carried out for a one-year period indicate that work animals had 18% higher body weight gains at the end of the experiment compared to the controls. The actual reason, although not clear, may be the moderate work which improved appetite and thereby the intake of fodder at grazing.

Starkey (1984) has quoted Reh and Horst (1982) that N'Dama draft cows in Sine-Saloum in Senegal had significantly higher carcass weights than females maintained in herds, they had higher dressing-out percentages and they fetched higher live-weight prices from butchers. He further quotes that the improve-

ments in performances of draft cows over traditionally maintained herds are attributable to the higher levels of management, supervision and nutrition given to draft animals. Although the above observation pertains to draft cows under a traditional system of management, it is possible to believe that the same may also hold true for draft oxen. However, in our experiment the level of feeding, attention and supervision was the same for both working and non-working animals.

The trypanotolerance of N'Dama is believed to depend upon the N'Damas' inherent capacity to control and reduce parasitaemia. It is also believed to be related to their superior innate immune response. According to Murray, Trail and Wissocq (1983) trypanotolerance can be supplemented or reduced by a number of factors affecting the host and its environment. The factors include stress (work, pregnancy, parturition, lactation and suckling), intercurrent disease and poor nutrition. According to Murray and his co-workers the most important factor that would affect the stability of trypanotolerance is the severity of trypanosomiasis risk to which animals are exposed. As the level of risk increases the productivity falls and that the N'Dama can suffer severely from disease, leading to stunting, wasting, abortion and even death.

In our experiment two animals each from the control and working groups exhibited parasitaemia (*T. congolense*) during the one-year period. The Haematocrit Centrifugation Technique employed was not enough to reveal trypanosomes in any of the cases. Parasitaemia could not have been detected if miniature Anion Exchange Centrifugation Technique had not been employed. Although none exhibited clinical symptoms, the intensity of parasitaemia and anaemia measured was greater for the controls than for the work oxen. The duration of parasitaemia was also observed to be longer (3 months) for the controls than for the work animals (1 to 2 months).

The better health status of the work animals as evidenced by their higher body weight gains probably helped them to resist the anaemia and to eliminate the trypanosomes more quickly from their blood. However, because sera from these animals were not checked at the outset of the experiment for antibodies to trypanosomes, it was not possible to understand if any of them had previously suffered from the disease. Animals with previous experience of trypanosomiasis are known to eliminate the parasites faster than others. Furthermore, animals revealing parasitaemia were few for both groups and therefore observations made here may not have high statistical significance. Thus from the limited observations made so far, trypanotolerance of work oxen appears superior as evidenced by low parasitaemia and anaemia and their ability for faster elimination of trypanosomes. The experiment continues.

Summary and conclusion

In areas of medium tsetse challenge, N'Dama work oxen gained 18% more body weight in one year than controls maintained under the same pasture grazing system. On the basis of a few observations, the trypanotolerance of work oxen was also noticed to be superior under conditions above as evidenced by their low parasitaemia and anaemia, and their ability for the faster elimination of trypanosomes.

References

- Murray, M., Trail, J. C. M. and Wissocq, W. 1983. Livestock productivity and trypanotolerance: network training manual. International Livestock Centre for Africa (ILCA), Addis Ababa, Ethiopia. 98p. (E/F).
- Starkey, P. H. 1981. Farming with work oxen in Sierra Leone. Ministry of Agriculture, Freetown, Sierra Leone. 88p. (E).
- Starkey, P. H. 1984. N'Dama cattle, a productive trypanotolerant breed. *World Animal Review* 50: 2-15. (E,F,S).

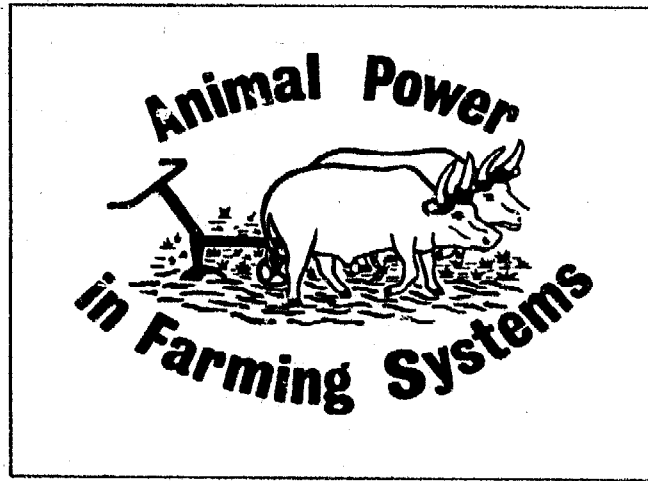

Animal Power in Togo

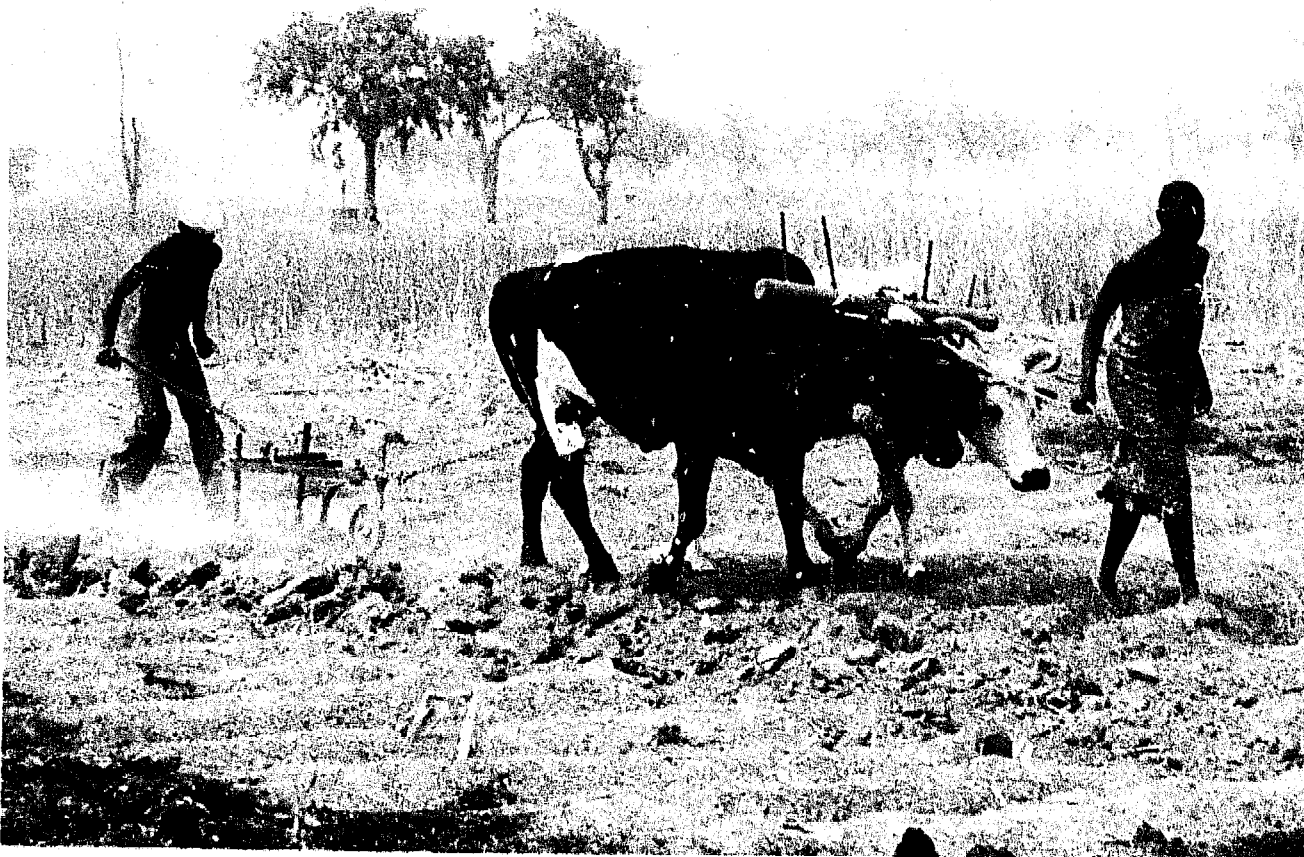

Title photograph (over)

Tine cultivation of old ridges using a "Triangle" cultivator at Broukou, near Kara, Togo

(Photo: Paul Starkey)

Features of animal traction adoption in Togo

by

A. S. Westneat, A. Klutse and K. N. Amegbeto

Projet pour la Promotion de la Traction Animale (PROPTA), Atakpame, Togo

Introduction

The Republic of Togo is an agricultural country of 56,600 square kilometres located between Ghana and Benin on the West African coast. It is divided into five economic regions: Savanes in the far north, Kara, Central, Plateaux, and Maritime in the south (see Figure 1). An estimated 3.05 million people live in Togo, of whom 77%, or about 2.35 million, live in the rural sector. Of those in the rural sector about 43%, or 1.01 million, work in agriculture. Average agricultural-sector per-capita income in 1982 was 38,200 CFA or US\$98 (IBRD, 1984).

The primary source of power in this agricultural sector is human hand labour, notably family farmers equipped with hoe and machete. When the 1976-77 government-sponsored effort to modernize agriculture using tractors failed, both development and political authorities concluded that another approach was needed. They turned to oxen power; that is, to animal traction.

This paper addresses several of the more prominent features of animal traction adoption in Togo today. After a brief historical overview, several specific factors which indicate the scale of animal traction adoption are presented. This is followed by a synopsis of the conditions which have contributed to the success of animal traction in the Savanes. The paper concludes with a discussion of several aspects of farm management involved in the transition from hoe to animal traction technologies in the Kara and Central Regions.

In 1986, the animal traction promotion project PROPTA (Projet pour la Promotion de la Traction Animale), in association with the Advanced School of Agronomy at the University of Benin (Lomé), sponsored a systems study of hoe and animal traction farming in the Kara and Central Regions and, more precisely, of the transition from one to the other. This paper benefits from some of the preliminary results of that study, results which should be of interest to participants in this Sierra Leone networkshop.

Historical overview

By the time the Togolese government came to select the animal traction policy option, animal traction was not new to Togo. Earlier, it too had been tried, had failed, and had been discarded. In fact, animal traction in Togo dates as far back as the German colonial era. In May 1900, the Berlin Colonial Economic Committee, in the hope of increasing cotton production, hired a team of black American experts from Tuskegee Normal Industrial Institute (Tuskegee, Alabama) to introduce animal traction in Togo (Kratz, 1982). Later, similar efforts were made in Mango (1908) and Tabligbo (1913). However, each effort failed to generate sustained interest by local farmers.

During the 1950s and 1960s several attempts were made to revive animal traction, primarily in the Savanes Region in the north. In the 1950s, animal traction was introduced at the Barkoissi School Farm and at an agricultural centre in Toaga. By the mid-1960s, a programme to introduce animal traction in the Savanes Region had been initiated by the

Togolese regional development administration (SORAD) and the French agricultural development organization BDPA (Bureau pour le Développement de la Production Agricole). These pioneering efforts, along with those already under way in neighbouring Ghana, began to effect a change in the way agriculture in this region was conducted. However when funding for the BDPA project came to an end, so too, for a time, did coordinated animal traction development activities.

The decade of the 1970s brought renewed and, finally, sustained interest in animal traction on the part of development agencies. In 1971, the American Peace Corps began an animal traction project in the Kara Region which has continued now for 15 years. The European Development Fund (EDF/FED) likewise has made a continuing commitment to animal traction development in the Kara and Savanes Regions. Furthermore, with the adoption of animal traction as a Togolese national policy objective in the late 1970s, interest in the technology accelerated; so much so that, by 1985, some 32 different development organizations were working with Togolese farmers to foster the adoption of animal traction.

In 1981, faced with this growing proliferation of projects, a national study and policy committee for animal traction programmes (known as COCA) was organized. This committee recommended the establishment of an executive body to provide the leadership and the direction required to transform the efforts and interests of the many individual animal traction projects into a more orderly and comprehensive national effort. This executive body, in effect the national coordinating administration for animal power technology, is PROPTA, created four years ago.

PROPTA, in addition to its purely administrative sections, has five technical divisions responsible, at the national level, for coordinating animal health, animal supply, animal traction equipment supply and development, technical training, and monitoring and evaluation

activities. The authors of this paper work in the fifth division, Monitoring and Evaluation, itself created in September 1984.

Scale of adoption

Farmer adoption of animal traction technology is increasingly common in Togo today. The steadily mounting numbers of animal traction adopters is increasingly making this the technology of choice among Togo's progressive farmers. Their growing influence becomes all the more evident as one proceeds north through the country. In brief, animal traction is very important in the Savanes Region, but very marginal in the Maritime Region.

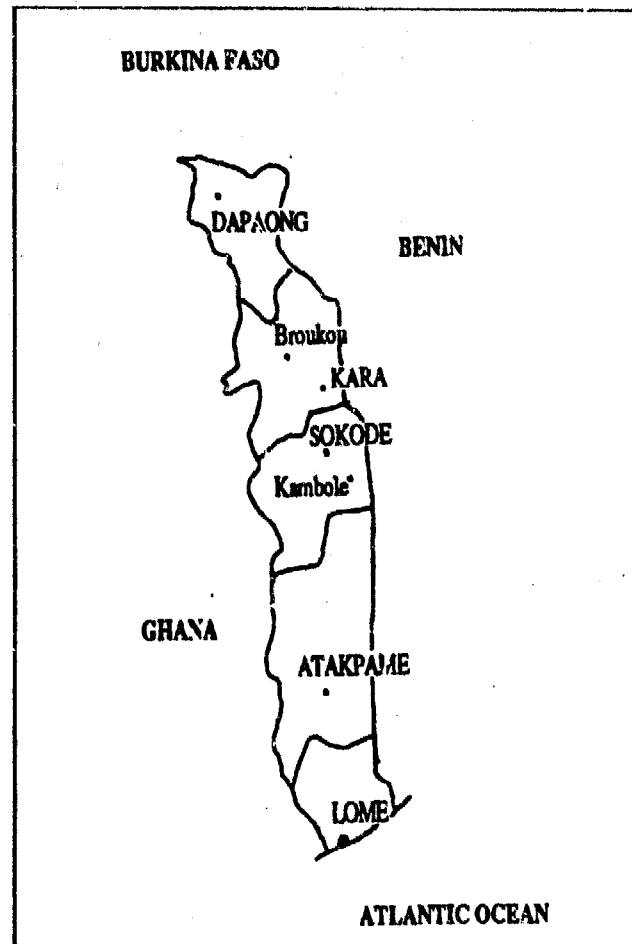

Figure Map of Togo

The absolute numbers of oxen pairs that PROPTA estimates are in use today are given in Table 1. These figures are based on the number of pairs associated with the 32 projects

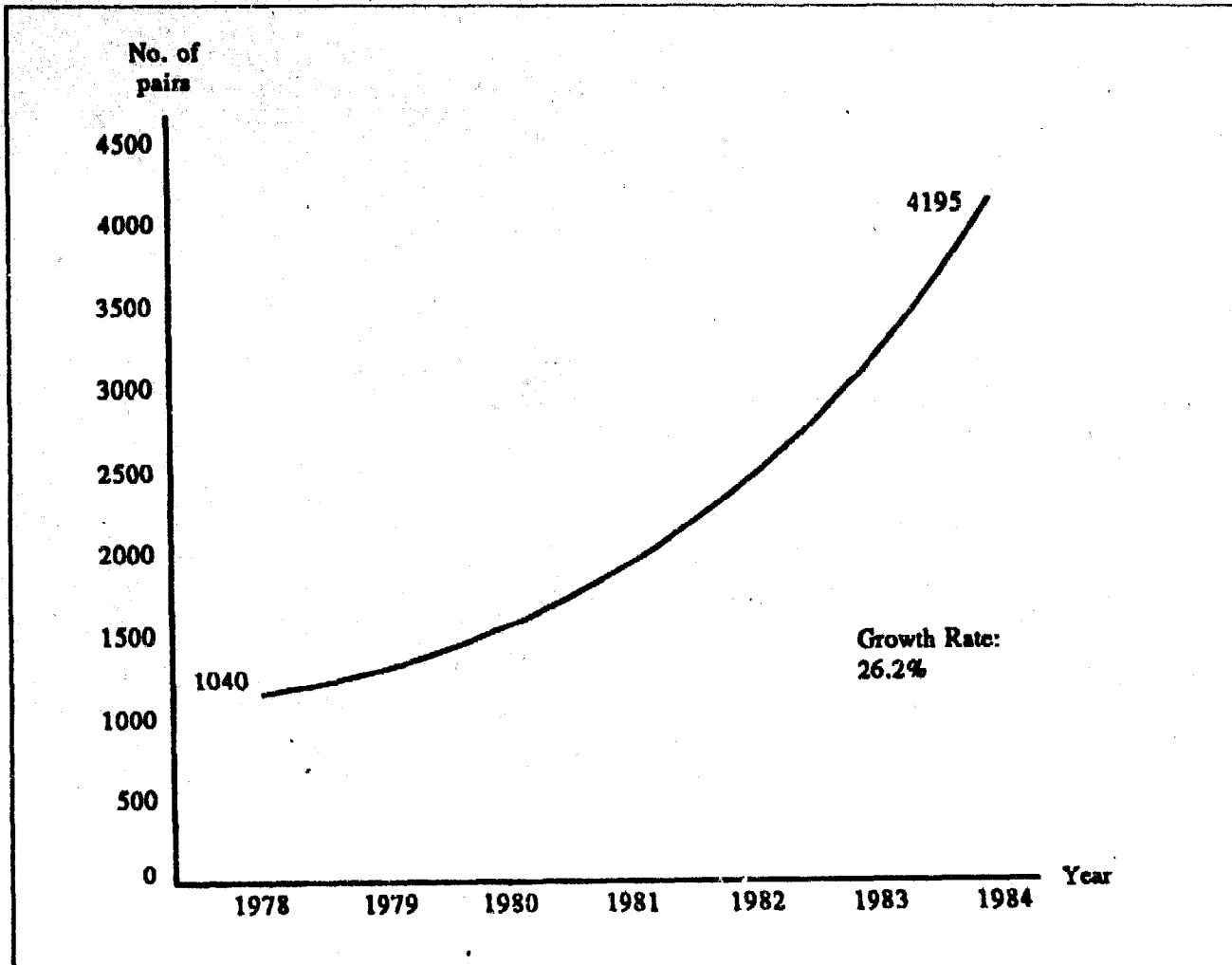

Figure 2. Animal traction adoption

promoting animal traction in 1985. There are, among PROPTA's colleagues, those that propose that the actual number of pairs is significantly greater than has been indicated. Through the continuing reporting procedures initiated this year by PROPTA, more precise figures will soon be available. At this early

stage, it is probably safest to say that 4,195 is the minimum number of oxen pairs to be found in Togo.

Absolute numbers of oxen pairs only tell part of the story. Helped by an earlier estimate of the number of oxen pairs in Togo in 1978, PROPTA has a general idea of the rate of growth in the number of oxen pairs. With the two available estimates seven years apart, an average annual growth in farmer-owned oxen pairs of about 26% per year emerges (see Figure 2). What is more, by employing known estimates of the total farmer households and extrapolating them to the present using commonly accepted population growth rates, it is possible to make an estimate of farmer adoption rates by economic region (see Table 2). Significantly, farmers in the Savanes Region

Table 1. Numbers of pairs of draft animals in Togo in 1985

Region	No. of pairs	%
Savanes	3214	76.6
Kara	637	15.2
Central	257	6.1
Plateaux	55	1.3
Maritime	32	0.8
TOTAL	4195	100.0

Source: PROPTA, 1985

Table 2. Estimated regional adoption rates for animal traction

Region	Adoption Rate
Savanes	9.2 %
Kara/Central	0.9 %
Plateaux	0.05 %
Maritime	0.05 %

Sources: PROPTA, 1985 and USAID, 1980

have achieved a rate of adoption nearing 10%. In the combined Kara and Central Regions, however, the estimated animal-traction adoption rate hovers at 1%, while the farmers in the Plateaux and Maritime Regions have shown little sustained interest in the technology.

A discussion of the reasons for farmer interest in animal traction in the Savanes Region merits a study all of its own. For the purpose of this paper, however, it can briefly be stated that animal traction development in northern Togo has benefited from the following conditions:

- The soils of the Savanes Region are generally light and the fields flat and open. These are conditions which are favourable to the smaller, less expensive animals generally available in Togo.
- The vegetation in the Savanes is dispersed, making it relatively easy to clear fields of stumps, bushes and rocks; this characteristic greatly facilitates the initial transition to animal traction.
- Farmers in the region have themselves been cattle owners for a long time. This familiarity with cattle facilitates their care and use for animal traction purposes. Furthermore, the region draws on supplies of animals in Burkina Faso and Niger. The number of animals in the herds available to Savanes farmers is therefore far greater than regions further south; hence animal prices are lower in the north.
- The cropping patterns and food preferences of northern Togo emphasize field crops

which are likely to benefit from cultivation using animal traction (millet, sorghum, maize, beans, groundnuts). By contrast, cropping patterns and food preferences in southern Togo emphasize root crops which benefit much less from animal traction technologies. Furthermore, long farmer association with cash crops, such as cotton and groundnuts, plays an important role in helping pay for the higher capital input costs associated with a switch to animal traction.

Farmer management in the transition zones

Definitions and areas of study

The Kara and Central Regions are areas where the adoption of animal traction is at the takeoff point. As farming systems are in the early stages of the transition from hoe to animal traction farming, discussions among farmers in these two regions about the two technologies are of particular interest. The following overview is drawn from interviews with farmers in Broukou (Kara Region) and Kambole (Central Region) earlier this year.

Farm capital during transition

In general, hoe farmers and animal traction farmers operate in the same socio-economic environment under identical conditions of resource availability and rules of land proprietorship. Labour is supplied by the farmers and their families. However farm capital is not the same, nor the farm equipment that extends the farmers' productive capacity. For manual farmers, the basic farm capital consists of a number of small weeding hoes, one for each worker, and large mounding hoes used only by men in conjunction with a machete. Animal traction farmers employ this same equipment except the number of hoes is reduced.

However, the adoption of animal traction also requires the acquisition of a pair of animals and traction equipment; the most common of

these are a plow, a ridger, a triangular weeder, a harrow, a cart and various accessories. Furthermore, the animal traction farmer may construct a stable for his oxen, a warehouse to store equipment, additional granaries, storage for hay and a manure pit. Clearly the animal traction farmer is faced with a significant investment in farm capital over and above what he would have made if he remained a hoe farmer.

The cost associated with this list of animal traction investments varies from farmer to farmer. The animals themselves, for example, are often inherited from parents. The parents may have initially acquired them through gifts, trading or as investment purchases following profits, the wealth being transformed into herds in a form of traditional savings designed to assure family security, financial health and social prestige. Cattle ownership can often save as much as a third of the price of the full animal traction package. It also gives rise to the notion, even in animal traction circles, that the rich get richer. Be that as it may, the farmer adopting animal traction is faced with a sizeable, supplemental farm-capital investment of between 50,000 and 350,000 CFA (US\$ 150-1050). These are high figures for a farmer in a country where the average annual per-capita income in the agricultural sector is around 38,200 CFA. Needless to say, capital investment in the construction of outbuildings remains small.

Table 3. Time comparisons for operations

Operation	No. of work days per hectare	
	Oxen and 2 workers	2 hoe farmers
Field cleaning	2	-
Light plowing	1.5	-
Plowing	2-4	-
Ridge plowing	1	7-10
Harrowing	1-1.5	-
Weeding	1-2	4-6
Ridging	1-1.5	6-8

Source: Arnegbeto, 1986

The consequence to the farmer of this initial investment is a very significant increase in fixed costs, most often involving the repayment of the cost of credit for farm machinery and animal purchases. This often represents the farmer's first initiation into the world of institutional credit and planning credit-repayments that is now so indispensable to the development of modern agriculture. This is an impact of animal traction adoption of the first order. The risks to the farmer of this indebtedness are considerable, especially since farmers are not well trained in financial management and are limited in their ability to commercialize grain.

Technical implications for production

The speed at which field operations are executed using animal traction has had an important influence on Togolese farmers. They no longer question its superiority over hoe farming in terms of speed of field work. It has simply become one of the realities of Togolese agriculture. Most farmers in the areas studied, whether they use hoe or animal traction, work practically the same number of days each week for about the same length of time, 10 to 12 hours/day. However, the time spent on actual farming operations differs significantly: 5-6 hours/day for animal traction farmers against 7-9 hours/day for hoe farmers. The impact of this time-saving aspect of animal traction technology is an increase in field size and a diversification of on-farm activities. In Table 3 comparative data is presented on the time spent on each farm operation.

Putting more land under cultivation

In the two zones studied, animal traction farmers clearly work more cropland than hoe-labour farmers. The average farm size for animal traction farmers was 5.4 ha, while for manual farmers it was 4.3 ha. Moreover, while PROP-TA's statistics in this area are still limited, data from other parts of the country indicates a willingness of animal traction farmers to put

Table 4. Cultivated areas of a sample of 28 farmers in the Savanes Region

Area cultivated with animal traction (ha)	No. of farmers
3.5	2
3.5-4.5	4
4.5-5.5	5
5.5-6.5	7
6.5-7.5	6
7.5	4

Source: Allingham, 1984

Table 5. Cultivated areas of animal traction adopters in the Kara and Central Regions (average figures)

Year	Kara sample ha/pair	Central sample ha/pair
1981-82	2.0	2.0
1982-83	2.8	2.8
1983-84	2.5	2.5
1984-85	3.3	3.3

Sources: Kara sample: PVAS, 1983;
Central sample: Zeidler, 1985.

Table 6. Hire rates for animal traction services

Operation	Price (CFA/ha)
Field cleaning	6000
Light plowing	5000
Plowing	9000-13000
Ridging	5000
Harrowing	1500-2000
Weeding	8000-10000
Mounding	6000-8000

Note:
Prices for transport services are negotiated according to the nature of the load and the distance, and are consequently very variable.

Source: Amegbeto, 1986

more land under cultivation than was previously possible with the hoe.

While the national average farm size is around 1.75 ha (IBRD, 1984), animal traction farmers surpass this average by a considerable margin. In 1983, a sample of 28 animal traction farmers

in the Savanes Region found only two who were still farming less than 3.5 ha. (Table 4).

Similar results are found among animal-traction adopters in other regions of the country. Data from both the Kara Region and the Central Region (Table 5) indicates *progressive* expansion year by year of total areas farmed using oxen by recent adopters.

Increased diversification

With time saved in executing field operations, the animal traction farmers diversify. However the possibilities are limited. Small-scale production possibilities (shea trees, *néré*, kapok, etc.) and local commerce exist, but are not yet a significant option, particularly since in these areas the traditional social division of labour is still strong. Likewise, the rural labour market is not sufficiently advanced to afford the animal traction farmer the opportunity of making money as a day labourer.

When the animal traction farmers diversify, they try to do it within the agricultural sector, but selectively so as to minimize the risk of dislocating their family work force. Consequently there is evidence of a shift toward livestock, but not as yet to a level where one could claim the emergence of a true livestock-agriculture association. Ways to encourage this tendency are a key topic for our discussions here at this networkshop.

Several other possibilities for diversification present themselves to the animal traction farmer. These include work on other farmers' fields and transport. Third-party animal traction services are an enterprise area now experiencing important growth in Togo's rural sector. This takeoff is due to the fact that the majority of the hoe farmers now recognize the inefficiency inherent in much of their hoe-farming technology and are no longer content with the low yields associated with it. This opening up of hoe farmers to animal traction is reflected in the development of a rental market for ani-

mal traction services, current prices for which are indicated in Table 6.

Limits to the animal traction service market

The development of this animal traction service market depends entirely on the means at the disposal of the hoe farmers who request these services. The constraints on hoe farmers will eventually limit the growth of the animal traction service market in the rural sector. In order to rent animal traction services for field operations, hoe farmers must have already acquired substantial resources necessary to prepare their fields for animal traction. Destumping, root pulling and initial plowing are necessary before the oxen can be used effectively on their fields. This investment in field preparation, in addition to the resources required to pay for the rented animal traction services, is an outlay beyond the means of many hoe farmers. Furthermore hoe farmers who rent animal traction services tend to acquire their own animals as quickly as possible. Consequently the rental market for animal traction services is liable to be unstable and limited in size as farmer customers become draft animal owners in their own right, and eventually competitors for the rental business of the remaining hoe farmers.

Other farm practices

Animal traction farmers in the transition zones studied have developed a farming system in which two distinct types of fields are prepared. There are fields which are completely traditional in character and developed using only human power and tools. There are also fields where both manual and animal traction tools are used; these are semi-modern fields where modern agricultural practices are commonly employed. Though each of these fields aims at increasing production, the result of their coexistence is an underutilization not only of the farmers' animal traction equipment but also of their manual farming equipment.

As contrasted to manual farmers, who tend to remain survival-craft farmers, animal traction farmers have a commercial interest in their adopted technology. Upon adopting animal traction, farmers modify their production practices. They are more likely to respect the agricultural calendar. They are more open to modern agricultural methods such as seeding in line in prepared fields and using improved seed, chemical fertilizer and synthetic products. They are more attentive to the fertility of their soil and the importance of increasing yields. Given the pressure they are under to maintain their financial and alimentary solvency, animal traction farmers give priority to cash crops (cotton, maize, groundnuts and beans) for which the market is more or less stable; in fact, in Togo it is often guaranteed by a marketing organization.

Furthermore, there is the animal health service associated with animal traction. Even where it is not well understood or even ignored, it plays a role in developing an association between cattle raising and agriculture. This, in turn, positively influences the care of other domestic animals.

Profitability of animal traction

The profitability of animal traction turns on the efficiency of farm management. Strong farm managers are more likely to make animal traction work than are weak farm managers. That the adoption of animal traction can increase production and net revenue for some farmers is not in doubt. This is illustrated by the financial data from typical successful animal traction farmers presented in Table 7. These farmers farm in the Broukou and Kambole zones and the CFA figures represent positive net revenue from each of their operations: agriculture, livestock and other. The total net revenue of these farmers contrasts with the average agricultural sector per-capita income of 38,200 CFA/year.

Table 7. Selected net revenues from mixed farming systems

Case	Agriculture (CFA)	Livestock (CFA)	Other (CFA)	Total (CFA)
1	243 456	8350	16 000	267 806
2	651 580	16 000	29 500	697 080
3	315 504	8 820	39 000	363 324
4	452 492	24 200	26 400	503 092
5	441 095	2 150	13 000	456 245
6	516 834	53 845	2 500	573 179
7	336 095	64 750	---	400 845
8	844 553	---	79 000	923 553
9	476 974	5 500	66 000	548 474
10	622 073	83 000	164 000	869 873

Source: Amegbeto, 1986

Reinvestment

In the village, it is remarkable to observe the difference between animal traction farmer households and hoe-farmer households. Animal traction farmers are able to support their food needs and tend toward a progressive improvement in their quality of life. In contrast to hoe farmers, animal traction households enjoy a visibly higher level of consumption based on increased farm revenues; this was particularly true of the consumption level of the head of the household.

However on the majority of the farms visited, farmer objectives seemed to have been rather quickly attained. Few of them reinvested directly in their agriculture, either to increase their productive capacity or to augment their revenues. Even while recognizing the benefits of animal traction, these farmers directed their revenues toward improving their house and toward the purchase of consumer goods which do not have a direct and progressive effect on their principal agricultural activity, but rather reinforce the social position of the head of the household.

As a consequence, many animal traction farmers are living from one agricultural season to the next. When it comes time to sell an old pair of animals and purchase a new pair, the

financial situation of these farmers is much the same as before. These farmers, like any new animal traction farmer, are left without the money to finance the new team. Such financial management practices do not favour the long-term development of animal traction; like several others discussed in this paper, this situation points out the need for a systematic farmer-oriented farm-management training programme.

Limits to the spread of animal traction technology

For most Togolese animal traction farmers, the full potential of the technology has not yet been realized for natural, technical and financial reasons. For example, the rainfall period is often so short in some sectors that it is not possible to fully exploit the animal traction technology. Complete soil preparation is often less a concern than getting the seed in the ground. The adverse climate limits the size of the farm and what resources farmers are willing to expend on it.

The local work force is often inadequate and limiting, and this is a crucial factor for Togolese farmers. Most farmers rely essentially on family labour, a resource which is typically spread thinly over the many agricultural and non-agricultural activities of the farm. The significant additional labour requirement which often follows the adoption of animal traction necessitates the use of temporary wage labourers. This is a financial burden in addition to those already cited.

In addition, the expansion of farmers' cultivated areas often requires the sizeable investment in field preparation, notably the destumping and cleaning of their fields with perhaps the opening work carried out by a tractor. These costs weigh heavily against the financial stability of the animal traction enterprise and exert a strongly negative pressure on the potential adopters.

The durability of hoe farming

It is evident that, even given the superiority of animal traction technology, the hand hoe will not be replaced easily. Consider the following three examples:

- Many farmer families in Togo enjoy foods made from root crops. *Fufu* is a popular example of such food preferences which are common in the Kara Region and in the south. Such tastes are an important reason for the durability of hoe farming in Togo, for cassava and yams are grown in mounds or holes, and these are more easily fashioned with hoes than with animal traction.
- Some operations, such as destumping, root removal, seeding, fertilizer spreading, plant treatments and harvesting, are not well suited to animal power systems and, even if they were, would require additional equipment, training and financial resources not currently available to many farmers.
- Animal traction operations do not always produce regular and homogeneous results. Consequently, manual follow-up work, with a hoe, is often required even of experienced animal traction farmers.

Impact on the village

The effects of animal traction at the village level, in those areas where the technology is developing well, are generally seen in the market place. Broukou, in the Kara Region, is a good example. The effect of the increased farmer production, produce sales and consumption has resulted in the transformation of this village into a market centre, a point of attraction for numerous consumers and merchants who trade in local and imported products. Villages like Broukou tend to achieve a fuller economic autonomy and an increased importance within their zone. This increased dynamism at the village level, as witnessed at Broukou and Kambole, influences younger Togolese to reconsider farming as a career.

Conclusion

This paper has tried to capture through observation, description and statistics the hope and the energy which an increasing number of Togolese farmers associate with animal traction technology. Quite simply, it is a technology which opens up new opportunities never before *realistically* available in the rural agricultural sector. Sadly the technology is not available to everyone and there are failures as well as successes to relate. For us at PROPTA, the failures increasingly indicate the urgency with which training in farming systems and farm-management technologies must follow the adoption of animal traction.

In closing, you are encouraged to visit Togo and PROPTA. Togo is a country where animal traction is a priority, where animal traction is, even within different regions, at different stages of development, and where there is great diversity in farming systems. When you visit Togo, you will find a uniquely dynamic animal traction development effort.

References

- Allingham, K. 1984. A contribution to the study of the sustainability of animal traction systems in Northern Togo. PROPTA, Atakpame, Togo. (E). (unpublished).
- Amegbeto, K. N. 1986. Data from study of hoe and animal traction farmers in the Broukou and Kambole zones, August 1986. Division de la Programmation, de l'Evaluation et des Statistiques, PROPTA, Atakpame, Togo. (F). (unpublished).
- IBRD 1984. Togo: issues and options for agricultural strategy. Western Africa Regional Projects Department, World Bank, Washington D.C., USA. (E).
- Kratz, A. 1982. L'histoire de la traction animale au Togo. *Le Courrier*, 72 (mars-avril): 42-43. (E,F).
- PROPTA 1985. Situation actuelle de la Traction Animale au Togo, octobre 1985. Division de la Programmation, de l'Evaluation et des Statistiques, PROPTA, Atakpame, Togo. (F).
- PVAS 1983. Rapport d'exécution du Programme Culture Attelée, financé sur Fonds du Conseil de l'Entente, décembre 1983, Projet Vivrier Atchangbadé-Sirka, Kara, Togo. (F). (unpublished).
- USAID 1980. Rapport sur la Culture Attelée au Togo. Cited in Karen Parsons: Togo grain and the quest for self-sufficiency, August 1982. USAID, Lomé, Togo.
- Zeidler, B. 1985. Rapport d'activités du 1/6/1981 au 28/2/1985. Eveché de Sokodé, Centre d'Animation Rural d'Adjengré, Sokodé, Togo. (F). (unpublished).

Caractéristiques d'adoption de la traction animale au Togo

par

A. S. Westneat, A. Klutse et K. N. Amegbeto

Projet pour la Promotion de la Traction Animale (PROPTA), Atakpame, Togo

Résumé

L'introduction de la traction animale au Togo remonte à l'ère coloniale allemande; elle résulte de la volonté des autorités de promouvoir la culture du coton sur une grande échelle et fait suite à l'échec des tentatives d'utilisation de tracteurs décidée par le gouvernement pour moderniser l'agriculture. Le niveau d'adoption de la traction animale dans les différentes régions est fonction des facteurs suivants:

- la disponibilité d'animaux de trait et d'équipements agricoles dans la région,
- l'existence de facteurs naturels favorables (sols, végétation, etc).
- les types de culture et les habitudes de consommation.

L'adoption de la culture attelée a eu des un impact positif sur les éléments suivants:

- la rapidité d'exécution des opérations culturelles.
- l'accroissement des superficies cultivées.
- la diversification des activités.

Par ailleurs, l'adoption de la traction animale a entraîné des modifications dans la pratique des adoptants en matière de respect du calendrier cultural, la pratique du semis en lignes, l'utilisation de semences améliorées, d'engrais chimiques et de produits phytosanitaires. Par conséquent, l'utilisation de la traction animale a procuré des revenus additionnels importants aux paysans compétents en gestion agricole.

Les paysans en culture manuelle ont de plus en plus recours à la location de matériels agricoles. Le développement de ce marché des services dépend essentiellement des moyens dont disposent les paysans en culture manuelle.

Certains facteurs tendent toutefois à freiner l'adoption et la diffusion de la traction animale. Il s'agit essentiellement de la plus grande adaptation de la houe à la culture de certains produits largement consommés au Togo, la difficulté de réaliser certaines opérations culturales à la traction animale, de l'importance des investissements initiaux et des résultats souvent décevants de la technologie. La technologie suscite toutefois beaucoup d'espoir et progresse rapidement au Togo.

Introduction

La République du Togo est un pays essentiellement agricole de 56 000 km² situé sur la côte de l'Afrique Occidentale, entre le Ghana et le Bénin. Il est divisé en cinq régions économiques:

- la Région des Savanes au Nord
- la Région de la Kara
- la Région Centrale
- la Région des Plateaux
- la Région Maritime au Sud.

Sa population est estimée à 3 500 000 habitants dont 77%, soit 2 500 000 habitants environ, vivent à la campagne; 43% de cette population rurale sont des agriculteurs dont le revenu moyen par tête était de 38 200 F (98 \$ US) en 1982.

La principale source d'énergie dans ce secteur agricole est le travail manuel où les familles utilisent la houe et la machette. A la suite de l'échec de l'utilisation des tracteurs décidée par le gouvernement (en 1976-77) pour moderniser l'agriculture, les autorités politiques et les responsables du développement rural

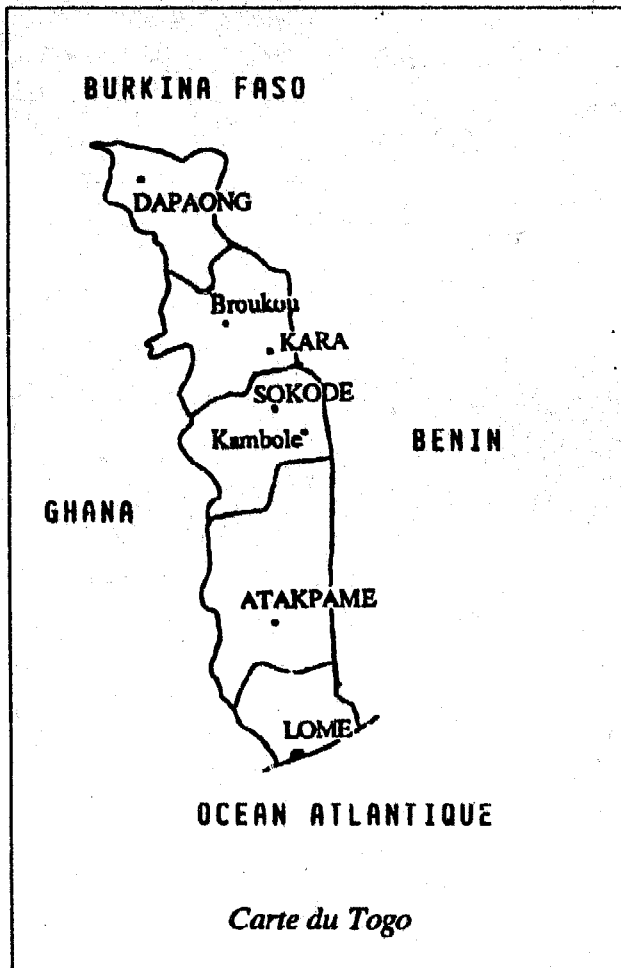

ont conclu ensemble qu'une autre approche était nécessaire. Elles se sont alors tournées vers l'énergie bovine, c'est-à-dire vers la traction animale.

Ce document décrit les traits les plus saillants de l'utilisation de la traction animale au Togo. Après un bref historique, nous présentons en grand plusieurs indicateurs spécifiques de son niveau d'adoption. Ceci est suivi d'un tableau synoptique des conditions qui ont contribué à sa réussite dans la région des Savanes. L'exposé se termine par une discussion sur la gestion agricole en cette période de transition entre l'utilisation de la houe et celle de la traction animale dans les régions de la Kara et du Centre.

Au cours de cette saison, PROPTA (Projet pour la Promotion de la Traction Animale) en collaboration avec l'Ecole Supérieure d'Agro-nomie de l'Université du Bénin (Lomé) a réalisé une étude sur des exploitations utilisant la

houe et la traction animale dans les régions de la Kara et du Centre et plus précisément la transition de l'une à l'autre.

Aperçu historique

Au moment où le gouvernement togolais a opté pour la politique de la traction animale, ce n'était pas une innovation car elle avait été déjà essayée mais avait connu un échec. En effet, la traction animale au Togo remonte à l'ère coloniale allemande.

En mai 1900, le comité économique colonial de Berlin a engagé une équipe d'experts Noirs Américains venus de "Tuskegee Normal and Industrial Institute" (Tuskegee, Alabama) pour introduire la traction animale au Togo et, par la, promouvoir la culture du coton au Togo sur une grande échelle. Plus tard, des efforts semblables ont été déployés à Mango (1908) et Tabligbo (1913). Chacune de ces tentatives pour stimuler l'intérêt constant des agriculteurs à cette technologie a été vouée à un échec.

Pendant les années 1950 et 60, plusieurs essais ont été entrepris pour relancer la traction animale principalement dans la région des Savanes du Nord. Dans les années 50, la traction animale a été introduite dans une ferme (Ecole de Barkossi) et dans un centre agricole à Toaga. Vers le milieu des années 60, un programme d'introduction de la traction animale dans la région des Savanes a été mis en place par le Bureau de Développement de la Production Agricole (BDPA, en collaboration avec la Société Régionale d'Aménagement et de Développement (SORAD).

Ces efforts, conjugués avec ceux déjà en cours au Ghana, pays limitrophe, avaient commencé à influencer la façon dont l'agriculture était pratiquée dans cette région. Mais au moment où le financement du Projet BDPA prenait fin pour un certain temps, les activités coordonnées pour le développement de la traction animale s'arrêtaient également.

La dernière décennie a vu naître un intérêt nouveau et de surcroît constant pour la traction animale au niveau des structures de développement rural.

En 1971, les membres du Corps de la Paix des Etats-Unis ont créé un centre pour la traction animale qui existe jusqu'à ce jour dans la région de la Kara. Le Fonds Européen de Développement (FED) s'est également engagé à développer la traction animale dans les régions de Kara et des Savanes. En outre, avec l'adoption de la traction animale comme objectif de la politique nationale de développement de l'agriculture vers les années 1970, un intérêt pour cette technologie s'est accru à tel point qu'en 1985 quelque trente-deux organismes de développement ont travaillé avec les agriculteurs pour stimuler l'adoption de la traction animale.

En 1981, devant la multiplicité de ces projets, un comité national d'étude chargé de la politique de traction animale (connu sous le nom de COCA) a été créé. Ce comité a recommandé la création d'une commission exécutive pour assurer la direction et l'organisation requises en vue d'unifier les efforts et intérêts de tous les projets opérant dans le pays. Cette commission d'exécution qui est en fait l'organe national de coordination des projets utilisant la technologie de la traction animale, est le PROPTA, créé dans la même période.

En plus de ses sections purement administratives, le PROPTA dispose au niveau national de cinq divisions techniques chargées de la co-

ordination du suivi sanitaire des animaux de trait, de la distribution des animaux, de l'approvisionnement et de l'amélioration de l'équipement de traction animale, de la formation technique ainsi que des activités de contrôle et d'évaluation. Les auteurs de ce document travaillent dans la cinquième division de contrôle et évaluation qui a été créée en septembre 1984.

Niveau d'adoption

L'adoption de la technologie de la traction animale par les agriculteurs est de plus en plus courante au Togo. Le nombre croissant de ceux qui ont opté pour la traction animale fait d'elle une technologie de choix pour des agriculteurs ayant l'esprit novateur; leur influence grandissante devient en effet évidente quand on monte vers le nord du pays. En bref, la traction animale est très importante dans la région des Savanes, très marginale dans la région Maritime. Les chiffres du tableau ci-après sont assez expressifs.

Les données présentées au tableau résultent des estimations du PROPTA pour cette date. Elles indiquent le nombre de paires mises en place par les 32 projets qui ont encouragé la promotion de la traction animale en 1985. Parmi les services collaborateurs du PROPTA, il y en a qui supposent que le nombre réel est plus élevé que celui indiqué. Avec les nouvelles méthodes de rapport en cours, introduites par le PROPTA cette année, des chiffres plus fiables seront disponibles bientôt.

Au niveau actuel il est probablement plus prudent de dire que ce chiffre de 4 195 est le nombre le plus bas de paires de boeufs au Togo.

Le nombre absolu de paires ne montre néanmoins qu'une partie de l'expérience. Le PROPTA a pu se faire une idée générale de son taux de croissance en se référant aux estimations de 1980. De deux estimations disponibles et séparées de sept ans (7 ans), on a pu calculer un taux de croissance des paires de

Tableau 1: Nombre de paires au Togo en 1975

Régions	Nombre de Paires	%
Savanes	3 214	77
Kara	637	15
Centrale	257	6
Plateaux	55	1.3
Maritime	22	0.7
Total	4 195	100

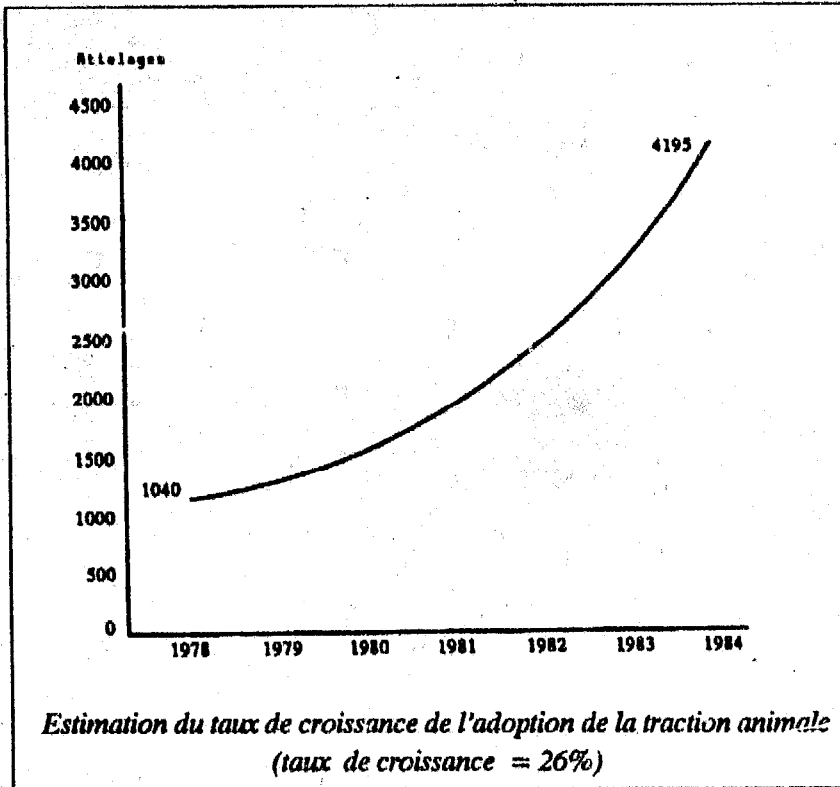

boeufs appartenant aux agriculteurs; ce taux est de l'ordre de 26% par an.

En plus si on emploie les estimations connues du total des ménages agricoles et si on les extrapole en utilisant les taux de croissance de la population, taux communément acceptés, il est possible de faire une estimation des taux d'adoption de la technologie par les paysans des différentes régions économiques (voir Tableau 2).

D'une façon plus significative, les paysans de la région des Savanes ont atteint un taux proche de 10%. Cependant dans les régions de la Kara et du Centre ce taux voisine 1% alors que les agriculteurs de la région Maritime et de la Région des Plateaux n'ont montré qu'un faible intérêt pour cette technologie.

Région des Savanes

Une discussion des raisons de l'intérêt porté à la traction animale mérite une étude à part. Cependant, dans le cadre de l'objectif de cet exposé on peut dire brièvement que le déve-

loppement de la traction animale dans le Nord a été guidé par les éléments suivants:

- Les sols de la région des Savanes sont généralement légers et les champs sont plats et ouverts; ce sont des conditions favorables aux animaux plus petits et moins chers, disponibles au Togo.
- La végétation de cette région (Savanes) est clairsemée et ceci permet de débarasser facilement les terrains des souches, des buissons et des roches. Cette caractéristique facilite beaucoup la transition du travail à la houe à celui de traction animale.

Les paysans de la région ont été eux-mêmes propriétaires de troupeaux de bovins depuis longtemps. Cette familiarité avec ce type de bétail facilite sa préparation et son utilisation pour la traction animale. En plus, le nombre d'animaux provenant du Burkina Faso et du Niger est plus élevé chez les agriculteurs des Savanes que chez les paysans du Sud. Par conséquent les prix des animaux sont plus bas dans le Nord.

Tableau 2:
Estimation des taux d'adoption par région

Régions	% taux d'adoption
Savanes	9.2
Kara/Centrale	0.9
Plateaux	0.05
Maritime	0.05

- Les types de cultures et les habitudes alimentaires dans le Nord-Togo favorisent les cultures qui peuvent bénéficier de l'utilisation de la traction animale (mil, sorgho, maïs, haricot, arachide).
- Les types de cultures et les habitudes alimentaires dans le Sud, par contre, favorisent les cultures à tubercules qui utilisent moins la technologie de la traction animale.

En outre la vieille habitude des cultivateurs qui consiste à associer les cultures d'exploitation telles que le coton et les arachides joue un grand rôle en les aidant dans le paiement des différents coûts qu'entraîne l'emploi de la traction animale.

Gestion agricole dans les zones de transition

Les régions de la Kara et du Centre sont des zones où l'adoption de la traction animale est à ses débuts. Comme les exploitations agricoles sont encore dans la période de transition de la houe à la traction animale, des discussions avec les agriculteurs de ces deux régions sont d'un intérêt particulier. Les points de vue qui suivent sont les résultats des interviews recueillies des agriculteurs de Broukou (Région

de la Kara) et Kambolé (Région Centrale) au début de cette année.

Le capital agricole nécessaire pour la traction animale

En général, les agriculteurs se servent de la houe et ceux qui emploient la traction animale travaillent dans un même milieu socio-économique avec des conditions identiques de disponibilité de ressources et d'exigences du droit de propriété foncière. Le travail est fait par l'agriculteur et sa famille. Le capital agricole ou l'équipement agricole qui contribue à la capacité productive de l'agriculteur n'est cependant pas le même.

Pour les agriculteurs manuels, le capital habituel de base est constitué d'un nombre de petites houes de sarclage, une pour chaque travailleur, et de grandes houes pour faire les billons; ces dernières et les machettes sont seulement utilisées par les hommes. Les agriculteurs qui utilisent la traction animale font eux aussi usage de ce même équipement, sauf que dans leur cas le nombre de houes est réduit. Cependant l'adoption de la traction animale exige également l'acquisition d'une paire d'animaux et d'équipements de traction dont les plus courants sont la charrue, la billonneuse, la houe triangle, la herse, la charrette et d'autres accessoires. De plus, l'agriculteur en traction animale devra construire une étable pour ses boeufs, un magasin pour l'équipement et prévoir des réserves pour l'aliment supplémentaire et une fosse pour le fumier.

En clair, l'agriculteur en traction animale fait face à des investissements additionnels importants pour le capital par rapport au cultivateur en culture manuelle.

Le coût afférent à cet investissement dans la traction animale varie d'un agriculteur à un autre. Les animaux par exemple sont souvent objet d'héritage laissé par des parents et constituent des troupeaux représentant une sorte d'épargne traditionnelle pour assurer la sécurité de la famille ou des finances et le pres-

Tableau 3 :
Comparaison des temps de travaux pour différentes opérations agricoles

Opérations	Nombre de jours ha-1	
	2 paysans + 2 boeufs	2 paysans en culture manuelle
Déblayage	2	
Sacrifiage	1.5	
Labour	2-4	
Labour sur billon	7-10	
Hersage	1-1.5	
Sarclage	1-2	4-6
Billonnage	1-1.5	6-8

- Les types de cultures et les habitudes alimentaires dans le Nord-Togo favorisent les cultures qui peuvent bénéficier de l'utilisation de la traction animale (mil, sorgho, maïs, haricot, arachide).
- Les types de cultures et les habitudes alimentaires dans le Sud, par contre, favorisent les cultures à tubercules qui utilisent moins la technologie de la traction animale.

En outre la vieille habitude des cultivateurs qui consiste à associer les cultures d'exploitation telles que le coton et les arachides joue un grand rôle en les aidant dans le paiement des différents coûts qu'entraîne l'emploi de la traction animale.

Gestion agricole dans les zones de transition

Les régions de la Kara et du Centre sont des zones où l'adoption de la traction animale est à ses débuts. Comme les exploitations agricoles sont encore dans la période de transition de la houe à la traction animale, des discussions avec les agriculteurs de ces deux régions sont d'un intérêt particulier. Les points de vue qui suivent sont les résultats des interviews recueillies des agriculteurs de Broukou (Région

de la Kara) et Kambolé (Région Centrale) au début de cette année.

Le capital agricole nécessaire pour la traction animale

En général, les agriculteurs se servent de la houe et ceux qui emploient la traction animale travaillent dans un même milieu socio-économique avec des conditions identiques de disponibilité de ressources et d'exigences du droit de propriété foncière. Le travail est fait par l'agriculteur et sa famille. Le capital agricole ou l'équipement agricole qui contribue à la capacité productive de l'agriculteur n'est cependant pas le même.

Pour les agriculteurs manuels, le capital habituel de base est constitué d'un nombre de petites houes de sarclage, une pour chaque travailleur, et de grandes houes pour faire les billons; ces dernières et les machettes sont seulement utilisées par les hommes. Les agriculteurs qui utilisent la traction animale font eux aussi usage de ce même équipement, sauf que dans leur cas le nombre de houes est réduit. Cependant l'adoption de la traction animale exige également l'acquisition d'une paire d'animaux et d'équipements de traction dont les plus courants sont la charrue, la billonneuse, la houe triangle, la herse, la charrette et d'autres accessoires. De plus, l'agriculteur en traction animale devra construire une étable pour ses boeufs, un magasin pour l'équipement et prévoir des réserves pour l'aliment supplémentaire et une fosse pour le fumier.

En clair, l'agriculteur en traction animale fait face à des investissements additionnels importants pour le capital par rapport au cultivateur en culture manuelle.

Le coût afférent à cet investissement dans la traction animale varie d'un agriculteur à un autre. Les animaux par exemple sont souvent objet d'héritage laissé par des parents et constituent des troupeaux représentant une sorte d'épargne traditionnelle pour assurer la sécurité de la famille ou des finances et le pres-

Tableau 3 :
Comparaison des temps de travaux pour différentes opérations agricoles

Opérations	Nombre de jours ha-1	
	2 paysans + 2 boeufs	2 paysans en culture manuelle
Déblayage	2	
Sacrifiage	1.5	
Labour	2-4	
Labour sur billon	7-10	
Hersage	1-1.5	
Sarclage	1-2	4-6
Billonnage	1-1.5	6-8

tige social. Cet élément à lui seul peut souvent permettre une économie représentant presque le tiers du prix de l'équipement complet de la chaîne de traction animale. Il donne aussi l'impression, même parmi ceux qui utilisent la traction animale, que les riches deviennent encore plus riches. Quoi qu'il en soit, l'agriculteur qui adopte la traction animale fait face à un investissement supplémentaire en capital agricole variant de 50 000 et 350 000 F CFA (150 et 1050 \$US). Ce sont des sommes excessives pour un agriculteur dans un pays où le revenu moyen par tête dans le secteur agricole est d'environ 38 200 F CFA. Il est inutile de dire que le capital investi dans la construction des bâtiments annexes est insignifiant.

La conséquence de cet investissement pour l'agriculteur est une augmentation très importante pour les coûts fixes, entraînant, dans la plupart des cas, le remboursement d'intérêts sur les crédits obtenus pour l'achat du matériel agricole et des animaux. Ceci représente souvent pour l'agriculteur son premier contact avec le monde des crédits et des échéances des remboursements, éléments indispensables de nos jours au développement d'une agriculture moderne. Tout ceci constitue un effet important dans l'adoption de la traction animale. Les risques de cette redevance pour l'agriculteur sont énormes, d'autant plus que les paysans ne sont pas formés en technique de gestion des exploitations et ont une faible habileté dans la commercialisation des graines.

Traction animale: implications techniques sur la production

La vitesse à laquelle les opérations agricoles sont effectuées lorsqu'on emploie la traction animale a eu une influence considérable sur les agriculteurs togolais. Ils ne mettent plus en doute sa supériorité sur l'exploitation à la houe en termes de vitesse de travail au champ. Elle est simplement devenue l'une des réalités agricoles togolaises.

La plupart des agriculteurs des régions étudiées, qu'ils emploient la houe ou la traction animale, travaillent pratiquement le même nombre de jours par semaine, mettent environ le même temps soit 10 à 12 heures par jour; le temps utilisé pour les opérations agricoles proprement dites est cependant significativement différent: 5 à 6 heures par jour pour les agriculteurs en traction animale contre 7 à 9 heures par jour pour ceux en culture manuelle. Les données suivantes indiquent le temps passé pour chaque opération agricole.

Augmentation de la superficie à cultiver

Dans les deux zones étudiées, les agriculteurs utilisant la traction animale exploitent plus de terre que leurs frères travaillant à la houe. La superficie moyenne des champs des premiers (agriculteurs culture attelée) est de 5,4 ha contre 4,3 ha pour les derniers (agriculteurs manuels).

En outre, les données en provenance d'autres régions du pays indiquent la volonté des agriculteurs en traction animale d'accroître la surface à cultiver alors qu'ils n'avaient pas cette possibilité lorsqu'ils faisaient usage de la houe.

Alors que la superficie nationale moyenne des champs est d'environ 1,75 ha (IBRD, 1984) les agriculteurs en traction animale dépassent largement cette moyenne. Les résultats obtenus sur un échantillon de 28 agriculteurs utilisant la traction animale dans les régions des Savanes a montré que seuls deux agriculteurs exploitaient encore moins de 3,5 ha (PROPTA, 1985).

Des résultats similaires ont été obtenus chez des agriculteurs qui ont opté pour la traction animale dans les autres régions du territoire national. De même, des données concordantes collectées dans plusieurs régions du pays indiquent une progression annuelle du nombre total d'hectares travaillés avec les boeufs par ceux qui viennent d'adopter cette technologie.

Avec le gain de temps réalisé dans l'exécution des opérations culturales, l'agriculteur utilisant la traction animale multiplie ses activités. Néanmoins ses moyens sont limités. Des possibilités de production à petite échelle (néké ka-pok, etc.) et le commerce local (interne) existent mais ne constituent pas encore une option fondamentale, parce que dans ces régions la répartition sociale et traditionnelle du travail est encore très importante.

De même, le marché des activités rurales n'est pas suffisamment développé pour donner à l'agriculteur utilisant la traction animale, l'opportunité de gagner de l'argent comme un travailleur journalier.

Quand l'agriculteur qui utilise la traction animale diversifie ses activités, il essaie de le faire à l'intérieur même du secteur agricole mais de façon sélective afin de minimiser les risques de dispersion d'énergie de sa famille. En conséquence il est évident qu'il se tourne vers l'élevage du bétail dans les cas où il existe une association de l'élevage et l'agriculture.

Plusieurs autres possibilités de diversification s'offrent à l'agriculteur utilisant la traction animale notamment le travail rémunéré dans les champs de ses collègues et le transport. Les services exécutés avec la traction animale au profit des tiers constituent une activité régionale qui connaît un développement important dans le secteur rural au Togo. Cet élan est dû au fait que la majorité des agriculteurs qui utilisent la houe reconnaissent enfin l'inefficacité inhérente à cette pratique et ne sont plus contents des résultats qu'ils obtenaient. Cette ouverture des agriculteurs traditionnels sur la traction animale rejaillit sur un marché de location de matériels et de prestations de services.

Limite du marché des services de la traction animale

Le développement du marché des services de la traction animale dépend essentiellement des moyens mis à la disposition des agriculteurs

manuels qui sollicitent sa prestation. La contrainte majeure qui leur est imposée dans le secteur rural limitera en fin de compte l'extension du marché des services de la traction animale. Pour louer ces services dans le but d'effectuer des opérations champêtres, les agriculteurs manuels doivent déjà avoir acquis les ressources nécessaires pour apprêter leurs champs pour l'introduction de la traction animale, c'est-à-dire enlever les souches, les racines, procéder à un labour d'ouverture avant que les boeufs ne soient utilisés efficacement.

Cet investissement pour la préparation des champs, plus les ressources nécessaires pour louer les services de la traction animale, est un élément qui dépasse les moyens de la plupart des agriculteurs traditionnels; de plus ceux qui louent les services de la traction animale souhaitent devenir propriétaires de leurs propres attelages le plus vite possible. En conséquence, le marché location des services de la traction animale est sujet à une instabilité et à une limitation lorsque, de plein choix, les agriculteurs clients deviennent propriétaires d'attelages et finalement concurrents dans ce marché de location au reste des agriculteurs traditionnels.

Autres pratiques agricoles

Les agriculteurs utilisant la traction animale dans les zones de transition étudiées ont développé un système agricole comprenant deux types de champs:

- les champs présentant un caractère traditionnel complet et qui se développent en utilisant la force manuelle et les outils archaïques.
- les champs qui emploient à la fois la force manuelle et la traction animale. Ces champs sont d'un caractère semi-moderne et utilisent les pratiques modernes courantes.

Bien que le but de l'un ou de l'autre de ces champs soit l'augmentation de la production,

leur coexistence constitue une sous-utilisation non seulement de la traction animale mais aussi de celle de l'agriculture manuelle.

A l'opposé des agriculteurs qui ont tendance à pratiquer une agriculture de subsistance, les agriculteurs qui utilisent la traction animale manifestent un intérêt commercial pour la technologie qu'ils ont adoptée. En adoptant la traction animale, ils modifient leurs pratiques de production. Ils sont plus enclins à respecter le calendrier agricole. Ils sont ouverts aux méthodes modernes agricoles telles que semer en lignes dans les champs préparés en utilisant des graines améliorées, les engrais chimiques et les produits phytosanitaires. Ils sont plus prévoyants en ce qui concerne la fertilité de leur sol et l'importance des résultats à avoir. Etant donné la pression à laquelle ils font face pour respecter leur remboursement et assurer leur nourriture, les agriculteurs qui utilisent la traction animale donnent la priorité aux produits d'exportation coton, arachide et dont le marché est plus ou moins stable. Au Togo en fait, ce marché est garanti par une agence de commercialisation. De plus, la relance des soins de santé afférents à la traction animale même dans les zones où elle n'est pas pratiquée ou là où elle est de temps en temps ignorée, joue un rôle dans le domaine d'une plus grande association entre l'élevage bovin et l'agriculture.

Tableau 4:
Revenu net dans les systèmes agricoles mixtes

Cas	Agriculture	Elevage	Autre	Revenu
1	243 456	8350	16 000	267 806
2	651 580	16 000	29 500	697 080
3	315 504	8820	39 000	363 324
4	452 524	24 200	26 400	503 092
5	441 095	2150	13 000	456 245
6	516 834	53 845	2500	573 179
7	336 095	64 750		400 845
8	884 553		79 000	923 553
9	476 974	5500	66 000	548 474
10	662 073	83 800	164 000	869 873

Source: Division de la Programmation, de l'Évaluation et des Statistiques, PROPTA.

Les bénéfices procurés par la traction animale

Le profit produit par la traction animale provient de l'efficacité de la gestion agricole. Les bons gestionnaires sont plus capables de faire travailler la traction animale que les gestionnaires incompetents. Il n'y a aucun doute que l'adoption de la traction animale puisse accroître la production et le revenu net de quelques agriculteurs; cela est illustré par les quelques données financières d'agriculteurs à traction animale qui ont réellement réussi (voir Tableau 4).

Ces agriculteurs exploitent les zones de Broukou et de Kambolé et les chiffres en CFA représentent un revenu net positif produit par chacune de leurs opérations agricoles: agriculture, élevage du bétail et autres. Le revenu total net de ces agriculteurs est supérieur au revenu moyen par tête qui s'élève à 38 200 F CFA dans le secteur agricole.

Les chiffres sont tirés d'une étude non publiée sur les agriculteurs qui utilisent la houe et la traction animale dans les zones du Broukou et Kambolé (Amégbéto, août 1986).

Réinvestissement

Au niveau du village, il est possible d'observer la différence existant entre les familles d'agriculteurs qui utilisent la traction animale et celles qui utilisent la houe. Les premières sont capables de subvenir à leurs besoins en nourriture et tendent vers une amélioration progressive de la qualité de leur vie. Contrairement aux agriculteurs utilisant la houe, les familles qui utilisent la traction animale jouissent d'un niveau de vie nettement supérieur, du fait de l'augmentation de leurs revenus agricoles. Ceci est particulièrement vrai pour le niveau de consommation du chef de famille.

Cependant, pour la majorité des fermes visitées, les objectifs de l'agriculteur semblaient plutôt avoir été vite atteints. Quelques-uns investissaient dans l'agriculture, soit pour accroître

tre leur capacité productive, soit pour augmenter leurs revenus. De même, alors qu'ils reconnaissent le profit que procure la traction animale, ces agriculteurs consacraient leurs revenus à la réfection de leurs maisons et à l'achat de biens de consommation qui n'ont pas d'effet direct et progressif sur leur principale activité agricole, mais plutôt qui affermit la position sociale du chef de la famille.

Par conséquent, beaucoup d'agriculteurs qui utilisent la traction animale dépendent de la succession des saisons. Quand le temps de vendre une vieille paire de boeufs et d'acheter une nouvelle arrive, la situation financière de ces agriculteurs est tout à fait la même qu'avant. Ces agriculteurs, comme tout nouvel agriculteur utilisant la traction animale, ne disposent plus d'argent pour financer une nouvelle chaîne. De telles pratiques de gestion financière ne favorisent pas le développement de la traction animale à long terme. Comme toutes les autres situations discutées dans cette étude, celle-ci ressent le besoin d'un programme systématique de formation de l'agriculteur en matière de gestion de l'exploitation agricole.

Les limites de la diffusion de la traction animale

Pour la plupart des agriculteurs togolais qui utilisent la traction animale, le potentiel complet de la technologie n'a pas encore été réalisé pour des raisons à la fois naturelles et technico-financières.

Par exemple, la période pluvieuse est souvent si courte, dans quelques régions, qu'il est impossible d'exploiter pleinement la technologie de la traction animale. La préparation complète du sol ne préoccupe pas autant que le moment des semis. Ces aléas climatiques limitent les dimensions du champ et les ressources que comptent avoir les agriculteurs. De plus, la non disponibilité de main-d'oeuvre locale est un facteur limitant pour les agriculteurs togolais. La plupart d'entre eux comptent essentiellement sur le travail familial, une ressource qui

conditionne les nombreuses activités agricoles et non-agricoles de la ferme. L'importante contrainte du travail supplémentaire liée à l'adoption de la traction animale nécessite une main-d'oeuvre salariée occasionnelle; un fardeau financier qui s'ajoute à ceux qui ont été déjà cités.

En plus, l'augmentation de la surface cultivée nécessite souvent un investissement important pour la préparation du champ, c'est-à-dire, le dessouchage, le déblayage des terrains et les travaux exécutés par un tracteur. Tous ces coûts pèsent lourdement sur la stabilité financière d'une entreprise à traction animale et exercent une forte pression négative sur un entrepreneur de bonne volonté.

L'obstination de l'agriculture à la houe

Il est évident que, même avec la supériorité de la technologie de la traction animale, la houe ne sera pas si facilement éliminée, ceci pour les raisons suivantes:

- la majorité des familles togolaises agricoles aiment des aliments, le fufu par exemple, provenant des cultures à tubercules. Ces tubercules sont plantés dans des buttes où des trous sont plus facilement réalisés à la houe qu'à la traction animale. Ces préférences de nourriture, courantes dans la région de la Kara et du Sud, constituent une raison importante pour la persistance de l'agriculture à la houe au togo.
- quelques opérations, telles que le dessouchage et l'enlèvement des racines, les semailles, l'épandage du fumier, les soins aux cultures et la récolte, ne sont pas bien adaptées aux systèmes agricoles utilisant la force animale, et si même elles l'étaient, elles exigeraient un équipement supplémentaire, une formation et des ressources financières qui ne sont pas actuellement à la disposition de la plupart des agriculteurs.

Les opérations par traction animale ne donnent pas toujours des résultats réguliers et homogènes. Par conséquent, le travail à la houe est souvent indispensable même aux agriculteurs expérimentés en traction animale.

Effet sur le village

L'impact de la traction animale au niveau du village, dans les zones où cette technologie est en cours d'évolution, est généralement visible au marché. Broukou, dans la région de Kara, est un bon exemple. L'effet de l'accroissement de la production de l'agriculteur, des ventes du produit et de sa consommation, a été l'origine de la transformation du village en un centre commercial qui est un point d'attraction de plusieurs consommateurs et négociants des produits aussi bien locaux qu'importés. Des villages comme Broukou, tendent à atteindre une autonomie économique complète et une importance croissante dans leur zone. Ce dynamisme accru, au niveau du village, comme on en voit à Broukou et Kambolé, influence les jeunes togolais à reconsidérer l'agriculture comme carrière.

Conclusion

Cet exposé a tenté de cerner, à travers observations, descriptions et statistiques, l'espoir et l'intérêt qu'un nombre croissant d'agriculteurs togolais attachent à la technologie de la traction animale. En termes très simples, c'est une technologie qui ouvre de nouveaux horizons qui n'avaient jamais réellement existé auparavant dans le secteur agricole du monde rural.

Malheureusement, cette technologie n'est pas à la portée de tout le monde et il y a des échecs aussi bien que des succès à relater. Pour le

PROPTA, les échecs indiquent, de plus en plus, l'urgence avec laquelle la formation aux systèmes agricoles et de gestion des exploitations agricoles doit suivre l'adoption de la traction animale.

En guise de conclusion, vous êtes tous invités à visiter le PROPTA et le Togo. Le Togo est un pays où la traction animale est devenue une priorité, où elle existe même à l'intérieur des différentes régions à différents niveaux de développement, et où il y a une grande diversité de systèmes agricoles. Le jour où vous visiterez le Togo, vous y trouverez un effort dynamique, unique en son genre de développement de la traction animale.

Références

- Allingham, K. 1984. A contribution to the study of the sustainability of animal traction systems in Northern Togo. PROPTA, Atakpame, Togo. (E). (Unpublished).
- Amegbeto, K. N. 1986. Data from study of hoe and animal traction farmers in the Broukou and Kambole zones, August 1986. Division de la Programmation, de l'Evaluation et des Statistiques, PROPTA, Atakpame, Togo. (F). (Unpublished).
- IBRD 1984. Togo: issues and options for agricultural strategy. Western Africa Regional Projects Department, World Bank, Washington D.C. USA. (E).
- Kratz, A. 1982. L'histoire de la traction animale au Togo. *Le Courrier*, 72 (mars-avril): 42-43. (E,F).
- PROPTA 1985. Situation actuelle de la Traction Animale au Togo, octobre 1985. Division de la Programmation, de l'Evaluation et des Statistiques, PROPTA, Atakpame, Togo. (F).
- PVAS 1983. Rapport d'exécution du Programme Culture Attelée, financé sur Fonds du Conseil de l'Entente, décembre 1983, Projet Vivrier Atchangbadé-Sirka, Kara, Togo. (F). (Unpublished).
- USAID 1980. Rapport sur la Culture Attelée au Togo. Cited in Karen Parsons: Togo grain and the quest for self-sufficiency, August 1982. USAID, Lome, Togo.
- Zeidler, B. 1985. Rapport d'activités du 1/6/1981 au 28/2/1985. Evêché de Sokodé, Centre d'Animation Rural d'Adjengré, Sokodé, Togo. (F). (Unpublished).

Mechanical weeding with animal traction: some prerequisites

by

Pakoubatcho Lekezime

Coordonnateur, Projet Culture Attelée, DRDR Kara-Savanes, Togo

Abstract

In the Kara region of Togo few farmers use their triangular toolbars for weeding. Weeds limit the area cultivated and reduce yields. Kara farmers use the early rains to begin plowing. Seeding is delayed until rains become regular. Seeding is in hills to save time and allow for in-row weeding by hoe. Seeding density is low to conserve seed, but requires re-seeding. Fertilizer is applied 15-40 days after emergence at a time of peak activity to minimize leaching in accordance with extension recommendations.

With existing management systems mechanical weeding is not efficient. Delay between plowing and planting allows weeds to flourish. Delayed fertilizer application worsens matters resulting in weeds higher than the crop. Hill planting leads to weeds between plants. Thus with normal ox weeding practices it is difficult to follow rows.

A system is suggested that allows effective use of weeders. Early plowing is followed by harrowing prior to seeding. Fertilizer is placed in bands, prior to seeding when the farmer has more time and when it is needed. Seeding can be by hand or rolling injector seeder. A higher seeding rate reduces weed competition, eliminates re-seeding but uses more seed and requires thinning. The first weeding is an early rapid, superficial cultivation when the weeds are small. An additional weeding is necessary.

Introduction

The Kara region, located in northern Togo, receives approximately 1200 mm of rain from March to November. Though the cropping season runs from May to October (6 months), scattered early and late rains allow numerous

perennial weeds to survive the dry season. Farmers have thus been quick to realize the benefits of animal traction mouldboard plowing for weed suppression. Yet few farmers employ the triangular toolbar with sweeps for weeding. Weeds continue to limit the area cultivated and reduce yields per area. We wish to describe the current mouldboard plow management system, explain why farmers do not mechanically weed, and suggest changes that will enable them to employ their weeding equipment.

Current mouldboard plow management system

Kara farmers use the occasional early rains to begin plowing. Seeding is delayed from one to three weeks until the rains become regular and the soil profile is moist. This reduces the risk of crop failure. Seeding is not done in uniform, straight rows as the use of a rope or a row marker is time-consuming and the farmer does not intend to weed mechanically. In-row spacing for maize and sorghum is in hills spaced 50-60 cm apart. This allows for in-row weeding with the hand hoe. Seeding density is low (3-4 seeds/hill) which conserves seed but requires re-seeding. N-P-K (15-15-15) fertilizer is applied 15-40 days after emergence at a time of peak labour activity. N-P-K is applied post emergence to minimize leaching of an expensive input. The N-stressed young plants respond readily to the applied nitrogen which serves as positive reinforcement for the farmer.

This delayed application is an official extension theme of both the DRDR (Direction Régionale du Développement Rural) and SOTO-CO (Société Togolaise de Coton) who maintain that phosphorous and potassium are as readily leached as nitrogen. Weeding is performed with the short handled hoe when weeds are 20-30 cm high. This enables the farmer to manually pull weeds and shake the soil from their roots.

Why the farmer does not mechanically weed

Early efforts to encourage farmers to weed with their animals centred on the obvious: seeding in straight rows of uniform spacing (80 cm). Yet this rarely resulted in farmer adoption of mechanical weeding. When asked why not, the farmers usually responded that their animals were not sufficiently well trained to follow the row, or that they were afraid that their oxen would eat the crops.

We feel that the farmers persists in hand weeding because, given their existing management systems, mechanical weeding is not efficient. The one to three week delay between plowing and planting allows annual weeds to get a good start ahead of the crop. Delayed application of N-P-K fertilizer results in extremely slow initial crop growth. At the time of optimal mechanical weeding the weeds are higher than the crop, making it difficult for the farmer to follow the row. This is further aggravated by the fact that the re-seeded plants may not have yet emerged at the time of first weeding.

Planting in widely spaced hills allows weeds to grow between the plants. Mechanical weeding, coupled with in-row hand weeding is only slightly more efficient than hand weeding *under farmer conditions*. Finally the farmer believes the time for mechanical weeding is the same as for hand weeding. At this stage, weeds quickly collect on the sweeps of the weeder, necessitating frequent stops to clean them off.

Mechanically weeded management system

Using early rains for plowing is encouraged. Weeds, turned under will be partially decomposed by planting time. A final seedbed preparation, just prior to seeding, is necessary. The farmer has the option of purchasing a spike tooth harrow (30 000 CFA) or using the triangular toolbar equipped as a spring tooth harrow (included in the original purchase package). This will eliminate weeds that have germinated since plowing. (When plowing is done later in the season, the farmer has the option of plowing and planting the same day). N-P-K fertilizer is placed in bands, prior to seeding. Fertilizer is applied when the farmer has more time and when it is most needed by the crop. The increased seeding rate will help the crop to compete successfully with in-row weeds and reduce root disturbance by mechanical weeding. The N-P-K can be banded to one side of the rope used to seed, and the seed placed on the other side. Or it can be placed in the furrow made by the rowmaker which can be mounted on the triangular toolbar (3500 CFA). Though fertilizer banding is labour intensive, it is much less so than the point placement method currently used, and it occurs before the period of peak labour activity.

Spacing between plants in the row is reduced in order to achieve in-row cover as quickly as possible. Seeding can be done by hand or with the rolling injector seeder (the 6-hole maize disc places 1 or 2 seeds every 22 cm). The seeder (40 000 CFA) is extremely solid and can successfully seed in fields having stumps, roots and rocks or in fields having surface trash. Though the high seeding rate will eliminate re-seeding, the farmer will use more seed and will need to thin.

The first weeding needs to be done much earlier than for hand weeding. This consists of a rapid, superficial cultivation when the weeds are still small. An additional weeding will

usually be necessary. Use of a single ox is ideal for this operation.

Weeding with animal traction can result in a significantly increased area cultivated and in slight yield increases per unit area. Achieving farmer adoption though is more than seeding

in straight rows or providing additional training for the farmers and their oxen. It requires multiple fine-tuning of the farm management system to ensure the establishment of vigorous seedlings and the suppression of weeds. This will require close, constant supervision of the farmer.

Introduction de la traction animale dans les systèmes d'exploitation agricole au Togo; le problème de l'approvisionnement en animaux de trait

par

K. Apetofia

Directeur du Projet pour la Promotion de la Traction Animale (PROPTA), Atakpamé, Togo

Résumé

La traction animale a été introduite dans les systèmes de production dans le but de réaliser l'autosuffisance alimentaire de la population togolaise. A cet effet, plusieurs circuits ont été mis au point pour faciliter l'approvisionnement des exploitants en animaux de trait et l'adoption de la culture attelée. Cet approvisionnement se heurte toutefois à d'énormes problèmes dont les principaux sont: la disponibilité en bovins de trait aptes à la traction. Elle constitue l'un des goulots d'étranglement à la promotion de cette technologie. En effet, une absence quasi totale de marchés organisés du bétail caractérise certaines régions; l'approvisionnement se fait donc à travers des structures de commercialisation et comporte des problèmes d'efficacité en ce qui concerne la fourniture d'animaux aptes à la traction à des prix compétitifs; ce n'est que dans les régions des Savanes et de Kara que l'approvisionnement se fait par les agriculteurs propriétaires de troupeaux.

Les structures qui ont été créées pour pallier aux difficultés d'approvisionnement des autres régions souffrent toutefois de certains défauts:

- *prix élevés,*
- *mauvaise qualité des animaux,*
- *problèmes de disponibilité, compte tenu de la concurrence entre la culture attelée et la boucherie.*
- *la familiarité avec l'animal: dans certaines régions où les activités pastorales ne sont pas très développées, l'inexpérience avec les animaux expose les paysans à des échecs du fait de problèmes de zootechnie et de médecine vétérinaire. Les difficultés d'approvi-*

sionnement résultant de cette situation constitue donc un sérieux handicap aux tentatives d'introduction de la traction animale dans le milieu.

Les mesures prises pour pallier à ces difficultés comportent les éléments suivants:

- *la livraison de produits appropriés à des prix acceptables.*
- *une meilleure collaboration entre le projet et les paysans en ce qui concerne l'utilisation, l'entretien et le traitement des animaux.*
- *élaboration d'une stratégie d'approvisionnement des projets en animaux de trait en s'appuyant sur des noyaux d'élevage soit chez les agriculteurs, soit au sein des projets zootechniques.*

Introduction

Depuis 1977, date du lancement de la "Révolution Verte" pour l'autosuffisance alimentaire, la culture attelée est devenue une priorité nationale dans le développement de l'agriculture togolaise. La traction animale au Togo remonte à la colonisation allemande et connaît beaucoup de péripéties. En effet, de 1900 à 1977, des tentatives d'introduction et de sensibilisation à cette technologie ont été menées dans presque toutes les régions du pays, mais les résultats furent assez maigres. Seule la région des Savanes, au Nord, a pu répondre favorablement à partir des années 1964 à cette activité, grâce aux actions des pays voisins du Burkina Faso et du Ghana et à la disponibilité en animaux de traction dans cette région.

Plusieurs raisons sont à la base de cet échec dans les autres régions:

- non disponibilité d'animaux pour la traction,
- population non habituée aux bovins,
- manque de sensibilisation de la population à qui cette nouvelle technologie est apportée,
- mauvais encadrement des cultivateurs,
- manque de suivi des attelages, etc.

L'analyse de tous ces problèmes nous permet de relever les facteurs limitants du développement de la culture attelée dans les régions autres que la région des Savanes. Un des facteurs les plus importants est le facteur animal.

Le problème d'approvisionnement des cultivateurs en animaux de trait se pose sous trois formes au Togo:

- la disponibilité,
- la familiarité avec l'animal,
- le suivi de ces animaux sur le terrain.

Dans ce document, nous parlerons des différents circuits d'approvisionnement en animaux de trait en milieu rural et des problèmes qui leur sont inhérents.

L'approvisionnement en animaux de trait

La population animale de traction au Togo est presque entièrement composée de bovins. Les chevaux sont utilisés dans l'armée comme parade dans les manifestations officielles. Quelques dizaines d'ânes font le transport du bois et des marchandises au marché de Cincassé situé dans la région des Savanes, à la frontière du Togo avec le Burkina Faso.

La disponibilité en bovins aptes à la traction constitue l'un des goulots d'étranglement au développement et à la promotion de cette technologie. L'effectif au dernier recensement (1985) se chiffre à 234 545 têtes. L'élevage est généralement de type traditionnel.

L'absence quasi totale de marchés organisés du bétail caractérise certaines régions de l'intérieur, notamment les régions Centrale, des Plateaux et de la Kara. L'approvisionnement se fait donc par des structures de commercialisation faisant face à d'épineux problèmes de fourniture d'animaux aptes à la traction et à des prix compétitifs. Plusieurs modalités d'approvisionnement coexistent:

Approvisionnement par l'agriculteur lui-même

Cette pratique est plus fréquente dans la région des Savanes et une partie de la région de la Kara (Bassar) où certains agriculteurs sont propriétaires de troupeaux de bovins. L'agriculteur choisit donc les animaux à dresser dans son propre élevage. Dans ces conditions le poids financier de l'attelage est amoindri. La culture attelée se développe plus rapidement dans le milieu, le paysan étant déjà habitué à cohabiter avec les animaux. L'encadrement est moins sollicité et l'attelage est mieux suivi si le planteur est lui-même éleveur. Dans les conditions où le cultivateur n'est ni éleveur, ni propriétaire d'animal, des alternatives s'offrent à lui: il a la possibilité de chercher et d'acheter l'animal, auprès d'un autre éleveur du village, puis de se faire rembourser par un projet ou un organisme d'encadrement. Ici, le coût de l'animal est quelque fois moindre mais la qualité n'est pas toujours garantie (mauvaise conformation, tares, santé douteuse, etc.). De plus les prix pratiqués varient d'un fournisseur à un autre, d'un acheteur à un autre et dépendent quelque-fois des liens de parenté entre acheteur et vendeur.

Dans la région des Savanes, des choix judicieux sont souvent possibles grâce aux mœurs et aux habitudes des agriculteurs d'une part, et d'autre part, aux prédispositions écologiques de cette région. Ce type d'approvisionnement favorise l'augmentation des attelages sur une même exploitation. En outre, la responsabilité de l'agriculteur dans ce domaine devient plus grande et on constate que la formation donne

retentit favorablement sur leur maîtrise des techniques de culture attelée.

Approvisionnement par les agents des projets

Cette formule est celle qui était pratiquée aux débuts de l'introduction de la culture attelée dans les différentes régions. De nos jours elle a presque disparu au profit d'une centralisation au niveau du PROPTA ou au niveau même de l'agriculteur, comme décrit auparavant. Il s'agit ici d'un individu ou d'une équipe d'achat, dont le rôle est de faire la prospection du milieu, de choisir les sujets aptes à la traction animale et d'acheter les animaux pour les mettre ensuite à la disposition du planteur. L'encadreur ou l'équipe (qui est généralement composée de l'encadreur, du comptable du projet, du responsable du suivi sanitaire des animaux, du chef secteur ou du volontaire du Corps de la Paix) constitue ici l'élément essentiel autour duquel s'organise une campagne agricole.

Au sein d'une équipe d'achat, chacun des membres a un rôle déterminé à jouer. C'est ainsi que:

- le responsable du suivi sanitaire des animaux a pour rôle d'apprécier l'état sanitaire des sujets retenus et de procéder, en cas d'acceptation, aux premiers traitements prophylactiques. En cas d'absence de ce responsable, l'inspection vétérinaire de la région est sollicitée,
- le chef du secteur et le volontaire du Corps de la Paix coordonnent l'opération,
- le comptable du projet est chargé naturellement des opérations financières.

Cette procédure d'approvisionnement a des garanties quant à la qualité des animaux mais elle est plus chère, car là aussi, aucune structure de prix n'est mise en place pour contrôler le marché qui, de surcroît, est souvent fantaisiste lorsqu'il s'agit d'achat par des agents de l'administration.

Approvisionnement sur les marchés extérieurs au Togo

Il s'agit plus particulièrement du Burkina Faso et de la République Populaire du Bénin. Certains organismes, faute de trouver des animaux de bonne qualité dans leur milieu s'orientent vers les marchés étrangers. Ce système exige des contacts administratifs d'Etat à Etat et d'autres tractations qui ne satisfont pas toujours les intérêts du pays acheteur ou ceux des planteurs. En outre, il se pose souvent des problèmes relatifs au transport et à la santé des animaux.

Approvisionnement au niveau des ranches d'Etat

Quatre structures alimentent l'action culture attelée sur le territoire. Il s'agit:

- du Centre de Recherche et d'Elevage d'Avétonou (CREAT)
- du Ranch de l'Adélé
- du Ranch de Namiélé
- de l'Elevage Sous-Palmeraie de la SONAPH.

Il est clair que la qualité des produits de ces institutions est bien appréciée, les élevages étant bien suivis sanitaire et conduits suivant les normes zootechniques requises. Toutes ces quatre structures répondent bien aux besoins qualitatifs des utilisateurs des bovins de traction, mais la quantité fait défaut, étant donné la concurrence entre la culture attelée et la boucherie.

Certains autres projets (Le Centre d'Animation Rurale d'Adjengré, dans la Région Centrale, et le Centre d'Animation Rurale de Danyi, dans la Région des Plateaux) organisent l'approvisionnement de leurs planteurs à partir de noyaux d'élevages naisseurs qu'ils créent sur le plan cantonal pour soutenir leur action en cas de besoin: Aouda pour Adjengré, Adéta et Apéyéme pour le CAR de Danyi. Cette façon de procéder encourage les agriculteurs non seulement à devenir des éleveurs, mais

également à résoudre sur place, voire au niveau de l'exploitation, les problèmes d'approvisionnement ou de renouvellement des vieilles paires.

Tous ces circuits d'approvisionnement dont nous venons de parler, hormis celles des CAR, ne présentent aucune garantie pour l'exploitant agricole. De plus, plusieurs projets et organismes se retrouvant en même temps sur le terrain pour la même cause, les commerçants et les éleveurs en profitent pour spéculer sur les prix.

En vue de pallier à cela, deux organisations, le Projet Culture Attelée à Kara et le Projet de Développement de l'Élevage Bovin dans les Régions des Plateaux et Centrale (PRODEBO) ont pris en main l'approvisionnement des projets au niveau des différentes zones de 1979 à 1982: PCA pour Kara et Savanes, PRODEBO pour les Plateaux jusqu'à quelques projets de la région de la Kara.

Toujours dans le souci d'harmoniser les actions, le gouvernement a décidé, par l'intermédiaire du Comité d'Etude et d'Orientation des Programmes de Culture Attelée (COCA) de confier, à partir de 1982, toutes les actions de coordination de la culture attelée au Togo au Projet pour la Promotion de la Traction Animale (PROPTA). L'une des attributions de cet organisme est l'approvisionnement en animaux de trait de tout projet qui en fait la demande.

Approvisionnement en boeufs de trait par PROPTA

Les sujets retenus par PROPTA tiennent compte des critères de choix des animaux de trait. La couverture prophylactique est assurée au lieu même de l'achat, avant leur mise en quarantaine et leur livraison. Les animaux sont également marqués, ce qui limite les vols, permet de déterminer les zones d'achat et de contrôler ainsi les maladies contagieuses. Le prix d'achat est fixé à 240 F.CFA le kg vif.

Les régions et zones d'achat des boeufs sont indiquées dans le tableau 1. L'analyse de ce tableau nous amène à quelques commentaires:

La Région des Savanes a fourni à elle seule, environ la moitié des boeufs acquis durant la période 1982-1986; celle de la Kara a fourni le quart et les Régions Centrale et des Plateaux, le quart restant (voir diagramme 1). Dans ces deux dernières régions, ce sont surtout les Centres d'Élevage qui ont fourni la majeure partie des boeufs.

Cette situation reflète en quelque sorte la répartition du cheptel bovin sur l'étendue du territoire.

- Région des Savanes	107 000 bovins
- Région de la Kara	66 000 bovins
- Région des Plateaux	59 000 bovins
- Région Centrale	16 100 bovins
- Région Maritime	2 700 bovins

Au début du projet, l'approvisionnement s'est surtout fait dans la région de la Kara (cf. graphique 2), aire géographique du taurin Konkomba, race résistante à diverses maladies et donc recommandée pour la traction. Malheureusement, la plupart des projets et organismes auxquels sont destinés ces bêtes ont récriminé leur petit format (150 à 170 kg pour les jeunes de 24 à 30 mois). Ils préfèrent pour cela des métis zébu-taurins ou même quelquefois des zébus qui sont plus lourds.

Tenant donc compte de ces desiderata, PROPTA s'est tourné en 1984 vers le marché de la région des Savanes, d'où une augmentation du nombre de bovins achetés dans ces zones où le poids des animaux pour le même âge est compris entre 170 et 225 kg (graphique 1 et 2). Il est bon de souligner que dès leur achat, les animaux reçoivent des traitements prophylactiques contre les parasites externes, les helminthoses, la trypanosomose; ils sont également vaccinés contre la peste et, quelquefois, le charbon bactérien.

Problème d'approvisionnement au niveau de l'agriculteur

Si les projets exécutent leur programme selon un ordre déterminé par le souci de soutenir et de faire réussir les objectifs fixés, il n'en demeure pas moins qu'un côté leur échappe. Il s'agit de la livraison des produits aux utilisateurs à des prix correspondant à leurs possibilités financières. Le deuxième effet de l'intervention des projets est la responsabilisation indirecte à laquelle ces derniers sont astreints pour préparer la relève. Pour ce faire deux conditions se posent: celle de l'existence d'une population bovine dans la région et celle des moeurs et coutumes des agriculteurs du milieu.

- Dans les régions où l'élevage fait partie des activités principales de la population, la région des Savanes notamment, la traction animale est également ancrée dans les habitudes des agriculteurs, à telle enseigne que la résolution du problème d'approvisionnement se fait sans heurts. C'est une éducation qui se transmet d'une génération à une autre et constitue l'un des points forts de la réussite des projets dans la région. L'exploitant agricole ayant une certaine familiarité avec les animaux a, la plupart des cas, des notions bien fondées pour choisir des sujets aptes à la traction. Au cas où il n'est pas propriétaire d'un troupeau, ou même s'il ne trouve pas des sujets conformes à cette activité, les relations familiales interviennent:
 - Achat des boeufs à des prix intéressants en raison de ses relations avec le propriétaire du troupeau.
 - Echange de sujets (généralement des génisses) contre des boeufs.
 - Le choix de ces animaux étant fait sur la base des notions de médecine vétérinaire et de zootechnie peu convaincantes, cela n'exclut pas les risques que court l'agriculteur en cas d'incubation de certaines maladies. Aucune disposition n'est prise à l'achat pour assurer la couverture sanitaire

de ces animaux; en conséquence, l'exploitant perd prématurément ses bêtes à la suite d'un stress dû à la disproportion d'efforts par rapport à sa force normale de traction, ou bien au manque d'entretien auquel elles sont soumises. La campagne agricole est de ce fait compromise.

- La situation des agriculteurs de la Région Maritime est la plus indiquée dans le deuxième cas. En effet, cette région, par opposition à celle des Savanes, regorge de potentialités agricoles intéressantes mais elle demeure une zone moins développée sur le plan des activités pastorales, plus exactement celles des bovins.
- L'élevage et l'agriculture sont des activités bien distinctes; l'intégration demeure difficile. Ce facteur constitue un handicap certain pour les tentatives d'introduction de la traction animale dans ce milieu. A côté de la rareté des bovins, l'inexpérience avec les animaux, les tabous, les moeurs et coutumes ne sont plus à négliger. Aussi, la reconversion des mentalités alliée à un effort d'intensification de l'élevage bovin seront le levier de la culture attelée dans ce milieu.

En attendant une orientation des activités, les services d'encadrement demandent au futur agriculteur de culture attelée de chercher lui-même ses animaux. Il s'ensuit que ce dernier, profane en la matière, perd une bonne partie de son temps pour faire son choix, et même s'il le fait, c'est dans des conditions l'exposant à des échecs tant sur le plan zootechnique que sur celui de la médecine vétérinaire. Dans le même ordre d'idées, le marché conclu est la plupart du temps en disproportion avec la qualité des produits: prix forts pour des animaux qui ne répondent pas aux critères retenus pour les sujets de traction.

Collaboration projet-exploitant agricole en culture attelée

Comme décrits plus haut, les deux systèmes d'approvisionnement ont leurs avantages et

leurs inconvénients. L'interaction des projets et des exploitants agricoles devient une nécessité pour le succès des uns et des autres, si les conditions de population bovine sont réunies.

En effet, l'irruption des projets dans les campagnes à la recherche d'animaux de trait offre une occasion certaine aux propriétaires de spéculer; en outre, la prospection des marchés d'achat des animaux par les intéressés sans les services d'un technicien (de l'inspection vétérinaire) constitue dans la plupart des cas la cause de perte de plusieurs sujets et même la dissémination de maladies dans les milieux ne connaissant pas cette pathologie. Partant de ces éléments, la conjonction des deux systèmes s'avère nécessaire pour les deux parties. C'est cette politique que certains projets viennent d'instaurer pour le mieux être des populations et le succès de leur action dans leur milieu.

L'approvisionnement se fait en trois étapes:

- Prospection des milieux des troupeaux et discussion des prix avec les éleveurs ou commerçants par les futurs bénéficiaires; le plafond est fixé à l'avance par le projet.
- Paiement assuré par le service d'encadrement après avis favorable des responsables de zootechnie du projet.
- Traitements prophylactiques exécutés par une équipe de l'inspection vétérinaire de la région.

Stratégie d'approvisionnement des projets en animaux de trait

Depuis l'introduction de la traction animale dans les exploitations agricoles, nous assistons à la mise en place d'une vaste opération de métamorphoses dans les systèmes d'approvisionnement des projets en animaux de trait. Au sein des services d'encadrement, les responsables déploient des efforts pour donner un visage réaliste à la technologie.

L'heure est maintenant au processus du suivi et au bilan avec la création du PROPTA. La renaissance de la culture attelée a pris un ca-

ractère particulier avec les résolutions des 4^e et 5^e Conseils Nationaux du Parti; c'est ainsi que l'on trouve des zones où se ruent des négociants d'animaux; cette ruée liée aux divers mouvements a permis la propagation de certaines maladies. Face aux problèmes de prix et de pénurie du bétail de traction, des marchés extérieurs ont été sollicités. Il s'agit ici du Burkina Faso et de la République populaire du Bénin dont nous avons fait cas plus haut. Cette tactique n'a pas porté les fruits qu'on en escomptait: prix de revient sensiblement plus élevé que celui pratiqué dans nos milieux, risque de perte d'animaux plus élevé également. Aussi, pour pallier ces contraintes, il a été décidé par certains projets de procéder à la mise en place de noyaux d'élevage soit chez les agriculteurs, soit au sein même des activités zootechniques desdits projets:

- prêt de génisses d'élevage
- utilisation des femelles dans la traction
- création de parcs de reproduction.

Prêt de génisses d'élevage

Le programme FED-Savanes a débuté en 1980. Ces actions ont été préparées par le BDPA dont la politique dans le domaine de la zootechnie a eu deux axes:

Approvisionnement à partir du Mali de la race N'dama avec comme objectif:

- amélioration du troupeau local.
- donner une orientation plus fiable à la traction animale.

Les animaux dans ce cas sont passés aux bénéficiaires sous forme de contrat dont le thème clé est la garde des animaux sous leur stricte contrôle. Ceci sera à la base de l'intégration de l'élevage à l'agriculture et permettra en outre d'éviter la suprématie du pasteur peul sur les produits de l'élevage (traite des vaches, vente illicite de certaines têtes). Le contrat comportait l'octroi de trois génisses et d'un taureau pour une période de quatre ans.

Approvisionnement sur place

Le BDPA dans la seconde phase de ses activités s'est intéressé aux produits des troupeaux locaux. Ce système a vite cessé à cause du départ quelque peu prématuré de cet organisme d'une part, de la malhonnêteté des bénéficiaires de l'autre, conséquence logique du suivi irrégulier dont les animaux faisaient l'objet. Vers 1975-1976, les actions furent ainsi bloquées; le programme de l'approvisionnement cessa et devra un an plus tard connaître une autre tournure.

Avant la reprise, il a été procédé à une étude d'évaluation des potentialités de cette région en animaux. Ceci ouvrit la voie à l'approvisionnement individuel basé sur un fonds à mettre à la disposition de tous les postulants. Cet apport financier donna l'opportunité au programme FED d'intervenir dans le domaine de la culture attelée à partir de mars 1980.

Prêt de génisses d'élevage formule DRDR Centrale

Dans le chapitre "zootechnie" de la Direction Régional de Développement Rural Central (DRDR-Centrale), un volet vient d'être créé pour la vulgarisation de génisses sous contrat pour promouvoir l'élevage des bovins sur les exploitations mêmes de l'agriculteur et assurer ainsi le renouvellement des sujets arrivés en fin de carrières; pourra souscrire à ce prêt, tout agriculteur ayant respecté les clauses de remboursement de crédit "prêt attelage"; l'opération est à ses débuts; la durée du prêt n'est pas encore déterminée.

Dans le même concept que celui décrit plus haut la conduite personnelle, c'est à dire l'organisation du métier de pasteur, est de rigueur. L'opération est bien accueillie par les populations intéressées et permet de noter dans les milieux qu'elle demeure le support principal de l'intégration de l'élevage à l'agriculture.

Utilisation de génisses dans la traction

Ce procédé responsabilise à double titre les utilisateurs:

- Exploitation de la force animale dans les travaux culturels; dressage à condition de se référer aux critères de choix des animaux de trait.
- Constitution de noyaux d'élevage.

Bien imprégnés des idées développées jusqu'ici, l'utilisation des femelles dans la traction devient une nécessité. L'étude analytique nous montre :

- Une disponibilité d'une catégorie d'animaux aptes au dressage à condition de se référer aux critères de choix des animaux de trait.
- Cette disponibilité est possible grâce à la nouvelle orientation du programme du suivi sanitaire qui garantit une bonne santé et un bon développement aux animaux grâce à un approvisionnement permanent en produits vétérinaires et en logistique.
- La planification de l'utilisation des ressources fourragères (pâturage naturel) et des sous-produits agricoles de l'exploitation.

Analyse des prix

Elle est définie selon la période, les relations sociales, les événements.

Au niveau traditionnel

Les prix pratiqués varient d'une région à une autre, d'un fournisseur à un autre, des conditions sociales liant les deux parties, de celles dans lesquelles se trouvent le vendeur et de celle de la personne qui se présente à lui. Ce prix n'est fonction d'aucun élément de base technique, (poids, âge, dépenses engagées jusqu'à la période de vente, transports, traitements prophylactiques, etc...).

Il se fait donc à partir d'une appréciation visuelle. Ce qu'on peut retenir surtout comme élément capital influant sur le prix est sans doute la période à laquelle s'effectuent les achats. En effet, à la période des grandes fêtes les prix montent, tandis que nous assistons à leur baisse à la rentrée scolaire et pendant la période de soudure. C'est l'une des caractéristiques principales des transactions de ce genre dans la région des Savanes.

Au cours d'une enquête que nous avons menée, il est apparu dans la région des Savanes qu'un animal de 180 à 200 kg de poids vif pouvait coûter entre 35 000 et 55 000 Francs CFA.

Au niveau des ranches d'Etat

Ici interviennent tous les éléments techniques de production, zootechniques, sanitaires, de transport; les prix pratiqués y sont fixes toute l'année soit 325 F. CFA/kg vif pour tous les ranches (Adélé, CREAT, Projet Elevage Sous Palmeraie de Wonougba), et 285 F CFA/kg pour Namiélé.

Malgré les coûts de production assez élevés, les responsables des ranches s'en plaignent à cause du coût élevé de production et se proposent de l'augmenter ces prix de vente. Il est donc fort possible qu'ils passent à leur révision dans les prochains mois de l'année 1987.

Au niveau des marchés extérieurs

Devant la flambée des prix pratiqués par les propriétaires de troupeaux locaux, conséquence première de la dernière éclosion de

foyer de peste bovine dans la région à vocation pastorale, devant le problème de la loi de l'offre et de la demande et certaines exigences des utilisateurs de bovins de trait, la Division de l'Approvisionnement en animaux de Trait au PROPTA a effectué une mission de prospection de marché en République Populaire du Bénin. Le rapport présenté par cette mission note les constatations suivantes :

- Possibilité d'approvisionnement assurée
- Période idéale pour cette opération: décembre-mars.
- Prix de revient excessivement cher comparativement à ce qui est pratiqué au Togo.

Ce troisième point est le vrai goulot d'étranglement qui a empêché cette division de mettre à exécution son programme d'achat.

Conclusion

Le problème d'approvisionnement en animaux de traction est assez sérieux au Togo. Pour y pallier, plusieurs alternatives sont offertes. La collaboration entre projets et exploitants agricoles ou une structure nationale de coordination à l'instar du PROPTA semblent indiquées pour procéder aux achats à des prix compétitifs.

Les ranches d'Etat sont loin de résoudre le problème d'approvisionnement si le coût de revient de leur production n'est pas mieux étudié. L'introduction de génisses dans les exploitations agricoles sous forme d'élevage ou pour faire la culture attelée permet de constituer des noyaux d'élevage pouvant accélérer la fourniture d'animaux de traction.

Suivi sanitaire des animaux de trait au Togo: situation et amélioration

par

E. Leroy

Vétérinaire, chargé de la Coordination du Suivi Sanitaire des Animaux de Trait, PROPTA, Togo

Résumé

Depuis quelques années chaque projet de promotion de la traction animale exécute le suivi sanitaire de ses animaux avec ses propres moyens. Dans le but de permettre aux IVSA régionales (IVSA = Inspection Vétérinaire et Santé Animale) de prendre totalement en main le contrôle et l'application du suivi sanitaire des animaux de culture attelée, le PROPTA (Projet de promotion de la traction animale) a mis au point des projets de contrats discutés avec les différents projets et services.

L'approvisionnement de ces projets en matériels roulants, en matériel vétérinaire et en médicaments nécessaires depuis 1986 ont permis aux IVSA d'organiser des tournées de prophylaxie des animaux; il en a résulté une uniformisation du coût du traitement prophylactique par paire de boeufs dans tout le pays.

Par ailleurs les projets sont consultés pour la mise au point de calendriers, l'établissement des prix et des traitements. Les projets ne sont toutefois pas obligés de fournir toute la logistique et peuvent compter sur l'action efficace des IVSA. En outre, des dispositions sont prises pour que les IVSA s'occupent des animaux des cultivateurs privés dans le cadre de traitements individuels ponctuels. Ainsi, le PROPTA s'attèle, comme par le passé, à fournir une assistance technique en matière de formation et d'information au niveau du suivi sanitaire des animaux au Togo.

Suivi sanitaire des animaux de trait au Togo

Il y a quelques années (3-4 ans), chaque projet s'occupant de culture attelée faisait lui-même

le suivi sanitaire des animaux avec ses propres moyens; les IVSA n'avaient pas les moyens matériels et les équipements pour assurer ce suivi sanitaire; par contre les moyens humains ne leur faisaient et ne leur font toujours pas défaut.

L'arrivée de volontaires du Corps de la Paix des Etats Unis dans la région des Plateaux, de la Kara et des Savanes, a permis d'améliorer cette situation et de démarrer une certaine coordination des actions du suivi sanitaire, en collaboration avec les services des IVSA.

Quoique leur action soit très efficace, le nombre et les moyens réduits de ces volontaires en ont souvent limité la portée. Si bien que jusqu'au début de 1985 seuls quelques résultats très positifs étaient enregistrés dans les régions des Plateaux et des Savanes.

Une exception à cela est constituée par la région du Centre où la GTZ et la Direction Générale du Développement Rural (DRDR) avait mis sur pied depuis 1982 une association avec l'IVSA pour le suivi sanitaire des animaux de traction; à cet effet, ils ont fourni un certain nombre d'équipements: motos, autos, médicaments, petit matériel et du fonctionnement; ce système marche de nos jours très bien et il a servi de base à certaines actions du PROPTA.

Le but du PROPTA est de coordonner ces activités et de permettre à l'IVSA d'effectuer le suivi sur l'ensemble du territoire et par ses propres moyens. Pour cela, le PROPTA a mis

au point des projets de contrats qui doivent encore être discutés par les différents services et projets; ces contrats sont passés entre les IVSA et les organismes s'occupant de traction animale et prévoyant le suivi sanitaire des animaux de trait par les IVSA. Dans ces contrats, le PROPTA aura une action combinée d'explication, d'animation et de coordination du suivi sanitaire et zootechnique en collaboration avec les IVSA.

Le projet apporte également une importante partie du matériel nécessaire ainsi qu'une partie du fonctionnement de ce matériel auprès des IVSA.

Des accords de cession de motocyclettes et de bâchées viennent d'être passés entre PROPTA et la Direction du Service Vétérinaire et Santé Animale (DSVSA); d'autres suivront. Nous espérons aussi pour bientôt un accord direct entre la Santé Animale au sujet de ce suivi sanitaire: nos propositions concernant nos obligations (médicaments, fonds de roulement, petit matériel vétérinaire, moyens de déplacement, etc.) et celles des IVSA (gérance des stocks, applications pratiques du suivi sanitaire, etc.) sont également à l'étude.

Pour l'instant (depuis août 1985), le projet a surtout aidé les IVSA à organiser les tournées de prophylaxie des animaux de trait en leur fournissant du matériel vétérinaire et des médicaments, en organisant ou en participant à des réunions de coordination de ce suivi dans les différentes régions. Ceci a permis, par exemple, depuis le début 1986, d'uniformiser le coût d'un traitement prophylactique par paire dans tout le pays. De même, pour certaines régions (Savanes, Plateaux et Maritime), un calendrier annuel avec toutes les implications logistiques a été mis au point et fonctionne déjà. Dans la région Centrale, cela se fait aussi en collaboration avec la GTZ-DRDR où nous avons essayé et pratiquement réussi à intégrer les animaux de culture attelée des autres projets dans leur calendrier annuel; tout

en pratiquant le même prix qu'ailleurs. Ce qu'il faut encore faire, c'est d'habituer les projets à ces réunions par d'autres au moins un mois avant les traitements prévus pour préciser dans les détails (si ce n'était pas déjà fait) et rappeler les décisions prises à tout un chacun. Surtout, on doit prendre l'habitude de bien faire circuler l'information et de respecter ce qui a été décidé d'un commun accord.

Le PROPTA est là pour l'instant pour aider à coordonner et appliquer ces actions. Une fois le matériel et la logistique (particulièrement les motos) mis en place, les IVSA devraient avoir beaucoup plus de facilité à appliquer ces calendriers et cela reviendra moins cher qu'actuellement où l'on utilise des bâchées et où dans certains cas, on pare au plus pressé à la dernière minute parce que l'un ou l'autre n'a pas pu faire comme cela était prévu.

Comme nous l'avons déjà dit, le but de l'opération que le PROPTA mène en ce moment, est de permettre aux IVSA régionales de prendre totalement en main le contrôle et l'application du suivi sanitaire des animaux de culture attelée. Ceci, en ayant à leur disposition le matériel roulant, le matériel vétérinaire et les médicaments nécessaires, ainsi qu'en étant liées par contrat particulier avec chaque projet de la région, définissant les conditions de cette action. De cette façon, les projets seront toujours consultés pour mettre au point les calendriers, les prix, les types de traitement, etc.; mais ils ne seront plus astreints à fournir toute la logistique et pourront compter sur une action efficace des IVSA.

Pour les éleveurs-cultivateurs privés (c'est-à-dire ne dépendant pas ou plus d'aucun projet de Culture Attelée), nous essayons également de trouver une solution afin que les IVSAs s'occupent de leurs animaux. Cela rentrerait dans le cadre de ce que nous appellerons les traitements individuels ponctuels, aussi bien des privés que de ceux dépendant d'un projet: il faut qu'un animal malade soit traité à temps

(en dehors des prophylaxies) avec toutes les sécurités voulues aussi bien pour le cultivateur (action rapide, efficace, pas trop coûteuse) que pour les IVSA (paiement de certains des traitements).

Des projets pour résoudre ce problème sont à l'étude au PROPTA aussi et font partie, pour

la plupart, des projets d'accord que nous avons préparés.

En dehors ou en sus de ce que nous venons de dire, PROPTA a toujours fourni (et continuera à le faire) une assistance technique d'information ou de formation au niveau du suivi sanitaire des animaux de trait.