

AT MICROFICHE
REFERENCE
LIBRARY

A project of Volunteers in Asia

Horse-Drawn Farm Implements, Part II:
Preparing the Soil

by John Thompson

Published by:

John Thompson
1 Fieldway
Fleet, Hants
UNITED KINGDOM

Available from:

same as above

Reproduced by permission.

Reproduction of this microfiche document in any form is subject to the same restrictions as those of the original document.

HORSE-DRAWN FARM IMPLEMENTS

PART II

Preparing the Soil

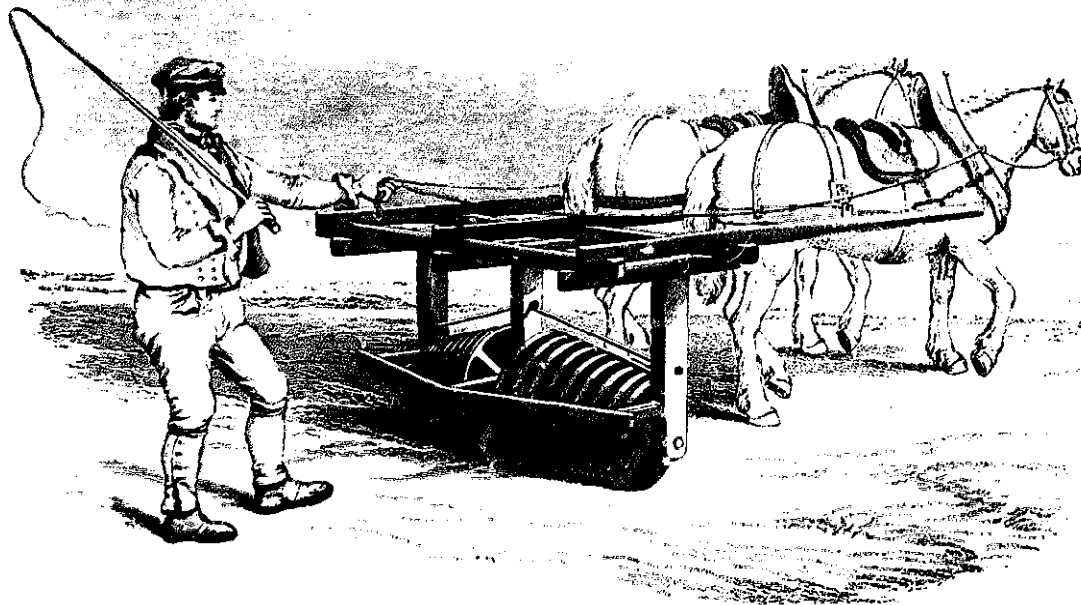

No. 4 IN A SERIES OF SOURCEBOOKS

Containing a selection of engravings and contemporary descriptions of cultivators, horse-hoes, rollers and harrows, reproduced from 19th Century agricultural books and manufacturers catalogues.

Compiled and Introduced
by

John Thompson

AMIES AND BARFORD'S

NEW PATENT

Adjustable Water-ballasting Wrought Iron Field Rollers.

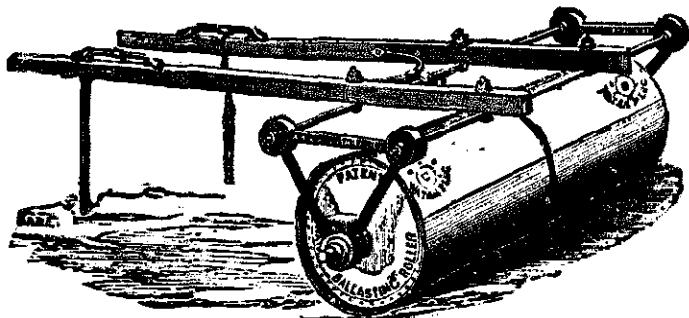

The large Rollers described on preceding page are designed chiefly to meet the wants of Noblemen and others who require occasionally a *very heavy* implement; but A. and B. now have pleasure in calling the attention of Agriculturists to the above, and while submitting the subjoined revised list of prices, would call particular attention to the following advantages possessed by these rollers over all others.

The cylinders and frames are made entirely of *wrought iron*, combining immense strength with durability, and are entirely free from the liability to breakage on rough, bad roads, and from other causes so common to the ordinary *cast iron* roller; in fact, whether through accidents or ordinary work, it is next to impossible to break these rollers.

They are cheaper than any kind, because *two* implements must be bought to obtain the same results here secured in *one*, as the weight of either size can be *doubled* if desired, by simply removing the brass water plug shewn in the engraving, and filling the cylinders with water.

Thus, besides securing in *one* roller a one, two, or three-horse implement at pleasure, the increased weight is employed directly on the *surface of the land*, with the highest possible percentage of crushing power, yet without increasing the friction on the bearings (and consequently the draught of the implement), as is the case when the old clumsy plan of loading the *frame* is resorted to.

They are designed to meet the requirements of small as well as large farmers, and are as easily made to weigh five tons as five cwt., according to the wishes of the purchaser.

As a proof of the value of this invention, it may here be mentioned that 6 Silver Medals and 10 First Prizes (in competitions open to all England) have been awarded to it, being successful on every occasion where it has competed, including the **FIRST PRIZE**, at the late trials of the Royal Agricultural Society, at Newcastle-upon-Tyne, against 40 competitors.

LENGTH 51 FEET

AMIES & BARFORD'S

IMPROVED PATTERN

Press Wheel Clod Crusher and Land Roller

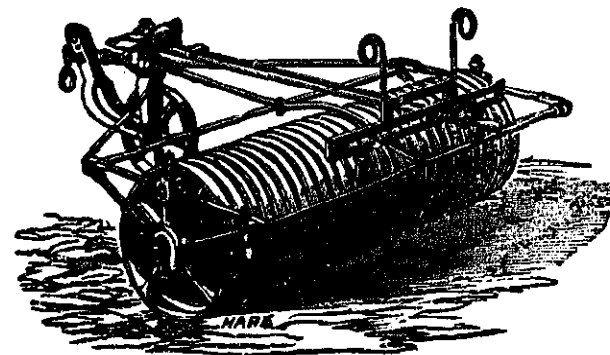

A novelty and moreover a GREAT IMPROVEMENT has been introduced into this Article.

The Cylinders are on Cambridge's principle but the frame **WHOLLY OF WROUGHT IRON**. It is fitted with a steering front guide rod, which enables the man not only to steer the implement with the greatest nicety, but at the same time with the assistance of reins 3 horses abreast without the aid of a boy. A saving of *one fourth* power is certainly saved thereby, and the undue strain upon the horse, so much to be condemned, is avoided. Being made entirely of wrought iron these rollers are not liable to damage by the weather, as is the case with all others.

PRICES—7 feet wide.

30 inches diameter	18	0
26 ditto	15	10
24 ditto	14	10
20 ditto	13	0

If made with seat for Driver, extra...£2 0 0

If fitted with Patent Scrapers which also make a perfect brake when strongly recommended, extra—£2 10s. 0d.

Can be made any width from 5 to 8 feet, to suit purchaser.

CULTIVATORS.

Fig. 2.
Plan



Upright



Plan of the Shares.

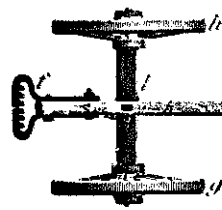

Fig. 1.

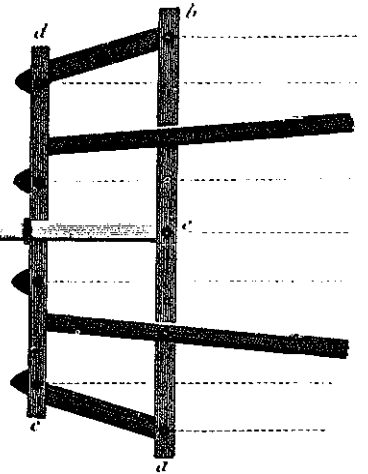

Fig. 4.

M. F. Western's Double Cultivator.

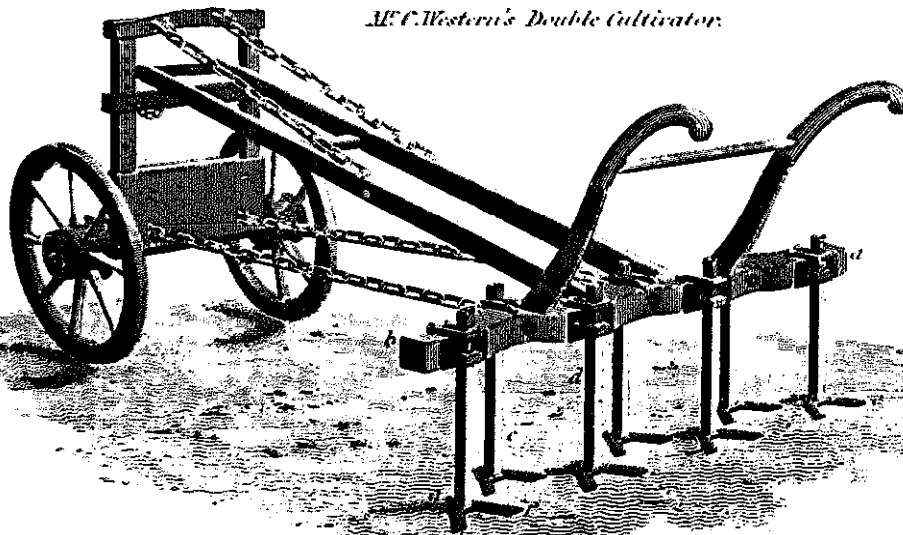

Fig. 3.

M. Roger's Bean Cultivator.

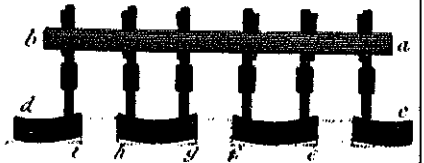
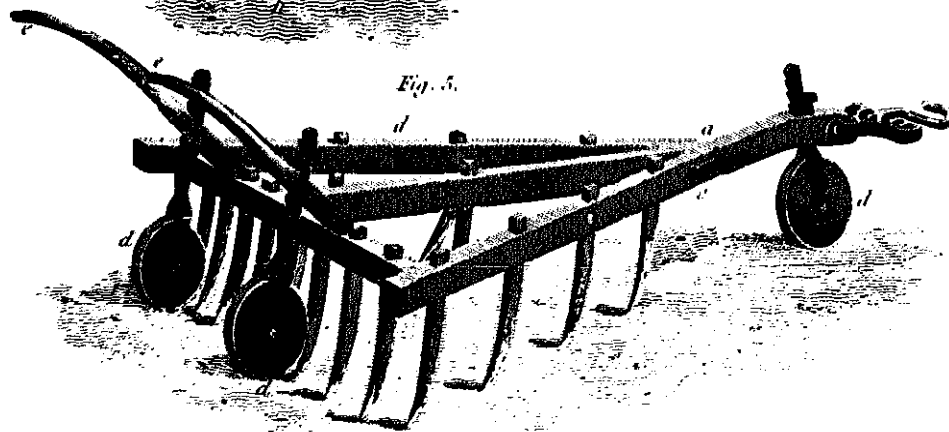

Fig. 5.



FRONTISPIECE — This engraving was prepared in 1816, for 'An Encyclopaedia of Agriculture' by J.C. Loudon. At that time the implements were made of wood, except for the actual tines, and even had wooden wheels similar to those used on farm carts. See also the plan of the Couch grass rake from the same source, on the opposite page.

HORSE-DRAWN FARM IMPLEMENTS

PART II

Preparing the Soil

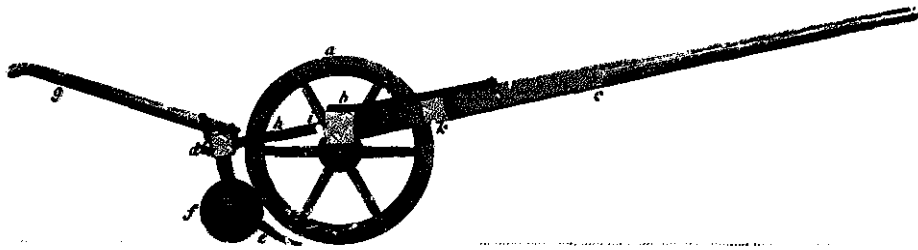

MR. AMOS'S Couch Grass Rake.

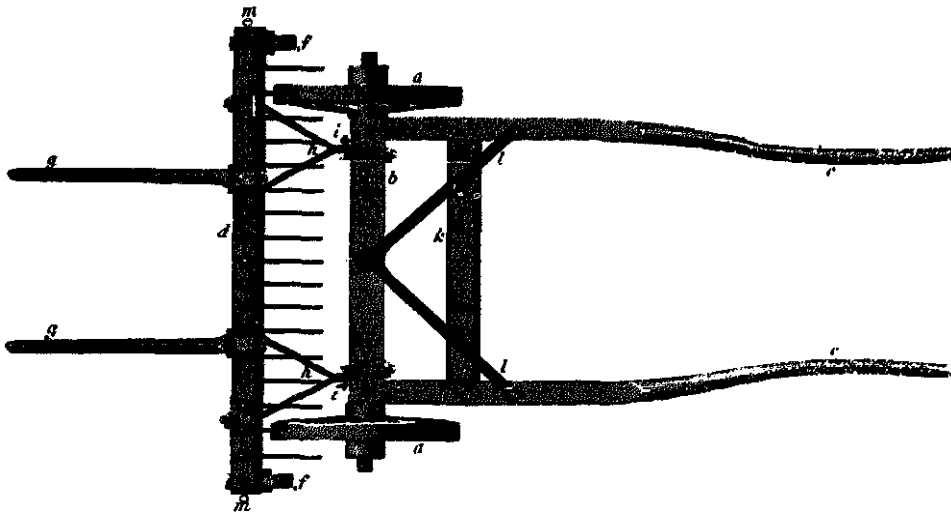

OTHER SOURCE BOOKS IN THIS SERIES:—

- 1 Horse Drawn Trade Vehicles**
- 2 Horse Drawn Heavy Goods Vehicles**
- 3 Horse Drawn Farm Implements — Part I, Ploughs**
- 5 — Part III, Sowing and Haymaking**
- 6 — Part IV, Harvesting**

IN COURSE OF PREPARATION:—

- 7 Horse Drawn Carriages**
- 8 Horse Drawn Farm Transport**

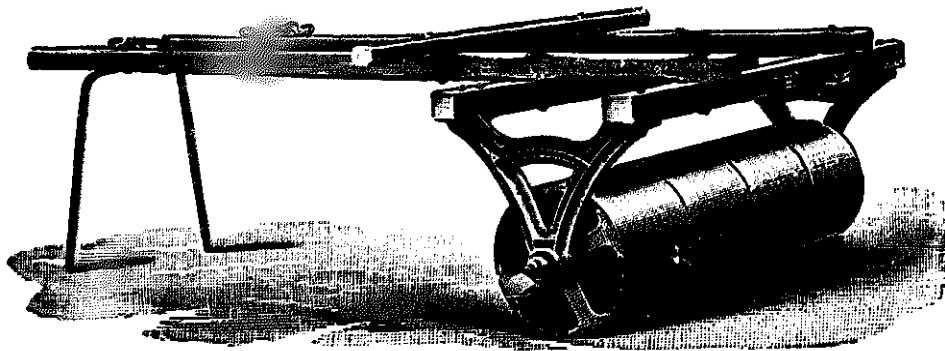

The purpose of this series of "Source Books" is to supply the enthusiast, student and modelmaker with clear illustrations and specific information, taken from out-of-print books, journals and manufacturers' catalogues. The material is presented exactly as it was printed, so that the reader can have direct access to the source. These original books are now rare collectors' items, and are only available at a very few reference libraries.

I do not pretend that these source books give a complete survey of the field — they are necessarily limited by the gaps in my collection of books, although kind friends have loaned some invaluable items to be included. However, any lack of balance is compensated by the presentation of factual detail, which is seldom to be found in more general accounts.

First Published 1979

by

John Thompson, 1 Fieldway, Fleet, Hampshire, U.K.

This selection with additional material ©John Thompson 1979

ISBN for complete set of 4 volumes: 0 9505775 5 3

ISBN for this volume: 0 9505775 7 X

Printed and Produced by Charterlith, 30 Reading Road South, Fleet, Hampshire.

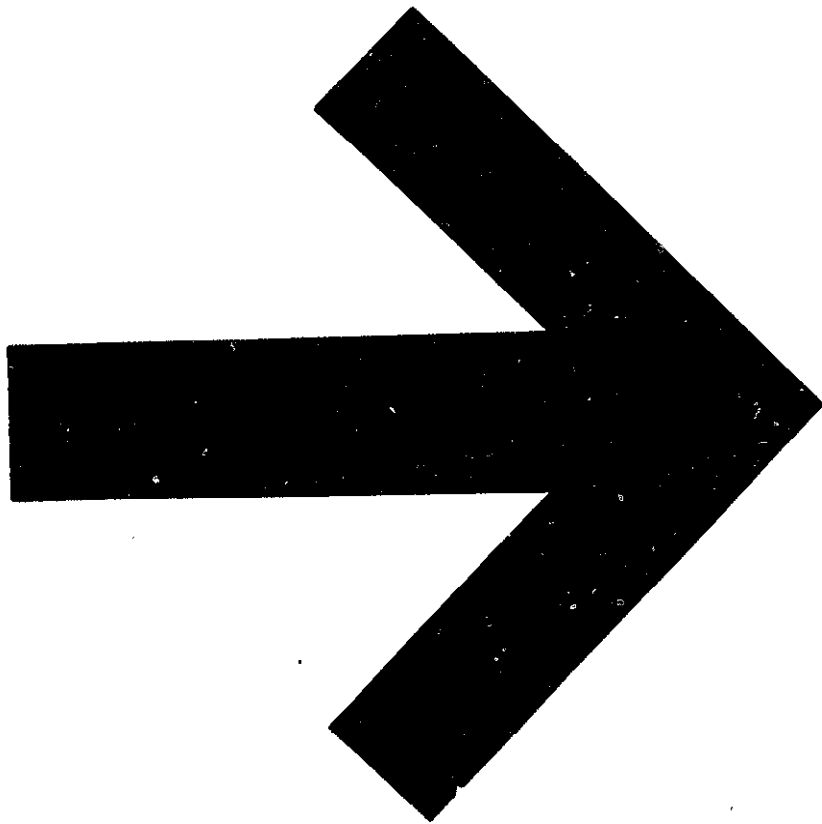

ACKNOWLEDGEMENTS

I am grateful to Mr Clewley of Newport for the loan of the Amies & Barford and E. H. Bentall's catalogues, to John Gall of the North of England Open Air Museum, Beamish, for the page from the William Elder catalogue and to the Librarian, North Devon Atheneum, for the engravings on page 6. The photographs on pages 22 and 51 are copyright of the University of Reading, Museum of English Rural Life.

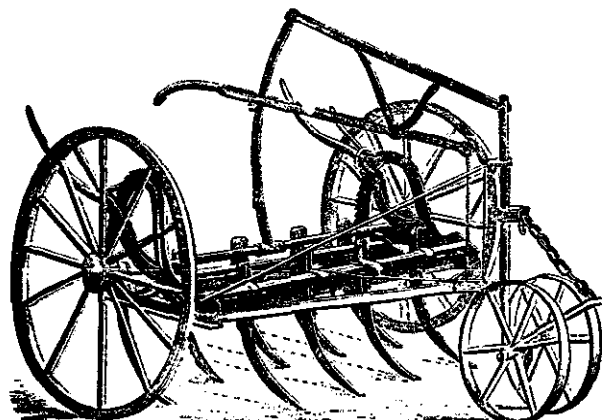

Biddle's Scarifier, as made by Ransome & Co.

(See also pages 21 and 30 for further engravings of this implement)

CONTENTS

Notes on the Material	6
Cultivator. (E. H. Knight, 1875)	7
Horse Hoe. (J.M. Wilson, 1847)	9
Grubber. (J.M. Wilson, 1847)	15
The Hoe. (J.C. Morton, 1855)	23
Cultivators, Grubbers or Scarifiers (J.C. Morton, 1855)	29
Grubber. (Henry Stevens, 1855)	40
Steerage Horse Hoe (Henry Stevens, 1855)	42
Scufflers and Horse Hoes (Henry Stevens, 1855)	44
Cultivators. (W.J. Malden, 1909)	47
Harrows. (J.C. Loudon, 1815)	52
Harrow. (J.M. Wilson, 1847)	53
The Harrow (J.C. Morton, 1855)	61
Sowing of Spring Wheat – The Harrow (Stevens, 1855)	68
Harrow. (W.J. Malden, 1909)	71
Roller. (J.M. Wilson, 1847)	74
On the Rolling of Land (Henry Stevens, 1855)	81

NOTES ON THE MATERIAL

In this volume I have grouped together implements of tillage except for the plough, so that it includes the devices for cleaning, breaking down and consolidating the soil, as well as those for cultivating the soil between growing crops. The classification of some of these implements may seem rather confusing; this is because many of them were introduced in the 18th and 19th centuries to 'fill the gaps' between work performed by the traditional implements of tillage, the plough, harrow and hoe, and thus there is some overlapping of functions. With the grubbers, scarifiers, cultivators, scufflers, horse-hoes, drags etc., I suppose the only distinction of real significance to the user was whether or not the implement could be used for tillage between the rows of standing crops.

The development from a few types of simple wood framed implements, to the diverse types of all iron or steel tools took place at a great pace in the first half of the 19th Century. The British inventors seem to have led the field, at least on the evidence seen in the extract from the American publication of 1875, reproduced on pages 7 and 8. The material in this book spans that period of innovation. The main advance in design of cultivators during the second half of the 18th Century was the introduction of lighter, spring tined implements, in place of the heavy rigid older types.

The origin of the extracts is noted in each heading. Further details and comments on these sources are given in the introduction to the first book in this set of four, "Ploughs". Most of the extracts are from the standard agricultural encyclopaedias, and although the text may look dry and dusty it is actually very clear and quite readable. Some of the engravings are of remarkable quality especially those in Morton's book.

Further information on books, locations where implements can be seen, and some advice for modelmakers is given in Books I and II of this set.

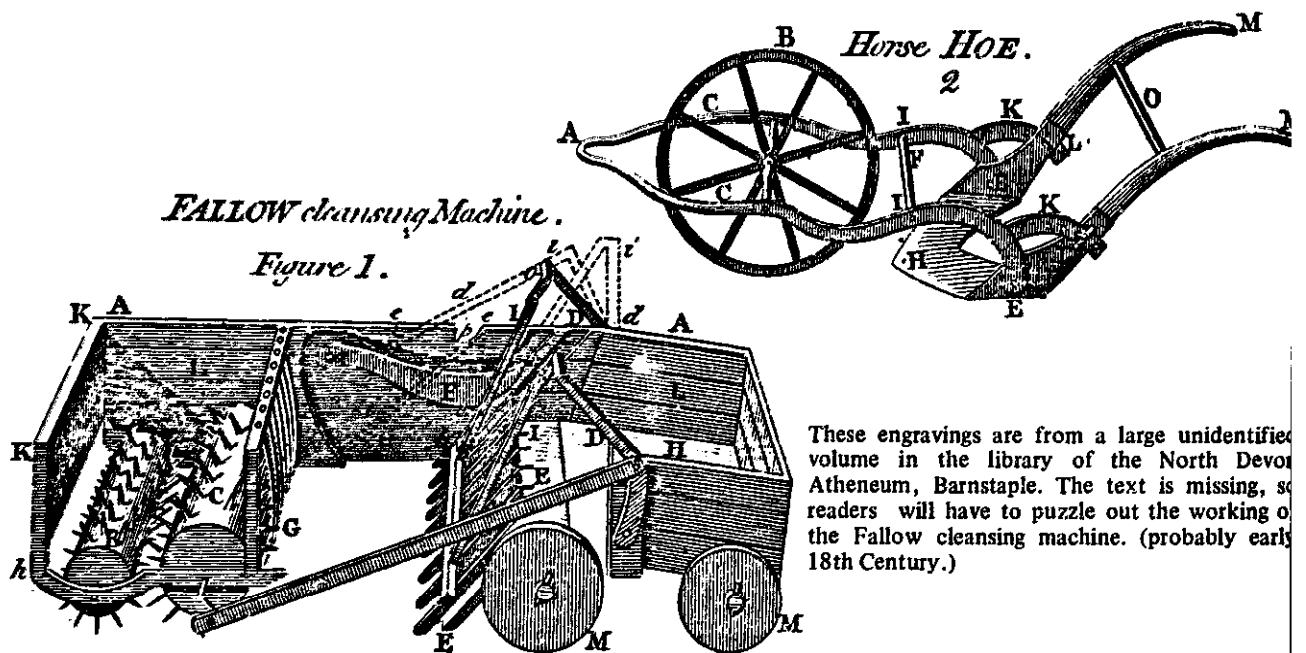

These engravings are from a large unidentified volume in the library of the North Devon Athenaeum, Barnstaple. The text is missing, so readers will have to puzzle out the working of the Fallow cleansing machine. (probably early 18th Century.)

CULTIVATOR

From 'The Practical Dictionary of Mechanics', by Edward H. Knight.
(Published in Boston, U.S.A., 1875)

(It is interesting to see that British implements feature prominently in this article. In contrast the articles on "Mowers" and "Reapers" from the same book are dominated by machines made in the U.S.A.)

Cul'ti-va'tor. This term, in a broad signification, includes harrows, drags, grubbers, scarifiers,

Fig. 1544.

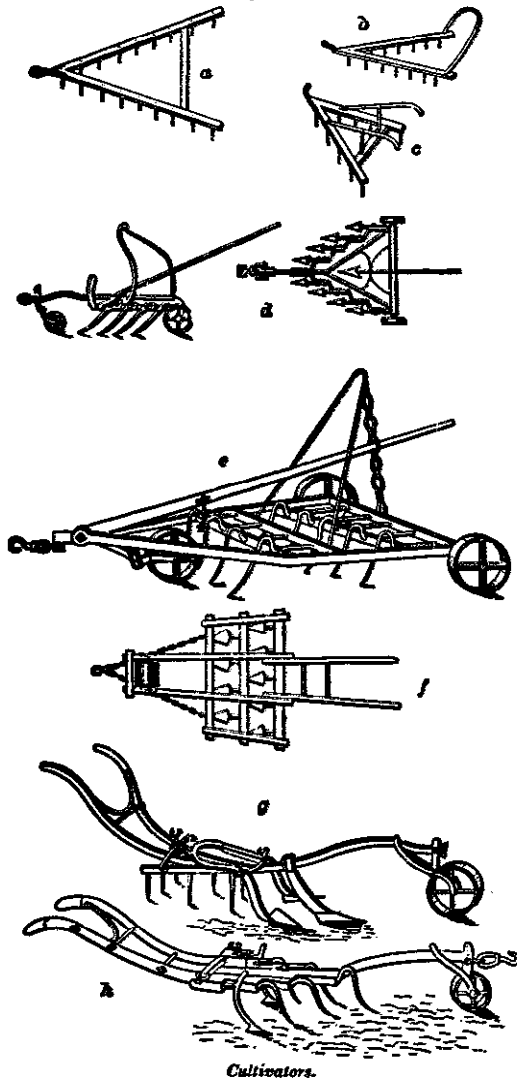

Cultivators.

scufflers, pulverizers, spiked harrows and rollers, horse-hoes, shovel-plows, and some other implements. The essential idea of cultivation is of course broader still, as it comprehends all the means of tillage, which would include plows, the dominant implement in the art of husbandry.

The term *cultivator*, in the United States, embraces implements which are used in tending growing crops. These are:—

1. The implement specifically known as a *cultivator*, having a triangular frame set with teeth or

shares, and drawn by one horse, which walks in the balk between the rows of corn, potatoes, or other plants. The animal is hitched to the apex of the frame, and the implement is guided by a pair of handles at the rear.

2. *Single and double shovel-plows*, which are used for precisely the same purpose, but are known as plows. See SHOVEL-PLOW.

The cultivator is an improved harrow.

The course of improvement is not difficult for a farming mechanic to imagine.

The ordinary harrow, we may say, is dependent for its course solely upon the direction of draft.

A good harrow, especially for new ground and in fields where there are occasional obstructions, is that of an **A** form (*a*, Fig. 1544). The rear corners may be readily raised by a hooked stick, so as to allow it to pass a stump without swerving the team. Better still is a bow of hickory, as in the next figure (*b*); by this it may be lifted one side at once, or, by swinging back on it, the whole harrow is lifted, to clear it of accumulated weeds, etc. This harrow is for regular service in putting in crops.

A smaller size, with a bow handle, is made to go between two rows of corn, potatoes, beans, etc., the handle affording the means of swaying it towards or from the row, to suit any irregularity in the line of plants, and also to keep it to its duty; if the horse swerves from the exact path.

Another mode of affixing handles is shown in the next figure (*c*), and this brings the subject to such close relationship to the cultivator as to render it unnecessary to trace the steps farther.

In connection with the subject we must not forget the author of "Horse-hoeing Husbandry." Jethro Tull introduced his system of drilling crops in 1701, with the object of cultivating the plants by machinery. He published his book 1731. His system rendered the cultivator possible.

The English cultivators and horse-hoes may be classed together, as no line of demarcation exists between them. The horse-hoes are designed to tend *drilled* crops, the prongs or shares passing along the balks between the rows of plants,—wheat, barley, oats, rye, turnips, beans, etc. This renders it necessary that the shares should have the same gage of width as the drills; but this is all that is peculiar about them, and is a question of proportion, not principle.

The tendency in all economical farming on an extended scale is toward reducing manual labor. Cultivators and shovel-plows have to a great extent superseded the hoe in corn-culture, and the English *horse-hoe* is designed to do the same in the culture of smaller drilled grain. A man can kill more weeds in a day with a double-shovel plow or cultivator than he can in a week with a hoe, *ceteris paribus*.

Wilkie, of Teddington, Scotland, is the inventor of the cultivator. He invented the plurality of shares, the expanding frame, and the caster-wheel. His cultivator (shown at *d*, Fig. 1544) has a frame of triangular form. The apex is supported on a caster-wheel, and the rear of the frame upon a pair of wheels. The share-frame is so suspended from the traction-frame as by a parallel movement to be raised bodily, or lowered, by means of a single lever raised bodily, or lowered, by means of a single lever projecting at the rear. The lever catches in notches in the segment-bar, so as to maintain the desired adjustment.

The teeth are curved prongs which enter the soil obliquely and raise weeds to the surface; the trash passes up the incline, and falls over the rear ends of the teeth, which are thus self-cleaning.

Finlayson's cultivator *c* (British, 1826) is made of iron, and the prongs are arranged on parallel,

Fig. 1545.

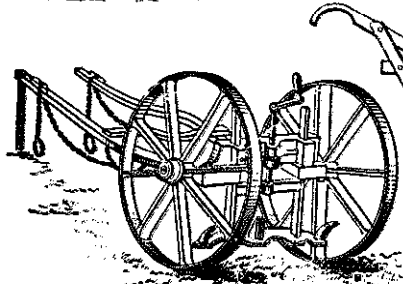
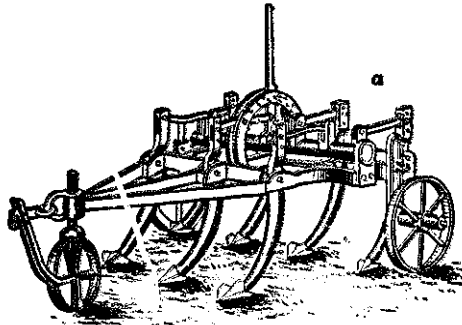

English Cultivators.

transverse bars of the frame, which is supported on a caster-wheel in front and two wheels at the rear. The depth of tilth is regulated by a lever, which is connected to the carriage of the caster-wheel so as to raise the apex of the frame when the lever is depressed, and conversely. The regulation for depth at the rear end is by set screws. The prongs are self-cleaning, having the arched form of Wilkie's; the rear set split the balks left by those preceding.

Finlayson's cultivator is shown at *f*.

Wilkie's horse-hoe and drill-harrow *g* (Scotland, 1820) has a central fixed share and adjustable side shares, which are expanded or contracted according to the state of the crop or the width of the balk. Following the shares is a frame with harrow-teeth. Either the share or the harrow-teeth may be removed, and the remainder used separately. The depth is adjusted by the caster-wheel in front.

h shows another form, somewhat modified.

In Fig. 1545, *a* is Colman's cultivator, and that below it is known as a skim-cultivator, with a long,

Fig. 1546.

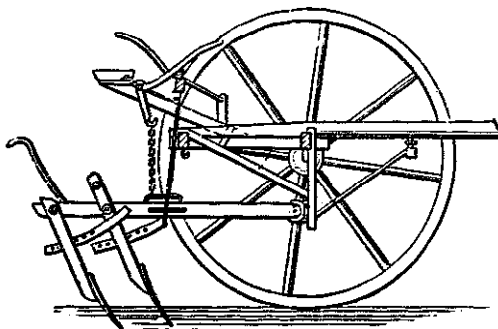

Cultivator

curved, flat share, whose depth is regulated by a crank and screw.

Fig. 1546 shows one American form of cultivator, in which the plows are managed by levers in driving and riding, and by the handles when walking behind the machine. The plow-beams are gimbal-jointed to standards depending from the axle, and have vertical and lateral movement by two hand-levers.

Fig. 1547 shows a form in which the plow-frames are attached by an arched yoke, which permits in-

Fig. 1547.

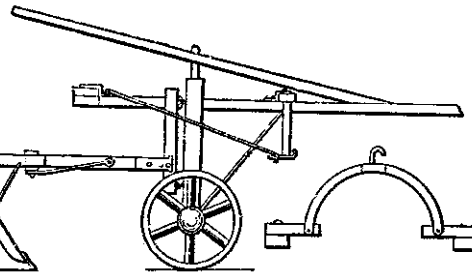

Cultivator.

dependent motion. Their clevises embrace posts shackled to the carriage.

M^r AMOS'S Couch Grass Drag.

Section through the line *x.y.* Fig. 7.

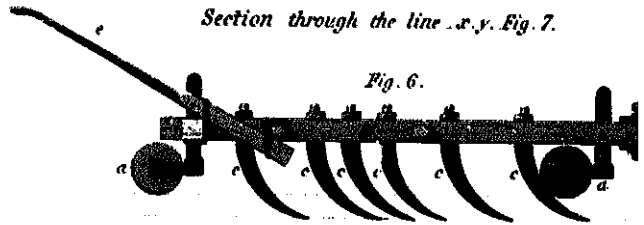

Fig. 6.

Scale of Feet.

Fig. 8.



PLAN

Fig. 7.

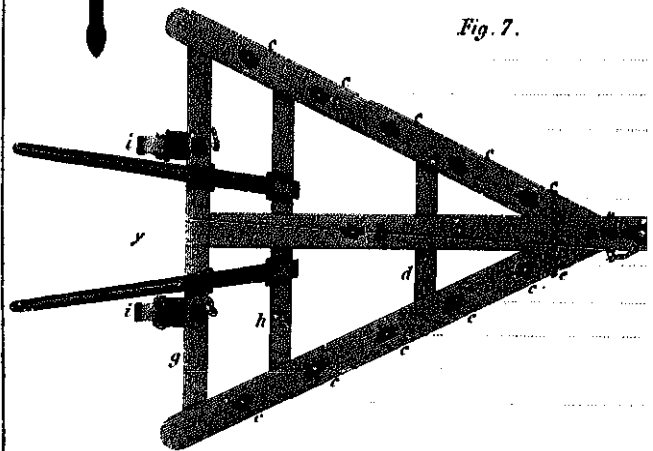

INSET - Compare this implement shown in Loudon's 'An Encyclopaedia of Agriculture' (1825), with the American cultivator, Fig 1544(c), on the previous page.

HORSE-HOE

from

"The Rural Cyclopaedia"
J.M. Wilson, 1847

HORSE-HOE. A horse-drawn implement for stirring the soil and destroying the weeds in the intervals of the drills of growing field-crops. It was first invented by the celebrated Jethro Tull; and, in consequence of its being the characteristic tillage implement of all the after-culture of drilled crops, it long gave the name of horse-hoeing husbandry to the system which Tull introduced of raising field-crops in drills. See the article **DRILL-HUSBANDRY**. The modes and uses of hoeing, whether with the hand-hoe or the horse-hoe, are noticed in the article **HOE**; and the principal advantages of the horse-hoe over the hand-hoe, are rapidity of performance and economy of labour. "Expedition," remarks Blaikie, "is a most material point in all processes of husbandry, carried on in a variable and uncertain climate; and it frequently happens, that hoeing in any way can only be executed to advantage in a very few days in spring. Hence, the horse-hoe has a most decided advantage over the hand-hoe; for a man will only hoe about half an acre a-day with the latter, while, with the former, a man and a boy, with one horse, will hoe 8 or 10 acres a-day, and that in a more effectual manner."

The original horse-hoe, or that invented by Tull himself, was a rude implement, and resembled a roughly-shaped swing-plough, wanting the mould-board, and with the cutting-edge of the share turned up on its land-side. Subsequent horse-hoes, though less rude and sometimes displaying considerable ingenuity, continued to be very simple; and possessed some resemblance, either to a swing-plough without the mould-board, or to the scuffer, the scarifier, or the old, simple, and diminutive varieties of the grubber. Modern horse-hoes are exceedingly diversified in both structure and adaptation; they range between great simplicity and very considerable complexity; they vary widely from one another, both in the facilities with which they are worked, and the precise soils, crops, and conditions for which they are most suitable; and even such as possess a sameness of both general structure and special adaptation are considerably diversified by

the caprice or the conflicting judgments of different manufacturers. Their comparative merits, as regards mere construction, will best appear from a separate description of each and a successive view of all; and their comparative value, as regards the circumstances in which they are to be used, is altogether relative, and depends, in a main degree, on the character of soil to be hoed, and on the best method of hoeing it. "Soils of different textures require to be hoed with shares of different forms, according to their hardness, or mixture of stones, flints or gravel. The number of hoes also in hard soils requires to be diminished; in the case of a strong clay, one hoe or flat share, with or without one or two coulters or prongs, will often be all that can be made to enter the ground. In using these implements, the operator should always consider whether he will produce most benefit by merely cutting over or rooting up the weeds, or by stirring the soil; because the hoe suited for the one purpose is by no means well adapted for the other. In the former case flat shares are to be preferred, but pointed, that they may enter the soil easily; in the latter, coulters or prongs, as in the cultivators, are much more effective, as they will enter the soil and stir it to a considerable depth, thus greatly benefiting the plants by the admission of air, heat, dews, and rains, and by rendering it more permeable by the roots."—[Loudon's Encyclopaedia of Agriculture.]

Wilkie's horse-hoe and drill-harrow, or Wilkie's drill-grubber with appended harrow, is a very efficient implement both for cleaning and pulverizing the intervals of the drills as soon as the plants appear above ground, and for performing all the subsequent hoeing operations of ordinary after-culture. It was invented by the elder Wilkie of Uddingstone, and brought to quite or very nearly the state in which it is still made, between the years 1818 and 1821. It has somewhat the form of a plough; and consists of a beam, three coulters attached to the body and wings of the beam, a small wheel at the point of the beam, directing handles like those of a plough, and a harrow behind the coulters and below the anterior middle parts of the handles. The wheel at the point of the beam regulates the depth of the implement's action, serves as a fulcrum when the implement is raised to free the coulters from an accumulation of weeds, and facilitates the turning of the implement at the ends of the ridges. The foremost coulter has a double-feathered sole, passes up through a hole in the beam, and admits of being raised or lowered so as to be adapted to the precise depth of action required in the centre of the drill; the other two shares have single-feathered soles, and are attached on a line with each other to the wings of the beam or lower part of the handles, and are prolonged and hinge-jointed at top so as to be capable of expansion and contraction; and while the foremost coulter cuts the weeds and stirs the soil in the centre of

the interval between two drills, the other two coulters, acting horizontally as well as vertically, pare the soil from the sides and bottom. The harrow consists of two bars, each armed with three very long harrow-tines, and is capable both of depression and of expansion; and it serves as a very useful auxiliary to the action of the coulters, by displacing the weeds, bringing the weed-roots to the surface, and thoroughly stirring and pulverizing the soil. A representation of this implement is shown in *Fig. 1, Plate XXVIII.*

Wilkie's horse-hoe with parallel motion is an invention of the younger Wilkie of Uddingstone; it differs from the preceding, partly in wanting the harrow, but principally in the manner in which the two side-coulters are adjusted; and it possesses, in an eminent degree, the capacity of easy and efficient contraction or expansion of its side-coulters, to suit the different widths of drills. A representation of it is given in *Fig. 3, Plate XXVIII.* The horizontal arms of its side-coulters behind their chief curvature are strongly jointed to the extremities of two cross-bars, which have their centres of motion in the beam; and in consequence of the arms and the cross-bars forming a parallelogram, the coulters, at whatever distance they may be set, constantly preserve a position equidistant from and parallel to each other, each uniformly advancing in the exact proportion in which the other recedes. The coulters, therefore, never suffer the inconvenience and comparative inefficiency, incident to those of many varieties of horse-hoe, of being thrown out of parallelism; and, being always at the greatest possible distance from each other, they also prevent, in the greatest practicable degree, a choking accumulation of weeds when the implement is working in narrow intervals.

The horse-hoe and double mould-board plough is an implement with a skeleton equally suitable for a proper horse-hoe and a proper double mould-board plough, and with such adjustments of the apparatus peculiar to each as to admit of that of the one being at any time easily substituted by that of the other. Both the horse-hoe of the elder Wilkie and the horse-hoe of the younger Wilkie, as originally made by their inventors, can be converted into double mould-board ploughs, for earthing up the soil on drills of turnips, potatoes, or other similarly growing crops, simply by the removal of the coulters of the latter, or of the coulters and harrow of the former, and by the affixation, in their stead, of a drill-body with mould-boards. The common double mould-board swing-plough, on the other hand, is often so constructed as to be convertible into a scuffing or cleaning plough, or virtually a quite efficient horse-hoe for any tolerably clean land, simply by withdrawing the hinge-pins of the mould-boards. It is usually made with a cast-iron body, and has its beam placed in the plane which bisects the angle of the handles; its

mould-boards are jointed at the fore-part to the head, so as to be capable of expansion and contraction behind; it has a double-feathered share and two kneed coulters or scufflers set in jointed bars, which are adapted for variable widths; and it has no wheel. See the article *Plough.*

Finlayson's self-cleaning horse-hoe and drill-harrow may be conceived to bear nearly the same relation to both the horse-hoe of the elder Wilkie and that of the younger Wilkie, which Finlayson's patent harrow bears to Wilkie's grubber. See the article *Grubber.* It has a much more facile and efficient action on many kinds of soil than the Wilkie horse-hoes, and operates much more in the manner of a harrow than that of the younger Wilkie. Its tines are eight in number, fixed in a narrow skeleton frame, and all self-cleaning; and six are swannecked and prong-pointed, while the two hindmost ones are curved and feather-soled. A beam projects from the front of the frame, and terminates in a fulcrum-wheel and the draught-attachment; and a pair of guiding-handles, exactly like those of a common plough, project from the rear of the frame.

Weir's expanding horse-hoe is somewhat similar in structure to the Wilkie horse-hoes; and is so made as to do the work either of a proper horse-hoe or of a double mould-board plough. It has circular coulters, hoe-tines, and a double mould-board; and when used as a horse-hoe, its curved coulters are adjusted into the expanding bar in adaptation to the width of the intervals to be hoed; and when used as a plough for earthing up potatoes or turnips, it is mounted with the mould-boards and a suitable coulters.

The common Scotch horse-hoe is a plough-grubber, carrying five coulters, and having the fore-part of its beam supported on a wheel, which regulates the depth of the coulters' action; and four of its coulters are set, two and two, in jointed bars, which contract and expand to suit the width of the interval between the drills. But another form of the common Scotch hoe has only three coulters, and is so constructed that, when required to work any hard soil, one or more of its ordinary coulters can be substituted by bent prongs.

Henry's improved scarifier is closely allied, at once in form, in action, and in uses, to a light grubber; and may be regarded as intermediate in character between a small form of the old scarifier and the Wilkie or Finlayson varieties of the modern horse-hoe. It has a triangular outline, and is mounted on three small wheels; its tines are nine in number, and have small duck-footed soles,—and are adjusted in two linear series,—four upon the front cross-bar and five upon the hind cross-bar; and its guiding handles are light, and project from the middle part of the frame.

Gorrie's drill-grubber or horse-hoe, was invented, in 1840, by Mr. Gorrie of Annat-Gar-

den in Perthshire. It carries a scuffer in front, equal in length to the width of the intervals between the drills, and so disposed as to undercut all weeds; it has, behind the scuffer, such tines or coulter as throw the weeds at once to the surface; and it is furnished with a wheel under the beam, for the purpose of regulating the depth of the action.

Morton's horse-hoe was invented about 20 years ago by Mr. Morton of Edinburgh. It consists of directing handles somewhat similar to those of a plough,—two beams, which extend in continuation of the handles, and finally curve to a junction, and send off a projecting bar,—two tines upon the lower extremity of the handles, eight upon the two beams, and two upon the projecting bar,—and two cross-bars, adjusted transversely between the beams. The foremost tine upon the projecting bar is a cutting coulter; the hinder tine upon the projecting bar is a triangular-soled share; the eight tines upon the beams are straight, pointed teeth; and the two tines upon the lower extremity of the handles are triangular-soled shares. An apparatus exists within the construction to set the tines at any width which the distance between the drills may require; and the relative position and aggregate expanse of the soles of the three triangular-soled shares are such as to cut all weed-roots athwart the whole interval between the drills.

The Hawick horse-hoe is similar, in general structure, to Morton's horse-hoe; but is less elaborate in the combination of its parts, and has a smaller number and different form of tines. One triangular-soled share in front cuts all the weed-roots in the middle parts of the interval between the drills; and six curved-footed coulter, adjusted on the beams, cut all the weed-roots along the side-parts which escaped the action of the share. A joint at the fore-extremity of the right beam, and a simple contrivance in the transverse bar between the hind-extremity of the two beams, serve the purpose of expanding or contracting the implement to suit different widths of interval between drills.

Brodie's horse-hoe is of similar date to Morton's horse-hoe, and takes its name from Mr. Brodie of Templebar in the vicinity of Peebles, and is specially adapted to the prevailing character of soils in any very stony district. It consists of directing handles, like those of a plough,—a middle beam, formed by the convergence of the handles, and extending thence to the fore-extremity of the implement,—two side-beams, connected at their hinder end by a transverse bar, converging to a junction at their fore-end with the middle-beam, and combining with the transverse bar to give the body of the implement a triangular outline,—one straight and pointed tine on the fore-extremity of the middle beam,—four straight and pointed tines, and a fifth and inwardly curved-footed tine, on each of the side beams,—two short rods projecting from the transverse

bar immediately below the handles, and each furnished at its extremity with a straight and pointed tine,—and an apparatus for expanding or contracting the body of the implement in adaptation to the width of intervals between drills. The nine straight tines in front stir and pulverize the soil of the greater part of the interval; the two inwardly curved-footed tines almost meet each other at the points, and cut up any root-weeds which escape the action of the other tines; and the two tines upon the backward-projecting rods spread or level the soil after it has been acted on by the curved-footed tines.

The Northumberland horse-hoe is of simple construction, and triangular form; it contains either six tines or three coulter and three tines, according to the state of the soil; and, when used for hoeing between rows of turnips, its two side coulter have a curved form. This implement is frequently used instead of a grubber in pulverizing land for barley in spring, and in tilling bean-stubbles in preparation for wheat in autumn; and a diminutive variety of it is sometimes attached to a small roller, and used for hoeing the intervals between drills of barley and wheat.

Blaikie's inverted horse-hoe was introduced by the author of the well-known Treatise on Farm-Yard Manure; and was the earliest efficient implement of its class for hoeing simultaneously the intervals between several drills of turnips; and possesses both singularity and simplicity of construction. Its tines are stalks or vertical bars, each terminating on one of its sides, in a small steel blade; they are fixed, at regular distances, into two parallel beams or bars of iron, the one of which is placed in advance of the other; those in the one bar have all their blades pointing to the right, while those in the other bar have all theirs pointing to the left; and the whole are so adjusted that, when the implement is in motion, the backs of each pair of stalks pass close to the plants in the drills, and the steel blades point to each other, and traverse all the soil of the interval between the stalks, and completely cut and till it without turning any of it upon the plants, or doing any injury to their roots. This implement is well-adapted for hoeing narrow intervals; and may, with both safety and efficiency, be employed either for drilled corn or for young turnips.

Lord Ducie's parallel expanding horse-hoe is constructed for hoeing drill crops, and at the same time is convertible into a light grubber by the simple means of taking out its hoeing-tines, and inserting a set of grubbing-tines with which it is accompanied. Its main part consists principally of a five-beamed or five-barred frame, and five strong, heavy, forward-curved, double-feathered shares,—mostly of cast-iron, but the cutting edges of the shares of hardened steel; and its other parts are handles to hold and steady it with, a tiller in front for the attachment of the

draught, and a small wheel in front for regulating the depth of the action. It is sometimes made with only three tines instead of five; and it can be very facily adjusted to any width from 12 to 27 inches, simply by moving the small pin into different holes made for the purpose in the side of the main-beam; and in consequence of the supports of the tines always moving parallelly with the beam, the share of each tine always presents its edge in a straight line to what it has to cut.

Grant's horse-hoes display considerable ingenuity, and possess much adaptation and efficiency. Grant's common horse-hoe is made entirely of wrought iron; and consists of guiding handles, a beam, a frame, angular-footed shares, a front wheel, and a hind wheel. "Mortices are made through the beam to receive two iron bars, upon which the frames supporting the shares may be adjusted to cut any given width, or at any desired interval; and by substituting mould-boards in the place of the wrought-iron frame for the shares, the implement is converted into a moulding plough." Grant's improved lever horse-hoe has a series of tines so adjusted on a frame, and each one of the series so commanded by a separate lever-power, that, by means of a compound lever, similar to that of Grant's patent-lever horse-rake, all the shares can be simultaneously elevated and instantly freed from an accumulation of weeds or rubbish. See the article HAY-RAKE.

Howard's horse-hoe is a very simple but effective implement for the after-culture of turnips and drilled pulse. It has two rows of tines, with wheels working at an equal distance from each row; and it in consequence has a steady movement, and maintains a uniform depth. Its tines are very narrow, and in the form of spuds, and leave the soil in a much finer state than if broader tines were used; and their stalks are placed in an oblique position so as to allow the weeds to slide freely up, and to prevent accumulations of soil and rubbish from falling over upon the young plants. The tines and wheels contract or expand on the frame so as to suit different widths of intervals.

Amos's expanding horse-hoe and harrow is a much inferior implement to several of those which we have noticed; yet is said to be extensively used in Lincolnshire. It has a beam and a front wheel; its shares are expanding, and can be adjusted to any width of interval between drills, from 12 to 30 inches; and its harrow, not only serves as an useful appendage in the proper work of drill-hoeing, but possesses a sufficiency of action in cleaning land from successive gatherings of weeds, and in bringing soil into a state of reduced pulverulence and tilth, to adapt the implement, in a considerable degree, to the purposes of a grubber in the process of fallowing.

Clarke's universal ridge horse-hoe was invented by John Clarke of Long Sutton; and received

the silver medal at the first meeting of the English Agricultural Society; and possesses ingenious adaptations for the purposes severally of a horse-hoe, a double tom, a moulding-plough, and a broad-share or cleaning plough, so as to perform all the various operations of ridge culture. A pointed, broad-soled share attached to the frame, completely hoes the furrow or central part of the interval between two drills; a moveable jointed frame, which can readily be adjusted to any desired width, is affixed to the beam, to receive the side-tines for hoeing; and two curved-footed tines are fastened into this when the implement is required to hoe plants upon the ridge,—and two flat-footed tines, when it is required to perform flat work. A small wheel, upon a vertical stem, poises the front of the beam, and regulates the depth of the action.

White's double-action turnip-hoe and Huckvale's patent turnip-hoe perform the after-culture of turnips, whether sown broadcast, in the drill, or on the ridge. "In addition to the hoes intended to pass in the direction of the ridge or furrow, or between the rows of the plants, White's implement is furnished with an apparatus which, by means of a crank put in motion by the fore-wheels, two hoes are made to traverse the rows, and thus to cut out the plants when it is desired to thin them on the row. It admits of adjustment to suit rows of any distance, from 15 to 30 inches wide; and the cross-hoes may be made to operate so as to leave the plants on the rows at distances of either 9, 12, or 15 inches apart. It may be used with one man and one horse; and by the substitution of spear-footed tines in the place of the hoes, it becomes an efficient light scarifier. Huckvale's patent turnip-hoe is intended to accomplish a similar operation to White's implement; but the hoes for cutting out the turnips on the rows, are, by a simple arrangement of two cogged wheels, made to revolve in the direction across the ridge, while the body of the implement, containing the hoes for cleaning between the rows, is drawn forward by a horse." [Ransome's Implements of Agriculture.]

Wilson's drill-grubber or horse-hoe was invented by Mr. James Wilson of Traprain in East Lothian, and is intended for cleaning the ground between the rows of drilled corn-crops. Its outer frame consists of timber, and is a variable parallelogram, and measures over all about $4\frac{1}{2}$ feet in breadth and $3\frac{1}{2}$ feet in length, and is supported in front on two wheels of about 20 inches in height, whose axles are bolted to the lower side of the front-bar. The hind-bar has affixed to its middle part a pair of directing handles, for the guiding of the implement, and so formed as to suit the height of the workman; the front-bar has affixed to it the draught-attachment; and the two side-bars are attached to the hind-bar by a mortice-joint and loose tenon, admitting of motion in a horizontal direction,—and to the

Wilkes' horse hoe and drill barrow

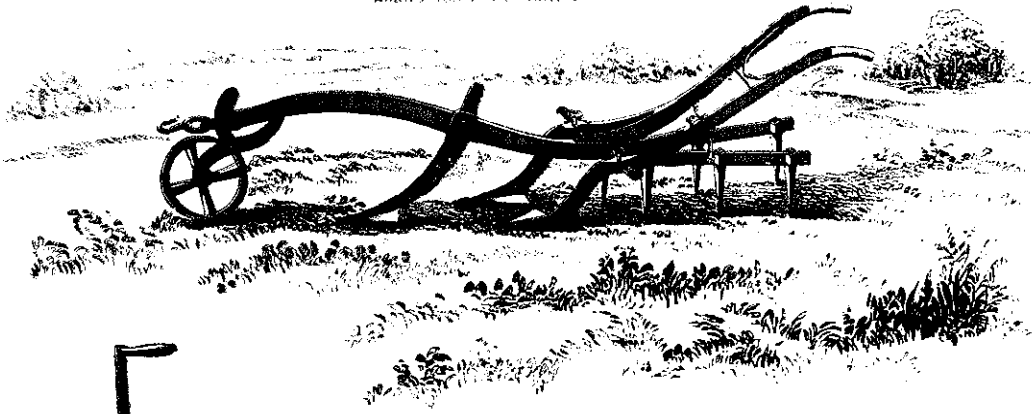

Smith's Patent horse hoe

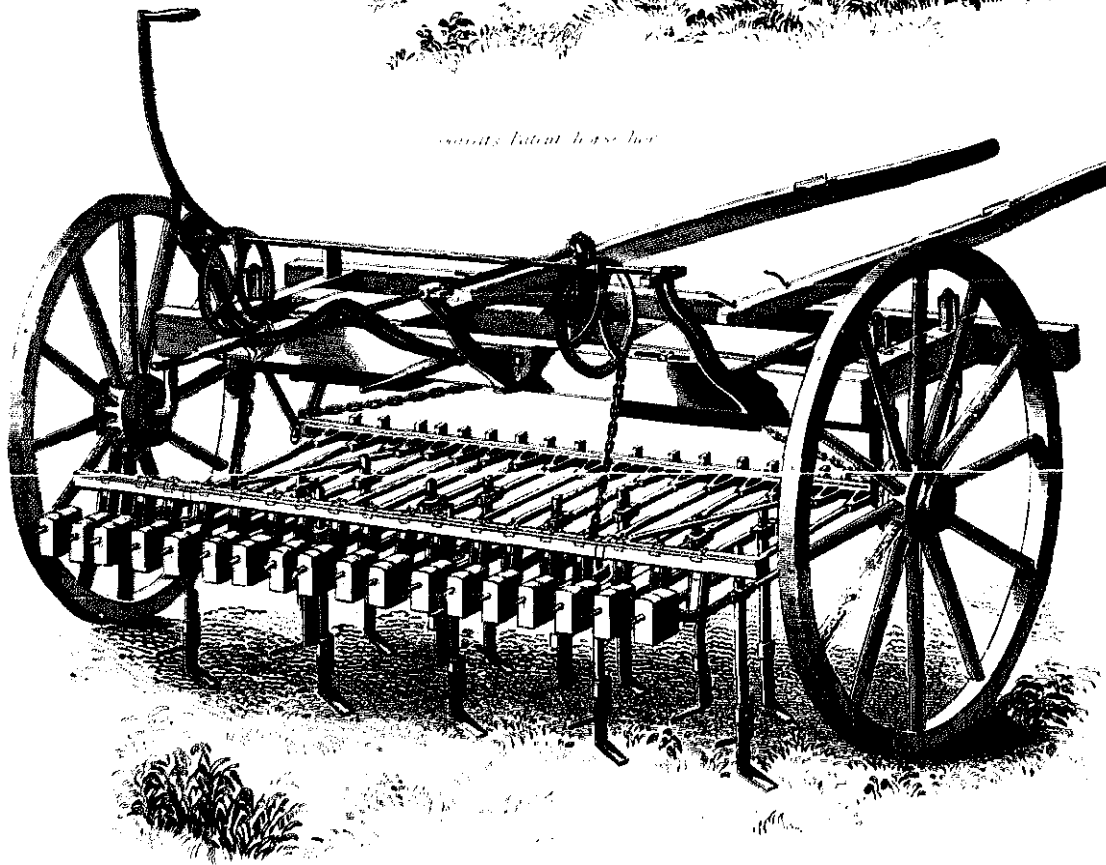

Wilkes' horse hoe with parallel motion

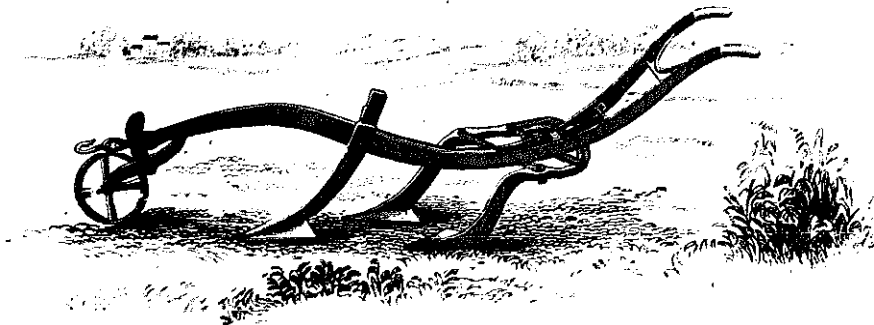

front-bar by a hook-and-eye joint, allowing a considerable freedom of motion in every direction. Five bars for sustaining the coulter extend from the hind-bar to the front bar; they are connected with the front-bar, each by means of a bolt which is immovable in the coulter-bar, but slides up and down the hole pierced for it through the hind-bar, so as to allow the hind end of the coulter-bar to rise and fall; and they are attached to the front-bar each by a species of double hinge, which has one joint moving vertically and the other horizontally, so as to combine with the mobility of the side-bars to give a certain degree of universal motion; and a slight spring is attached to each of the coulter-bars, and adjusted to act against the lower side of the hind-bar, so as to keep the coulter at the greatest depression. The coulters are pointed and broad-footed shares, and are fitted to mortices in the coulter-bars at points about one-third of the total length of these bars from the hind-bar, and are fixed by wedges at the required height. A wheel of about 6 inches in diameter is attached by a vertical stem to each coulter-bar between the coulter and the front-bar, and serves to regulate the depth of the coulter's action. "From the form and description of the machine," says the Report of it in the Highland Society's Transactions, "it is easy to see that it must be made to dress either the same, or half, or any other aliquot part, of the original number of rows performed with the sowing-machine, by which the crop has been sown; and the intervals must be the same in both. The utility of the universal motion in the coulter-bars and frame will also be apparent; the horizontal motion of the whole allowing the director to follow any sinuosity that may have occurred in the operation of sowing, where all the rows sown at one time must be parallel, though they may not be in perfectly straight lines. The vertical motion of the coulter-bars, at the same time, allows any individual bar to rise when its coulter happens to meet with any obstacle, and so to pass over it without affecting the position of the others."

Garrett's patent horse-hoe was invented by Garrett & Son of Leiston; and it received prizes at the English Agricultural Society's meetings at Liverpool in 1841, and at Bristol in 1842, and the honorary medal at Derby in 1843, also East Norfolk in 1842, and West Norfolk in 1843. A representation of it is given in *Fig. 2, Plate XXVIII*. "This implement," says the report of it in the Journal of the Royal Agricultural Society of England, and in the Annual Register of Agricultural Implements, "is so complete in itself as to be fully suited to all methods of drill-cultivation, whether broad, stetch or ridge ploughing; and is adapted to hoeing corn of all sorts, as well as roots. The peculiar advantages of this implement are as follow:—It may be increased or diminished in size to suit all lands or methods of planting; the axle-tree being moveable at both

ends, either wheels may be expanded or contracted, so as always to be kept between the rows of the plants. The shafts are readily altered and put to any part of the frame, so that the horses may either walk in the furrow, or in any direction to avoid injury to the crop. Each hoe works on a lever independent of the others, so that no part of the surface to be cut, however uneven, can escape; and in order to accommodate this implement for the consolidated earth of the wheat crop, and also the more loosened top of spring corn, roots, &c., the hoes are pressed in by different weights being hung upon each lever, and adjusted by keys or chains to prevent them going beyond the proper depth. What has hitherto been an insuperable objection to the general use of the horse-hoe, is over-ruled in this by the novel and easy method of steering, so that the hoes may be guided to the greatest nicety, if common caution be used, doing every execution among the weeds, without injury to the crop. This implement is so constructed that the hoes may be set to any width from 7 inches to any wider space. For the purpose of hoeing all kinds of corn, the inverted hoes only are preferred; but for the root crops, where the rows of plants are wider (say 16 inches or more), an extra hoe of a semicircular form is placed on a separate lever, working between and in advance of the two inverted hoes, for the more effectually cutting all the land, however uneven the surface, by the three separate hoes working independently of each other between the rows. The hoes are of peculiar improved manufacture, the blades being of steel, and made separate, and attached to a socket handle in a simple and easy yet effectual manner, so that any husbandman may replace them; and being manufactured by the patentees at an exceedingly low price, no difficulty can arise in replacing those parts subject to wear. In order to set the hoes in a proper cutting position for either flat or stetch ploughing, and so as thoroughly to cut either hard or soft ground, the levers are put into a more or less oblique position, causing the cutting edges of the hoes to be more or less inclining downwards, by raising or lowering the jointed irons to which the forward ends of the levers are suspended and swung, which is done by merely moving the pin which rests upon the frame into different holes."

GRUBBER

from

"The Rural Cyclopaedia"

J.M. Wilson, 1847

GRUBBER. An implement of tillage, of intermediate character between the harrow and the plough. It has been described as "in principle a member of the harrow tribe of implements," and as "approaching so closely the harrow in its character that it is not easy to draw the line of distinction;" but—at least in all its best forms and most recent varieties—it really differs as much from the harrow as from the plough, and must be considered, as, to both its structure and its mode of action, a perfectly distinct and exceedingly important agricultural implement.

Difference between the Harrow and the Grubber.—The harrow pulverizes ploughed soil, disengages from it and collects the roots and stems of weeds, and covers the seeds of cultivated plants. The rectangular harrow is attached to the draught at only one point, and has a shaking, shying, alternating, and sometimes tossing motion, and is in consequence well suited to break the clods of dry lumpy land, and to cover broadcast-sown seeds in almost any kind of soil; for, in the former case, its teeth being constantly flung from the direct line of draught, and constantly flinging themselves back to regain the equilibrium, strike the clods upon the surface, and either break them or tear out the roots and stems which bind them together; and in the latter case, its teeth, in continually swinging and oscillating from side to side, and in seldom or never having sufficient steadiness to penetrate far into the soil, perform exactly the kind of dispersed and superficial action which buries a maximum of seeds at a desirable average of depth. The rhomboidal harrow, on the other hand, is drawn equally by two horses walking abreast, and makes a close series of parallel and comparatively deep lines of indentation through the soil, and admits, when necessary, of a certain degree of lateral motion, simply by means of shortening the posterior swingle-tree and otherwise modifying the attachment of the draught; and it is, therefore, pecu-

liarily fitted, on most kinds of land, for pulverizing soils and disengaging weeds. See the article **HARROW.**

Every harrow, however, be its particular construction what it may, fails to bring up the roots of weeds from any considerable depth, to reduce cohesive and refractory land, to exert more than a comparatively shallow action, to perform such following operations as are intermediate between upturning and cleaning, to perform a hoeing process upon land too foul for the harrow and too pulverulent for the plough, and occasionally to act as an entire succedaneum for the plough in the tillage of clean, powdery, and very light soils which do not immediately require to be thoroughly upturned. "The teeth of the harrow, being forced into the ground solely by their own weight and that of the frame-work in which they are fixed, are not well calculated to penetrate into it, and are constantly thrown out by the obstacles they encounter. In firm clays or cloddy ground, therefore, the impression made by the teeth of the harrow is often seen to be extremely superficial. Were the teeth formed somewhat like the coulter of a plough, and curved like it forward, they would better insinuate themselves into the ground, and be less liable to be forced out of it when encountered by obstacles. But the harrow, from its nature, does not admit of this construction; for in this case the teeth would form an angle with the frame-work in which they are set. The weeds and rubbish disengaged from the ground would be collected at the angle, and would thus be carried along with the harrow and impede its progress; while this form of construction would add to the difficulty of freeing the teeth from the rubbish collected."

The grand object in the invention of the grubber, therefore, was to substitute coulter-like tines for the teeth of the harrow, and to mount these within some kind of frame-work which should possess similar capacities of draught and control to those of the plough; and this object has been fully accomplished. The grubber has a heavier frame than the harrow, is mounted on wheels in the manner of wheel-ploughs, and has shafts for guiding their action, and handles for lifting the tines out of the ground at the end of the ridges; and it admits of much variety of construction to suit different soils and purposes, and sufficient graduations or control of action to adapt itself to the degrees and emergencies of any one course of tillage.

Uses of the Grubber.—The grubber, though far from being so well known and commonly appreciated as its excellence demands, has for some little time been in pretty general use in some of the best cultivated districts. It is most eminently serviceable on the lighter kinds of soils; but, when preceded by one ploughing or at the utmost two ploughings, it makes good and profitable work on even stiff loams and adhesive clays. It acts more or less as a substitute for

the abundant use of the plough, and occasionally as a substitute for all use of it whatever; it prepares soils of all kinds for the most efficient action of the harrows; and it searches and tears the soil, intermediately between ploughing and harrowing, in such a manner as to produce a far higher degree of cleaning and pulverization, and at considerably less cost of time and labour, than could be effected by mere ploughing and harrowing. In any medium kind of land, in an averagely fair condition, one ploughing, one grubbing with half-set tines, one cross-grubbing with full-set tines, and a few finishing turns of the common harrow, usually constitute a very efficient tillage. A plough, too, turns over only 9 inches at each bout, while a grubber of the best construction tills a breadth of 4 feet 4 inches; one pair of horses, drawing the plough, till on an average about one acre of land in a day, while the same horses, drawing the grubber at the same pace, would till nearly six acres; any horses can move at a quicker rate with the best grubber than with the best plough,—so that a pair which could plough only one acre would grub considerably more than six acres; and land which is tilled with plough, grubber, and harrow, can, in many instances, be cleaned and sown much earlier than land of the same kind, and in the same situation, tilled only with the plough and the harrow.

The grubber is specially useful in assisting the operations of the summer-fallow. "When land is full of root-weeds, the repeated operations of the plough, the harrow, and the roller, are the methods resorted to for tilling and cleaving it; but very frequently, when the land is stiff, even the operation of ploughing itself tends to compress the furrow-slices, and if the influence of the sun be considerable, it will be formed into a hard mass, on which the subsequent operations of the harrow and the roller have little comparative influence. So much is this felt in many of the stiffer clays of England, that it is a very frequent practice to delay giving the first ploughing to the fallow land till the month of May, by which one of the great benefits of an efficient summer-fallow is lost. But, by means of a well constructed grubber, such land may be cleaned and tilled without the necessity of turning up a new surface. The instrument, too, can be made to go at any depth in the soil which may be required, and thus the land can either be stirred to the depth to which it had been originally ploughed, or to such depth as may be most suitable for the purpose intended, whether that purpose be to clean the land of root weeds, or to till the soil only a few inches deep.—Further, land which had been ridged up in autumn or winter, after having produced any of the leguminous crops, as pease or beans, may be prepared for the seed with advantage by using the grubber alone, and without the necessity of a repetition of the more costly operation of ploughing. In this manner, the seed is sown upon the surface-mould which had been pulverized

by the influence of the sun and frost. In the case, too, of land which had produced a crop of turnips or potatoes, the grubber may, in all cases, obviate the necessity of a second ploughing as a preparation for the seed; and may even, in many cases where the soil is light and dry, obviate the necessity of ploughing at all after the green crop has been removed or consumed."

History of the Grubber.—An implement of a medium character between a powerful and long-toothed harrow and a modern grubber, and called *urpax* or *irpex*, was in use among the ancient Romans; and is described by Varro as a plank with teeth for pulling roots out of the ground, and as drawn by oxen in the manner of a wain. Various implements, more or less like this ancient one, and exhibiting a desiderated but slow transition from the harrow to the grubber, appear to have been known to the best class of farmers at an early period of modern British agriculture. One of these, called an *edget*, was in use, in the eighth decad of last century, in the vicinity of North Berwick in East Lothian; and is described as follows in an early volume of the Highland Society's Transactions, "The tines were fixed, standing perpendicular,—the feet not dipping, but forming a right angle with the tines; the wheels were only two,—these stood in front of the machine, and, being moveable upwards and downwards, regulated the depth the tines were intended to work at." But while this rude implement remained unimproved in Scotland, and continued to be very little known there in even its unimproved state, the implements corresponding to it in England advanced, stage after stage, toward the form of grubbers, till they became the groundwork for a very superior class of implements in both divisions of the island.

The *scuffler*, derived from the Kentish *nidget*, was the first decided stage of improvement. This was originally a small, heavy, triangular, harrow, with tines longer than harrow-teeth, sharp, penetrating, and inclined forward, but without any plates at the bottom; and it afterwards was constructed with a number of triangular plates or feet, steeled on their edges, fixed at the bottom of tines in the form of iron bars, and looking, jointly with these tines, like the feet and legs of a duck. This implement both cut up weeds and pulverized the soil; and may even yet be usefully employed on light lands which are free from stones and have a plain surface. "Scuffling strong land, and exposing it to the sun and air," remarks Sir John Sinclair, "is greatly preferable to harrowing, which tends to consolidate the surface; but it is necessary to have the land well reduced before the implement is employed."

The *scarifier* was the next great stage of improvement; and this was introduced from England to Scotland in 1811, and occasioned that year to be a sort of era in the history of British

tillage. The particular form of the scarifier introduced to Scotland was brought by Sir John Sinclair before the Dalkeith Farming Club, and was 4 or 5 years after figured and described in the Transactions of the Highland Society, and is now very generally called the old Scotch grubber, and the old quadrangular grubber. Its frame is wooden and rectangular, and is mounted upon four cast-metal wheels, of 20 inches in diameter. Two bars extend within the frame, and from end to end of it; nine cross-bars are mortised to these, at distances of about 8 inches from centre to centre; and a pair of handles or small shafts for guiding the machine, are attached to the third and the seventh cross-bars, so as to be at equal distances from one another and from the ends. Eleven coulters are fixed into the nine cross-bars and the two end-bars of the outer-frame; and are placed in such an alternate manner that five are near the front of the frame and six are near the back. "Around the openings for the coulters, above and below, are plates of iron for strengthening the wood, and with bolts firmly fixed to steady the coulters when the machine is at work. These bolts are attached by chains to prevent them from being lost, should they happen to drop out. By means of the bolts, the coulters can be set to any depth required. When the machine is to be removed from one field to another, the coulters in the ends of the outside frame are lifted up to the top by shifting the bolts; and the inner-frame is then lifted up by means of the handles, and is supported by small iron stays. The coulters stand inclined forward, and have steeled triangular feet, dipping a little, from 3 to 4 inches broad at the base, and from 5 to 6 inches long from the base to the point of the triangle." The wheels can be set at a higher or a lower pitch by means of the pins and the wedges, and can, in consequence, modify the depth of the implement's action, or the degree in which the coulters penetrate the ground; and when the machine is moving down a declivitous hard surface, the fore-wheels, if necessary, are dragged to prevent the machine from running against the horses. This implement, in spite of its cumbrousness, and its obvious defectiveness, was regarded by the ablest and most scientific agriculturists of the day as a very grand advance in the appliances of cultivation. "Such," said they, "is its utility, in saving ploughing, and keeping the land clear of weeds, that it is supposed to have added considerably to the value of every farm where it has been introduced; and it is considered to be one of the greatest improvements in the culture of the soil that modern times can boast of." Yet its faults are great and obvious. The very considerable dip of the feet gives it a tendency to go down into the soil, and occasions a constant pressure on the wheels to keep it from sinking, and a corresponding drag upon the draught of the horses. The triangular and spreading form

of the sharp-edged feet of the coulters, too, causes a severe cutting operation upon firm ground along the path or lower stratum of the machine's action, and occasions a very great and useless expenditure of draught. The form, size, and weight of the machine also diminish its utility; and, along with the previous disadvantages, require it, in the majority of cases, to be drawn by four horses. Much inconvenience and waste of time are involved in its general working, especially at the ends of the ridges; and its large frame-work and the confined position of its coulters render it continually liable to be choked up with weeds, stubble, and rubbish, and to retain them to such a degree as to give the workman considerable trouble in clearing it again for action.

Various implements, under various names, but particularly under those of scarifiers, cultivators, and grubbers, served jointly with the old Scotch grubber, at either earlier, or contemporary, or later dates, to lead the way to the true grubbers or thoroughly modern class of improved implements. Among these might be named Parkinson's scarifier, Weir's improved cultivator, Hayward's cultivator, Beatson's grubber, Cooke's scarifier, Fuller's extirpator, and some others. But the most anomalous, and at the same time the most useful, and almost serving as the type of a quite distinct class of implements, intermediate between grubbers, harrows, and hay-tedding machines, is Morton's revolving harrow. In this machine, a number of small naves, armed with radiating prongs, are made to revolve by the progressive motion of the machine; but they revolve in planes oblique to the line of direction in which the machine travels; and they not only stir the soil, but tear out root-weeds, which, as well as surface-weeds, are immediately collected by an appended harrow. "The original machine consisted of sets of spikes or prongs, fixed on an axle, round which they revolved like the spokes of a carriage-wheel. This axle was placed oblique to the line of motion, so that the manner in which the teeth worked was of a twofold nature; they partly revolved, and they were partly dragged like the teeth of the common harrow. The axle consisted of two parts converging towards each other, forming the two equal sides of an isosceles triangle. There were ten sets of teeth in all, five being on each side or half of the axle; and each set contained ten spikes or prongs, like the spokes of a wheel, but curved forwards at the point. The machine moved on two wheels, and required the labour of four horses." But it was afterwards improved and simplified by its inventor, so as to lessen its draught; and it led to the invention of some other instruments of its own peculiar class, particularly Brite's revolving harrow and Vaux's patent revolving harrow,—the latter of which was patented in 1836, and possesses two series of revolving spikes, the one so placed

as to clear away tufts and accumulations of rubbish from the other. But revolving harrows of any kind cannot be considered as true grubbers; and though excellently fitted for particular soils, situations, and purposes, do not possess such comprehensive adaptations as the true grubbers, and possibly may never come into general use.

The earliest true grubber, or next great stage of improvement after the scarifier or old Scotch grubber, was an implement brought out, about the year 1820, by Mr. John Finlayson, farmer at Kaima, in the parish of Muirkirk, in Ayrshire, and called the patent harrow or patent self-cleaning harrow. This machine was triangular-framed, and made entirely of iron, and mounted on three wheels, the foremost of which was a castor; and by means of a long lever which, in a limited degree, raised or depressed its tines, it was capable of working at different depths in the soil, and was freed from some of the disadvantages which so seriously encumbered the scarifier. It was made with either 5, 7, or 9 strong tines or coulters; and, according to the number of tines, it was drawn by 2, 4, or 6 horses. But even this machine, chiefly in consequence of its deficient means of raising the tines out of the ground, has been superseded by numerous improved grubbers, —and particularly by Finlayson's improved patent harrow, Kirkwood's grubber, and Wilkie's grubber in Scotland, and Biddell's scarifier and Lord Ducie's cultivator in England. These five implements may be regarded as, in the present state of agriculture, comprising everything worthy of attention in the category of true grubbers. The three Scotch ones present a resemblance in general form to one another and to the original patent harrow of Finlayson; and though the two English ones differ widely in structure from the Scotch ones and from each other, all the five aptly and facily perform the various operations which we have described as proper to the true grubber's action and adaptations. Another group of implements, indeed, have a grubbing action and are frequently called drill-grubbers; but they are constructed and used only for acting chiefly between the rows of growing crops, and they will come to be described under their more appropriate name of horse-hoes. See the article *Horse-Hoe*. The sequel of the present article, therefore, must be wholly occupied with a notice of the five implements which we have named.

Finlayson's Improved Patent Harrow. — This machine has a different arrangement of the wheels and levers from the original patent harrow, and is, in consequence, both efficient and very commodious. The hind wheels are attached to crank levers vibrating on an axis, and are thence connected with the lever of the fore-wheel by means of a connecting-rod; and a powerful lever, acting on this combination, and adjusted in readiness to the hand of the operator, enables him to raise the entire frame and its tines promptly and completely out of the ground. Two varieties of

the machine came early into use,—the one comparatively large, and requiring to be drawn by three horses on light land, and by four on heavy land,—and the other comparatively small, and requiring to be drawn by two horses on light land, and by three on heavy land; and several varieties are now made; but all, whether early or recent, have essentially one construction, and are particularly distinguished by the swan-neck or self-cleaning form of their tines.

The larger early variety is represented in *Fig. 1, Plate XXIV.*, and may be regarded as a good type of all the varieties. It tills a breadth of 5 feet 4 inches at one bout, and weighs between $4\frac{1}{2}$ and $4\frac{3}{4}$ cwt.; and each of its tines has a length of 29 inches, a breadth of $1\frac{1}{2}$ inch, a thickness at the point of $1\frac{1}{4}$ inch, and a thickness elsewhere of $\frac{7}{8}$ of an inch. Its two sides are for some distance parallel, and are there connected by two sets of transverse bars. "Into the hindmost of these sets are inserted five double curved teeth or prongs, and into the foremost four prongs. A little before the foremost prongs, the continued sides converge, so as to meet at the point B, where they are attached by a bolt to the apparatus ADC, consisting of the handle or regulator A, the bar leading to the forewheel C, and the part D, to which the line of draught is attached; these three parts A, D, and C, being all united together. On the hindmost transverse bar is an upright lateral spring E, consisting of two rods, forming openings, supported by two rods, from the hindmost of the two foremost bars. The regulator is made to pass through these upright lateral springs. And as the regulator, the point of draught, and the bar leading to the forewheel, are all fixed together, or of one piece, it will appear that by raising the regulator (the forewheel being always on the surface), the point of draught, and consequently the forepart of the frame, will be depressed, and the prongs forced deeper into the soil. When the regulator is at the bottom of the upright lateral springs at *a*, the foremost prongs are then lifted out of the ground; and as the regulator is lifted up through each opening, the prongs descend about $1\frac{1}{2}$ inch till it is up to the top at *b*, which gives the maximum depth, when the prongs will be between 8 and 9 inches in the ground. The hind part of the frame was raised or depressed by means of a screw on the axle of the hind wheels. These were put on, according to Mr. Finlayson's original plan of the instrument, at the sides behind the hindmost transverse bar. The length between the fore and hind wheels, however, was found to weaken the machine, and cause it sometimes to have a vibratory motion. To obviate these defects, Mr. Kirkwood afterwards made these machines, with the permission of the holder of the patent, with the hind-wheels as shown in the figure, placed opposite to the upper curve of the hindmost prongs. The axles, by means of a capstan attached to the side-beam, may be elevated or depressed, and thus the hinder

prongs made to correspond in depth with the foremost prong."

Kirkwood's Grubber.—This machine was invented by Mr. Kirkwood, an intelligent and ingenious mechanic at Tranent, who, as already noticed, effected a considerable part of the improvement on Finlayson's patent harrow; and, in point of time, it preceded the improved form of Finlayson's implement, and was probably, in even its original form, the earliest variety of grubber which combined thorough commodiousness with great efficiency. It is distinguished by a simple and powerful combination of the levers and the connecting-rod for raising the tines out of the ground; and it permits the workman, merely by pressing his hands on its handles, to graduate and modify the depth of the tines at will, or to lift them at any moment entirely out of the soil. It speedily underwent improvements, and continues to receive modifications; and it is made of different sizes, and with either five or seven tines, to suit different soils or to be drawn by respectively two and four horses; but it does not vary in any of the essential principles of its construction, and is commodious and efficient in every one of its varieties.

In *Fig. 2, Plate XXIV.* is a representation of a seven-tined variety of it, which may be regarded as a good type of the whole. The tines are a kind of blunt coulters, and are so placed as to move at equal distances from one another, and parallel to the line of motion. "The frame-work rests upon three wheels, to the axle of the two posterior of which at BB, are fixed the two guiding handles AA. These handles, which are moveable round the axle at BB, are extended to the cross-bar at CC. By depressing the handles they act as levers, of which the fulcrums are BB, and elevate the bar CC, and consequently the posterior part of the frame-work. Further, the part of the machine EF, to which is attached the forewheel G, is connected by means of the rods ED, DH, and DL with the handles AA; the same depression of the handles which elevates the hinder part of the instrument, acts upon the upright rods CD, CD, which are moveable round the iron bar CC, at these points. This acting upon the bar at the points CC, moves forward the forewheel G, and thus elevates the fore part of the frame-work, and that in the same degree as the hinder part is elevated. Thus an elevation or depression of the guiding handles elevates or lowers the whole frame-work, and consequently causes the teeth to move at a greater or less depth as may be required. By means of a simple contrivance at the point K, the rod ED is fixed in its position, and thus the whole frame is kept at the elevation required. By depressing the handles sufficiently, the whole teeth may be lifted out of the ground, which is found to be extremely convenient when turning at the end of ridges, and when moving from one field to another, or even when encountering great obstacles in the

II.

ground, as stones. The various coulters being also fixed in their place by keys or wedges, may be removed, or set at a greater or less depth as may be required. The space covered by the coulters is 4 feet 4 inches. The coulters are $14\frac{1}{2}$ inches long below the bars; 2 inches broad, or deep; and $\frac{1}{4}$ ths of an inch thick, or across, except at the point, where they are $1\frac{1}{4}$ inch thick." The diameter of the hindmost wheels is 22 inches; and the weight of the whole implement is about 4 cwt.

Wilkie's Grubber.—This machine is the invention of the well-known ploughmaker at Uddingston. It partakes of the principles of both Finlayson's and Kirkwood's, and at the same time has characters peculiar to itself. The parallel motion by which the coulters are raised out of the ground, is produced by means of the lever only, and parallel links; and the couler-frame itself constitutes the connecting-rod of the motion. The two sides approach each other, not in straight lines, but by a series of gradations; and the coulters are so fixed upon the gradations as to have aggregately a triangular adjustment. The coulters have, in a considerable degree, the swan-neck, or self-cleaning form of those of Finlayson's; and they can be nicely regulated in the depth of their incisions, or lifted promptly and entirely out of the ground, with the same ease as those of Kirkwood's. The whole machine is elegant, effective, and convenient; but, in consequence of the elaboration of its structure, it is more expensive than its rivals, and has therefore come comparatively little into use.—All the three Scotch grubbers are always constructed of malleable iron; they are generally set on wheels of not more than 20 inches in diameter, and are therefore more or less liable to become choked when working on foul ground; they have usually either five tines or seven, and penetrate the soil to the depth of from 6 to 8 inches; and they range in price from £7 to £12, and have seldom a greater weight than $3\frac{1}{2}$ cwt. when five-tined, and 5 cwt. when seven-tined.

Biddell's Scurifer.—This implement is represented in *Fig. 3, Plate XXIV.* It was invented between 30 and 40 years ago by Arthur Biddell of Playford; and is still regarded by some good judges as the most efficient implement of its class in England. It was originally, and for a long time, made with a wooden frame and wrought-iron tines; but it is now made with a cast-iron frame; and, though a heavy implement, it has a light appearance, and possesses great facility of working. "It consists," says Mr. J. Allen Ransome, "of a very strong cast-iron frame, upon which the teeth, nine in number, are arranged in two rows, and so disposed at intervals of $16\frac{1}{2}$ inches from each other, as that those in the hinder row should form a pathway midway in the intervals left by the passage of those in the front. It is suspended on a cranked axle between two wheels, 50

2 M

inches in height behind, and on an upright shaft carried on two small wheels running close together in front. It will be seen that the machine is thus suspended on three points; and by means of two levers, the one to direct the position of the front teeth, and the other to regulate the depth of the hinder ones, it may be balanced between these points in any direction that may be required. It may thus be used either with the fore-tines parallel with the hinder ones, or at a greater or less depression. This arrangement allows it to penetrate very strong or hard land, and to retain its hold when scarcely any other implement would produce any effect, and even when the plough could not work to advantage. By a simple contrivance to shift the bearing of the frame upon the axle, either side of the machine may be depressed—so that the tines shall penetrate the land to a uniform depth, even when, from the circumstance of one wheel having its path along the furrow, the bottom of the wheels may not be parallel with the general level of the land. The tines are prepared to fit case-hardened cast-iron points, of one, two, or three inches width, or cast-iron or steel hoes of nine inches width. With these latter, every part of the land will be cut. They are readily taken off and exchanged." Mr. Ransome afterwards quotes a disparaging comparison of it with Lord Ducie's cultivator, in the Prize Essay on Agricultural Mechanics, in the Journal of the Royal Agricultural Society of England, and examines some objections which are there adduced against it,—particularly, that it is a clumsy implement, that the apparatus for adjusting its tines is complicated, that the form of its tines is not good, that, in consequence of being made of cast-iron, it is liable to break, and that, when made at a width of 4½ feet, it requires to be drawn by four horses; and he so disposes of both the comparison and the objection as to give Bidell's scarifier a decided preference.

Lord Ducie's Cultivator.—This grubber was brought out a number of years ago by the talented manager of Lord Ducie's model farm; and is often called the Uley cultivator from the locality of its origin. A representation of it, as presented by Lord Ducie to the Highland and Agricultural Society of Scotland, is given in *Fig. 1, Plate XXV.*; and a description of it, with references to the original of that representation, occurs, in the following terms, in the 14th vol. of the Society's Transactions.

"It consists, first, of a frame AA of cast-iron, of an irregular pentagonal shape, and formed in one entire casting. This frame carries five tines, BB, &c., with which the machine is armed. These tines consist each of two parts, the body B also of cast-iron fixed immoveably into the frame by means of tenon and key, and of the point or share C fitting upon the lower extremity of the body like a ploughshare. Two forms of share are employed, the webbed and the point-

ed. The frame thus constructed is mounted on two wheels DD, 3 feet 2 inches diameter, and what may be called a double wheel EE in front, 1½ foot diameter. These last wheels are mounted on a reverse T-form axle, and the hind-wheels on a cranked axle F. The draft-shackle, to which the horses are yoked, is applied in a permanent position to the stem H of the T-axle; and by this means, the wheels, the stem, and the shackle turn together, forming an efficient castor-wheel. The stem H of this axle passes also vertically through an eye in the anterior angle of the tine-frame. For the purpose of elevating or depressing the tine-frame, a lever II, having equal arms, and of the second order, has its fulcrum in the top of the stem of the T-axle at I. The point of resistance of the lever is jointed to a slender pillar K fixed in the tine-frame. On the cranked axle is fixed a wheel or segment of a wheel with oblique teeth, fitted to work in an endless screw or worm L; and on the axle of the latter is the winch-handle M. The oblique-toothed wheel carries also a crank-pin, forming a lever, which is placed diametrically opposite, and of equal radius with the cranks of the main axle, each being 6 inches. The crank-pin of the oblique wheel is now connected with the power end of the principal lever, by means of the connecting-rod N; and this elegant mechanical combination has the effect of moving the tine-frame always parallel to the horizon in its vertical movements out of or into the soil, these movements being performed by turning the winch-handle M."

This machine has a sufficient height of wheels to escape the risks of choking to which the Scotch grubbers are subject; and possesses such a recurvature in the upper part of its tines as to give them the property of self-cleaning; and it admits of being made of different sizes, in adaptation to different situations and to different powers of draught. It was supposed, in the Highland Society's account of it in 1842, to be essentially so ponderous that a five-tined variety would weigh not less than 10 cwt.; but it was early furnished from Uley at an ordinary weight of about 6 cwt.; and it has since undergone improvements which affect some points of its strength and construction, and considerably increase its commodiousness and adaptations. Clyburn's five-tined Uley cultivator covers a space of 40 inches; his seven-tined one covers a space of 56 inches; and both are improved in constructing the tines so that they can be made of malleable iron, in fixing them more strongly into the frame, and in forming them with such a concavity below that they wear a sharp edge and readily enter very hard ground. "The frame is made to receive five or seven tines, each tine covering a space of 8 inches and so arranged that, although drawing lines only 8 inches apart, they are two feet from each other; and this, with their curved shape and length, prevents its clogging in the foulest land.

Fulversons Improved Patent

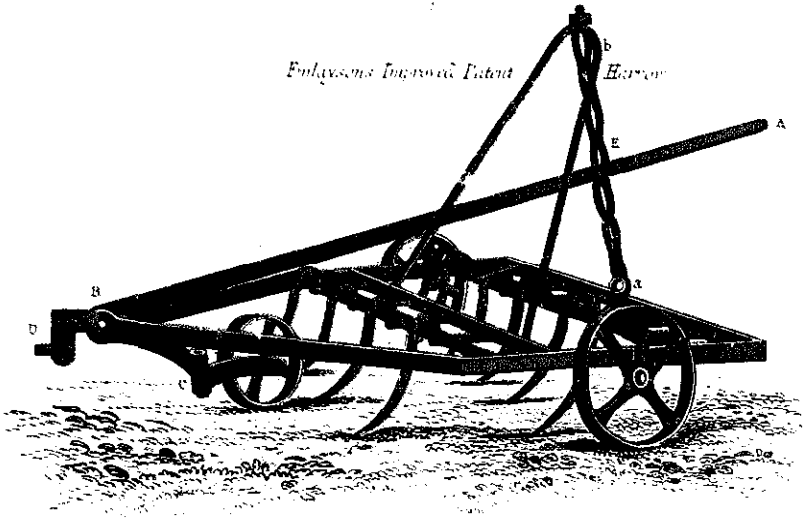

Kirkwoods Grubber

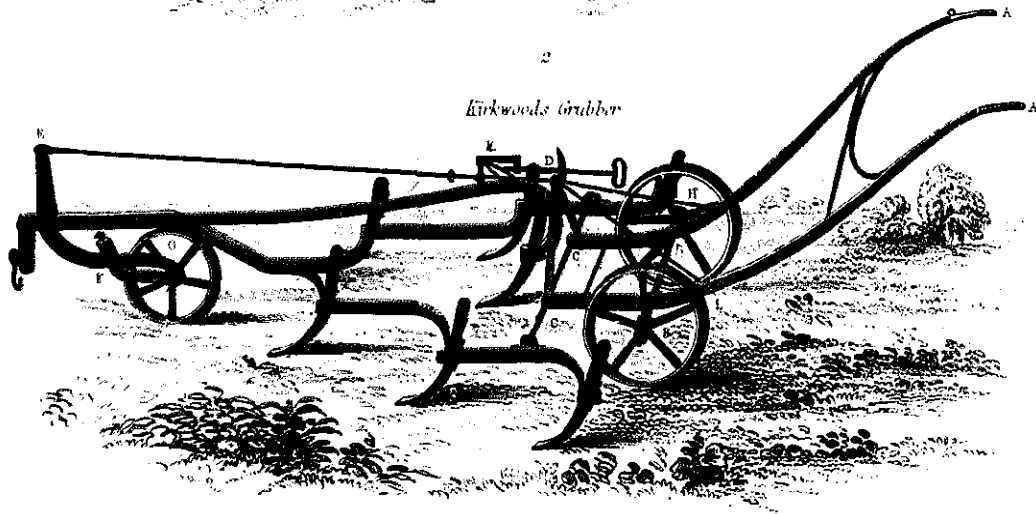

Biddells Sartin

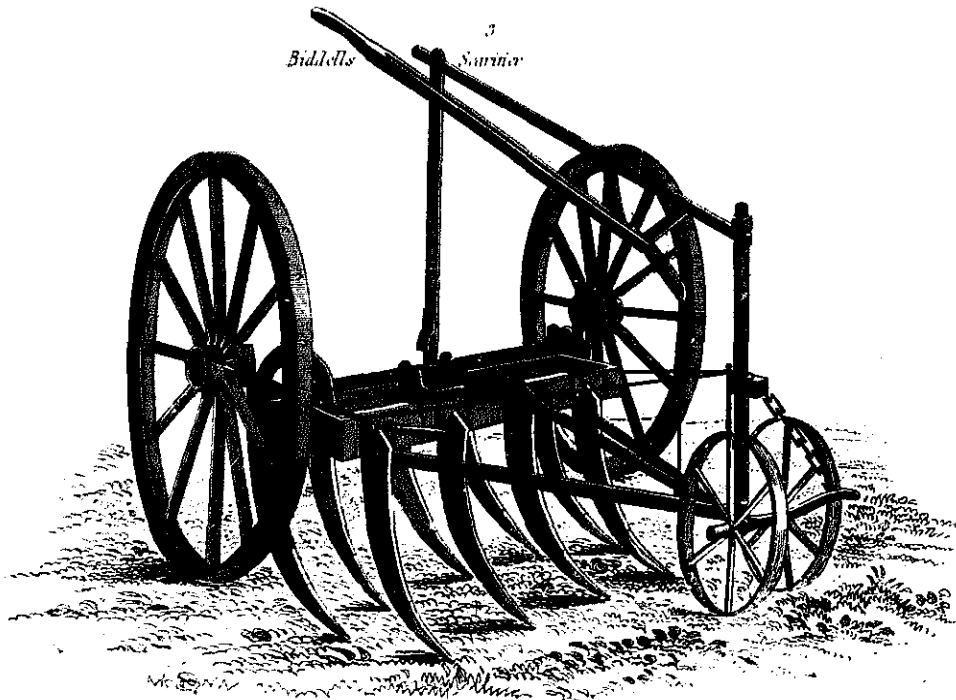

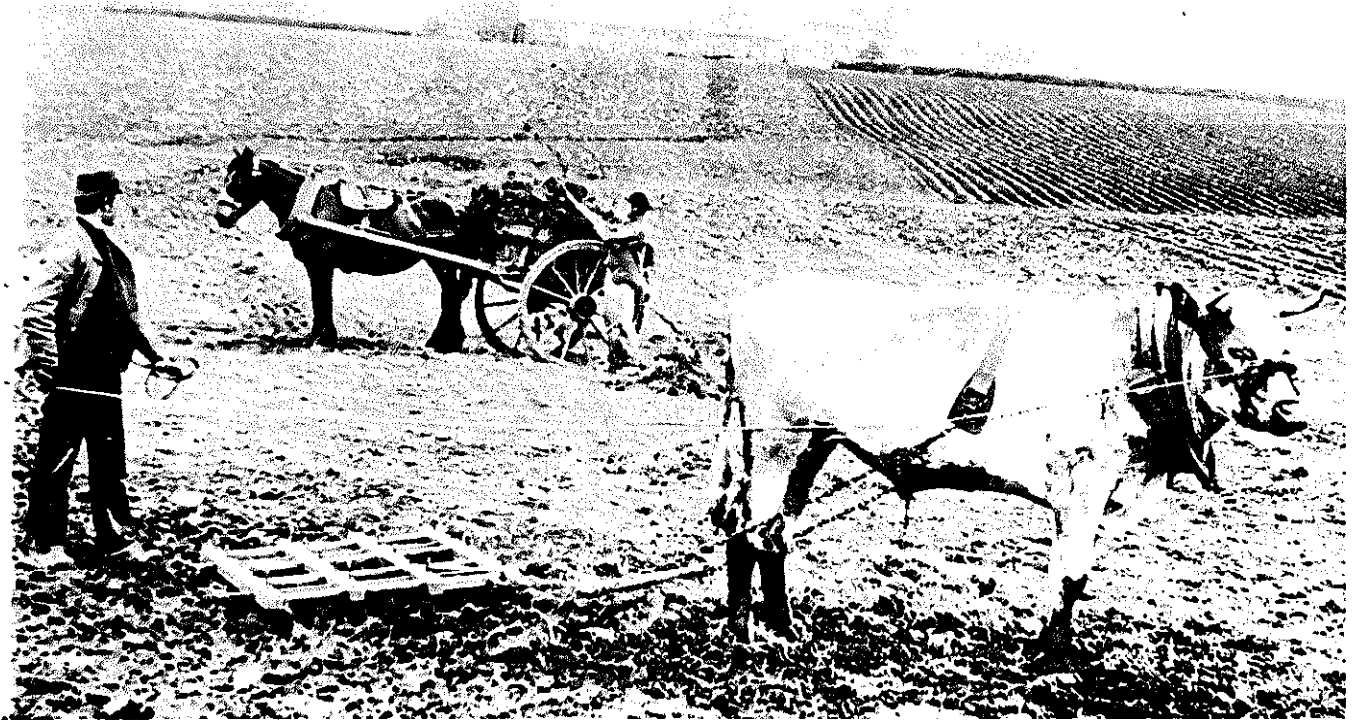

Harrowing would have been a slow job using this small wooden framed implement, pulled by an ox. I would think it was more usual to employ two animals pulling a yoke. Below is the "modern" method. Both photographs are from the collection of the Museum of English Rural Life, Reading.



THE HOE

from

"A Cyclopaedia of Agriculture"
J.C. Morton, 1855

HOE (THE).—This implement, as used by the hand, is employed for the destruction of weeds, as in the surface hoeings of corn and green crops; for the loosening of the ground, as in hacking the potato crop, or even turnip land, under a spade husbandry cultivation, and for "singling" plants, whether sown broadcast or in rows. For all these purposes, except the last, implements drawn by horses, have been successfully substituted for the

hand hoe. For this reason, we give no figures of the latter in the different forms given to it in various districts. If used for hoeing between the rows of drilled corn, it must be a light tool, narrow enough for the purpose. For singling turnips in rows, its blade may be eight inches wide, and fixed at right angles on its shaft, so as to be equally efficient when pushed as when pulled, for the removal of those plants in the row which are to be destroyed. For heavy hacking, a heavier tool, with a longer and narrower blade, is used, shaped more like the adze, and having a stronger handle. For the removal of weeds in hedgerows, the form of the tool, known as the Dutch hoe, which presents a mere edge to be pushed against the roots of the plants, is adopted. And other hoes are used in different localities, of a variety of forms; pointed when they are intended for a deep penetration of the land, or for the drawing of furrows or drills in the seed bed, and very broad when used, for instance in the earthing up of potatoes, and, of course, of every width between these extremes, for other purposes. But it is to notices of the implements of the hoe kind, drawn by the horse, that we must at present confine ourselves.

The drill system, as it spread, soon opened the way for a thorough cultivation of the land during the growth of the crop by means of horse hoes. The last application of mechanism, for this purpose, is seen in Garrett's horse hoe for cleaning the land between drills of corn. It is of various widths, corresponding to those of the drilling machine employed in sowing the seed. The latter, when used during seed time, was guided by an apparatus for the purpose described in the article on sowing machines, and the rows have accordingly made their appearance with great exactness in straight lines at intervals of from eight to twelve inches; and this will facilitate the safe use of the hoes between them. But it will be observed, that, even supposing the drill to have been imperfectly managed, so that the rows have not come up in perfectly straight lines, yet, owing to the system of drill coulter being of one piece, nearly rigid together, any deviation from exactness must affect all alike; the rows, if not parallel, are at least concentric in the case of any curvatures occurring during their course. Now the system of hoes, in Plate XXVII. brought to bear in Garrett's horse hoe, are of equal number, and operate at equal intervals, with the system of drill coulters in his sowing machine; and the former, like the latter, is also rigid together; it only needs, therefore, that one of the hoes be guided correctly, and the whole, being once placed on the width formerly occupied by

the sowing machine, will also be guided correctly. If the interval between two hoes be safely and correctly made to include a row of the growing corn, following it with exactness in all its deviations from the straight line, then all the other intervals between hoes throughout the breadth of the machine, will correctly and safely include all the other rows, throughout the course of the machine from one end of the field to the other. In order, then, to enable the man who walks behind the machine, to guide the system of hoes correctly, it is hung from a framework, supported on two wheels; and, by means of a lever seen in the drawing, it may be moved to and fro from one side to the other, with great ease.

The bar on which all the coulter levers are placed is hung in front, on two arms jointed to the framework at top, and jointed to this horizontal bar at bottom; and by means of a cross shaft carrying a lever handle at one end, and a crank lever at the other; these suspension arms are moved to and fro, carrying the horizontal coulter-bar, and all the coulters with it from one side to the other, according as the manager of the machine directs. All of the coulter-levers, at the same time, rest upon a bar behind, which is suspended by chains, giving it free motion, and thus enabling perfect obedience throughout their whole length, to this enforced lateral oscillation of the coulters in front. Before the machine is set to work, the coulters must be hinged at the proper intervals on to the horizontal coulter-bar in front; and this is best done by taking it to the field, placing the machine in its working position over the rows whose intervals it is to clean, and fixing the coulters so that the rows shall be safely within these intervals with a space of about one inch on each side to spare. The system of hoes is then let down by the two strong suspension chains behind, until, the shafts of the machine being held up as if the horse were between them, the hoes are found to have play enough to drop into the deepest unevennesses they are likely to meet with. The machine is then drawn from one end of the field to the other, a man guiding the shaft horses carefully, so that the hoes shall, as nearly as possible, fit the intervals in which they are to work, and the manager behind compensating any deviation from the accurate direction of motion by pushing the hoes from one side to the other, as they need it, so as to save the one row on which he has his eye, so therefore as to save all the rest of them. On reaching the end, the bar carrying the hinder ends of the coulter levers is lifted by the two chains which suspend it, and which are carried on eccentrics placed upon a cross shaft behind the

machine, to which one third of a revolution, enough to lift the chain, can be given by the handle placed upon it for the purpose. The machine is then turned and placed upon another breadth, and proceeds on its course as before. A very efficient hoeing is thus given to all except the very hardest lands, and surface weeds are thus satisfactorily destroyed. So far as our experience goes, however, it is not capable of working hard clay land, nor of cutting through root weeds, such as the couch grasses. The coulter levers carry weights, which enable the hoes to penetrate beneath the surface of ordinary soils. The hoes themselves are arranged in various ways, as may be desired. Where two hoes are used to an interval, any of the arrangements *d*, *c*, *b* in the an-

Fig. 549.

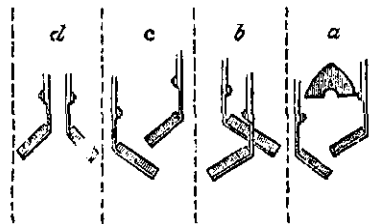

nexed figure will do; *b* being a pair of wider hoes, and adapted for a larger interval than the others. In the case of the widest intervals, three hoes, as in *a*, must be used.

The cost of Garrett's horse hoe varies with its width, from £16 to £18. A strong horse will clean eight acres a day.

We have yet to describe the implements employed in the cultivation of the wider intervals between the rows of turnips, and other green crops, during their growth. Only one interval is here managed at once, except where, as in some of the English counties, the seed has been drilled at intervals of about eighteen inches on the flat, and where Garrett's implement, just described, comes into play, covering and cleaning three or four intervals at once.

During the cultivation of the turnip, as will be more particularly described in the article on that crop, the rows are paraded, that is, a small plough (*see* PLOUGH), or the common plough with its mould-board taken off, is taken down each side of each of them, and the earth on each side is thrown into the middle of the intervals; the earth in the middle is harrowed with the drill-harrow (*see* HARROW); it receives a surface cultivation by horse-hoes with paring teeth, for the destruction of weeds; and it receives repeated stirrings, for the proper loosening and tillage of the soil, so that the rootlets of the plant may thoroughly penetrate it. Besides this, of course, the hand-

HARROW-HOE.

PLATE XXVII

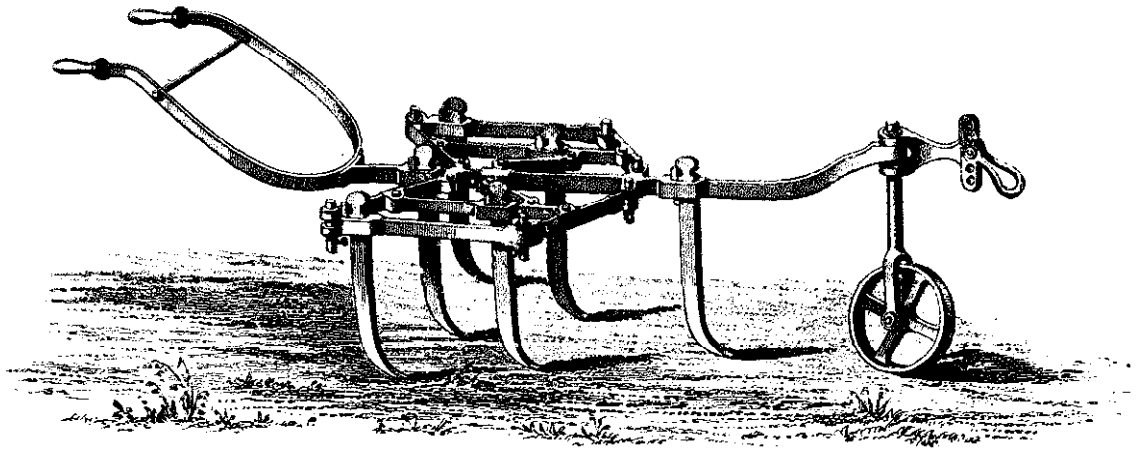

ULEY EXPANDING HOE.

$\frac{2}{3}$ of the full Size

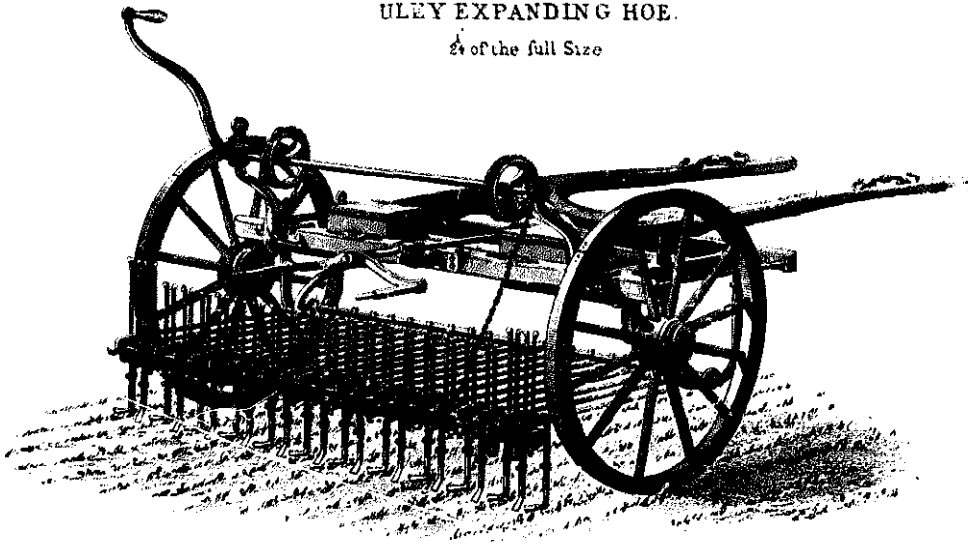

GARRETT'S PATENT HORSE HOE.

$\frac{2}{3}$ of the full Size

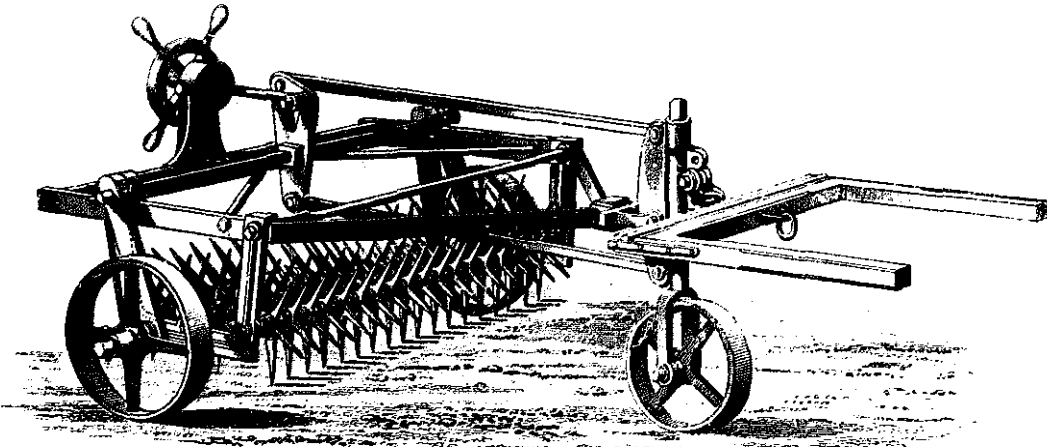

H. Stone Del.

NORWEGIAN HARROW

$\frac{2}{3}$ of the full Size

J. H. Le Keur Sc.

HORSE HOES.

Plate XXVII.

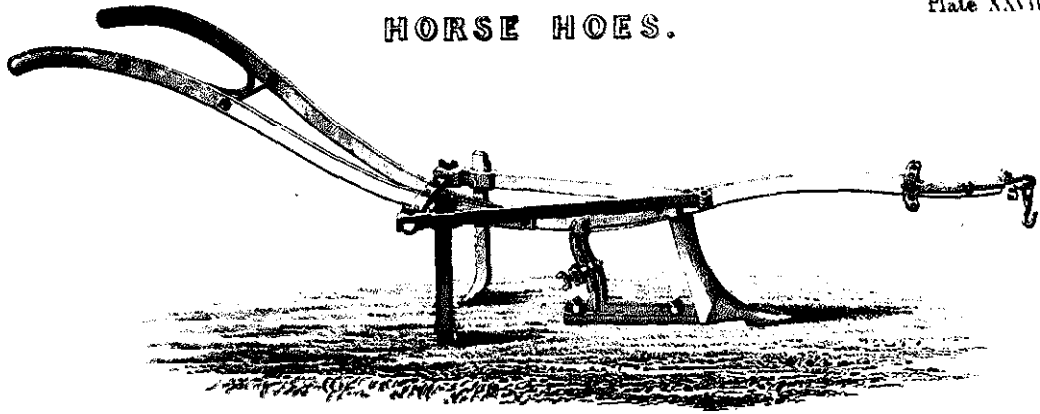

SCOTCH PLOUGH & HOE.

$\frac{1}{28}$ of the full size.

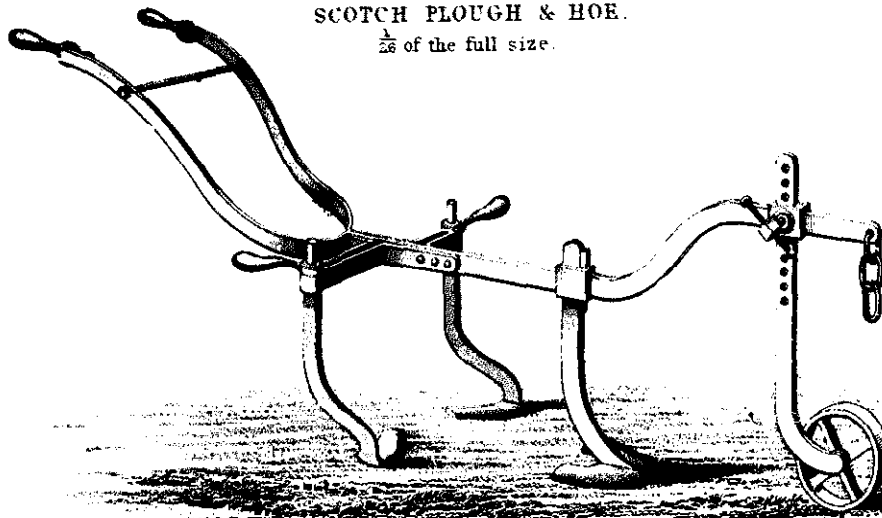

COMMON HORSE HOE.

$\frac{1}{20}$ of the full size.

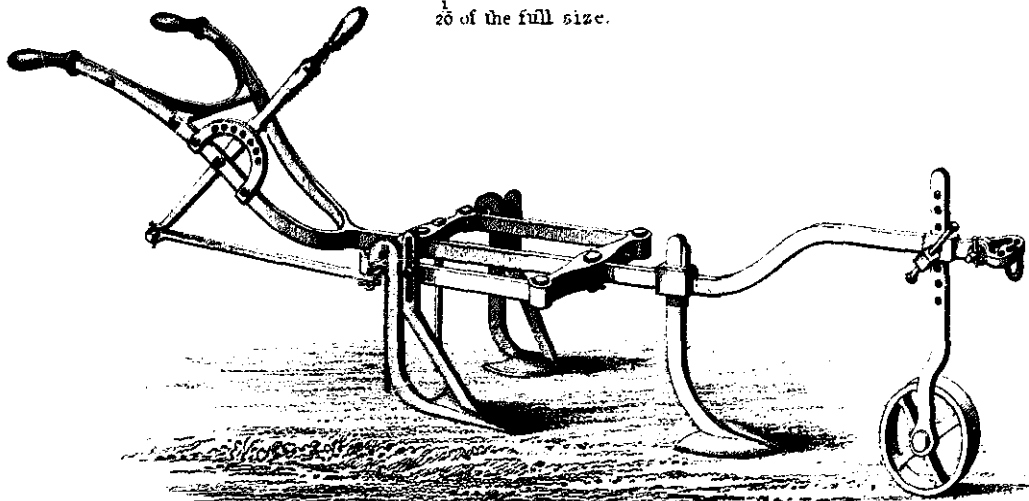

CLARKES' HORSE HOE.

$\frac{1}{20}$ of the full size.

W. Stone del.

J. W. Lowry Jr.

hoe is used at least twice for the singling of the plants, and the destruction of weeds between them. It is only the two latter kinds of implements that we have to describe under this article, HORSE-HOE. A small, generally narrow, triangular framework, with a wheel in front, regulating the depth it shall be permitted to go—carrying teeth, either merely harrow teeth, as in the case of the drill-harrow, pointed forwards, as in the case of the drill-grubber, or having horizontal edges, where the destruction of surface weeds is the main object; having handles behind, between which the man or boy in charge of the implement shall walk, and a place of attachment for the horse in front—is a horse-hoe. These are its essential features, though of course descriptions of such implements vary considerably in their details. The common drill-harrow, described under the article HARROW, contains all the chief parts of a horse-hoe: substitute for those tines, teeth with horizontal edges, or with mere points projecting forwards, and you have a horse-hoe.

Our figures in Plates XXVII., XXVIII. give drawings of four different forms. The common Scotch horse-hoe, Plate XXVIII., is perhaps the simplest. Those arms carrying the teeth may be removed, and two mouldboards being hinged on to the front part of the plough, and connected together through the slot below its central beam, the machine becomes a double mouldboard plough. With the radiating arms attached, as it is drawn, it is a horse-hoe; the front coulter and the two side ones together, clear the path of the machine of all surface weeds. It may be observed here that the mode of widening the operation of these horse-hoes, by means of radiating arms, is incompatible with the use of a tooth projecting forwards into the land, for if in any one position of these arms these teeth face their work, then, in any other position, they must be pulled sideways on to their work, occasioning much useless labour, and ultimately suffering injury by being bent aside. The front teeth being fixed, may, of course,

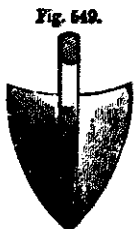

be of any shape; and it is best that they be paring teeth, of either of the forms annexed.

When it is desired to have expanding horse-

hoes, to suit different widths of interval, the teeth must either be shifted individually on the cross-bars to which, as in a common form of the horse-hoe, Plate XXVIII., they are attached; or they must be bolted or wedged in the side-bars of a parallelly, not radially, expanding framework. In the Uley expanding horse-hoe, we have such a framework, which is figured in plan below. For the perspective drawing of this implement, see Plate XXVII.

Fig. 551.

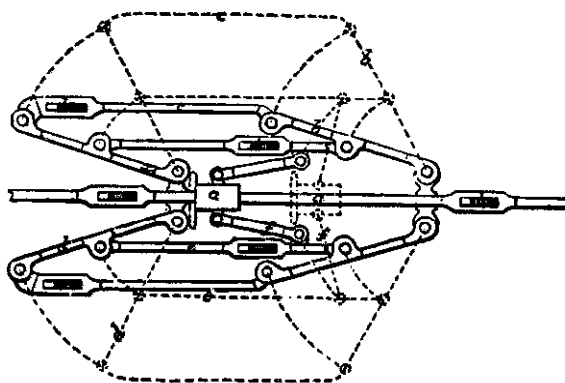

The plan, Fig. 551, shows the mode in which the framework is widened. It consists of five parallel bars jointed together by parallel cross-pieces: the central bar is extended at either end—at the one furnishing the handles, and at the other the slot-hole for the shaft of the front wheel. When widened—*c*, *b*, and *d* assume the positions indicated by the dotted lines. The saddle *a*, connected with the cross-arms *f*, slides up the central bar into its new position; and being hindered from sliding back by the pin behind it, the whole framework becomes rigid in the wider form thus assumed. But Harkes' horse-hoe is much the cheapest form of parallel expanding horse-hoe that we are acquainted with. The mode of its operation is obvious from the drawing in Plate XXVIII. By pushing or pulling the handle attached to the stilts of the implement, the jointed framework which holds the teeth may be made a square, or a very acute angled parallelogram; in the one case, its side-bars, and the teeth which they carry, being at their greatest—in the other, at their least—distance from one another; and in either position, the framework remains so long as this arm or lever, by which it is shifted, retains its position; and this it is made to do by the very

Fig. 552.



simple spring-catch figured below, by which it is bolted into one or other of the

holes in the semicircular loop by which it traverses.

The mode in which the hinder teeth of this horse-hoe may be made to point downwards, so as to take hold of the land, deserves attention. It is clearly represented in the drawing. We may mention that latterly attempts have been made to combine the harrow and the hoe in one implement, by attaching behind the former a narrow triangular framework, studded with harrow teeth, which it drags after it as it proceeds. Weeds cut off by the front part of this machine are then pulled to the surface by the hinder part. And we have even seen a light apparatus, of the Norwegian harrow description, dragging after a horse-hoe; which, however, we consider less likely to be useful than the simple harrow. The following

are the prices of these implements:—

The common horse-hoe, about	£2	0	0
Do. do., with harrow attached,.....	2	15	0
Do. do., with Norwegian harrow, ..	3	10	0
Harkes' parallel expanding horse-hoe,	£2	to	3
The horse-hoe and moulding plough, about.....	5	0	0
The Uley horse-hoe,.....	7	0	0

This last implement we have figured, as representing a thoroughly efficient machine, but its merits are obtained at a cost beyond the intrinsic value of the horse-hoe; and, indeed, they may, as Mr. Harkes has proved, be developed in implements of much less expensive construction. A horse-hoe, working in intervals of twenty-six inches, ought to get over more than three acres in ten hours. [J. C. M.]

E. H. BENTALL, HEYBRIDGE WORKS, MALDON, ESSEX.

27

BENTALL'S PATENT HARROWS.

These Harrows have now been some years before the public, and have given general satisfaction. A Prize was awarded to them at the Chelmsford Meeting of the Royal Agricultural Society; also at the Royal Dublin Society, the Bath and West of England, the Highland Agricultural Society of Scotland, the Royal Agricultural Improvement Society of Ireland, Liverpool and Manchester, North Lincoln, Norfolk, and many other societies.

There are three points of special importance to which particular care and attention has been paid in the construction of these Harrows: they are as follow:—

The shape of the Beams.—These Harrows are made on the zig-zag principle, which allows of the teeth being so placed that each cuts a separate track, or line; by this means all the land is equally dressed.

Form of the Iron.—This is of a double angle form, thus — which renders the Harrows much stronger than if made of the same weight of square iron. The holes in the beams and bars can, in consequence of this peculiar form, be punched by a machine when the iron is cold, thus ensuring greater truth than on the ordinary process of manufacture.

Securing the Teeth.—The teeth are securely held in their proper positions by means of a stop or guard, which is riveted against the nut so as to effectually prevent it from turning or getting loose.

Prices.—A list containing several hundred sets of these Harrows, differing in the width of teeth, width of the set of Harrows, weight, &c., can be had on application.

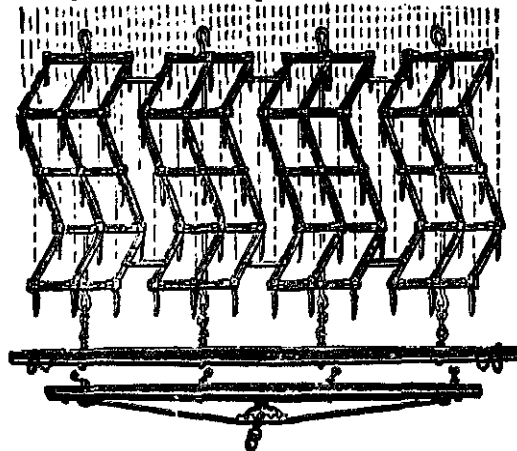

In ordering Harrows, say if a trussed or straight Whippletree is required.

LAND ROLLS.

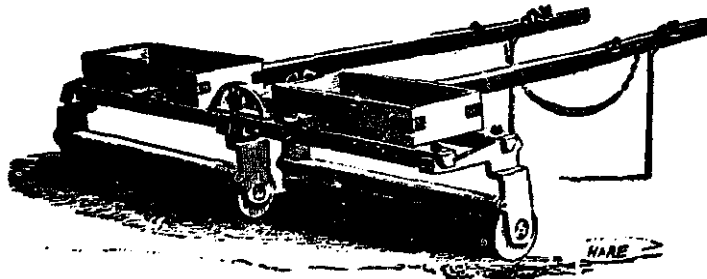

These Land Rolls, being jointed, are adapted for use either on the ridge, stetch, or flat. They are constructed so that there are no tenons or mortices in the framing: the bars are made of oak, and the gudgeons and boxes in which they run are of cast iron, renewable at pleasure.

Mr. BENTALL has made an improvement in the construction of these Rolls, which consists in placing one of the cylinders in advance of the other, instead of their being

both in a line. The advantage of this is that all the land is covered. When the ordinary jointed Roll is used across the ridges, there is always a space between the two cylinders. Boxes can be fitted on the top of the frame for the purpose of loading the roll with stones, if required.

Bentall's Improved Land Roll.

Prices.—The Prices of the Straight and Improved Rolls are alike.

	WIDTH	DIAMETER	£	s.	d.
Two ridge or	8 ft.	11 in.	8	8	0
Half-rod or	9 ft.	11 in.	9	9	0
Three ridge or 10 ft.	11 in.		10	10	0

Boxes, according to size, 5s. to 7s. 6d. each extra.

Extract from manufacturer's catalogue, 1865.

CULTIVATORS

grubbers or scarifiers

from

"A Cyclopaedia of Agriculture"
J.C. Morton, 1855

CULTIVATORS, GRUBBERS, OR SCARIFIERS, are a class of implements in much more general use now than they formerly were. They probably originated in an alteration of the harrow, the teeth of which, though admirably adapted for the surface operations of breaking clods, and gathering weeds, and covering seed, do not possess a form enabling them to penetrate the furrow slice. By raising the framework in which they are fixed, and giving them a form curving obliquely forwards, they are enabled to penetrate to any required depth; their shape gives them a hold of the land, and thus the frame requires to be supported on wheels, lest the teeth should work themselves into the ground altogether. Add an apparatus for raising or lowering this framework, adapting its

position to the depth at which the teeth are desired to work; arrange these teeth in the positions, relatively to one another, in which each will be likely to perform its work with least annoyance to the rest; give them a form, which, while it takes hold of the ground, shall stir it effectually, with the least exertion of force, and clean it thoroughly, leaving the weeds on the surface of the land, with the least liability to clog; arm the points of these teeth, or tines, with chisel or "duck-feet" edges, in order to fit the machine either for stirring or paring; give the framework height enough above the ground to allow room for weeds to gather and fall off, even where the teeth are deepest in, and the land is foulest; give due attention to all these particulars, and you will succeed in the formation of a good cultivator. It is found that five teeth thus fitted up give abundant work for two strong horses. Where the framework is made to hold seven or more teeth, four or more horses are needed.

It may be well first to refer to the uses of the implement, and then to describe some of its existing forms. Cultivators are employed, with their broad edges, in paring stubbles, and with their narrow teeth in stirring the land after being thus cleaned—in stirring ploughed land, in spring, to the bottom of the furrow slice of the previous autumn—and in lifting to the surface the weeds to be gathered and removed, or the clods to be broken, which may have been buried by the last ploughing. In all cases, it is desirable that the surface be tolerably even before it be used, as the depth of its teeth in the land depends upon the position of its wheels on the surface; and unless that be even, a uniform depth of cultivation will not be obtained. In the case of the autumn cultivation of stubbles, this is not likely to require attention; but for spring work across the previous winter's furrow, the harrows, and probably the roller, must precede the implement, in order to prepare an even surface for its operations. Besides these methods of using the cultivator, it has been successfully employed in breaking up clover lea: if the land be crossed with this implement, using its narrow teeth, before being ploughed lengthwise in the ordinary way, the furrow slice will be much less difficult of reduction to tilth; the seed it receives will be more satisfactorily covered by the harrows, and the land will be in a better condition to nourish the young plants.

Now, as to the construction of the machines which are to perform all these operations, *the form of the teeth*, on which the efficiency of their action, and the facility of their passage through the land depend, seems the point of chief consid-

CHAFF-CUTTER, CULTIVATOR.

Plate VI

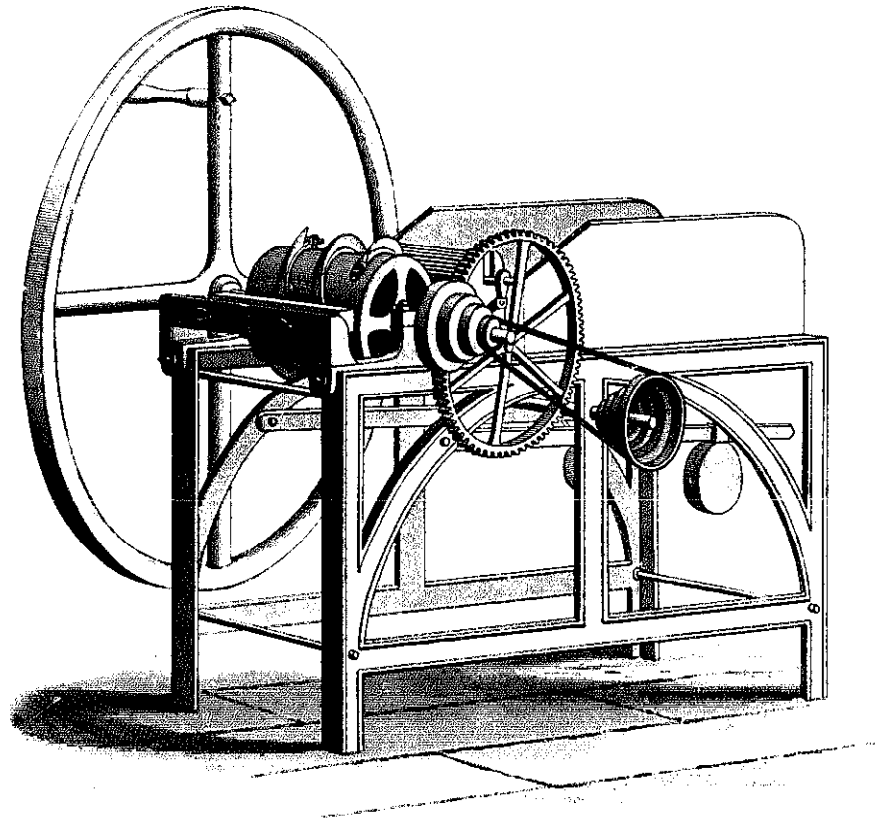

CLYBURN'S SPIRAL CHAFF-CUTTER.

$\frac{1}{2}$ of the full size

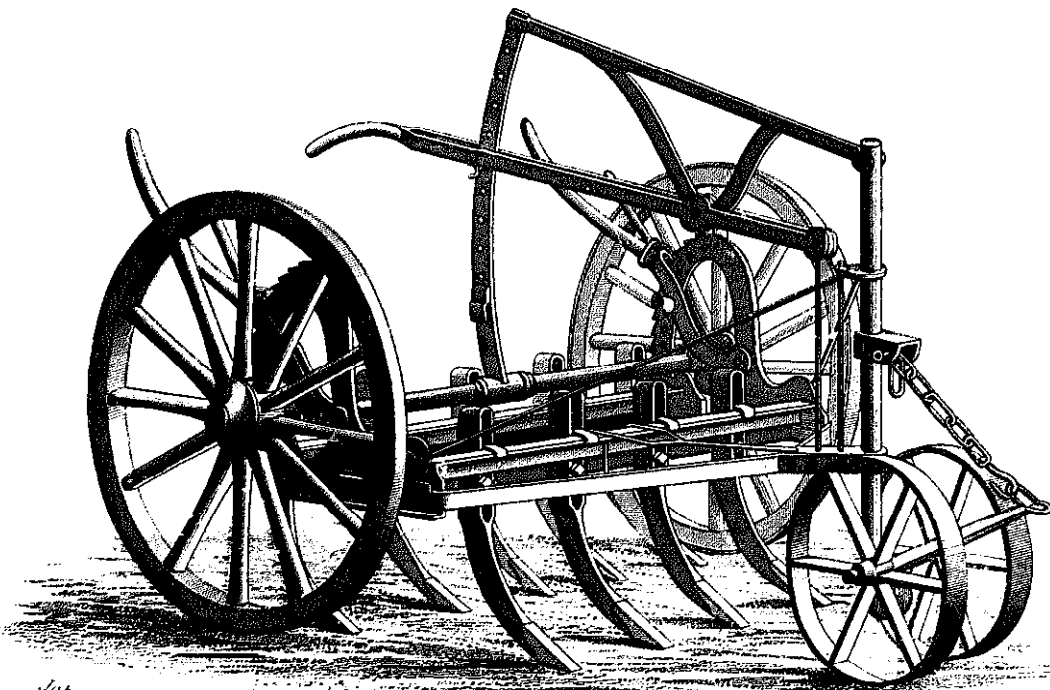

Jabez Hare, del.

H. A. Alard, sc.

BIDDE'S SCARIFIER

$\frac{1}{2}$ of the full size

CULTIVATORS.

PLATE VIII.

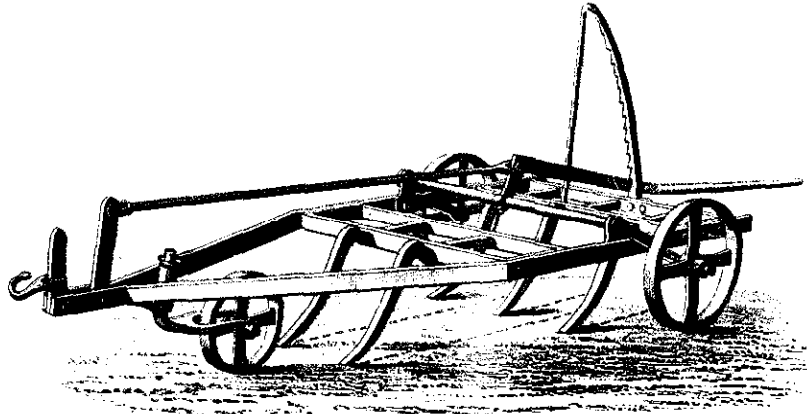

FINLAYSON'S GRUBBER IMPROVED BY SCULAR.
 $\frac{1}{2}$ of the full size.

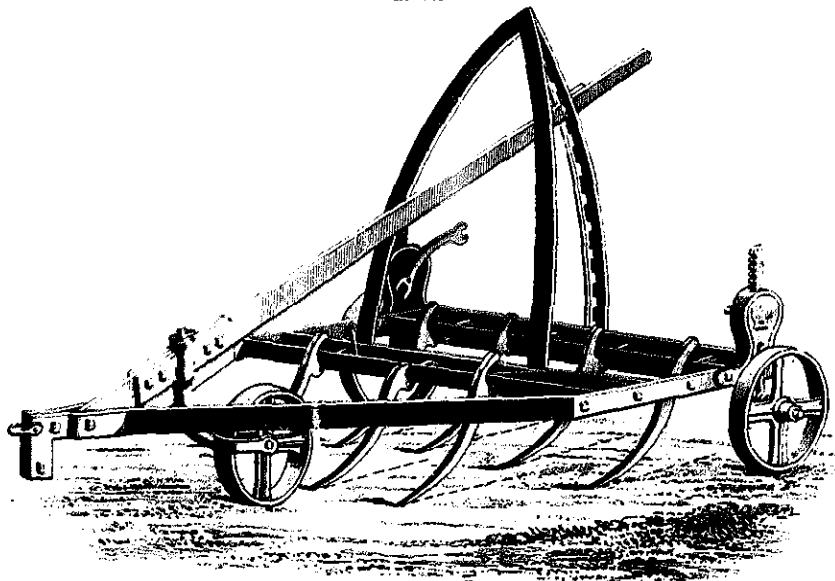

FINLAYSON'S GRUBBER.
 $\frac{1}{2}$ of the full size.

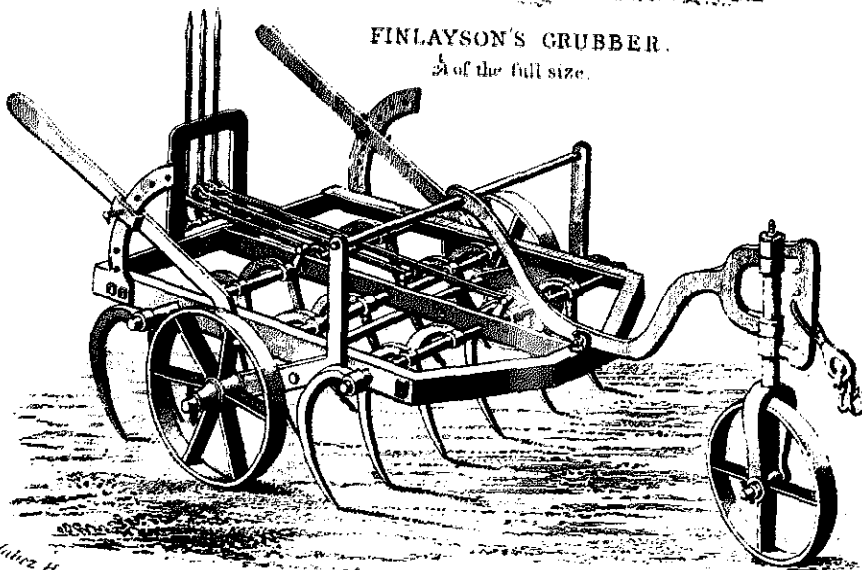

BARRET & EXALL'S CAT'S CLAW DRAG.
 $\frac{1}{2}$ of the full size.

W. H. Lowe del.

J. H. Lowe sc.

CULTIVATORS.

PLATE IX

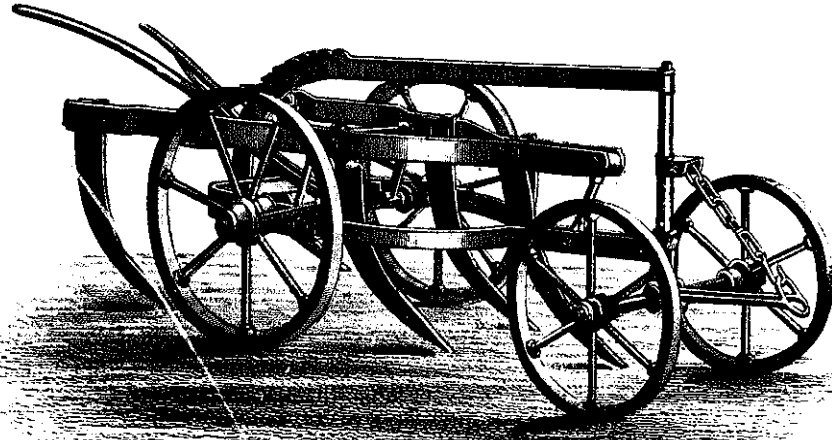

RANSOME'S INDIAN CULTIVATOR.
 $\frac{1}{4}$ of the full size.

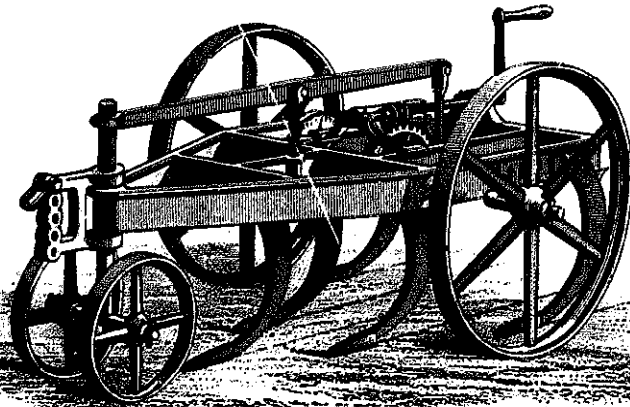

THE ULEY CULTIVATOR.
 $\frac{1}{4}$ of the full size.

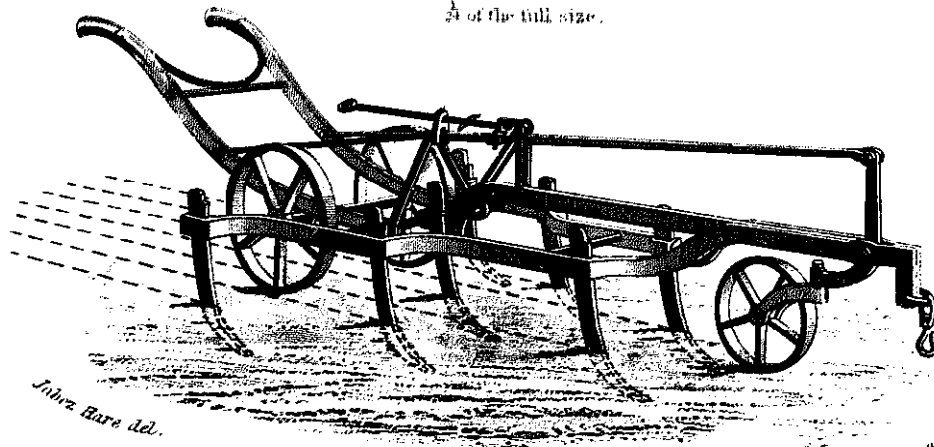

KIRKWOOD'S GRUBBER.
 $\frac{1}{4}$ of the full size.

J. H. B. del.

J. H. Lowry jr.

eration. The following is a drawing of four teeth:—(1) is adopted in Biddell's scarifier; (2)

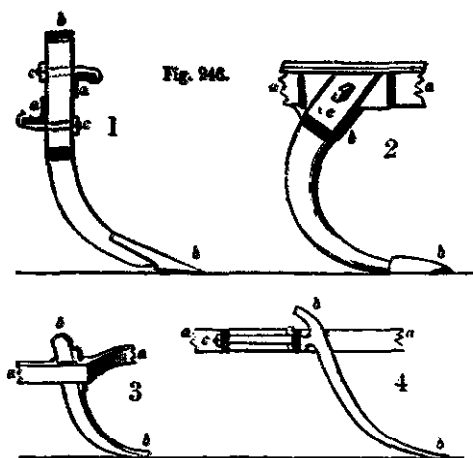

in the Uley cultivator; (3) in Kirkwood's grubber; and (4) in Finlayson's harrow: (1) and (4) are shown in elevation; (2) and (3) in perspective. The fourth, as figured here, seems the best adapted to perform its work with facility. The tooth *b b* in it and (3) might be armed, as (1) and (2) are, with points, or edges, of any required shape, either for stirring, or for paring the surface. At that part of it where it is in action, (3) is of a shape somewhat resembling (4); but in foul land, the weeds will be apt to accumulate between it and the framework *a a* in which it is fastened; while in (4) they will more easily fall off. (1) differs from (3) and (4) in being somewhat more abrupt, and (2) in being still more gradual in its action upon the land. There is a possibility of being too gradual—not sufficiently abrupt; for where there is any length of the tine nearly horizontal, as in (2) is the case, it merely has the effect of carrying a weight of earth, and so of increasing the labour of the operation, without in the least increasing its efficiency. These teeth are shown, as fixed in their respective machines, in Plates VI., VII., VIII. Biddell's machine, Plate VI., which is there shown as one of the largest size—a nine-tined cultivator—has its teeth, as is shown both there and at (1) in the above figure, placed between two cross bars *a a* of the framework, to which it is bolted at *c c*; and they can thus be placed at such a depth below the framework, consistently with the height at which that is slung above the ground, as may be considered desirable; the same form of tooth is adapted by the same makers, Messrs. Ransome and May of Ipswich, to another framework, shown, under the name of the Indian cultivator, in Plate VII., and Fig. 251; there it is bolted directly on to the cross bar,

without any ability to shift. The second form of tooth, that which is used in the Uley cultivator, is shown, as fixed for use, in Plate VII., and Fig. 253; it embraces the framework, *a a* (2), Fig. 246, and is keyed up to its position by *c*. The tine is held by the key *c*, and is supported by a projecting part of the framework, which is extended downwards below the general line for that purpose. This seems as good a way to hold the tine in a cast-iron framework, as has been devised. A somewhat similar tooth to this has been adopted by Mr. Smith of Northampton, in his large cultivator, shown in elevation at Fig. 250. Here the framework and teeth are of wrought iron, and, accordingly, they are made of smaller section and material. The tooth (3), Fig. 246, is shown in Plate VIII., and Fig. 249, as fixed in the grubber of Mr. Kirkwood, Tranent, East Lothian, which is a useful machine, long of high estimation in the south of Scotland. The tines here, too, are of wrought iron, and are keyed into mortises in the framework. The fourth, again, the form adopted by Finlayson, is shown in Plate VIII., and in Figs. 247 and 248; it is fixed in its place by a horizontal extension of the tines passing through two cross bars of the framework, and bolted at its extremity, as is shown at *c* (4), Fig. 246.

Besides the teeth named, we may refer to that of Messrs. Barrett and Exall of Reading, in what they call their cat's-claw drag, Plate VIII. In this machine, each row of teeth is made movable independently of the others, and being made to move nearly in the circle which its own nearly circular form occupies, there is no difficulty in lifting it out of any heap of weeds and rubbish which may, for the time, have clogged its operation.

Besides the form of the teeth, as affecting their facility and efficiency, there are the *height of the framework, and the arrangement of the teeth* in it, which greatly determine the former of these particulars. In Scouler's (Haddington) form of the Finlayson's harrow, the wheels being only twenty inches in diameter, the frame is not more than ten inches above the ground when the teeth just rest on its surface; and, when they are at work, four or five inches deep in the land, there is not space enough, except in clean land, for the weeds to pass without catching in the framework, and so obstructing the operation of the implement. The same is true, though in a less degree, of Kirkwood's grubber, where the wheels are eleven or twelve inches in radius, and where the framework, besides being a little higher from the ground, is of a form less liable to catch the rubbish lifted to the surface by the operation of the

machine. In the other machines we have named, the fault of too low a framework has been avoided by the use of wheels from three feet to three feet six inches in diameter; and a framework being hung from, or resting on their axles, it is thus placed at a sufficient height to allow of the teeth it carries going deep enough, without the weeds they lift having any liability to clog the passage of the machine.

But unless the teeth are properly arranged, they will themselves be unable to traverse a couchy field; the weeds and roots will "reave" up before them, and stop their passage; it is of importance, therefore, that they be arranged in the manner least likely to clog their progress. In most machines, the tracks of the teeth in the land through which they pass, are about six or seven inches apart; and if they be arranged in two rows directly across the length of the machine, no two adjacent teeth can be further apart than double this distance. This is the case in Biddell's scarifier, in Finlayson's harrow, and in Barrett and Exall's cat's-claw drag; but there is ample experience, that an arrangement allowing more room than this is often necessary, always beneficial. When the surface of the ground, and the stubble or grass it carries, is wet, the paring teeth will clog, if they are not more than twelve or fourteen inches apart; and where the land is full of couch, that distance is not sufficient to allow the passage of teeth so near. In the Uley cultivator, accordingly, in Ransome's Indian cultivator, in Kirkwood's grubber, and in almost all other machines of the kind, excepting those named above, the teeth are arranged, either in three rows, with sufficient intervals between them, when the minimum distance between adjacent teeth is, of course, three times the width of the teeth tracks in the ground; or in two rows as before, but inclined to the direction of motion, so that each shall be not abreast, but in advance, of that in the same row with itself. In the five-tined form of the Uley cultivator, accordingly, where the tines are arranged in two parallel rows, one containing three teeth, and the other two, both very much inclined to the direction of motion, the distance between any two adjacent teeth is four times the distance between the tracks in which they move. There is one difficulty, however, connected with this mode of facilitating the passage of the machine—that the machine is then very apt to work sideways upon the edge of the land it is stirring. The tines may be arranged symmetrically on either side of the longitudinal axis of the machine; and the fact that the half of them on the land side meet with more resistance than the others,

may be true of all the different kinds of this machine alike; but their arrangement in two oblique rows extending forwards, as from the right hand to the left, certainly does increase the tendency thus to lose its even forward motion, whenever it is working on the edge of unstirred land to the right. I am not aware, however, that this is of material consequence, except when the implement is used as a paring machine on a tolerably hard surface; but certainly, in such a case, the soil is often seen in long strips of unmoved surface, whenever any unusual resistance to a forward motion has had the effect referred to, of turning the nose of the framework in towards the unworked land, so as to make the two rows of teeth travel more evenly, each in its own track. To avoid this, it needs that the machine teeth be arranged in transverse rows, as in Biddell's and Finlayson's scarifiers; and to avoid too close a neighbourhood, they may be placed in more than two rows. Something like this is the plan adopted in the case of Kirkwood's seven-tined grubbers, where the two front teeth alone are so near as double the interval between their tracks; all the others being considerably further apart, as is seen in the drawing of the machine in Plate VIII.

It now remains to describe the various ways that have been adopted of lowering and lifting the framework to and from its work; for while this is not an essential part of the implement, it is of considerable importance, both as affecting the ease of working it, and as, more than any other particular connected with it, determining the shape and appearance of the machine.

In the figures below, a number of elevations are given, including Finlayson's harrow, as originally constructed, Scouler's improvement upon it, Kirkwood's grubber, Biddell's scarifier, Ransome's Indian cultivator, Smith's scarifier or cultivator, and the Uley cultivator.

The first, fourth, and seventh of these, differ from the others; the two former, in requiring at least two operations to effect the thorough elevation of the framework, and the last, in effecting it, not by a lever, but by a worm and wheel; and so far as this part of their structure is concerned, all these must be held to be inferior to the others, in which the position of the framework is altered at one operation, by means of a single lever. In order to explain the mode in which this operation is effected, it will be seen, that in all the figures given, *a* and *b* are two points of fixed height above the surface of the ground, resting, either directly or indirectly, upon the axes of the hind and front wheels of the machine. Now, to take each imple-

ment in succession:—In Finlayson's harrow, Fig. 247, the depression of the handle, which is a lever having *b* as a fulcrum, raises *d*, a point in the framework to which its further extremity is attached, and thus the front part of the machine is lifted out of the ground; the first row of teeth may thus be elevated, and the points of both rows raised sufficiently, to allow of the machine being

turned with facility at the headland, in order to commence another furrow. If, however, it is to be carried along roads, or out of the field altogether, the frame must be raised parallelly, and both rows of teeth must be entirely lifted out of the land. This is effected by the racks rising from the hind wheels, on which the framework there rests, and up which it may be lifted on either side by the

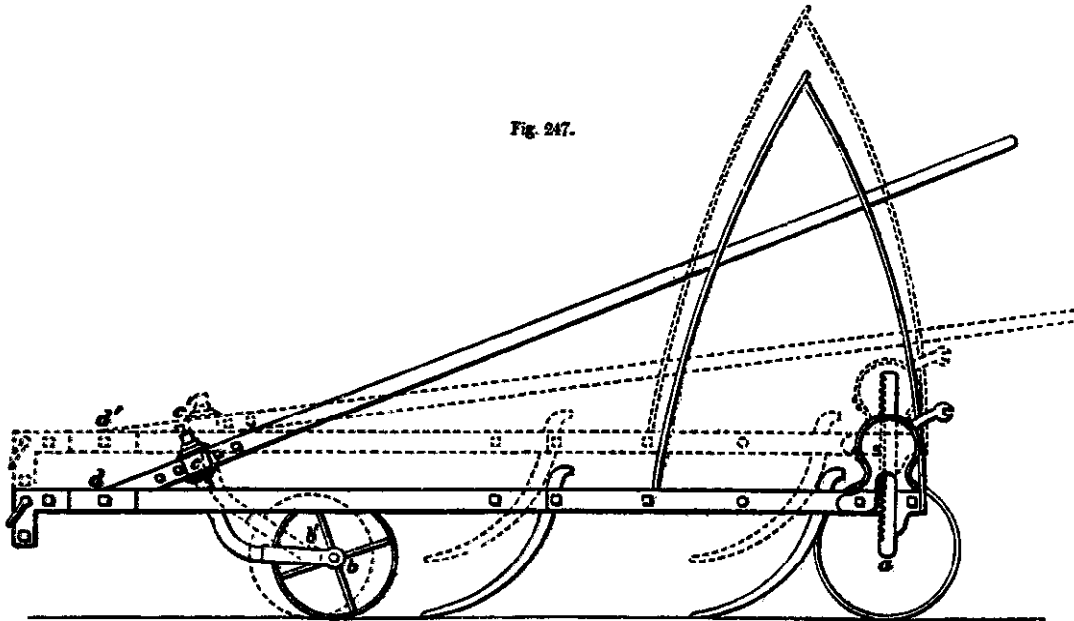

Fig. 247.

toothed wheels working into these racks, which are brought into action by the use of the spanner shown in the figure.

Mr. Scouler's improvement of Finlayson's implement is shown in Fig. 248. For its somewhat cumbrous mode of raising the framework, there

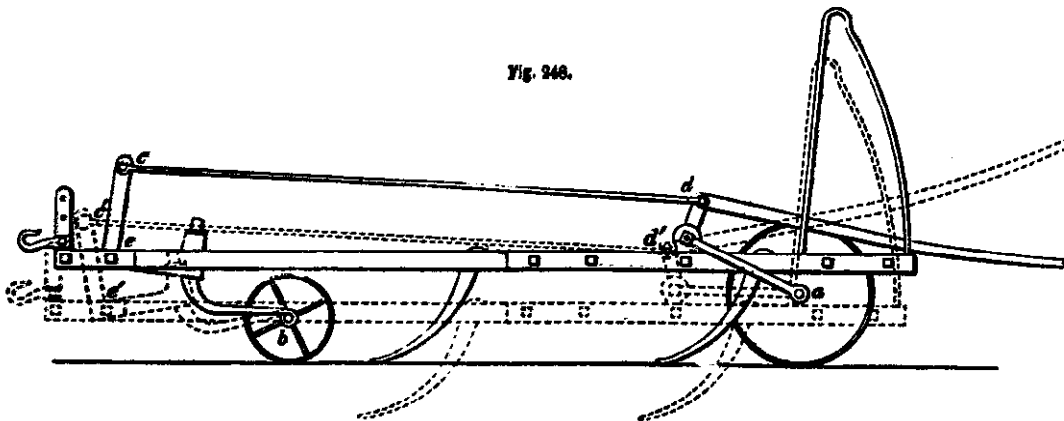

Fig. 248.

is substituted a single operation by the lever handle. In front, *e*, a point in the framework, has been raised from *e* by the angular movement of *c* around *b*, produced by the depression of the lever handle; the angle *ceb* being rigid, and *b* being a fixed point as regards its height above the surface

of the ground, *e* is necessarily lifted in proportion to the sine of the angle described. Behind, again, the framework is, by the same depression of the lever handle, raised; *d*, a point in the latter, being raised from *d*' by its angular motion around *a*, just as *c* is raised by its motion around *b*; the

rod $d c$ serves to connect these two portions so as to produce them both by one operation; and the lengths of $a d$, $b c$, are arranged relatively to the proportions in which they are respectively divided by the framework at its points of attachment to them in front and behind, so that these points are equally elevated by any given depression of the lever handle, and thus the framework moves paral-

lelly up and down; its position, at any particular height, being determined by that of the lever handle in question; and that is held in any required position by a series of notches in the loop above it, Plate VIII., into any of which it may be fitted.

In Kirkwood's grubber, Fig. 249, the process of elevation is produced in a more complicated manner. The front is lifted as in the two machines

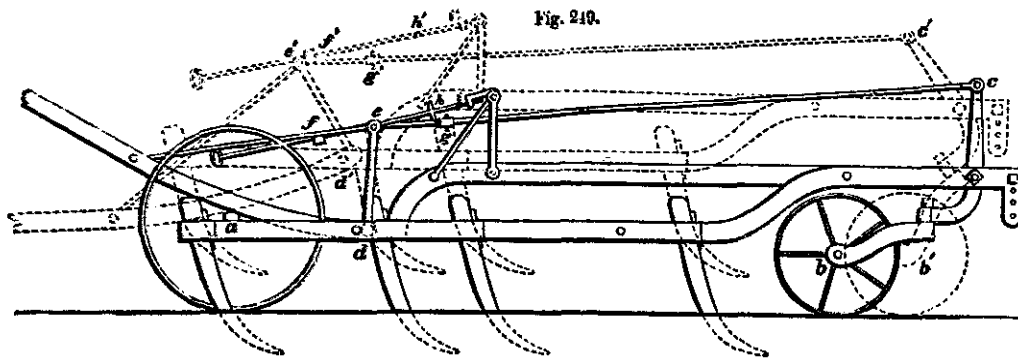

Fig. 249.

already described; c is lifted to c' , carrying the framework with it, by its angular motion around b , produced whenever, the lever handle being depressed, e is made to move around a , and so to pull the rod $e c$ towards it; and at the same time that this is being done, d is lifted to d' , and thus the hinder part of the framework is lifted too. The fact is, $a d e$, or $a d' e'$, is a rigid triangle, and when the handle is worked over the fulcrum a , d and e necessarily move with it; the former,

from its position, being simply lifted, and the latter, being at the same time pulled backwards, and thus made to act upon the leverage in front. When lifted to the position of the lines in the dotted figure, the weight of the machine tends to depress d' , and make $e' d'$ revolve about a , thus pushing e' forward; any contrivance, therefore, which would check this forward movement in e , would keep the machine up. We have such a contrivance in the handle f , or f' , which turns

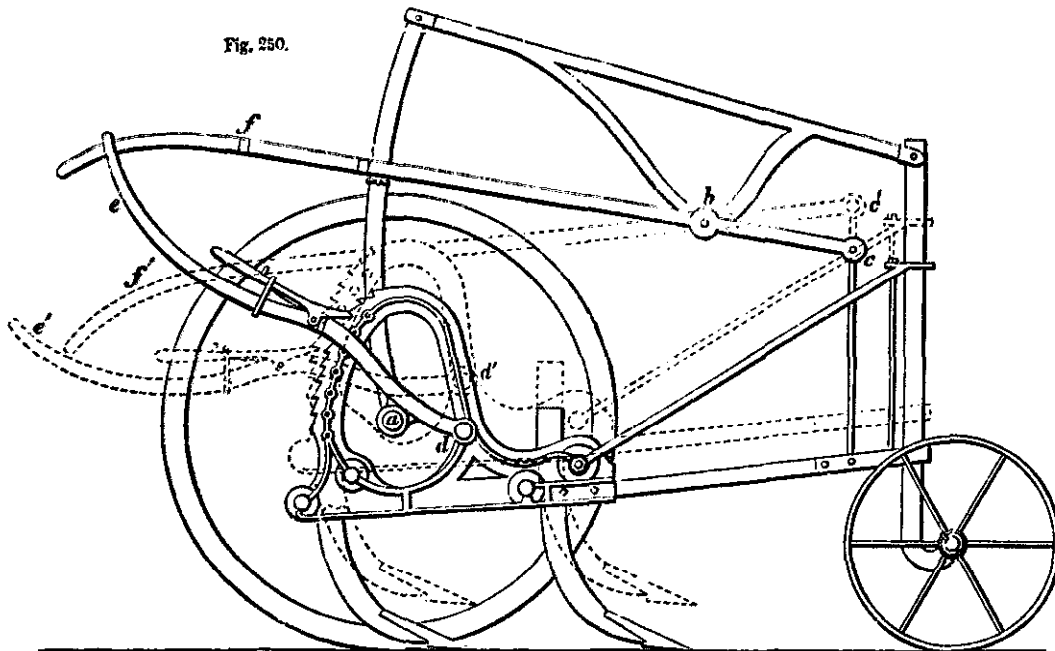
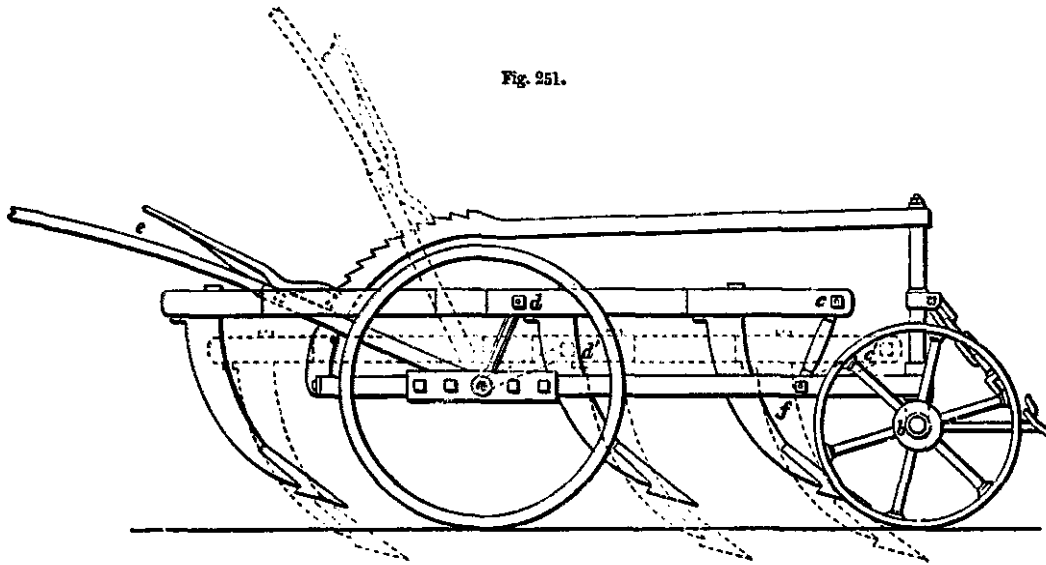

Fig. 250.

around the extremity *i*, or *i'*, connecting it with the framework, and carries a bolt at *f*, which, when *e* is pulled far enough back in the lifting of the framework, may shift in front of it, thus forbidding its approach towards *i*, without which the machine cannot be lowered. Another catch, carried by *f*, and represented at *h*, *h'*, is used to hold the machine down when at work, so that the teeth shall not rise over an obstacle; and this it does, when turned behind the bolt *g*, by hindering the backward motion of *e* or *g*, without which, no rise of the framework, independently of the wheels, is possible.

There yet remain four forms of framework to describe. In Biddell's scarifier, Fig. 250, *a* and *b* are fixed; the lever *f*, acting over the fulcrum *b*, lifts *c*, and with it the front part of the machine is raised, which, as in Finlayson's harrow, is all that is needed to enable it to turn on the headland; and the levers *e*, one to each of the hind wheels (see Plate VI.), acting over the fulcrum *a*, lift *d*, a point towards the hinder part of the framework; *c* is thus lifted to *c'*, and *d* to *d'*. The whole framework is lifted parallelly, and the teeth are thus raised altogether out of the ground.

Fig. 251.



In the Indian cultivator, Fig. 251, the process of elevation is effected by one motion. There are two frameworks; one connecting the wheels, and the other, within the former, carrying the tines;

Fig. 252.

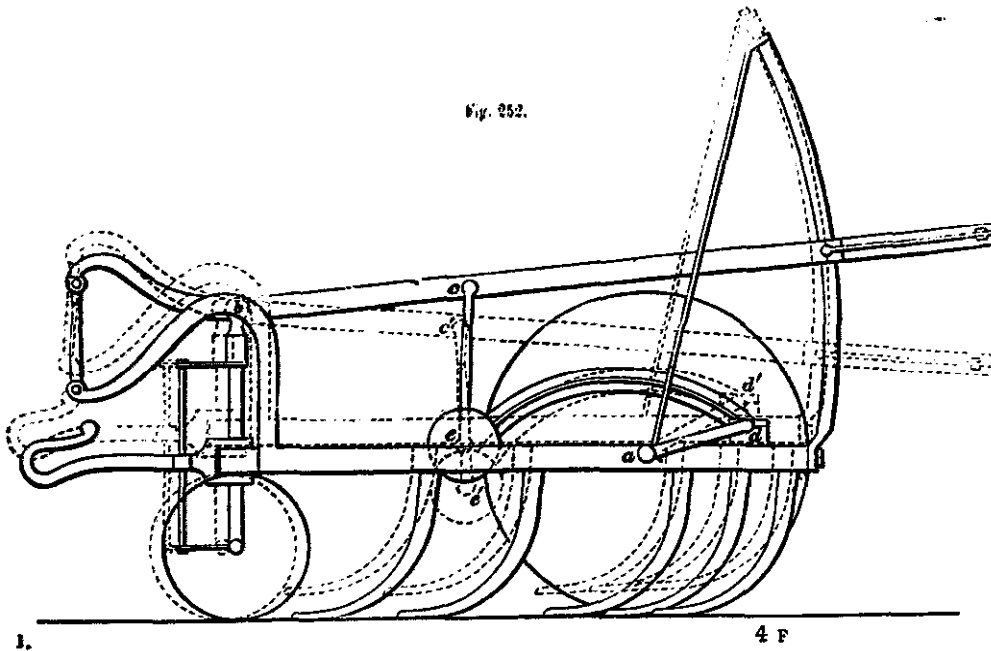

and the two are connected by arms of equal length, just as the parts of parallel rulers are connected. Lift one part of the tine framework, and all must be equally lifted, just as in the case of the instrument alluded to; d is lifted by the rigid angular lever $e a d$, working over the fulcrum a , and so every other point in the tine-framework rises too; as represented in the figure, e' has been depressed to e , and so d' , working around a , has been raised to d ; and c' , working around f , has been raised to c .

Smith's grubber, as shown at the annual meeting of the English Agricultural Society at Northampton, is an instance of a method of lifting such machines, considerably more cumbrous than that just described. Here, Fig. 252, a and b are fixed points; the depression of c , by the lever handle, lifts the framework in front, to which that

lever handle is attached by its extremity beyond b ; and e being depressed by the same movement, the other end of $e d$ is raised; $e d a$, in virtue of its rigidity, being considered as a lever acting over the fulcrum a . A considerable weight of metal is collected at e , in order to balance, in some measure, the weight of the machine hanging at d , which tends by its weight to lift e , and therefore to render the depression of the lever handle more difficult. This certainly appears a clumsy method of assisting the operation of lifting the teeth out of work; a constant increase of draught is inflicted throughout the length of the furrow, in order to diminish the labour of the workman for one minute at the end of it.

In the Uley cultivator, Fig. 253, which, along with Ransome's Indian cultivator, and Scouler's

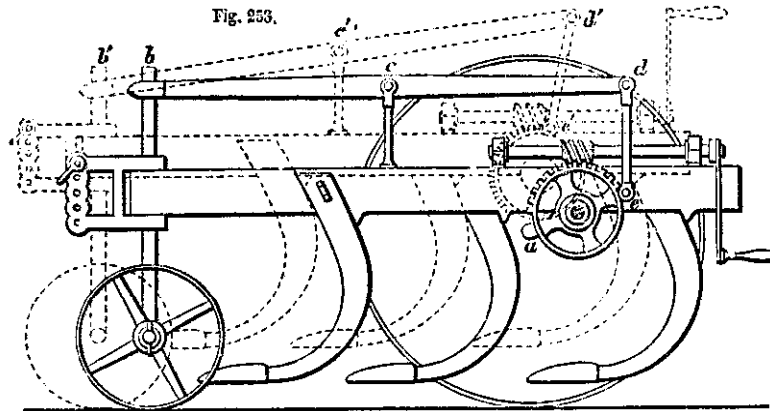

Finlayson harrow, I cannot but think among the neatest and most efficient implements of its class, the framework is lifted by the action of the worm and wheel, shown in the figure. The handle being turned round, e is made to revolve around a , which is the axle of the hind wheels; and for every inch it is thus raised, the framework, to which the centre of the wheel between a and e is attached, is raised half an inch *there*; and d being raised an inch along with e , c , a point midway between the extremities d and b of the lever $d b$, is also raised half an inch, and so the framework rises half an inch in front also. Perfect parallelism of motion is thus very simply and elegantly obtained; the only fault characteristic of the process arising from the length of time needed to conduct the two or three revolutions of the handle which are required to produce the effect, when compared with the single depression of a lever handle, which, in the other cases, is all that is needed.

Besides the cases mentioned, other contrivances of this kind might be alluded to; as, for instance, a singular method devised by Mr. Evan Thomas,

of Welshpool, which received the approval of the judges at the Shrewsbury meeting of the English Agricultural Society; and that adopted by Messrs. Barrett and Exall of Reading, shown in Plate VII.; where, besides the general arrangement for lifting the whole framework, the means exist for moving every separate row of teeth independently of the others, in case it should be needed to free them of any accumulation of weeds when at work.

The reader will perceive, from the drawings, which of these machines are made of cast and which of wrought metal. The Uley cultivator and Biddell's scarifier are wholly cast; the advantage obtained is cheapness; and it is urged against the merit of lightness, in which the wrought-iron implements excel, that weight is an advantage, whenever it is desired that the thorough stirring of the ground be effected. But this cannot be considered sound argument—the necessary strength must of course be provided, but it is attainable with a less weight of material in a wrought than in a cast-iron implement;

and we should depend upon the form of the teeth for the hold the instrument shall take of the land, not upon the weight forcing them in. The advantage which a cast-metal implement has, in the neighbourhood of the foundry—in broken parts being easily replaced—will, of course, occur to every one; but this is balanced by the advantage, on the other side, possessed everywhere else, in breakages being easily capable of repair by the village blacksmith. Certainly, the weight of the machine is a very considerable tax upon the horses. The draught, when not at work, of a machine weighing four or five cwts., resting on narrow wheels, and sinking in the soft ground, exhausts a considerable proportion of the strength of one horse; and to this, among other things, must be attributed the fact, that Scoular's form of the Finlayson five-tined harrow is as easy for two horses, as the Uley cultivator is for three. Excepting, however, where the land is very hard, or very foul, a five-tined cultivator is quite under the command of two strong horses.

It would appear, then, that the only other particular needed to enable a judgment of the relative merits of these machines is, the price at which each is charged, and we subjoin the list, as given in the *Catalogues* of the English Agricultural Society:—

Uley cultivator, five-tined, £10, 10s.; if made with wrought iron, from £12 to £13, 13s. The seven-tined (cast-metal frame) cultivator costs £12, 10s.; if made of wrought iron, from £14 to £18.

Scoular's improved Finlayson's harrow, five-tined, £7.

Smith's grubber, used with five, seven, or nine equidistant tines, at will, £15. When made only for five or seven tines, £10, 10s. (Wrought iron.)

Biddell's scarifier, seven-tined, £18; nine-tined, £21.

The Indian cultivator, £14, 14s.

Kirkwood's grubber, £8 to £10.

Finlayson's grubber, £8, 8s.

The following is the list of prizes which implements of this class have received from the judges of the English Agricultural Society, at the different annual meetings of that body:—

At OXFORD—Messrs. Ransome received the gold medal for their machines, and “especially for their chaff-cutting machines, and *Biddell's scarifier*.”

At LIVERPOOL—The Earl of Ducie received £15 for the *Uley cultivator*, and Messrs. Ransome £10 for *Biddell's extirpating harrow* (scarifier).

At BRISTOL—Messrs. Cottam and Hallen, of Oxford-street, London, received a prize of £5 for a *light scarifier*.

At DERBY—The *Uley cultivator* and *Biddell's scarifier* were selected from the others, for subsequent trial.

At SOUTHAMPTON—The Earl of Ducie received £10 and a silver medal for the *Uley cultivator*.

At SHREWSBURY—The Earl of Ducie received £10 for the *Uley cultivator*.

At NEWCASTLE—Mr. Crosskill of Beverley received £10 for the *Uley cultivator*.

At NORTHAMPTON—Messrs. Sharman and Co. of Willingborough received £10 for *Biddell's scarifier*.

At YORK—Messrs. Sharman and Co. again received £10 for *Biddell's scarifier*.

At NORWICH—Messrs. Ransome received £10 for *Biddell's scarifier*; and Messrs. Smith of Stamford received £10 for *Mr. Smith's cultivator*.

The judgments here recorded were, in great measure, of course, determined by the nature of the work done by the different instruments on the several occasions, and necessarily varied considerably, according to the condition of the land on which the trials were made; and so they seem to have oscillated pretty evenly between *Biddell's scarifier* and the *Uley cultivator*. At the last meeting of the Society, the large machine of Messrs. Smith obtained a prize along with the former of these implements, the judges observing, “it is a very effective implement, either as a scarifier or a grubber;” that is, either for surface or deeper operations. But it certainly seems reasonable to suppose, that a lighter machine than any of those named, if strong enough for ordinary work, would be an improvement upon all; and if makers, preserving sufficient strength, as well as the shape of tine, in Scoular's *Finlayson harrow*, with the higher framework, and better arrangement of tines, characteristic of the *Uley cultivator*, the result would be preferable to any form of the machine now in existence. It certainly is very desirable that the attention hitherto worthily paid to this class of implements be maintained, with a view to their continued improvement. The cultivator is probably among the most important of agricultural machines. Its work is, in many cases, a perfect substitute for ploughing, and, in some, an improvement upon it; while it does not involve above one-third of the horse labour per acre which the other requires; and this alone is sufficient to maintain its position of usefulness among the implements of the farm.

There is another class of implements which, like the cultivator, operate partly by the stirring they give to the soil: they include the Norwegian harrow of Messrs. Stratton of Bristol; the spiked clod crusher of Messrs. Barrett of Hull, &c.; but these must be referred to under the articles HARROW and ROLLER.

GRUBBER

from

“The Book of the Farm”

Henry Stevens, Second Edition, 1855

2417. But when the land cannot be sufficiently impressed by the harrows, recourse should be had to the grubber, which is a much better implement, in every respect, than the brake-harrow. Fig. 215 is a view, in perspective, of Kirkwood's grubber,

Fig. 215.

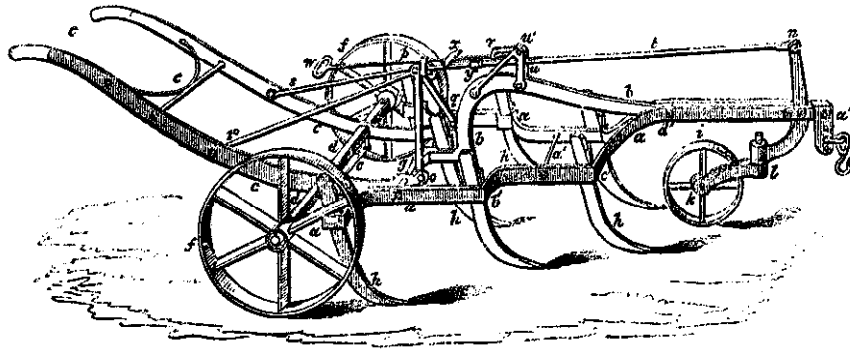

KIRKWOOD'S GRUBBER.

which I consider a good implement of its class, as well in the execution of the work done by it, as for the facility with which the tines are taken out and let down again into the soil. This grubber may be considered as consisting of two parts, the tine-frame, and the carriage with its wheels and handles, the two being connected by means of the apparatus for elevating the tine-frame, and by a joint-rod which is common to both, the whole being constructed of malleable iron, except the wheels. The tine-frame is *a a*; the muzzle *a''* is provided with several holes, in which the draught shackle and hook can be attached, to regulate in some degree the tendency to earth. The beam *b b* is bent upwards at *a'*, above the frame *a*, for the purpose of receiving the bridle *u u'*. The tines, of which this form of the implement contains 7, *h h*, &c. are bent at the point as in the figure, with a slight tendency to *earth*, and are flattened

out at the point; and they are secured at any required degree of earth by an iron wedge to each tine.

2418. The carriage consists of the axle *d d*, on which are mounted the two handles or levers *c c*. The levers are perforated for the joint-rod *g*, the position of which in the tine-frame is such as just to allow the extremities *o* to pass the axle when the frame is being raised or depressed. The levers extend backward, and terminate in sockets into which wooden helms are inserted. The carriage is supported on the hind-wheels *f f*; and the fore-part of the frame on the castor-wheel *i*, with its shears *k l*, and crank-lever *l n*. The connexions between the carriage and frame also form the elevating apparatus, by which the tine-frame is moved up and down in positions always parallel to the horizon.

2419. In working the machine, it is requisite that the conductor have it in his power to regulate and preserve a uniform depth for the tines, and to be able to withdraw the tines from the earth. To accomplish this part, the connecting-rod *t* has small mortices in it, to the number of 6 or 8, at very close intervals. A nut or slide-box *y*' is fitted to slide easily upon it; and it can be fixed at any point by dropping a pin through this and any required mortise. The bridle *u u'* consists of two similar parts. The handle *v x w* is made of such length as will bring the eye *w* within reach of the conductor—but it can be shortened or lengthened at pleasure; and this is done to make the cross-head fall *h* behind the end of the connecting-rod when the tines are in the ground, which thus lock them that they cannot rise out of the ground, although, from any malformation of the tines, they might have a tendency to do so were this lock not applied. But while the tines preserve their due form, the lock is not required. A prolonged screw-nut at *p* is also put upon the handle; and when the tine-frame is raised out of the ground for travelling, the nut is adjusted to fall in before the checks of the

stays at *p*, and thus keeps up the tine-frame without the continued aid of the conductor.

2420. *Ducie's Grubber*, or cultivator, the production of Earl Ducie, is based, in its construction, on the improved form of Finlayson's and of Kirkwood's grubbers. In this cultivator we have the high wheels raising the tine-frame to a height above the surface of the ground that must greatly prevent the choking of the tines in foul land, by the accumulation of roots about their neck; and this is further secured by the curvature which they possess. The castor-wheel in front, being double, is an improvement on the crank-lever and shears, and decidedly superior to them; and the apparatus for elevating the tine-frame exhibits a fine mechanical taste, though the application and arrangement of the screw, the wheel and axle, and the levers to effect the purpose, is perhaps an example of too much elaboration for the particular case.

2421. Fig. 216 is a view in perspective of this implement. It consists of a frame *a a*, which carries five tines *b b*, &c., with

Fig. 216

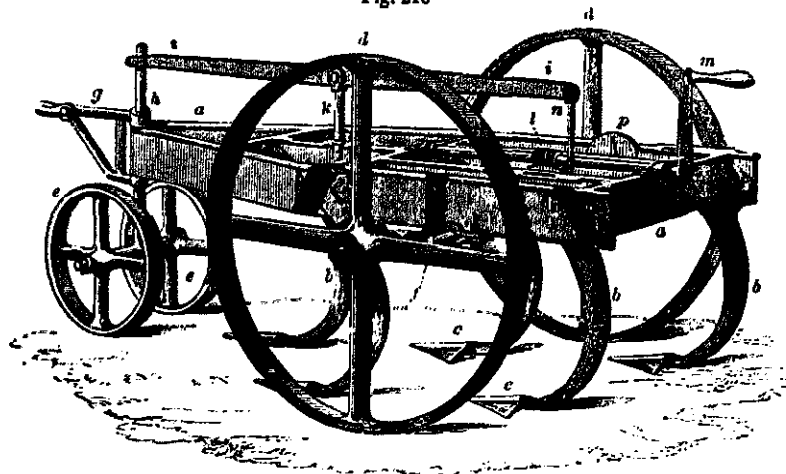

THE DUCIE CULTIVATOR.

which the machine is armed. The frame thus constructed is mounted on two high wheels *d d*, which support the body of the tine frame; and the front or apex of the frame is supported on the double castor-wheels *e e*, which are mounted on a reversed T-form axle, to the stem of which

h, the draught-shackle *g* is applied in a permanent position, so that the shackle and stem shall turn together, and, by consequence, the wheels also, forming thus a castor-wheel of the most perfect description. The elevating and depressing of the tine-frame is accomplished by a very

beautiful combination of parts. When the tine-frame is to be raised, the winch-handle *m* is turned, by a sufficient number of revolutions of the screw *l*; and by reversing the motion of the winch-handle *m*, the frame is lowered—and these movements will be made with perfect accuracy, preserving to the tine-frame a correctly horizontal position at any height within the range of its lift. An index is attached to the main axle as seen at *p*, which is divided in the proportion of inches in depth of the penetration of the tines; but this is one of its least important points.

2422. The weight of the cast-iron grubbers may be averaged at 10 cwt., and their price at £15.

2423. The action of any of these grubbers in the soil is to stir it effectually as deep as their tines descend, and at the same time retain the surface soil in its existing position—an operation which bestows the softness of a ploughed surface, whilst it preserves the original upper surface dry, which the plough cannot do. This advantage is especially appreciated in early spring, when it is precarious to turn over the soil with the plough; and should rain follow, the land would be easily made much wetter, and worse to work with any succeeding implement, than if it had not been ploughed at all.

STEERAGE HORSE HOE

from

“The Book of the Farm”

by

Henry Stevens

4100. There are many forms of horse-hoes for cleaning the ground between the rows of corn, and perhaps not one displays so much ingenuity of construction as that of Messrs Garrett & Sons, Leiston Works, Suffolk; but as its construction necessarily enhances its price, I have seen no cheap one please me so much as the steerage horse-hoe contrived by Mr William Smith, Northampton. It is shown in perspective in fig. 353, where *a a* is the framing, which also constitutes the horse shafts, supported on iron brackets, which in their turn are supported on an iron axle, *b*, as high as to permit the crop hoed to pass under it. The axle, bent down at both ends, works in the wheels, *c c*. These form the carriage portion of the machine. The hoe consists of a bar *d*,

Fig. 353.

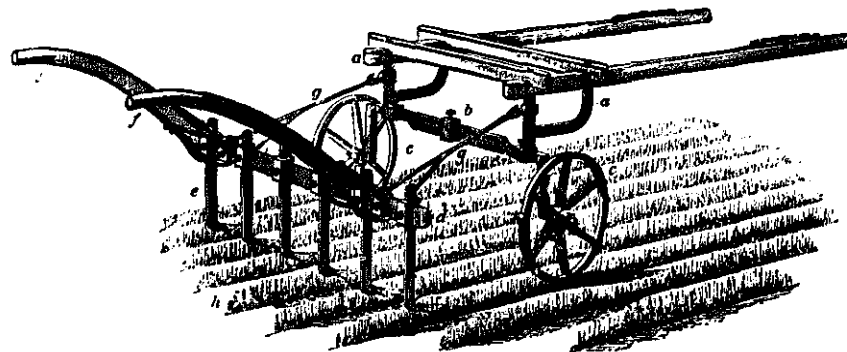

which bears the shanks *e*, of six triangular duck-footed hoes, or shares, made to embrace as many rows of corn, at the ordinary breadth of 7 inches asunder. The handles, *f f*, by which the driver guides the hoes along the centres of the rows, are attached to the bar *d*. The carriage and hoe are connected by means of the rods *g g*, which, at one end, are attached to the handles *f*, and at the other linked on by eyes to hooks in the hind part of the brackets, which support the framing or shafts *a a*. The rods *g* are strengthened by others, passing under the bar *d*, and welded at both ends to the under part of *g*. When the rows are placed wider than 7 inches, the axle is expanded to the requisite width by being slipped outwards through the collar, and fixed at any given width by the pinching screw at *b*.

4101. Fig. 354 represents two differ-

Fig. 354.

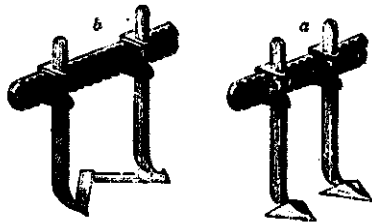

LONG AND SHORT SHARES FOR THE HORSE-HOE.

ent sorts of shares used in this hoe, one *a*, being the ordinary one for narrow rows of 7 inches; the other, *b*, to answer the broadest width of 18 inches. The latter consists of a long rectangular feather attached to each shank placed in a diagonal direction across and meeting in the centre of the drill. The inclination of their edges allows the shares to clear themselves of the soil while they are cutting the weeds under the surface. Having the bar *d* as long as the width to which the axle may be expanded, the requisite shares might then be affixed to it, required to hoe the number of rows determined on—and thus the hoes may be increased in number from 6 to 12, and the breadth hoed from $3\frac{1}{2}$ to 7 feet; but from 4 to 5 feet in width is the best one for doing the work quickest and most effectually. To obtain that distance, 8 hoes at 7 inches wide give 4 feet 8 inches; 6 hoes at 9 inches wide give 4 feet 6 inches; and 6 hoes set

at three doubles as *b*, at 18 inches wide give 4 feet 6 inches. The prices of this horse-hoe, at these respective widths, are—with 6 hoes, £4; 8 hoes, £4, 10s.; and 12 hoes, £5, 10s.

4102. In using this hoe, the horse is put into the shafts *a*, fig. 353. The driver holds on by the handles *f f*, and steers the hoes along the centre of the rows *h*, which he is enabled to do by the movement of the rods *g* upon the hooks attached to the brackets at *a*. Should the horse swerve from the row he walks in, the driver directs the hoes in their rows, until the horse regains his former track. A steady horse will not leave the row he is placed in, from one end of the landing to the other, and only a steady one should be employed in such work as hoeing. A steady man, to steer the hoes, is as requisite as a steady horse, otherwise carelessness will send the hoes through the rows of corn plants, and cut them through as well as the weeds.

4103. In 1849, Dr Newington of Knolo Park, near Tunbridge Wells, the inventor of the dibble, fig. 292, introduced to public notice a hoe, which he names a *cultivator*, for weeding and stirring the ground between the rows of corn. It consists of a shaft with a cross-handle at one end, and at the other end a shank, to which is attached a head, into which three or four or more shares are inserted at shiftable distances, corresponding with the width of the rows to be hoed, from four to eighteen inches apart—taking at one time two or three rows of the smaller distances, and one of the larger. The instrument is drawn through the ground by the force of a man, who is equipped in a canvass jacket, to which is looped a belt, by which he draws by the cross-handle. I have not seen this implement at work, but the inventor affirms that “a man can do two acres a-day with great ease; that is to say, stir and hoe an acre, from three to four inches deep, five times for 5s., much more effectually than by the present mode of hand-hoeing, and at one-fifth the expense.”

SCUFFLER & HORSE HOES

from Henry Stevens "The Book of the Farm"

3250. *Horse-hoe or Scuffler.* — The double mould-board plough, fig. 209, is convertible into a scuffling or cleansing plough, or horse-hoe. To effect this, the hinge-pins of the mould-boards are withdrawn, and the mould-boards removed, when the implement represented by fig.

262, is formed; the portions of the beam and handle being cut off, and the remaining portion of the beam is *a*, and of the handles, are *b b*, exhibiting also their junc-

Fig. 262.

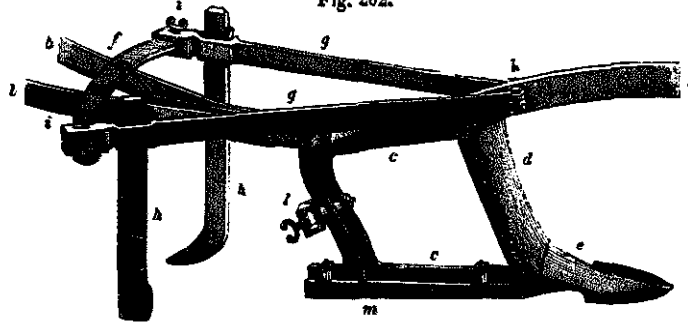

THE BODY OF THE DOUBLE MOULD BOARD ALTERED TO A SCUFFLING PLOUGH.

tion with the tail of the beam. The body frame *cc* is of an irregular rhomboidal form, whereof the front bar *d* forms the shield, and the lower bar, the sole-shoe *m*. The two wing bars *gg* are jointed to a stud that projects from the beam on each side at *k*. A quadrant bar *f* is attached to the two stilt bars at *f*, and the ends of the wing-bars, having a mortise formed to receive the quadrant, are moved upon this to any required width, and secured by the screws *ii*. A second mortise is punched in each wing-bar to receive the scuffling coulter *h h*, which are thinned off to a knife-edge in front, and bent inward below till the points stand 6 inches to the right and left of the shanks. A double-feathered share *e* is fitted to the head *d* of the body-frame, which completes this simple horse-hoe, and the change from the one state to the other is effected in a few minutes, for, in return-

ing it to the double mould-board state, it is only necessary to remove the scufflers *gg* and *h h*, and the feathered share *e*.

3251. The effect of this horse-hoe in the soil is to loosen the earth between the rows of drills, or, if foul, to under-cut all the weeds that exist in that space, or to such breadth as the two scufflers *h h* may be set; the upright part of these coulter performing a species of paring along the sides of the two contiguous rows. If the land is in good order, and tolerably clean, stirring it with this scuffler will be sufficient; but if overrun with weeds, one or other of the drill-harrows or grubbers will be found necessary to prevent a re-vegetation of the weeds.

3252. Fig. 263 exhibits Mr Wilkie's horse-hoe with parallel motion, in which

Fig. 263.

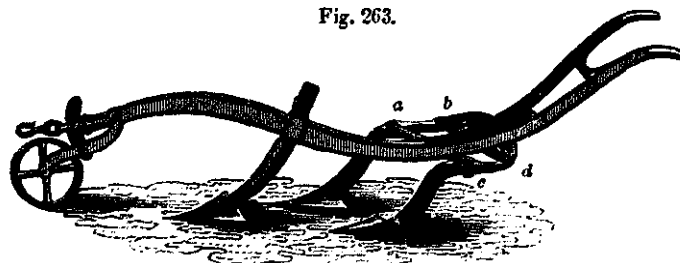

WILKIE'S HORSE-HOE WITH PARALLEL MOTION.

the two back tines have their tails jointed, at *a b c d*, to two transverse parallel bars, which traverse to a small extent upon

pivots placed in the middle of their length, attached to the tail of the beam. By the motion of these, a perfect parallelism of the

tines is preserved, capable of being secured at any required width by pinching-screws. This is the most perfect mode of adjustment for the tines of a hoe of this construction—three-tined—but it does not apply to those of more than three, and is perhaps too refined for a field implement. The self-cleaning form of the tines has been adduced in favour of this implement, but

the form that may be useful in a great field-grubber is not applicable to an implement such as this; for it seldom occurs, and ought never to be the case, that a drilled green crop is so overrun with weeds as to require a self-cleaning tine.

3253. The common drill-grubber, fig. 264, is a light and convenient implement drawn

Fig. 264.

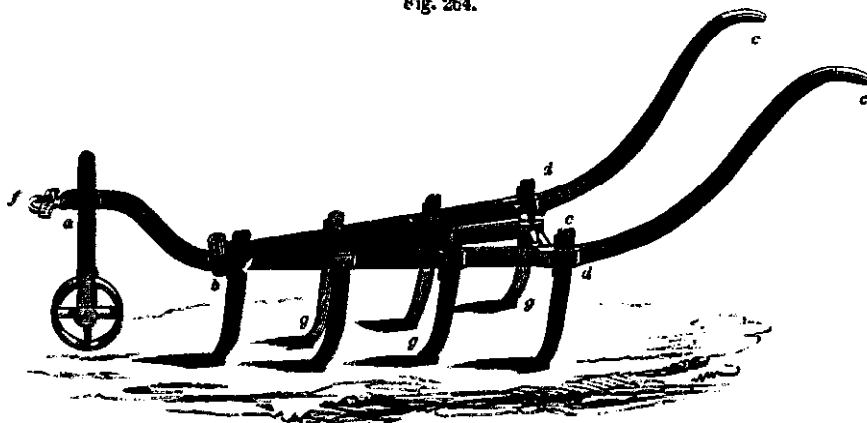

THE COMMON DRILL-GRUBBER.

by one horse. It consists of a central beam *a b c*, the neck part of which is bent upwards, and punched at the front for the passage of the stem of the wheel. The wing-bars *b d*, carry the tines *g g g*, 6 in number, and the central beam carries the front tine at *b*. The wing-bars are each furnished with a quadrant-bar riveted into the wings at *d d*; the tail of the quadrants, passing through the mortise at *c*, are secured by a pinching-screw fixing the wings at any required width. The wing-bars are extended backward, and bent upwards to form the handles *c c*. To the point of the beam is affixed a simple bridle *f* with a cross-web and shackle, giving a small range of yoke right and left. The front wheel, whose office is to regulate the depth of the grubbing, is usually 8 or 9 inches diameter, and the tines *g* are forged with duck feet slightly pointing forward. In many localities this implement is used for all the purposes of horse-hoeing, except the process of paring or of earthing up; and, having cheapness as well as utility as a recommendation, it is very generally approved of. It is, however, subject to variety in the different districts where it is employed: in some it is shortened to 5 tines,

in others lengthened out to 9, and in many cases the tines are plain-pointed. It is frequently also made with the tines standing in a zigzag position; but, except in the second pair of tines, this is of little importance, as those behind the second are sufficiently apart to prevent them becoming choked with weeds. The price of this grubber is about £2, 10s.

3254. In this class of implements, we find a very handsomely constructed one, known as *Wilkie's drill grubber and harrow*, which is represented in fig. 265. This implement is constructed with a beam *a b*, and a pair of handles *c c* attached to the tail of the beam, one on each side. It has no proper body-frame, but is merely a skeleton, the grubbing parts of it being the three tines or coulter *d e f*. The foremost one *d* is set in a coulter-box in the beam, and terminates in a double-spreading feather or duck's-foot point; the two others, *e* and *f*, are continuations of the two wings, which are capable of adjustment by the quadrant-bar *g*. The effect of the tines on the soil is somewhat similar to that of the scuffler, fig. 262, paring and undercutting; but the implement is furnished with an appen-

dage in the attached 6-tined harrow *i*, which completes the operation at one turn. The harrow is capable of adjustment to

depth by means of its suspenders, and to breadth by means of its two small quadrant-bars. The regulation of depth is

Fig. 265.



WILKIE'S DRILL-GRUBBER AND HARROW.

aided by the wheel *l* hung in the shears *n*, which is jointed to the beam at *a*, and to which also is attached a shackle and hook *o* for the draught. The price is £4, 15s.

3255. In stiff soils, the broad-feather shares will with difficulty be kept in the ground; and, from their great length and breadth, will have the effect of consolidating that part of it which they pass over, into a hard crust. The harrow is an important part of the implement, but adds considerably to the draught; and the implement, upon the whole, is too heavy for one horse being able to produce efficient work with it. By lightening the entire structure, and altering the form of the tine, it might be rendered a very useful horse-hoe.

3256. A ploughman is set to work the scuffer, fig. 262, and he takes one of his horses while the other one is resting, each horse working one yoking every day while at this work. On farms having a large breadth of turnips, two scuffers may be thus engaged. As the work of scuffling is easy compared to ploughing, the aged horses, or mares suckling foals, are employed at it. Should the companion to the mare with foal be a horse or a mare without a foal, the mare and her foal are sent to pasture, while her companion works all the day. The steadiest horses, in whatever state they may otherwise be, should only be employed at scuffling, else by unsteady walking the implement may cut up the plants right and left. The ploughman should provide double reins to the horse. In setting the wings of the scuffer, the coulter should be brought to

pare the soil from the plants as near as possible without touching them, and the drier and finer the state of the soil, the nearer they may work to the plants. In rough and damp soil, the clods, raised and disturbed by the coulter, will be apt to fall upon the plants when the coulter is placed too near to them. In scuffling turnips the ploughman requires to be constantly on his guard, to guide the implement in the middle space between the row of plants on each side of him; and on entering and finishing every landing, he should take care that the horse does not turn too sharply upon the head-ridge, and cause the coulter to cut off some of the plants from the ends of the drills. Scuffling admits of walking at the rate of three miles in the hour or more, and is a very expeditious process, when the land is pretty clean.

3257. The scuffling having cleared part of the ground in a yoking in advance, the singling is ready to commence. The implement used for singling turnips is represented in fig. 266, and is named the *turnip-hoe*. It consists of a thin iron plate

Fig. 266.



THE TURNIP OR HAND DRAW-HOE.

a, faced with steel 7 inches in length and 4 inches in breadth, with an eye *b*, attached to its upper edge to receive the shaft *c*, usually made of fir, to make the implement as light in hand as possible. The shaft should not exceed 3 feet in length, though in some parts of the country it is 4½ feet, whilst

CULTIVATORS

by W.J. Malden,

from

"The Standard Cyclopaedia of Modern
Agriculture", 1909

Cultivators.—Improvement in agricultural machinery is as well marked in cultivators as in any class of implement. The past century has witnessed the transition from the wooden frame to the iron frame and to the steel frame, in fact to the all-steel cultivator; while the effectiveness and diminution in draught have been vastly improved, and cultivation rendered more easy and far less expensive. Cultivators are ordinarily regarded as being included in those implements which are used to perform the heavier acts of tillage, and a distinction between them and harrows is that they are generally carried on wheels, whilst harrows are wheelless; the one being carried on a wheeled frame, by which the depth of the work can be regulated, and the other without wheels, relying entirely on its weight to force the tines into the ground. Modern introductions have, however, somewhat disturbed this classification. Different nomenclature is employed in different parts of the country; and what is a cultivator in one, in another may be a scuffle or scuffler, scarifier, grubber, drag, shim, &c., while the smaller or lighter ones are known as wheeled drag harrows, shims, nidyats or nidgets, &c.

The earlier wheeled cultivators, in spite of their wheels, depended largely on the dead weight of the heavy frame to force the tines into the ground, in fact heavy weights were sometimes laid on them to make them face hard work. This was because it was not realized that the pitch or angle of curve of the tine to a great extent controlled the ease with which the tine could enter the ground; in fact that a well-set tine would naturally draw into the soil almost independently of, or at any rate with only a small amount of pressure. Where pressure is depended upon there is necessarily more friction below than where a tine merely draws in, consequently the draught was very heavy. The gradual development of the cultivator is interesting as showing the progress and improvement in mechanical methods and construction. Whereas twenty years ago the common cultivator or drag employed in Wiltshire, Hants, and adjoining counties with chalk soils, was made with a heavy wooden frame, with tines set in holes bored through the frame incapable of being adjusted as to width, and with practically no mechanical aid to alter the wheels to adjust the depth of the tines; with no provision to lift the tines without lifting the whole implement; and with tines which were only very slightly curved to face the work: now the modern spring sickle-tine cultivator possesses powers of adjustment quickly and easily manipulated, with curve tines set so as to avoid under friction, requiring but a small weight to force them or draw them into the ground. Cul-

tivators on better lines than the one first described had, however, been available, and had been freely used in many districts, and some had attained much efficiency. As long ago as 1824, Finlayson brought out a curved tine cultivator on three wheels, the front one having an axle mounted on a bell-crank lever, to raise the fore part, while the hind wheels were raised by a rack and pinion. This may be regarded as the first great stride from the old type. Scouler soon improved this by mounting all the wheels on bell cranks, operating them with one lever. The cranked axle was introduced in 1843. Clay and Coleman and Morton made cultivators which were held in high esteem throughout the latter half of the 19th century; Clay's was light, and the shape and pitch of the tines were distinctly good, and the means of adjusting convenient. This type was copied considerably by other manufacturers, and on the

soil, or for stirring very rough land, though it does good work when land lies in a finer condition; (2) the spring tine, in which a lighter and more vibratory tine is used, and a large number of tines are inserted in a given width; (3) sickle-tine harrows, that is cultivators without wheels, made lighter for finer work. The heaviest cultivators are made with steel tines, giving a certain amount of vibratory action, but the more advanced have a spring attachment to the frame which supplies further vibration and retraction; but the piercing of hard ground is ensured by the spring having a limited yield, so that the tine is brought to rigidity against the frame when this point is reached. A cultivator of this type is convertible into many forms, and with slight alteration of parts, or with additional attachments, may perform many kinds of operations. The points are changeable, and may be used in various widths from plain points

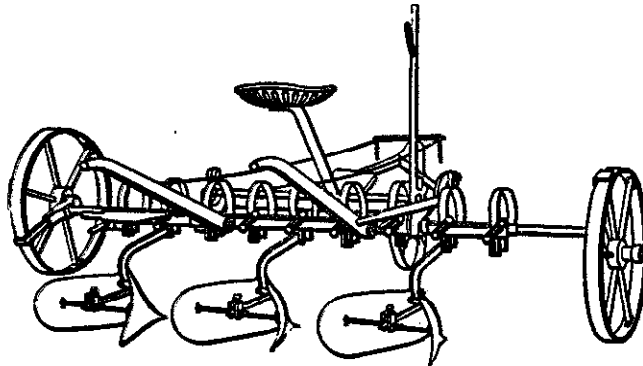

Martin's Cultivator as a Three-furrow Ridger

whole the cultivation was satisfactory. The introduction of the modern sickle tine by Messrs. Massey Harris in 1893, and in more rigid form by Messrs. Howard at the Leicester show of the Royal Agricultural Society, however, opened up a new era in cultivation, and the advantage of this type very quickly became recognized, and now it may be held that in both heavy and light cultivators all other types are superseded. A comparison between the cultivators exhibited not many years ago at the Royal Agricultural Society of England show and those now exhibited, affords a most striking illustration of the rapidity of the change, and is only equalled by the change in type of haymaking machinery which is now in progress. The work done by the tine with a sickle curve differs widely from that of previous shapes, for instead of merely breaking a line through the soil, this form of tine causes the soil to ride up the curve and to be thoroughly inverted; the liveliness of the work from this motion, and from the vibratory action of the spring tine, gives the land a most effective working, and whether applied as a cleaning operation or in the preparation of the seedbed, the result is far superior to the older methods.

The sickle-tine cultivator may be divided into three types: (1) the rigid, or nearly so, which is suitable for breaking up very hard

soil, or for stirring very rough land, though it does good work when land lies in a finer condition; the tines may be altered in position to grub between rows of root crops, beans, &c., and act as horse hoes or plain grubbers; moulding bodies may be attached so as to form three ridgers for potatoes or roots; and a corn box may be added to make an efficient broadcaster: with these attachments a very economical land-working outfit may be secured, securing high efficiency in every section of the work. The lighter forms of wheeled cultivator are generally made in sections, each section being controlled by some form of spring to regulate the pressure on the tines. These

cultivators also can be fitted with points of varying width, according to the nature of the work done.

The Norwegian harrow or double rotary harrow is a cultivator of distinct type. Two barrels or drums, one before the other, are suspended from the frame, which is carried on wheels. The barrels act as spindles placed at right angles to the line of draught; sprockets taking the form of slightly curved tines are thickly placed about the barrels, and the barrels are placed so near to one another that, as they rotate, the tines of one barrel pass through the interspaces of the tines of the other. Rotary motion is given to the barrels as the implement is drawn forward, and both a clod-piercing and soil-stirring action is produced; the teeth on the first barrel are naturally making an upward motion as those on the hinder one are coming down, therefore weeds which have been picked up by the one are cleared off by the other. The implement possesses useful features, but the modern cultivators are generally more serviceable.

[w. J. M.]

CULTIVATORS—I

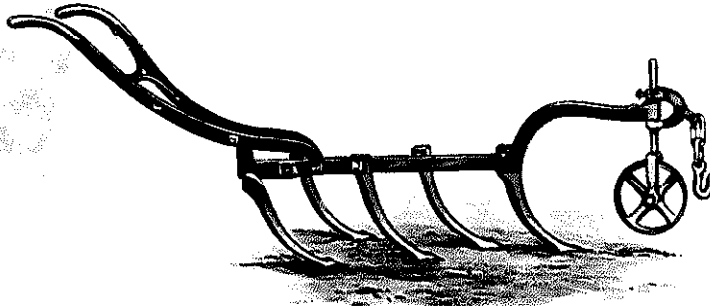

1

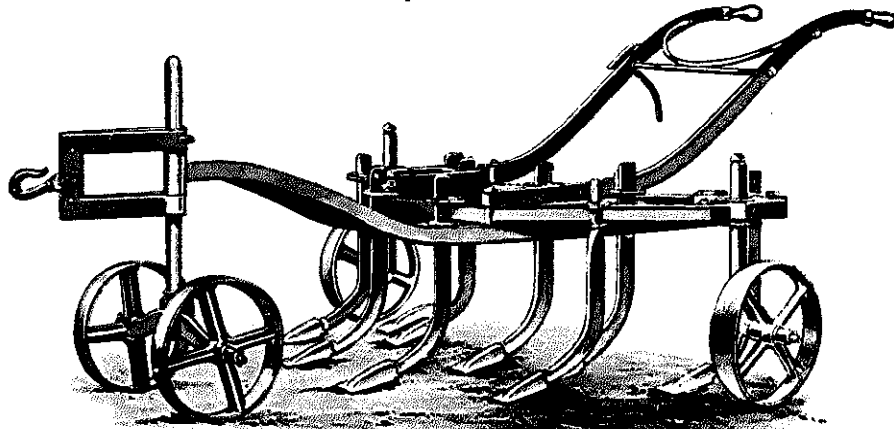

2

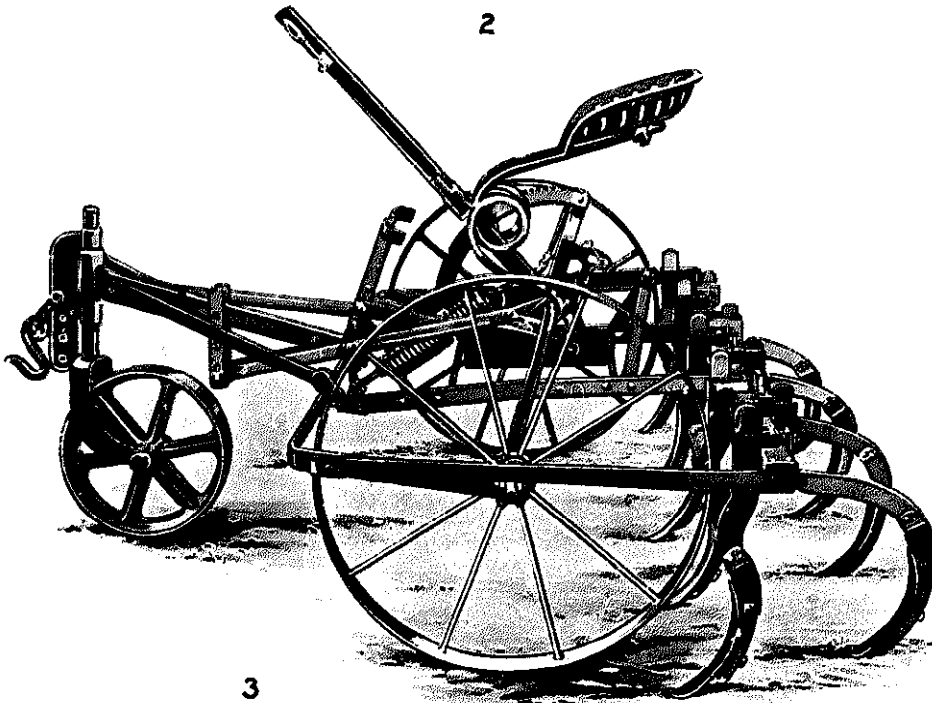

3

1. Jack's Five-tined Drill Grubber. 2. Ball's Scuffer. 3. Wallace's Universal Cultivator.

CULTIVATORS—II

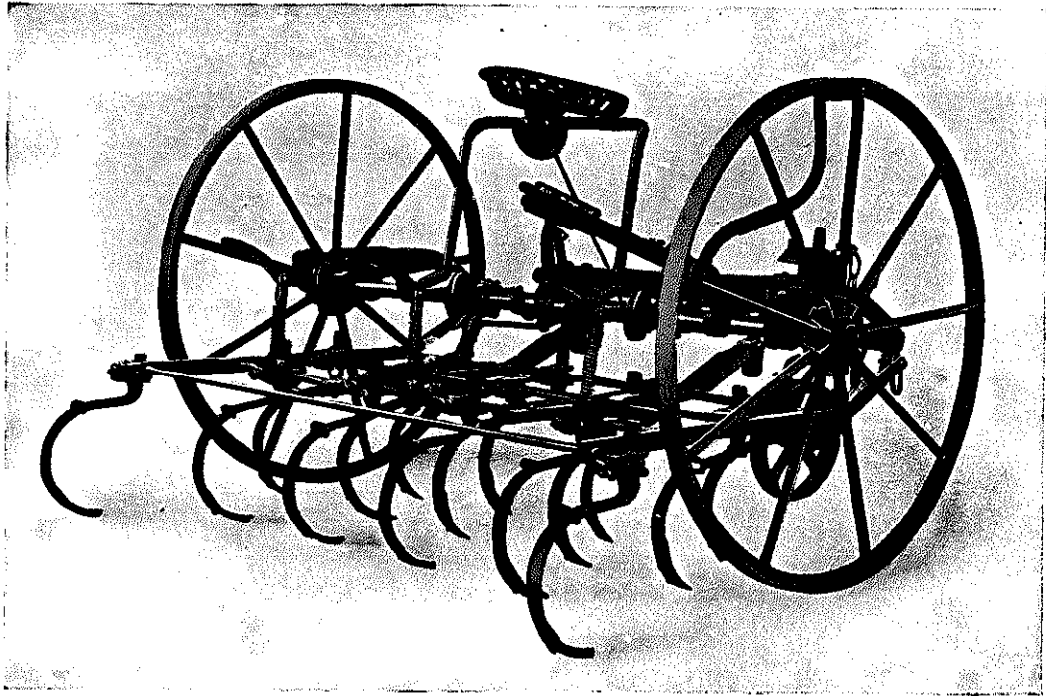

NICHOLSON'S SPRING STEEL TINE "HERCULES" CULTIVATOR
(Heavy Pattern)

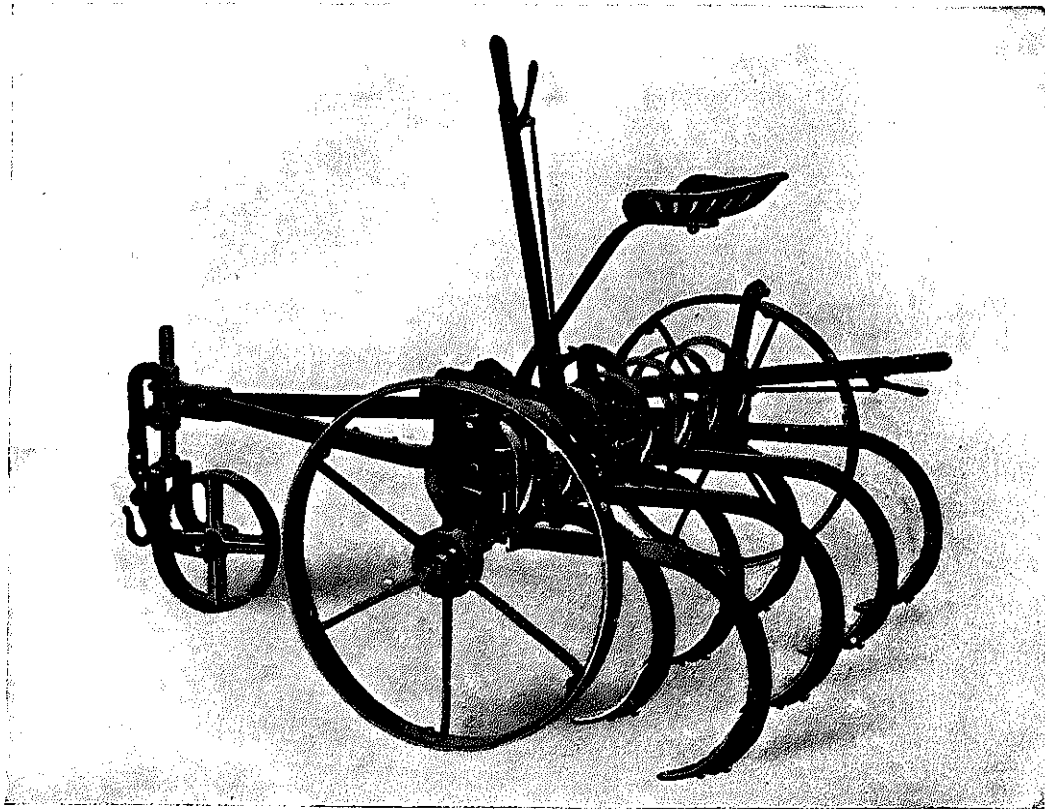

MARTIN'S CULTIVATOR (seven tines)



TYPICAL SUSSEX SCENE.

"The slow, black oxen toiling through the day."

Contrasting styles of implement and motive power used for rolling. The team of oxen are equipped with the old wooden yokes, and the driver and his boy both use goads. These photographs are from the collection at the Museum of English Rural Life, Reading.



HARROWS

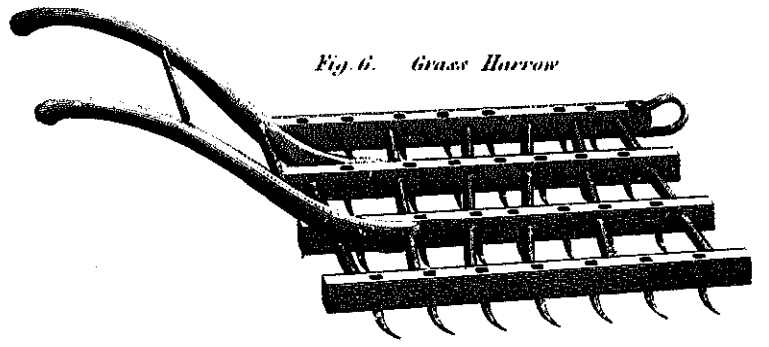
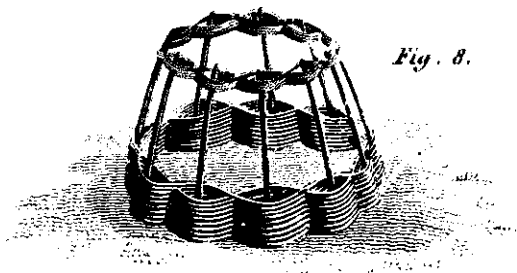
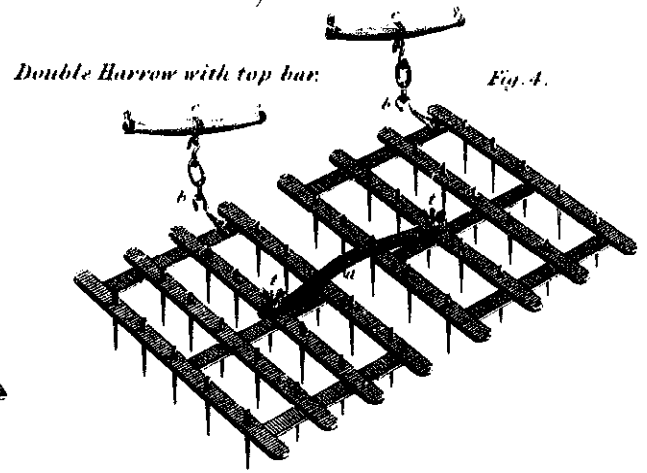
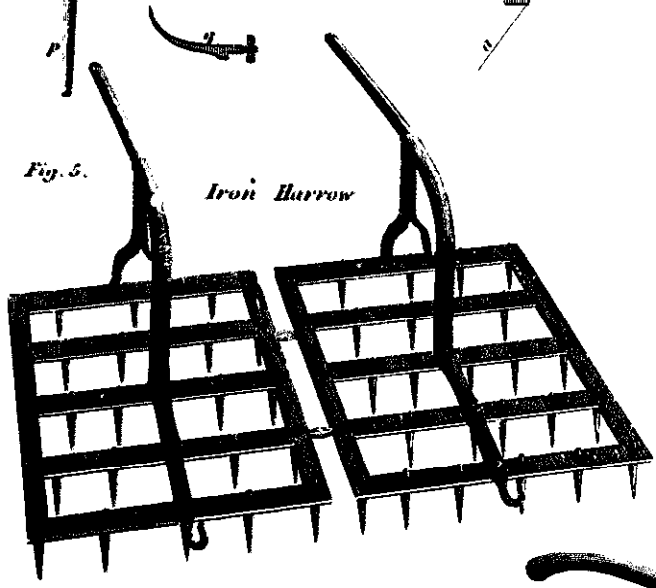
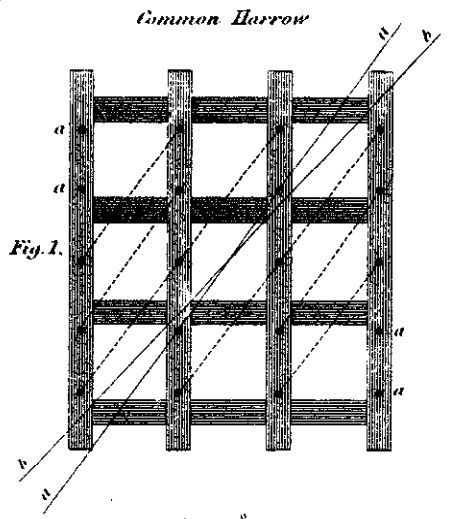
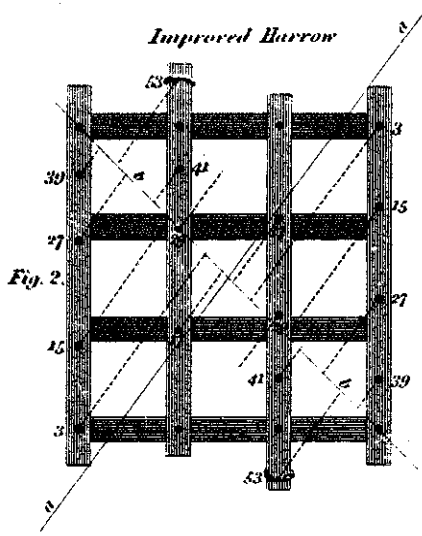
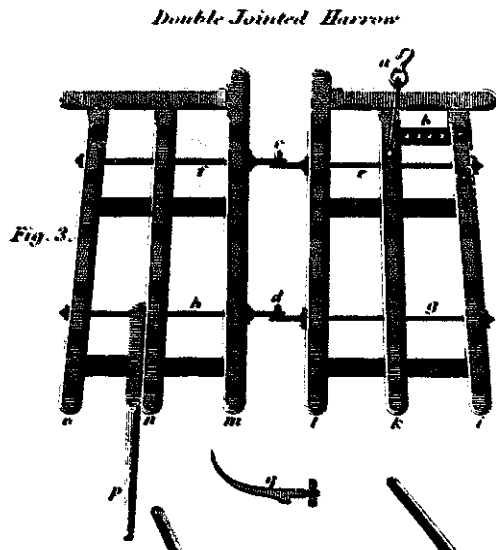

In this early illustration (Loudon, "An Encyclopaedia of Agriculture", 1815) all but one of the harrows have wooden frames. Even the iron harrow is built in the same style as the wooden implements – contrast it with the light frames on page 54.

HARROW

from

"The Rural Cyclopaedia"

J.M. Wilson, 1847

HARROW. An implement of draught, for pulverizing soil which has been stirred by the plough, for disengaging from it the roots and lower stems of weeds, for thoroughly intermixing its component parts, and for covering the sown seeds of cultivated plants.

The History of the Harrow.—The harrow im-

mediately succeeds the plough, both in the natural order of description, and in the uses to which it is applied. But—except that intermediate classes of implements, such as brake-harrows, revolving-harrows, scarifiers, and cultivators, more or less combining the action of the harrow with that of the plough, have, in modern times, been invented and multiplied—the harrow continues from remote times to be a very simple implement, while the plough has entirely relinquished its ancient forms, and has undergone thousands of transformations and improvements. The complicated ploughs of the moderns have no resemblance in form, and exceedingly little in action, to the rude machines with which the ancients scratched the soil, rather than tilled it,—and the best ploughs of the present day, in some districts or for some purposes, widely differ, in several of their prominent characters, from the best ploughs of other districts or for other purposes; but all the ordinary harrows of the moderns closely resemble the harrows depicted on ancient medals and sculptures, and may be regarded, not only as very simple, but as essentially imperfect.

The earliest or rudimental form of the harrow was probably a stiff, spinous, ligneous plant, of medium character between bush and tree, either a common hawthorn or any plant of similar size and habit, so cut, lopped, and pruned as to lie flatly on the ground, and make a great number of somewhat deep parallel scratches; and this rudest of all forms of it is still used in some of the cultivated parts of Asia. Another early form, also rudimental, though less so than the preceding, consisted of branches of stiffly ligneous trees, so dressed and fastened together that the stumps of their spray and branchlets acted on the soil in the manner of tines; and this form of it is still used in some parts of Russia. But a third early form—so early as to appear figured on ancient monuments, and to identify itself with very ancient practices of proper cultivation—consisted of a wooden frame of bars and cross-bars, with projecting teeth; and though both the frame and the teeth of this were of wood, while the teeth of most modern harrows and both the teeth and the frame of others are of iron, it embodied nearly all the principles on which the harrow continues till the present hour to be constructed. Materials, weight, size, and mode of traction, indeed, have been greatly varied,—though more for adaptation to particular soils and purposes, than with the design of effecting any constructional improvement; but—with the exception of a change of form from the rectangular to the rhomboidal, and of modifications of several kinds upon the form and collocation of the tines,—changes designed to distribute the action of the implement more uniformly and steadily athwart the surface operated upon—and with the exception, also, of brake-harrows, revolving-harrows, and clod-reducing harrows,

HARROWS

U.S. Pat. 437,589

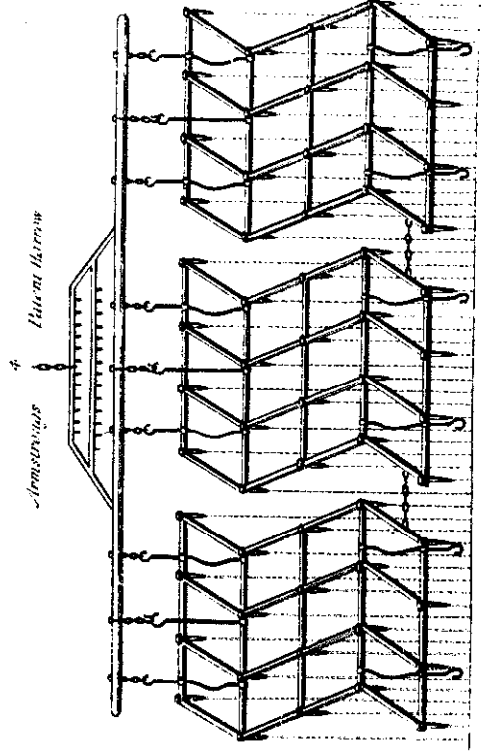
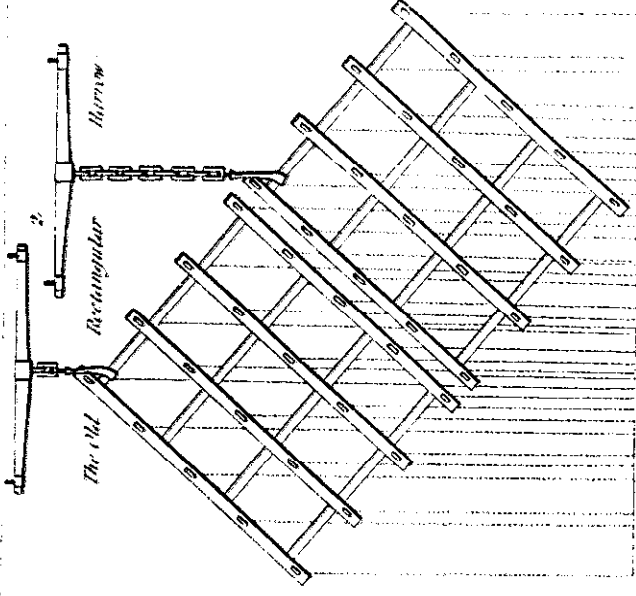
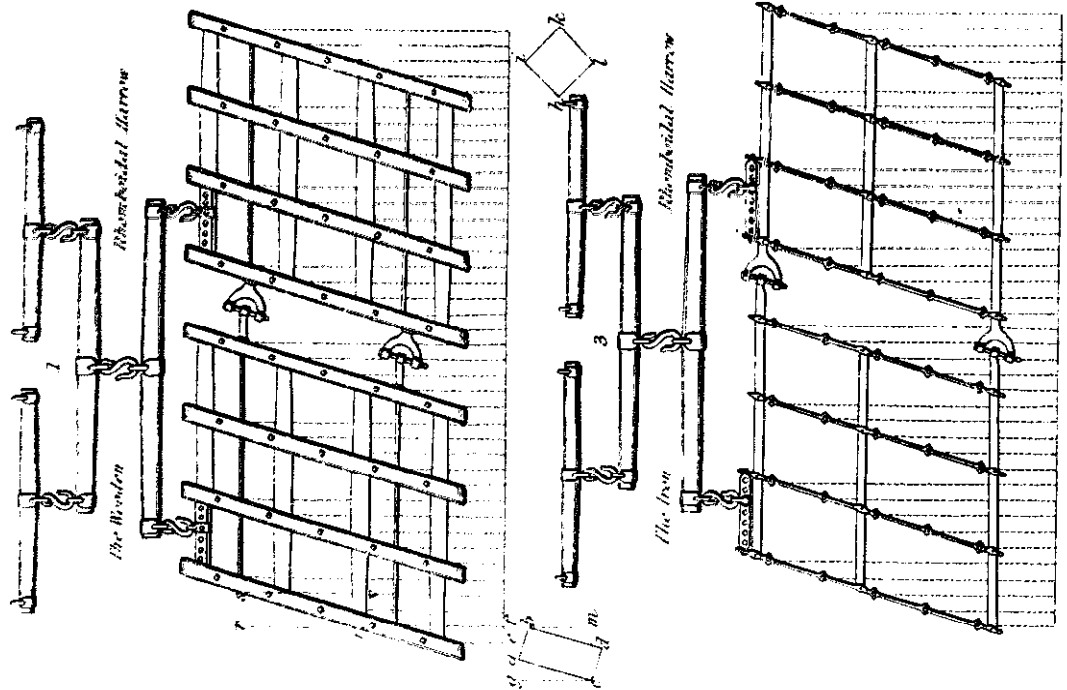

which, though retaining the name of the harrow, both possess the structure and perform the work of a higher and more complicated class of implements—the original, rude frame-harrow exemplifies all the same principles of power and mechanism which characterize the several varieties, light and heavy, wooden and iron, good and bad, of our modern harrows.

The Methods of Using the Harrow.—One driver or workman may employ either one horse and one harrow, or a pair of horses and a pair of harrows, or three horses and three harrows; but he makes thriftless work with only one harrow, and, except in rare instances or with harrows of very light construction or smaller than the usual size, he has much difficulty in commanding more than three harrows. Three men are required to drive three harrows when they are separate, while one man can drive them when they are yoked together; and three harrows yoked together can do as much work as four harrows in four separate yokes. "The reason," remarks Mr. George Robertson, "why two harrows are better in proportion than one, and three than two, is that a small piece of land, at the extreme diagonal corners of the space covered by the harrows, is insufficiently done, and must be overlapped the next time the harrows go round. This piece is to the same extent when one harrow is used single, as when two or three are yoked together. Thus, when one harrow is yoked by itself, it will not sufficiently harrow more than 2½ feet; but two harrows together will harrow 6 feet, and three will harrow 10 feet equally well. Each harrow, after the first, adds 4 feet to the space properly harrowed. Hence, three harrows in a set are better than four harrows separately, besides requiring one driver instead of four."

The workman in command of the team may either lead the horses, and walk before the harrows, or drive the horses by means of long whip-reins, and walk behind the harrows. But, in the former method, he cannot proceed as rapidly as in the latter; nor can he as easily, or with as little risk of a blow from the harrows, free them from occasional obstructions in the soil, and from successive chokings with weeds. He ought, by all means, to drive and walk behind; and he must ever be ready, either with his hand or with a crooked stick, to lift or jerk the harrows suddenly up so as to liberate them from obstructions and accumulations.

When the action of the harrows is required to no further an extent than a single turn or one double turn, they pass along the ridges; and when it is required to the extent of several double turns, they usually alternate a double turn along the ridges with a double turn across them, and make their concluding double turn along them. A single turn is effected, when the harrows proceed upon one belt of ground and return upon the adjacent belt; and a double

turn is effected, when they both proceed and return upon one belt. A single turn is commonly sufficient at the sowing of the smaller seeds of grasses; one double turn or two double turns are commonly sufficient to give the finishing tilth to a piece of thoroughly summer-fallowed and completely pulverized soil; but several or even many double turns may be required for the reduction of ploughed grass land, for the earlier cleanings of coarse and foul summer fallows, and for other cases in which the ground is adhesive and matted with the roots and the decurrent fibres of either weeds or gramineous plants. See the article FALLOW.

To prevent the injurious effect of the treading of wet or finely pulverized soil by the horses' feet, attempts have been made so to construct and yoke harrows as to allow the horses to walk in the furrows. But though the attempts are practicable enough on narrow ridges, they have been found possible only with complicated and expensive machines on broad ridges. In any ordinary instance of a farmer being obliged, in an unfavourable season, to harrow the ground when it is in a very wet state, a beam may be so attached to a set of three, four, or more common heavy harrows as to extend quite across the ridge, and to allow the horses to be harnessed to the ends of it, and to walk in the furrows. But both on account of the greater efficiency of the harrows' action, and for the sake of preventing injury from the treading of the horses' feet, harrowing, except in cases of absolute necessity, ought always to be performed when the land is dry.

All the proper work of the harrows, as may readily be inferred from the lightness of the whole implements and from the comparatively slight hold which they take of the ground, makes but a very gentle and easy traction for the horses. Yet the irregularities of their motion, the starts and bounds which they make upon obstructions, and their alternations of skimming lightly when free from accumulations of weed and rubbish, and of lumbering heavily, when encumbered with these accumulations, sometimes occasion considerable labour; while the mere sinking of the horses' feet in the soft and pulverulent soil is frequently so laborious as to render the entire traction easier to a colt or a light pony than to an ordinary farm-horse.

The amount of harrowing which can be effected in any given time varies with the condition of the soil, the activity of the horses, the alertness of the workman, and the forms and combinations of the harrows; and it is somewhat variously estimated by leading agricultural writers of Britain and the Continent. Sir John Sinclair says, "In Norfolk, it is the custom to walk the horses against the rise, if any, and to trot them back again in the same place; the quantity done in this way is about 7 acres per day. In Scotland, a man and a pair of horses will do a single

tine, as it is called, to the extent of 10 acres; but if a double tine, only 5 acres per day." Veit estimates, for one horse, an average of about $3\frac{1}{2}$ acres per day; and he elsewhere says that a man, with the usual harrow, may go over from $4\frac{1}{2}$ to 5 acres per day. Thær says, "The difference is greater in harrowing than in ploughing. This arises from the degree of carelessness, and the character of the implement, with which the work is done. The round harrowing is the most difficult; and 7 yokes," nearly 10 acres, "of this is the highest which a four-span harrow can perform; but on bending and grassy soils, one must content oneself with 6 yokes. In even harrowing, without the breaking up of clods, 9 yokes," 12.8 acres, "may be accomplished; and in merely drawing along once, with one man and four horses, from 11 to $12\frac{1}{2}$ yokes," from 15.6 to 17.8 acres, "may be harrowed." And Burger says, "When the harrow goes only once in the same line, in a soil not filled with weeds or very much bound together, so many as $4\frac{1}{2}$ yokes," 6.39 acres, "may be harrowed in 9 hours."

The General Structure of the Harrow.—As the harrow performs its work by means of teeth or tines, pressed into the soil merely by their own weight and that of the frame in which they are fixed, two prime considerations are the proper form of the teeth and the proper distribution of them in the frame. Were the harrow intended solely to drag up weeds and roots from the ground, the best form perhaps that could be given to the teeth would be that of a thin wedge, tapering to the point like the coulter of a plough, and, like it, inclining forward. But, although this form might be the best calculated for penetrating into the ground, and tearing up the roots beneath the surface, it would not be so well calculated for covering the cultivated seeds, as one which should present a broader surface to the earth, and so give a greater movement to the particles of the soil. The wedge for this latter purpose, as well as for pulverizing the clods of earth upon the surface, should not be thin but broad. In order, therefore, to adapt the teeth to these different purposes, to the strength necessary to be given to them, to the attrition to which they are subject, and to the lateral or shaking motion of the implement when encountered by obstacles, the best form is one whose horizontal section *h i k l*, *Fig. 1, Plate XXVI.* is a square, the diagonal of which is moved forward in the line of the harrow's motion. The teeth, however, must gradually taper to a point, the fore-part being kept straight; and they are generally inserted into the frame work with 'a rake,' as it is technically termed, or with slight inclination forward, so as the better to insinuate themselves beneath the roots which they are to raise to the surface, and to have a tendency downwards rather than upwards, when encountered by obstacles beneath the surface. As to the distribution of the teeth in the frame

of the harrow, they should not be too closely set, for then they would be constantly impeded by the obstacles opposed to them; and, they ought, also, to be so disposed in relation to one another as to give all parts of the implement an equal degree of liability to obstruction. The number of teeth, moreover, should not be too great, because then their power to penetrate into the ground would be diminished, unless the weight of the whole implement were increased in a corresponding degree; and, lastly, their length should not be greater than is necessary, because they would not, on that account, penetrate more deeply into the ground, unless the whole weight were also increased,—and they would at the same time have a greater power, when encountered by obstacles, to split the frame in which they were fixed.

The harrows represented in *Fig. 1, Plate XXVII.*, are formed with a regard to these general principles. They consist each of four bars of wood, A, B, C, D, &c., technically termed bulls, and connected together by an equal number of cross bars of smaller dimensions, mortised through them. The former of these bars may be $2\frac{1}{2}$ inches in width by 3 in depth, and the latter 2 in width by 1 in depth. The longer bars are inclined at a certain angle to the smaller, so as to form the figure of a rhomboid; and they have inserted into them the teeth at equal distances from one another. This inclination of the larger bars is made to be such, that perpendiculars from each of the teeth falling upon the line I K, drawn at right angles to the line of the harrow's motion, shall divide the space between each bar into equal parts; so that the various teeth, when the implement is moved forward, shall equally indent the surface of the ground over which they pass. The advantages of this distribution of the teeth and position of the bars, will best appear by comparing the harrows in *Fig. 1* with those in *Fig. 2*. In the latter, which represent the old and unimproved harrows of Scotland, the bulls are not inclined, but are placed at right angles to the cross bars; and, in order to diversify the tracks of the teeth, each harrow is drawn by its corner. But here the teeth, though at equal distances from one another, in their several bulls, do not equally indent the surface, as will appear by drawing lines from their different centres, parallel to the line of the harrow's motion. This defect, indeed, could be obviated by attaching the line of draught more to the right hand; but then one of the corners of the harrow would still move before the other, which is an inconvenient position, and attended in practice with certain disadvantages.

The number of teeth in the harrow is twenty, five being inserted in each bull. When two harrows, therefore, are employed together, the surface of the ground from I to K is indented by forty teeth, moving at equal distances from one another. The teeth may so project below the

under surface of the wood, that the length shall be about six inches in the hindmost row, and shall gradually increase to about seven in the foremost, where the oblique position of the line of draught tends most to elevate the harrow. The teeth, it has been said, are generally inserted into the frame, with a little inclination forward. This deviation from the perpendicular, however, if made at all, should be very slight, because it renders the harrow more apt to be impeded by the weeds and rubbish raised by the teeth, and collected in the angle formed between them and the wood. The teeth are fixed in the bulls, by boring holes with an auger of about three-fourths of an inch diameter, and then driving the teeth firmly through. The best of the common kinds of wood for the bulls, on account of its being the least liable to split, is elm, birch, or ash, and for the cross-bars, ash; yet the whole may be made of well-seasoned larch. The teeth, when thus driven into the bulls, will be retained with sufficient firmness; though, in the very large and heavy species of harrow called brake-harrow, they should be further secured by means of bolts or screw-nuts.

The harrows referred to in *Fig. 1*, are connected together by the iron hinges *L, M, N, O*, which keep them at the distance required, and admit either of rising or falling according to the inequality of the surface. The method of attaching the animals of draught, will be explained by the apparatus represented in the figure, by means of which, each animal must exert an equal force in pulling. Here *RQ, RQ*, are the foremost slots of the harrows, bars of iron passing through the upper end of the bulls of each harrow. These bars have, on each side of the bulls *AB, EF*, a few holes or notches, so situated that the line of draught may be shifted to the right or left as may be required; and the staple *P* being the point to which the moving power of the whole machine is applied, it is important to ascertain its proper position. In order to place an equal number of the teeth on each side on the line of traction, it is apparent that the point *P* should be placed in the middle of the entire breadth covered by the harrows. This, however, would not be the true position of this point, unless each of the teeth were so formed as to be equally resisted by the earth on each of its sides. Thus, if a tooth, whose horizontal section is *abcd*, were so moved forward that, in the rectangle *cg, fm, ge*, perpendicular to the line of traction, should be greater than *ef*, then the impinging earth would act with a greater force upon the left than upon the right side of the tooth, and so tend to turn the whole harrow round the point to which the moving power was applied. The point *P*, therefore, could not now be precisely in the middle of the breadth covered by the harrows, but would need to be applied so much more to the left hand as that the tendency of the implements to turn round should be counteracted by

throwing more of the space covered by them to the right hand side of the line of traction. The effect, however, produced by any particular form of the teeth will generally be slight, owing to the limited surface which they present. But in practice there is found to be a considerable tendency in this species of harrow to turn round from left to right, arising from the oblique position of the bulls. When any obstacle raised above the surface of the ground strikes a bull, as at *t*, the force *ts*, which it exerts upon the motion of the harrow, may, according to the laws of mechanics, be resolved into the two equivalent forces *rt* and *rs* of the parallelogram *rstv*, of which, the side *rt* in the line of motion will represent the force of the obstacle in resisting the advance of the harrow, and *rs* perpendicular to *rt*, the force operating to turn it to the right. Now, as there are not fewer than eight bulls in the harrows, and these of considerable length, it is evident that, in ground with any great unevenness of surface, there will be a constant succession of strokes, forming a strong lateral pressure on the left side of the several bulls, tending to push them to the right hand side. But the staple *P*, being nearly fixed in its position, while the hind part of the harrow may be moved round, the effect of this pressure is to turn the whole harrow upon *P* as on a pivot; and this effect on very rough ground will be found so considerable as often to place the bulls of the harrow parallel to the line of motion, thus causing all the teeth in the same bull to follow in the same track. Hence, then, *P* is not a fixed point, but varies with the nature of the surface; and hence means must be afforded to the driver of shifting the point at which the draught is applied to the right or to the left as may be required; and these means exist in the cross-bars *RQ, RQ*, which pass through the upper end of the bulls of each harrow.

The Varieties of the Harrow.—The old quadrangular harrow is represented in *Fig. 2, Plate XXVI*, and has been almost sufficiently noticed, though but incidentally, in the preceding section. Its bulls, in general, are about $4\frac{1}{2}$ feet long, 3 inches broad, and from 3 to $3\frac{1}{2}$ inches deep; its slots, in general, are 3 inches broad and an inch or seven-eighths of an inch deep; and its teeth or tines consist of malleable iron, and are 20 in total number, or 5 in each bull, and each is about 10 inches in length, and projects from 6 to 7 inches beneath the under surface of the bulls. This variety of the harrow is greatly inferior to the rhomboidal variety; yet whenever it is still preferred, it may now, according to recent improvements, be made wholly of iron.

The rhomboidal harrow is represented in *Fig. 1, Plate XXVI*, and has been very fully described in the preceding section. The rhomboidal form of it is the chief instance of the only essential improvement which has been made in the principles of the harrow since the times of the ancients;

and this was invented, about 55 years ago, by Mr. Low of Gordonbank, in Berwickshire, the father of the well-known professor of agriculture in the university of Edinburgh; yet, in spite of its great and manifest excellence, it came but slowly into use, and was not generally imitated in the construction of harrows, even in the south-east of Scotland, till about the third decad of the present century.—The hinges of the common forms of two mutually connected rhomboidal harrows, are adjusted together in close and well-fitted joints, and have their tails prolonged in a bolt through only the first and the second bulls; but the hinges in the newest and most improved forms of these harrows, as represented in the figure in our plate, have a wide-eyed single joint in the one harrow, and an arched double joint of about six inches of span in the other, so as to produce looseness and freedom of action, and have their tails prolonged in bolts through all the bulls, quite to the opposite sides of the harrows, so as to contribute to the increase of both the strength and the efficiency of the implements.

Since the recent extensive introduction of iron into the manufacture of large and heavy implements, rhomboidal harrows have very generally begun to be wholly constructed of that material; and in this case, they have fewer slots and far more slender bulls,—and, besides being more durable, and less liable to accidental injury, they expose a smaller surface to the resistance of obstacles on the ground, and perform somewhat more work in proportion to their weight. These harrows are represented in *Fig. 3, Plate XXVI*. The slots are only 3 in number, and may be 2 inches broad, but need not be more than $\frac{3}{4}$ of an inch deep; the hinge-joints are formed upon elongations of the two end slots; and the bulls may be $\frac{1}{2}$ an inch broad and 1 inch deep, and require to be swelled out at the mortises for the slots and for the tines.

Several or even many varieties of rhomboidal harrows, with either wooden or iron slots and bulls, are readily obtainable from manufacturers of agricultural implements, and may all be alike efficient for different purposes or on different kinds of land. One cheap and small variety, with wooden slots and bulls, is made for garden culture, with tines let in with shoulder and plate, and fixed angularly with nut and screw, and so arranged as to cut tracks in parallel lines at distances of $2\frac{1}{2}$ inches; and a 14 lb. weight is fitted to be used when a deep tilth is required.

Armstrong's patent four-beam iron harrows exhibit a much wider deviation, than the rhomboidal harrows do, from the form of the old quadrangular harrows; yet they seem not at all likely to come into such general use as the rhomboidal harrows, and may be ranked as a less approved, though much more curious, instance of the one great feature of modern improvement

on the principles of the ancient harrows. Three of these harrows, linked together into one gang, and adjusted to a single line of traction, are represented in *Fig. 4, Plate XXVI*. "These harrows," says the account of them in the Annual Register of Agricultural Implements for 1844, "are made in a peculiar zigzag form, by which means the tines are so arranged that they can cut a separate track from each other 2 inches asunder. They are made without the projecting corners, as in the old sort, allowing them to fall into the hollow parts of the land much better. One decided advantage they possess is in the principle of draught, which is from a centre. Upon the original mode of draught, the horses draw from each end of the whipple-tree, so that if one horse draws more forward than the other, the harrows are drawn out of their proper track, the tines being thus made to follow each other, thereby causing a total loss of horse-power,"—a remark, however, which, as may be seen from the statements in the preceding section, applies very slightly, and sometimes not at all, to the properly mounted and attentively driven rhomboidal harrows; "but upon the new principle of draught, let the horses draw ever so irregularly, one part of the harrows is not more affected than the other. The harrows are attached to the whipple-tree by double hooks, which prevent them, in rough work and in turning, from riding on each other. The teeth are made with a square shoulder, and secured to the frame by means of a nut and screws; consequently they may be taken out and relaid, without the frames or beams sustaining any injury. There are four bows or slides on the top of each harrow, placed there for the purpose of removing them from one field to another." These harrows, both in the variety represented in our figure, and in other varieties of different adaptations and prices, are made by Mr. John Howard of Bedford. One of the other varieties is in all respects the same as that represented, except that it is lighter in construction, and suited to sandy lands and all other kinds of light soils; another has an additional row of tines and makes tracks at distances of $1\frac{1}{2}$ inch; another has two additional rows of tines; and another is very light, and has a great number of tines, and is adapted for covering in small seeds, for following the drill, and for drawing over crops in the spring, to destroy young weeds, without injury to the cultivated plants. One set of Mr. Howard's patent iron harrows are made with two beams to each, and six harrows to the set, suitable for convex or high-backed lands, adapting themselves, by means of an extra number of joints, much better to the form of the land than when made wider, with four or more beams, and having the whipple-tree so made that the horses walk up the furrows; and another set—which he calls patent drag harrows—are made on the same principle as those represented in our figure, but much

stronger, and made to draw backward or forward, so as to act in the former way like a grubber, and in the latter like a pulverizer or clod-breaker. Attempts, in short, are made to accommodate varieties of Armstrong's zigzag harrows to the purposes severally of the common cleaning harrows, the light seed-covering harrows, the brake-harrows, and, in some degree, the grubber and the clod-bruise.

A registered expanding harrow, formed entirely of iron, was recently invented by Mr. Exall, and made by Messrs. Barrett & Co. of Reading, and was expected freely to adapt itself to the unevenness of the land, to admit of being put to any width from 4 to 8 feet, to be very easily and readily cleaned, and to combine the advantages of cheapness, portability, and durability; but it has not been found to answer expectation.—Expanding lever-harrows were invented and patented by Richard Colman of Colchester, Sussex; and were exhibited, of two sizes, at the Highland Society's Agricultural Show at Dumfries, in 1845, and are noticed as follows in the official Report of that Show: "These harrows embody two essential points—1st, The principle of their expansion, which is based on a strictly geometrical principle,—that a parallelogram, divided into any number of lesser parallelograms, by lines drawn parallel to two of its contiguous sides, will have these smaller, each exactly similar to the original figure; and whatever degree of obliquity may be given to the greater, each of the lesser will undergo the same change, preserving the exact similarity of figure. 2d, The harrows being supported on small wheels attached to levers, whereby any degree in depth of penetration by the tines is readily obtained at pleasure, by changing the position of the levers. The first property is an important one as applied to the harrow; and the changeable nature of the parallelogram when not tied by a diagonal, as well as the constant similarity of its integral divisions, are very beautifully brought to bear in this improvement. By their means, this harrow is capable, not only of making every tine form a distinct line in the soil, like the best kinds of common harrow, but the distance between the whole of these lines can be varied with mathematical exactness, both as to equality one with another and to extent of variation. Thus, they will draw lines that shall be all four inches, or all one inch apart, or at any fractional part of the distance between these; and the construction being effected, the changes are produced by simply changing the place of a hook in a chain. We have few examples in agricultural machinery where a geometrical principle has been so happily applied, and applied, too, to one of the rudest of implements. The variation in depth of penetration seems also a considerable step in the perfecting of this harrow, that being a point in which all others are defective. An objection was made to the use of cast-iron in

these harrows; but the inventor stated that he also makes them entirely of malleable iron. As there was no opportunity of testing these harrows in the field, it would be premature to pronounce upon their *practical* efficiency, though in principle they are in advance of all others."

The rectangular drill harrows are employed chiefly in the culture of the potato; and are drawn along the drills by one horse, and applied in the early periods of the growth of the crop. Their object is to remove weeds and loosen the soil; but they are often marred in their efficiency by having too many teeth. No two of their teeth should stand nearer to each other than 6 inches; and all ought to be so arranged as to produce streaks at regular distances of from 2 to 3 inches.—The triangular drill harrows are used for the same purpose, and produce the same effects, as the preceding, and differ from them principally in form, and in the facility which their inclined bars afford for keeping the teeth well separated, and for producing streaks at every three inches with the least possible number.

Grass-seed harrows of various constructions are used for covering grass-seeds and clover-seeds, and sometimes for giving finishing turns to the covering of grain-seeds and the polish of the tilth; but they are often superseded by the common pulverizing harrows; and most of them, even as expressly made for covering grass-seeds and giving a finish to tilth, differ from ordinary harrows only in being lighter and smaller, and in having a proportionally larger number of teeth. Some varieties of grass-seed harrows, when intended for sandy lands or other very light lands, are made, also, with very small teeth of not more than 4 inches in length; and some are made with wooden teeth.—The bush-harrow is used sometimes as a substitute for the grass-seed harrows, but more commonly for cautiously cleaning the surface of grass lands, and for harrowing in top-dressings upon grass. See the article BUSH-HARROW.—The iron-web harrow is a recent, elegant, and very efficient invention of Mr. Smith of Deanston, for achieving the same purposes as the bush-harrow. It mainly consists of annular, cast-iron discs, precisely similar to cast-iron playing-quoits, woven with iron wire of about one-fourth of an inch in diameter into a flexible web of about one foot in breadth and 6 feet in length; and this web is simply dragged along the surface of the ground, and possesses so free a texture as to keep the discs in constant play and motion.—A set of four very light seed-harrows, figured and described in Mr. J. Allen Ransome's Work on the Implements of Agriculture, is stated to have been invented by a friend of that gentleman, after his observing the efficient manner in which the seed-corn, in some parts of Norfolk, is covered by a common wooden-toothed rake. The frames are parallelogramic, and made of ash, and as light as possible;

the teeth of each harrow amount to twenty, and are made of iron, and project only 3 inches below the frame; and the four harrows have jointly a sufficient breadth to cover a ridge of 108 inches, and are hinged together lengthwise, and are attached by the middle of their respective fore-ends to a single bar, which extends quite across the ridge, and has its draught-attachments at the ends, so as to require the horses to walk in the furrows. But one serious disadvantage of this implement is, that, whenever the one horse walks in even a slight degree a-head of the other, all the harrows are so far thrown into the diagonal as to make the teeth of the second, third, and fourth bulls pass through the same tracks as those of the first, and leave three-fourths of the aggregate breadth of the ridge unharrowed.

The brake-harrow or break-harrow—or as it is sometimes abbreviatedly called, the brake or break—is simply a large and heavy variety, or rather class of varieties, of the common pulverizing harrow. It is designed to reduce and pulverize any kind of rough and stubborn land, and particularly any strong clay land, when in too obdurate a condition to be subject to the teeth of the common harrow; and it is made of either a rectangular, a rhomboidal, or a triangular shape, and in a considerable number of different ways. One somewhat common, though rather old-fashioned kind of it, is quadrangular, and has 6 slots, 5 bulls, and 25 tines, with the perforated bar of traction adjusted between the ends of the second and the third bulls; and another kind of it, which some authorities allege to exert a superior action, is rhomboidal, and has 4 slots, 3 bulls, and 15 tines, with the perforated bar of traction between the first and the second bulls, and worked in a set of two, so loosely though firmly hinged to each other as easily to suit themselves to the curvatures of the ridges. But brake-harrows of all shapes and forms are alleged by some good judges to be all alike efficient, provided they be heavy enough, and have tines of sufficient length and number, and properly arranged. Brake-harrows of all sorts, however, have become, in a main degree, antiquated,—partly from the subduing and pulverizing effects of drainage upon clay lands, and partly from the extensive introduction of scarifiers, grubbers, and other implements of facile and thorough fallow-cleaning. A whole class of implements, with the true grubbers as their type, now combine the action of the common harrow with that of the plough, so as very efficiently to perform the work which was formerly appropriated to the brake-harrow; and another though much smaller and quite recent class of implements, called revolving harrows, combine in some degree the action of the break-harrow with that of the scarifiers or the grubbers. See the article GRUBBER. An implement, called a crosscutting harrow, operating by means of three blades or coul-

ters cutting across the plough furrow, and designed to improve and reduce moss-land, was invented in 1829 by Mr. Brown of Carabus in Islay. See the article CROSSCUTTING.

A harrow of an entirely novel construction, and of great promise in the estimation of the judges, was exhibited at the Shrewsbury meeting of the Royal Agricultural Society in 1845, by Mr. George Edward Frere of Edinburgh, and attracted much attention in the field. The official report of it says:—"It is called the Norwegian Harrow or Clod-crusher, and was originally imported from Norway by Mr. Frere; the one under notice having been constructed, with some changes, by Mr. Richard Stratton, of Bristol. The acting part of this implement consists of a frame containing four horizontal spindles, on each of which is fixed a set of cast-iron bosses, with teeth projecting from them like the rowels of a spur. These teeth revolve with the spindles, those on one spindle inter-working with the others, so that they severally clear and clean each other. The effect produced is a remarkable bruizing, crumbling, or disintegration of the soil, without any clogging of the spikes, or possible derangement of the working parts. The weight suffices to cause the spikes to penetrate to the required depth, which is also governed by an adjustment of the wheels applied for travelling the implement, and for taking it out of work when turning. But it acted quite as well when divested of the wheels and of other paraphernalia, which tended rather to embarrass than assist its good action. Neither stones nor sods appear in any way to obstruct the working of this eminently simple machine, the stones being pushed aside, and the sods torn to pieces. The force was thought to be less than that required to work a common set of harrows going equal depth, and the effect in pulverization much greater. It was tried on two different kinds of soil, immediately after ploughing, with similarly good results. To what extent this implement may act as a clod-crusher the judges cannot say, as they had no means of trying it; but this distinction may be drawn between it and such an implement as Mr. Crosskill's, namely, that the Norwegian harrow leaves the land perfectly light and loose, whilst the clod-crushing roller gives to it firmness and consistence. The judges awarded to Mr. Frere a premium of £10, and Mr. Stratton obtained many useful hints from this first trial of the implement for its future improvement."—*Annual Register of Agricultural Implements.*—*Catalogue of the Highland Society's Museum.*—*Transactions of the Highland Society.*—*Quarterly Journal of Agriculture.*—*J. Allen Ransome's Implements of Agriculture.*—*Sir John Sinclair's Code of Agriculture.*—*Goodrich Smith's Economy of Farming.*—*Sir John Sinclair's General Report of Scotland.*—*Marshall's County Reports.*—*Mill.*—*Low.*—*Doyle.*—*Stephens.*—*Sproule.*—*Knowledge Society's Farmer's Series.*

This page is taken from the 1903 catalogue of William Elder, of the Tweedside Implement Works, Berwick-on-Tweed.

GRUBBER HARROW.

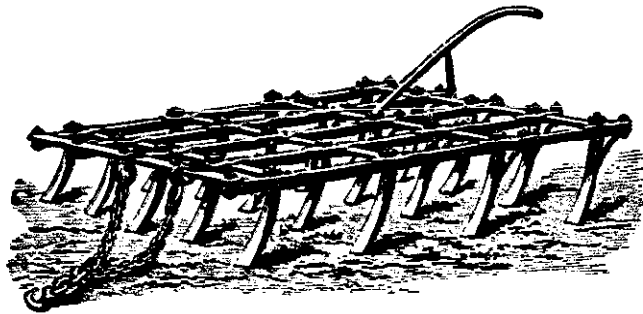

The above represents my Grubber Harrow, which is now so well known that any comment by me is unnecessary, being one of the best implements of the kind in the Market.

Heavy, for 3 Horses,	£4 0 0
Medium, for 2 Horses,	3 10 0

GENERAL PURPOSE HARROWS.

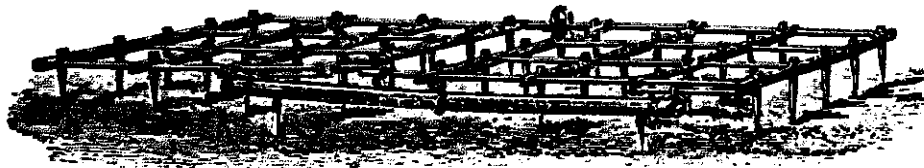

The above engraving represents my new General Purpose Harrows, which are made of the best Steel and Iron combined, and the Tines are made and fastened on a principle by which there are no nuts required, and therefore cannot get loose or out of order.

These Harrows are also well adapted for export They are made in two sizes, Heavy and Medium.

Medium Weight, 9 feet wide,	£3 10 0
Heavy do., 9 feet wide,	4 0 0

THE HARROW

from

“A Cyclopaedia of Agriculture”
J.C. Morton, 1855

HARROW (TIE).—The purpose of this implement is precisely that of the gardener's rake. The rake is used to prepare a seed-bed or to cover seed. In the one case it operates by bringing clods to the surface, that they may be broken by farther rakings or harrowings, or by the operation of the roller; by bringing weeds to the surface, that they may be removed or burned; and by reducing the surface of the land to the tilth requisite for the reception of the seed. In the other

HARROWS.

Plate XXVI.

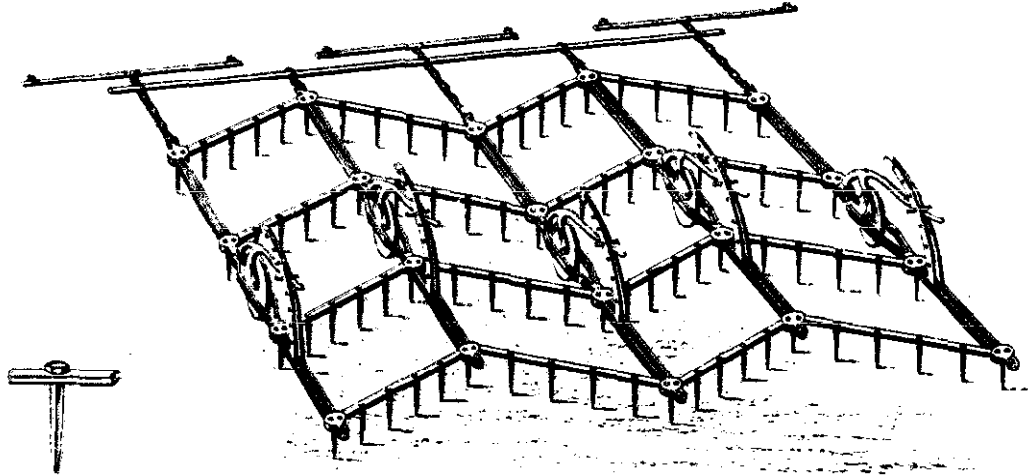

Tooth.

COLEMAN'S HARROW

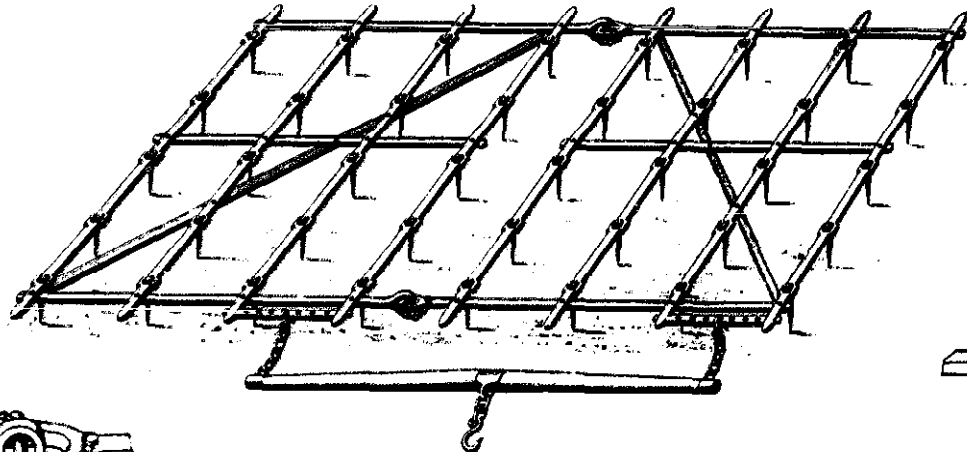

Coupling.

COMMON RHOMBOIDAL HARROW.

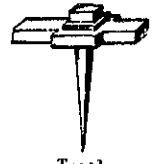

Tooth.

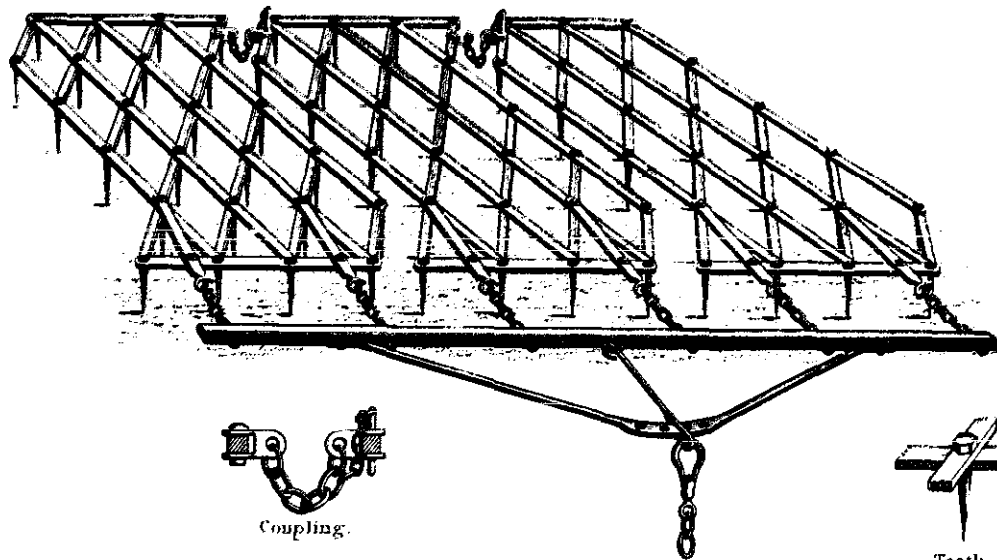

Coupling.



Tooth.

SAUNDERS' AND WILLIAMS' HARROW.

Henry Stone del^d

J.W. Lowry sc.

case it acts by mixing the seed, if sown broadcast, with that portion of the surface soil through which the teeth penetrate; or if drilled, by dragging down the sides of the little furrows in which the seed is placed. In both cases, the rake is worked backwards and forwards over the surface repeatedly until its purpose is accomplished. The rake consists of but one row of teeth, and this to and fro motion is necessary to render it efficient. In the harrow we have not a line, but a surface studded with teeth; these are placed far enough apart to hinder the liability to clog, which it would experience in foul or cloddy land—but they are in rows, frequent enough to compensate, in some measure, for our inability to imitate with this implement the to and fro action of the gardener as he rakes the land. To arrange the spikes in a sufficiently convenient extent of surface frame-work, so that the most efficient harrowing shall result from dragging it over the land, would seem an easy problem, and yet very many solutions of it exist, which differ very materially in their perfectness. We have seen a wooden frame-work studded with iron teeth about a foot long, intended as a harrow, which exhibited the most obvious faults of construction: the main beams of this frame-work, in which the teeth were morticed, tending towards each other in front, so that the teeth were nearest together where the land on which it was to operate was coarsest—and furthest apart where it could act on the soil, only after it had been somewhat comminuted by the front part of the machine. The converse of this would be nearer the just arrangement; but in practice, where no such nicety of fitness is possible, the even and uniform distribution of the teeth is the general and better method of arrangement. The frame-work is made of cross bars morticed through longitudinal bars, whether of wood or of iron, the latter being preferable; and these longitudinal bars, carry iron teeth from nine inches to a foot long, either morticed in and held by the mere elasticity of the iron, or fitted in by bolt and screw. These teeth are placed so as that their edge shall go first. The common rhomboidal harrow, represented in Plate XXVI., illustrates the common form of the implement. Each harrow here weighs about one cwt., and carries twenty teeth, each of which is therefore pressed with a force of about six lbs. into the ground. This is by no means sufficient to sink it very deeply into the soil, and it is not intended that it should. The harrow is essentially a surface machine. If it be desired to work the land to the full depth of the ploughing, a cultivator should be employed for the purpose. The heavy drags, drawn

by four horses, or six, and even eight oxen, which are still to be seen in some English counties, are most wasteful of power. The work which they are performing with such effort might be equally well executed by a better implement, one of the cultivator class, with one-half the power. The draught bar, it will be seen, is attached to the common harrow, Plate XXVI., in front by two chains, which are attached to one or other of the holes in the pierced plate connected with each piece of the machine. According as it is fastened to the right or left of this bar, the framework which it drags will swing to the right or left, and its longitudinal bars will be more or less inclined across the line of draught. It would be possible to make such an attachment as should cause these longitudinal bars to follow exactly in the line of draught, and each tooth would then follow in the track of the one preceding it. This, however, is of course undesirable, and so the attachment is made at a point so much to the right of this as to cause the longitudinal bars to work sideways, each of their teeth thus taking a path of its own. It is drawn by two horses, the man guiding them by reins as he walks behind, and attending to the condition of the implement, lifting it, without stopping the horses, when it becomes suddenly clogged with weeds or otherwise, and clearing its teeth with his hands when they require it on turning at the land's end. A man will, with one of these implements, which covers a width of about seven feet, and a surface of twenty-four square feet, give rather more than ten acres of land a single harrowing in ten hours. The same form of implement is adopted in one of lighter make, containing, in about ten square feet, as many as sixty-four teeth or tines, each about six inches long. The weight of the two pieces in this case is about one cwt., each tooth being thus pressed into the land with a force of hardly two lbs. These light harrows are for covering grass and clover seeds.

The fault of this rhomboidal form of the harrow is, that however perfectly in theory the path of each tooth may be equidistant from that of its neighbour, in practice this is rarely the case, so that the angular extremities of the framework do not so efficiently operate upon the land which they pass over, as the central part, which is passed over by the whole depth of the machine. For this reason, the modification of this form of the machine, manufactured by Messrs. Saunders and Williams, of Bedford, and represented in Plate XXVI., is preferred by many. The somewhat zig-zag arrangement of parts causes an equal depth of the framework to pass over every part

of its track across the field. In this machine the teeth are fastened by screws, which at the same time hold together the crossed bars of the framework. The mode in which the parts of which this machine consists are connected is preferable to that ordinarily adopted (both are represented in the Plate), inasmuch as, with perfect security of connection, it allows a greater freedom of independent motion among the parts, and this is of importance to the efficiency of the implement.

The faults of the common harrow, independently of its form, are that there are no means of altering it according to the circumstances of the land to be acted upon. If more teeth in a given space, and less weight to force them in to the land, be desired, another implement of lighter make must be adopted. Mr. Coleman, of Romford, Essex, has the merit of having attempted to fit one and the same machine for all the different purposes to which the harrow is applied. His machine is figured in Plate XXVI. It consists of four parts jointed together, so that they may fold up like parallel rulers into an extremely narrow width, or extend abroad over a considerable surface—the eighty teeth which it carries in the one case acting as a very fine comb, and in the other as a comparatively coarse one. Its framework is at the same time carried on discs or wheels, one of which is represented in Fig. 522, where the lever, jointed to the framework at *a*, which carries the wheel, may be pressed down and secured

Fig. 522.

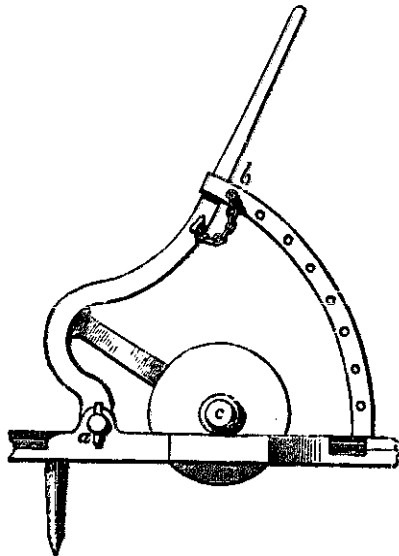

in that position by the pin at *b*, until the wheel *c* is so far below the framework as to convey the machine without the teeth touching the ground

at all; or it may be fixed at such a height as to permit the machine to exert its full efficiency.

This harrow is intended for three horses, whose draught-bars are fixed in their position by the relative distance of their points of attachment to the main draught-bar shown in the Plate; and it is obvious that upon their nearness or distance depends the degree of collapse, and consequent degree of fineness of the harrow. When very near to one another, the chains connecting them with the machine require to be lengthened, in order to permit that retreat of those parts of the machine which ensues on its collapse.

As regards the prices of these machines:—

The common heavy rhomboidal harrow will cost per pair about.....	£3 0 0
The light grass-seed harrow about.....	2 2 0
Saunders and Williams',	4 15 0
Mr. Coleman's expanding horse harrow,	8 0 0
Or without the wheels and levers, and retaining merely the expanding arrangement,	4 10 0

For covering small seeds, the roller merely is often employed; but an implement which should in a manner combine the operation of roller and harrow would be an improvement for this purpose upon either. Such a combination is effected by what is called the web harrow, invented by the late Mr. Smith of Deanston. The drawing at Fig. 523

Fig. 523.

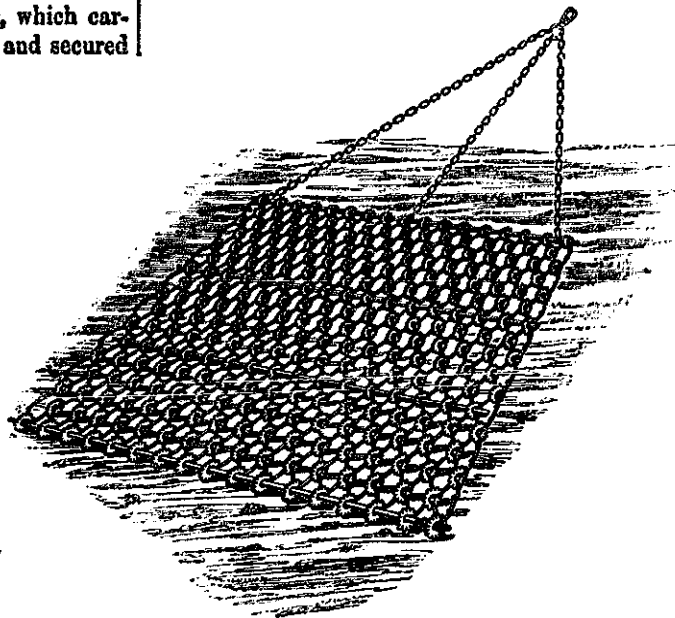

represents this machine as manufactured by Messrs. Cottam and Hallen, of Oxford Street, London. It consists of an iron chain web, connected to-

gether by discs or quoits of iron, which, lying obliquely upon their sides when in operation, roll around, thus tearing and abrading the surface of the ground, and grinding the smaller clods, so as to expose and disturb the surface to depth enough to cover the small seeds strewn upon it. It is admirably adapted for covering in grass seeds—the grinding and pressure, and shallow, though thorough, operation of the implement, bring about the exact result that is desired. We may add, that in Fig. 521 these serrated discs are represented as running more on their edges than when in use they really do. It is by the rubbing of their *sides* against the land as they revolve that they are especially useful, more than by the action of their edges, though that is also efficient to some extent. And the efficiency of the machine has been increased, since its invention by Mr. Smith, by the substitution of serrated for the rounded discs which were originally employed. The serrated form of the disc as now used is shown at *b* in Fig. 524, where the mode in which these discs bind the whole framework together is also exhibited at *c*. This implement costs from £4, 15s. to £5, 15s., covering twenty-five square feet of ground.

Fig. 524.

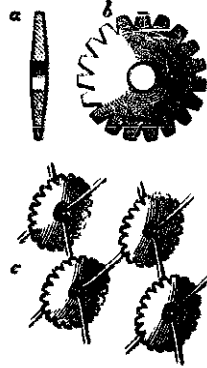

In the article GRASSES will be found an account of the experiments on the germination of grass seeds, which, we believe, led Mr. Smith to devise the above machine for covering them in. It had long been known to farmers that a large proportion of these small seeds did not vegetate, owing to the depth at which the operation of harrowing with the common form of the implement deposited them in the land, and the experiments of Mr. Sterling, of Glenberrie, determined the fact with precision. Rolling, on this account, was often preferred to harrowing and covering clover seed, and, in a moist seed-time, answered perfectly. An instrument, however, which should unite the process of rolling with a certain amount of that disturbance of the soil produced by an ordinary harrowing, would be preferable; and this desideratum has been completely satisfied by the web harrow, which we

owe to Mr. Smith's ingenuity. A much smaller quantity of seed than is now used will, if covered so that all of it shall germinate, answer the purpose; all now wasted will thus be saved; and, no doubt, one of the chief merits of this harrow lies in the great saving of seed which may thus be effected by its use. Any one who considers how many clover plants, for instance, will suffice to stock an acre, and what a vast number of seeds are contained in the twelve lbs., or even twenty lbs. which are now sown per acre, will admit the great room there is for the use of some contrivance for avoiding the common waste now permitted. It is only fair to add that the bush harrow—a framework of wood interlaced with thorns—forms a good substitute for the expensive implement of Mr. Smith. It merely scratches the surface, and so far gives the seed lying upon it a very shallow covering; but it wants the weight which makes the web harrow to compress as well as abrade the surface—both of which conduce to its efficiency. The bush harrow is the cheap, less effective—the web harrow the dearer, but more efficient implement for the purpose of covering small seeds.

Besides the machines just described as adapted for acting uniformly on a surface, implements of the harrow kind, for merely stirring the surface, have been devised, which shall act in lines as required under the system of drill husbandry.

Here, for instance, Fig. 525, is a machine intended for working down the drilled ridges underneath which potato sets have been planted. It is used to remove a certain depth of soil just before the shoots of the potato come through, so

Fig. 525.

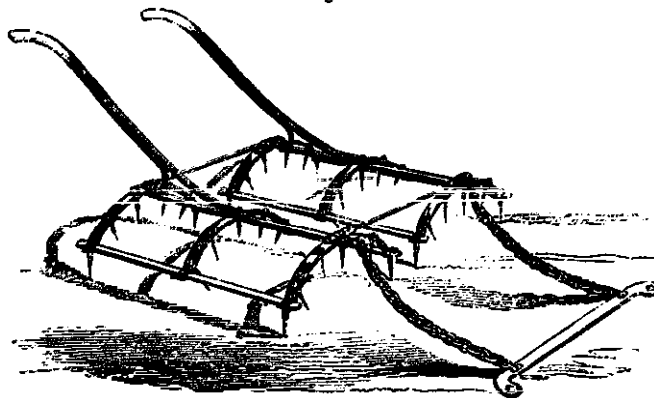

as to diminish the effort needed by the plant, both by making the ground which it has to penetrate shallower, and by giving a fresh soft surface. It is made in two parts, each being convex, and about twenty-four inches wide, connected by a bar across them, which admits of their separation to a

greater or smaller distance, so as to fit the width of drill; and it is drawn by one horse, which walks between the drills on which it is to operate.

The common drill harrow, again, of which Fig. 526 is plan and elevation, is intended to stir the ground between rows of potatoes, tur-

Fig. 526.

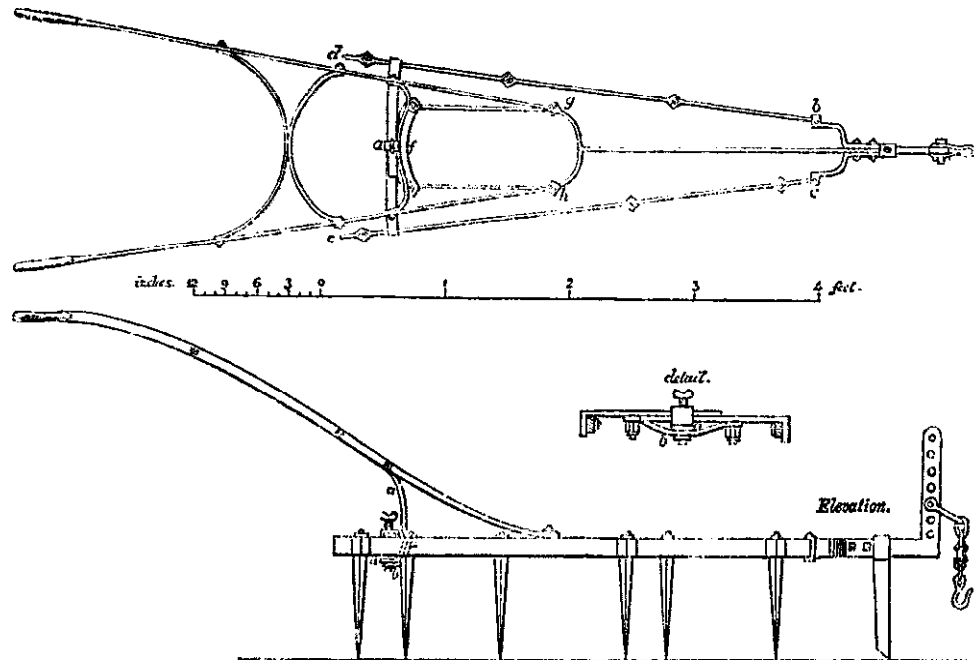

tips, mangokl-wurzel, &c. It is furnished with handles, by which a pressure may be given to the machine, and the teeth forced in to any required depth, and by which its course may be guided without risk of injury to the plants. The teeth are fixed in side wings, *d b* and *e c*, hinging to the front of the framework at *b* and *c*, whose distances from one another is regulated by the screw shown at *a* in all three figures, where the method of widening or making it narrow, according to the nearness of the rows between which it is to act is also shown. The handles are fastened to the central part of the framework at *g* and *h* and at *f*; this central part also carries two of the nine teeth on which the efficiency of the machine depends.

The dimensions of this implement may be gathered from the scale of feet and inches given with the figures. It is intended to stir the land and loosen the weeds in the space

between drills where the horse hoe (see HOE) has already been in operation.

The drill harrow usually costs from £2, 2s. to £2, 10s.

We have yet to mention and describe an implement which has received the name of the Norwegian harrow. It is not, however, properly

Fig. 527.

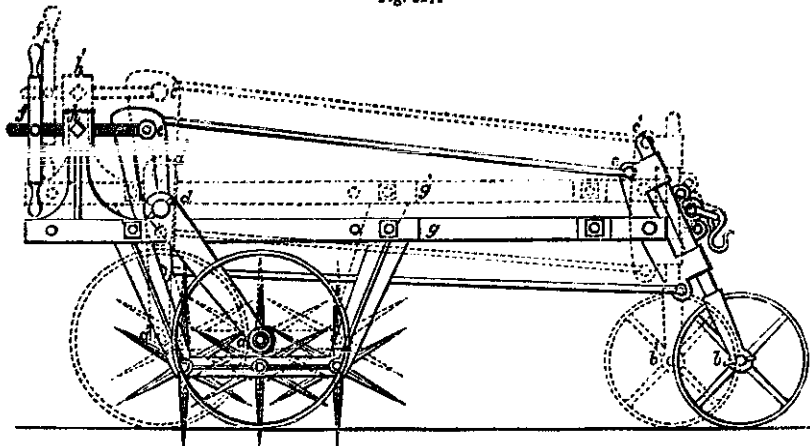

speaking, a harrow, notwithstanding its name. It consists (see Plate XXVII.) of a framework carrying three parallel axles, on which are a number of rowels, each having six radiating prongs, six

inches in length. This framework is slung from another, which travels on wheels; and by means of an elevating apparatus, represented in Fig. 527, where the implement is shown in two different positions, as in the case of the figures illustrative of the article CULTIVATOR, the whole may be raised or lowered, lifted so far as that the machine travels independently upon its wheels, or lowered so far as that it travels wholly on the rowels. In the figure it will be seen that by turning the handle *f* the screw *f e* is pushed through the block *h*, and *e* and *c* are thus pushed away from the back part of the machine; the axles of the wheels *a* and *b* are at the same time pulled away from the horses, and the sloping lines *e a* and *e b* being made to assume the upright position *e a'*, *e b'*, the whole framework of the machine is lifted from the ground. When drawn along in operation, it will be seen that each line of rowels is cleaned by the neighbouring one, the prongs of which revolve between those in the rows imme-

diately adjoining. The effect is, that while the machine acts as a clod-crusher, it at the same time penetrates the land to a considerable depth, and tears the surface to pieces. It is not chiefly as a fallow implement that it is useful, though the breaking of clods, for which it is efficient, is certainly a fallow operation of considerable importance. It is for the purpose of reducing the surface of land to a tilth sufficient to fit it for the reception of seed that it is more particularly adapted; and for the wheat seed especially it is a remarkably excellent preparative, firming the soil at the same time that it prepares a good surface tilth. For the mere breaking of clods, however, it is excelled by Crosskill's clod-crusher, which will be described under the article ROLLER. The price of the Norwegian harrow, covering a width of four feet, as manufactured lately by Messrs. Stratton, of Bristol, and now by Messrs. Fowler and Fry, of the same city, is £15. [J. C. M.]

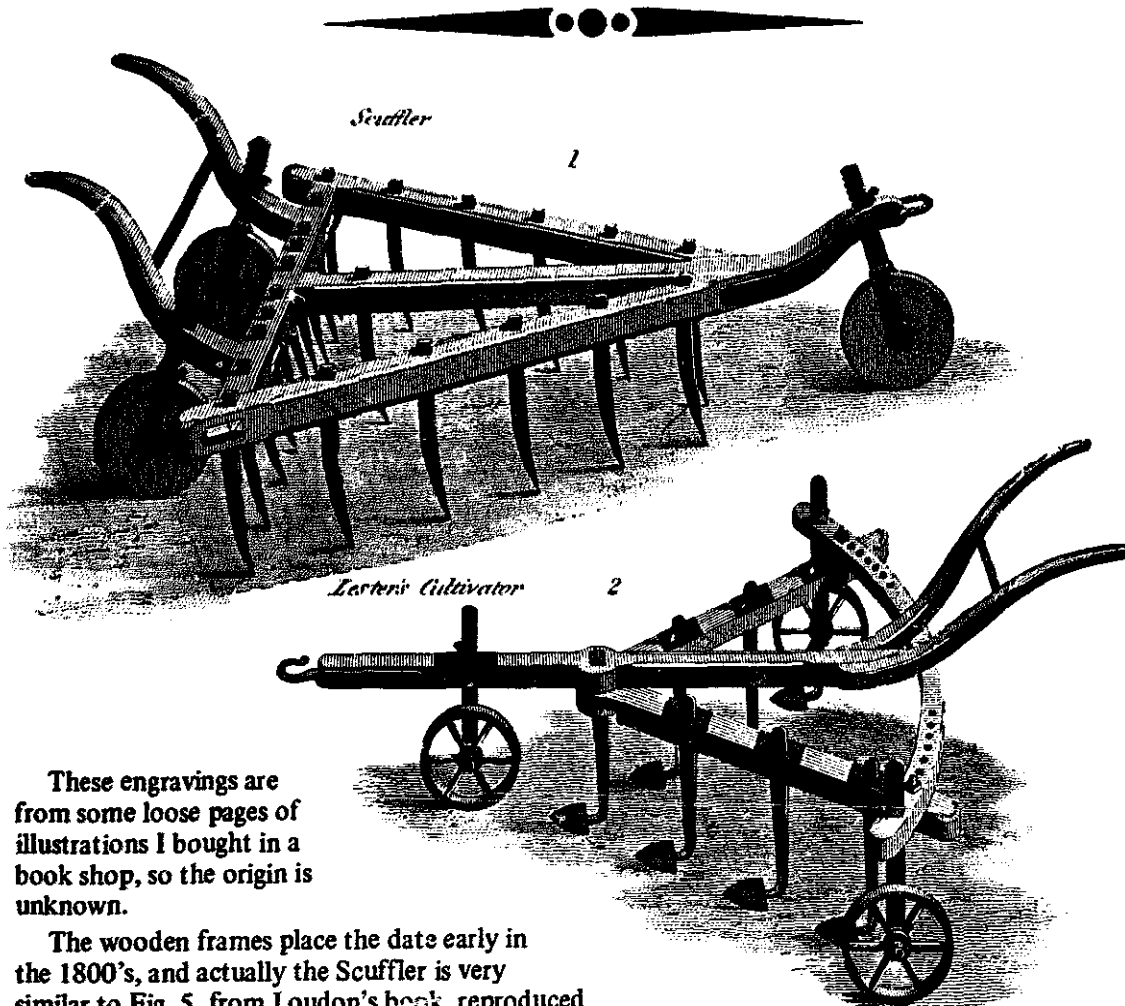

These engravings are from some loose pages of illustrations I bought in a book shop, so the origin is unknown.

The wooden frames place the date early in the 1800's, and actually the Scuffler is very similar to Fig. 5. from Loudon's book, reproduced on page 2. Can any reader place them exactly?

SOWING OF SPRING WHEAT —

The Harrow

from

“The Book of the Farm”
(2nd Edition)
Henry Stevens, 1855

simplest order. So simple, indeed, is this construction, that at a very remote period it appears to have taken that form which, in so far as the simple principles of its action are concerned, is almost incapable of further improvement.” The dimensions of the rectangular harrows are, on an average, 3 feet 9 inches in breadth, measuring over the bulls, and 3 feet 10 inches in length over the slots.

2345. “*The Harrow*—considering the operation it has to perform,” observes Mr Slight, “in covering the seeds that have been cast upon the surface of the soil—is an implement of no small importance; and yet its effects are apparently rude and uncertain, while its construction is of the

2346. The *improved* form given to the harrow, as above alluded to, changes the rectangle into a rhomboid, and this, when duly proportioned, gives to the implement, as has been supposed, as high a degree of perfection, in point of form, as it appears capable of attaining. Fig. 207 represents a pair of the rhomboidal harrows in the

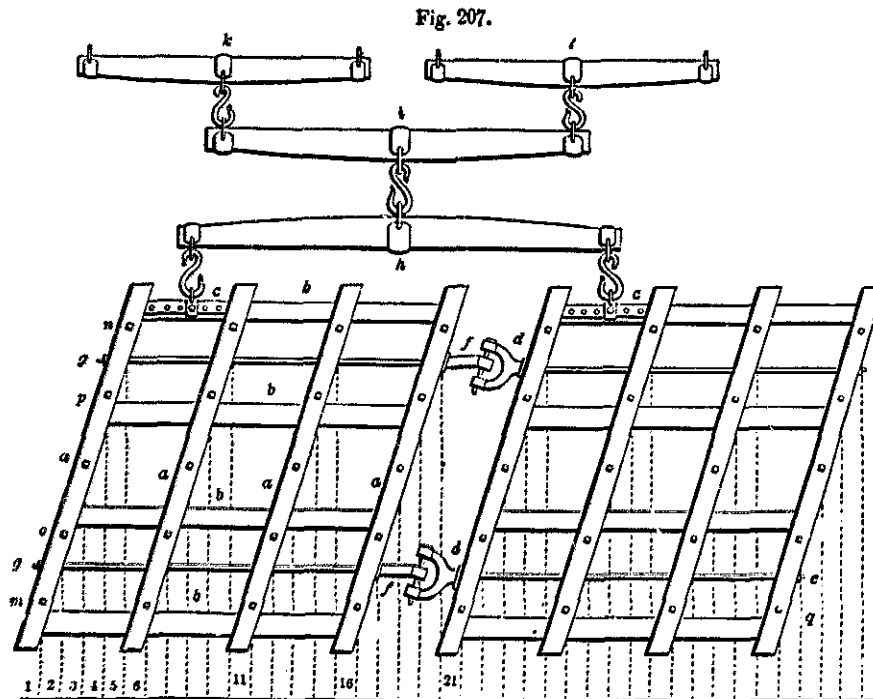

THE WOODEN RHOMBOIDAL HARROWS, WITH THEIR YOKE OF SWING-TREES.

working position. The frame of these harrows consists of the same number of parts as the common sort, above alluded to, four bulls *a a a a*, and four slots *b b b b*. The breadth of the frame over the bulls, at right angles to them, is 3 feet 6 inches, and in the same manner over the slots the length is the same; but the bulls extend at each end 4 inches beyond the slots, making their entire length, including the obliquity, about 4 feet 6 inches. The

dimensions of the parts vary a little, according to the quality of the material employed. In each harrow is an iron bar *c c*, having a number of holes punched in it, for the attachment of the yoke. Each bull is divided into four equal parts, and at each division the bulls are bored with an auger for the reception of the tines. The length of the tine is about 10 inches, of which 6 or 7 inches project below the bulls.

2347. There is one point in the improvement of this harrow that appears of even more importance than the rhomboidal shape—it is the joints or hinges *d d*. In the one harrow, the tail of the double joints of the hinge is prolonged into a bolt *d e*, *d e* passing through all the bulls, and secured with screw-nuts at *e e*. The single joints are in like manner prolonged into the bolts *f g*, *f g* thus serving to add greatly to the strength as well as to the efficiency of the harrows. The loose joints *d f*, *d f* have been found to answer their purpose much better than the well-fitted joints originally given to them, by their allowing a great freedom of action, and the double joints *d d* are therefore now usually made as in the figure. The eye of the single joint *f* has great freedom to play upon the joint-bolt.

2348. From the figure of the rhomboidal harrow, when duly constructed, it can only perform its maximum of effect when drawn forward with its slots at right angles to the direction of its motion, and this is effected by the master swing-tree *h*. This tree, for harrows of the dimensions here described, requires to be 4 feet

8 inches in length between the points of attachment, and it is connected to the harrows by means of the S hooks and shackles at *c c*. The balance of draught of the harrows is adjusted by shifting the shackles into the different holes of the bars *c c*, until the harrows are found to lie at right angles to the draught when in motion; and this, be it observed, is not attained by having an equal number of tines on each side of the centre of the swing-tree *h*, for there is found to be a greater resistance to the forward motion of the implement on the left than there is upon the right side, arising, it is supposed, from the tines presenting a broader surface to resistance on that side than on the other. The other parts of the yoke, *i k l*, are the common plough swing-trees, fig. 6. Wooden harrows cost £2, 15s. per pair.

2349. The extensive application of iron has of late years brought the use of that material to the formation of the harrow as well as of the plough, and iron harrows are now coming very generally into use, both in the rectangular and the rhomboidal form. Fig. 208 represents the malleable-iron rhomboidal harrow, as commonly

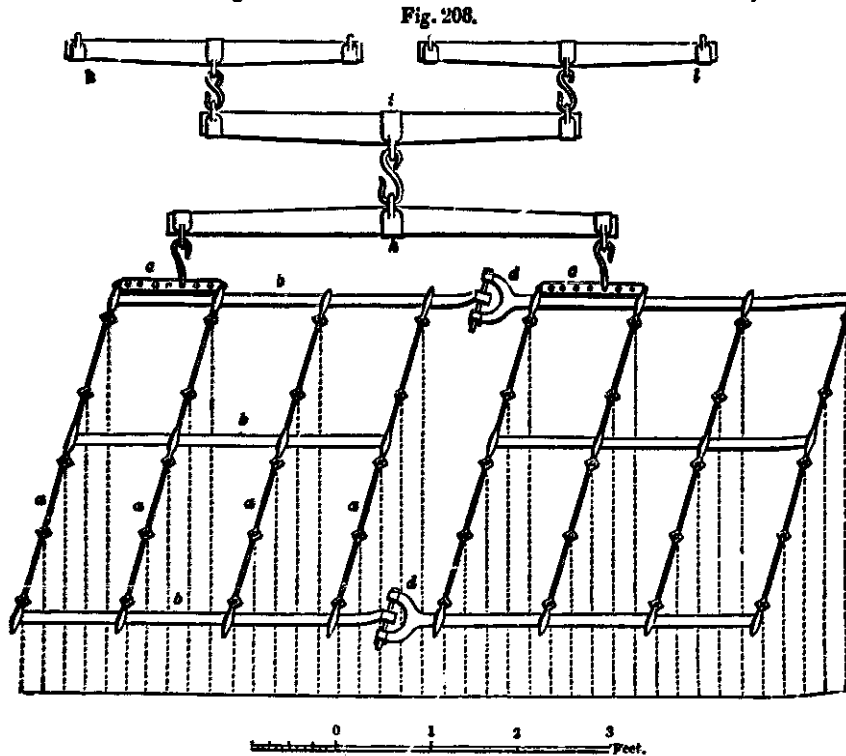

THE IRON RHOMBOIDAL HARROWS, WITH THEIR YOKE OF SWING-TREES.

constructed, and its dimensions are the same as already given for those of wood. The arrangement of the parts are somewhat different, and, from the nature of the materials, the dimensions of the parts differ also more materially. Thus, the bulls *a a a* are swelled out where the mortises for the slots are formed, and also for the tines, their ends projecting only 2 inches beyond the slot. The slots are *b b b*, and there being only three of them, the middle one is so placed as to be free of the middle row of tines; while the end slots are elongated towards the meeting sides of the pair, and are there formed into the hinge-joints *d d*, as formerly described for the wooden harrows. The bars *c c* are inserted in the projecting ends of the first and second bulls, and the master swing-tree *A* is attached to them by twisted S hooks. The swing-trees *i k l* are the same as described for the wooden harrows. The construction of the iron harrow is so similar to the others, that it is unnecessary to enter into further details regarding it; but it may be remarked, that, from the almost imperishable nature of the materials, as compared with wood, there seems every reason to expect the iron implement will entirely supersede the wooden; and though the price of the iron harrows is considerably above that of wood, the additional first cost is more than repaid by the greater durability of the iron. There is good reason also to believe, that, by a construction more adapted than the present to the nature of the material, the price may yet be considerably reduced.

2350. The *form of the tines* is that which has its cross section forming an exact square, and inserted in the bull with its diagonal pointing in the direction of the progressive motion. This form and position of the tine, however well adapted to the soil, cannot, with propriety for safety to the implement, be used in the wooden harrow from the powerful tendency it has to split the wood. In the iron implement this difficulty does not exist; and as this form of tine is in every respect best adapted to the intended purpose, it should never be omitted in the iron harrow. Whatever be the cross section of the tine, in that part which passes through the bull, the projecting part is tapered towards the point, not uniformly but a little barrelled,

and terminates in an obtuse point. In all wooden harrows the tines are simply driven firmly into the wood after it has been bored. In most iron harrows they are fixed in the same manner; but as the tines are sometimes liable to become loose, when simply inserted and driven down by the hammer, they are, when a more perfect construction is followed, fixed by being driven from below, and secured by a screw-nut above.

2351. The dotted parallel lines in figs. 207 and 208 represent the lines which the tines make in the ground in the act of harrowing it; and as they are at equal distances, it follows that the harrows, as in the figures, are set in the proper manner for working. They are wrong set when these lines are not at equal distances.

2352. The *harrows* follow the sowers, each sower keeping 2 pair of harrows employed when the land receives a *double tine*—that is, backwards and forwards on the same ground, that is, on the same ridge, which the *breaking-in of the seed* should always receive. I have said that, on inclined ground, for the sake of the horses, that end of the field should be first sown which gives the horses the advantage of *breaking-in the ground down hill* (2312.) If the sowing commences at the top of the declination, the harrows start at once for the breaking-in down the hill; but if it commences at the foot of the inclination, the harrows will have to go an extra landing to the upper side of the field and begin there. Two pairs of harrows work best together, their united breadth covering the entire ridge, and lapping over the crown where the soil is thickest. One pair takes the lead, by going on the near side of the ridge, while the other pair follows on the off side, but the leader usually takes that side of the ridge which is nearest the open field. Each pair of harrows should be provided with double reins, one rein from each horse; and every ploughman should be made to walk and drive their horses with the reins from behind the harrows. If a strict injunction is not laid upon them in this respect, the two men will be found walking together, the leading one behind the harrows, the other at the head of his horses, with their attention more engrossed in talk than the work in hand.

HARROW

by W.J. Malden

from

"The Standard Cyclopaedia of Modern
Agriculture". 1909

which the name harrow is applied which have wheels, which would be better described as cultivators, as they are used as cultivators to break up land to greater depth than is usually expected of a harrow. The frame of the ordinary seed harrow is now practically always made of iron, and is constructed so as to form diamond-shaped interspaces, the points where the bars cross being slotted to hold the tines, which also brace the frame. In this way no two tines follow exactly in the same place, and practically every portion of the surface is scratched. Usually three of these *zigzag harrows* are worked at once, being attached to a draught pole or bar on which is the draught chain to which the whipple-trees are hooked. These harrows are made in several sizes, from a light one-horse set for harrowing in small seeds, or for a last harrowing after other harrows, to heavy four-horse sets for pulling down coarse furrows on heavy land. *Wooden harrows* are fast disappearing, and in many districts have done so entirely, and it is certain that they are not so economical to work as are modern harrows. They remained popular on heavy clay soils because their weight tended to make them force their way into stiff furrows, but

this is better done by sickle-tine cultivators or harrows. An exception in favour of wooden harrows may be made in respect to the use of very light sets for covering seed on light sandy soils, where lighter harrows than those made of iron are desirable; such harrows are found in Suffolk, where a set will cover a breadth of 20 ft. or more, and be easy work for two horses. As a rule, seed harrows have straight tines, as they

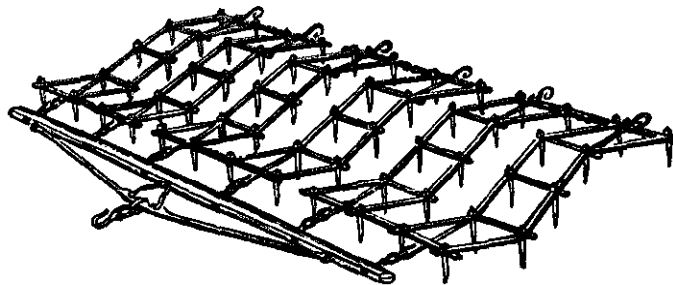

Fig. 1.—Zigzag Harrows

[v. s.]
Harrow. — Harrows are mainly surface-working implements, employed to produce a fine surface tilth and to cover seeds after sowing or drilling; they, however, perform other work, and there is a considerable number of different types constructed to do special work. So far as arable-land work is concerned they may be regarded as light cultivators with many tines, not provided with wheels. Cultivators practically always have wheels, and there are some implements to

are wanted to smother the soil over the seed without disturbing it. Slightly curved tines are sometimes used on harrows to work land, but as they are short, and tend to make weeds collect and block against the frame, the straight ones, which are less liable to do so, are generally preferred. *Rotary harrows* are occasionally used, and work effectively. In these the frame is circular, and the draught is taken from a hinge working round a central vertical arm. A horizontal arm carrying an adjustable weight slightly

depresses one side of the harrow, thus impeding it, which with the forward motion from the

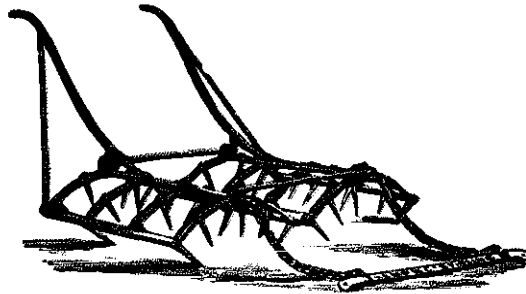

Fig. 2.—Drill or Saddle-shaped Harrow

horses causes the harrow to rotate, thus giving a lateral as well as a forward motion to the tines. Sometimes one large or two smaller har-

rows are used. In spite of the more thorough working, they have not come into general use. *Saddle-back harrows* are used for harrowing ridges laid up for potatoes or roots, to which their shape adapts them, and are very effective and in common use. The *Norwegian harrow* is practically a rotary cultivator: two spindles are mounted on a frame, and these each carry a drum into which are fixed a number of curved tines; the forward motion causes these to rotate, and in doing so they pierce the ground; the same harrowing thus gives a forking or combing treatment, lifting out couch or other weeds. As the two drums are placed sufficiently near for the tines on the hinder one to pass between the tines of the drum in front, the implement is self-cleaning. There are many good features in the Norwegian harrow, but it is not extensively used. *Sickle-tine harrows* are now made with slide guides or other adjustable contrivances for regulating the depth of cultivation.

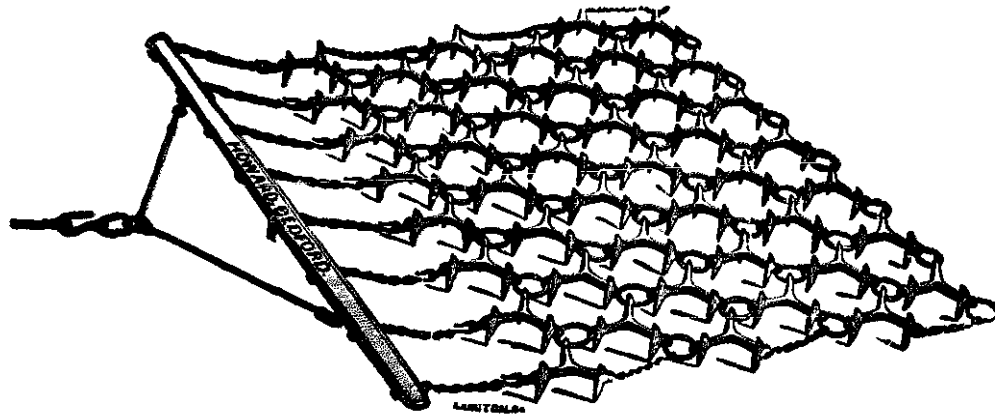

Fig. 3.—Howard's Flexible Grass Harrow. Can be worked either side up, to use the long or short points.

They are chiefly used for working down furrows, but are not well suited for covering seeds. *Flexible harrows* are now made in many forms, and there is a great increase in the extent of their use, especially on arable land. Being light and effective they are well suited to work down land, cover seed, collect couch, and destroy annual weeds such as charlock; moreover, they are effective grass harrows. This type is associated with Parmiter of Tisbury, who introduced them; they differ from flexible, chain, or link harrows in that they are provided with sharp cutting tines. *Steam harrows*, or harrows used in steam cultivating, are heavy, fitted with a stout frame, and are better suited for breaking down coarse furrows than for use as seed harrows. *Steam drag harrows* do the work of heavy horse cultivators. *Disk harrows*, very much used in the colonies, are becoming increasingly popular in Britain, and do

excellent work when breaking up temporary or permanent pasture, as they cut the turves and masticate them. They are also suitable for working down land under ordinary conditions.

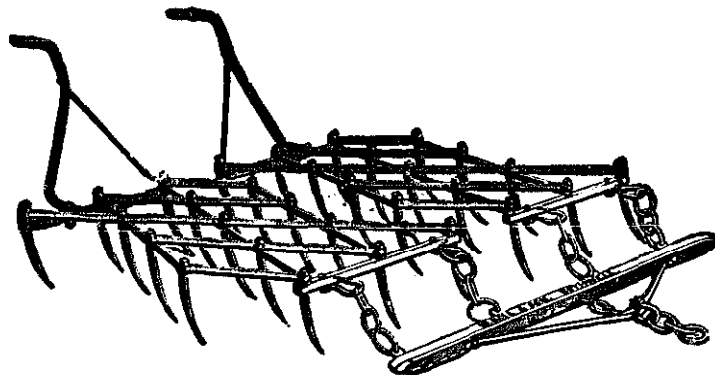
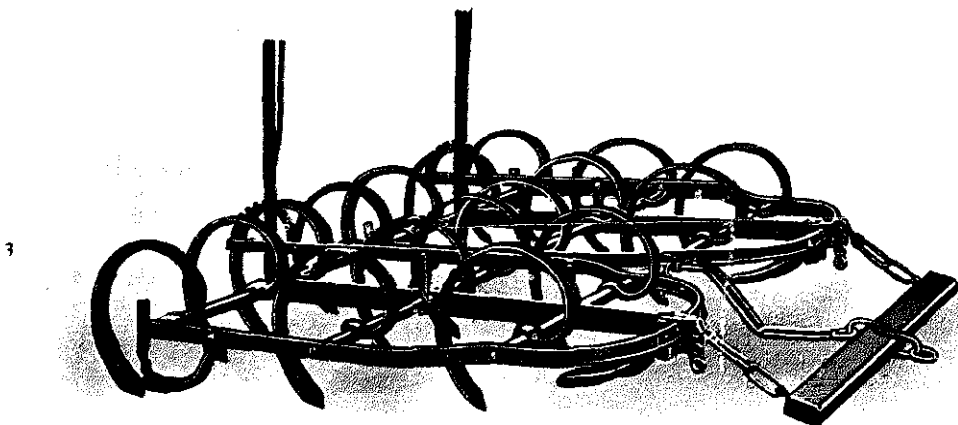
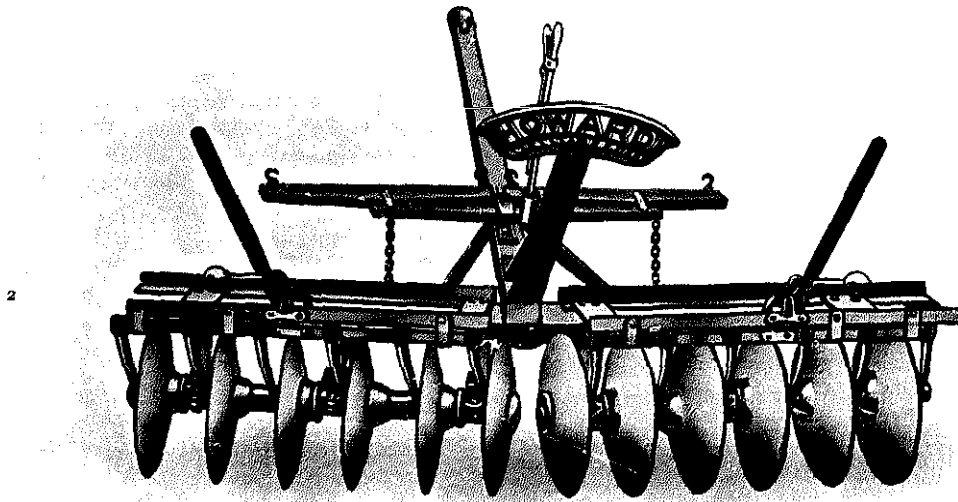
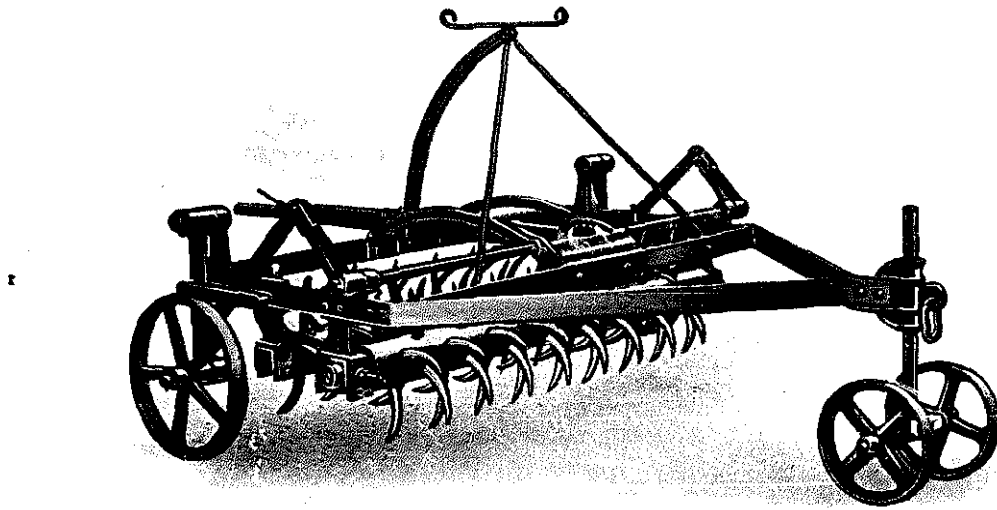

Fig. 4.—Ball's Twitch or Drag Harrow

Drag harrows are stout cultivating harrows with curved tines, very commonly used. *Wheeled drag harrows* are light cultivators with numerous small curved tines.

[W. J. M.]

HARROWS



1, Stanford's Norwegian Harrow. 2, Howard's Disc Harrow. 3, Spring-Teeth Harrow

ROLLER

from

“The Rural Cyclopaedia”

J.M. Wilson, 1847

ROLLER. An implement for compressing, smoothing, pulverizing, or otherwise finishing-off cultivated land, whether in grass or in tillage, in preparation for sowing or subsequent to sowing, in a newly sown state or after the appearance of the nascent crop. Both the forms and the uses of the roller, in fact, are exceedingly diversified; and some of the most useful implements of the roller class differ so very widely from all the old and common rollers, and at the same time from one another, as to take to themselves peculiar names, such as drill-roller, seam-presser, and clod-crusher.

All the old or early rollers were simply cylinders, and may be supposed to have been employed only for breaking down the cloddy and lumpy portions of tilled stiff soil preparatory to sowing, and for compressing and smoothing and consolidating light and driftable lands immediately subsequent to sowing; and such rollers are still confined to the same principal uses, with the addition of the smoothing and compressing of grass lands. They are thought by some writers to have come into existence coevally with the plough, or with the rudest stirrer of the soil, or at least to have appeared immediately after it,—and certainly they occur in countries where agricultural processes are in a very rude and almost nascent

state; yet they are assigned by other writers to an epoch later than the harrow, and even than the grubber,—or to one in which the pressure of increasing population drove farmers by necessity to the cultivation of stubborn and adhesive soils, and compelled them to invent mechanical means for breaking hard clay clods. The cylindrical roller, at all events, is known to have been till recent times the only implement of its class; and though this might seem to a superficial thinker to have been quite simple and unique and incapable of variety, it really received, in the course of time, a great diversity of size and weight and construction, and was made first entirely of wood, then of stone with a wooden frame, and then in various ways of iron, and came at last to be formed of two or three or more parts, revolving either on the same axle or on independent axles.

The common rollers, or land-rollers, of the present day comprise all the varieties which have ever been used, except the most rude and ancient. The wooden ones are either pieces of heavy solid timber, of the full diameter of a large tree, or hollow cylinders, variously constructed, and of comparatively large diameter; and though they make little impression on any but very light soils, they are highly serviceable for levelling potato or turnip drills, for compressing the earth about newly sown seeds, and for some other and analogous light purposes. Some are spiked with iron or encircled with large metallic rings, to assist in crushing clods; many or most have simple contrivances, generally a weight-containing box on the upper part of the frame, for temporarily increasing their weight and pressure; and all are mounted with a skeleton cart-like frame, terminating in shafts for one or two horses, or with attachments for four or even six oxen, according to their respective size and weight. The common solid wooden rollers of England are usually made of oak or ash, and generally vary from 5 to 7½ feet in length, from 16 to 20 inches in diameter, and from 10 to 15 cwt. in weight, but occasionally are 9 feet in length, from 20 to 30 inches in diameter, and so heavy as to require to be drawn by 4 horses or 6 oxen. A very common roller in Scotland 20 or 30 years ago, and one most easily and cheaply procured, had a wooden axle, with two or three rows of spokes placed in it according to its length, and felloes placed on the extremity of the spokes in the manner of a cart-wheel, and planks or boards of wood fastened on the felloes all round; and a closely similar roller, of still more facile construction, is now occasionally made in England, with three broad wheels of the required diameter,—two of them placed at the ends and the other in the middle of the required length,—and with an iron axle passing through the whole, and adjusting them to their positions, and with strong, narrow, bevelled planks nailed firmly lengthwise round all the exterior. Some hollow wooden rollers

have an octagonal instead of a circular circumference; and they do their work better than the circular ones, on account of each turn laying the flat surface with a momentum on the ground; but they require a greater power of draught. Many wooden rollers, also, as well as many stone and many iron ones, are double, or consist of two pieces, placed in one frame, and performing the same action as one piece, but rolling independently of each other; and not only are these much more convenient in turning than single rollers, and less severe on the team, but they are more suitable for light soils or corn crops or sown grass, in consequence of their neither tearing up the ground nor injuring the young plants at the end of a field.

Stone rollers of granite, or of hard, compact, crystalline trap, are very common in districts which abound with these materials, and are both very cheap and very efficient. They are usually made of from 12 to 16 inches in diameter; and, including the cost of both frame and scraper, they are sometimes from 5 to 10 times cheaper than equally efficient wooden ones, or from 8 to 12 times cheaper than equally efficient iron ones. They have the high advantage also of being easily and cheaply obtained of a great diversity of size and weight and mutually proportional length and diameter; so that from 5 to 12 of them of different kinds, in adaptation to different soils or different states of soil or different kinds and conditions of land and crop, may be kept on a farm for the price of a single roller of iron or of wood.

Iron rollers of the common cylindrical kind are the most common for gravel-walks, lawns, parks, and other land-surfaces which require to be kept firm and smooth; and they are also common for ordinary agricultural purposes, in some districts which are destitute of granite or compact trap; and they possess the advantage of admitting a temporary increase of their pressure by means of suspending weights on their axis. They are made of great diversity of size and proportions to suit a corresponding diversity of tastes and purposes; and one of the most approved, for ordinary agricultural uses, is double, or has two separately revolving parts, and weighs from 10 to 15 cwt., and is drawn by two horses; while another has three separate cylinders, each about two feet in diameter, and of the same length. As cast-iron rollers are liable to fracture when drawn along a rough road, in transit from one field to another, a small low-wheeled wooden carriage may be kept for the purpose of transporting them.

Booth's roller was invented by the late George Booth of Allerton, near Liverpool, and comprises five cylindrical pieces, arranged alternately three in one line and two in another, and so constructed on the lever principle that they may be pressed down by weight, and possessing each a diameter of not more than a foot. "Mr. Booth," says Mr. Ransome, "contended for solid

rollers of very small diameter, as the most effective in crushing the clods, and throwing the greatest weight on the surface of the ground. From this opinion I venture to differ, believing that whatever advantage may arise from small diameters, it is more than counterbalanced by the difficulty of surmounting clods and other obstacles, and their consequent tendency to drive them before the roller, which would also cause increased labour to the horses."

Spiked rollers are used to reduce the lumps and clods of clay soils. Those of the simplest form consist each of a single wooden cylinder, with spikes of about 3 inches or so in length, inserted quincunxly or in some other regular order; and these perform their work pretty well when the land is dry, but become clogged and inefficient when the land is moist. But the better kinds of spiked rollers have each two cylinders, the one placed before the other, both armed with regular and mutually alternate rows of spikes, and the two adjusted so closely together as to intersect each other's rows of spikes, and in consequence constantly cleanse each other in all their revolutions. One of this class, described in the Leicester Report, has rollers of about 9 inches in diameter, armed with eight rows of spikes, fixed in a frame, mounted on wheels of about 3½ feet in height, and provided with an upright post windlass and power of pulleys to raise or lower the rollers at pleasure.

The Earl of Ducie's improved clod-crusher has two parts or lengths in the manner of the common two-cylindrical iron roller; but instead of a continuous surface, it has from end to end, round all its circumference, a series of square wrought-iron bars; and it presents the angles of these bars to the clods, so as readily to penetrate and reduce them. It acts well in its proper capacity of a clod-crusher, and at the same time is useful for rolling or pressing wheat in the spring.

Bartlett's cultivator is a roller of 13 thin iron plates of 15 inches in diameter, each fastened to a circular block of wood 4 inches thick, 9 inches in diameter, and bound round with iron,—the plates and the blocks strung together on an iron axle, and made moveable upon it,—and the whole adjusted in roller-style within a strong quadrangular frame, and subtended by a bar with fixed iron scrapers, which keep the roller continually clean. This implement is said to be serviceable in the tillage of wet lands in the extreme south of England; and it may be made with plates and blocks of other sizes than those which we have named, or those adopted by the inventor.

The double-jointed barley-roller is simply a variety of the common two-cylindrical or three-cylindrical iron roller; but is so constructed that the parts may revolve at opposite angles,—and may also, for convenience in travelling or for any special purpose in tillage, be placed the one behind the other. Its framing, too, is often so con-

E

structed with twisted joints, as to make the inner end of one part work behind the end of the other, so that no seam is left between them.

Lord Strathmore's soil-consolidator is a combination of machinery for the purpose of consolidating loose soils. First in it are two common rollers; and these put in motion two wiper shafts; and these lift, in continued rotation, a number of stampers, which are let fall on the soil while the machine is travelling over the surface.

Drill-rollers have a series of stout metallic rings, upon an axis, each commonly about $2\frac{1}{2}$ inches thick, and sometimes so much as 3 feet in diameter; and they are used either without weights for making grooves ready on light soils to receive the seeds of a broadcast sowing, or more or less heavily laden with weights to crush the clods of rough and strong land in the manner of common or of spiked rollers. They have long been known to the farmers of Norfolk and Suffolk, and were a highly appreciated implement so long as 40 years ago; and they have of later years been variously improved,—but principally in rendering each ring independent of the others, so as completely to accommodate their action to diversities of surface, and to facilitate their turning at the end of fields. When a drill-roller is used for crushing clods, it requires to be followed by a harrow of sufficient weight to lighten up the surface; but when it is used for making grooves preparatorily to broadcast sowing, it should not be followed by anything heavier than a fine short-toothed harrow, or even than a mere bush-harrow.

The seam-presser or land-presser or pressure-roller is an abstract of a drill-roller, and has but two double conical wheels for pressing, and is greatly employed in some districts for rolling down the soil newly turned up by the plough, or for closing the furrow-seams of a seed-furrow from lea. The two double conical wheels are set upon an axle, at about 10 inches apart, and are situated on the one side of the machine-frame; while a common wheel supports the other end of the axle, and occupies the corresponding side of the frame. The machine, in working, follows in the wake of two ploughs; its conical wheels run in the seams of the last turned-up furrows; and its common wheel runs upon the unploughed land. It acts more effectually than the drill-roller, and directs its whole force upon each furrow, and gives a firmer bottom for the germination of the seeds, and tends to retard, if it does not altogether prevent, the insidious operations of the wire-worm.

The conical grooved pulverizing land-roller, was invented by J. Stewart Hepburn, Esq., of Colquhalzie in Perthshire; and is described and figured in the 11th volume of the Highland Society's Transactions. It comprises three varieties, and has, as its chief characteristic features, a conically diminishing instead of a cylindrical form of roller, and a series of transverse parallel

flutings round the roller's surface. Two of the rollers or conical frusta are adjusted in one frame, base to base, and have their axes so inclined that both the fore-part of their peripheries and the parts in contact with the ground are always in a straight line. The frame is the same as that of a common roller; and three perpendicular bars from it carry the axes of the two rollers; and a light horizontal frame with scrapers is adjusted behind the rollers to clear the grooves of the rollers when at work from all adhering soil. "The effects of such a form of roller upon the surface of the soil," remarks Mr. Slight, "are peculiar and important. While the cylindrical smooth roller acts merely by its pressure on the rough soil intended to be pulverized, one of a conical form, arranged in the manner of Mr. Hepburn's, will, besides acting by its direct pressure, produce a strictly pulverizing effect, by reason of its form; for the cones having a constant tendency to move outward in a circle, but being restrained by the bearings in which they revolve, their surface will produce a crushing and abrading action well adapted to the pulverization of the soil." *Plate LI.*

Crosskill's patent clod crusher is, in several respects, a remarkable and very valuable implement, and was pronounced by the judges to be, with its latest improvement, the most beneficial implement used in agriculture exhibited at the Newcastle Meeting of the Royal Agricultural Society in 1846. "Mr. Crosskill," says the official Report of that Meeting by Mr. Parkes, "about the year 1832 imagined the form of this roller. His first plan consisted in forming a barrel, by stringing a number of narrow indented rims or discs loosely upon a square axis, the whole revolving, together with the axis, in the journals of the frame. In addition to the saw-like teeth into which the periphery of each rim was divided, other teeth were formed, projecting sideways from the plane of the rim, and in a radial line from the centre, so as to leave no portion of the soil unoperated upon. This roller gradually fought its way into considerable practice, being found to effect a much greater amount of superficial pulverization than the common plain roller. Extended experience disclosed other uses than mere clod-crushing, to which it was applicable; and at the same time pointed out defects which deteriorated its performance and diminished its value. The rolling of young wheat and spring corn, or other plants, was commenced with it, and usefully; but it was found that, on turning short at the headlands, injury was done by tearing up the soil in the act of turning. A greater scope for turning than is convenient was, therefore, necessary to avoid this evil. Another evil resulted when using it on soils at all damp or sticky, from the adhesion of earth to the teeth and their interstices, which further limited its useful employment. Mr. Crosskill, observing these defects, applied himself to their remedy,

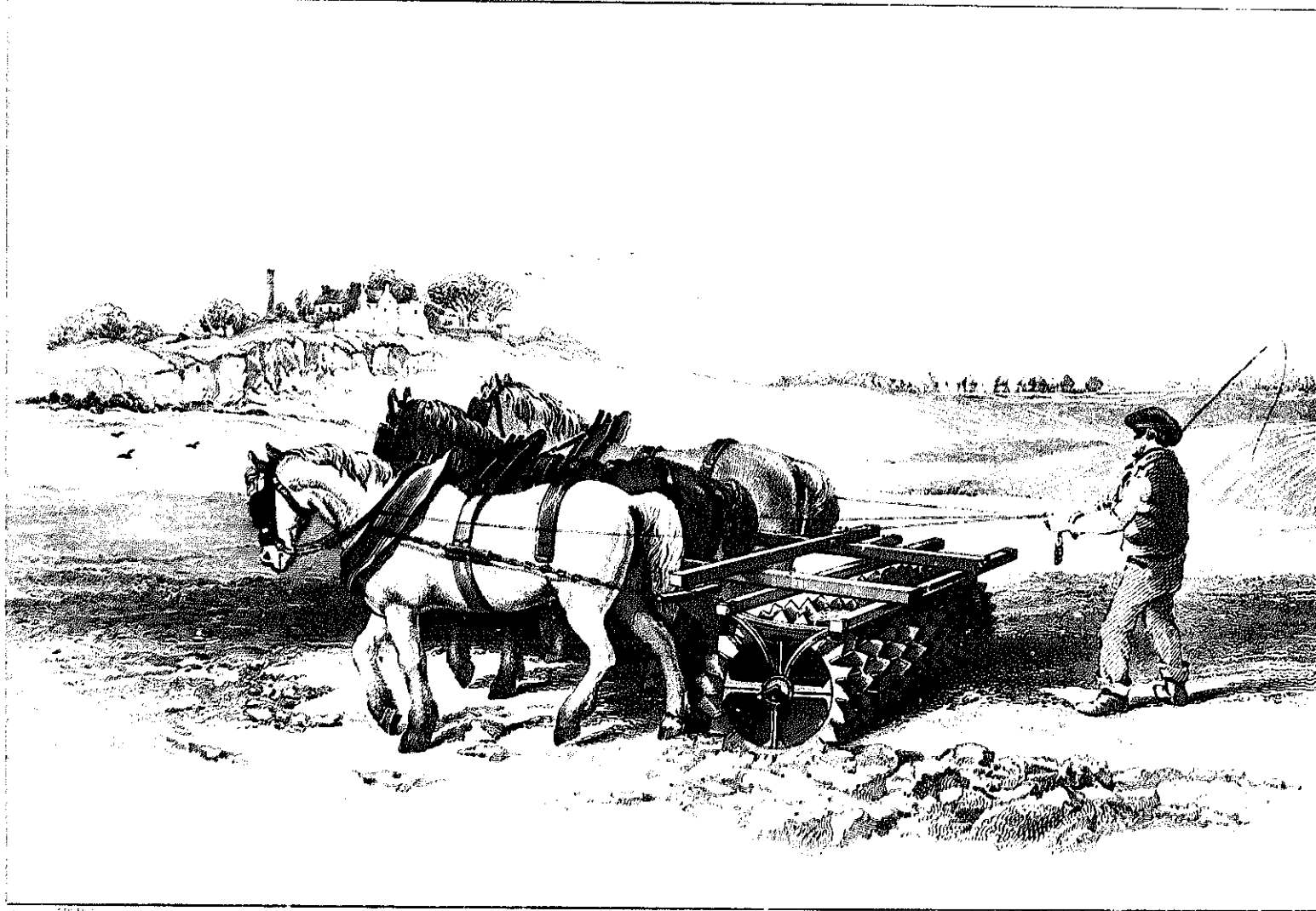

A. Fullerton & Co. London & Edinburgh.

HEAVY DRAFT HORSE POWER

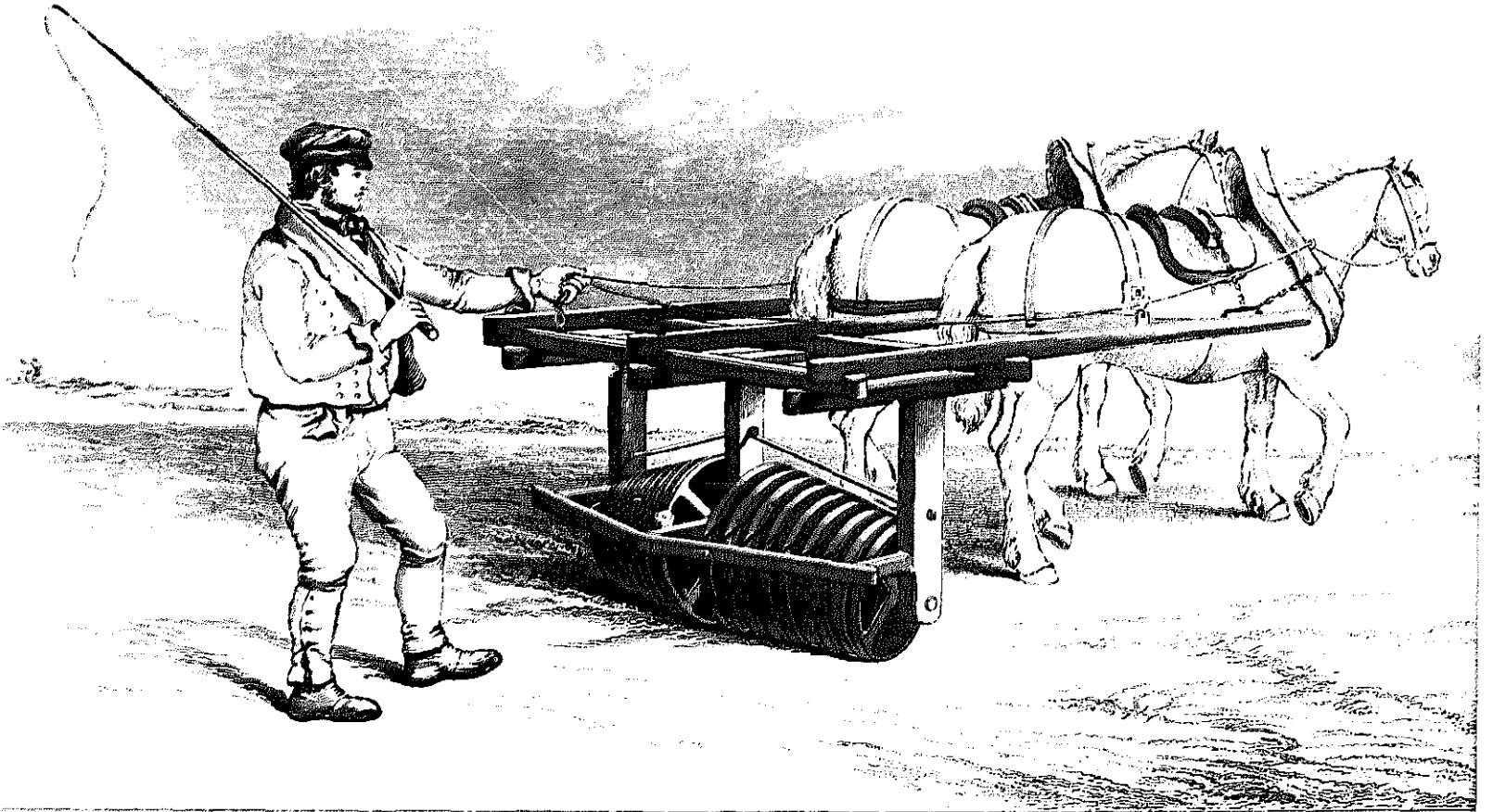

and in 1842 he took out a patent for the present implement, the improvements consisting, first, in setting each toothed rim free to revolve separately on a round, instead of their being fitted on a square axle; and secondly, in giving a different form and direction to the lateral teeth. By the first-named alteration the independent action of each rim was secured, so that each rim, in the progressive movement of the whole series, revolves upon its axis, and at the rate exactly due to the space to be travelled over in surmounting the irregularities presented to it; whilst in turning, all tearing of the soil or plants is avoided by the same faculty, which permits every rim or disc to adapt its velocity to the space required for each one to pass over, either forwards or backwards, in the act of turning; in fact, this roller can be turned about on the centre of its axle without producing any injurious effect. The independent motion of the rims also provided a powerful means of self-cleaning; for, inasmuch as the velocity of the several rims is perpetually varying, so they rub off the soil which might otherwise adhere to them—an action now further increased by enlarging the bore of the eye of each alternate ring, which causes a kind of eccentric or up and down motion to take place between each pair, and among the whole series of rings or discs. This last improvement consists in the enlargement of the eye of each alternate ring, forming collectively the series of rings or discs of which the roller is composed; so that of these rings, which are 23 in number, 12 have eyes fitting the axle just freely enough to revolve upon it, whilst the 11 alternate rings have their eyes enlarged about half an inch more in diameter. This arrangement has added materially to the effect of the implement in abrading and reducing hard clods; it has also induced among the rings a more efficient self-cleaning movement, when the roller is used on moister soils or softer clods; so that, practically, the scope and power of the roller have been augmented, without adding to its cost, or impairing its extreme simplicity; and it can now be employed on soil when in states which would have clogged it, or have diminished its effect if all the rings on the axis had eyes of similar size. The superior results arising from this disposition of parts are altogether attributable to what is properly termed action—mechanical action; and it has been owing to its possessing this function in so high a degree, that Mr. Crosskill's patent-roller has proved to be more effective in comminuting and compressing soil than the common plain roller, or than the serrate-edged ringed-roller with a square axle, first introduced by him. Mr. Crosskill's square-axle toothed roller first made its appearance in the Society's show-yard at Cambridge in 1840—the round axled patented machine at Derby in 1843—a premium of £20 was awarded for it by the judges at Southampton in 1844—and it gained the Society's prize of £10

at Shrewsbury in 1845, having on all occasions of trial at the Society's shows greatly excelled the performance of every other roller brought into competition with it. The fourth volume of the Royal Agricultural Society's Journal contains a large collection of instances of its utility in arresting the ravages of the wire-worm—an effect owing probably to the forcible bite of the teeth on the ground—in the pulverization of stiff, and compression of light soils, together with the opinions of numerous agriculturists upon its value as a roller of various crops in a state of young growth. Its application to the latter purpose has greatly extended since that period, and the writer may bear his testimony to the success attending its employment on pasture land in destroying the white slug, curing mossiness, and especially in consolidating soft grass-land after drainage. For these latter uses the effect of the implement is greatly enhanced by weighting it to the full extent of the power of the team which can be commanded." See the article ROLLING.

Garrett's patent clod-crusher and cultivator has also a heavy, rough, biting surfaced cylinder, and comprises a patent improved method of heightening or lowering the wood carriage wheels, so as to produce any required degree of pressure in working, and to obviate all difficulty in removing the implement from field to field. This roller acts very powerfully in crushing clods on heavy lands; and is peculiarly suitable after a drought, or in a very dried state of the soil, for preparing fallow lands for root crops, and for pulverizing hard and cohesive cloddy surfaces, and raising mould for the barley seed. Some very experienced agriculturists who have tried it recommend it as most desirable for preparing clover lands for wheat, by rolling it once or twice over the ploughed and dried land, in order that it may thoroughly press down the flag, and raise an inch or more of mould on the top; for when the implement is so set upon the travelling-wheels as to enter the ground to the depth of $1\frac{1}{2}$ or 2 inches, it gives that firmness to the under soil which is so desirable for wheat, and presses down the flag so closely as not to admit any harbour for the slug, and at the same time acts as a preventative of the ravages of the wire-worm.

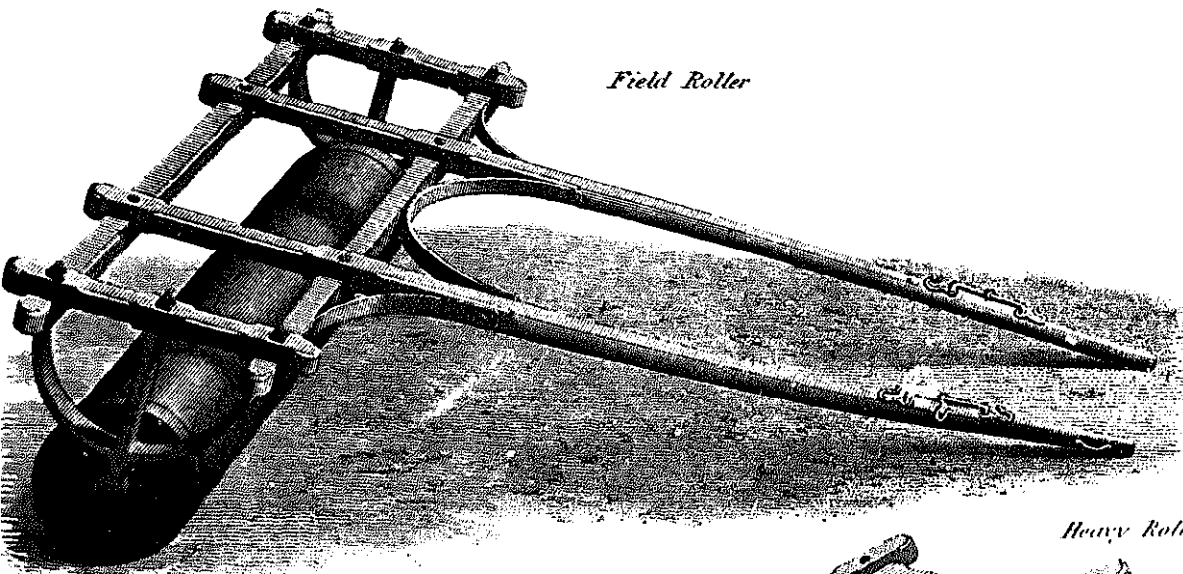

Field Roller

These engravings are from the same unidentified source as those on page 67.

The particular reason for including them is to illustrate the 'Siamese Twin' arrangement of double shafts on the heavy roller. I had never seen this before, and perhaps Hepburn's roller on page 67 might have the same feature.

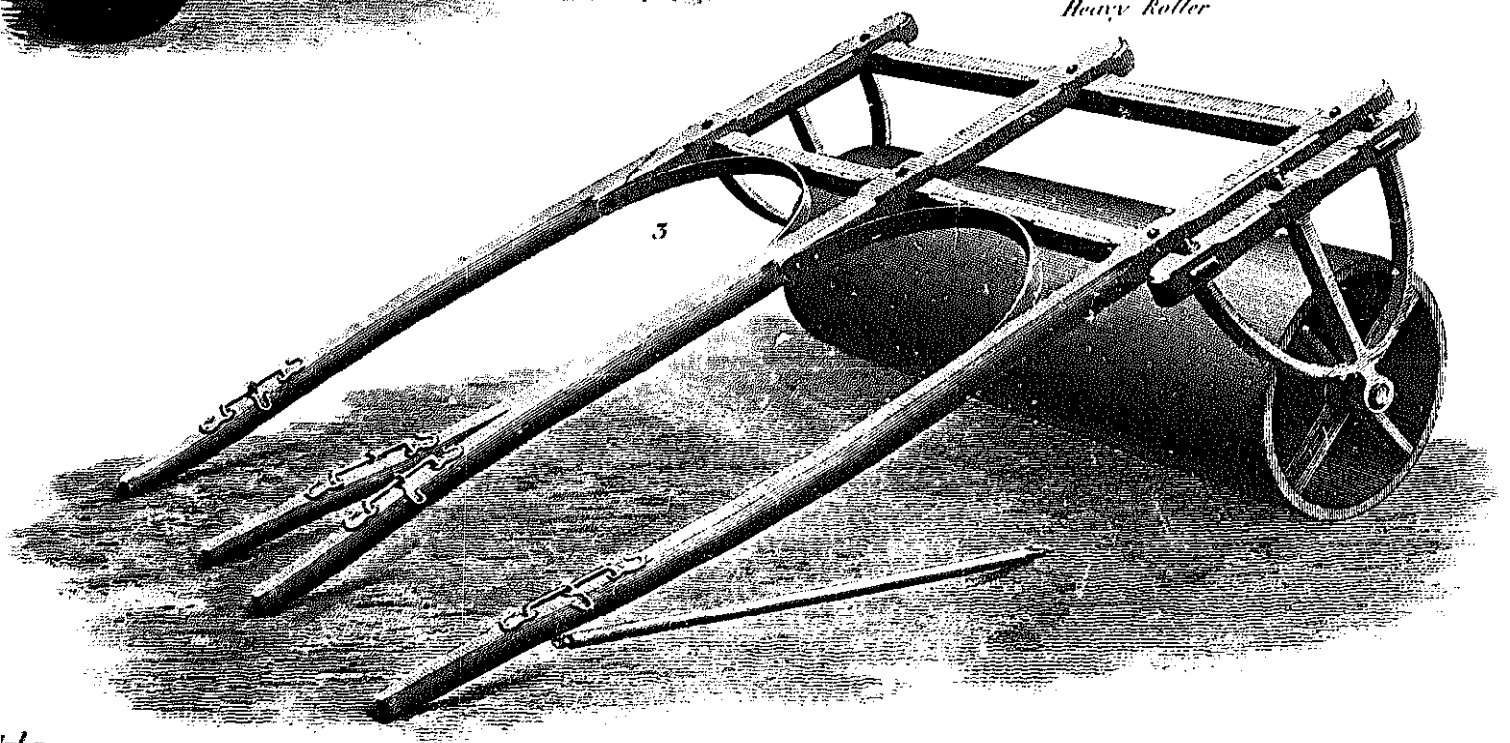

Heavy Roller

ON THE ROLLING OF LAND

from

“The Book of the Farm”
(2nd Edition)
Henry Stevens, 1855

ON THE ROLLING OF LAND.

2473. The common *land-roller* is an implement of great simplicity of construction, the acting part of it being a cylinder of wood, of stone, or of metal. Simple as this implement appears, there is hardly an article of the farm in which the farmer is more liable to fall into error in its selection. From the nature of its action, and its intended effects on the soil, there are two elements that should be particularly kept in view—*weight* and *diameter* of the cylinder. By the former alone can the desired effects be produced in the highest degree, but these will be always modified by the diameter. Thus, a cylinder of any given weight will produce a greater pulverising effect if its diameter is one foot, than the same weight would produce if the diameter were two feet; but then the one of lesser diameter will be much worse to draw; hence it becomes necessary to choose a mean of these opposing principles. In doing this, the material of the cylinder comes to be considered. Wood, which is frequently employed for the formation of *land-rollers*, may be considered as least adapted of all materials for the purpose; its deficiency of weight and liability to decay renders it the most objectionable of all others. Stone, though not deficient in weight, possesses one marked disadvantage, liability to fracture; this of itself is sufficient to place stone rollers in a

doubtful position as to fitness. This brings us to cast-iron, which is undoubtedly the most appropriate of all materials for this purpose. It is unnecessary here to enter into the inquiry as to the most advantageous diameter for a *land-roller*; the subject has already been elaborately discussed: † let it suffice to say, that experience has proved that a diameter of 2 feet is, under any circumstances, the one that will produce the best effects with a minimum of labour from the animals of draught; the weight being of course proportioned to the force usually applied, which is in general 2 horses. The weight of roller, including the frame corresponding to this, is from 12 to 15 cwt.; but it is better that the roller itself be rather under the weight, and that the carriage be fitted up with a box, in which a loading of stones can be stowed, to bring the machine up to any desired weight. Such a box is besides useful in affording the means of carrying off from the surface of the ground any large stones that may have been brought to the surface by the previous operations. In a large and heavy roller, in one entire cylinder, the inconvenience of turning at the headlands is very considerable, and has given rise to the improvement of having the cylinder in two lengths; this, with a properly constructed carriage, produces the *land-roller* in its most perfect form.

2474. Fig. 222 is a perspective of the *land-roller* constructed on the foregoing principles: *a* is the carriage-frame, crossed by the horse-shafts *b*. The cylinder *c* is in 2 lengths of 3 feet to 3 feet 3 inches each, and 2 feet in diameter; the thickness of the metal is according to the weight required. The axle, in consequence of the cylinder being in two lengths, requires to be of considerable strength, and of malleable iron; upon this the two sections of the cylinder revolve freely, and the extremities of the axle are supported in bushes in the semi-circular end-frames. Two iron stay-rods pass from the end frames to the shafts as an additional support to the latter. The price of the *land-roller*, fitted up as here represented and described, is, according to weight, from £10 to £14.

* Lawson's *Agriculturist's Manual*, Supplement, p. 48.

† *Quarterly Journal of Agriculture*, vol. i. p. 700.

Fig. 222.

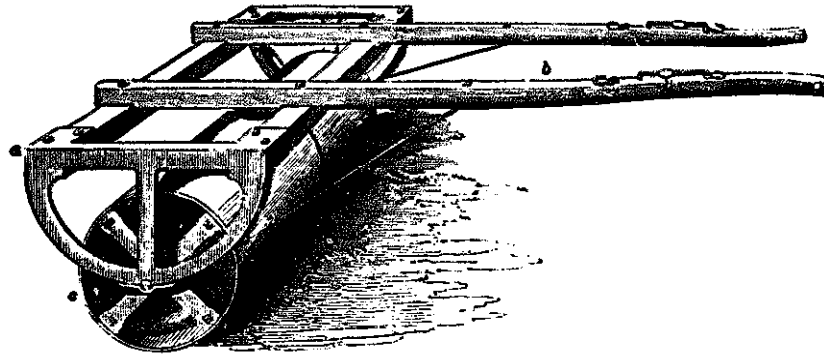

THE LAND-ROLLER.

2475. In using the roller, the 2 horses are yoked in the same manner as in the double horse-cart, shown in Plate III. The rolling is always effected across the line of ridges, for otherwise the open furrows would not receive any benefit from it. Although the dividing of the cylinder into two parts facilitates the turning of the implement, it is not advisable to attempt to turn the roller sharp round, as part of the ground turned upon will be rubbed hard by the cylinders; and where young plants grow upon those parts, such as young clover, the probable effect would be to kill them. The rolling is executed in fees of 30 yards in width, *hieing* the horses one half of the feering, and *hupping* them in the other half, the same as in ploughing ridges, two-out-and-two-in, fig. 25. It is not necessary to carry the feering-poles to the field for making these feerings; the first line of the feering being easily kept straight across the field by placing clods or stones in the line. When the ploughman becomes fatigued in walking, it is quite allowable for him to sit on the front of the framing, for which purpose a space to sit upon is either boarded or wrought into a seat with hard-twined straw-rope, and thence drive the horses with double reins and whip. With such an indulgence a frail ploughman, employed mostly in ploughing, could take a day or more at rolling, when urgent work was employing at the time the stronger horses in the cart. Were a 6-foot roller to proceed uninterruptedly for 10 hours, at the rate of $2\frac{1}{2}$ miles per hour, it would roll about 18 acres a-day; but what with the time spent in the turnings and the

markings-off of feerings, 14 acres a-day may be considered a good day's work—7 acres at each yoking. When the weather is favourable, and a large extent of ground has to be rolled, it is a good plan to appoint 2 pair of horses to work the roller, from dawn to night-fall, each pair working 4 hours at a time. In this way, 16 hours' constant rolling, from 4 in the morning to 8 at night, may be obtained in the course of 24 hours, and $33\frac{1}{2}$ acres rolled within the day with one roller. This roller is an instrument used not so much to crush clods as to render the surface of the ground smooth; at least it effects the latter purpose much better than the former, which is best executed by a class of implements named clod-crushers, to be afterwards described; and the roller should only be used when the surface of the ground is dry.

BOOKS by John Thompson

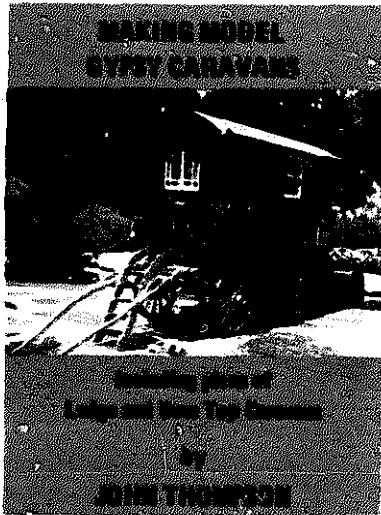

"MAKING MODEL GYPSY CARAVANS"

The Gypsy Caravan is probably the most popular horse-drawn vehicle as a subject for modelmakers, and no wonder for it gives scope not only for woodwork and metalwork, but for carving, colourful painting, and the making of internal fittings. This large format book is very fully illustrated with photographs and plans, and deals with all the aspects from choice of materials to finishing the model.

There are detailed notes on the construction of the ornate Ledge waggon and a little Open Lot Bow Top, whilst the beginner is catered for by a simple plan for a Showman's caravan. Bound in a card jacket with full colour photograph.

Also Making Model Horse Drawn Vehicles

THE "HORSE-DRAWN" SERIES OF SOURCE BOOKS

The books in this unique series all comprise fascinating extracts from makers' catalogues, trade journals and out-of-print books from the 19th Century, when horse-drawn transport was dominant on the roads and farms. All these volumes are fully illustrated, from the original clear engravings, and provide a wealth of detailed information for the enthusiast and the modelmaker.

Available from bookshops, or direct from the author.

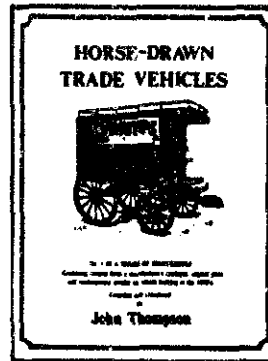

- Horse Drawn Trade Vehicles
- Horse Drawn Goods Vehicles
- Horse Drawn Farm Implements
 - Part I Ploughs
 - Part II Preparing the Soil
 - Part III Sowing and Haymaking
 - Part IV Harvesting

In course of preparation:-
Horse Drawn Carriages
Horse Drawn Farm Vehicles

"THE EAST YORKSHIRE & CROSSKILLS CART & WAGGON CO. LTD." 1904 CATALOGUE

The facsimile edition of this very rare and informative catalogue has some 150 full page engravings of trade, farm and private vehicles. It is reproduced and bound in as near to the original style as possible. A fascinating book to browse through and a source for many new ideas for the modelmaker.



ALL BOOKS AVAILABLE BY POST FROM JOHN THOMPSON, 1 FIELDWAY, FLEET, HANTS

PLANS by John Thompson

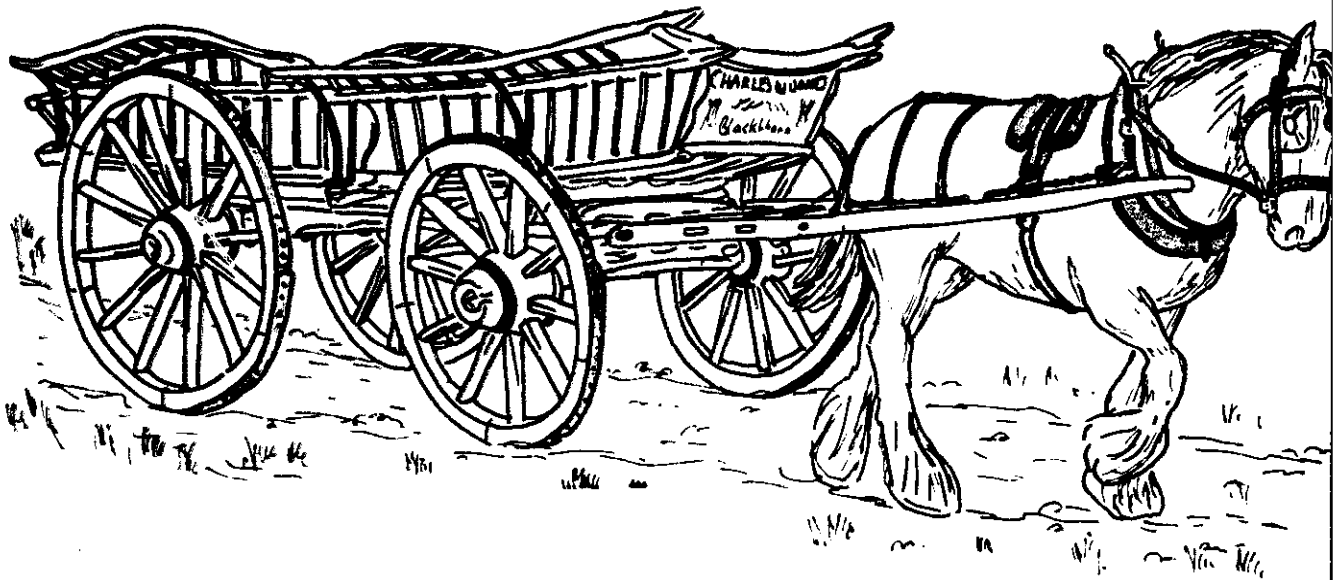

FULL details of the plans and current prices are given in the catalogue, issued yearly. This catalogue also contains a directory of suppliers of parts and materials, and particulars of books, museums, model horses etc. To obtain a copy please send 25p postal order or stamps to John Thompson, 1 Fieldway, Fleet, Hants.

"MODEL WHEELWRIGHT" PLANS – fully detailed scale drawings, with instructions and cutting patterns, to enable the craftsman of average ability to construct fine models.

Farm Tip Cart.
Monmouthshire Waggon
Milk Float

"Courage" Brewers Dray
Bow Top Caravan

THE "FIELDWAY" COLLECTION – Accurate highly detailed and authentic records of a wide range of vehicles from museums, for the serious modelmaker or student of the wheelwright's craft.

Barge Waggon
Medium Timber Bob
Large Timber Bob
Straked Timber Bob
Harvest Cart
East Anglian Waggon
Timber Carriage
Welsh Gambo
Hansom Cab
Royal Mail Coach

Wiltshire Dung Cart
Ledge Gypsy Caravan
Turnwrest Plough
Welsh Long Cart
Oxfordshire Waggon
Governess Cart
Surrey Dung Cart
Welsh Truckle Cart
Forest of Dean Waggon
Devon Harvest Trolley

Essex Waggon
Hampshire Waggon
Sussex Plough
Mole Plough
Ransomes Plough
Hop Tug
Hermaphrodite
Glamorgan Waggon
Conestoga Waggon
Northumberland Cart

..... plus others in course of preparation

"CARTCRAFT" PACKS – designed for those who want easy to make and attractive models, needing no special tools or materials. Comprise clear plans, full instructions and cutting patterns, together with a set of moulded composition wood finish wheels.

Lake District Cart
Brewers Dray

Cornish Haywain
Railway Trolley

Coal Cart

AMIES & BARFORD'S New Patent Water Ballasting Adjustable Wrought Iron Roller.



As used for Gentlemen's Parks, Race Courses, Cricket Grounds, Lawns, Landscape Gardener's use, and for making New Roads everywhere. The Cylinder is made of the best wrought iron boiler plate, and perfectly water-tight, so that it can be loaded by water to any extent at pleasure. This has proved one of the most successful of recent inventions, nearly 300 of these rollers, of various sizes, having been sent out in two years. They can be made from one to ten horse power, as desired.

SIZE.		(EMPTY.) APPROXIMATE WEIGHTS.			(FULL.)			PRICE.		
Long.	Diameter.	Ton.	Cwt.	Qr.	Tons.	Cwt.	Qr.	£.	s.	d.
4½ feet	...by 4 feet	2	0	0	4	10	0	60	0	0
4½ feet	...by 3½ feet	1	15	0	3	15	0	55	0	0
4 feet	...by 3½ feet	1	5	0	2	15	0	45	0	0

If made with A. & B's New Patented Turn-table Frame, to allow the horses to turn, without turning the implement, thus avoiding much strain on both, and shelling of the soil also—£5 extra.

Delivered at Peterborough Stations only. — Estimates given for any other sizes to order.

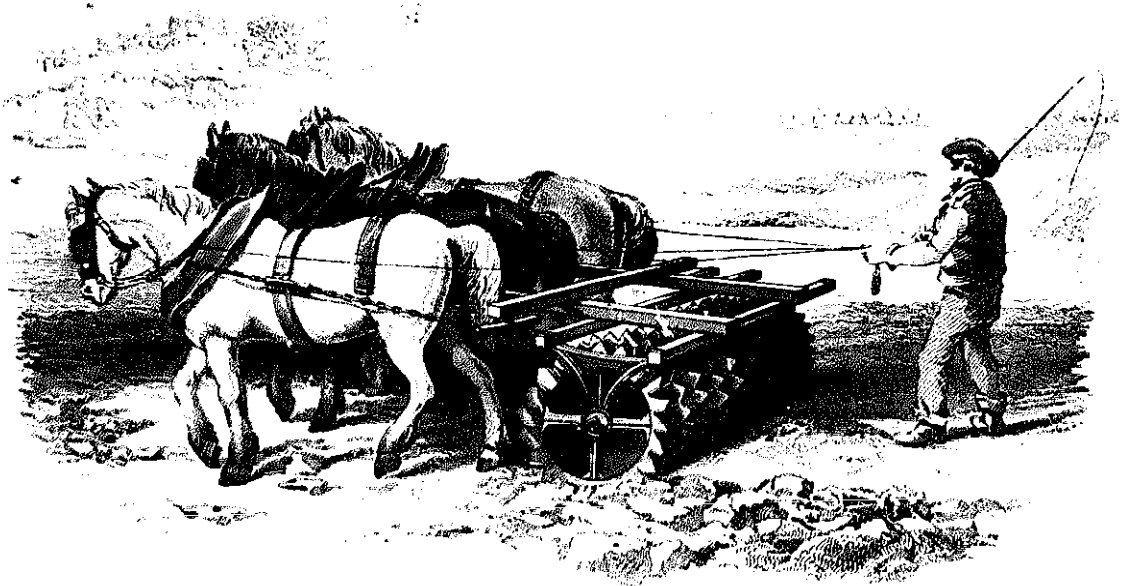

HORSE-DRAWN FARM IMPLEMENTS

Part II – Preparing the Soil

ISBN for complete set of 4 volumes: 0 9595775 5 3

ISBN for this volume: 0 9505775 7 X

No. 4 in a series of sourcebooks compiled and published
by

JOHN THOMPSON

1 Fieldway, Fleet. Hampshire, U.K.