

**AT** MICROFICHE  
REFERENCE  
LIBRARY

A project of Volunteers in Asia

Raising Healthy Pigs Under Primitive Conditions

by Dr. D.E. Goodman

Published by:

Christian Veterinary Mission  
c/o World Concern  
Box 33000  
Seattle, Washington 98133  
USA

Available from:

same as above

Reproduced by permission.

Reproduction of this microfiche document in any form is subject to the same restrictions as those of the original document.

# Raising Healthy PIGS Under Primitive Conditions

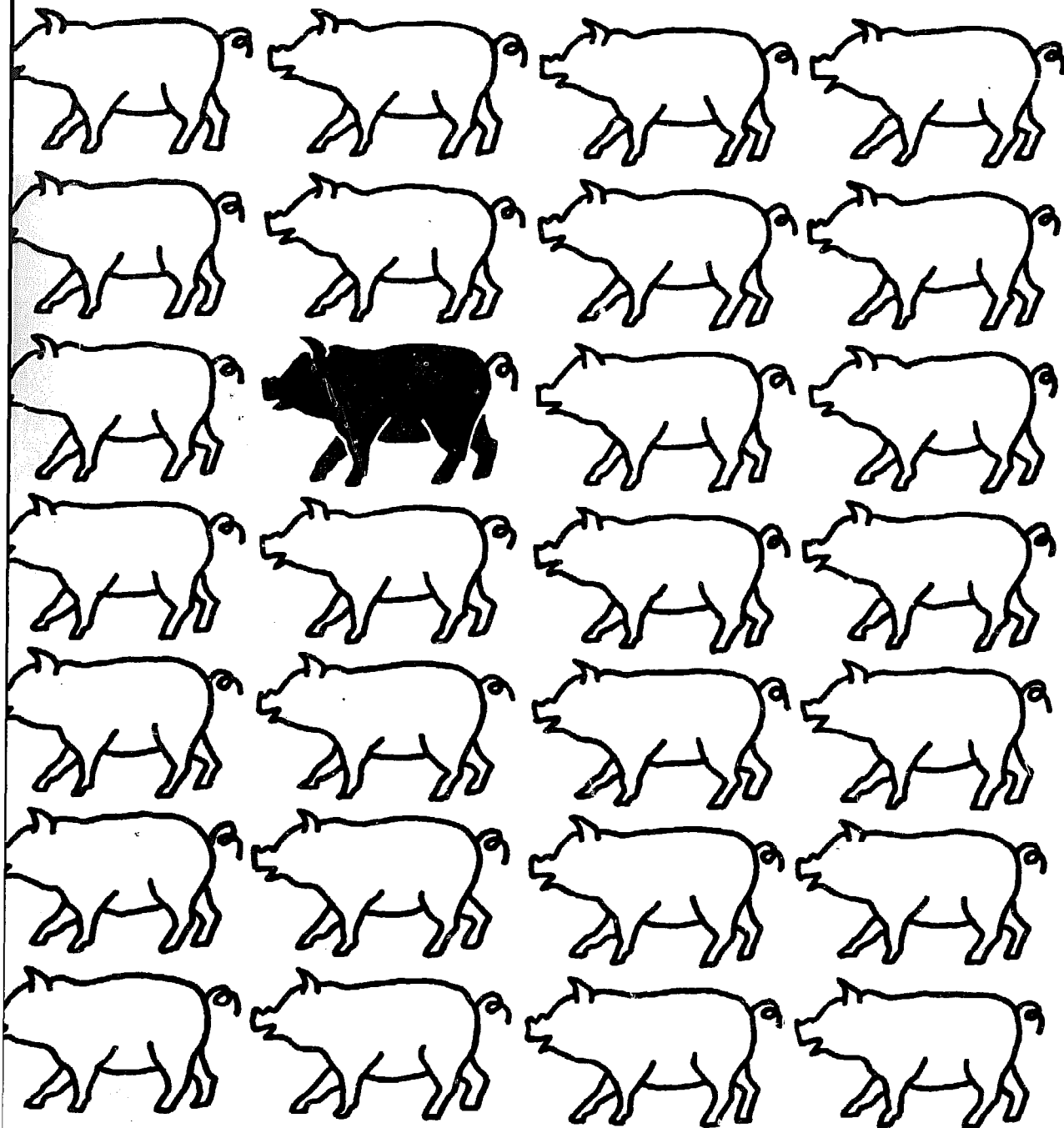

Dr. D.E. Goodman, Christian Veterinary Mission  
Division of World Concern

# Raising Healthy Pigs Under Primitive Conditions

by

Dr. D. E. Goodman  
Turbeville, South Carolina



A Publication of Christian Veterinary Missions

Division of World Concern

Box 33000  
Seattle, Washington 98133  
USA

Copyright © by World Concern

This booklet, in part or its entirety, may be copied, reproduced or adapted to meet local needs, without permission from the author or publisher provided credit is given to Christian Veterinary Mission and the author.

**These provisions apply provided the parts reproduced are distributed free or at cost — not for profit.** Christian Veterinary Mission would appreciate being sent a copy of any materials in which text or illustrations have been adapted.

For reproduction on a commercial basis, permission must first be obtained from Christian Veterinary Mission, division of World Concern.

**THIS IS AN EXPERIMENTAL FIRST EDITION**

It can be improved with your help. If you are a Veterinarian, Veterinary Technician, Animal Husbandry Amateur, Missionary, Development Worker, or anyone with ideas or suggestions for ways this booklet could be changed to better meet the needs of your people, please write to the author at Christian Veterinary Mission, a division of World Concern.

Thank you for your help.

# CONTENTS

## SECTION I

Background . . . . .	1
Introduction . . . . .	2

## SECTION II — A Healthy Environment

Living Conditions — Part 1 . . . . .	3
The Big Decision: Fencing, Tethering, Running Loose or Buildings — Part 2 . . . . .	7
Buildings and Equipment — Part 3 . . . . .	16

## SECTION III — Nutrition

Introduction and Background on Swine Nutrition . . . . .	26
Carbohydrates and Fats . . . . .	27
Grain Substitutes . . . . .	28
Garbage Feeding . . . . .	30
Forages — Green Grazing . . . . .	31
Protein . . . . .	32
Plant Sources of Protein . . . . .	32
Emergency Plant Protein Sources . . . . .	33
Meat-Fish Sources of Protein . . . . .	34
Dairy Product Sources of Protein . . . . .	34
Vitamins . . . . .	35
Minerals . . . . .	35
Calcium and Phosphorous . . . . .	35
Selenium . . . . .	37
Salt (NaCl) . . . . .	38
Iodine . . . . .	38
Methods of Feeding Pigs . . . . .	40
Food Preparation for Pigs . . . . .	42
Feeding A Balanced Ration . . . . .	43
Feeding Pregnant Sows . . . . .	44
Feeding the Nursing Sow . . . . .	44
Feeding Baby Pigs . . . . .	45
Feeding the Grower-Finishing Animal . . . . .	45
Sample Rations . . . . .	46

## **SECTION IV — Management Practices**

Reproduction — Part 1 .....	50
Breeding Methods .....	51
Length of Pregnancy — Number of Days .....	53
Managing Pregnant Sows .....	53
Boar Management .....	53
Farrowing (Delivery of Baby Pigs) Management .....	54
Baby Pig Management — Part 2 .....	56
Iron Deficiency Anemia .....	56
Castration .....	58
Weaning .....	59
Raising Orphan Pigs .....	60
Grower-Finisher (Fattening Animal) Management — Part 3 ..	60

## **SECTION V — Health Problems In Pigs**

General Considerations in Prevention of Health Problems in Pigs .....	63
Understanding The Normal Healthy Pig and Recognizing Signs (Symptoms) of Health Problems .....	64
Major Categories of Health Problems and Their More Probable Causes .....	66
Internal Parasites (Worms) and Their Role in Health Problems in Pigs .....	69
External Parasites (Insects) That Affect Pigs .....	75
Diseases of Pigs .....	77

## **SECTION VI**

Consulting By Mail On Problems In Pigs .....	80
--	----

## **SECTION VII**

Acknowledgements .....	82
------------------------	----

# Section 1

---

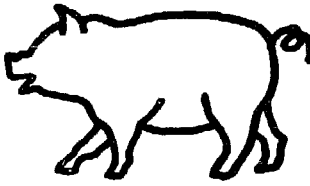
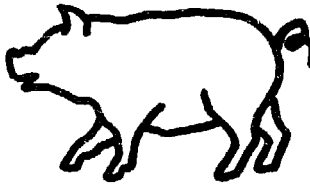
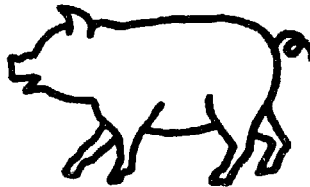
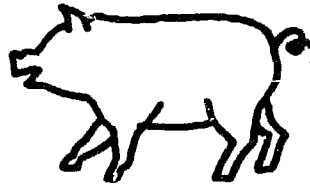
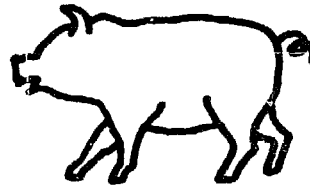
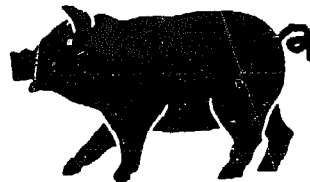

## Background

This booklet was prepared by Christian Veterinary Missions as an aid to those working in areas where information and assistance needed by small farmers is limited. Hopefully, this booklet will aid you in working with people in your area in order to raise healthier animals and improve the standard of living. It also provides you with a means of consulting by mail on special livestock problems.

The author of this booklet has traveled widely, and has lived and worked in underdeveloped areas of the world. He has also made several short-term missionary tours in those areas. He has had extensive experience with small scale pig production and livestock veterinary practice, as well as disease control and swine health consulting work. He is presently Supervisor of Animal Health Programs for Clemson University Livestock-Poultry Health Division and Diagnostic Laboratory.

This booklet is purposely written in discussion style for the sake of a broad background understanding, and contains only the minimum of hard facts and tables.

These suggestions, when used with adjustments for local conditions and a common sense approach to problem solving, could be a big help to those in your area.



## Introduction

Pigs are grown in almost all inhabited areas of the world with the exception of Arctic and sub-Arctic areas, and some extreme desert climates. They have proven to be adaptable to wide ranges of climate and production systems — from the very primitive to the highly sophisticated.

Pigs have also proven themselves able to thrive on a variety of foodstuffs. This makes them very desirable as a source of protein and cooking fat in otherwise deficient areas.

Also, they can aid in land clearing and slash-burn systems by eating roots, seeds, vegetation, and seedlings of young trees. Their manure (fecal waste) may serve as a source of fertilizer as well.

With the exception of areas with religious or cultural taboos against eating pork, the flesh of pigs is much in demand. It is a highly nutritious food and is totally safe to eat if a few basic sanitation and cooking practices which are outlined in this booklet are followed.

The fact that pigs can be grown on small acreage and their exceptional reproductive ability makes them very desirable. One pregnant female managed properly can soon be the basis of a small herd which can supply much needed food and income for the family. This can often be done at very little expense, if good judgment is used. Hopefully, this booklet will help you assist those in your area to do that.

# Section 2

---

## A Healthy Environment

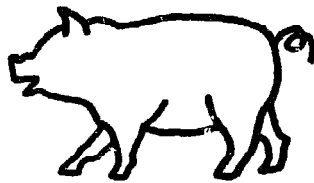
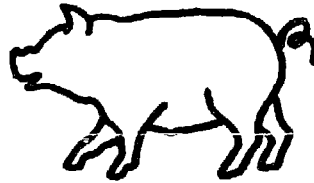
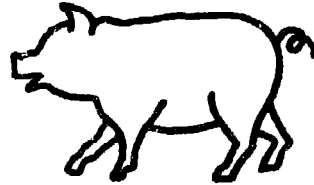
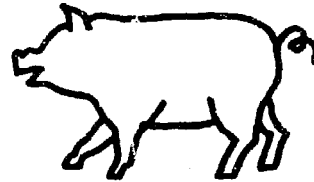
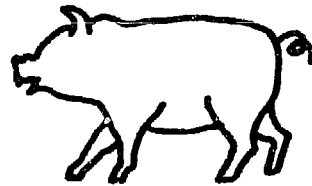
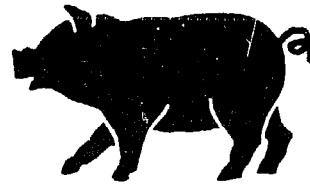
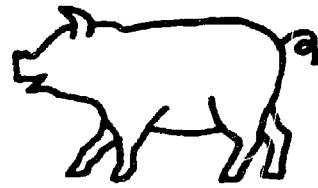

# ENVIRONMENT PART I

## Living Conditions

## Environment (Living Conditions)

Protection from adverse weather conditions is an important consideration in raising pigs. Although they have adapted to wide variations of local climate, they still need protection from extreme heat and cold, cold rain, cold wind, and snow.

Swine suffer more from hot weather than any other livestock. They have no sweat glands in their skin which provides a natural cooling system for other animals that can perspire and who are cooled by the evaporation of this moisture from their skin. Also, the heavier fat layer beneath the skin tends to hold body heat. For these reasons it is necessary that we furnish protection from heat or allow pigs to use their native instincts to stay cool.

Protection from extreme heat can be just as important as protection from extreme cold. Prolonged exposure to bright sunshine or in poorly ventilated buildings may cause pigs to become overheated and can bring on respiratory problems (colds and pneumonia) and reproductive (breeding) problems. Exposure to extreme cold without protection from wind, rain, and snow often leads to severe respiratory problems in all ages, as well as slowed growth and reproductive problems.

Generally 50° to 80° is the best temperature range for adults. Baby pigs have a poorly developed temperature regulating response and need more warmth than do adults (around 80° - 90° F. for the first three or four weeks). These, however, are only rough guidelines. Native pigs often have adapted very well over a period of time to most extremes of local climate if given some protection or if they are allowed to use their natural instincts.

Sows, with their great maternal instincts, have a remarkable ability to protect their baby pigs from temperature extremes by farrowing in protected areas and making beds of dried vegetation. By using their natural instincts and their ability to adapt, plus a few basic management suggestions, healthy pigs can be grown almost anywhere that humans live. Pigs may survive extremes of weather without shelter; however, their health is often impaired and stunting, poor reproduction, and weak animals occur and protection becomes unsatisfactory.

In areas where temperatures often drop below freezing or chilling wind and rain occur, some type of temporary (movable) or permanent shelter or housing will be needed. At the minimum, a roof and three sides are needed to protect against wind and rain. The open side should face the sun for warmth.

In tropical or subtropical areas where temperatures are often above 80° F. some type of natural shade (tree cover) or permanent or

temporary (movable) shelter will be needed. Thatch, straw, wood, or bamboo roofed, **open-sided shelters** are often all that is necessary if adequate natural shade is not available. Tin or other metal may be used for the roof, but tends to be hotter than other coverings. The framework can be made from discarded lumber, bamboo, or poles cut locally from the more rot and insect resistant trees.

On pastures and in dirt pens sows and boars will need around 15 square feet of shelter built with the roof sloped and approximately five feet high. Sows with pigs need twice this much sheltered area. Growing-fattening animals on pasture or dirt pens need 10 square feet of sheltered area.

Temporary (movable) shelter is much to be preferred over permanent structures because they can be moved to prevent build up of filth which causes sanitation problems and leads to disease and parasite difficulties. They are also less expensive and are easier to build.

Canvas or plastic sheets over a temporary framework can be used in emergencies such as protecting a sow and her newborn baby pigs.

Pigs should be pastured on land that is as well drained as possible with some tree cover for wind and shade protection. Mud wallows and low wet areas soon become unsanitary and can be a source of disease and parasite problems. For this reason, pigs should be given shade and fresh water; otherwise, they should be moved often.

Wallow areas where animals are allowed to escape extreme heat by laying in shallow water or mud is a natural method of keeping animals cool. However, it should be used as a last resort and when other methods are not feasible because the poor sanitation leads to disease and parasite problems.

Running streams may bring disease germs from nearby farms. This is another reason why it is a good idea to keep pigs out of these areas and give them fresh water.

Pasture and pen rotation, where pigs are frequently moved to an area not recently used and recently used areas are allowed to rest is almost a necessity if we are to raise healthy pigs without serious trouble from disease and parasites. **Pens and pastures can be used again 6-12 months later.** This also applies to dirt lots as well.

If land is greatly limited or large number of animals are being raised, permanent housing with floors may be necessary. However, sanitation problems from the build up of manure and filth without adequate waste disposal systems usually leads to serious health problems. Therefore, permanent housing should be build only as a last resort in most situations. Temporary shelters built for one or two adults, or several (one litter) small animals can be moved by a few people or may be built on pole runners and pulled to a clean area.

Pigs can be raised satisfactorily on a few acres if only a small amount

is used at a time, and if the animals are frequently moved. **It is almost certain that pens, pastures, or open land used continuously for as little as two years will have developed health problems from disease or parasites, and should not be used again for 6-12 months for pigs.**

More details on housing are given in the section on buildings and equipment.

Often in your area there will be someone who has, over a long period of time, acquired experience and has been able to successfully grow pigs under local conditions. Careful observation of his methods may give you clues that you can pass along to others. You should also contact any livestock specialists in your area for assistance (government workers or others).

In summary, the ideal pig living conditions are high, well drained land, with animals frequently moved to unused land and allowed natural or artificial protection from weather extremes.

**SPECIAL NOTE I:** In some areas vampire bats may bite animals, causing infections and spreading rabies. If they are a problem in your area, animals must be protected at night. Screened or boarded enclosures, or some source of light such as candles, lamps, etc., usually prevent the problem. In such areas pigs may be turned out during the day and protected at night.

**SPECIAL NOTE II:** Sows should farrow on the cleanest ground; newborn pigs are very susceptible to disease, and infections and parasites do their most serious damage to pigs under 8-10 weeks old. **There are further details on this in later chapters.**

**SPECIAL NOTE III:** Another important consideration is that pigs be prevented from having contact with human fecal waste. This is to prevent the spread of certain parasites and diseases that can be real problems. **This is covered in more detail in the section on parasites.**

## **ENVIRONMENT PART II**

### **The Big Decision: Fencing, Tethering, Running Loose or Buildings**

## **The Big Decision** — Fencing, Tethering or Buildings

1. Totally Primitive — pigs allowed to run loose.
2. Tethering.
3. Pen or pasture with fencing and sheds.
4. Buildings.

## **Fencing, Tethering or Buildings**

One of the most difficult decisions in pig production is to decide what type or combination of facilities to use. There are advantages and disadvantages to each.

Major considerations include the farmer's experience with pigs, cost and availability of building supplies and equipment, size of farm, climate, method of feeding and others.

1. **Primitive** — animals run loose, no buildings and no fences or only a few small pens.

**Advantages** — no cost for buildings and fences.  
— less feed cost — animals forage for themselves with small amounts of other foods.  
— less experience with pigs needed.  
— less time needed to care for animals.

**Disadvantages** — wild animals may harm pigs, especially newborn.  
— can't assist with farrowing problems and help when sick. Sow at farrowing time and sick animals are often hard to find.  
— animals may stray and come in contact with other pigs and become sick from disease.  
— may damage crops.  
— may come in contact with human waste and develop parasite problems. This would only be practical in isolated areas with no other farms closeby. However, it could be done in seasons when no crops are grown and animals are confined during the growing season.

2. **Tethering** — animals tied to control their movement.

**Advantages** — less costly than fences and still control animals' movement.  
— no unwanted crop damage.  
— no contact with human waste.  
— no contact with other pigs and less exposure to disease.  
— keep pigs out of low wet areas where parasites



and disease are a problem.

**Disadvantages** — takes time to train pigs to the tether. Start with younger animals.

— much time needed. Animals are usually moved to grazing area during daylight and brought back near the family at night.

**On hot days they can only graze early in the morning and late in the afternoon and have to be moved often.**

**Description of Tether Harness** — Basically a shoulder harness similar to a dog harness and made from leather strapping or cloth webbing. It has to be long enough to encircle the body behind the front legs at the chest with **one strap** and **another** around the neck in front of the front legs and short pieces to connect the two at the sides. Fit the harness over the pig's neck, cross it under the chest and wrap around the body. Attach the tether, preferably a chain (or rope) to the harness under the chest and tie to a tree, post, or ground anchor. It has to be adjustable for growing pigs or several sizes are needed.

In some areas a simple neck harness is used. It can be made of the same material and consists of one strap around the neck fixed so it cannot tighten and choke the animal. It is then attached to the chain or rope. With this type neck harness, pigs should be trained from a very young age to get used to it. In most primitive situations this type tether might be more practical than the one shown in the illustration.

### 3. **Pen or Pasture with Fencing and Shade Fences**

A. Woven Metal wire is very good, but is too expensive for most primitive farms. It is also difficult to move and pens and pastures may be used too long and build up parasite (worm) and disease germs.

B. Wooden fencing made from poles or scrap lumber are most often used on primitive hog farms. They are easier to construct and little or no cost of materials. They do not last as long as metal wire, but this is no problem since they should be moved often.

#### C. **Barbed Wire Does Not Work Well for pigs.**

**Fencing Advantages** — control movement of animals.

— assist at farrowing time and when sick.

— only minimal experience with pigs needed.

**Disadvantages** — cost of fence and shed if materials have to be purchased.

— buildup of disease germs and parasites unless moved often.

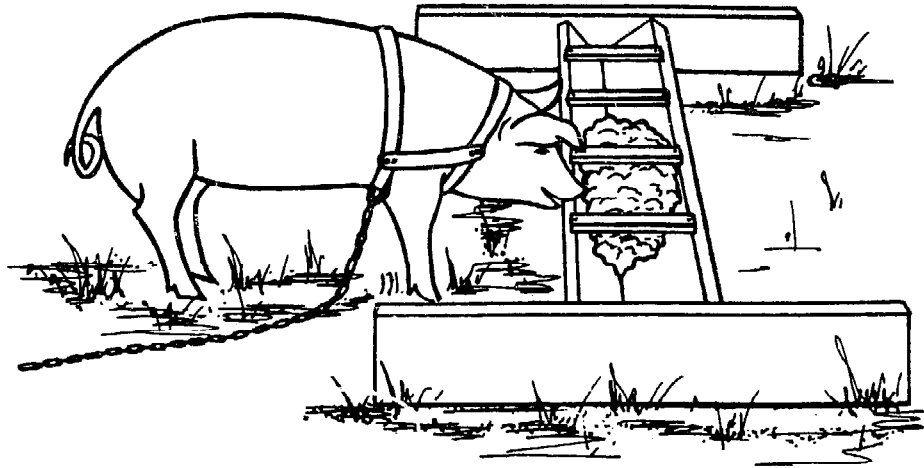
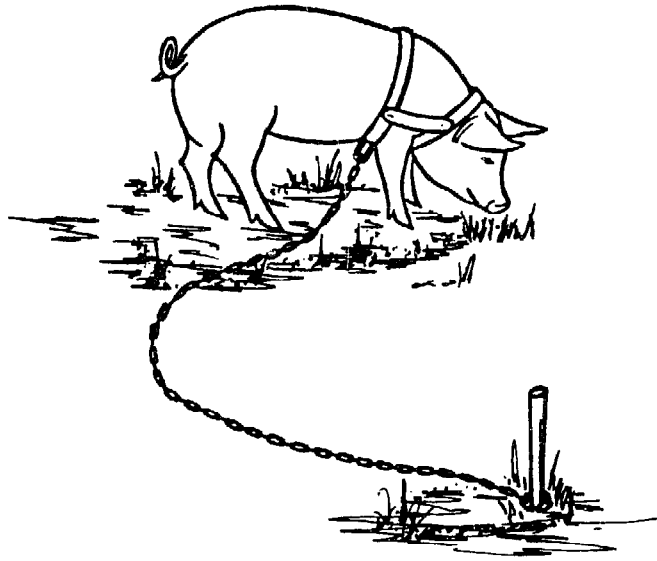

"Drawings of Use of Tether Harness on Pigs"

From: USDA Leaflet 537

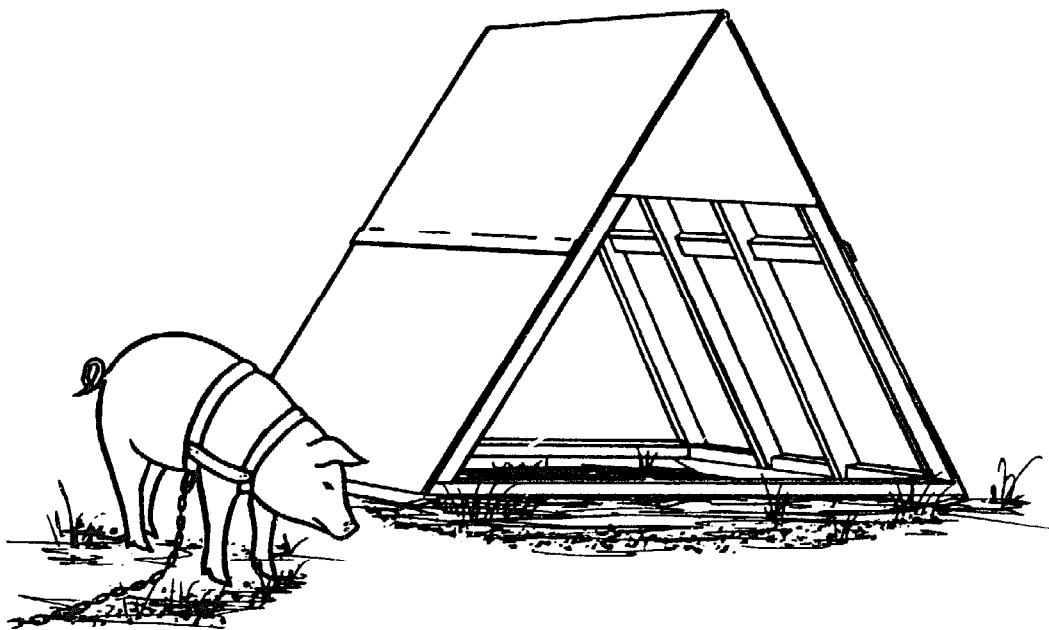

"Drawing of pig with Tether Harness and movable A-Frame Shed"

From: USDA Leaflet 537

## **Summary:**

The most practical system for primitive farms is a combination of tethering and allowing pigs to run loose.

**Example:** — Tethering at farrowing time and growing season for crops.

— Run loose in non-crop season.

— This is probably the best combination in most cases.

**Example:** — Pen or enclosed pasture during farrowing time and crop growing season.

— Run loose during non-crop season.

(This would be another combination)

**Example:** — Large pen or pasture most of the day, night.

— Tether animals for other grazing during part of the day.

**Example:** — Pen-Pasture during farrowing and baby pig time.

— Tether during crop season.

— Loose during non-crop season.

4. **Buildings** — Other than temporary sheds as already described.

There are few practical reasons for using buildings in primitive pig production.

**Advantages** — Ease of handling animals when confined in small areas, especially at farrowing time and sickness.

— protection from extreme weather, **mainly cold weather.**

— less land used.

**Disadvantages** — cost of buildings and equipment.

— farmer needs more experience in raising pigs.

— sanitation problems from buildup of filth often lead to disease problems.

— baby pigs in buildings **with floors** will have a serious anemia problem unless precautions are taken. **See Notes in Baby Pig Section of Reproduction.**

— enclosed buildings are often too hot for animals' comfort and good health.

## SKETCHES OF FENCING

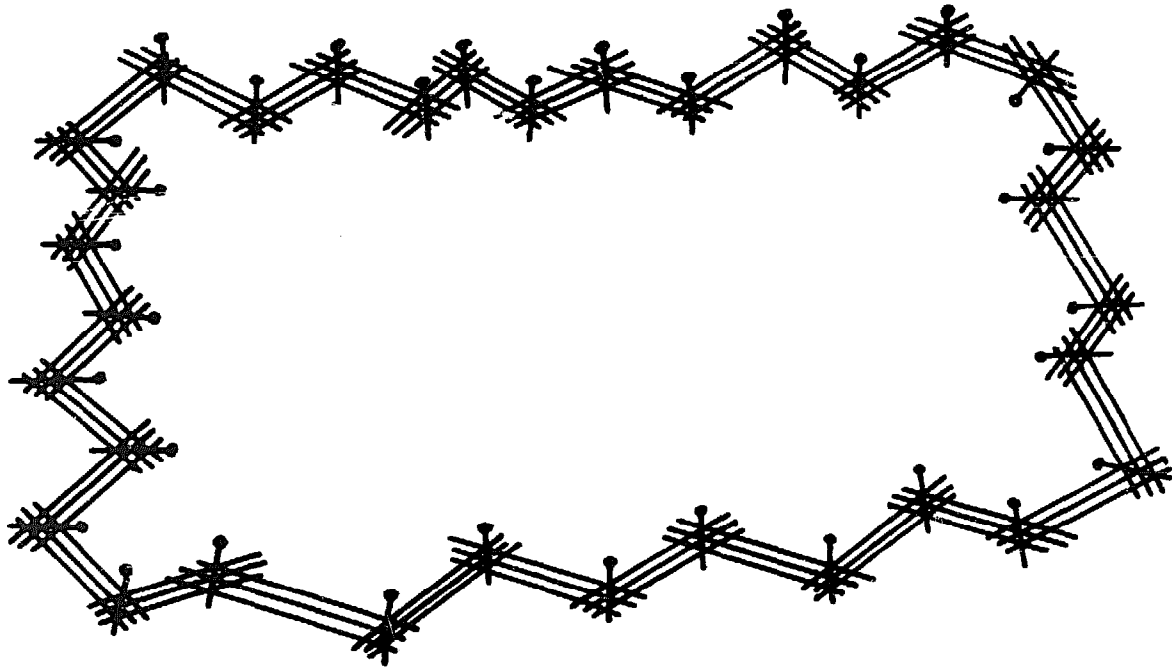

“Sketch of pole or split-rail Fence”

This uses long poles or split-rails around 10 feet long. They are laid horizontally and overlap each other at the ends. For maximum strength the ends must cross at an angle. An upright pole in the angle adds more strength. The poles may be attached to each other with nails, wire, or strong vines. For many reasons this type fencing is often used in primitive livestock production.

# FENCING MATERIALS

BARBED WIRE

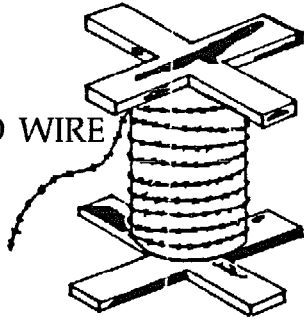

FENCE POLES

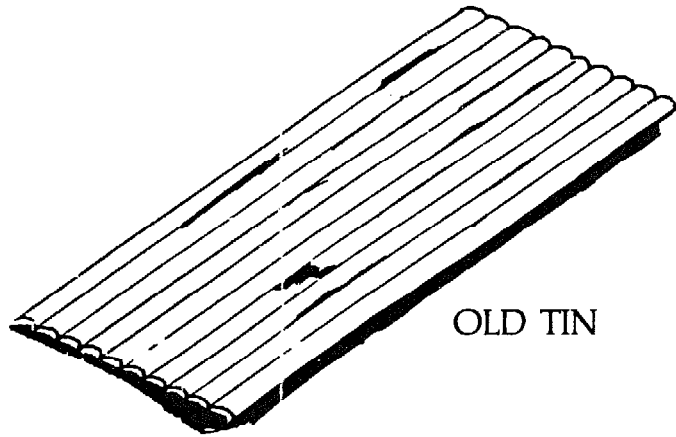
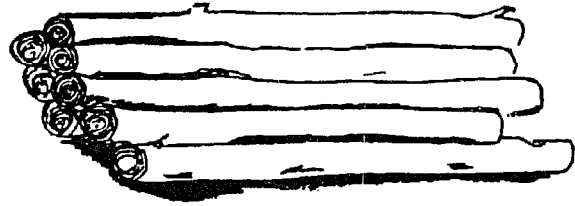

OLD TIN

OLD CROSS TIES

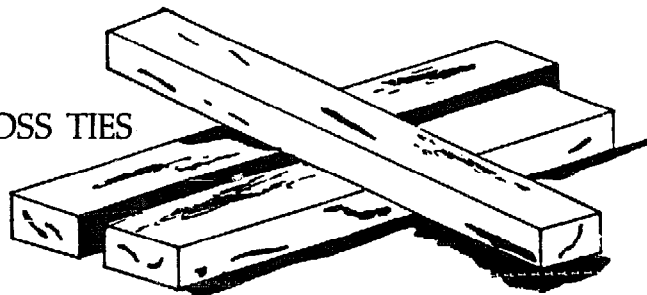

FENCE WIRE

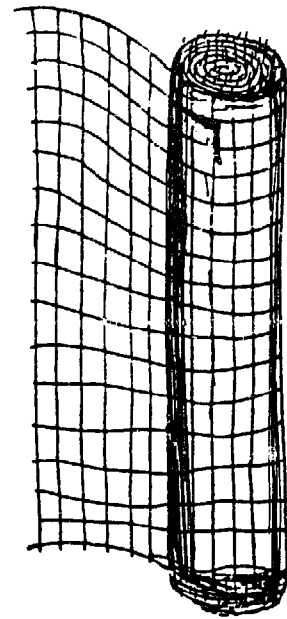

From: Tuskegee Inst. Cir. TI-AS-14B 6:79

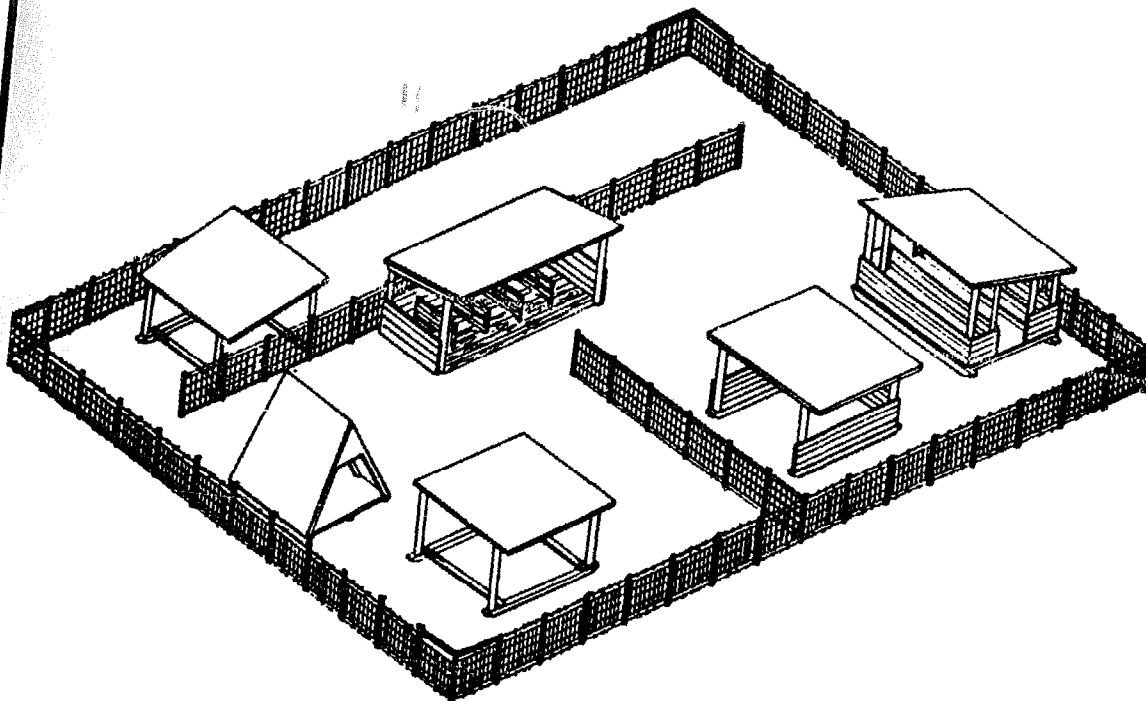
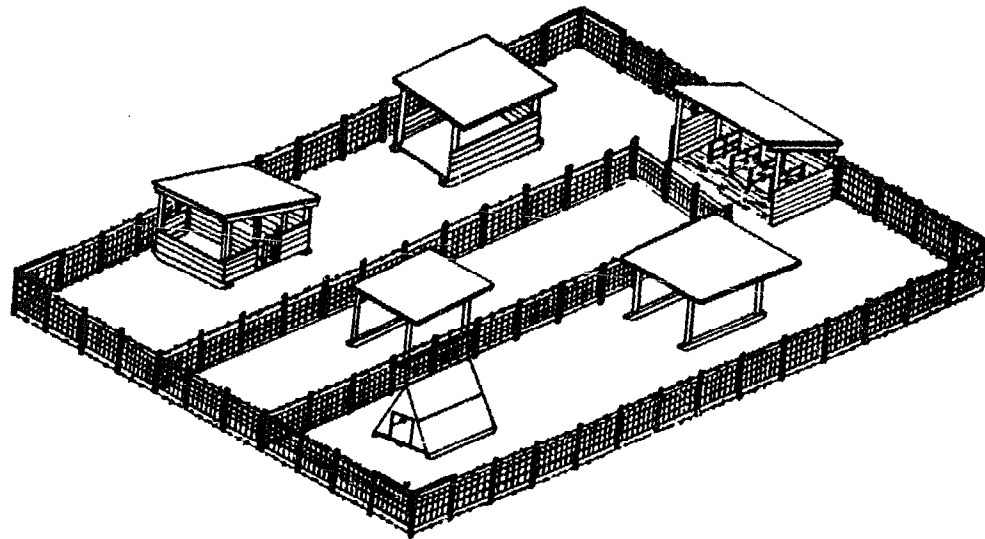

From: Tuskegee Institute Cir. TI-AS-14B 6:79

**ENVIRONMENT PART III**

**Buildings and Equipment**



# feeders & waterers

PORTABLE FEED BUNKS

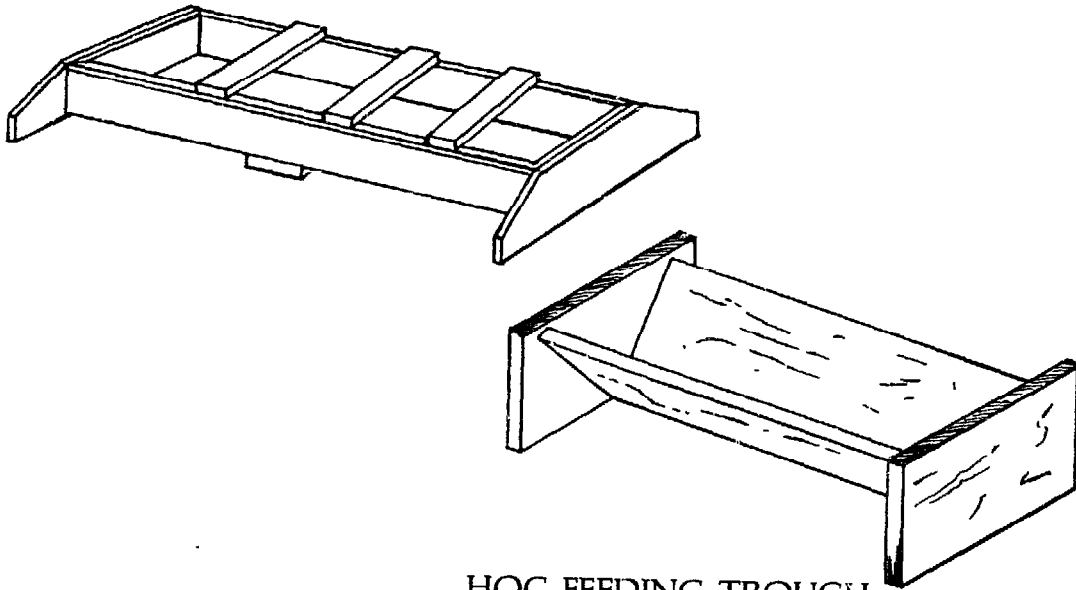

HOG FEEDING TROUGH

FEED OR WATER TROUGH  
FROM OLD TRACTOR TIRE  
OR TRUCK TIRE

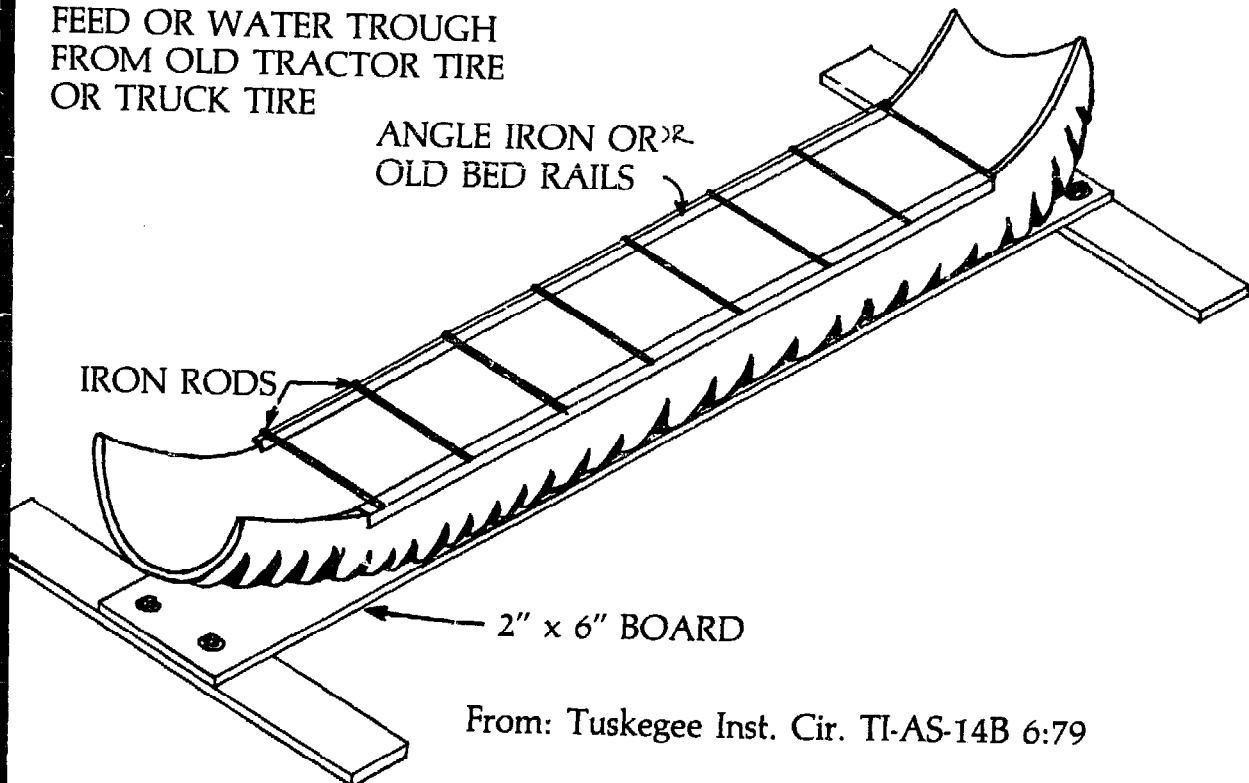

From: Tuskegee Inst. Cir. TI-AS-14B 6:79

From: Tuskegee Inst. Cir. TI-AS-14B 6:79

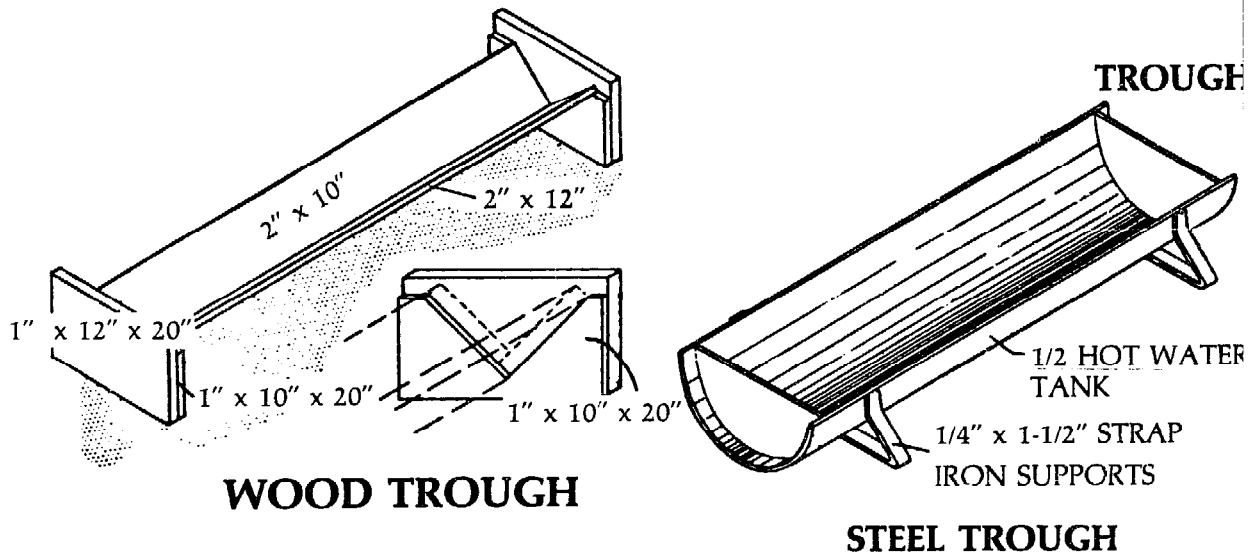

"Drawings of Feed and Water Troughs for Pigs"

From: Clemson University Agri. Eng. Circular 205

# FEEDERS OR WATERERS

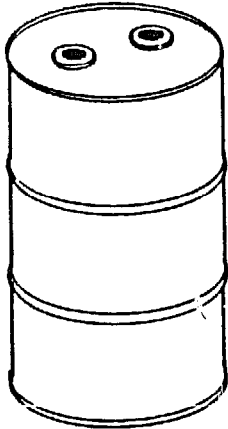

FEED OR WATER TROUGHS  
FROM RECYCLED OIL DRUM  
55 GAL. OIL DRUM

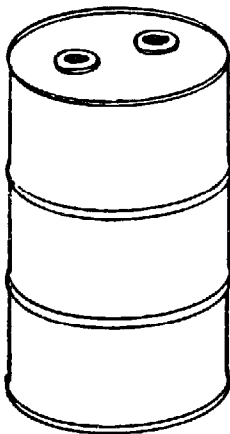
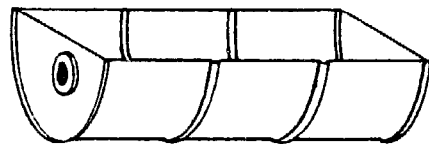
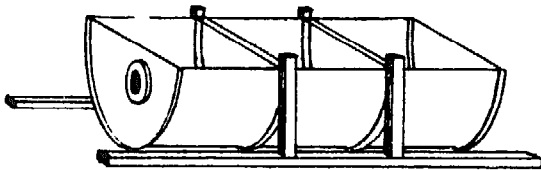
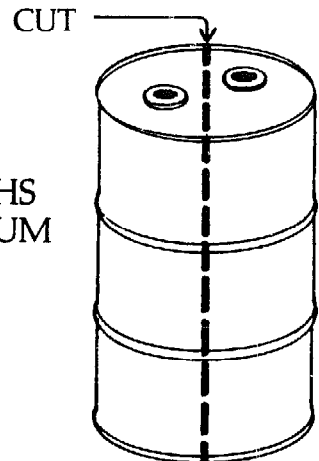

OLD OIL DRUM  
CUT IN THIRDS

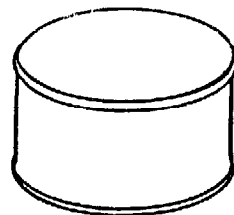
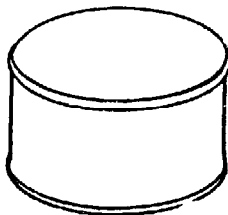
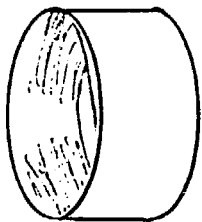
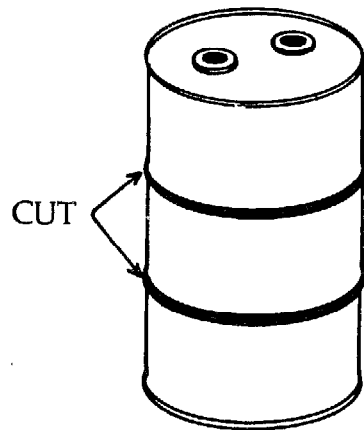

From: Tuskegee Inst. Cir. TI-AS-14B 6:79

# farrowing houses

## A ONE-JACKET HOUSE

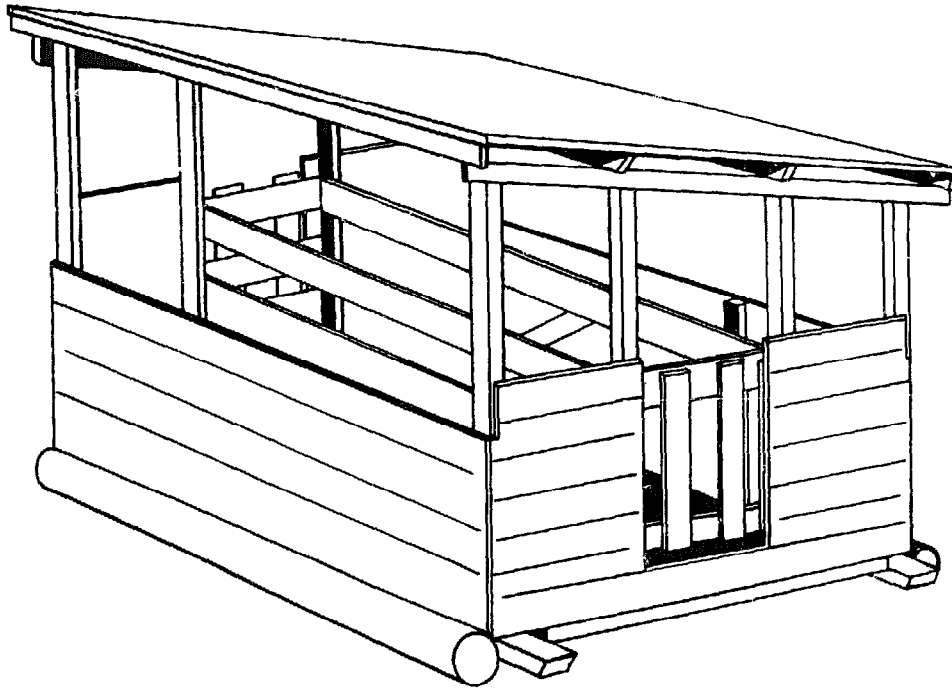

## CROSS SECTION

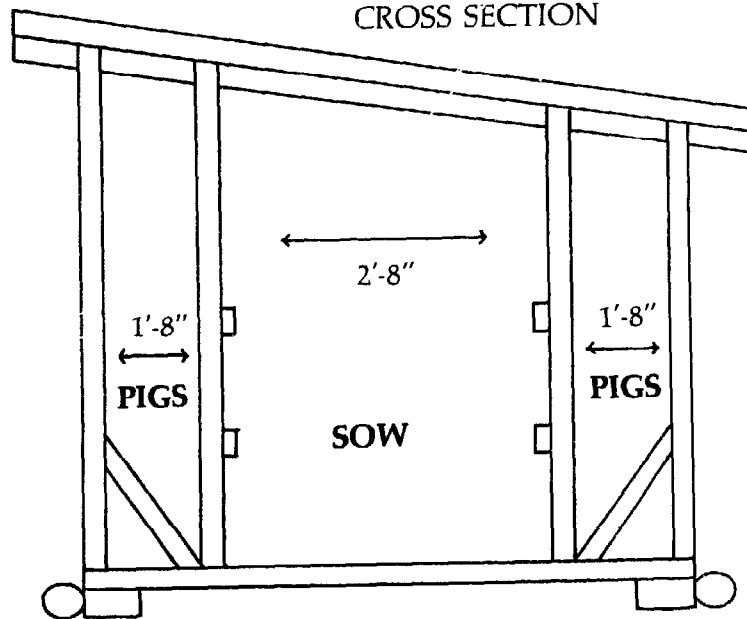

From: Tuskegee Ins. Cir. TI-AS-14B 6:79

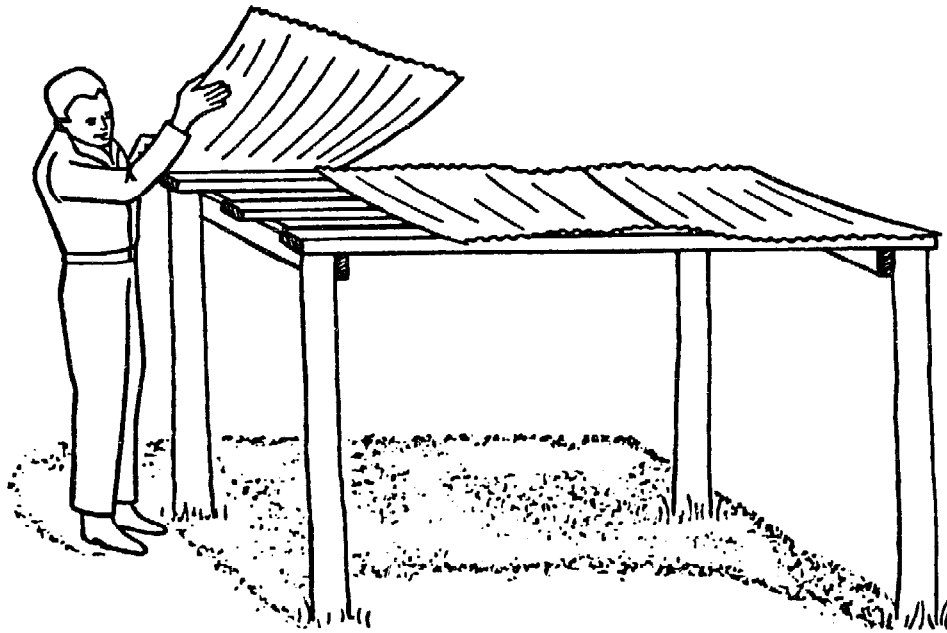

“Drawing of Temporary Shed made from Poles and Scrap Building Material.

Thatch or straw would also work well if roof were more steep.”

From: USDA Leaflet 537

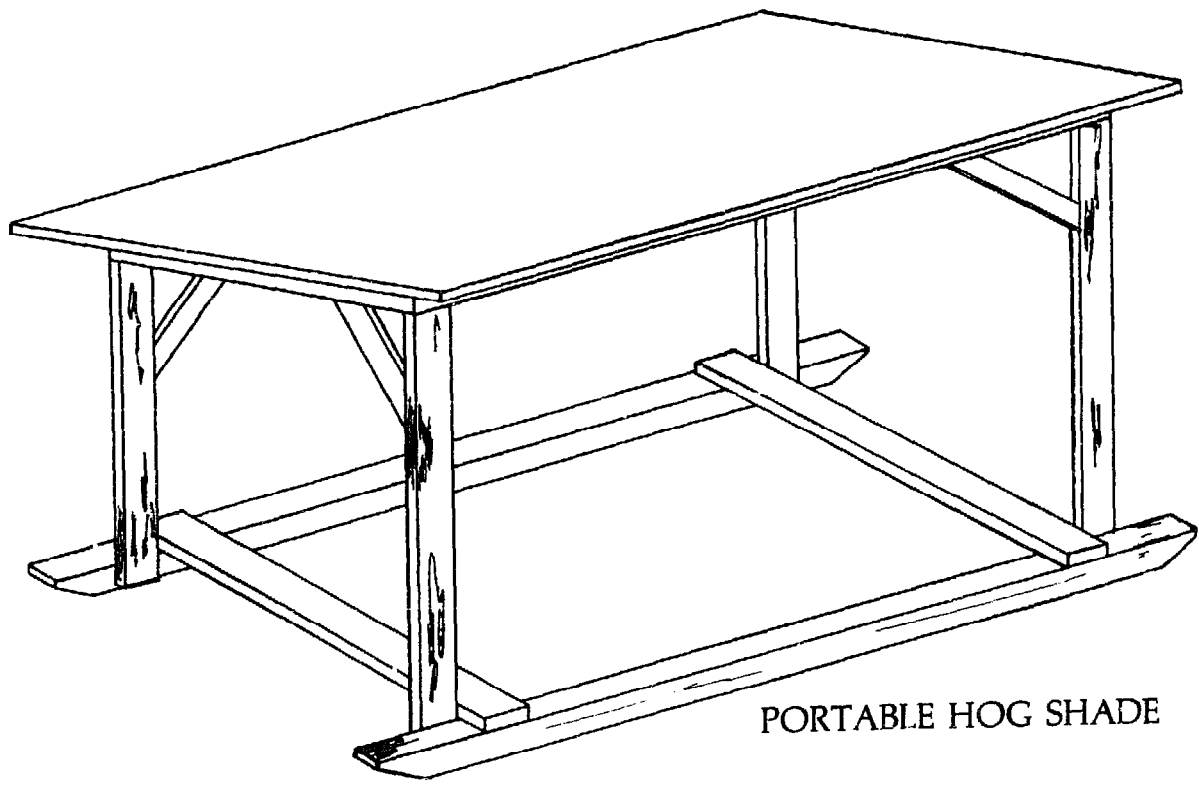

PORTABLE HOG SHADE

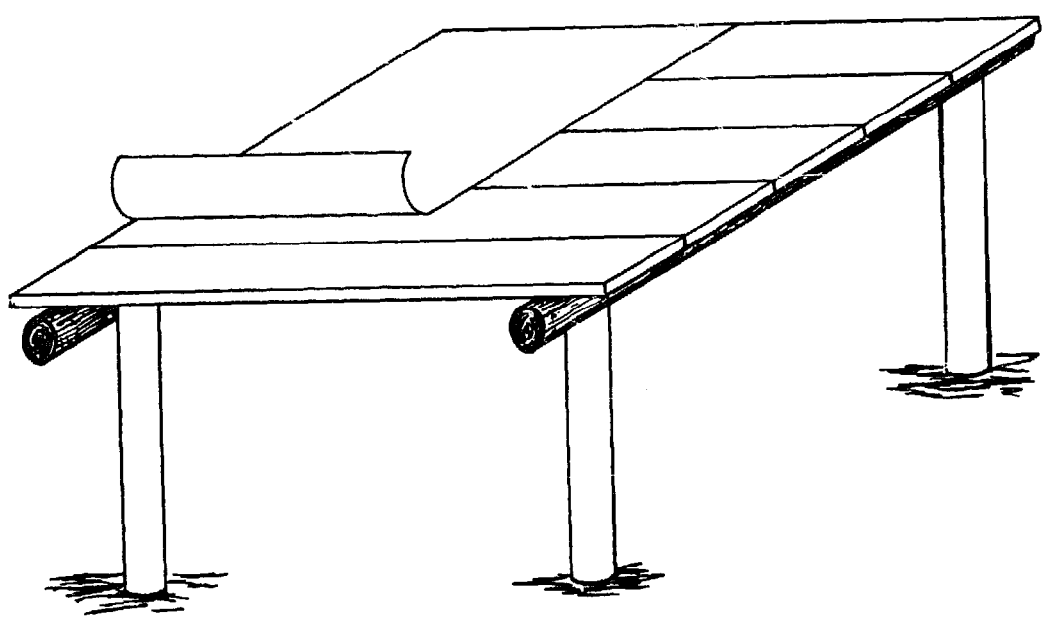

STATIONARY HOG SHELTER

From: Tuskegee Int. Cir. TI-AS-14B 6:79

# A-TYPE HOG HOUSE

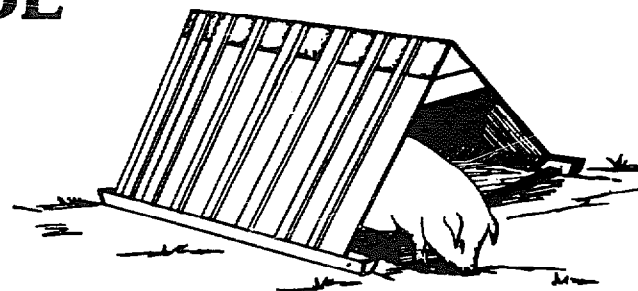

## BILL OF MATERIALS

- 2 - 2" x 6" x 8'-0" RUNNERS
- 7 - 1" x 6" x 8'-0" BRACES
- 10 - 1" x 3" x 12'-0" BATTENS & CLEATS
- 10 - 1" x 8" x 12'-0" SIDING
- 1 - 2" x 4" x 10'-0" GUARD RAIL
- 2 LBS. 8d COMMON NAILS
- 1 LB. 6D COMMON NAILS
- 1 PC. 24" TAR PAPER 7'-0" LONG

PREPARED BY  
G.H. STEWART, LEADER  
AGRICULTURAL ENGINEERING EXTENSION  
WORK  
AND  
A.L. DURANT  
EXTENSION LIVESTOCK SPECIALIST  
COOPERATING

CLEMSON AGRICULTURAL COLLEGE  
Cooperating with  
UNITED STATES DEPARTMENT OF AGRICULTURE  
EXTENSION SERVICE  
D.W. Watkins, Director  
Clemson, South Carolina

DISTRIBUTED IN FURTHERANCE OF THE ACTS OF CONGRESS  
OF MAY 8 AND JUNE 30, 1914.

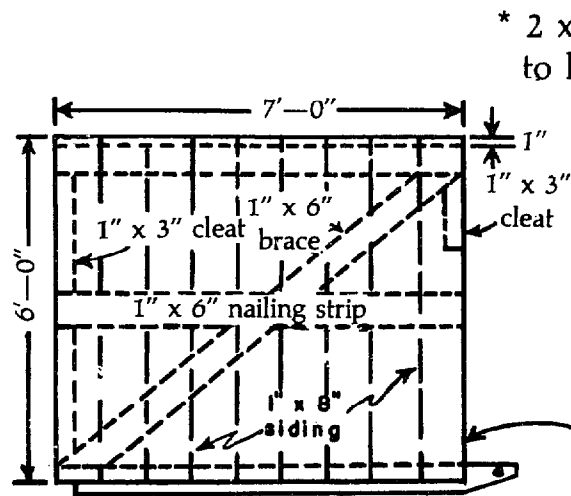

-LEFT SIDE-

\* 2 x 4 needed across here to keep sow from spreading it.

SIDES ARE BUILT ON THE GROUND, THEN RAISED UP AND NAILED TOGETHER.

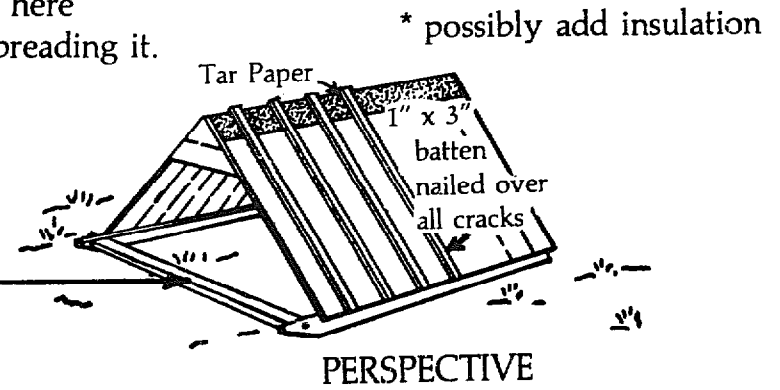

PERSPECTIVE

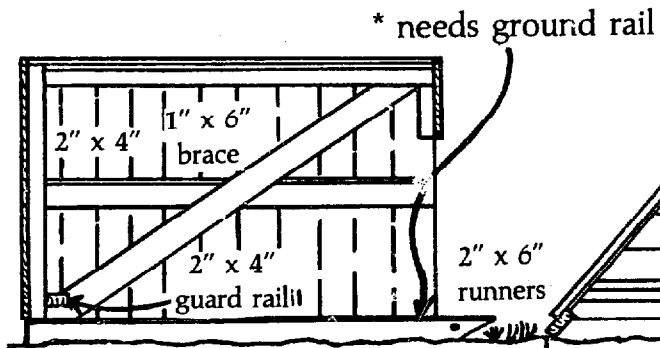

-SECTION

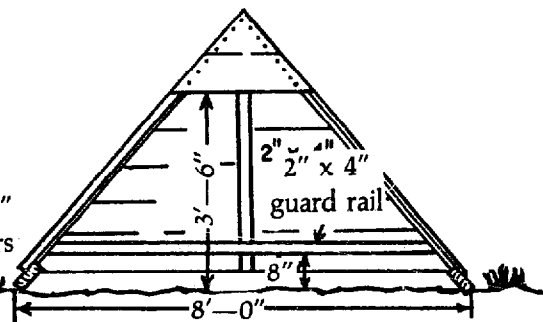

-END VIEW



- RIDGE DETAIL

# A-TYPE HOG HOUSE



## A FEED MIXER

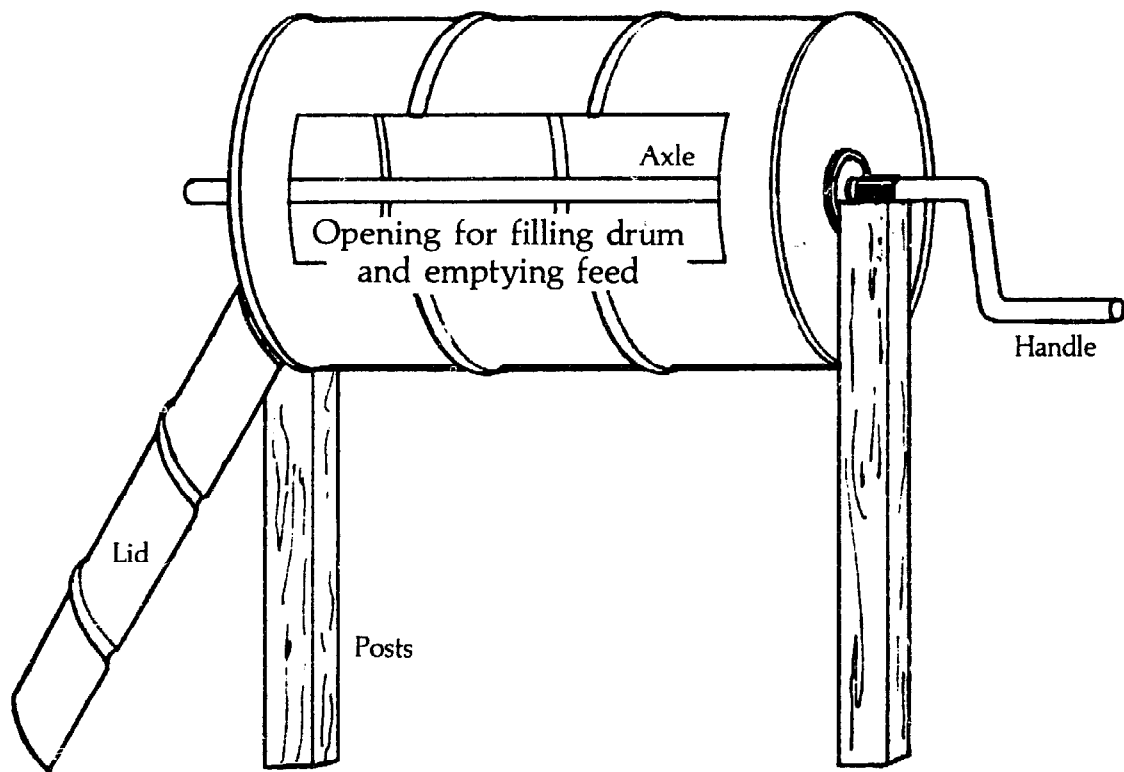

The 200 lb. mixer  
made from a 44 gallon drum

# Section 3

---

## Nutrition

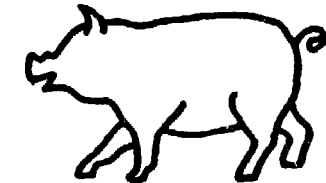
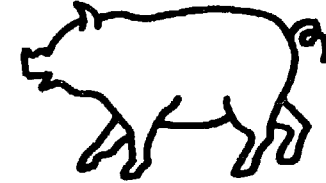
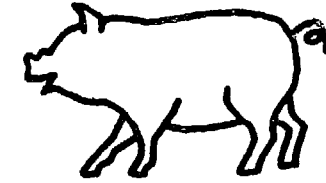
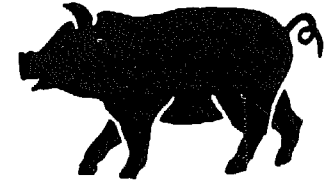
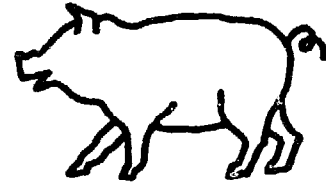
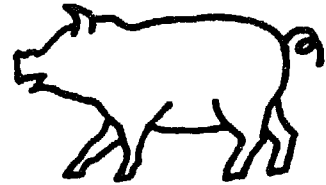

## Nutrition — Food and Water For Growth and Health

In this booklet we will greatly emphasize nutrition because so many aspects of an animal's health are affected by nutrition, and because pigs are able to consume and often thrive on a wide variety of foodstuffs. Many of these foods are in a surplus seasonally, are very inexpensive in certain areas, or are not nutritious or appetizing for humans and consequently may be wasted if not fed to pigs. Also, there are many times when grain and occasionally purchased ingredients fed along with these other products to pigs will often result in a great increase in protein and cooking fat available to humans. This protein and cooking fat would probably not be otherwise available if it were not for some of the unique characteristics of pigs.

Like humans, pigs have a simple stomach of relatively small size. Since pigs are omnivorous (like man) they are able to utilize food of both animal and plant origin. This gives us many options in feeding pigs that we do not have in feeding cattle, sheep, and goats.

Pigs are also able to utilize forages, grass, and other grazing much better than is generally believed and this gives us options that help extend other foodstuffs in the diet.

Nutritional needs of the animal are influenced by size, age, pregnancy, nursing pigs, climate, soil type, and many other factors. These nutrition suggestions are offered as information only, and **should be used on the basis of the animal's needs but with the realization that local conditions and the owner's circumstances will dictate a great degree of flexibility in feeding pigs.** For this reason, the author has extensively researched the subject to find as many as possible of the foodstuffs that pigs can consume. Also, visits to existing hog farmers in your area may help you discover other satisfactory foodstuffs for pigs.

The key to pig nutrition is understanding that different classes of foods must be combined for a balanced ration since no one feed provides all required nutrients. (California)

There are five classes of feeds for hogs:

**Carbohydrates and fats:** These are mainly grains, but include dried (and fresh) fruit, yams, potatoes, molasses, and fats. Vegetables and garbage are also included, but are less desirable. Foods in this group give energy which is used daily in body processes, stored as fat, and used for milk production. They make up the bulk of pig diets, around 80% of the total.

2. **Protein:** This is supplied by a number of animal and fish by-

products, and oil seeds. Good grazing supplies much protein, and grains contain a small amount. Protein provides for growth and builds tissues (muscle and lean meat).

3. **Minerals (including salt):** These are supplied by sources such as ground limestone, steamed bone meal, and salt. These are necessary for bone and tissue growth, and for body functions.

4. **Vitamins:** These are needed in small amounts for growth, reproduction, and body functions. They are **necessary** for good health. Vitamins are supplied mainly by good grazing, but small amounts come from protein sources and fresh fruits and vegetables.

5. **Water:** A fresh, plentiful, and constant source of water is needed for good health.

## 1. **Carbohydrates and Fats:**

A. **Grain:** In areas where corn can be efficiently produced, it is a staple of hog rations. However, any grain can be fed, as well as grain by-products and substitutes. Often grain is expensive or is not available locally. Small amounts, however, used along with other inexpensive ingredients will greatly extend them and will balance the ration. This method can be cost effective and can increase the protein and cooking fat available to humans. Also, in the isolated areas where transportation of farm products is difficult, meat and animals are often more easily sold.

1. **Corn:** Corn is an ideal hog feed, but, **as with all grain products**, needs to be balanced with a little extra protein and minerals for best results. Yellow corn has more vitamins and is preferred.

2. **Wheat:** This grain is similar to corn and is an ideal hog feed. Cost and availability, however, mean that little is used as hog feed (it should also be balanced with protein and minerals.)

3. **Oats:** Also a good hog feed and less expensive than wheat. Because of its high fiber content, it is better for adults than young animals. It works best when mixed with other grain, especially for young animals. Hulled oats are a good feed for young pigs.

4. **Barley:** Is almost as good as corn, but **must be crushed or ground.**

5. **Rye:** A satisfactory hog feed if it is ground or crushed.

6. **Grain Sorghums:** These include milo, millet, kafit, etc. and are similar to corn in feed value to pigs, if crushed or ground.

7. **Triticale:** A relatively new hybrid which is a cross between wheat and rye is satisfactory as pig feed. Except for short periods, it should not constitute over 50% of the total diet.

8. **Wheat Bran and Wheat Middlings:** These are similar in feed value to wheat, and can be fed to pigs, if available, at a reasonable cost. These are better fed to animals over 100 pounds, and should

not make up more than one-fourth of the total ration, except for short periods. These are the milling by-products.

9. Other grain or feed milling by-products, including floor sweepings, may be fed to pigs, but there is an element of risk if other chemicals are stored in the same building.

**NOTE:** All of these grains, except corn, should be ground, crushed, or soaked for pig feed. Corn can be fed without grinding. See **Details** in the section on **Food Preparation**.

### **B. Rice Products:**

1. **Rice:** Rough or paddy type; it is a good pig feed, but only if it is ground or cooked. It is better for use with older animals. Cost and availability limit its use in pigs except for special circumstances. It can be used to extend other inexpensive products in order to produce protein and fat. Older hogs do well on rice stubble.

2. **Rice Bran and Polish:** A good pig feed if mixed with other grain and a little protein. Do not feed as the only carbohydrate source except for short periods. The high fat content causes rancidity to develop quickly.

C. **Grain Substitutes:** These are best used to replace part of the grain, but can be used as the only source. As with other products, they need to be balanced with minerals, a little protein, and grazing or cut forage, if possible.

1. **Potatoes:** Cull or surplus potatoes are occasionally fed to pigs. If cooked they can replace part of the grain in the diet.

**NOTE:** Sprouts may be dangerous. Remove before feeding. Dehydrated potatoes also work well.

2. **Yams (sweet potatoes):** These are a good grain substitute. Do not feed as the only carbohydrate source except for short periods of time. Do not feed molded or rotten potatoes or sprouts. If yams are not grown in your area, suggest it be tried. Cooking improves their value. It takes 3-4 pounds to replace a pound of corn.

3. **Manioc (Cassava-Manihot-Yucca):** These can be used as a grain substitute. **It can be poisonous to humans and animals.** Heavy peeling and boiling seems to prevent this problem. A practical guideline is to prepare it as is done for human food. This is a food that seems to be cheaply and easily grown in many areas with a warm climate, and should probably receive more attention as a pig food.

4. **Cassava Meal:** A manufactured product is a satisfactory grain substitute in pigs if available at a reasonable cost.

5. **Molasses:** Can replace part (1/3) of the grain, but should not be used as the only carbohydrate except for short periods. Molasses should **not** make up more than 10% of the diet of young pigs, 20%-

30% in growing animals. Cane molasses is best, beet molasses fair and citrus molasses less desirable.

6. **Sugar:** Same as for molasses.

7. **Tubers:** Root crops, artichokes, beets, and turnips, and any other root vegetable eaten by humans is a satisfactory pig feed. These are not highly nutritious, but pigs like them, and then can extend the diet somewhat. Carrots are better than any others.

8. **Cull Vegetables** (overripe or surplus): Cucumbers, watermelon, tomatoes, pumpkin, lettuce, cabbage, squash, and others locally available, are not highly nutritious, but can extend the diet. They should not be the only food for nursing sows and young animals. They are better used in larger growing animals.

9. **Cull Fruits** (overripe or surplus): Coconut, ripe bananas, pineapple, pineapple bran, avocado (without seeds), pears, apples, peaches, papaya, and breadfruit are satisfactory for up to 1/3 of the diet, or higher for short periods. They should not be the only food for nursing sows and young animals as they are too low in energy supply. Any other fruit available locally should be looked into as a pig feed. **Bananas** can be utilized in several forms, but they are more appetizing if allowed to ripen. Green bananas are somewhat bitter and pigs will eat less of them than they will eat if ripe. Ripe bananas may be fed whole with peelings. Green bananas may be made more appetizing by cooking them. Bananas are often in a surplus, and may be available free or at a very low cost. In such areas they should receive more attention as a food for pigs. Bananas and breadfruit are among the best grain substitutes for pigs.

**NOTE:** Vegetables, potatoes, and fruit should be cut into small pieces for better digestion and to prevent choking.

10. **Dried Fruit:** Cull raisins, dried figs, prunes, dates, apples, etcetera, can be fed to pigs. They should be limited to 1/3 of the diet except for short periods. This is one method of preserving surplus or inexpensive food for later use when it is out of season.

11. **Citrus Fruit and Pulp:** There is often a surplus of this at harvest time, and it can prove to be an inexpensive feed or culls may be free. Information for other fruit applies here. They can be fed with the peelings. Those with a sweeter taste such as oranges or tangerines are preferred over lemons, limes, and grapefruit.

12. **Kiawa Bean Meal:** If dried and ground or crushed, this is a satisfactory pig feed for up to 1/3 of the ration. It is high in fiber and is best fed to non-nursing animals.

13. **Copra:** This is coconut oil meal and is a satisfactory carbohydrate-grain replacer for up to 1/3 of the diet. It is not very appetizing to pigs and should be mixed with other food for better results. Molasses works well with copra.

14. **Babassu Oil Meal:** A manufacturing by-product of the Brazilian palm. It is similar in food value to that of Copra for pigs.

15. **Tamarind Seed:** Has been fed satisfactorily in India, as a grain-carbohydrate source, though details are not available.

16. **Incubator Waste Eggs:** This is a good source for pigs that is often available around egg hatcheries. They are a reasonably satisfactory food for pigs, but **only if cooked and in small amounts.**

**Caution: No grain or seed of any kind** (including oil seeds such as peanut, soybean, and cottonseed) which has been treated with **chemicals for planting** should be fed to animals or humans. **All seed treatment chemicals are harmful.**

**Caution: Leucaena** — An unusual, fast growing Leguminous Tree has leaves and seeds that have been used for livestock feed. However, there **may be a problem** in feeding it to pigs. Do not feed it to pigs unless local experience with it has proven satisfactory. This is especially true in pregnant and nursing females.

17. **Bagasse:** Sugar cane pulp, a manufacturing by-product. While not a very desirable grain substitute, can be used in small amounts, (not over 15 %) in the ration of larger growing animals. (See Sample Ration 13). It is best used with molasses. It has very little feed value for pigs and would only be used as a last resort.

D. **Waste Kitchen Fat:** Lard and tallow and cooking oils. All of these are good energy sources and work well in swine rations. They should not be the only energy source. Fat stimulates nursing sows to give more milk and it is richer in fat. It should be supplemented with other carbohydrate and protein and minerals. Food grade vegetable oil such as a peanut, soybean, and sunflower works well.

E. **Bakery Waste:** Stale bread, dough, cake, etc., is occasionally available free or is inexpensive and often not appetizing to humans or is a surplus. It is similar in food value to grain and can replace it. Protein and minerals are also needed to balance it. If very dry, it should be moistened.

**Caution: Before feeding, always remove plastic and paper wrappers.**

F. **Garbage Feeding:** Garbage can also be a grain substitute - carbohydrate source. It is usually animal or vegetable source food discarded from the human food supply. Business, institutional and military garbage is far superior to household garbage, though both are satisfactorily fed. As with any grain - carbohydrate source, protein and minerals should also be fed. Because of poor nutrient balance, garbage **alone** should not be fed to the very young or nursing adults: it is best fed to growing animals. Because **it often contains meat and bone scraps it may spread disease and parasites (Trichina & Tapeworms)** that affect humans and animals. **Boiling for 30**

**minutes is considered an adequate safeguard.** It also improves the food by blending it and softening it. As a last resort, if cooking is impossible, try to remove meat and bone scraps or cook these separately. Also, remove plastic, paper, metal foil, etc.

Particular attention should be paid to slaughter house waste as a source of disease and parasites. **Always cook these well before feeding.** Good quality garbage with meat scraps may be fed without added protein to growing animals; however, they will grow faster and healthier with more protein. Garbage always needs to be supplemented with minerals, including salt. This is especially true in pregnant and nursing animals. Garbage alone is not a satisfactory food for pigs under 8-10 weeks old. In order to do well they need some regular carbohydrate-grain produce and added protein. **Feeding household food waste to pigs is often a recommended practice in primitive situations.**

Animals confined in a small area and fed garbage will greatly benefit if **freshly cut green grazing food is also fed to supply vitamins.**

**Environmental Note:** Because of many factors, garbage feeding soon becomes unsanitary and pigs generally suffer from more health problems. Rotation of pens and pastures on at least a 6-12 month system is a great help in growing healthier animals.

G. **Forages - Green Grazing:** Grazing is an inexpensive source of nutrients that is usually available and should be utilized if at all possible wherever swine are grown. In many areas it is available year around. In non-nursing adults it can replace part of the carbohydrate-grain and protein. Grazing is especially helpful for pregnant animals and is almost a necessity unless a well-balanced highly nutritious diet is fed. Legumes such as clover, alfalfa and others are high in protein and do well with no added nitrogen fertilizer. If local conditions are suitable they should be grown even if in small patches. **However, any (non-poisonous) green vegetation is helpful.**

If grazing is of high quality or in limited supply it may be better to **cut it and bring it to animals** rather than damage it by grazing. Any excess can be dried like hay for future use.

In many countries, local experimentation has developed greatly improved strains of local grasses that are more nutritious and resistant to disease and insects. Also, imported grasses may have been introduced that are much better than local forage. In either case, seeds or cuttings of these should be started from the original planting.

While commercial fertilizer is often too expensive or transportation is too costly, there may be some situations where cost will allow their use. Yields are greatly increased with fertilization and foods are much



more nutritious. In many cases small amounts of fertilizer will increase yields more than enough to be cost-effective. In other areas, soil testing will have indicated that single ingredients such as phosphorus or potassium alone will greatly help. They are much less expensive than complete fertilizers.

Grazing with access to wooded areas allows swine to supplement their diet with grubs, earthworms, roots, seeds, acorns, berries and occasional small rodents.

## 2. **Protein:**

Grain and grain substitutes do not contain protein in sufficient amounts to satisfy the needs of swine. Therefore, some feed high in protein needs to be added as often as possible. Failure to do this causes slowed growth, stunting and many health problems.

Although the usual commercial products are costly, there are often local sources of some type of protein which can be grown or purchased at reasonable cost. The numerous possibilities listed here well prove that to be true.

### A. **Plant Sources of Protein:**

1. **Soybean Meal** is 40-44 % protein and is the ideal pig plant protein. **As with all plant protein sources it should be supplemented with vitamins and minerals. It should not be over 1/2 of total ration.** Cooking soybeans for 30 minutes at 280° F. or 138° C. will destroy a chemical that interferes with digestion and should be done if at all possible. Any cooking such as parching or boiling is a big help.

2. **Peanut Meal:** 47 % protein, is a good protein source. It is a better ration if some meat protein is also fed. Peanuts can also be fed raw to pigs and in the hull.

3. **Linseed (Flax) Meal:** 35 % protein. Information as for peanut meal applies here but should only be fed in limited amounts or short time. It should not make up more than 1/3 of the added protein. It has a laxative affect and small amounts are good for sows.

4. **Cottonseed Oil Meal:** 35 % is a good source of protein for swine but unless specially processed it is **dangerous to swine** because of a chemical called gossypol. It is mentioned here because cotton is grown in many areas and may be available at low cost. **If care is used** — small amounts, **not over 10%** of a normal ration may be fed if animals are closely observed. It is better if a little animal protein is also fed.

5. **Copra (Coconut Meal):** 21 % protein — rates as a protein **and** carbohydrate-grain source. It is better if a small amount of meat protein is also fed.

6. **Field Peas:** 23 % protein — are a good source of protein for swine. They are usually grazed but they are more efficient and there

is less waste if hand picked. They may also be dried for later use and cooked for swine. They supply carbohydrate as well and since they require little fertilizer and in many areas can be grown year-round, they should receive more attention as a swine feed. They yield well on small patches and are also a good human food. **The dried peavine bush makes excellent hay.**

7. **Navy, Lima and Other Edible Beans:** 23 % protein. They supply protein and energy. They **have** to be cooked or they are toxic (poisonous) and salt added or they are not appetizing to swine. **Caution — Hulls of some beans, if wilted, are poisonous and should not be fed. Caution — Raw velvet beans are not safe for pigs** and not totally safe if cooked.

8. **Alfalfa** (Green) or Hay (Chopped Fine) is an excellent source of protein, vitamins and minerals for swine. It is usually high priced but even in small amounts is an excellent swine feed at up to 10% of total ration. Newer varieties show promise of being grown in many areas not formerly suitable. Suggest that it be tried in your area.

9. **Sunflower Seeds:** Can be source of protein for swine, though not as suitable as others. It is a better feed for adults since it is high in fiber, but can be fed to all ages except baby pigs.

**Sunflower Meal:** 25-45 % protein is better than seeds and is satisfactory for all ages.

10. **Safflower Meal:** Low in protein (20 %) but is a fair protein source up to 10% of total diet.

11. **Sesame Meal:** 44 % protein. If this is used as the protein source some animal-fish protein is also needed.

12. **Feather Meal:** (By-product of poultry processing). It is not a good protein source for swine, but is available in some areas and should be used if inexpensive. It is best used to extend other protein.

13. **Brewers Grain:**(By-product of beer processing) and Distillers Grain (By-product of Alcohol production). It is a satisfactory source of protein for swine if available and reasonably priced. They have the same limitation as the grain from which they were produced.

14. **Emergency Plant Protein Sources:** Very poor source of protein for pigs.

a. **Tung Nut Meal** — must have been detoxified for pig feed. It is not palatable unless fed in small amounts and mixed well. It might best be used in emergencies or for a short time.

b. **Kapok Oil Meal** — another manufacturing by-product that can be used as a protein for pigs. It is much less desirable than others but can be used. It is best used to extend a more desirable protein.

c. **Palm Kernel Oil Meal** or **Cake** — a manufacturing by-product that is not a very appetizing nor highly nutritious protein source for pigs. However, it can be used in small amounts when no other

protein is available.

d. **Rubber Seed Meal** — a manufacturing by-product of the Para-Rubber Tree, containing 25 % protein, can probably be used in small amounts in pigs. Heat treatment seems to reduce the Toxic Hydrocyanic (Prussic) Acid. **Caution:** Hemp Seed Meal is a poor protein source for pigs and **possibly dangerous**.

### B. **Meat-Fish Sources of Protein**

1. a. **Meat and Bone Scraps**
- b. **Meat Meal and**
- c. **Tankage**

All of these are meat processing by-products. These generally run 45-60 % protein and are an excellent protein source for swine. If any of these products have not been cooked in processing, they should be cooked as for garbage. It also supplies minerals.

2. **Blood Meal** — 80 % protein — another meat processing by-product that is a good protein source for swine. It is best used when other protein is also fed and is of most value in larger growing animals.

3. **Fish Meal** 50-70 % protein, one of the best protein sources for swine and one of the most appetizing for swine. High cost limits its use in most areas. However, in some areas it is available at a cost that makes its use in swine a possibility. It is especially good to get young growing pigs off to a good start and to extend lesser quality protein. It does not give pork a fish taste.

**Cooked Fish or Fish Scraps** — Locally caught fish or fish scraps, if cooked, can be fed to swine as an excellent source of protein. In many areas this could satisfy the protein needs of swine. Fish species not appetizing to humans can be used in swine. If not well cooked by boiling (and in the case of larger fish, also crushed or ground) bones may be a problem. In some areas fish might also be a source of disease and parasites if not well cooked. By-products of processing seafood other than fish can also be used in swine rations. These would include scraps from fresh processing, as well as shrimp and crab meal, shark and tuna meal.

### C. **Dairy Product Sources of Protein**

1. **Surplus whole or skim milk and buttermilk** — These are excellent sources for swine and very appetizing. They would be of the most value in nursing sows and baby pigs but also are very good in growing animals. Even in small amounts they stimulate nursing sows to give more milk and help young pigs to get a good start. In areas where crop farming is not practical and grazing for cattle (and goats) is plentiful and cheap, milk could become a surplus and could be efficiently used in swine diets. This would be especially true in areas

with many cattle and few people or where transportation of milk is impractical. **Surplus goat milk could be used for swine.**

2. **Whey** — By-Product of cheese making. Though low in protein it is easily digested. It has about half the food value of skim and buttermilk, but should be used if available at reasonable cost.

3. **Vitamins:** These are only needed in small amounts, but are necessary for good health, growth and reproduction. They are not used as a source of protein or energy, but are essential for normal body functions. The vitamins most often deficient in swine rations are Vitamin A, B Complex, and B<sub>12</sub>. Vitamin A is produced from carotene which is found in green and yellow feeds such as grasses and yellow corn or carrots. The B complex vitamins are found in green feeds and grain and B<sub>12</sub> in animal and fish products. In advanced swine production systems swine are fed commercially produced vitamins. This is a necessity, where swine are raised on concrete or in confinement buildings.

High cost, transportation problems, and heat inactivation necessitate that a practical and inexpensive solution to providing vitamins to swine be found. The answer to this is the knowledge that the 14 vitamins swine require are generally available in feed if some of the different categories are regularly fed. Also some are produced by normal microorganisms in the intestine. This means grain or grain by-products and plant and animal (or dairy) protein sources need to be fed regularly. Many of these are also available in forages being grazed or cut and brought to animals. Fruits and vegetables, especially those with yellow color, also provide vitamins and should be fed as often as possible. Any source of fish or fish by-product or animal protein, even if only occasionally, is a big help in providing vitamins.

Under most primitive production systems, forage of good quality grazed or cut and fed to swine, or dried for later use will adequately provide vitamins if animals are fed a reasonably well balanced diet. **This is a simple and inexpensive way of providing vitamins, that is usually available.** If good quality forage is not available, use any green grass or other vegetation, if palatable and not poisonous.

#### 4. **Minerals:**

These are inorganic elements that are essential for many vital functions and are major components of the skeleton. Calcium, phosphorus, sodium and chlorine (salt) are the ones needed in larger amounts. Iron, zinc, iodine, selenium, copper and manganese are also needed, but in minute amounts.

Calcium and available phosphorus are too low in the usual carbohydrate-energy sources to satisfy the needs of swine, especially pregnant and nursing females.

Also, almost all of the usual foodstuffs are deficient in salt.

Practically all feeds contain some minerals. The combination of feeds being fed determine the amount of extra minerals needed. Because pasture and grasses harvested for forages have more mineral than seeds and their by-products, **swine fed on pasture need less additional minerals**. Also, they can obtain some of their mineral requirements directly by **rooting in the soil**, particularly iron and other minor elements.

We have to understand that the mineral content in grain and forage-pasture depends to some extent on this **amount in the soil**. Where topsoil is limited, in areas with very heavy rainfall, in areas naturally deficient in certain minerals, and on land that has long produced crops with poor replacement of minerals we can expect that foodstuffs grown will contain lesser amounts of minerals. This **almost always** means that we have to provide **additional minerals** since one or more of the above conditions prevails in most areas and swine will not grow or reproduce well without adequate minerals.

Where a complete mineral mix (calcium, phosphorus, salt and minor elements) is available and at affordable cost it should be fed since only small amounts are consumed daily. In other circumstances, a practical solution can usually be found if one has a basic understanding of the problem.

A good trace mineralized salt will supply salt and the minor elements — all that is needed except calcium and phosphorus.

Calcium is the principle component of Limestone (Lime) which is often available and the usual source of calcium. It may contain magnesium also.

**Steamed bone meal** is a good source of calcium and phosphorus and often used. **Defluorinated rock Phosphate** is a good source of phosphorus and calcium. **Raw rock phosphate** with the **fluorine not removed is poisonous to swine**. **Dicalcium phosphate** also contains both calcium and phosphorus and works well for pigs. **Caution** — Do not use lime that has been heated or has had other ingredients added as for cement or mortar mix. Protein supplied from animal sources also provides a source of calcium and phosphorus. **Possible Mineral Mixes** that might be prepared locally.

- Mix No. 1 — Equal parts — ground limestone (or oyster shell)
  - steamed bone meal
  - trace mineralized salt (or iodized salt)
- Mix No. 2 — Equal parts — ground limestone (or oyster shell)
  - DiCalcium phosphate
  - trace mineralized salt (or iodized salt)
- Mix No. 3 — Equal parts — ground limestone (or oyster shell)
  - Defluorinated Rock Phosphate
  - trace mineralized salt (or iodized salt)

Mix No. 4 — Equal parts — steamed bone meal or DiCalcium phosphate  
— trace mineralized salt

This mix is not as good as numbers 1-3 mixes, but can be used for pigs.  
Mix No. 5 — Another mineral mix that can be used, though not as good but simple and inexpensive is:

- 80 pounds of wood ashes and
- 20 pounds of trace mineralized salt

All of these mixtures should be fed free-choice to all ages daily, in boxes or feeders protected from rain; unless they are being fed as a complete ration containing minerals. If no other minerals are available **wood ashes** can be fed. However, they are best used to extend other better quality minerals. It can be fed at one teaspoonful daily per 100 pounds bodyweight and seems to also have a small beneficial effect in controlling intestinal worms. Also, bone meal or mixed minerals can be fed daily at one teaspoonful per 100 pounds body weight. In many areas there are cattle or poultry operations who are using home-made or commercial mineral mixes who will help other farmers. Although these are slightly different from the needs of pigs, they are preferable to doing without. Also, they might help you obtain certain ingredients such as trace mineralized or iodized salt.

**Ground Oyster Shells** (clam shells, coral, coquina or any seashell) (or mussel-fresh water shells) can be used when lime (limestone) is needed. Ground oyster shell is usually available wherever poultry are grown, but needs to be more finely ground for pigs.

**Fish** in the diet will provide iodine if fed often and also other minerals such as calcium and phosphorus.

**Selenium** is a mineral needed by animals, but in extremely minute amounts. It is deficient in most coastal flatlands, river valleys that flood and most areas with high rainfall. Trace mineralized salt often contains selenium and would be preferred, if available.

**Note** — Animal bones are often available and they can be **finely ground** or crushed by hand or a hammer mill. They should be **thoroughly cooked**, preferably in steam to kill germs. Fresher bones are better for these purposes. They are good sources of calcium and phosphorus.

**Note** — Trace mineralized salt contains iodine and minor elements and is less costly to transport than complete mineral mix with calcium and phosphorus. It can then be mixed with the calcium and phosphorus source. If trace mineralized salt is not available, use iodized salt rather than plain salt. **See later notes on Adding Iodine to Salt in the discussion on salt.**

**Note** — Commercial trace minerals without salt may be available.

They could be mixed with salt and the calcium and phosphorus sources for a complete mineral by following the label directions. Since only very small amounts are used, transportation costs would be small.

**A simple homemade mixer** adequate for mixing minerals is described in the **discussion on salt** and there is a **drawing in the section on Buildings and Equipment**.

**Calcium and Phosphorus Deficiencies** are usually seen as swollen joints and arthritis in all ages, but is much more noticeable in young growing pigs a few weeks after weaning. Sows often show weakness and paralysis in rear legs and reproductive problems and poor milking is common.

Mineral needs are very great in animals being fed grain alone and no protein.

They are less critical in animals on good grazing and in animals fed on animal or fish protein.

**Salt** is the one mineral which swine always need. It may be fed loose or in blocks, or mixed into the ration. In most primitive systems it is fed loose, preferably in a free choice mineral mix. If not fed as part of a mineral mix, Trace mineralized salt or at least iodized salt should be used. It should be fed daily or as often as possible. Health problems may arise if hogs go very long without salt. Also, they may overeat salt when it becomes available with serious consequences if they have long been without it. Salt or mineral mixes should be kept covered to protect from rain. **Water dissolves salt and pigs may consume too much.** If salt is fed in a complete ration with a grain-carbohydrate source and protein, it should be used at 0.5% rate, equivalent to 1/2 pound in 100 pounds of feed or 10 pounds in a ton of feed. **If fed this way, do not give other salt.** Animals should always have access to plenty of fresh water. **Swine on complete feed with salt have to have water constantly available.**

Since iodine is so important and iodized or Trace mineralized salt may not be available, the following information is given.

#### **Sources of iodine for mixing with salt**

Potassium iodide	(readily available to livestock
Sodium iodide	but will leach or evaporate
Calcium iodate	from salt blocks)

Pentacalcium orthoperiodate (PCOP) is equal to above in availability, but will not be lost as rapidly from blocks. Used when exposed to rainfall.

EDDI (ethylenediamine dihydriodide) — also useful for livestock. Less problem with moisture.

Potassium iodide is less desirable because of moisture problems, but is often available, even in remote areas. Drug stores often stock it or can order it; also try chemical supply companies.

EDDI is an iodine containing preparation that is often fed to cattle and might be available through feed dealers or possibly from cattlemen. It is not an expensive product and because of the very small amount used it can well be justified. An advantage is its moisture tolerance.

The following table provides a list of iodine containing preparations and amounts to use in mixing with salt.

	<b>Amount of Product to Add to Salt to provide 0.007% Iodine</b>		
	% I	mg/kg	gm/100 lbs.
Potassium iodide	76	92	4.2
Calcium iodate	65	108	4.9
Sodium iodate	85	82	3.7
EDDI	79	87	3.9
PCOP	26	270	12.3

**Conversions:**

- 1 ounce = 28.35 grams
- 1 gram = .03527 ounces
- 1 kg. = 2.2 lbs.
- 1 lb. = .454 kg.

In known iodine deficient areas, especially if goiter is seen, the amount of iodine may be doubled in salt or even tripled. The larger amount may also be easier to mix.

**Note 1:** Iodine or Trace minerals can be mixed with salt in small containers but the high dilution factor makes this very difficult. A clean oil drum (usually a 60 gallon barrel) with a steel rod through the center and a handle on it suspended on a pole frame makes an adequate mixer for this purpose and for mixing small amount of feed and mineral mixes. **(See Drawing in section on Buildings and Equipment).**

**Caution** — Containers previously used for gasoline and oil are safe if thoroughly cleaned with soap and water or steam. **Never take a chance on a container that may have contained poisonous chemicals. They cannot be cleaned well enough to be safe.**

**Note 2:** If there is no other way to provide iodine, it can be furnished by dissolving one ounce of potassium iodide in one gallon of water and feeding each sow one tablespoonful of the solution on her feed once each week. This is **only as a last resort in known iodine deficient areas. Do not overdose!**

**Iodine Deficiency in pigs** is seen as goiter (greatly swollen glands in the throat below the ears) of newborn and very young baby pigs



and lack of hair in pigs. Animals also do not grow and reproduce well.

Pigs with symptoms of a **salt deficiency** will be seen licking boards and do not grow and reproduce well.

#### 5. **Water:**

Water is the most important nutrient required by swine, yet it is one of the most neglected aspects of swine production.

Since water is so important the following table is given for information. For their size, swine require a surprisingly large amount of water.

<u>Weight of Hog</u>	<u>Gallons Water Per Day</u>
50 lbs.	Up to 1.0
100 lbs.	Up to 1.5
150 lbs.	Up to 2.0
200 lbs.	Up to 2.5
250 lbs.	Up to 3.0
Pregnant Sow	Up to 3.0
Lactating — Sow with nursing pigs (Milk is around 80% water)	Up to 6.0
Weanling Pig	Up to 0.5

In extremely hot weather they may need even more water. Swine should have water constantly available if possible, or at least several times daily. Swine given fresh water instead of ground (surface) or pond or stream water will have much less parasite and disease problems.

However, regardless of the source it must be frequently available. Homemade inexpensive troughs and other suitable containers for water are shown in the section on Buildings and Equipment. Surprisingly, pigs prefer clean fresh water to dirty surface water.

#### 6. **Methods of Feeding Pigs:**

Pigs may be fed in a number of ways. The farmer may combine methods to fit his situation. For example, he might hand feed limited amounts of protein and grain and graze on good quality forage.

A. **Self-Feeding** — requires a feeder in which feed is placed and pigs are allowed to eat at will. This is usually done where larger groups of growing animals are being fed. Sows should **not** be self-fed; they will become too fat and have trouble with farrowing and milking. Self-feeding is not practical in most primitive situations or where only a few animals are being fed. Its advantage is in saving labor. A **drawing** of a self-feeder is shown in the section on Buildings and Equipment.

B. **Hand-Feeding** — is done with small groups and where one wants to limit feed to sows. Small amounts are fed one or more times daily in troughs or other containers. Animals are fed no more than

the amount they will consume at the time. There is much less waste and a healthier situation where feed is placed in troughs or other containers rather than on the ground. Hand-feeding takes more time and labor than self-feeding, but no expensive equipment. This is the commonest method of feeding in small operations and under primitive conditions.

C. **Gleaning** — is a good and simple way to fatten animals. **After harvest**, pigs are turned out to clean up waste grain, rice, peas, beans, and other crops. The stubble or other remains alone may be adequate, but extra protein is usually needed. Gleaning is also good for pregnant sows. Animals under 3 months of age will not do well on stubble. Nursing sows will need additional grain and protein in most situations. This feeding method saves time otherwise lost and should be used in almost all circumstances following harvest.

**Hogging Down** — is similar to gleaning and is a way of letting pigs harvest their own feed. It saves labor, but is not as efficient as other methods because some feed is lost. This method may be used for almost any crop except soybeans. Some additional protein should be also feed unless animals are on beans or peas which contain adequate protein. Sows and fattening animals over 3 months of age do well but younger animals do not do as well. There is less waste of feed if a small area is used until all the feed is gone and then another area is used. Smaller animals often cannot reach the food and one or more older pigs should be in the group to help break plants down. **Water** should always be available closeby to animals gleaning or hogging-down crops.

Labor saving is the primary advantage in hogging-down crops. The loss of feed is too great to justify its use in most cases.

E. **Pasturing-Grazing** — as already mentioned is good for all ages, especially pregnant and nursing sows and young pigs. If forage is plentiful this is best, but it can be wasteful. In many cases, it is best to cut it and bring to the animals. Grazing animals get sunlight and exercise, plus moderate amounts of carbohydrate and protein as well as vitamins and minerals.

Nursing sows will need additional grain and protein and pregnant sows will do better with it.

F. **Hay-Dried Forage** — is a method whereby excess forage is preserved by drying for use at a later time. This evens out the food supply between better growing seasons and poor growing seasons, and it saves on the cost of purchased ingredients. While not efficient users of dried forage as are ruminants, older pigs can use it to greatly extend grain-carbohydrate and protein source foods. It also contains minerals and vitamins. The forage should be cut for hay near the time of maximum growth, but while still tender and green. It should be

dried as rapidly as possible. This often means that it has to be protected from daily rains and then placed out in the sunny part of the day or dried under sheds.

G. **Creep Feeding** — this is a method that provides nursing pigs with feed that is not accessible to the sow. It is a method that introduces baby pigs to solid food and greatly reduces the shock of weaning. The sow's milk production begins to decrease when the pigs are around 3 weeks of age. Creep-feeding helps offset the lessening milk flow and helps pigs grow faster. A small shallow trough or other container is placed in a small enclosure with an opening only large enough for baby pigs to enter.

Finely ground feed, initially mixed with milk if possible, for a day or two, is fed to baby pigs in the creep area starting at 2-3 weeks of age. When pigs are eating well, milk is not necessary, but is still a great help if available. **Bread scraps can be fed instead of ground food.** Do not let milk spoil, it can make pigs sick. Clean troughs often if milk is fed. There is more information in the **section on Baby Pig Management**, and sample rations 1-3 at the end of the section on Nutrition.

### **Food Preparation for Pigs:**

1. **Grinding (or crushing)** — For small grains, such as wheat, oats, barley, sorghums such as m:ao and millet. This is almost a necessity for efficiently growing swine. Baby pigs have to have ground grain. Corn can be fed whole in older animals, but has to be ground for baby pigs. Other small grains can be fed whole, but not as efficiently. Hammer mills are most often used for grinding, but are not available in many areas. Small portable hand grinders used for making corn meal and flour are available in many areas. They are slow, but satisfactory. In very primitive situations, mortar and pestle is often used for a few sows and baby pigs.

2. **Soaking** is a poor alternative to grinding small grains to improve digestibility of small grains. It is not as good as grinding. Grain is placed in clean water in a container and fed after soaking 24 hours. Feed soaked over one day may ferment and cause problems.

3. **Cooking Grain or Forage** — does not improve digestibility, and is **not recommended**. However, rice products need to be cooked.

4. **Cooking Potatoes and Bean and Peas** — This does increase food value and **is recommended**. Potatoes may be cooked with dry heat or steamed or boiled. They should then be cut into small pieces or ground into meal. **Beans** should be steamed or boiled to eliminate the bitter taste and are more digestible if ground or crushed before feeding. **Soybeans have to be well cooked.**

5. **Grinding or Chopping Hay or Dried Vegetation** allows

pigs to make better use of it and **should be done**.

6. **Chop fruit** and vegetable into small pieces to avoid choke and aid in greater consumption.

### **Feeding a Balanced Ration:**

Pigs require a balanced ration for good health, growth and reproduction. Daily or as often as possible, the following categories of foodstuff should be fed.

1. A grain-carbohydrate source or grain substitute.
2. A protein source, plant and/or animal.
3. Mineral and salt source — preferable free-choice.
4. Vitamin source — usually green forage.
5. Adequate Water — at all times.

A highly detailed discussion of balanced rations for pigs is beyond the scope of this booklet. However, the following guidelines should be a big help.

1. Generally the diet of pigs should contain around 75-80% grain-carbohydrate (or grain substitute) sources and 20-25% from protein sources with minerals and salt fed free choice or mixed in feed and at least some green forage being grazed or brought to animals, or fed dried as hay.

2. In most primitive situations, grazing will of necessity replace much of the grain-carbohydrate and protein source feeds even though growth and reproduction suffer as higher amounts are fed.

3. Also grain-substitute feeds will be necessity at times replace much of the grain in the ration. Again this is done at the sacrifice of fast growth and reproduction often is not as efficient.

4. Better quality feed (more grain and protein) should be fed to nursing sows and baby pigs.

5. Poorer quality food can be fed with less problems to larger growing animals.

6. Protein source foods should not make up over 1/3 of the diet.

7. Commonly used grains — corn, oats, wheat, barley, rye and sorghums contain around 7-8% protein. However, this is not enough for pigs to do well without at least some additional protein.

Grain alone with no additional protein can be fed to larger growing animals with slowed growth often the only consequence; however, vitamins and minerals should be provided. Grain with good quality grazing for large growing animals is often satisfactory except for slightly slowed growth rate. Grain alone is **not** adequate for nursing sows. Grain with good quality grazing is better, but additional protein is needed. Also, vitamins and minerals should be fed.

8. Fruit and vegetables should not make up over 1/3 to 1/2 of the total diet, if possible. However, conditions often dictate greater use

of these. The higher amounts would be best used in larger growing animals rather than in sows and baby pigs.

See other notes on feeding in the **Section on Management**.

**Caution** — Avoid sudden changes in type (source) and amount of each ingredient in the ration. Serious digestive upsets and other health problems may occur. This is especially true of high percentage protein source foods.

Pregnant and nursing sows and baby pigs are especially sensitive to sudden diet changes.

To prevent problems gradually add newer ingredients or increase regular ingredients by small amounts over several days.

### **Feeding Pregnant Sows**

Pregnant sows should gain 40-75 pounds between breeding and farrowing. This will vary according to her size, and condition (amount of body fat) at breeding. If she is extremely fat or too thin at farrowing time she will often have problems delivering the baby pigs and not give enough milk. While good grazing will supply part of her carbohydrate and protein needs, she still needs at least 1/4 to 1/2 pound of protein source food per day and some grain or grain substitute in order to produce normal pigs and milk well. The pregnant sow needs a constant source of minerals and vitamins also, if the unborn pig's skeleton is to develop normally. If possible, grain and protein should be increased slightly the last month of pregnancy.

### **Feeding the Nursing Sow:**

Sows should gradually be fed increasing amounts of food from the day after farrowing until on full-feed at around 10-14 days after farrowing. **If possible**, an approximate 80% Grain Source - 20% Protein Source ration should be fed or as close to this as possible, starting with 1-2 pounds per day and increasing by one pound per day to full feed, (all she will eat daily). Sows fed too much the first few days after farrowing may produce too much milk and cause digestive upsets in the baby pigs. Good quality grazing is a big help to the nursing sow and can replace part of the grain-protein source foods and is advised for most primitive production systems. However, in order to milk well some added grain and **protein source foods are needed**. Even in small amounts they are a big help. Never let the nursing sow and baby pigs use old contaminated lots and pastures. This helps prevent worm problems.

Fruits and vegetables, with the exception of a few such as bananas, pumpkin, coconut and breadfruit are too low in food value to feed to nursing sows except in small amounts and in emergencies. A constant supply of fresh water is necessary if sows are to milk well. Remember: The nursing sow is in a very nutritionally stressful period. Use good

judgment! About a week before weaning, gradually reduce the sow's ration to decrease milk flow. This will help dry up her milk and lessen chances of udder (breast) injury.

### **Feeding Baby Pigs:**

When pigs are 2-3 weeks old they will eat a little grain. They will accept it better if it is ground and mixed with milk. Bread scraps in milk also work well. The food should be placed in a **creep** area as previously described. As pigs become older and nearer weaning they should receive small amounts of the protein they will later consume. Milk is not necessary in the feed after pigs are eating well, but if it is plentiful it should be continued. Give pigs only what they will consume daily; the food will soon spoil.

Creep feeding is not inconsistent in primitive pig production systems; in fact, it is one of the most recommended management practices in raising healthy pigs. The creep feeding area should be located convenient to the baby pigs, preferably near their shelter and close to a source of water.

### **Feeding the Grower Finishing Pig:**

This is the age between weaning and market or home butchering. It deserves special consideration because a high percentage of feed used in the operation is used during this time. It is also a time in the pig's life when we have many options to consider in feeding these animals. As previously mentioned in feeding pigs of other ages, a ration based on 75-80% grain-carbohydrate source and 20-25% protein source foods with salt and minerals and green forage (or dried) is the preferred ration. However, the pigs of this age have less critical nutritional needs than pregnant or nursing sows and baby pigs. Although growth will be slowed and health problems may occur, this is the age that is most often fed on the grain-carbohydrate substitutes and garbage.

Surplus or inexpensive fruits and vegetables can be fed in larger amounts to this age pig than others.

In almost all primitive situations this age pig should be grazed on some form of green forage or have it brought to them. Good quality forage can greatly offset the deficiencies that would otherwise occur if a balanced diet were not being fed.

### **Sample Rations:**

Under primitive production systems there will be **very few times** when complete rations using ground ingredients will be fed. However, there might be circumstances where this information would be useful. A few sample rations follow. There are many others that could be used, based on other ingredients mentioned previously.

1. **Sample Ration No. 1** — Creep feed for baby pigs

- 75 pounds corn — finely ground
- 25 pounds protein meal — preferably part or all from animal or fish
- 1/2 pound trace mineral salt
- 1/2 pound ground limestone
- 1/2 pound steamed bone meal or DiCalcium Phosphate or Defluorinated Rock Phosphate

This is a very simple but adequate ration.

2. **Sample Ration No. 2** — Creep feed for baby pigs

- 58 pounds corn, finely ground
- 22 pounds soybean meal or other oil seed meal
- 5 pounds Tuna or other fish meal
- 3 pounds wheat middlings
- 10 pounds molasses or sugar
- 1/2 pound trace mineral salt
- 1/2 pound ground limestone
- 1/2 pound steamed bone meal or DiCalcium Phosphate or Defluorinated Rock Phosphate

3. **Sample Ration No. 3** — Creep feed for baby pigs

- 60 pounds corn
- 20 pounds soybean meal
- 5 pounds dried skim milk, milk replacer or mix other ingredients in milk
- 15 pounds sugar or molasses
- 1/2 pound trace mineralized salt
- 1/2 pound ground limestone or finely crushed oyster shell
- 1/2 pound steamed bone meal or Difluorinated Rock Phosphate

In all creep rations, wheat or oats may be substituted for corn with little difference. Other grains such as barley, rye and sorghum do not work as well in baby pig rations, but may be used if available and are finely ground.

4. **Sample Ration No. 4** — Pregnancy Ration — Hand Fed

- 79 pounds grain
- 18 pounds soybean oil meal
- 1 pound ground limestone or finely ground oyster shell
- 1 pound steamed bone meal or Defluorinated Rock Phosphate or DiCalcium Phosphate
- 1/2 pound Trace mineral salt

5. **Sample Ration No. 5** — Pregnancy Ration — Hand Fed

82 pounds grain  
8 pounds soybean oil meal  
7 pounds fish meal  
Minerals and salt as in Ration No. 4

6. **Sample Ration No. 6** — Pregnancy Ration — Hand Fed

24 pounds grain  
20 pounds molasses  
25 pounds pineapple bran  
5 pounds fat  
17 pounds soybean meal  
7 pounds fish meal  
1/2 pound steamed bone meal  
1/2 pound Trace mineralized salt

**Special Note:** Where minerals and salt are being fed free-choice, eliminate them from all above rations.

7. **Sample Ration No. 7** — Nursing Sow Ration

78 pounds grain  
19 pounds soybean meal  
1/2 pound Trace mineral salt  
1 pound steamed bone meal or Defluorinated Rock Phosphate or DiCalcium Phosphate  
1 pound ground limestone

8. **Sample Ration No. 8** — Nursing Sow Ration

82 pounds grain  
11 pounds soybean meal  
5 pounds fish meal  
1/2 pound Trace mineral salt  
1/2 pound steamed bone meal or Defluorinated Rock Phosphate or DiCalcium Phosphate  
1/2 pound ground limestone or finely ground oyster shell

9. **Sample Ration No. 9** — Nursing Sow Ration

57 pounds grain  
20 pounds molasses  
15 pounds soybean meal  
4 pounds fish meal  
2 pounds meat and bone meal  
1/2 pound ground limestone or finely chopped oyster shell

10. **Sample Ration No. 10** — Growing Ration — Low Protein

87 pounds grain  
10 pounds soybean meal



- 1/2 pound Trace mineral salt
- 1 pound steamed bone meal or DiCalcium Phosphate  
or Defluorinated Rock Phosphate
- 3/4 pound ground limestone or finely ground oyster shells

This is an example of a simple grain-soybean meal ration.

11. **Sample Ration No. 11** — Growing Ration — Medium Protein

- 60 pound grain
- 12 pound soybean meal
- 4 pounds fish meal
- 2 pounds meat and bone meal
- 20 pounds molasses
- 1/2 pound Trace mineral salt
- 1/4 pound ground limestone or finely ground oyster shell
- 1/4 pound steamed bone meal, DiCalcium Phosphate or  
Difluorinated Rock Phosphate

This ration is more complex with several protein sources.

12. **Sample Ration No. 12** — Growing Finishing Ration —  
High Protein

- 61 pounds grain
- 17 pounds soybean meal
- 3-1/2 pounds fish or tuna meal
- 2-1/2 pounds meat-bone meal
- 15 pounds molasses
- 1/2 pound Trace mineral or iodized salt

This ration shows an example of using molasses and several protein sources.

13. **Sample Ration No. 13** — Growing Finish Ration —

- 30 pounds soybean meal
- 5 pounds Tuna or fish meal
- 48 pounds molasses
- 10 pounds bagasse pulp
- 5 pounds vegetable oil or other edible fat
- 1/2 pound Trace mineral or iodized salt
- 1/2 pound steamed bone meal or Defluorinated Rock  
Phosphate or DiCalcium Phosphate

**Special Notes:**

1. Where minerals and salt are being fed free choice, eliminate them from above rations.
2. These rations are based on assumption that animals are grazing or being hand fed green forage or good quality hay.
3. Generally animal-fish and plant source protein may be interchanged in rations with little or no adjustments. However, animals

grow and reproduce better and are healthier when some of each is fed. When animal or fish protein is substituted for plant source protein, less is needed, around 10-20% less.

4. Cooked soybeans (preferably with dry heat) that are crushed or ground may be substituted for soybean meal in these sample formulas. They should be used at a slightly higher level, around 20% more than soybean meal. The additional fat in the cooked beans helps nursing sows produce more milk. It also would help balance out a ration that was deficient in grain-carbohydrate. Since soybeans can be grown in many areas and require very little commercial fertilizer, growing them and home-cooking for swine feed would seem to be a good idea.

**Caution:** Since cooked soybeans contain more fat, the rations made from them spoil more quickly. The ration should be made often and in small amounts.

Although extensively researched, there are many other potential food sources available for pigs. A little imagination and a few dollars spent on a small scale experiment could possibly mean a breakthrough of great importance in your area. The author would appreciate hearing about other foods used for pigs. He will also be happy to furnish more information on nutrition in pigs.

# Section 4

---

## Management Practices

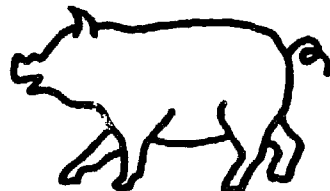
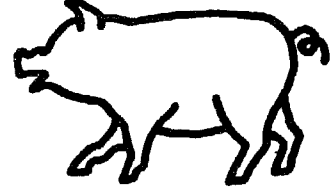
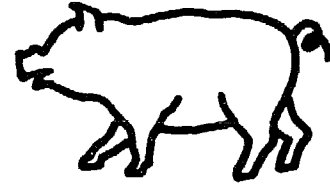
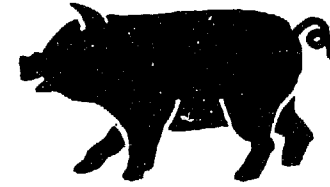
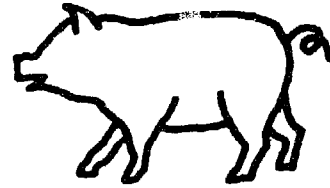
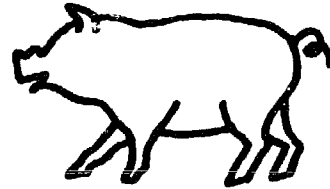
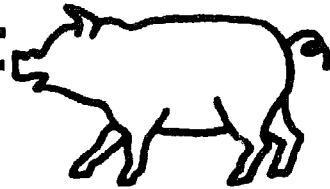

## Reproduction

Covers Management Practices from Breeding  
through Farrowing

### A. Selection of Young Females (Gilts) for Breeding Animals

Look for the following:

1. Select females from best milking mothers (dams).
2. Select females from largest litters.
3. Select larger faster growing females of litter.
4. Females free from obvious defects such as hernias, lameness and other health problems.
5. Females with at least 10 well developed, well spaced teats (preferably 12 teats). None of the teats should be "blind" (non-functional teats) which do not protrude as do normal teats.
6. Be of Desired Body Type.
  - a. Short blocky fat type animals if cooking fat is in demand.
  - b. Long, lean, muscular type animals if lean meat is much in demand.
  - c. In most situations, the preferred body type is a compromise between the first two types.
6. Purchase from herds with as few health and disease problems as possible. Purchase virgin females that have never mated with a boar. This greatly lessens the chances of her introducing one of the diseases that cause reproductive problems.

### B. Selection of Males (Boars) for Breeding Animals

1. He should have the rugged masculine appearance of a male.
2. Free from hernias, lameness and other health defects.
3. Two large, well-formed testicles.
4. From a large litter.
5. Fastest growing males of the litter.
6. Not related to your females — preferably from a different herd than your females.
7. From herds that are as disease free as possible in the area.
8. Body type as referred to in female selection.

If no good quality boars are available in the immediate area it may be necessary to look elsewhere. In most countries there are herds with high quality breeding animals. The high cost of these animals and transportation problems may make it impossible for most primitive operations to obtain them. There are foundations and organizations that can help, such as Heifer Project in Little Rock, Arkansas, and many

church groups as well. The male pigs from one high quality boar can then go into other herds and improve them.

One good male can help genetically as much as many females, at much less cost.

Always purchase **virgin boars** if possible. This greatly lessens the chances of introducing disease. This is especially true if we are purchasing higher priced animals.

**Blood Tests For Purchased Breeding Stock** — Purchase of virgin females and males from herds with no known disease problems is always a good idea. An even better safeguard would be blood tests for diseases such as Brucellosis. However, this is only possible where there is a veterinarian in the area.

### C. **Physiology of Swine Reproduction — An Understanding**

Swine are not seasonal breeders. This means that their reproductive cycles are not directly affected by seasons. However, in areas with more extremes of winter and summer, they often tend to farrow more in spring and fall with milder weather. Generally the gilt from her first heat (estrus) or the sow after weaning her pigs will continue to cycle regularly until she becomes pregnant, or is nursing pigs or develops a health problem.

1. **Heat (Estrus)** The 2 or 3 day period when the female will accept the male in the mating act. It is seen as a swelling of the vulva (external female genitalia) and a sudden show of interest by the male. It is the only time the female will accept the male.

2. **Heat Cycle (Estrus Cycle)** The interval between heat (estrus) periods. It averages 19-21 days, but may vary by another day or two.

3. **Ovulation** — release of the ova (egg) by the **ovary** (female sex glands) so that it can be fertilized by the male's sperm. Ovulation generally occurs the second day of heat. That day and the next day are when mating (breeding) should take place for best conception (fertilization of ova by sperm).

4. **Conception** — fertilization of ova by sperm following the mating act.

5. **Female Puberty** — Time of the first heat period and first desire to mate with the male. It varies by breed, size, nutritional conditions, other health factors and by climate. It may be as early as 6 or 7 months or as much as a year of age.

6. **Male Puberty** — Time of their first desire and ability to mate with the female. It is generally a month or so earlier than in the female but varies because of the same factors.

**Breeding (Mating) Methods** — There are two methods of breeding (mating): hand breeding and pen breeding.

In **Hand-breeding** — the male is kept separate from females.

When the female is noticed in heat she is brought to the male for breeding. The advantages of this are that the male may serve more females and is not left with the pregnant females. (There is a chance that the male may injure the females if left with them). The disadvantage is that someone has to closely observe the females for heat daily and extra labor is required in moving the female to be bred. It requires someone experienced in observing heat.

In **Pen-Breeding** — the male stays with the females. The advantages are that the male will find the female in heat and no labor is required in moving the female. The disadvantages are that the male may injure pregnant females and that he cannot serve as many females. This is **because of its simplicity the method usually used in primitive systems.** If a herd is successful and gets larger than a few females and one boar then hand-breeding is often used.

**Age to first breed females** — as previously mentioned in notes on puberty, the age of the first heat varies because of many factors. However, it is rare to breed gilts under 8 months of age. Some gilts do come in heat earlier but unless they are fully grown should not be bred until they are 8 months old. In most primitive situations, gilts grow slowly and reach puberty late and are bred later.

Gilts bred when too small will not grow to the normal size and often have trouble at farrowing time.

**Age to first breed males** — Young boars are usually not bred before 8-10 months of age. Those that reach puberty may be bred occasionally, but litter size is often small and conception is poor.

**Time of Year to Breed Females** — Left on their own swine will breed year around. However, where there are distinct seasons they tend to farrow more in the spring and fall. Since baby pig survival is best in least severe weather, it is a good idea to breed sows to farrow during these times. In areas with heavy rainfall at one season, it is a good idea to avoid farrowing during that time. In areas with little seasonal changes the time of year to farrow would not be of importance unless there were some other factors such as seasonal market demand or transportation problems.

**State of Heat to Breed Females** — The best time to breed the females is on the second day of heat. If she is still in heat on the third day, breed her again. Conception is much better with two matings. Of course, where the boar is running with the females he usually breeds them several times.

**Breeding Sows After Weaning** — Sows generally come into heat 3-7 days after pigs are weaned and they are mated at that time. If they are too thin they should not be bred on the first heat. They need time to put on some flesh before being bred. Occasionally, a sow will come into heat when pigs are 2-3 weeks old and still nursing. They should

not be bred at this heat.

**Length of Pregnancy (Gestation in Swine)** — The length of pregnancy in swine averages 114 days with up to 3-4 days variation; earlier or later. An easy way to remember it is the often heard "three months — 3 weeks and 3 days." For example, a sow bred on January 1 will farrow around April 24. It is important to keep good breeding records in order to give the sow some special care the week prior to farrowing.

**Managing Pregnant Females** — Basically, we must remember that the pregnant animal is an expectant mother. The life of the pig begins at conception and the ration fed the pregnant sow is extremely important, (refer to previous notes in nutrition section on feeding of pregnant animal).

After she is obviously pregnant, not coming into heat on the 19-21 day cycle and showing sign of udder enlargement, she should not be allowed to run with the boar.

The unborn pig, especially early in pregnancy, can be affected if the sow becomes overheated. For this reason she should be given good protection from extremes of heat and should not be overly exerted as in moving her or excited by other animals.

If at all possible, the pregnant female should be allowed to graze and on the best forage available. The nutritional value of the green forage and the exercise both help her develop healthy pigs.

**Care of the Male** — The male should be fed very much like the pregnant female. He needs to stay in a medium state of flesh, not too fat or not too thin. Boars too thin will not be able to perform well and those too fat tend to be lazy and poor breeders. The boar should be fed very much the same as pregnant females. However, if he is breeding sows often he may lose weight. If this happens he should be fed more to keep him in the medium state of fleshing.

When there are no females to breed, he should be kept separate from the other pigs. He needs at least a quarter of an acre so he can get exercise, with adequate protection from extreme weather. He should be able to graze or green food should be brought to him to supplement his other food.

His pen or pasture should be moved occasionally to prevent health problems.

**Boar Use** — The boar can breed more females in a given period as he grows older. Males under 1 to 1-1/2 years of age should be used to breed no more than 2 or 3 females per week. As they become older, they can be used to breed more females, up to as many as six per week, if they do not come into heat at the same time. In most primitive situations where there are only a few sows, it would be rare for him to be bred too often. One mature boar should be enough for 10-12

SOWS.

When weaning pigs from sows, do not wean several sows at one time if there is only one boar. They will come in heat about the same time and the boar may be overworked and small litters may be the result.

Protection from heat is very important. Extreme heat has the effect of killing sperm in males for around 30 days and females will not conceive. Avoid undue exertion in moving and handling and provide protection from extreme heat. A boar that has been sick with a high fever usually cannot effectively breed for 30 days.

**Tusk Removal in Boars** — Most boars develop long protruding teeth at the corner of the mouth called tusks. They become larger as the boar grows older and can be very dangerous to the farmer and his family and to other pigs. Usually by the time the boar is one and a half years of age they have to be removed. To remove the tusks the boar is restrained by way of a rope tied around the upper jaws behind the tusks and the rope tied to a post or tree. Then large nippers such as bolt cutters, or a saw is used to remove the part of the tusk above the gum line. Try not to damage the gum. This may have to be repeated later.

**Sharing Boars by Different Farmers** — This is a situation where necessity, too few sows on one farm to justify a boar or the cost of the boar mean that two or more farmers must use the same male. There is a considerable risk because there are diseases that he can spread. However, where the farms are closeby each other or where animals often intermingle, the diseases may have already spread.

There is one situation where the boar should not breed females from other farms. This is when a superior male is brought in to improve the pigs in a community. He should also be kept away from pigs running loose.

**Health Tests For Breeding Animals** — There are several breeding diseases that can be very serious and boars and sows should be tested if there is anyone available to do it. Blood samples are tested at laboratories and some can be done on the farm. If possible, animals should be tested prior to purchase. (See Other Information in Health Section).

**Preparation For Farrowing (Delivery of Baby Pigs)** — Decide how you want to handle sows at farrowing.

**Farrowing Methods:**

1. **Pasture Farrowing** — sows and baby pigs are left on their own.

**Advantages** — no facilities required.  
— no labor involved.

**Disadvantages** — can't assist with farrowing problems.  
— can't help newborn pigs.



— more pig deaths result from bad weather and wild animals.

2. **Pen Farrowing** — sows moved to small pen with a shed for days before farrowing.

**Advantages** — can help sows and baby pigs if they need assistance.

— some weather protection.

— temporary facilities can be moved, (and should be moved) to lessen diseases and parasites.

— more pigs saved.

**Disadvantages** — facilities required.

— need slightly more experienced help.

**This would be the system most practical for primitive locations.**

3. **Farrowing in Buildings** — with floors

**Advantages** — sow closely confined and easy to help with

— pigs can be better protected from weather.

**Disadvantages** — cost of facilities.

— need experienced help

— sanitation problems often lead to sickness

— have to prevent baby pig anemia (see Note) on Baby Pigs later.

### **Signs of Approaching Farrowing Time**

**2-3 weeks** before farrowing — udders (breasts) becoming noticeably enlarged.

**5-7 days** before farrowing — vulva (external genitalia) noticeably enlarged.

**24-48 hours** before farrowing — milk appears in teats.

**12-24 hours** before farrowing — sow becomes very nervous and restless and carries dried vegetation to make a bed.

**Assisting with Farrowing** — Old sows seldom need help with farrowing. However, gilts often need help with their first litter. If a pig lodges in the pelvis bones (birth canal) it soon dies, usually in 30 minutes unless delivered. If it remains there more than an hour or two the next pig also dies. If a pig lodges for 12-24 hours the other remaining pigs die and often the female also dies.

A clean, well greased hand and arm can often reach the lodged pig. Grasp the feet if possible and remove the pig with the least possible force. If the feet cannot be grasped, use the head. Often the first pig is the problem and others follow normally when it is removed.

A woman because of her small hands can often assist far better than a man.

**Caution:** Always wash and disinfect hands after assisting in

farrowing or handling newborn pigs. Never assist in farrowing if there are cuts or bad scratches on your hands. Rubber gloves are much better to reduce risk of human infections that can occur.

**Fetal Membrane** (Afterbirth) — contrary to the opinion of the uninformed, these should **not** be fed to sows; rather, they should be burned or buried soon after all pigs are delivered.

**Feeding the Lactating Sow** (Nursing Pigs) — Refer to notes in Nutrition Section.

**Helping the Newborn Pig** — The degree of involvement with helping the newborn pig will vary with the skill of the owner and the facilities. However, newborn pig survival is much greater when as many of these as possible are done.

**On Arrival** — remove from membrane.

- wipe mucus from mouth and nose with a clean cloth.
- clip the navel cord 1-2 inches long with scissors and spray or dip in iodine. **Wait about 20 minutes to do this.** If the cut cord bleeds excessively, tie it with cotton string or fish line.
- if weather is cold, dry pigs off with a clean cloth soon after delivery. You may also put them in a box or basket lined with straw until all pigs are delivered, but not longer than 2-3 hours.
- they must nurse as soon as possible to get colostrum (milk in udders at birth that gives protection from infections).
- needle teeth are very sharp teeth often found at the front corners of the mouth, both upper and lower, in newborn pigs. They can damage the udder of the mother if not removed. Small wire cutters or pliers with side wire cutters work well. Only the outer half is removed; do not injure the gum.

**Iron Deficiency Anemia in Baby Pigs** — An unhealthy condition in baby pigs called **baby pig anemia** (lack of blood) is common in baby pigs who do not have access to soil the first few weeks of life. It is caused by a lack of iron and copper which is **essential for blood formation**. Since sow's milk is deficient in both of these minerals, baby pigs **must have additional amounts** or their chances of survival are very poor. Soil usually contains adequate amounts and the baby pigs almost from the first day will eat soil. If they are housed in buildings with floors they do not have access to soil and a method **must be found** to provide iron and copper.

The simplest solution is to bring soil to the pigs and place it in

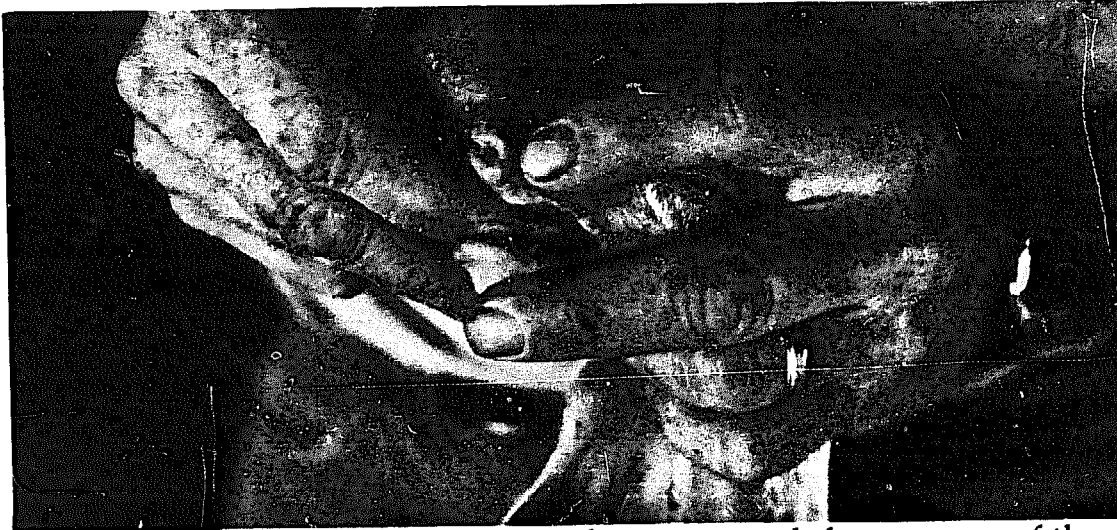

Notice the needle teeth. There are eight: two at each front-corner of the upper and lower jaws.

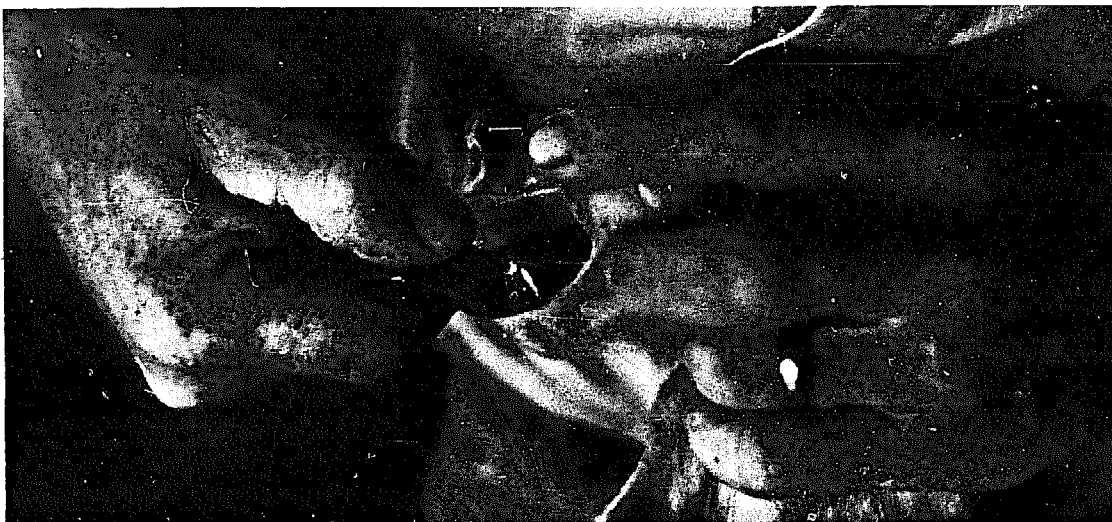

Method for trimming needle teeth of a newborn pig.



The pig's mouth after its needle teeth have been trimmed.

a small container for each litter of pigs. **This adequately solves the problem** but soil should come from an area that **pigs have not had access to**. This prevents spread of parasites and disease germs to the pigs. This dirt should be replaced often.

There are commercial injectable and oral products available for pigs and solutions to apply to the sow's udder, but these are costly and often not available.

Anemic pigs have very poor resistance to infections, do not grow well and many will die if an iron source is not provided by the end of the first week. It should be provided by the third or fourth day of age.

Pigs born on the ground should not have an anemia problem.

**Feeding The Baby Pig** — (See Notes in Section on Nutrition).

**Castrating (Testicle Removal) The Baby Pig** — Pigs are castrated for several reasons: to prevent an unpleasant taste and odor in meat, to prevent the nuisance of the boars not needed for breeding, and some people think castrated males grow faster.

Under most primitive conditions male baby pigs should be castrated around 2-4 weeks of age. Pigs withstand castration much better while nursing than after weaning.

The operator should be careful to have his hands and knife clean (and disinfected if possible). The scrotum (skin over testicles) should also be washed (and disinfected), as well as the knife.

Hold the testicle firmly between the fingers and thumb and make an incision through the skin and into the testicle with a sharp knife. The incision should be parallel to and 1/4 to 1/2 inch off the midline of the scrotum. Separate the testicle from the surrounding tissue, pull it away with the attached spermatic cord and cut it off near the body. Remove the other testicle in the same manner. Be sure the incisions are low enough for good drainage when the pig is standing; this speeds healing.

After the operation, blood should be washed from the skin near the incision. Blood will attract flies and infection may result and insect larvae such as screwworms may infest the wound.

Wound spray of liquid (with fly repellent) applied around the wound is even better.

Often in the community, there is someone with experience in castrating pigs. His techniques should be observed. However, some of these mentioned suggestions might well be an improvement.

Keep the recently castrated pigs from dirty wallow areas and other unsanitary conditions until wounds heal.

**Common Mistakes in Castration** are failure to clean and disinfect prior to the operation, incisions too small for drainage, incisions too high for drainage, wet and unsanitary living conditions before healing

and waiting until pigs are past weaning age.

There are many satisfactory **disinfectants** including iodine, alcohol, very weak solutions of chlorine laundry bleach, hydrogen peroxide, mercurochrome and any human disinfectants available.

**Weaning** — Separating Nursing Pigs From Their Mother. This is one of the greatest stress periods in the pig's life. It is also a time of considerable stress on the sow.

In the natural state, sows usually wean the pigs themselves and when pigs are around 8-10 weeks old.

In modern operations with confinement rearing, baby pigs are often weaned as early as 3-5 weeks of age. However, in **primitive situations**, without expensive buildings and sophisticated rations, **this is neither or wise to do**. Since sow's milk is the natural food for baby pigs it should be used as much as possible. This means leaving pigs on the sow until around 8 weeks of age. The quantity of milk starts decreasing at around 3-4 weeks after farrowing. Baby pigs should be started gradually on solid food at 10-14 days of age and fed increasing amounts as they grow older and as sow's milk is decreasing. If they are eating solid food well, there is much less digestive shock at weaning and fewer health problems in general. (**There is much more information on feeding Baby Pigs in the Nutrition Section.**)

The nursing sow should have her food gradually decreased starting about a week prior to weaning. This will greatly lessen her milk production and lessen the chances of udder problems following weaning.

**Sow Weaning Problems** — If, as occasionally happens, the udder becomes distended with milk a day or so after weaning, pigs can be allowed to nurse a few minutes every other day.

If the udder becomes "caked," (hard to the feel and often with a hot feeling), a simple remedy is to massage it daily with comphorated oil, a common human remedy for bruises. If the sow should also lose her appetite, she probably has an udder infection and fever. In this case she will need to be treated with antibiotics — (See Health Section).

**Baby Pig Weaning Problems** — These can usually be prevented by the following:

1. Continue pigs on feed they are already used to before weaning. By not changing the feed we avoid one stress that often causes problems. After a week or so the feed can gradually be changed.

2. Remove the sow and leave the pigs in their familiar surroundings for several days. This is a simple way to prevent another stress problem.

**Weaning Age For Two Litters Per Year** — Under most primitive conditions two litters per sow per year is feasible. Consider that pregnancy length in the sow is almost 4 months and that sows come in heat a few days after weaning pigs. This means no later than

**8 week weaning** of baby pigs for two litters per sow per year. this is also a very good time for the sow and baby pig.

**A Big Decision — One or Two Litters Per Year Per Sow** — While 2 litters per year should be tried for in most cases, there will be instances where 1 litter may be more practical. One situation would be where for various reasons, food for pigs is very limited at certain seasons. Sows might be on a maintenance ration and unable to sustain a normal pregnancy, and nurse pigs adequately. In that case, sows should be bred to become pregnant and farrow during the highest level of nutrition.

Another circumstance would be when one season of the year is a long period of extreme weather. Maintenance of pregnancy and baby pig survival might be very poor.

**Raising Orphan Pigs** — Orphans pigs become a problem when the mother sow dies, is sick and not giving milk or occasionally when the sow has too many pigs and some must be taken away (generally over 12 in the litter).

Cow's milk is a satisfactory food for the newborn pig. Human baby bottles can be used but cleaning and sterilizing are a big problem. Pigs will usually drink from a shallow pan. They must be fed six times a day for the first two weeks, then gradually reduced to three times a day. At around 10-14 days, small amounts of bread scraps or cracked grain can be added and gradually increased and the milk decreased over the next several weeks. **Goatmilk is less desirable**, but may be used.

Another possible solution is to move pigs to sows with very small litters. This will only work if the orphan pigs are within a few days of the age of the other pigs. Very often the sow will reject the orphan pigs. This may be overcome by wetting the orphan pigs' backs with milk or a human skin medication, both of which would have an odor that would confuse the sow as to which were the orphan pigs.

## **SECTION ON THE GROWER-FINISHER (FATTENING ANIMAL)**

### **A. General**

After pigs have made the adjustment of weaning, they have passed the most critical stages of their life.

The Grower-Finishing-Fattening period is the period between that time and the time when they reach the desired slaughter or market weight.

It is that stage in their life when if given reasonably adequate nutrition and protection from extreme weather they should reach market or slaughter weight with very few problems.

It is the age when there are less critical nutritional and environmental needs. **However, the fewer of these compromises that we have to make the faster growing and healthier these animals will be.**

#### **B. Nutrition of the Grower-Finisher Animal**

This is well covered in the Section on Nutrition. The important point is to keep in mind that the needs of the pregnant and nursing sow and baby pigs must come first if the amount and quality of food are in limited supply. This age animal may be stunted by inadequate nutrition but has a much better chance of surviving.

**If food is plentiful they should be allowed to consume all that they will.**

#### **C. Environmental Consideration of the Grower-Finisher Animal**

This was covered in general in the Section on Environment. However, there are a few things to keep in mind.

1. Where higher, well drained land is limited or land has been heavily used by pigs for a long period of time, this age animal could better tolerate the less satisfactory conditions.

2. Also, where natural or man-made protection from extreme weather is limited this age animal can better tolerate these conditions.

However, every possible effort should be made to provide satisfactory living conditions so that animals will be healthy, fast growing and the operation be efficient. Animals subjected to excessive environmental stress will not efficiently use food, will grow very slowly and develop health problems.

#### **D. Length of Time to Reach Slaughter Weight**

This will vary according to nutrition, environment, disease and health conditions and the genetic makeup of the animal. Well bred animals on a balanced ration and satisfactory living conditions often reach slaughter weight as early as 6-7 months of age. Under less satisfactory conditions it may take as long as 12 months and unhealthy animals may never reach that point.

**Factors in Growth Rate** — The major limiting factor in growth rate under most primitive conditions is a lack of protein in the diet and failure to control internal parasites (worms) and environmental stress.

Other factors often involved are mineral deficiencies and other nutritional problems and many health and disease problems.

#### **E. Castrating Older Pigs**

As we mentioned earlier in the Section on Baby Pigs, castration should be done prior to weaning. However, for various reasons this

may not have been done. It can be done at later times, but the risk is greater. The major problem is blood loss from the larger blood vessels and the greater risk of infection. Blood loss can be prevented by tying off the blood vessels leading to the testicle with a material such as small fishing line. This is a necessity in the case of older mature boars no longer needed for breeding purposes.

**F. Internal Parasite (Worm) Treatment and Control**

Worm treatment and control is a necessary practice if we are to produce healthy pigs. This topic is covered on pages 92-96.

**G. External Parasites (Insect) Treatment and Control**

Another factor in producing healthy pigs is insect treatment and control. This topic is covered on pages 98-101.



# Section 5

---

## Health Problems In Pigs

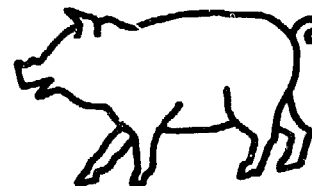
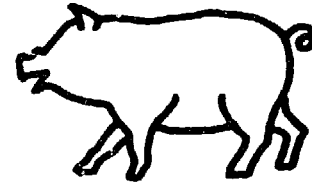
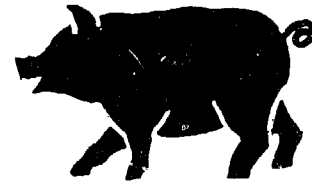
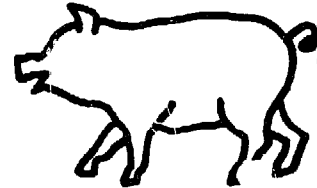
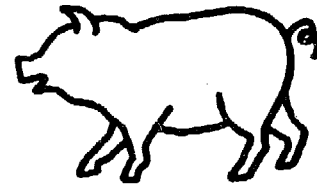
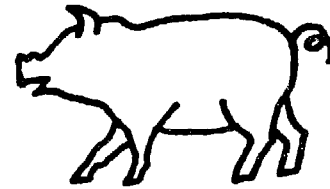
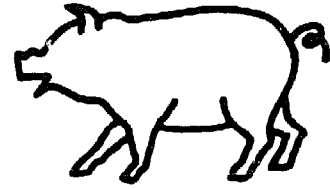

## I. General Considerations in Prevention of Health Problems In Pigs

Health problems are costly to the farmer by way of reproductive problems, poor baby pig survival, stunting and death. Very often stunted, slow growing animals are a major economic problem because they continue to eat but take a long time to reach market or slaughter weight, and some never reach that point.

Veterinarians are often not available for assistance and medications to treat sick animals, even if available, are often very costly. Sick animals that are treated successfully and recover usually are stunted and often take longer to reach slaughter weight.

For those and many other reasons the farmer should try to prevent health problems if at all possible.

This booklet will concentrate on an understanding of the potential problems and ways to prevent them. A detailed description of all possible diseases is beyond the scope of this booklet; however, a few of those that deserve particular attention are discussed.

A. **Sanitation**, or cleanliness, is the first rule in profitable livestock farming. The commonly held idea that pigs are naturally dirty and prefer muddy wallow holes, dirty pens, stagnant drinking water and swampy pastures is wrong. In fact, that belief has led to many unnecessary and serious health problems in pigs.

We must realize that wherever there is fecal material (animal waste-manure) there are almost always germs and worm eggs.

We must also realize that germs and worm eggs survive well where there is moisture and a lack of sunlight. This means that anything we can do in the way of a good sanitation program will go a long way toward preventing many health problems.

The following are suggestions for **Basic Sanitation**.

1. Locate pens and pastures on **highest, well drained land**.
2. **Rotate** pens and pastures often, leave them unused and allow germs and worm eggs to decrease. **Nursing sows and baby pigs should be placed on cleanest land** (longest without pigs on it).
3. **Food and water** should be placed in troughs or containers. Otherwise, pigs may ingest germs and worm eggs from soil as they obtain food and water.
4. Buildings should be cleaned often with soap and water and soiled bedding material replaced. As the buildings are emptied they should also be cleaned well. (**See later notes on Disinfectants**).

Temporary (moveable) building should be moved often. This is a great help in reducing the number of germs and worm eggs that pigs are exposed to. **We simply move the buildings and leave the filth.**

Since buildings with floors are so hard to adequately clean and disinfect, they should only be used under certain conditions such as in areas with extreme cold weather. See earlier notes in Environment Section.

**Disinfectants** (Germ killing chemicals) for use around pig facilities:

**Commonly available products:**

1. **Lye** — sodium hydroxide. Mix one pound in 10 gallons of water; it kills most germs, but is dangerous to use if precautions are not taken. Because it can cause skin burns and serious problems to eyes and internally, it should be used with care. Use rubber gloves and boots, if possible.

2. **Household Chlorine Bleach** diluted according to directions the bottle is also a satisfactory germ killer. **Also use with care.**

There are also **many** commercial disinfectants available; however, they are costly and in most primitive situations their use is not practical. In other cases the sanitation measures previously outlined are usually satisfactory.

**Note:** If feed or water containers have been disinfected, they should be rinsed well prior to being used again.

B. **Nutrition:** This was well covered in the **Section on Nutrition.** However, one cannot overemphasize the importance of adequate amounts and a well balanced ration in maintaining good health and resistance to infection.

**Weather Stress:** Protection from extremes of hot and cold weather, whether by natural or artificial means, is very important in maintaining good health and resistance to infection. Weather stress can lower resistance and lead to serious problems. **Refer to earlier Notes in The Environment Section.**

D. **Vaccinate,** if possible, for diseases that are a problem in the area. Consult with University Agricultural Staff or Government Veterinarians or others knowledgeable on animal health in your area. Often they can help locate a source of vaccine and demonstrate their use. **There are also General Notes in the Disease Section later.**

E. **Treat for Parasites** — While this will be covered in detail in the **Section on Parasites,** it is well to emphasize the importance of parasite control in maintaining health and resistance to infection. **Parasite (worm and insect) prevention, control and treatment are major factors in good health.**

## II. **Understanding The Normal Healthy Pig and Recognizing Signs of Health Problems (Symptoms)**

The more that we know about the basic nature of the pig, the more likely we are to raise healthy pigs.

**If we are to recognize the sick pig we must first know how the normal healthy pig acts.**

Pigs should be observed more as a group than as individuals because most diseases and other conditions generally affect several animals. They should be observed while quiet, rather than when we are working with them and moving them.

A. **Disposition** — The normal pig is a very curious, alert animal that will constantly be poking around and interested in observing any approach to the pen by people or other animals.

The sick pig will appear dull and listless with a lack of curiosity. Often he is reluctant to get up and move around even if forced to and may be weak and uncoordinated.

B. **Appetite** — Lack of appetite is one of the earliest and most consistently recognizable signs of sickness. It is often a sign of fever from infection, and disease.

C. **The recent bowel movement** (fecal material) is also a good indication of a health problem. A hard consistence often means fever. Loose consistency (diarrhea) usually means an intestinal problem and most often an infection. It is also often caused by **intestinal worms**. At times it may be caused by **nutritional** problems such as sudden changes in the diet. Various poisons may also cause diarrhea.

D. **Normal Respiration** (breathing) is a smooth in and out movement by the muscles of the rib area. Any interruption of that smooth pattern such as a jerky movement, coughing, or sneezing is an indication of a possible respiratory problem. The normal respiratory rate (breaths per minute) in the pig ranges from **10-18 per minute**. A rate in excess of that usually indicates a problem.

**Bronchitis** is a mild respiratory problem usually indicated by a faster than normal respiratory rate and a slight change in breathing patterns. A slight cough also is common and sneezing may be seen. It is a symptom of a mild lung problem.

**Pneumonia** is a more severe respiratory problem as evidenced by a very noticeable interruption in the breathing pattern and a much faster respiratory rate and often there is a harsh cough. It is a symptom of a severe lung problem.

**Discharges from the nose and eyes** are also recognizable signs of respiratory problems and often occur at the same time.

Respiratory problems have **many causes**. The most likely is chilling and overheating. Lungworms often damage lung tissue and allow germs to cause an infection. Pneumonia and bronchitis often follow a high fever from other infections. Generally unhealthy pigs from parasitism and nutritional problems often develop respiratory problems.

E. **Normal Temperatures** in the pig is 102-103 ° F. When environmental temperature is very high the normal pig's temperature may

be as much as 103.5° F.

**Fever** is a higher than normal body temperature. It is usually the response of the body to an infection and is a sign that the body defenses are responding to that infection. Under normal environmental conditions a body temperature over 103.5° F. is considered to be a sign of fever. During very hot weather a body temperature over 104° F. is considered to be a sign of fever. **Body temperature in the pig is checked by using a rectal thermometer held in the rectum for at least 3 minutes.** The animal has to be very tightly restrained during this procedure.

Checking the body temperature is a simple procedure that should be used often when we have sick pigs. It is a fairly reliable indicator of whether or not we are dealing with infection-disease.

F. **Color of the mucous membranes** (lining of mouth and nose and inner eyelid) are often a good indication of health problems. The normal healthy color is reddish-pink. A pale to white, bleached out color indicates anemia (lack of blood). Baby pig anemia was previously discussed in the Baby Pig and Reproduction Section.

There are many causes of anemia, especially parasites and nutrition. Icterus (jaundice) — an orange to yellow color may be seen. It is an indication of a number of conditions: infections, blood parasites and poisons that destroy blood cells.

G. **Problems with Locomotion** (movement) show up in several ways:

**Arthritis** — sore, stiff, swollen joints and a reluctance to get up and move around — usually caused by mineral deficiencies, also infections, diseases as Erysipelas and injuries.

**Foot Problems** — sore, swollen feet and a reluctance to place weight on affected limb — usually caused by injuries, infection and diseases such as Foot and Mouth Disease.

**"Downer" animals** — (animals completely unable to get up) — This is usually seen in pregnant and nursing sows and most often is caused by a mineral deficiency. It may also be caused by a severe back injury.

**Weakness and Uncoordination** — are usually secondary to other serious conditions such as infection, disease, poisoning, etc.

### III. **Major Categories of Health Problems and Their More Probable Causes:**

A. **Reproductive Problems** as evidenced by poor conception, and late abortion, weak and stillborn pigs and small number of live healthy pigs farrowed.

**Causes:** 1. **General Poor Health** Boar and Females

a. **Nutritional** problems such as a poorly balanced

- ration and deficiencies of necessary nutrients.
- b. **Parasites** — failure to prevent and treat.
  - c. **Chronic Diseases** such as non-fatal pneumonia and diarrhea.
2. **Stress of high environmental temperatures** on Boar and females.
  3. **High Fever** in Boars and Females from infection and major diseases.
  4. **Reproductive Diseases** such as Brucellosis and Leptospirosis and others.
  5. Boars or females too young at breeding time and mating (breeding) boars too often in a short period of time.
  6. **Injuries** to pregnant females.
  7. **Failure** to assist at farrowing time.
- B. **Poor Baby Pig Survival** — as evidenced by deaths and severe stunting in baby pigs.
- Causes:**
1. **Poor Milking in Sows** — one of major causes.
    - a. **Nutritional Problems** — prior to farrowing while nursing pigs. (**See Notes on Nutrition of Pregnant and Nursing Sows**). **This is the cause.**
    - b. **Fever** in the sow usually causes milking problems.
    - c. **Udder infection** causes milking problems and milk may make pigs sick.
    - d. **Heat stress** on the sow as in poorly ventilated buildings and anytime the sow is not given protection from high environmental temperature will probably cause milking problems.
  2. **Scours** (Diarrhea — (Loose bowel movement) — another major cause.
    - a. **Poor sanitation** in the farrowing area often leads to infections and is a major cause of scours.
    - b. **Milking Problems** in the sow often cause scours.
    - c. **Chilling** results in loss of resistance to infection.
    - d. **Baby Pig Anemia.**
    - e. **Internal parasites** — worms.
  3. **Intestinal Diseases** — Bacterial and Viral infections such as Salmonellosis, TGE, and others.

4. **Pneumonia** — respiratory problems caused by most of the same causative factors of scours, especially chilling.
5. **Major Diseases** — Hog Cholera, Erysipelas, Foot and Mouth Disease and others which cause high death losses in all ages.
6. **Failure to provide solid food** to supplement the **sow's milk. This can contribute** to slowed growth and less resistance to infection. It also adds to the stress of weaning.
7. **Weaning Stress** is often a major cause of health problems. It was well covered in the **Baby Pig**

### **Section with Reproduction.**

C. **Stunting** — slowed growth in the growing - fattening animal after weaning. It may be a minor problem where the animal takes longer to reach slaughter weight or such a severe problem that animals will never reach that point. **It is one of the most common and serious economic problems to a swine farmer.**

**Causes:** 1. **Nutrition** — The major cause in most cases. It may from a lack of food in general but most often is caused by a **lack of protein in the diet.**

2. **Parasites** — internal parasites (worms) are the other major cause of stunting in most cases. This be covered in detail in **The Parasite Section.**
3. **Continuation of Any Baby Pig Problems** that weakened but did not kill. Often the lung damage from pneumonia, intestinal damage from worms and scours and liver damage from worms causes long term effects leading to stunting.
4. **Non-Fatal Diseases and Infections** such as Pneumonia and Diarrhea that cause long term effects in survivors.
5. **Environmental Stress** such as extremely hot or cold weather with poor protection.
6. **Non-Fatal Poisoning.**

D. **Major Death Losses** in animals after weaning.

**Causes: Major Infectious Diseases** such as Hog Cholera, Erysipelas, Foot and Mouth Disease and African Swine Fever.

2. **Common Infections** such as Pneumonia and Diarrhea in animals not adequately treated for these common problems. Inadequate nutrition, and parasites often are the cause of the already weak animals.

3. **Poisoning** — There are many potential causes of poisoning in swine and while not a common problem it is serious when it does occur. Treating poison cases is expensive and results are usually poor.

#### IV. **Internal Parasites and Their Role in Health Problems of Pigs.**

Internal Parasites (worms) and External Parasites (insects) are a major cause of health problems in pigs. Because they are so serious we need to have a good background knowledge of these parasites, the problems that they cause and how to prevent them and treat animals for them.

A. **Getting to Know the Worms** — Pigs are parasitized by many species of worms. Their ordinary living conditions, low wet unsanitary areas and rooting in soil, favor survival and spread of worms. All the species of worms that infest pigs are major or contributing factors to stunting, poor utilization of foodstuffs, lowered resistance to disease and general poor health. They come in various sizes from the thread-line strongyloides to the pencil size ascaris. They are located in:

1. The **stomach and intestine:**

**Ascaris** — Large roundworm.

**Oesophagostomum** — Nodular worm.

**Strongyloides** — Threadworm.

**Trichuris** — Whipworm.

**Hyostrogylus** — Red stomach worm.

**Ascarops** — Thick stomach worm.

**Macracanthorhynchus** — Thorny Head Worm

**Spiruroids** — several species, (Ascarops, Physocephalus, Gongylonema) of small stomach and intestinal worms that migrate through the liver and cause intestinal irritation and stunting.

There are other stomach and intestinal worms in various parts of the world that parasitize pigs but they are usually similar to the ones being discussed.

2. Three species of **Lungworms** infest swine: two species of **Metastrongylus** and one species of **Choerostrogylus**.
3. In the kidney area, **Stephanurus**, the **kidney worm** of swine, is often a serious problem. They also cause severe liver damage.
4. **Flukes:** Any type of flatworm are common in



many parts of the world, usually low wet swampy areas.

**Fasciola** — common liver fluke

**Paragonimus** — liver fluke

5. **Tapeworms and Trichina** are under some circumstances **a possible danger to humans** and will be discussed separately.

B. **The effect of worms on a pig's health** depends on the species of worm and its location in the body.

**Stomach and Intestinal Worms** cause irritation to the lining of these areas and lead to digestive upsets, diarrhea, poor food utilization and stunting. Some species of these cause damage to the liver and lungs by immature stages migrating through the body. All of these effects are very serious in the baby pig.

**Lungworms** develop in the small air passages of the lungs and set up an irritation which interferes with normal lung function and causes severe stunting. This irritation also often leads to bronchitis and pneumonia.

**Kidney Worms** in their immature stages migrate through the liver and cause severe damage. They then migrate to the kidney area and cause severe irritation. Since the liver and kidney are such important organs, this irritation causes the animal to be stunted and unthrifty.

**Liver Flukes** cause damage to the liver by irritation and blocking bile passages. Liver damage leads to stunting and general unthriftiness and poor resistance to disease.

**Lung Flukes** cause irritation to the lungs and secondary effects similar to lungworms.

### C. **Life Cycle of the Worms**

All of these worms pass part of their life cycle **outside the pig's body. Knowing this is the key to prevention and control,** we try to interrupt the life cycle and prevent spread from an infested animal to a healthy animal.

All of these worms have adults in the body who lay microscopic eggs that are eventually passed out of the body in fecal waste (stomach and intestinal worms), coughed up, swallowed and passed in the fecal waste (lung worms and lung flukes) and through the urine (kidney worms).

The next animal becomes infested by taking in these eggs in food or water contaminated with manure or urine from an infested animal. This is true of all worms except lungworms whose intermediate stage is in the earthworm and flukes whose intermediate stage is in snails and crayfish.

Ascaris and Strongyloides may also infest the unborn pig.

Eggs of strongyloides and kidney worms may hatch in very wet soil and the immature stages penetrate through the skin into the body.

#### D. Prevention and Control of Worms in Pigs

This is based on our knowledge of the life cycle of these worms and the fact that they all pass part of their life cycle outside the pig. It is also based on our knowledge that food and water contaminated with fecal material and urine are the primary method of spread.

1. **Good Basic Sanitation** — as previously discussed in detail.
2. **Pasture and Pen Rotation** where pigs are often moved from one area to another to allow the eggs in the soil to decrease. This is especially true when low, wet swampy areas are used for pigs.
3. **Separate Newborn Pigs and Their Mothers** away from other pigs to decrease chances of becoming infested at an early age.
4. **Farrow Sows and Keep Baby Pigs on Cleanest and least used land.** This is a major consideration. Worms cause their most serious damage to the youngest pigs and the longer we can prevent or minimize infestation the better chance the pig has of remaining healthy.
5. **As much as is practical, keep pigs away from low, wet, swampy areas** where worm eggs survive so well. This also lessens the chances of eggs hatching and immature stages penetrating the skin. This is also the area where earthworms, snails and crayfish, which are intermediate hosts of lungworm and flukes, are usually found. **If low, wet land must be used for pigs, move them often to areas not recently used.**
6. Provide fresh water in clean troughs or other containers. This lessens the chances of contamination with fecal material and urine.
7. Feed grain, ground food, garbage and all others possible in **clean troughs** or other **containers.**
8. **Worm Treatment Medication:** This lessens the number of adult worms who can lay eggs and lessens the chances of contaminating the food and water. **It is also one of the most necessary practices in raising healthy pigs.**
9. Prevent pigs from access to human and dog fecal waste to lessen chances of becoming parasitized by tapeworms and trichina. Also cook garbage well always.

#### E. Medication — Worm Treatments

There are a number of medications. Some of these are effective against many species of worms (Broad Spectrum Wormers) and others only available against one or two species. Generally the Broad Spectrum wormers should be used if available. Conditions that favor

one species of worm often are satisfactory for others and most often pigs are infested with several species.

In some areas the farmer may have a choice of several worm medications. In other areas the choice may be limited and in some areas he may have to improvise by using products more suitable to cattle, sheep or chickens. For that reason a large number of products are listed and also the fact that worm treatment is almost a necessity in raising healthy pigs.

Dosages are not given because these medications come in differing forms and strengths. **ALWAYS FOLLOW DIRECTIONS ON THE CONTAINER FOR PROPER USE.** Chemical names are given first, then brand name and manufacturer in parenthesis. These may vary in different areas of the world.

1. **Broad Spectrum Wormers** — Most often used if available

a. **Fenbendazole** ("Panacur"-Hoechst AG) is effective against a number of stomach and intestinal worms and kidney worms.

b. **Levamisole** ("Tramisol," "Levasole"-Ripercol, American Cyanamid Co.) is effective against most stomach and intestinal worms and its effectiveness against lungworms makes it very desirable. It also has an effect on kidney worms.

c. **Dichlorvos** ("Atgard"-Shell) is effective against most stomach and intestinal worms and is one of the few effective against whipworms which can cause severe diarrhea.

d. **Febantel** ("Rintal"-Bayer) is effective against a number of stomach and intestinal worms. If fed in feed over a long time it is effective against lungworms and whipworms.

e. **Citarin-L, Concurat-L** (Bayer) is effective against a number of stomach and intestinal worms as well as lungworms and whipworms.

2. **Other Commonly Used Pig Wormers**

a. **Piperazine** is effective against two of the most common intestinal worms, *Ascaris* and *Oesophagostomum*. Poultry farms often use this product and they might help you locate it. Use it if one of the Broad Spectrum Group is not available.

b. **TBZ** — (Thibenzole-Omnizole-Merck) for use in baby pigs at one week of age with a serious worm problem. Cattle and sheep farms use this. It can be used in older animals if no others are available.

c. **Pyrantel** (Banminth-Pfizer) is effective against *Ascaris* *Oesophagostomum*. It is often used if Broad Spectrum products are not available.

d. **Phenothiazine** is a cattle and sheep product that has been used in pigs. **It often makes pigs sick** and should not be used if others are available. Also, it is only effective against the two most common intestinal worms. **Do not use in pregnant sows.**

e. There may be other satisfactory products available in certain parts of the world. **Always follow directions closely.**

f. **Neguvon** (Bayer) is an animal medical product sometimes used in pigs, but **not** recommended. Dosage is critical, especially in young pigs. It should **not** be used if others can be found. The experience of others using it might be helpful.

#### F. **Treatment Schedules**

1. **Normal Circumstances** — no major stunting

a. Pregnant Sows — 1-2 weeks before farrowing with a drug **approved** for this — do not use a drug not approved for pregnant sows.

b. Pigs a few days after weaning — **ABSOLUTE**

c. Repeat 3 weeks later in pigs.

2. **Severe Stunting problems** — slowed growth

a. TBZ or Rintal in baby pigs one week old.

b. Broad Spectrum wormer at 5-6 weeks old.

c. Repeat in 3 weeks — after weaning.

d. Sows 1-2 weeks before farrowing with an approved drug.

Also in sows after weaning, before rebreeding.

However, worm treatment in herds with severe problems is very costly. Prevention and control measures as already discussed should be followed to reduce the need for heavy medication.

#### B. **Drug Forms and Notes on Use of Worm Medicines**

1. **For a few pigs**

a. Powder or crushed tablets in small amount of feed.

b. **Tablets** are difficult to administer to pigs, especially older animals.

c. **Drenches** — often used, but care is needed to prevent strangulation.

d. **Skin Pour-On** preparations work well, but are not usually available.

2. **Water Medication** mixed in drinking water is mostly used for large groups. **Access to any other water has to be prevented.**

3. **Injections** work well, but experience is needed. Syringes and needles are costly and must be sterilized. This means they are rarely used in small operations.

#### H. **Worm Treatment Drugs Approved For Pregnant Sows**

1. Dichlorvos (Atgard)

2. Levamisole (Tramisol)

3. Citarin L, (Concurat)

4. Rintal

5. TBA (Thibenzole-Omnizole) only if no others are available and problems are severe.

I. **Flukes** — are unusual flat, leaf shaped worms that parasitize many animals. In pigs, several species of lung and liver flukes infest pigs. Lung flukes cause damage similar to lung worms that leads to bronchitis, pneumonia and severe stunting. Liver flukes damage the liver and also cause stunting.

Flukes in pigs are usually found only where animals have access to low, wet, swampy areas. This is because intermediate stages outside the pig require crayfish or snails as part of the life cycle. Since snails and crayfish are found in low, swampy areas the obvious control and prevention is to limit access by pigs to those areas.

There are no practical and safe way to treat pigs infested with flukes.

#### J. Worms in Pigs That May Affect Humans

1. **Tapeworms** — The **pork tapeworm, Taenia solium** affects swine in the intermediate stage while the adult stage is in humans. The intermediate stage in swine is a small blister appearing lesion in various organs and muscles. Humans are infested by eating raw or slightly cooked pork products. In the human the intermediate stage develops into a full grown tapeworm that causes health problems in humans. Segments from the adult worm pass in human feces.

Pigs become infected when they have access to human fecal waste by rooting in soil or when their food and water are contaminated.

Control and prevention are by limiting access of pigs to human feces by good sanitary practices by humans and by cooking all pork well done for human consumption.

The **Hydatid Tapeworm**, Echinococcus granulosus, is a tapeworm that infests pigs in the intermediate stage and dogs in the adult stage. Occasionally humans become infested by eating raw or improperly cooked pork. Control includes preventing **dogs from straying through hog pens and pastures** and preventing dogs from eating raw pork products. The practice of giving dogs **raw pork scraps at butchering** time should not be allowed.

2. **Trichina (Trichinella spiralis)** is the worm parasite of pigs most often thought of as causing a problem in humans. The Trichina are microscopic worms in the muscle meat of pigs. Humans become infested when they **eat raw or improperly cooked pork**. Dogs and other meat eating animals also become infested by eating dead pigs or pork scraps. Control and prevention in pigs and later problems in humans is done by cooking garbage and preventing pigs from access to human and dog feces. Dead pigs should be buried or burned.

Always cook all pork products well done if used by humans.

This is the worm parasite in pigs which has caused most of the reluctance to human consumption of pork. By following the few suggestions outlined previously, pork should be completely safe for humans.

## V. External Parasites (Insects) That Affect Pigs

A. **External parasites** of pigs include those parasites that live on the outside of the pig and usually on or in the skin. Some of these, lice and ticks, are easily seen but mange mites are microscopic and their presence is noted by a severe skin irritation. They cause problems by skin irritation, often severe, that may lead to skin infection as germs enter the broken skin. They also may spread germs from animal to animal and carry a malarial type blood parasite. Ticks and lice are blood suckers and contribute to anemia problems. All contribute to stunting and poor health.

1. **Lice** (*Hematopinus suis*) is the most often noticed insect problem of pigs. They are usually found around the head, neck and between the legs. The adults are 1/8 to 1/4 inch long, greyish-black in color and easily seen on white pigs, but less easily seen on black pigs. Pigs with lice are often restless, and **scratch** a lot and skin may be irritated. Affected pigs are usually unthrifty.

The adults lay eggs on the same pigs and the life cycle repeated as eggs hatch and immature stages grown to maturity. They may move to another pig as they lie side by side or when a pig scratches them off on a pole or wall and they later get on another pig.

Treatment involves use of sprays, dips, dusts or pour-on insecticidal chemicals approved for use on pigs. Treatment should be repeated in 2-3 weeks. **This is one of the most often required management practices in raising healthy pigs. A Table of Insecticides approved for pigs follows at the end of this Section.**

2. **Mange** is the common name for a skin infection caused by mites of two species. **Sarcoptes** and **Demodectes**. They are too small to be seen without magnification. They burrow into the skin, most often around the head, neck and shoulders and cause a severe irritation. It is first seen as a reddening of the skin, later severe and followed by scabs. They are first seen around the ears and later over the face, neck and other parts of the body. The severe irritation and scratching caused by the mites is usually followed by skin infection and a stunted unhealthy pig.

Mange mites live their entire life on the pig and the life cycle is repeated in the skin. They may spread to other pigs by direct contact or when scratched off on a post or wall and later get on other pigs.

Treatment is difficult because the mites are in the skin. Spraying or dipping is necessary and must be repeated in 10-15 days. **Insecticides**

**that kill mange mites and are approved for pigs are listed at the end of this Section.**

3. **Ticks** of several species affect swine. Ticks commonly found on cattle, sheep, dogs and wild animals may affect swine. Ticks do not spend their entire life cycle on an animal. At various stages of their life cycle they drop off on bushes and small trees and later attach to another animal. This makes them important in the spread of diseases. They also are blood suckers and cause skin irritation.

Treatment for ticks is by using **Toxaphene, Sebacil or Bacdip or Lindane** dip or spray as listed in the following Section on Insecticides.

**B. Insecticides Approved For Use on Pigs**

1. **Co-Ral** — 25% wettable powder. Mix 1 pound in 50 gallons water for lice.

2. **Co-Ral** — 1% Dust. 1 ounce per animal for lice.

3. **Ciodrin** — 13.1% Emulsifiable concentrate — 3-1/3 pints to 50 gallons water for lice.

4. **Korlan** 5% Granules. Apply 1/2 pound to 100 sq. feet of bedding for lice.

5. **Korlan 24E** — Mix 2 quarts in 50 gallons water for lice.

**Can be used on baby pigs.**

6. **Lindane** — 20% Emulsifiable Concentrate. Mix 1 pint in 50 gallons water for mange, lice and some effect on ticks. **Do not use on baby pigs less than 30 days old.** Wait 30 days until slaughter after use.

7. **Lindane** — 12.4%. Mix 1-1/2 pints in 50 gallons of water. For mange, lice, and some effect on ticks. **Do not use in baby pigs less than 30 days old.** Wait 30 days until slaughter after use. Lindane is generally available; it has many uses.

8. **Malathion** — 4-5% Dust. Apply 1/4 to 1/2 tablespoonful per animal. It is good for lice and fair for mange. It **can be used on baby pigs.** This product has many uses and is generally available.

9. **Malathion** — 57% Emulsifiable Concentrate. Mix 2 quarts in 50 gallons water for mange and lice.

10. **Sevin** (carbaryl) 5% dust is a very safe and generally available product that is used for lice in pigs. Do not use on baby pigs less than 30 days of age.

11. **Methoxychlor** — 24% Emulsifiable Concentrate. Mix 1 gallon in 50 gallons of water for lice.

12. **Rabon** — 3% Dust. Use 3-4 ounces per animal.

13. **Toxaphene** — 60% Emulsifiable Concentrate. Mix 3 pints in 50 gallons of water. Effective for mange and lice. **Effective for Ticks.**

14. **Bacdip (Bayer)** — **spray, dip and paint on for all external parasites of pigs, especially ticks.**

15. **Sebacil** (Bayer) — spray on pigs for lice and ticks.
16. **Odylen** (Bayer) — pour on, paint on for mange and lice.
17. **Neguvon** (Trichlorfon — Bayer) — pour on for external parasites in pigs.
18. **Tiguvon** (Fenthion-Bayer) — pour on for lice in swine. **Okay for use on pregnant and nursing sows.** Wait 14 days until slaughter.
19. **Used Motor Oil** — an old home remedy, is effective against lice in swine. It should be used in small amounts poured or painted on the shoulders and neck behind the ears. **This is somewhat risky because oil may contain harmful chemicals. It should be used as a last resort only and when no others are available.**
20. There may well be other insecticides approved for swine that are available in your area. **Follow Directions Closely.**

### C. Notes on Use of Insecticides in Pigs

1. **Insecticides are potentially dangerous drugs much more so than other drugs used in animals. Always follow directions closely, especially mixing and dilution.**

Be especially careful when using insecticides **on sows** just **prior to farrowing** and while **nursing** their baby pigs. Pigs may ingest insecticide as they nurse and serious problems may result. Also, use with care **on baby pigs**. Lice are usually the only insect problem before 5 weeks of age. Mild dusts such as 4-5 % Malathion are safest. Use others **only if label contains directions for baby pigs.**

## VI. Diseases of Swine

It is not within the scope of this booklet nor would it serve a real purpose to go into great detail on all the diseases of swine. Earlier parts of this section on Health Problems which describe more common problems are more useful in most circumstances.

Also, diagnosis of most major diseases is difficult even for experienced veterinarians with laboratory assistance. Treatment is expensive, drugs are often hard to find and results often are poor with resulting death losses and stunting in survivors.

**Prevention of Health Problems Through previously mentioned guidelines should be our goal.**

A. **Hog Cholera** (Swine Fever) is a highly contagious and highly fatal disease of pigs caused by a virus. It is generally considered the worst disease of swine in the world. Though eradicated in some countries it is still a very serious problem in many areas.

Affected animals are first noticed by their lack of appetite which



is caused by the high fever. Soon after this they become weak and depressed. Many develop diarrhea and death follows in a high percentage of affected animals. Recovered animals are often weak and unthrifty.

This disease spread rapidly through an area where many farms have pigs. Keeping animals closely confined to prevent contact with other pigs is a good idea. Also, keep pigs away from streams because the virus may travel from farms with sick pigs.

If the disease is known to be in an area and cases are frequent it would be advisable to vaccinate if possible for it.

If it has not been diagnosed, but sickness that is suspicious of it does occur, try to get help in diagnosing it. In most countries, government or university veterinarians are available for help in disease outbreaks and they should be advised of suspicious cases in an area.

B. **African Swine Fever** is a very serious disease of pigs which in many respects is similar to hog cholera. Laboratory tests are needed to differentiate between the two diseases.

Until the past 10-15 years this disease only occurred in the continent of Africa. However, it is now widespread with outbreaks in parts of Europe, South America and the Caribbean.

Other information on Hog Cholera applies here. Suspicious cases should be reported to government veterinary authorities.

C. **Foot and Mouth Disease** (Aftosa) is a very serious disease in pigs as well as other livestock. It is also very contagious and rapidly spreads through an area. The fact that other livestock are involved allows it to spread through an area more easily.

The disease is usually not hard to diagnose. The combination of vesicles (hard thick blisters) inside and outside the mouth, snout, feet and udders is very likely to attract attention. These lesions later become red and raw as vesicles rupture.

Animals become very lame and are reluctant to eat because of the sore mouth.

Death losses are usually not great but the stunting and general poor health in survivors causes great economic loss to the farmer.

Vaccines are available and should be used if possible in areas with frequent outbreaks.

Suspicious cases should be reported to government veterinary authorities.

D. **Erysipelas** — is a bacterial disease of pigs which occurs worldwide. It is considered one of the major diseases of swine, but it is not as contagious in its spread through an area as the previous viral diseases.

It occurs in two forms. One is a highly fatal condition which results in deaths in 24-72 hours in affected pigs. Pigs develop a very high fever, sore swollen joints, are reluctant to move, but usually remain

alert until near death.

The other form manifests itself by a chronic arthritis or raised reddish diamond shaped areas of skin. Stunting is the problem associated with this form of Erysipelas.

Vaccines are available and should be used, if possible, on farms with previous problems. It often recurs on the same farm.

E. **Brucellosis** (Bangs Disease) (Infectious Abortion) is a major reproductive disease of pigs and occurs worldwide. It is caused by a bacteria that affects the reproductive organs of adult males and females.

It causes poor conception, early and late abortions, weak and still-born pigs and small litters. However, animals are not noticeably sick. It is usually brought into a herd by infected breeding stock who in turn infect others. An infected male may spread it to sows and from an infected sow to others. Often laboratories are not closeby but if possible, newly purchased animals should be blood tested prior to purchase.

Sharing boars is often a necessity, but this may spread the disease.

It also spreads within a herd when sows have an abortion and at farrowing time.

F. **Leptospirosis** — is another reproductive disease caused by bacteria and is worldwide. It causes a widerange of reproductive problems similar to Brucellosis. Animals are rarely visibly sick.

Strains of this bacteria are found in other livestock, wild animals, dogs and rats. All of these may cause problems in pigs. This makes it difficult to control.

The organism is found in the kidney and passes from the body in urine and may be spread to other animals as urine contaminates drinking water. This is especially true of animals drinking from ponds or small streams. As with Brucellosis, blood tests are available. There are very effective vaccines available to prevent this disease.

G. **Pox (Pig Pox)** is a disease of pigs found worldwide and caused by a virus. It is noticed as clean blisters on the skin most often between the legs and under the abdomen. Blisters turn into dark raised areas that disappear within a week to 10 days. The condition is most often seen in pigs under 3 months old.

Deaths are rare. However, the virus does lower resistance and common pneumonia and diarrhea may follow.

# Section 6

---

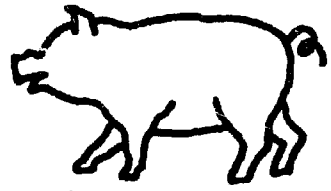
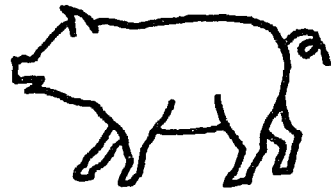
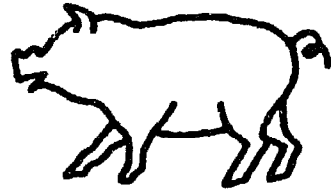
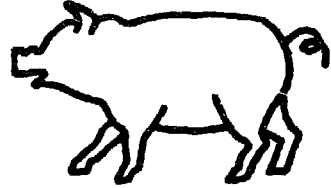

Since this booklet cannot cover all possible aspects of health and production practices in primitive pig raising, Christian Veterinary Missions is providing in this section a method whereby you may obtain additional information on pig problems in your area.

The following is a general outline of information needed.

1. **Farm Location**

1. Country
2. Area of Country — State or Province
3. Distance and direction from nearest large city

2. **Climate By Season**

Ex. — Winter, December-February, Cool with heavy rains daily  
Rest of year — hot and dry

Give seasonal extreme temperatures and amounts of rain, if possible.

3. **Description of Area** where farm is located

- Ex. — High mountain plateau, sparsely populated.  
Ex. -- Small farms, densely populated area near large city.  
Ex. — Rangeland with low swampy areas near streams.  
Ex. — Tropical island with coconut and sugar cane plantations.

4. **Description of Farm** in great detail

a. **Terrain**

Ex. — Low, uncleared land with small amounts of well drained cropland being farmed.

Ex. — High mountain valley.

b. Total Acres in Farm\_\_\_\_\_.

c. Acres in crops\_\_\_\_\_.

d. List crops grown by season\_\_\_\_\_.

e. Acres used for pigs\_\_\_\_\_.

f. Acres used for other livestock\_\_\_\_\_.

g. Number of pigs on farm —

Baby pigs\_\_\_\_\_.

Growing Animals\_\_\_\_\_.

Adult Females — Sows\_\_\_\_\_.

Adult Males — Boars\_\_\_\_\_.

h. List other livestock and poultry on farm.

i. Describe method of confinement, tethered, fenced, running loose, etc.

j. Describe all buildings and sheds; age and condition.

k. Distance to nearest farm with pigs.

l. Do neighboring pigs run loose?

5. **Management Practices**

- a. Sanitation — good, bad or fair, describe.
- b. Nutrition — in great detail.
  - what foods are fed and to each age group.
  - how much of each is fed.
  - seasonal variation.
  - include minerals and salt.
- c. Drinking Water
  - Source — well, stream, pond
  - How supplied — trough, etc.
- d. How are animals protected from extremely hot and cold weather.
- e. List worm and insect control practices and drugs; what, when, how much, how used.
- f. Vaccines used; what, when, how.
- g. Weaning age.
- h. How many years experience does farmer have in raising pigs.

6. **Describe Sickness in Great Detail**

- a. How long has the problem been observed in the herd  
\_\_\_\_\_?
- b. Does it have a seasonal pattern, describe it.
- c. Are other pigs in area sick?  
Has it been diagnosed?
- d. What ages are affected?
- e. What percent of pigs are affected, by age.
- f. What percent of affected pigs die, by age.
- g. Average number of days from first sickness noticed until death.
- h. Are survivors stunted, mild or severe.
- i. Is reproduction affected? \_\_\_\_\_. Describe.
- j. Is appetite affected? \_\_\_\_\_. Describe.
- k. Body temperature while sick.
- l. Describe all symptoms in great detail.
- m. Describe treatments used and results.

7. **Any Other Observations.** Remember, no detail is too trivial to be of great importance.

Mail to:

Christian Veterinary Mission  
c/o World Concern  
Box 33000  
Seattle, Washington 98133  
USA

# Section 7

---

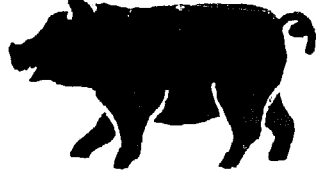
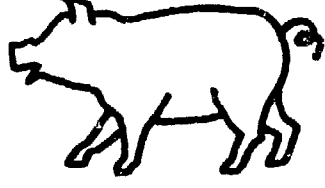
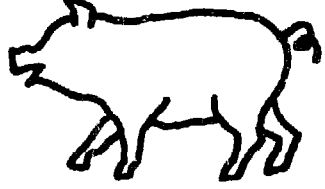
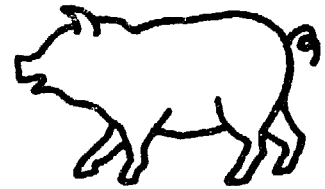
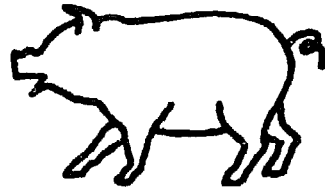

## Acknowledgements

The author has received information from many individuals and sources in preparing this booklet and he is very grateful for their assistance. If anyone or any source has been omitted, it is an oversight and apologies are in order.

### Special Acknowledgements:

1. Mr. Carl Ackerman, Clemson University, Clemson, South Carolina for many helpful tips and for proofreading the final copy.
2. Dr. Joseph H. Conrad, University of Florida for information on Tropical Nutrition.
3. Dr. Roger Henken, University of Kentucky for highly detailed nutritional information.
4. Mr. C.H. McGowan, Tuskegee Institute, Alabama for much helpful information.

### Sources of Information:

1. Agricultural Extension Service of State Universities as follows:
  - A. Auburn University, Alabama
  - B. University of California
  - C. Colorado State University
  - D. University of Florida
  - E. University of Hawaii
  - F. University of Illinois
  - G. Iowa State University
  - H. University of Kentucky
  - I. Mississippi State University
  - J. Montana State College
  - K. North Carolina State University
  - L. University of Nebraska
  - M. North Dakota State University
  - N. Pennsylvania State University

- O. Purdue University, Indiana
- P. Clemson University, South Carolina
- Q. Tuskegee Institute, Alabama
- R. University of Tennessee
- S. Utah State College
- T. Virginia Polytechnic Institute
- U. University of Georgia

2. **United States Department of Agriculture**

3. Farm and Livestock Magazines:
- A. Hog Farm Management
  - B. National Hog Farmer
  - C. Pig America

Special thanks to United Methodist Women of Pine Grove United Methodist Church, Turbeville, South Carolina, for their generous financial assistance in preparing this booklet.