

AT MICROFICHE
REFERENCE
LIBRARY

A project of Volunteers in Asia

How to Grow More Vegetables

by: John Jeavons

Published by:
Ten Speed Press
P.O. Box 7123
Berkeley, CA 94707 USA

Paper copies are \$8.50.

Available from:
Ten Speed Press
P.O. Box 7123
Berkeley, CA 94707 USA

Reproduced by permission of Ecology Action of
the Mid-Peninsula.

Reproduction of this microfiche document in any
form is subject to the same restrictions as those
of the original document.

"... A MASTERPIECE." Alan Chadwick

REVISED
AND
ENLARGED

HOW TO GROW MORE VEGETABLES*

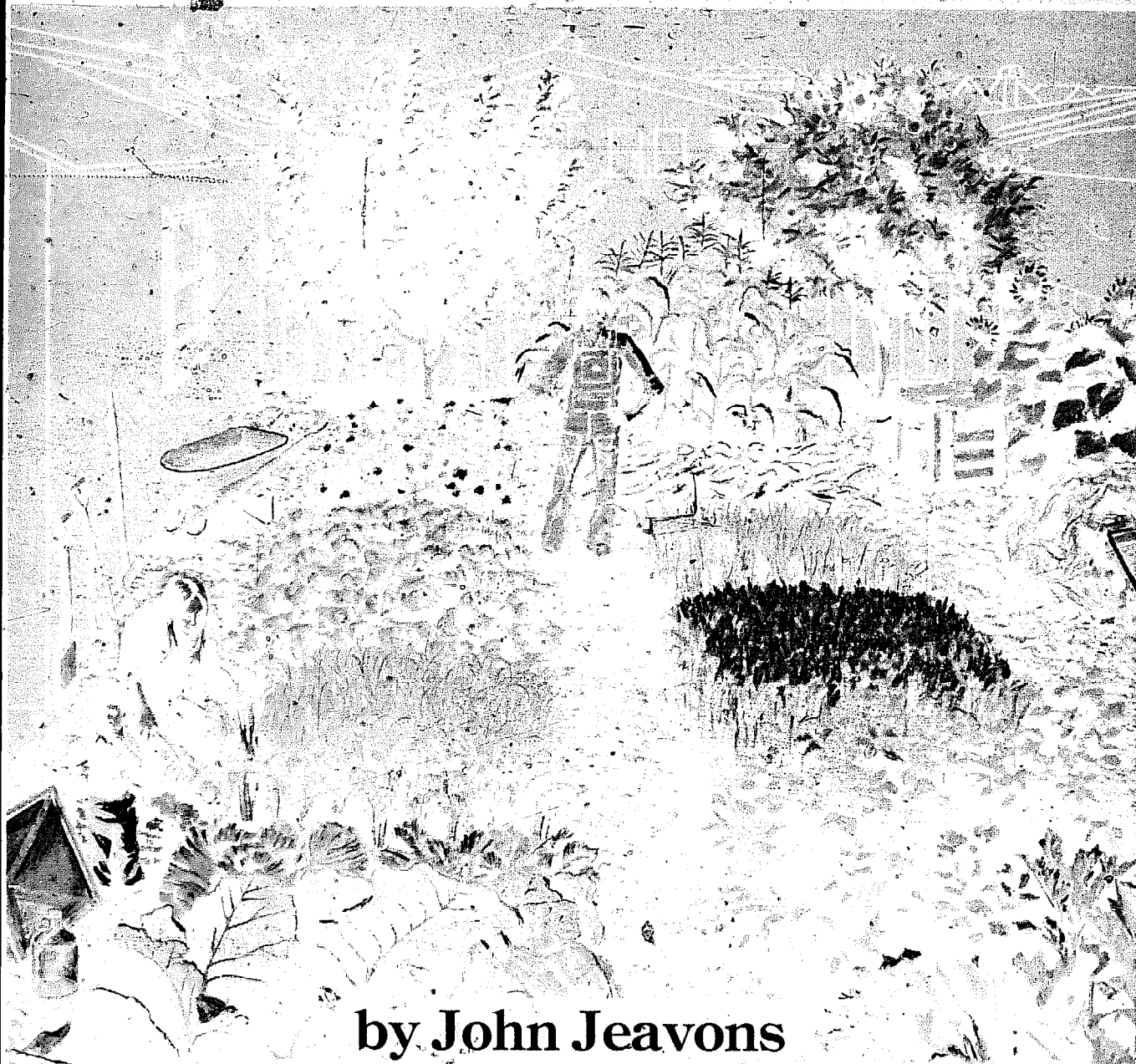

by John Jeavons

... more than you can imagine

"... the best plain-language explanation of Biodynamic/French Intensive gardening techniques we've yet seen." *Mother Earth News*

\$7.95

HOW TO GROW MORE VEGETABLES*

... have been seeking for the way to grow the most food with the least land, water and fertilizer. Here's it.

... could never imagine small producing. Introduces the Biodynamic/French intensive method of gardening. The talk of the air under the table set.

The Fackelmann Post

... Perhaps the best kept secret of the 19th century. If working with the land people say, more productive than machinery. You may see food get more appetizing and easy to digest but it's windowless, or no-light, or no-air. Now it grows in earth in open, postulated. A surprise of the times!

Pilot's Gilman

The 19th Century Chronicle

... ... could grow a year's supply of soil gardening nation

The New York Times

... .. demonstrating that small

The New York Chronicle

... .. could grow a year's supply of soil gardening nation demonstrating that small

ISBN 0-89815-077-6

 Ten Speed Press

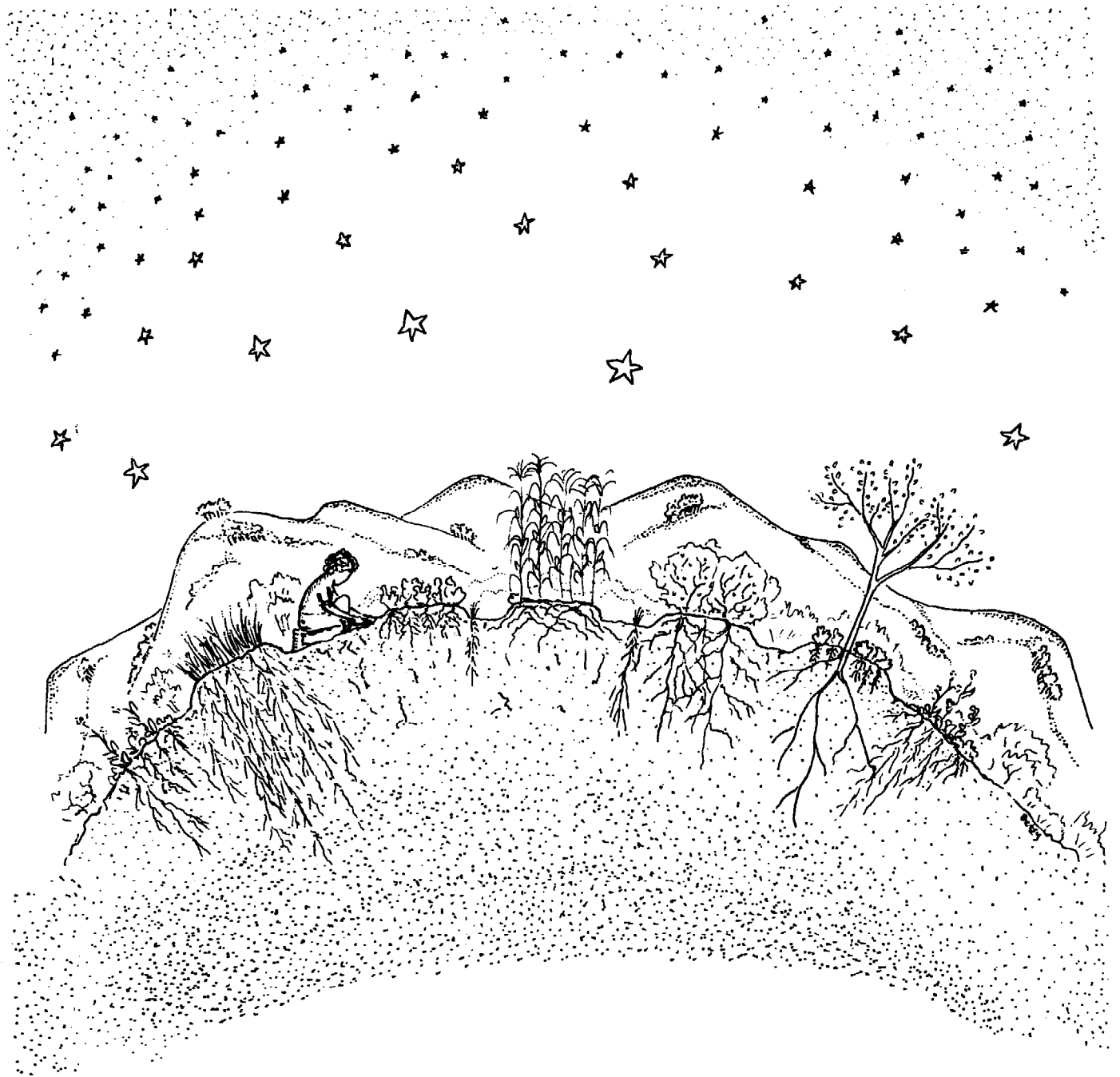

*... for, lo, the eternal and sovereign luminous space,
where rule the unnumbered stars,
is the air we breathe in
and the air we breathe out.
And in the moment betwixt the breathing in
and the breathing out
is hidden all the mysteries
of the Infinite Garden.*

—Essene Gospel of Peace

How to

*A Primer on the Life-Giving
Biodynamic/French Intensive Method
of Organic Horticulture*

*than you ever thought possible

Grow More Vegetables*



by John Jeavons

ECOLOGY ACTION of the MID-PENINSULA

 Ten Speed Press

on less land than you can imagine

Copyright © 1974, 1979, 1982
by Ecology Action of the Mid-Peninsula

Published by



TEN SPEED PRESS
P.O. Box 7123
Berkeley, California 94707

All rights reserved. No part of this book may be reproduced in any form, except for brief reviews, without the written permission of the publisher.

You may order single copies prepaid direct from the publisher for \$7.95 (paperbound) or \$10.95 (clothbound) + \$.50 for postage and handling (California residents add 6% state sales tax; Bay Area residents add 6½%).

Library of Congress Catalog Number:
82-050212
ISBN: 0-89815-073-6 (paperbound)
0-89815-074-4 (clothbound)

Book and Cover Design by Brenton Beck,
Fifth Street Design Associates
Cover and major illustrations by
Pedro J. Gonzalez
Other illustrations by Betsy Jeavons

Printed in the United States of America

10 9 8 7 6 5 4 3 2 1

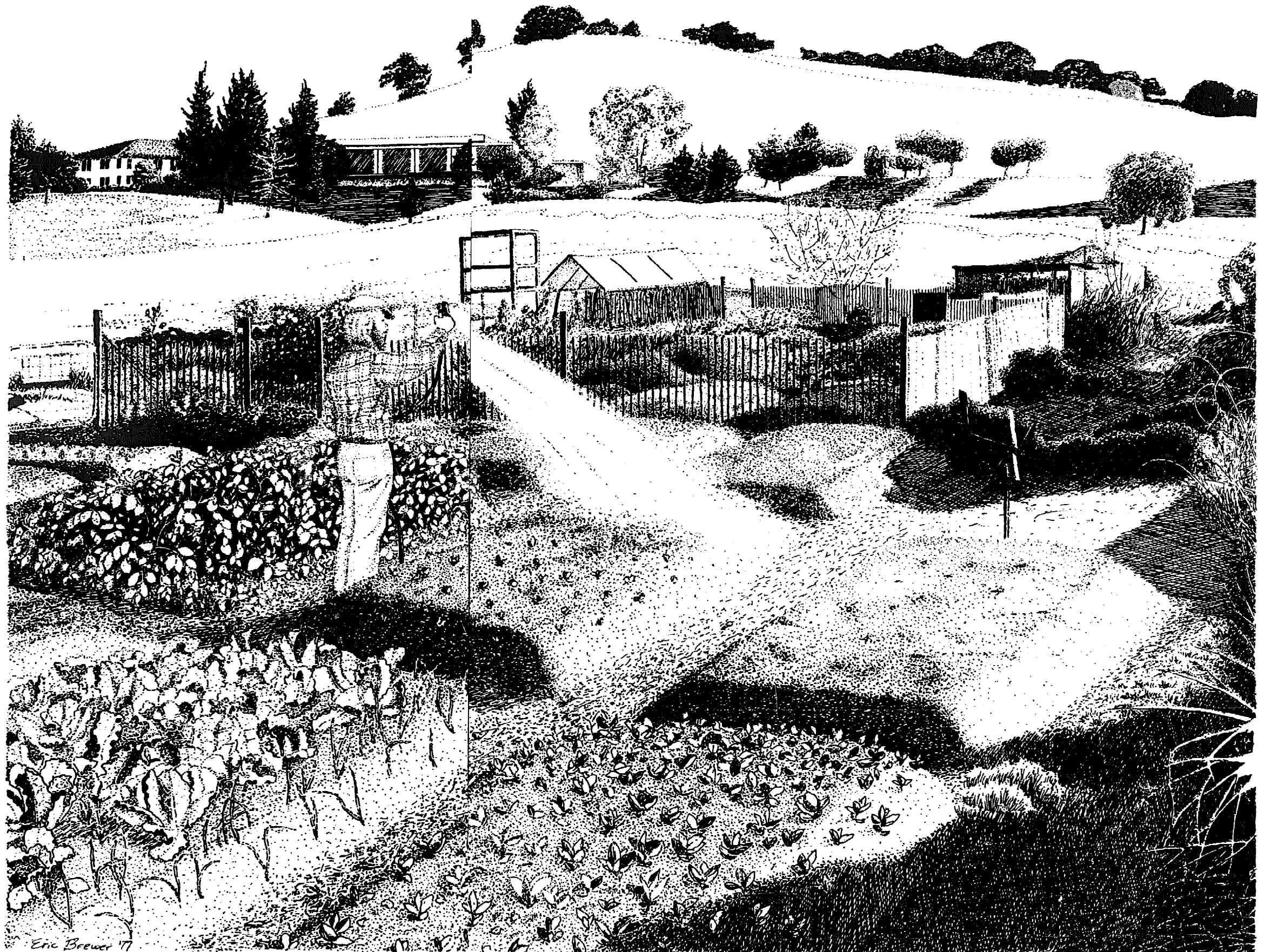

Eric Brewer '77

Drawing of Common Ground Garden provided by Landal Institute, Sausalito, CA

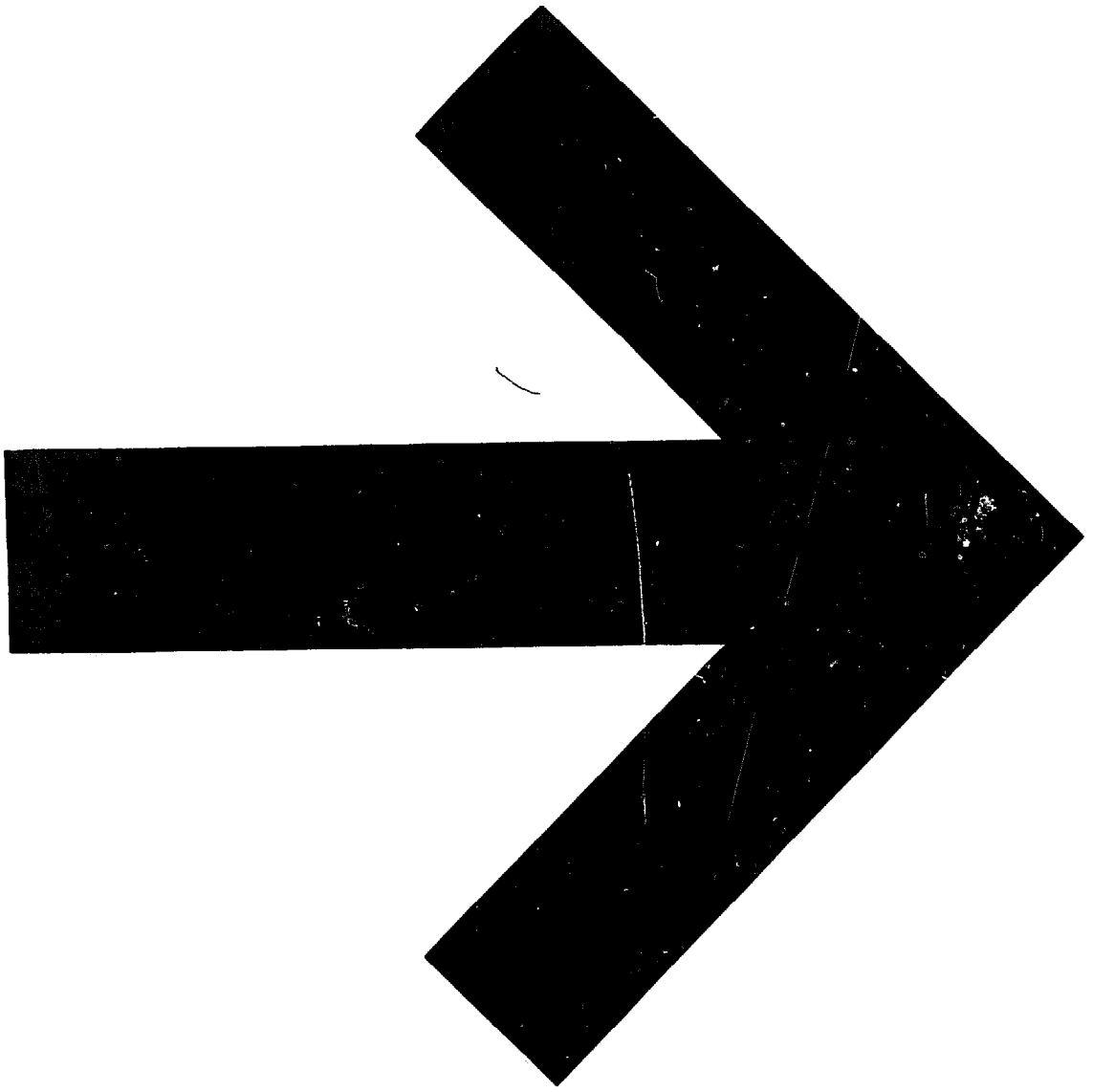

Contents

Preface / xii

Introduction / xv

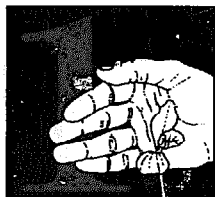

History and Philosophy / 2

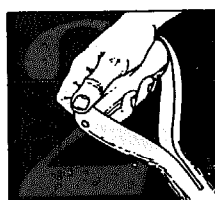

Bed Preparation / 6

Initial Preparation Chart

Tools

Double Digging Process

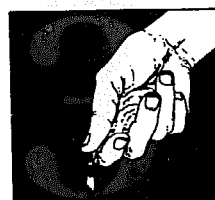

Fertilization / 20

Soil Testing

Fertilizers

General Program

(use second column on page 27
if no soil test is done)



Compost / 33

Simple Compost Recipe—44



Seed Propagation / 45

Seed Planting

Flats

Transplanting

Moore Planting

Watering

Weeding

Plant Seasons

Master Charts (use Column H for spacings)

Vegetables—68

Grains—76

Cover crops—80

Special Crops—84

Tree and Vine Crops—88

Flowers and Herbs—98

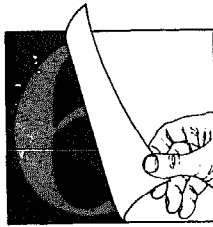

Making the Garden Plan / 101

Simple Mini-Garden

One-Person Mini-Garden—Plans for Four Years

Family Garden

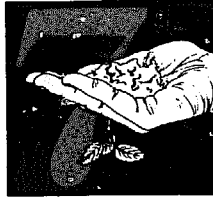

Companion Planting / 118

Health

Beneficial Herbs

Crop Rotation

Multi-Crop Planting

Physical Complementarity

Weed Control

Insect Control

Companion Vegetable Chart

Companion Herb Chart

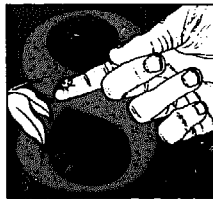

A Balanced Natural Backyard Ecosystem and Insect Life / 132

An Ecosystem and Natural Predators

Simple Insect and Pest Control

Bibliography / 141

Plan Your Own Mini-Course!

Animals

Bed Preparation

Companion Planting

Composting

Cover/Fodder/Organic Matter Crops

Experiences

Films and Video Tapes

Flowers

Food and Nutrition

General

Grains

Greenhouse Culture

Homesteading

Insect Life

Learning/Teaching

Other Crops

Seed Catalogs

Seed Propagation

Soil

Tools

Trees

Tropics

Vegetables

Water

Who is Ecology Action? / 151

“The Method”—Made Simple

The preceding Table of Contents has special notations to make this book especially easy to use for the beginner. One of the advantages of *How To Grow More Vegetables . . .* is that it is a complete general approach to gardening. As one learns the basics of soil preparation, the simple joys of gardening grow in depth. This is because the bed preparation, fertilization, composting, seed propagation, transplanting, watering and weeding are performed essentially in the same way for *all* crops. Only the seedling flat and growing bed spacings are different from one crop to another and these are given in *first* column M and H of each section master charts. So, once you know how to grow lettuce, you know most of the basics for growing onions, tomatoes, wheat, apple trees, and even cotton!

Remember to enjoy the gardening experience while you are working: the warmth of the sun, the touch of a breeze, the scent of a flower, the smell of freshly turned soil, the song of a bird, and the beauty of it all. Above all it should be fun!

One way to harvest the fullest enjoyment is to garden with your family or friends. Light conversations make the time pass quickly during even the most difficult tasks. Consider: having a barbeque or picnic after double-digging, a neighborhood compost building party, and letting your children experience the joy of harvesting! And preserving the year's harvest is always a social occasion. Gardening together is a practical experience of learning and sharing for each of us, and it is at least half of the fun.

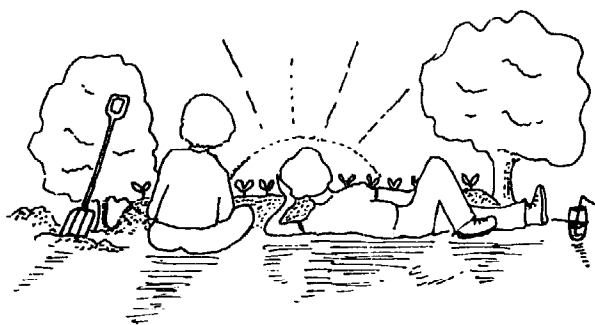

As a *beginning* gardener reads *How To Grow More Vegetables . . .*, he or she will want to skip most of the tables except for the second column of the fertilization table on page 23 and the *first* column H in the master charts which list plant spacings. These charts begin on page 68. A beginner normally starts by growing vegetables and a few flowers and herbs and many of those crops could even be bought as seedlings from a local nursery. Starting your own seedlings is another level of skill that can be tried the second or third year.

As this book is reread, an *intermediate* gardener will begin to use more of the tables and charts and to grow some cover crops, grains, and fruit trees. The Bibliography will begin to be a source of additional learning on particular topics of interest as a skilled backyard mini-farmer begins to emerge.

Ten years in the garden will produce a fully experienced food grower. This person will draw on most of the information provided in the book as he or she works on growing most or all of the family's food at home, plants a mini-orchard in the front yard, or teaches others the skills already mastered.

How To Grow More Vegetables . . ., then, provides one with everything needed to create a garden symphony—from the basic techniques to a beautifully planted backyard homestead. What is exciting is that each of us will never know everything! Alan Chadwick, when he had been gardening for fifty years often said "I am still learning." And so are we all. There is a lifetime of growing before us and the living "canvas" we are "painting" will always be getting better!

Preface

The Common Ground Garden was started in 1972 to find the agricultural techniques that would make food-raising by small farmers and gardeners more efficient. We have come to call the result “mini-farming”. Mini-farms can flourish in non-agricultural areas such as mountainous regions, arid areas, and in and around urban centers. Food can be produced where people live. With knowledge and skill, output per hour can be high without the expensive machinery that is the addiction of our current agriculture. Mini-farming is available to everyone.

So far we have concentrated on the exciting possibilities presented by the biodynamic/French intensive method—does this method really produce four times the yield as its originator claimed? If so, does it take more water? Consume vast amounts of fertilizer and organic matter? Does it exhaust the soil? Or the people working? The only way to answer these questions was to plunge in and try it. We have mostly been working on the quantitative aspects, developing the tools and data to maximize yields within the framework of its life-giving approach. This has involved experimentation with and evaluation of plant spacings, fertilizer inputs, various watering methods and other variables. The work has always been worthwhile despite ongoing difficulties attracting strong and sustaining support. The biggest single asset to this undertaking is John Jeavons’ unfailing stamina and dedication. Over and over, when we all ask, “Can it work?”, he answers “How are we going to make it work?” It is becoming increasingly clear that use of “the method” will be an important part of the solution to starvation and malnutrition, dwindling energy supplies, unemployment, and exhaustion and loss of arable land, if the social and political barriers can be overcome.

After ten years of testing, “the method” has produced amazing benefits and a lot of work is still to be done. YIELDS can average 4–6 times that of U.S. agriculture and range on up

to 31 times. The full potential has probably not yet been reached. We are still working to develop an optimally healthy soil system. GRAINS, BEANS, and COVER CROPS present the most challenges because they are crucial in meeting nutritional needs for people and the soil. Experiments include soybeans, alfalfa, fava beans, wheat and comfrey. So far our yields are from one to five times the U.S. averages for these crops. WATER use is well below that of commercial agriculture per pound of food produced, and may be about one-half that used by commercial techniques per unit of land area. ENERGY consumption, expressed in kilocalories of input, is 1/100 that used by commercial agriculture. The human body is still more efficient than any machine we have been able to invent. Several factors contradict the popular conception of this as a labor-intensive method. Using hand tools may seem to be more work, but the yields more than compensate. At 18¢ a pound wholesale, zucchini brings us \$6.00 to \$12.00 per hour depending on harvesting size. Time spent in soil preparation is more than offset later in less need for weeding, thinning, cultivation and other chores per unit of area and per unit of yield. Hand watering and harvesting appear to take the most time. Initial soil preparation may take up to 8 hours per 100-square-foot raised bed. Thereafter the time spent decreases dramatically. A new digging tool, the U-bar, has reduced subsequent bed preparation time to as little as 20 minutes. A new hand watering tool is also being developed which waters more quickly *and* more gently.

Nature has answered our original queries with an abundance even greater than expected and narrowed our search to the most important question that can be asked of any agricultural system. Is it sustainable? Nitrogen fertilizer use of the biointensive method is currently 1/2 or less of that used commercially. Can we produce all fertilizer needs on site? Or is some outside input always necessary? We need to look closer at other nutrients: phosphorus, potash, calcium, and trace minerals. Anyone can grow good crops on good soil cashing in on Nature's accumulated riches. The biodynamic/French intensive method appears to allow anyone to take "the worst possible soil" (Alan Chadwick's appraisal of our research site) and turn it into a bountiful garden. The long-term question of soil sustainability is still to be answered. Preliminary monitoring of the soil-building process by a University of California soil scientist is probably the most important research that has been performed at the garden. Continued monitoring may unlock new secrets and provide hope for people with marginal, worn-out or desertified soils. However, a complete answer will require at least 50 years of observation as the living soil system changes and grows!

Nine years of growing and testing in Ecology Action's urban garden came to an end during 1980 due to the termination of our lease and the start of construction on that land. As so much other agricultural land in the United States, our lovingly tended

beds succumbed to the press of urbanization. The city garden has prepared us for a rural site. The "safety nets" of grocery store and electric lines will soon be removed to make room for open skies and room to grow more herbs, flowers, vegetables, beans and grains than we ever imagined. We are especially looking forward to a permanent site where we can grow trees of all kinds, for food, fuel, and beauty. Other favored projects will be a self-fertilizing lawn composed of fragrant herbs and clovers, and a working "mini-farm". We estimate that a one-person small holding (1/2 to 1/8 acre) can grow crops bringing in a net income of \$5,000 to \$20,000 a year after 4 to 5 years. We hope to achieve this income from 1/8 acre set aside in our research area soon after a new site is established. Crops grown may include: collards, beets, spinach, green onions, garlic, radishes, romaine and bibb lettuce, zucchini, patty pan squash and cucumbers. Most importantly, we hope people will not look solely to Ecology Action for answers, but will dig in and try "the method" for themselves! The techniques are simple to use, as this book shows. No large capital expenses are necessary to get started. The techniques work in varied climates and soils. American farmers are "feeding the world," but mini-farming gives people the knowledge to feed themselves.

Robin Leler
Ecology Action Staff
March 1, 1982

Introduction

In September, 1971, Larry White, Director of the Nature and Science Department for the City of Palo Alto, invited Stephen Kafka, Senior Apprentice at the University of California-Santa Cruz Student Garden, to give a four hour class on the biodynamic/French intensive method of gardening. Two years before, the City had made land available to the public for gardening and residents appeared eager to hear more about this method. Alan Chadwick had brought the method to Santa Cruz five years earlier and with love, vision and apparent magic, the master horticulturist had converted a barren slope into a Garden of Eden. Vegetables, flowers and herbs flourished everywhere. The techniques of the method were primarily available through training in a two year apprentice program at Santa Cruz and through periodic classes given by Alan Chadwick or Stephen Kafka. However, neither detailed public classes nor vegetable yield research were being conducted regularly at Santa Cruz or in Palo Alto.

In January, 1972, Ecology Action's Board of Directors approved a biodynamic/French intensive method research and education project. The purposes of the Ecology Action project were

- to teach regular classes
- to collect data on the reportedly fourfold yields produced by the environmentally sound horticultural method
- to make land available for gardening to additional mid-peninsula residents
- to publish information on the method's techniques.

In May, after a five month search for land, the Syntex Corporation offered 3-3/4 acres of their grounds in the Stanford

Industrial Park at no cost and all the water needed for the project. Frank Koch, Syntex Public Affairs Director, told Dr. Alejandro Zaffaroni of the Alza Corporation about the project and Dr. Zaffaroni subsequently contributed the first money to the project, \$5,000 without which we never could have begun. Commitment by Frank Koch, Don Keppy, Chuck and Dian Missar, Ruth Edwards, Ibbey Bagley, numerous individuals, several corporations and the Point Foundation enabled the project to continue.

Alan Chadwick soon visited the garden site and gave us basic advice on how to proceed. We then attended a series of lectures given by Mr. Chadwick in Saratoga, California. Using the classes taught by Alan Chadwick and Stephen Kaffka as a base, we began teaching our own classes in the spring of 1972.

Further study and experience in the garden have made it possible to increase the original class to a five week series which is continually "recycled". The series of classes led to the development of information sheets on topics such as vegetable spacings and composting techniques. Many people asked for a book which contains all the information we have gathered. Those who have been unable to attend our Saturday classes or have friends who live outside the area have been especially insistent. This book is the result. Robin Leler, Betsy Jeavons, Tom Walker, Craig Cook, Rip King, Bill Spencer, Claudette Paige, Kevin Raftery, Marion Cartwright, Paka, Phyllis Anderson, Wayne Miller, members of Ecology Action and friends, have all made important contributions to its content and spirit.

I assume responsibility for any inaccuracies which may have been included—they are mine and not Alan Chadwick's or Stephen Kaffka's. The book is not intended to be an exhaustive work on the subject, but rather one of simple completeness. We, ourselves, are only at a beginning to intermediate stage of knowledge. Its purpose is to "turn on" as many people as possible to a beautiful, dynamically alive method of horticulture and life. I had hoped that the great interest this book is stimulating would eventually encourage Alan to write an extensive work on the many sophisticated techniques which only he knew well. Because of his untimely death in 1980, this is no longer possible.

Our initial research seems to indicate that the method can produce an average of four times more vegetables per acre¹ than the amount grown by farmers using mechanized and chemical agricultural techniques. The method also appears to use 1/8 the water² and 1/2 to zero^{2a} purchased nitrogen fertilizer, and 1/100³ the energy consumed by commercial agriculture, per pound of vegetable grown. The flavor of the vegetables is usually excellent and there are indications that their nutritive value can be higher. The method is exciting to me because each of us be-

1, 2, 2a. Based on data collected through 1979.

comes important again as we find our place *in relation* to nature.

One person annually consumes in food the energy equivalent (in calories or British Thermal Units) of 32.6 gallons of gasoline.⁴ In contrast, the best economy car available will use that much gas in a month or two of ordinary driving. Imagine the fuel consumed by a tractor or industrial machine each year! People are not only beautiful, they are very capable and efficient! At this point we believe "the method" can even produce more net income per acre than commercial agriculture. With "the method" we help provide for the needs of the plants instead of trying to dominate them. When we provide for these real needs, the plants bounteously provide more food. In striving for quality, a person will be able to provide a diet and income more than sufficient for his or her needs. The effort will produce a human renaissance and a cornucopia of food for all.

Much new material is included in this latest revision: some improved soil preparation approaches, basic water consumption information for natural rainfall and drought growing, corrected and updated yield and planning data, added data for grain, fodder, cover, and tree crop growing, and a greatly expanded bibliography. In short, more information to add to your fun as you grow past the beginning stage of biointensive mini-farming in depth and breadth! This edition represents over a decade of our working with plants, chickens and goats. Hopefully, it will make your path easier.

John Jeavons
March 1, 1982
Palo Alto, California

3. November 2, 1973, letter from Richard Merrill, Director of the New Alchemy Institute-West, Pescadero, California. Data were collected and evaluated by Mr. Merrill and Michael J. Perelman, Assistant Professor of Economics, California State University at Chico. The data are for a growing area with a proper humus content after a 5 year development period. The data are a qualitative projection and have been assembled during a three year period of tests performed on root and leaf crops (except brassicas) grown by hand cultivation in the Santa Barbara area with its 9 month growing season. (The 1/100 figure does not include the energy required to get the soil system to the point noted above and does not include unproductive plots which constituted 10% of the area under cultivation.)

4. Michael Perelman, "Efficiency in Agriculture: The Economics of Energy," *Radical Agriculture*, Edited by Richard Merrill, Harper and Row, New York, 1976, p. 86.

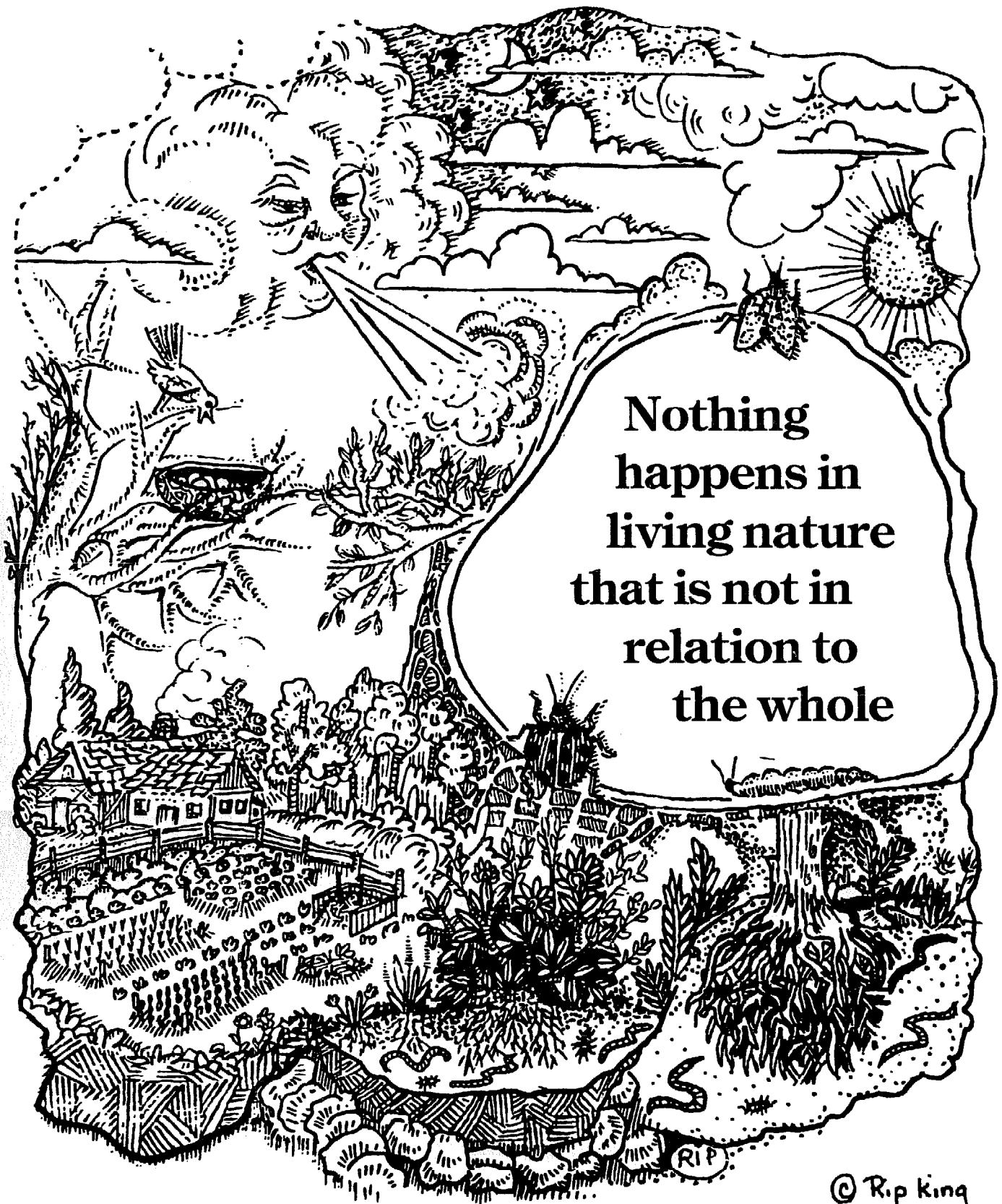

**Nothing
happens in
living nature
that is not in
relation to
the whole**

© Rip King
1976

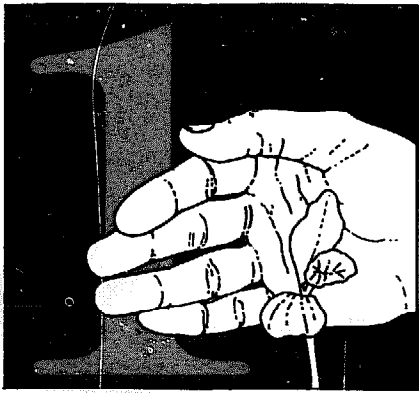

History and Philosophy

The biodynamic/French intensive method of horticulture is a quiet, vitally alive art of organic gardening which relinks people with the whole universe—a universe in which each of us is an interwoven part of the whole. People find their place by relating and cooperating in harmony with the sun, air, rain, soil, moon, insects, plants and animals rather than by attempting to dominate them. All these elements will teach us their lessons and do the gardening for us if we will only watch and listen. We each become gentle shepherds providing the conditions for plant growth.

The biodynamic/French intensive method is a combination of two forms of horticulture begun in Europe during the late 1800's and early 1900's. French intensive techniques were developed in the 1890's outside Paris on two acres of land. Crops were grown on an eighteen inch depth of horse manure, a fertilizer which was readily available. The crops were grown so close to each other that when the plants were mature their leaves would barely touch. The close spacing provided a *mini-climate* and a *living mulch* which reduced weed growth and helped hold moisture in the soil. During the winter glass jars were placed over seedlings to give them an early start. The gardeners grew up to nine crops each year and could even grow melon plants during the winter.

The biodynamic techniques were developed by Rudolf Steiner, an Austrian genius, philosopher and educator in the early 1920's. Noting a decline in the nutritive value and yields of crops in Europe, Steiner traced the cause to the use of the newly introduced synthetic, chemical fertilizers and pesticides. An increase was also noticed in the number of crops affected by disease and insect problems. These fertilizers were not complete and vital meals for the plants, but single, physical nutrients in a soluble salt form. Initially, only nitrogen fertilizers were used to stimulate growth. Later phosphorus and potash were

Winter lettuce growing in 1890's Cloche (Bell-Glass). Standard diameter 16 3/4 inches.



added to strengthen the plants and to minimize disease and insect problems. Eventually, trace minerals were added to the chemical larder to round out the plants' diet. After breaking down nutrients into their component parts for plant food, people found it necessary to recombine them in mixtures approximating a balanced diet. This attempt might have been more successful if the fertilizers had not caused chemical changes in the soil which damage its structure, kill beneficial microbiotic life and greatly reduce its ability to make nutrients already in the air and soil available to plants.

Rudolf Steiner returned to the more gentle, diverse and balanced diets of organic fertilizers as a cure for the ills brought on by synthetic, chemical fertilization. He stressed the holistic growing environment of plants: their rate of growth, the synergistic balance of their environments and nutrients, their proximity with other plants and their various *companion* relationships. He initiated a movement to scientifically explore the relationship which plants have with each other. From centuries of farmer experience and from tests, it has been determined that certain flowers, herbs, weeds and other plants can minimize insect attacks on plants. Many plants also benefit one another. Strawberries and green beans produce better when grown together. In contrast, onions stunt the growth of green beans. Tomatoes are narcissists—they prefer to be grown alone in compost made from tomato plants.

The biodynamic method also brought back raised planting beds. Two thousand years ago, the Greeks noticed that plant life thrives in landslides. The loose soil allows air, moisture,

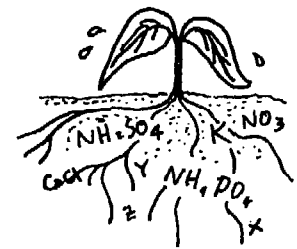

Artificial fertilization

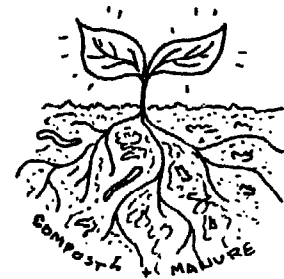

Natural fertilization

French gardeners at lettuce beds
—early 1900's.



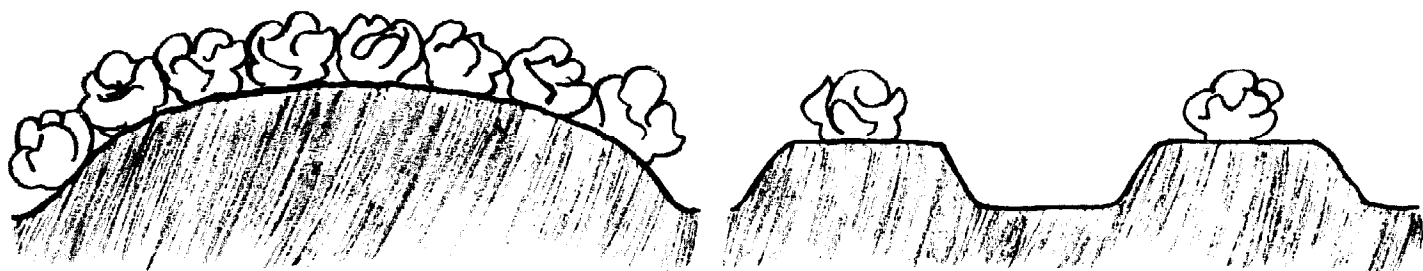

(Left) Biodynamic/French intensive raised bed (Right) traditional rows.



Row plants are more susceptible to soil compaction.

warmth, nutriment⁵ and roots to properly penetrate the soil. The curved surface area between the two edges of the landslide bed provides more surface area for the penetration and interaction of the natural elements than a flat surface. The simulated landslides or raised beds used by biodynamic gardeners are usually 3 to 6 feet wide and of varying lengths. In contrast, the planting rows usually made by gardeners and farmers today are only a few inches wide with wide spaces in-between. The plants have difficulty growing in these rows due to the *extreme* penetration of air and the greater fluctuations in temperature and moisture content. During irrigation, water floods the rows, immerses the roots in water and washes soil away from the rows and upper roots. Consequently, much of the beneficial microbiotic life around the roots and soil, which is so essential to disease prevention and to the transformation of nutriment into forms the plants can use, is destroyed and may even be replaced by harmful organisms. (About three-quarters of the beneficial microbiotic life inhabits the upper six inches of the soil.) After the water penetrates the soil, the upper layers dry out and microbial activity is severely curtailed. The rows are then more subject to wide temperature fluctuations. Finally, to cultivate and harvest, people and machines trundle down the troughs between the rows, compacting the soil and the roots which eat, drink and breathe—a difficult task with someone or something standing on the equivalent of your mouth and nose!

These difficulties are also often experienced at the *edges* of biodynamic/French intensive raised beds prepared in clay soils during the first few seasons. Until the soil texture becomes friable, it is necessary to level the top of the raised bed to minimize erosion (see chapter on Bed Preparation) and the soil on the sides of the beds is sometimes too tight for easy planting. Increased exposure to the elements occurs on the sides and the tighter soil of the paths is nearby. The plants along the sides usually do not grow as vigorously as those further inside the bed. When raised beds are prepared in friable soil, the opposite is true. The top of the bed can now be curved and erosion will not be a problem. The soil is loose enough for plants to thrive along the sides. The mini-climate effect created by closely

5. A nutriment is "something that nourishes or promotes growth and repairs the natural wastage of organic life." It differs from a nutrient which is merely "a nourishing substance or ingredient."

spaced plants is added to the edges of the beds and the water that runs from the middle of the bed provides the extra moisture which is needed.

During the time between the 1920's and the 1960's, Alan Chadwick, an Englishman, combined the biodynamic techniques and the French intensive techniques into the biodynamic/French intensive method. The United States was first exposed to the combination when Mr. Chadwick brought the method to the four acre organic Student Garden at the University of California-Santa Cruz campus in the 1960's. Alan Chadwick, a horticultural genius, had been gardening for half a century and was also an avid dramatist and artist. He studied under Rudolf Steiner, the French gardeners, George Bernard Shaw, and worked as a Gardner for the State of South Africa. The site he developed at Santa Cruz was on the side of a hill with a poor clayey soil. Not even "weeds" grew well there—except poison oak which was removed with pick-axes. By hand, Alan Chadwick and his apprentices created a good soil in two to three years. From this soil and vision, a beautiful, wonderous and real Garden of Eden was brought into existence. The original barren soil was made *fertile* through extensive use of compost, with its life-giving humus. The humus produced a healthy soil that grew healthy plants less susceptible to disease and insect attacks. The many nuances of the biodynamic/French intensive method—such as transplanting seedlings into a better soil each time a plant is moved and sowing by the phases of the moon—were also used. The result was beautiful flowers with exquisite fragrances and tasty vegetables of high quality. As an added bonus for all the tender loving care they received, the vegetable plants produced yields four times greater than those produced by commercial agriculture.

Lush growing beds at Common Ground make optimal use of garden space.



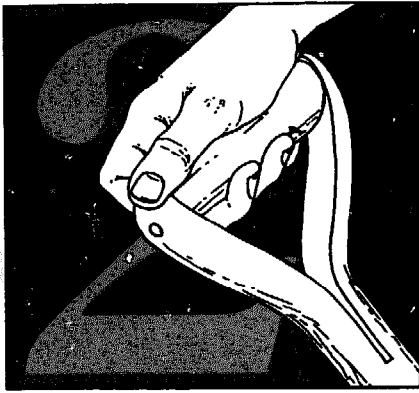

Bed Preparation

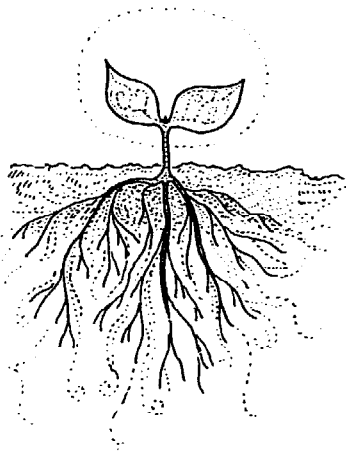

Proper soil structure and nutrients allow uninterrupted and healthy plant growth.

The preparation of the raised bed is the most important step in biodynamic/French intensive gardening. The proper structure and nutrients allow uninterrupted and healthy plant growth. Loose soil with good nutrients enables roots to penetrate the soil easily and a steady stream of nutrients flows into the stem and leaves. How different from the usual situation when a plant is transferred from a flat with loose soil and proper nutrients into a hastily prepared backyard plot or a chemically stimulated field. Not only does the plant suffer from the shock of being uprooted, it is also placed in an environment where it is more difficult to grow. The growth is interrupted, the roots have difficulty getting through the soil and obtaining food, and the plant develops more carbohydrates and less protein than usual. Insects prefer the carbohydrates. The plant becomes more susceptible to insect attack and ultimately to disease. A debilitating cycle has begun which often ends in the use of pesticides that kill soil life and make the plant less healthy. More fertilizers are then used in an attempt to boost the health of the plants. Instead, the fertilizers kill more soil life, damage the structure of the soil further, and bring into being even sicker plants that attract more insects and need more toxic “medicines” in the form of pesticides and additional fertilizers. There are well documented reports on a wide variety of commercial pesticides, which kill beneficial invertebrate predators while controlling pest populations. These pesticides exterminate earthworms and other invertebrates that are needed to maintain soil fertility. The pesticides also destroy microorganisms that provide symbiotic relationships between the soil and plant root systems. Why not strive for good health in the first place!

Unless you are lucky enough to have loose soil, preparing and planting a raised bed takes a lot of work—as much as 6 to 12 hours for a 100-square-foot bed 5 feet by 20 feet the first time.

After the first crop, however, only 4 to 6 hours should be required because the soil will have better texture. Once the beds are planted, only about 5–10 minutes a day are required to maintain a 100-square-foot area—an area large enough to provide one person with vegetables 12 months a year in an area with a 4–6 month growing season.⁶ Even less time and area are required in an area with an 8–12 month growing season. Beginning gardeners may require a 200-square-foot area for the same yield, but we recommend a new gardener only use 100-square-feet and allow his or her improving skills and soil to gradually produce more food. It is much easier.

The square feet required to provide the vegetable supply for one person are approximate since the exact amount varies depending on whether the individual likes corn (which takes up a lot of space per pound of edible vegetable grown), or a lot of carrots, beets, potatoes, and tomatoes (which require much less area per pound of food produced). Using the tables in the Planning chapter (based on yields produced by the method for all vegetable crops), the homeowner or farmer can determine the actual amount of area that should be allowed for each crop.

An Instruction Chart for the first preparation of a 100-square-foot bed in a heavy clay, very sandy, or good soil is given below. A chart for the reparation of a bed each season is also given. After the soil has been initially prepared you will find the biodynamic/French intensive method requires less work than the gardening technique you presently use. The Irish call this the “lazy bed” method of food raising. In addition, you will receive good tasting vegetables and an average of four times as many vegetables to eat! Or, if you wish to raise only the same amount of food as last year, 1/4 the area will have to be dug, weeded and watered.

6. 100 square feet can yield over 300 pounds of vegetables and soft fruits in a 4–6 month growing season. The average person in the United States consumes about 322 pounds of vegetables and soft fruits annually.

INITIAL PREPARATION PER 100 SQUARE FEET

Perform a Soil Test (see soil test section in the chapter on Fertilization)

1. Soak area to be dug for 2 hours with a sprinkler (for hard, dry clays).
2. Let soil dry out partially for 2 days.
3. Loosen soil 12 inches deep with spading fork and remove weeds: 1–2 hours.
4. Water gently by hand for 5 minutes, and let soil rest for 1 day. If your soil has particularly large clods you can wait several extra days, and the action of the warm sun, cool nights, wind and water will help break down the clods. Let nature help do the work! Water the bed lightly each day to aid the process. Sand may be added to a bed with clayey soil at this time to improve its texture. Normally not more than a 1 inch layer of sand (8 cubic feet) should be added,

as more may allow the water-soluble fertilizers to percolate down too rapidly. Mix the sand thoroughly into the upper 12 inches with a spading fork: 1 hour.

5. Add a 3 inch layer (1 cubic yard or 27 cubic feet per 100 square feet) of compost (preferably or aged manure⁷ to soil with poor (very sandy or very clayey) texture. Add only a 1 inch layer (8 cubic feet) to the surface of the bed in good soil. Mix thoroughly into the upper 12 inches with a spading fork: 1-2 hours.
6. Water gently by hand for 5 minutes, and let soil rest for 1 day.
7. "Double-dig" the soil with a flat spade and spading fork. Be sure to use a digging board to avoid unnecessary compaction of the soil (See pages 10 to 17 for "double-digging" instructions.): 2-4 hours.
8. Level and shape bed: 1 hour.
9. Water gently by hand for 3-5 minutes, and let soil rest for 1 day if working with a heavy soil.
10. Sprinkle organic nitrogen, phosphorus, potash, calcium and trace mineral fertilizers (such as blood, fish, hoof and horn, cottonseed, bone and kelp meals, wood ash and eggshells) indicated by the soil test evenly over surface of bed after leveling and shaping bed. pH modifiers (such as leaf/pine needle compost to make the soil less alkaline, or lime to make the soil less acid) indicated as desirable by a soil test should also be included at the time. Sift in fertilizers and pH modifiers only 2-3 inches deep with spading fork. Reshape bed if needed. Tamp bed down with the digging board by placing the board on various sections of the bed and then standing on the board. This removes excess air from the upper few inches of the bed: 1-2 hours.
11. Plant or transplant: 1-2 hours.

TOTAL: 6-14 hours

7. 2 year old steer or cow manure, or 2 year old horse manure (which originally contained a lot of sawdust) or 2 month old horse or chicken manure not containing much sawdust.

PREPARATION FOR REPLANTING PER 100 SQUARE FEET

1. "Double-dig" the soil after removing remaining vegetation: 2-3 hours.
2. Shape bed: 1/2 hour.
3. Water gently by hand for 3-5 minutes, and let soil rest for one day if soil is still heavy.
4. Add a 1-inch layer (8 cubic feet) of compost to the top of the bed, and add any fertilizers and pH modifiers indicated by soil test plus 1/4 inch layer (2 cubic feet) aged manure to the surface after shaping the bed. Sift in materials 2-3 inches deep with spading fork: 1/2-1 hour. (Adding the compost *after* the double-dig for *ongoing* soil preparations minimizes problems caused by more rapid water-soluble nitrogen leaching in an increasingly loose soil.)
5. Plant or transplant: 1-2 hours.

TOTAL: 4-1/2-6-1/2 hours

as more may allow the water-soluble fertilizers to percolate down too rapidly. Mix the sand thoroughly into the upper 12 inches with a spading fork: 1 hour.

5. Add a 3 inch layer (1 cubic yard or 27 cubic feet per 100 square feet) of compost (preferably or aged manure⁷ to soil with poor (very sandy or very clayey) texture. Add only a 1 inch layer (8 cubic feet) to the surface of the bed in good soil. Mix thoroughly into the upper 12 inches with a spading fork: 1-2 hours.
6. Water gently by hand for 5 minutes, and let soil rest for 1 day.
7. "Double-dig" the soil with a flat spade and spading fork. Be sure to use a digging board to avoid unnecessary compaction of the soil (See pages 10 to 17 for "double-digging" instructions.): 2-4 hours.
8. Level and shape bed: 1 hour.
9. Water gently by hand for 3-5 minutes, and let soil rest for 1 day if working with a heavy soil.
10. Sprinkle organic nitrogen, phosphorus, potash, calcium and trace mineral fertilizers (such as blood, fish, hoof and horn, cottonseed, bone and kelp meals, wood ash and eggshells) indicated by the soil test evenly over surface of bed after leveling and shaping bed. pH modifiers (such as leaf/pine needle compost to make the soil less alkaline, or lime to make the soil less acid) indicated as desirable by a soil test should also be included at the time. Sift in fertilizers and pH modifiers only 2-3 inches deep with spading fork. Reshape bed if needed. Tamp bed down with the digging board by placing the board on various sections of the bed and then standing on the board. This removes excess air from the upper few inches of the bed: 1-2 hours.
11. Plant or transplant: 1-2 hours.

TOTAL: 6-14 hours

7. 2 year old steer or cow manure, or 2 year old horse manure (which originally contained a lot of sawdust) or 2 month old horse or chicken manure not containing much sawdust.

PREPARATION FOR REPLANTING PER 100 SQUARE FEET

1. "Double-dig" the soil after removing remaining vegetation: 2-3 hours.
2. Shape bed: 1/2 hour.
3. Water gently by hand for 3-5 minutes, and let soil rest for one day if soil is still heavy.
4. Add a 1-inch layer (8 cubic feet) of compost to the top of the bed, and add any fertilizers and pH modifiers indicated by soil test plus 1/4 inch layer (2 cubic feet) aged manure to the surface after shaping the bed. Sift in materials 2-3 inches deep with spading fork: 1/2-1 hour. (Adding the compost *after* the double-dig for *ongoing* soil preparations minimizes problems caused by more rapid water-soluble nitrogen leaching in an increasingly loose soil.)
5. Plant or transplant: 1-2 hours.

TOTAL: 4-1/2-6-1/2 hours

as more may allow the water-soluble fertilizers to percolate down too rapidly. Mix the sand thoroughly into the upper 12 inches with a spading fork: 1 hour.

5. Add a 3 inch layer (1 cubic yard or 27 cubic feet per 100 square feet) of compost (preferably or aged manure⁷ to soil with poor (very sandy or very clayey) texture. Add only a 1 inch layer (8 cubic feet) to the surface of the bed in good soil. Mix thoroughly into the upper 12 inches with a spading fork: 1-2 hours.
6. Water gently by hand for 5 minutes, and let soil rest for 1 day.
7. "Double-dig" the soil with a flat spade and spading fork. Be sure to use a digging board to avoid unnecessary compaction of the soil (See pages 10 to 17 for "double-digging" instructions.): 2-4 hours.
8. Level and shape bed: 1 hour.
9. Water gently by hand for 3-5 minutes, and let soil rest for 1 day if working with a heavy soil.
10. Sprinkle organic nitrogen, phosphorus, potash, calcium and trace mineral fertilizers (such as blood, fish, hoof and horn, cottonseed, bone and kelp meals, wood ash and eggshells) indicated by the soil test evenly over surface of bed after leveling and shaping bed. pH modifiers (such as leaf/pine needle compost to make the soil less alkaline, or lime to make the soil less acid) indicated as desirable by a soil test should also be included at the time. Sift in fertilizers and pH modifiers only 2-3 inches deep with spading fork. Reshape bed if needed. Tamp bed down with the digging board by placing the board on various sections of the bed and then standing on the board. This removes excess air from the upper few inches of the bed: 1-2 hours.
11. Plant or transplant: 1-2 hours.

TOTAL: 6-14 hours

7. 2 year old steer or cow manure, or 2 year old horse manure (which originally contained a lot of sawdust) or 2 month old horse or chicken manure not containing much sawdust.

PREPARATION FOR REPLANTING PER 100 SQUARE FEET

1. "Double-dig" the soil after removing remaining vegetation: 2-3 hours.
2. Shape bed: 1/2 hour.
3. Water gently by hand for 3-5 minutes, and let soil rest for one day if soil is still heavy.
4. Add a 1-inch layer (8 cubic feet) of compost to the top of the bed, and add any fertilizers and pH modifiers indicated by soil test plus 1/4 inch layer (2 cubic feet) aged manure to the surface after shaping the bed. Sift in materials 2-3 inches deep with spading fork: 1/2-1 hour. (Adding the compost *after* the double-dig for *ongoing* soil preparations minimizes problems caused by more rapid water-soluble nitrogen leaching in an increasingly loose soil.)
5. Plant or transplant: 1-2 hours.

TOTAL: 4-1/2-6-1/2 hours

The proper tools will make the work easier and more productive.

FOR SEED PROPAGATION

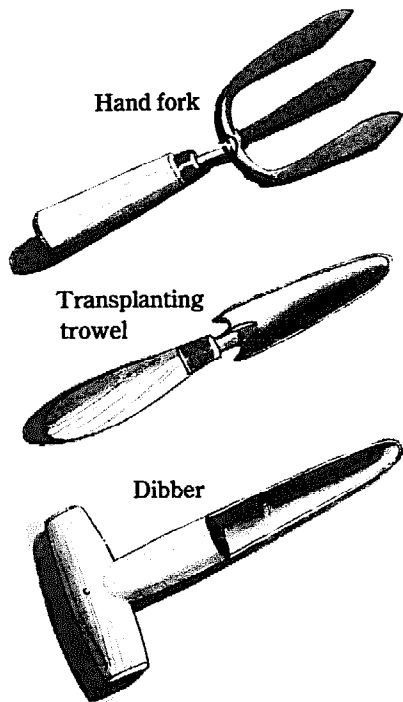

FOR SOIL PREPARATION

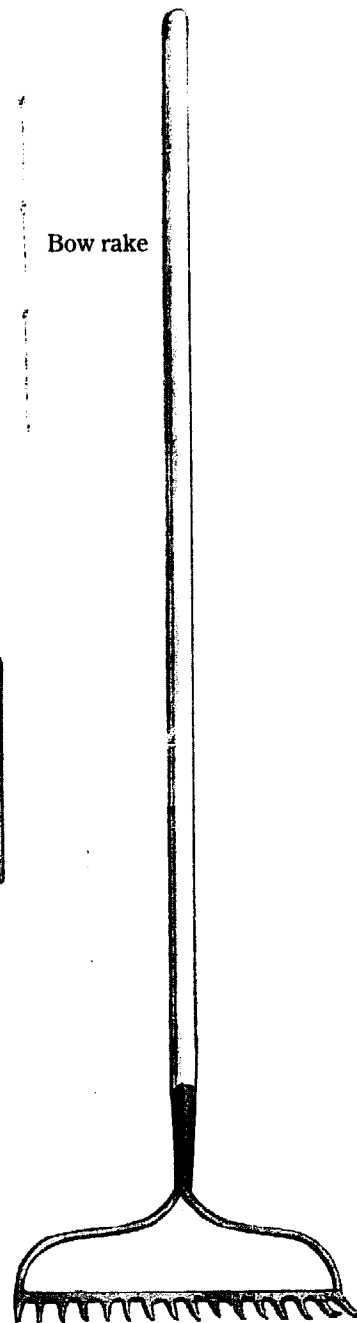
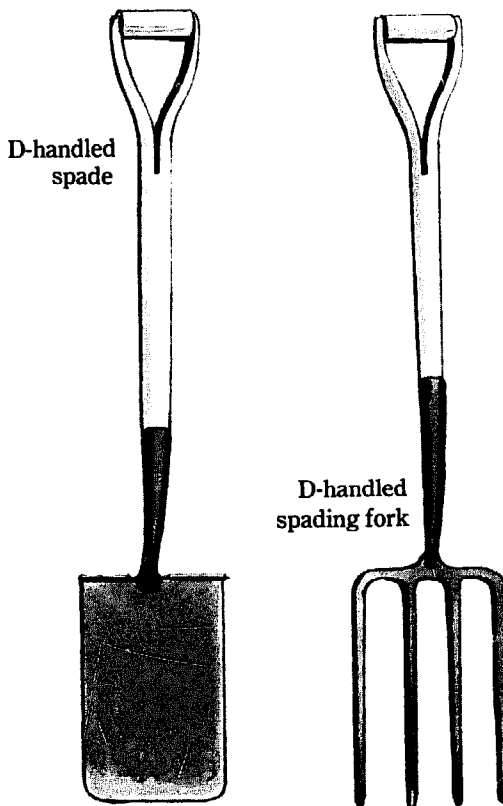

The goal of "double-digging" is to loosen the soil to a depth of 24 inches below the surface of the soil. The first year you may only be able to reach 15 to 18 inches with reasonable effort. Be satisfied with this result. Do not strain yourself or your tools. More important than perfection the first day or year or two is going in the right direction. Nature, the loose soil, worms, and the plant roots will further loosen the soil with each crop so that each year digging will be easier and the depth will increase 3 to 6 inches. This is easier on you and your tools!

For all around ease, D-handed flat spades and D-handed spading forks of good temper are usually used for bed preparation. (Poor tools will wear out rapidly while the garden area is being prepared.) D-handles allow the gardener to stand straight with the tool directly in front. A long handled tool must frequently be held to the side of the gardener. This position does not allow for simple, direct posture and leverage. When digging for long periods of time, the use of a D-handed tool is, therefore, less tiring for many people (though it will probably take the digging of 3 beds to get used to!). However, people with back problems may need long handled tools. In fact, people with back problems and those not in good health should check with their physician before proceeding with the physically active process of "double-digging."

The flat spade has a particular advantage in that it digs equally deep all along its edge rather than along a pointed "V"

Note the difference in side views of shovels

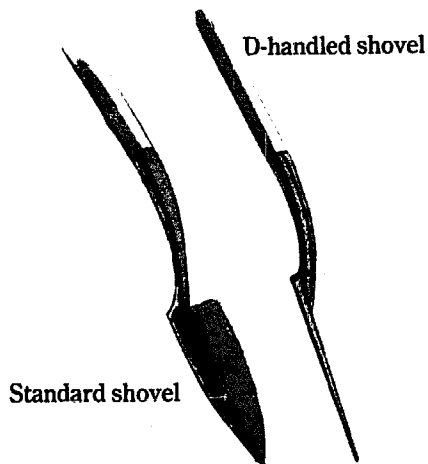

The Initial Double-dig Process

Step by Step

1.



2.



1. Spread a layer of compost over entire area to be dug.
2. Using a spade, remove soil from a trench 1 foot deep and 1 foot wide across the width of the bed. Place the soil at far end of bed.

Sides of bed should be dug outward into path.

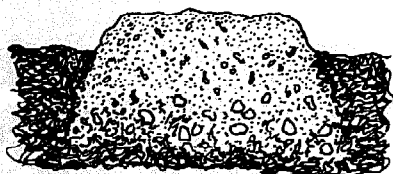

pattern. This is especially important in the double-dig when all points in the bed should be dug to an equal depth. The blade of the flat spade also goes into the soil at less of an angle and without the curve of the usual shovel. This means the sides of the bed can be dug perpendicular or even diagonally outward into the path, a plus for root penetration and water flow.

Digging should only be performed when the soil is evenly moist. It is easier and better for the soil. Digging a hard, dry soil breaks down the structure and it is difficult to penetrate. Wet soil is heavy and easily compacted. Compaction destroys a friable structure and minimizes aeration. These conditions kill microbotic life. The main reason for drying out periods after watering the soil is so the proper moisture level can be reached and to make digging enjoyable and beneficial. Soil is too dry for digging when it is loose and will not hold its shape after being squeezed in the palm of your hand (in the case of sands or loams) or when it is hard, dry and cannot easily be penetrated by a spade

3.

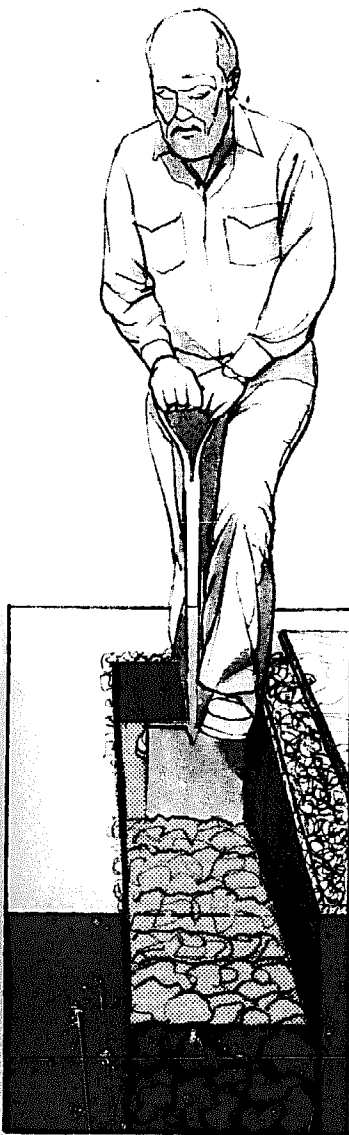

4.



5.



(in the case of clays). Soil is too wet when it sticks to the spade as you dig.

“Double-digging” is the term used for the process of preparing the soil two spades deep (about 24 inches). To begin, mark out a bed 3–5 feet wide and at least 3 feet long. Most people prefer a bed 5, 10 or 20 feet long but the maximum is up to you. To double-dig, remove the soil from a trench 1 foot deep and 1 foot wide across the width of one end of the bed. Use a 5/8 inch thick plywood board, 2–3 feet long by 3–5 wide, to stand on. Place it on top of the compost layer you spread over the bed and advance it along the bed 1 foot at a time as you prepare to dig each new trench. Move the soil from the first trench to the path in back of the last trench you intend to dig at the far end of your bed. Make as few motions as possible in the process. This will conserve your energy and involve less work. You can move the soil by hand with the shovel or by wheelbarrow. (When you are through double-digging, you will need the soil from the

3. *In good soil:* While standing in trench, loosen soil an additional 12 inches with a spade by digging into its full depth, lifting soil out on spade pan and then tipping pan downward so that the loosened, aerated soil slides back into trench. Mix up soil layers as little as possible.
4. *Alternate for moderately compacted soil:* loosen soil an additional 12 inches with a spading fork by digging tool into its full depth and then pushing tool handle downward so fork tines will lever through soil, loosening and aerating it.
5. Dig out upper part of second trench 1 foot deep and 1 foot wide. Throw each spadeful of dirt forward, mixing the soil layers as little as possible.

6a.

6b.

7.



- 6a. *Alternate for compacted soil:* while standing in trench, loosen soil an additional 12 inches with a spading fork by digging in the tool to its full depth, and lifting out a tight soil section on the fork pan.
- 6b. Then, by moving your arms upward in a small jerk, cause the soil to break apart as it falls downward, hits the fork tines, and falls into the hole below.
7. Spade the soil at the end of the bed (which came from the upper part of the first trench) into the open upper part of the last trench.

first trench to fill in the open trench which remains at the back of the bed.) Next, standing in the trench, dig down another 12 inches (if possible) with a spading fork a few inches at a time if the soil is tight. Leave the fork as deep as it has penetrated and loosen the subsoil layer by pushing the fork handle down and levering the tines through soil. If the soil is not loose enough for this process, lift the chunk of soil out of the trench on the fork tines. Then throw the chunk slightly upward and allow it to fall back on the tines so it will break apart. If this does not work, use the points of the fork tines to break the soil apart. Work from one end of the trench to the other in this manner.

Next, dig a trench behind the first one throwing each spadeful of soil forward. Sometimes you will have to go over a trench a second or third time to remove all the soil and obtain the proper trench size. Repeat the subsoil loosening process in the second trench. Dig a third trench and so on until the entire bed has been double-dug. At the end, spade the soil carried to the back of the bed into the open last trench.

When you are throwing the soil forward from one trench into another, notice two things. First, some of the compost layer you have added to the surface of the bed before beginning to dig slides three to six inches down into the trench along the small mound of soil or landslide. This approximates the way nature adds leaves, flower bodies and other decaying vegetation to the top of the soil where they break down and where their essences can percolate into the soil. Second, the *upper* layer should not be turned over during the double-dig and succeeding double-digs. Most of the microbiotic life lives in the upper 6 inches of the soil. Also, the natural layering of the soil which is caused by rainfall and leaching, leaf litter, water, temperature, gravity, and other natural forces is less disturbed when the soil is not generally mixed, even though the soil is loosened up and mixed a little. Thus, there is a balance between nature's natural stratification and man's shepherding landslide loosening. Strive not to mix the soil layers as a goal. The goal is important even though it will never be reached and significant mixing sometimes occurs. Without the goal, however, excessive disruption of the soil layers will occur.

TYPES OF DEEP SOIL PREPARATIONS

Simplified Side Views

Ecology Action uses four basic types of deep soil preparation processes: the initial double-dig, the ongoing double-dig, the complete texturizing double-dig, and the U-bar dig. Below are simplified side views of these processes for easy reference. The first two are described in the text. The complete texturizing double-dig was developed to improve soil quality more rapidly and is used one time only. It is used usually in place of the initial double-dig, but can be used at a later point in time. We have found this soil preparation process greatly improves plant health and yields immediately in poor soil. It is often worth the extra digging time involved. The U-bar dig is used as a frequent substitute for the ongoing double-dig in soil which is in reasonably good shape. This usually means after one normal double-dig or more. The eighteen-inch long U-bar tines do not prepare the soil as deeply, but compaction in the lower twelve inches of the growing bed is much slower than in the upper twelve inches. Also, the U-bar appears to have the advantage of mixing up the soil strata much less than double-digging with a spade and a spading fork. It aerates the soil less, however. This is an advantage in looser, sandier soil and can be a problem in tighter clays. We use the U-bar frequently now and do a normal double-dig as often as increased compaction indicates. U-barring is quicker and easier, though some knowledge of how your soil is improving, or not improving, is lost with the decreased per-

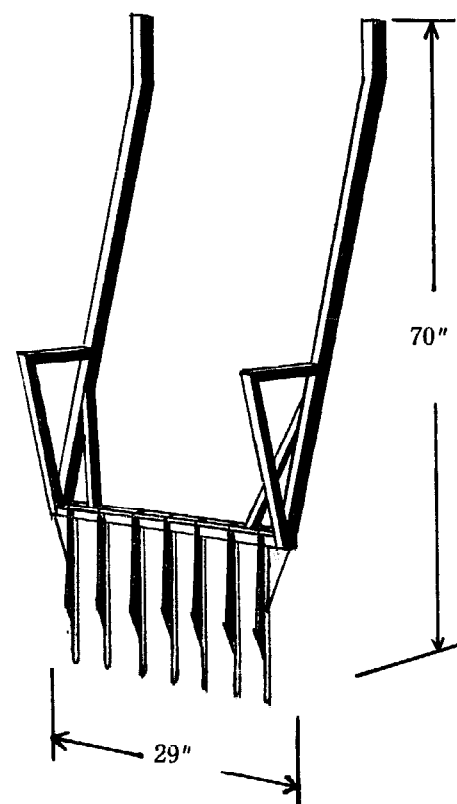

The U-bar

sonal contact with the soil. (For detailed plans on how to build a U-bar, see Ecology Action's booklet on "Sophisticated Low Technology Tools for Biointensive Food Raising".)

THE INITIAL DOUBLE-DIG

1. After soil is lightly moist, pre-loosen and weed entire area to be dug 12 inches deep with spading fork.
2. Spread a 1-inch to 3-inch layer of compost over entire area to be dug (after mixing in a 1-inch layer of sand—optional—12 inches deep).
3. Thoroughly mix in compost 12 inches deep.
4. Remove soil from upper part of first trench and place at far end of bed.
5. Loosen soil an additional 12 inches.
6. Dig out upper part of second trench and throw forward into upper, open part of first trench.
7. Loosen lower part of second trench.
8. Continue "double-digging" process (repeating steps 4 and 5) for remaining trenches.
9. Place soil in mound at end of bed into open, upper part of last trench.
10. Shape bed. Then spread any fertilizers needed evenly over entire area and sift in 2-3 inches deep with a spading fork: the completed "double-dug" bed.

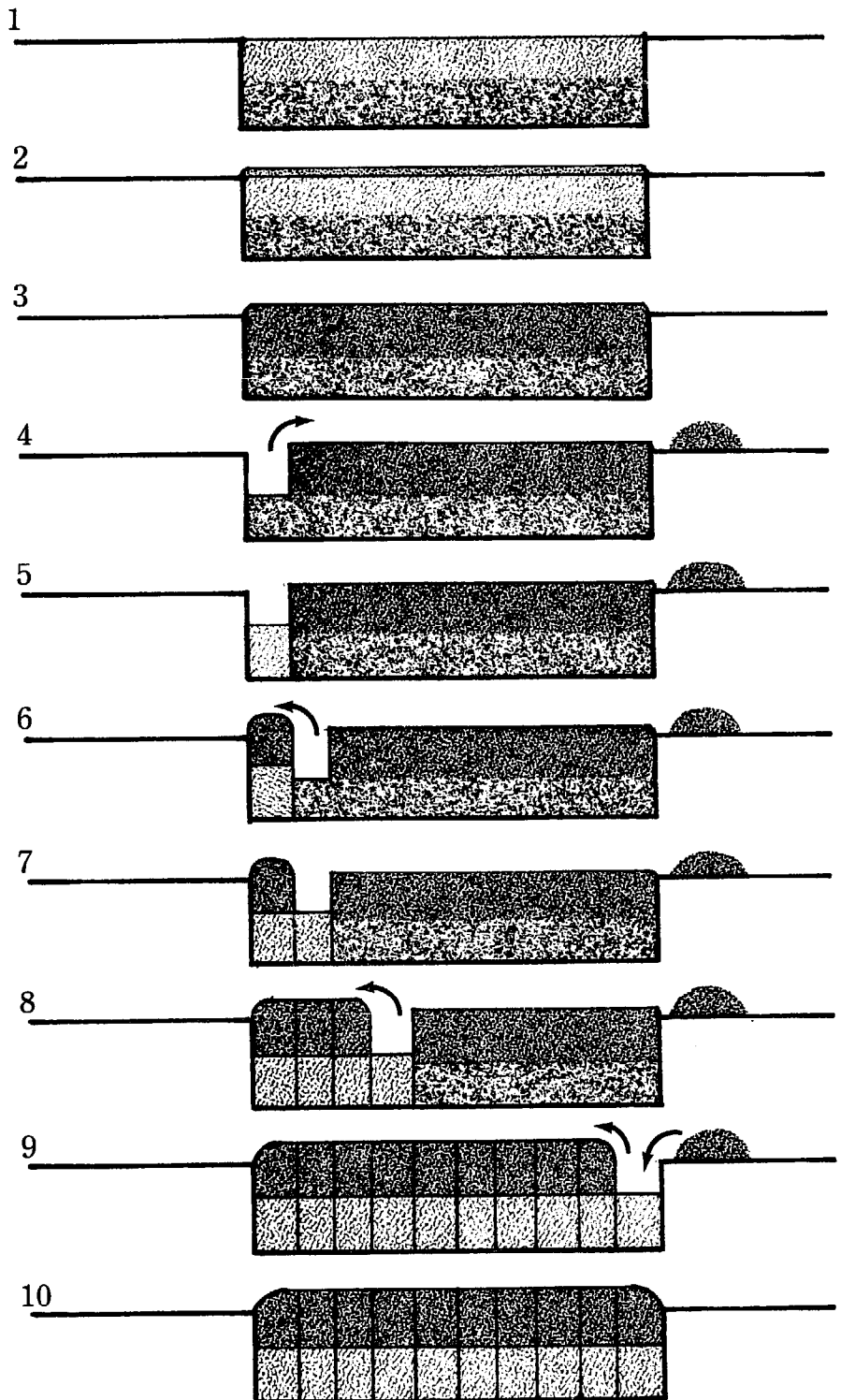

ONGOING DOUBLE-DIG

1. Bed shown after harvest with slightly raised mound of partially recompact soil and residual compost. After soil is lightly moist, preloosen and weed entire area to be dug 12 inches deep with a spading fork.
2. Remove soil from upper part of first trench and place at far end of bed.
3. Loosen soil an additional 12 inches.
4. Dig out upper part of second trench and throw forward into upper, open part of first trench.
5. Loosen lower part of second trench.
6. Continue "double-digging" process (repeating steps 4 and 5) for remaining trenches.
7. Place soil in mound at end of bed into open, upper part of last trench.
8. Shape bed. Spread 1-inch layer of compost and any fertilizers needed evenly over entire area. Sift in compost and any fertilizers 2-3 inches deep with a spading fork.

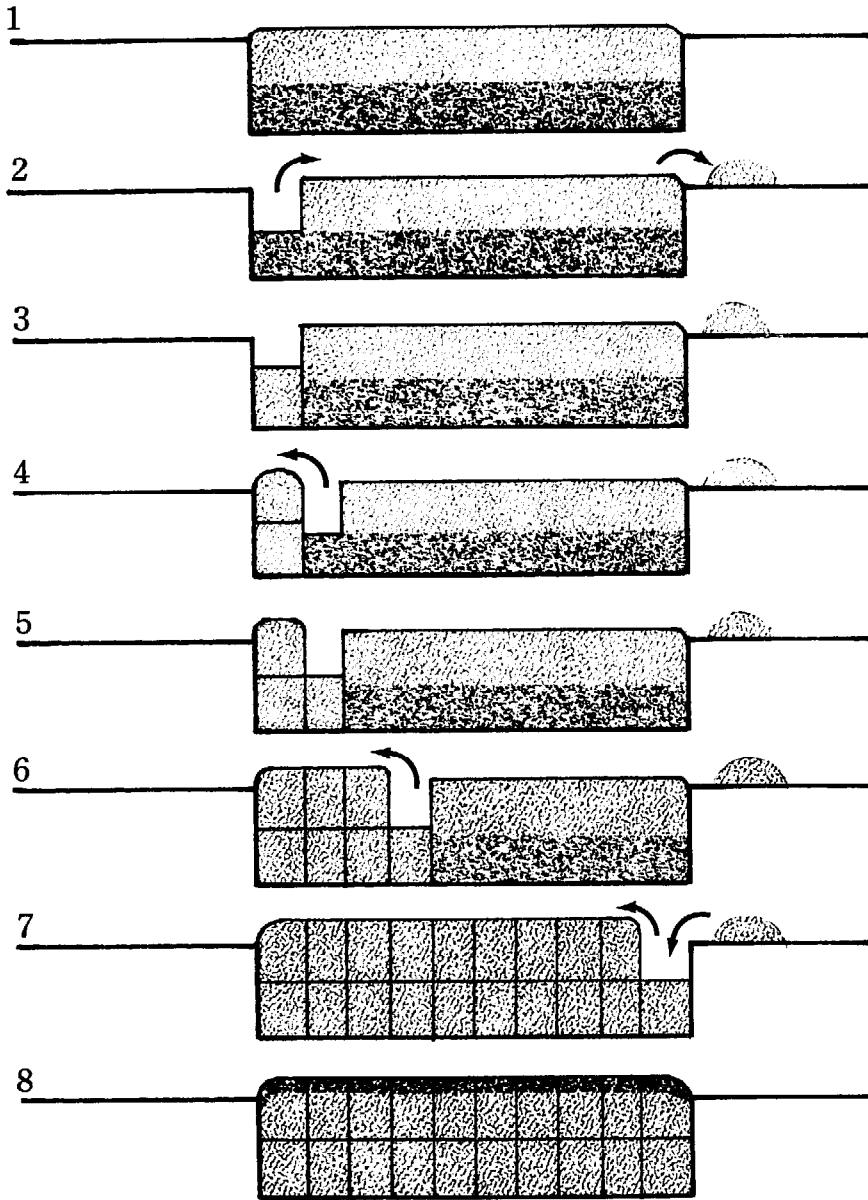

THE COMPLETE TEXTURIZING DOUBLE-DIG

1. After soil is lightly moist, pre-loosen and weed entire area to be dug 12 inches deep with a spading fork.
2. Spread 1-1/2-2 inch layer of compost over entire area to be dug (after mixing in a 1-inch layer of sand—optional—12 inches deep).
3. Thoroughly mix in compost 12 inches deep.
4. Remove soil from upper part of first trench and place at far end of bed.
5. Loosen soil an additional 12 inches.
6. Spread 1-1/2-2 inch layer of compost on top of loosened soil in lower first trench.
7. Thoroughly mix in compost on top of lower first trench 12 inches deep.
8. Dig out upper part of second trench and throw forward into upper, open part of first trench.
9. Loosen lower part of second trench.
10. Spread 1-1/2-2 inch layer of compost on top of loosened soil in lower second trench.
11. Thoroughly mix in compost on top of lower second trench 12 inches deep.

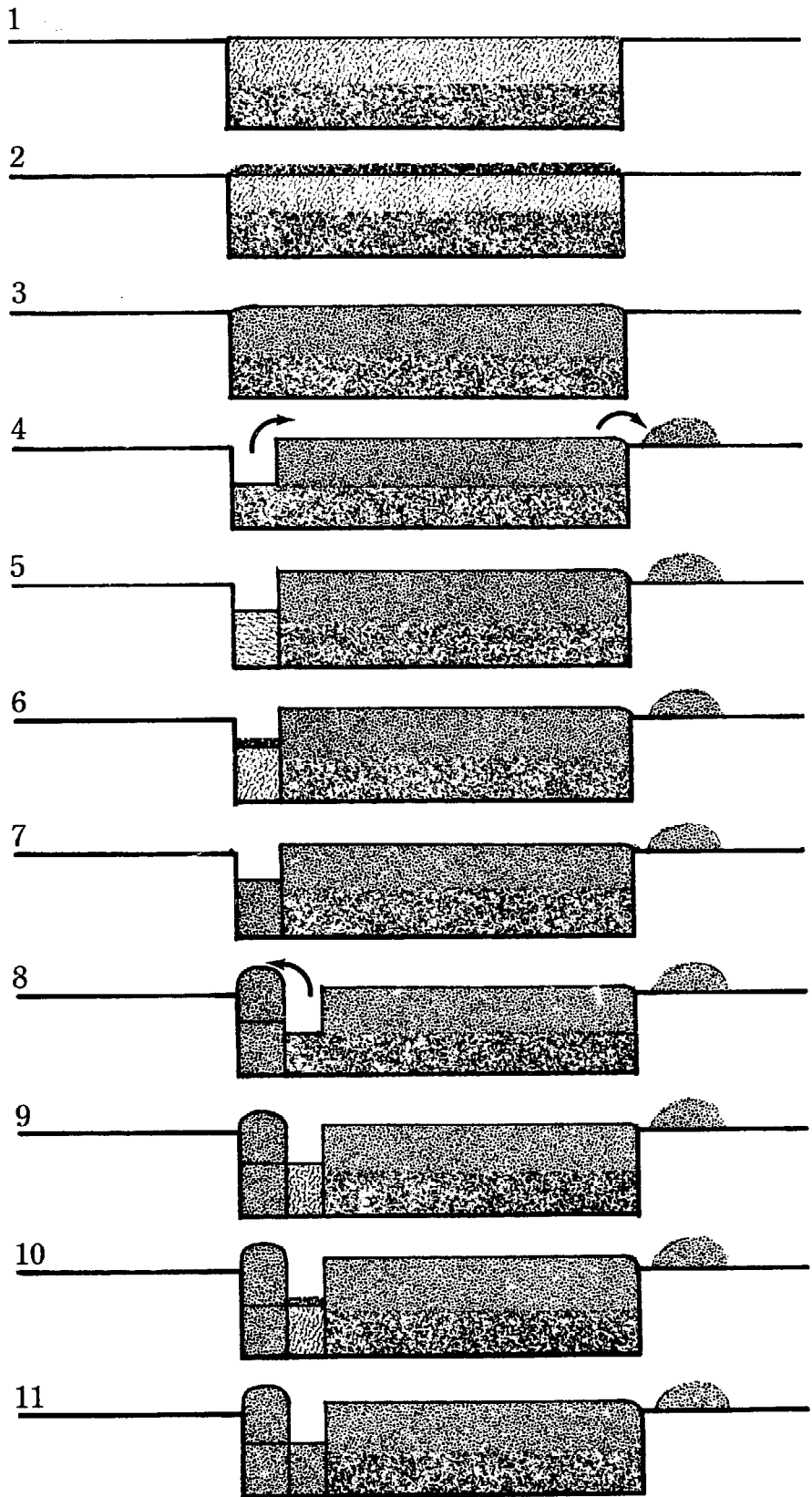

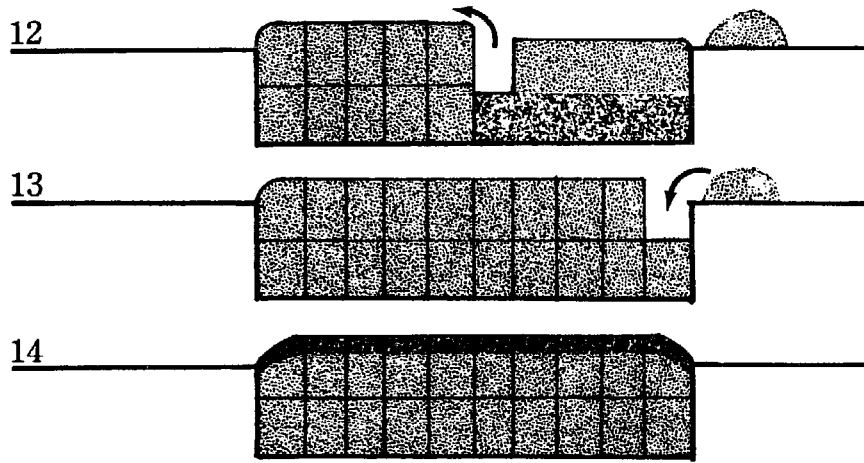

12. Continue complete texturizing "double-digging" process (repeat steps 8 through 11) for remaining trenches.
13. Place soil in mound at end of bed into open, upper part of last trench.
14. Shape bed. Then spread any fertilizers needed evenly over entire area and sift in 2-3 inches deep with a spading fork: the completed "complete texturizing 'double-dug'" bed.

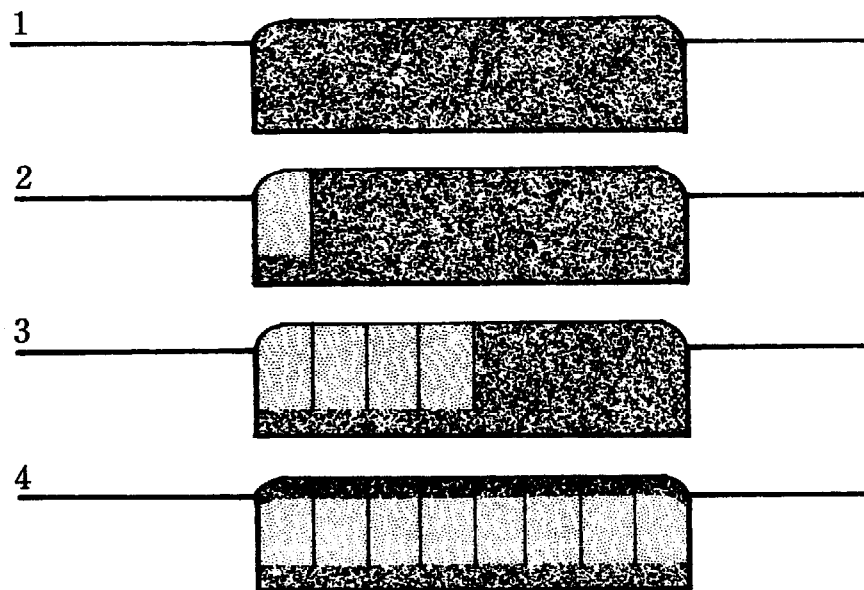

THE U-BAR DIG

1. After harvest, if necessary, weed entire slightly raised bed.
2. After soil is lightly moist, begin U-barring soil along length of bed. No digging board is used. soil will be loosened 3/4 as deep as in double-dig.
3. Continue U-barring until bed is complete. Two or three U-barrings along the length of the bed may be necessary depending on the width of the bed. The U-bar is 2 feet wide and loosens the soil 2-2-1/2 feet wide. See photo on page 158.
4. Break up any remaining large clumps with a spading fork. Shape bed. Then spread compost and any fertilizers needed evenly over entire area and sift in 2-3 inches deep with a spading fork.

Once the bed is prepared, you will find great advantages in its width. The distance between the tips of your fingers and nose is about 3 feet when your arm is extended. This means a 3-5 foot wide bed can be fertilized, planted, weeded and harvested from each side with relative ease. Insects can be controlled in the same way without walking on the beds. A 3-5 foot width also allows a good mini-climate to develop under closely

SELECTED VEGETABLE ROOT SYSTEMS SHOWN IN SCALE

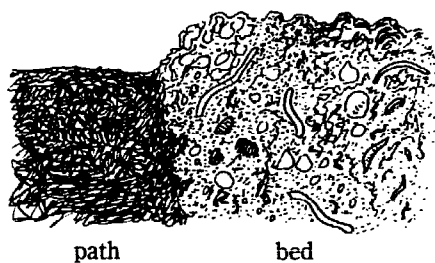
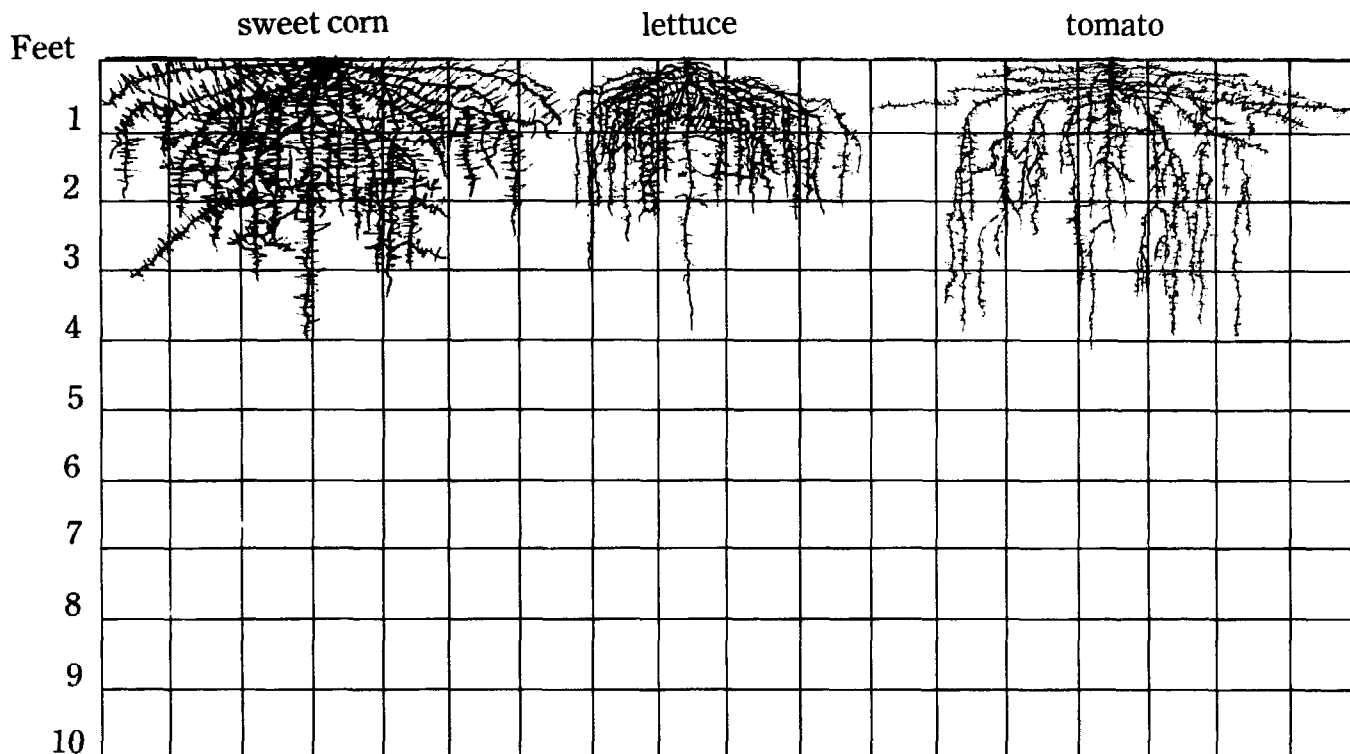

path bed

Soil in path is subject to compaction, soil in bed remains loose.

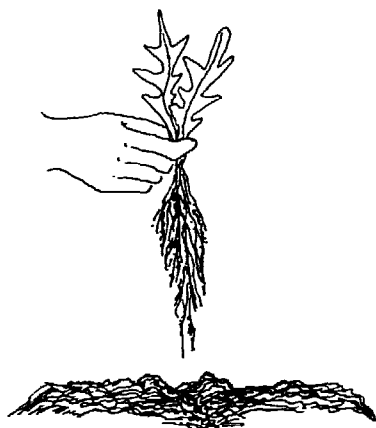

The loosened soil of the planting bed makes weeding easier. The entire weed root usually comes out intact.

spaced plants. You may wish to use a narrower bed 1-1/2 to 2-1/2 feet wide for plants which are supported by stakes, such as tomatoes, pole beans and pole peas for easier harvesting. Normally, one does not step on the plant beds once they have been prepared. To do so compacts the soil and makes it more difficult for the plants to grow. If the bed must be walked on, use the double-digging board. This will displace your weight over a large area and minimize the damage. Plants obtain much of their water and nutriment through the contact of their root hairs with the soil. If the plants do not develop an abundant supply of root hairs, less water and nutrients are taken in. In looser soil the root hairs are more numerous and vigorous, so keep your soil loose!

When weeding, note that the entire weed root usually comes up out of loosened raised bed soil. This is a welcome change to the weeding process—and, if you get all the root, you will not have to weed as often. Also, you do not need to cultivate the soil of raised beds as much. The *living mulch* shade cover provided by the mature plants helps to keep the soil surface loose. If the soil compacts between the young plants before the microclimate takes effect, you should cultivate.

Once this beautifully alive bed is prepared, it should be kept evenly moist until and after planting so the microbiotic life and plants will stay alive. It should be planted as soon as is convenient, so the plants can take advantage of the new surge of life made possible by the bringing together of the soil, compost, air, water, sun and fertilizers.

carrot

cauliflower

beet

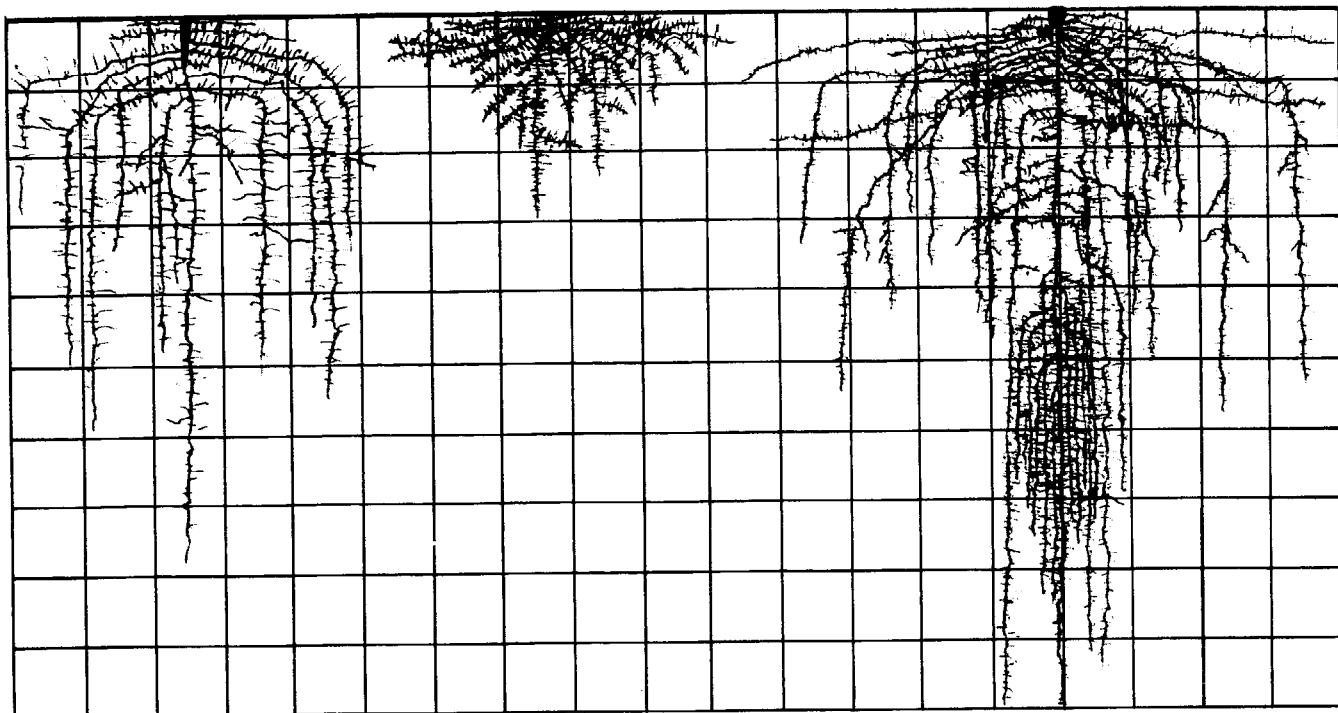

A good growing bed will be 4 to 12 inches higher than the original surface of the soil. A good soil contains 50% air space. (In fact, adequate air is one of the missing ingredients in most soil preparation processes.) The increased air space allows for an increase in the diffusion of oxygen (which the roots and microbes depend on) into the soil, and the diffusion of carbon dioxide (which the leaves depend on) out of the soil. This increased “breathing” ability of a double-dug bed is a key to improved plant health.

Thus, the prepared depth will be as much as 36 inches in clayey soil. A sandy soil will probably not raise as high as clayey soil at first. If the bed raises higher than 10–12 inches as you are double-digging, be sure to level it out with a rake as you go along. Otherwise you will find a very wide and deep trench at the end of the bed. Then you will have to move a large amount of soil from one end of the bed to the other to even it out when you are tired. This would also cause a disproportionate misplacing of top soil into the subsoil area. Whenever you re-dig a bed (after each crop or season), the 24-inch depth of the bed should be measured from the top of the bed, rather than from the path surface. We currently reprepare the soil after each crop. Some people prefer to do this only once each year. As your soil improves, and the large clods disappear, your bed may not raise as high as initially. Do not worry about this. It is just a sign that you and your soil are being successful. The goal of double-digging is not in the height of the bed, but in the looseness and good structure of the soil.



The biodynamic/French intensive method raised bed. A balance between nature's natural stratification and man's shepherding landslide loosening.

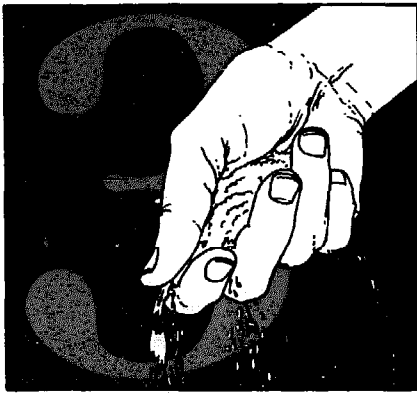

Fertilization



Taking a soil sampling.

If you can, test your soil for nitrogen, phosphorous, potash and pH (the acidity or alkalinity level of your soil) before choosing your fertilizers. The best testing kit to use is the *La Motte kit*^{7a}. It uses large amounts of test liquids to smaller amounts of soil and has large test tubes. All this insures a good “wetting” of the soil being tested and reduces the error margin. We have experienced significant errors sometimes with smaller kits.

To take a soil sample from your yard, use a trowel and take soil from a level 2–6 inches below the surface. Do not handle the soil with your hands. Take samples from 3 to 4 representative areas and mix them together. Make sure organic matter, such as roots are not included in the samples. Also, do not sample for 2 weeks after any fertilizers, manure or compost has been added to the area. The samples should normally be taken at the end of a season and just before the next one. You will need 4 heaping tablespoons of soil total. Mix the samples together well before beginning the tests. Remember that soil tests can save you a lot of money, since they will often indicate that the soil contains some of the nutriment needed for good plant growth. Let the samples dry in a small paper bag in indirect sunlight—*not* in the sun or an oven. You are now ready to begin the test. Use the easy to understand instructions included with the kit. Record your results on a photocopy of the chart on the following page.

The La Motte soil test kit.

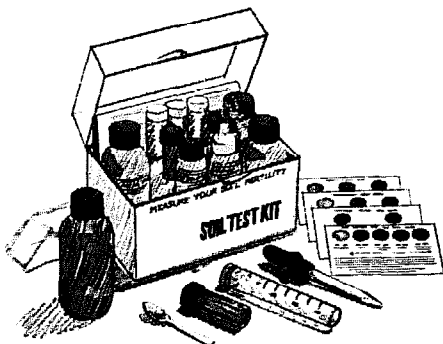

Once you have completed the test, use the information on the following pages to determine a fertilization program.

pH

Most vegetables grow best in a slightly acidic pH of 6.5. A range of 6.0 to 7.5 is fine for most crops. When adequate organic matter is used, we have found crops will better tolerate a wider range of acidity or alkalinity.

7a. La Motte Chemical Products, Box 329, Chestertown, Maryland 21620

NITROGEN (N), PHOSPHORUS (P) AND POTASH (K)

Pounds of fertilizer to add per 100 square feet. Pounds of *pure* nutriment added given in parentheses.

Test Rating	Nitrogen (N)	Phosphorus (P)	Potash (K)
<i>Very High</i> ⁸	(.1) .75 lb. blood meal or 1 lb. fish meal or 2 lbs. cottonseed meal or .75 lb. hoof and horn	(.2) 1 lb. bone or 2 lb. phosphate rock or soft phosphate	(.15) 1 lb. kelp meal ⁹ or 2 lb. greensand or 3 lb. crushed granite
<i>High</i> ⁸	(.2) 1.5 lbs. blood meal or 2 lbs. fish meal or 4 lbs. cottonseed meal or 1.5 lbs. hoof and horn meal	(.3) 1.5 lb. bone or 3 lbs. phosphate rock	(.2) 1 lb. kelp plus .66 lb. greensand or 1 lb. granite; or 2.66 lb. greensand; or 4 lbs. granite
<i>Medium High</i>	(.25) 2 lbs. blood meal or 2.5 lbs. fish meal or 5 lbs. cottonseed meal or 2 lbs. hoof and horn meal	(.35) 1.75 lbs. bone or 3.5 lbs. phosphate rock	(.25) 1 lb. kelp plus 1.33 lb. greensand or 2 lb. granite; or 3.33 lbs. greensand; or 5 lbs. granite
<i>Medium</i>	(.3) 2.25 lbs. blood meal or 3 lbs. fish meal or 6 lbs. cottonseed meal or 2.25 lbs. hoof and horn meal	(.4) 2 lbs. bone or 4 lbs. phosphate rock	(.3) 1 lb. kelp plus 2 lbs. greensand or 3 lbs. granite; or 4 lbs. greensand; or 6 lbs. granite
<i>Medium Low</i>	(.35) 2.75 lbs. blood meal or 3.5 lbs. fish meal or 7 lbs. cottonseed meal or 2.75 lbs. hoof and horn meal	(.45) 2.25 lbs. bone or 4.5 lbs. phosphate rock	(.35) 1 lb. kelp plus 2.66 lbs. greensand or 4 lbs. granite; or 4.66 lbs. greensand; or 7 lbs. granite
<i>Low</i>	(.4) 3 lbs. blood meal or 4 lbs. fish meal or 8 lbs. cottonseed meal or 3 lbs. hoof and horn meal	(.5) 2.5 lbs. bone or 5 lbs. phosphate rock	(.4) 1 lb. kelp plus 3.33 lbs. greensand or 5 lbs. granite; or 5.33 lbs. greensand; or 8 lbs. granite
<i>Very Low</i>	(.5) 4 lbs. blood meal or 5 lbs. fish meal or 10 lbs. cottonseed meal or 4 lbs. hoof and horn meal	(.6) 3 lbs. bone or 6 lbs. phosphate rock	(.5) 1 lb. kelp plus 4 lbs. greensand or 6 lbs. granite; or 6.66 lbs. greensand; or 10 lbs. granite

8. Addition of nutriment at these levels is optimal.

9. Because of the growth hormones kelp meal contains, do not add more than 1 pound per 100 square feet per year.

To lower the pH one point, you might try 2 cubic feet decomposed pine needles, oakleaf mold, decomposed oak or pine sawdust, compost, or manure per 100 square feet (about 68 pounds, or a 1/4 inch layer over the area to be planted). Optimally, do not use more than 4 cubic feet of manure per year (about 136 pounds, or a 1/2 inch layer). This is because the salts from the urine it contains can build up in the soil over time. It is best to use manure which contains little undecomposed sawdust. Undecomposed sawdust steals nitrogen from the plants during the period in which it breaks down into compost.

To raise the pH one point use the following amount of Dolomitic Lime per 100 square feet:

- Light, sandy soil—5 pounds
- Sandy Loam—7 pounds
- Loam (good soil)—10 pounds

The table on pages 24-25 describes the nutriment content of many commonly used organic fertilizers. You can also use this information with the pure nutriment listings on page 22 to determine the amounts of each fertilizer to add. In your calculations, you may also *subtract* nutriment added in the form of manure (if any) during the pH modification. Be careful about subtracting nitrogen, however, as much aged manure in actuality often contains little nitrogen and a substantial amount of nitrogen-borrowing sawdust. If you use a lot of manure containing sawdust, as a pH modifier or soil texturizer, you may want to add about 1 extra pound of blood, fish or hoof and horn meal or 2 extra pounds cottonseed meal per 100 square feet. You may also subtract nutriment added in the form of compost, if you have performed a soil test on the compost and know its nutriment values. Notice that the release times are different for each fertilizer. Sometimes we use a combination of blood meal (which releases over a 3-4 month period), fish meal (which releases over a 6-8 month period), and hoof and horn meal (which releases over a 12 month period). In this way, nitrogen release is spread over a longer period of time. For example, if a soil test indicated we needed 0.4 pounds of pure nitrogen per 100 square feet, we might add:

1 pound blood meal .125 pounds N (12.5%)	&	1 pound fish meal .105 pounds N (10.5%)	&	1 pound hoof and horn meal .140 pounds N (14%)												
<table style="width: 100%; border-collapse: collapse;"> <tr> <td style="width: 33%; border-bottom: 1px solid black;">.125</td> <td style="width: 33%;"></td> <td style="width: 33%;"></td> </tr> <tr> <td style="border-bottom: 1px solid black;">.105</td> <td></td> <td></td> </tr> <tr> <td style="border-bottom: 1px solid black;">.140</td> <td></td> <td></td> </tr> <tr> <td colspan="3" style="padding-top: 5px;">.370 pounds N or approximately the .4 pounds N needed</td> </tr> </table>					.125			.105			.140			.370 pounds N or approximately the .4 pounds N needed		
.125																
.105																
.140																
.370 pounds N or approximately the .4 pounds N needed																

ANALYSIS OF RECOMMENDED ORGANIC SOIL AMENDMENTS

N, P and K refer to the three main nutrients plants need: NITROGEN for green growth and in compost piles to speed decomposition, PHOSPHORUS for root growth, disease resistance, and production of good fruits, vegetables, and flowers, and POTASH for strong stems, vigorous roots and increased disease resistance. Plants also need HUMUS which is provided by decomposed organic matter such as compost and manure. For information on the application rates for organic fertilizers when a soil test is not used, see the Fertilizer Program Table which follows this table.

NITROGEN

Cottonseed Meal

3-5% N 2% P 1% K Lasts 4-6 months. Use up to 10 lbs./100 sq. ft. Fair source of nitrogen. Especially good for citrus and azaleas because it has an acidifying effect on soil.

Blood Meal

12.5% N 1.3% P .7% K Lasts 3-4 months. Use up to 5 lbs./100 sq. ft. A quick acting source of nitrogen, good for slow compost piles. Can burn plants if using more than 3 lbs. per 100 square feet. If using higher amounts, wait 2 weeks to plant.

Hoof & Horn Meal

14% N 2% P 0% K Lasts 12 months. Use up to 4 lbs./100 sq. ft. Highest nitrogen source. Slow releasing: no noticeable results for 4-6 weeks.

Fish Meal

10.5% N 6% P 0% K Lasts 6-8 months. Use up to 5 lbs./100 sq. ft. Good combined nitrogen and phosphorus source.

PHOSPHORUS

Bone Meal

3% N 20% P 0% K Lasts 6 months to 1 year. Use up to 5 lbs./100 sq. ft. Excellent source of phosphorus. Especially good on roses, around bulbs, and around fruit trees and flower beds.

Phosphate Rock

33% P Lasts 3-5 years. Use up to 10 lbs./100 sq. ft. Very slow releasing.

Soft Phosphate

18% P Lasts 2-3 years. Use up to 10 lbs./100 sq. ft. Clay base makes it more available to plants than the phosphorus in phosphate rock, though the two are used interchangeably.

POTASH

Kelp Meal (Seaweed)

1% N 0% P 12% K 33% trace minerals. Lasts 6 months to 1 year. Excellent source of potash, iron, and other minerals. Reportedly, the proper amount of trace minerals in the soil may mean only one-half the fertilizers will be needed for the same growth and yield! Kelp meal is also a natural fungicide. Use sparingly (up to 1 pound per 100 square feet per year) because it contains growth hormones.

Wood Ashes

1-10% K Lasts 6 months. Use up to 1-2 lbs./100 sq. ft. Ashes from wood are high in potash and help repel root maggots. Ashes also have an alkaline effect of the soil, so use them with care if your soil is already alkaline. Black wood ash is best.

Crushed Granite

3-5% K Lasts up to 10 years. Use up to 10 lbs./100 sq. ft. Good slow-releasing source of potash and trace minerals.

Greensand

0%N 1.5% P 6.7% K Use interchangeably with crushed granite.

SOIL pH SCALE

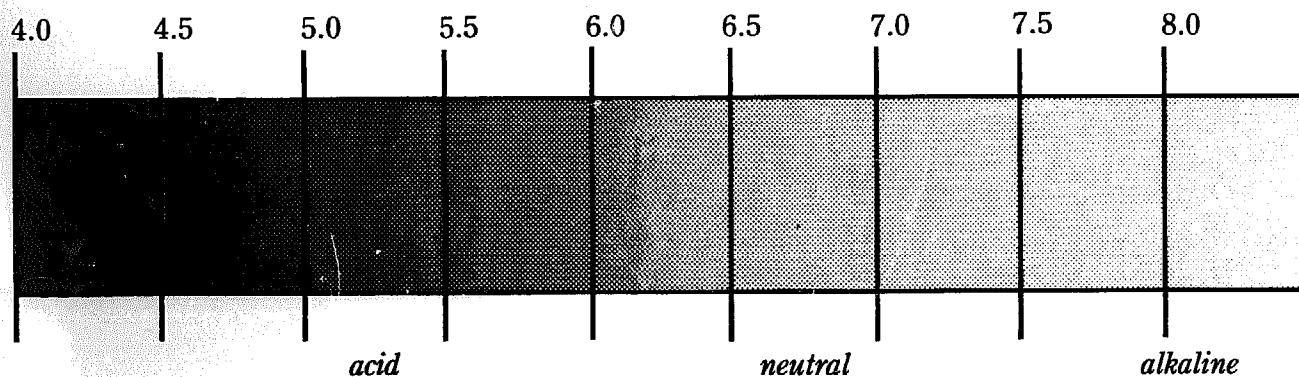

A pH reading tells you the relative acidity/alkalinity of the soil. Most vegetables will grow well in a range from 6.0 to 7.5. 6.5 is probably the best all round pH. In extremely acid or extremely alkaline soils valuable nutrients are tied up and thus unavailable to the plants. An acid soil can be sweetened by the addition of dolomite lime. An alkaline soil can be brought closer to neutral by compost or manure. Compost has a buffering effect on soil, correcting both acid and alkaline conditions.

SOIL MODIFIERS

Dolomitic Lime

A good source of calcium and magnesium to be used in acid soils. Do not use lime to "sweeten" the compost pile; it results in a serious loss of nitrogen. You can discourage flies and odors with a layer of soil.

Gypsum

Gypsum is not needed by organic gardeners. It is normally used commercially in soils made impermeable by excess exchangeable sodium.

"Clodbuster"

15% Humic Acid 5.5 pH Lasts 1 year. It is crushed "rock" deposits made up of ancient plant and animal remains. Helps make soil less alkaline and releases nutrients tied up in the soil. Use up to 1 lb./100 sq. ft.

Crushed Eggshells

High in calcium. Especially good for cabbage family crops. Help break up clay and release nutrients tied up in alkaline soils. Use up to 2 lbs./100 sq. ft.

Manure

A good source of humus in the garden. Nutrient levels depend on proper handling and the amount of straw or sawdust present. Large amounts of bedding may add up to 2 years to the decomposition time.

50 pounds of manure (approx. 2 cubic feet dry weight) applied per 100 square feet can lower the pH *one* point.

Horse	.7%N	.3%P	.6%K	Age 2-3 months
Rabbit	2.4	1.4	.6	Age 2 months
Chicken	1.1	.8	.5	Age 2 months
Steer	.7	.3	.4	Age 2 years

Compost

Good compost is the most important part of the garden. It aerates soil, breaks up clay, binds together sand, improves drainage, prevents erosion, neutralizes toxins, holds precious moisture, releases essential nutrients, and feeds the microbiotic life of the soil, creating healthy conditions for natural antibiotics, worms and beneficial fungi. Use an inch of compost each year (8 cu. ft./100 sq. ft.) or up to three inches in a first-year garden.

What a Soil Test Will Not Tell You

A soil test is a limited tool and points out deficiencies of major nutrients. If you simply cannot get plants to come up in your garden, a soil test may not give you the solution. Plants lacking only major nutrients will usually grow and show their deficiency in yellowed leaves, stunted growth, purple veins or any of a number of signs.

When seeds fail to germinate, or plants hardly grow at all after germination, some common causes are:

1. Use of redwood compost. As a mulch or soil conditioner redwood compost is widely available, but it does contain growth inhibitors that can keep seeds from coming up or keep plants from growing well. (This is how the redwood trees reduce competition.)
2. Planting too early or too late in the season. Seeds and seedlings will wait for the right temperature and length of day to start and continue growth.
3. Use of weed killers or soil sterilants. Many weed killers are short-lived but they can limit growth in a garden long after they are supposed to degrade. Soil sterilants can last for two years. Some people use them to minimize or eliminate yard care, but they can continue to have an effect after the users move away and you move in. There is never any reason to use these poisons in your yard. Also, dumping excess motor oil can destroy valuable growing areas. Take it to a service station for recycling.
4. Use of old seeds. Check with your source.

More Sustainable Fertilization

It should be the goal of each gardener over time to use less and less fertilizer that is brought in from outside his or her own garden area. This will be especially true as such amendments

GENERAL FERTILIZER PROGRAM—PER CROP PER 100 SQUARE FEET

Assuming no soil test is performed

Functions	Sources	1st & 2nd yr. Assuming poor soil	3rd & 4th yr. Or 1st & 2nd yr. in average soil	5th yr. Or 1st year in good soil	Maintenance Every year thereafter ¹²	Add to Soil <i>before or after</i> Double-Dig		
Nitrogen	Cottonseed Meal	10 lbs.	6 lbs.	3 lbs.	—	After		
	(or Fish Meal)	(5 lbs.)	(3 lbs.)	(1-2 lbs.)	—			
	(or Blood Meal) ¹⁰	(5 lbs.)	(3 lbs.)	(1-2 lbs.)	—			
	(or Hoof & Horn Meal)	(4 lbs.)	(2 lbs.)	(1 lb.)	—			
Phosphorus	Bone Meal	4-5 lbs.	2 lbs.	2 lbs.	2 lbs.	After		
	(or Phosphate Rock)	(10 lbs.)	(5 lbs.)	(3 lbs.)	—			
	(or Soft Phosphate)	(10 lbs.)	(5 lbs.)	(3 lbs.)	—			
Potash and Trace Minerals	Kelp Meal	1 lb.	1 lb.	1 lb.	1/4 lb. ¹³	After		
	and Wood Ash	2 lbs.	1 lb.	1 lb.	1 lb.			
	(or Granite)	(10 lbs.)	(5 lbs.)	(3 lbs.)	—			
	(or Greensand)	(10 lbs.)	(5 lbs.)	(3 lbs.)	—			
Texturizer,	Manure	2 cu. ft.	2 cu. ft.	2 cu. ft.	2 cu. ft.	After		
Microbiotic Life, Humus,		Compost	Up to 1 cu. yd. (1st crop),	8 cu. ft.	8 cu. ft.		8 cu. ft.	After for best results ^{13a}
Multiple Nutriment			8 cu. ft. (ea. addit. crop) ¹¹					
Calcium	Eggshells	2 lbs.	1 lb.	as available up to 1/2 lb.		After		
Humic Acid	"Clodbuster"	1 lb.	—	—	—	After		

10. Do not plant for 2 weeks if using more than 3 pounds blood meal per 100 sq. ft. It can burn the plants during this time since it releases nitrogen rapidly at first.

11. 1 cubic yard equals 27 cubic feet. 1 cubic yard will cover 100 sq. ft. 3" deep. 8 cubic feet will cover 100 sq. ft. 1" deep. 2 cubic feet will cover 100 sq. ft. 1/4" deep. You can substitute manure for compost the first year if you do not have a ready supply of compost.

12. Beginning the sixth year your legumes, cover crops, and recycled plant materials (in the form of compost) can provide most of your nitrogen, phosphorous and potash. Double-check this periodically with a soil test.

13. For trace minerals: kelp meal is 33% trace minerals.

13a. Except for first double-dig when it is added *before*.

become more scarce when divided among the increased number of people using them. There are at least three ways to create a "closed system" garden:

1. Use most of the food you grow *at home*, so that all the residues can be returned to your soil. "Export" as little as possible of your valuable soil resources.
2. Grow some trees. Their deep root systems will bring up nutrients from deep down in the subsoil, and even further, into the tree leaves. These materials would not otherwise become available for use as plant food.
3. "Grow" your own fertilizers by raising plants strictly for making compost, which concentrate the nutrients required in a form the plants can use. For beginning information on identifying the plants you may utilize see *The Organic Method Primer* and *Weeds and What They Tell* (see Bibliography).



To revitalize an old lawn—Use 1.5 lbs. hoof and horn meal, 2 lbs. bone meal, and 1 lb. kelp meal per 100 sq. ft. Apply in spring and water well twice a week for 2 weeks. You should see the results in 6 weeks. (For an additional approach to lawns, see Ecology Action's booklet on the "Self-Fertilizing Herbal Lawn".)

Fruit trees—Use 1 heaping tablespoon blood meal per foot of height, up to 2 lbs. of bone meal per full grown tree, and a light sprinkling of kelp meal (up to 1/4 lb. per full grown tree) around the drip line. Apply in spring when leaves first start to



(Left) raking soil outward from inside for lip.
(Right) raking soil up from side for lip.

appear and water in well. Cover crops and compost mulches are also excellent for full grown trees.

Citrus trees—Same as fruit trees with the addition of 5–8 lbs. phosphate rock and 2 lbs. of “Clodbuster” applied to full grown trees once every 3–5 years. Line the planting hole with crushed red rock for a long-lasting source of iron.

The bed should be shaped before the fertilizers are added. If your soil is in good condition, use a rake to shape the bed into a mound as shown below. The soil will not easily wash off or erode from beds shaped in this manner, once the texture and structure of the soil are improved. While you are still improving the texture of heavy clay soils, you may want to form a *flat-topped bed* with a small lip on the outer edges of the bed instead. This will minimize watering-caused erosion. It is also desirable to provide the sides of the beds with about a 30 degree slope. A sharper angle will encourage erosion. When the bed has been shaped, tamp the soil down before planting by placing the digging board on all parts of the bed and walking across the board. If a lip is added to the bed, it is done after the soil is tamped down.

Add the fertilizers and other additives one at a time. Avoid windy days and hold fertilizer close to the bed surface when spreading. Use the different colors to help you. The soil is darkish so sprinkle a light colored fertilizer (such as bone meal) on first, then a dark one (such as kelp meal) and so on. It is better to under apply the fertilizers because you can go back over the bed afterwards to spread any left over but it is difficult to pick

(Left) casting fertilizer onto bed surface.
(Right) sifting in fertilizers with spading fork.



up fertilizer if too much falls in one place. Aim for even distribution. After all are applied, sift in the fertilizers and other additives by inserting a spading fork 2-3 inches deep and lifting it upwards with a slight jiggling motion.

Several things should be noted about the special nature of the nutriment added in the upper 2 to 3 inches of the soil.

- 1) The nutriment is added to the upper layer as in nature.
- 2) The nutriment percolates downward with the root growth of the plant.
- 3) Organic fertilizers break down more slowly than most chemical fertilizers and therefore remain available to the plants for a longer period of time.

The bone meal often used in the upper layer provides quality growth-producing phosphorus and calcium to the plants plus an important animal essence. Wood ash (preferably black wood ash) provides strength, plant essence, aids in insect control and is a flavor enhancer for vegetables, especially lettuce and tomatoes. Black wood ash is produced from a controlled, soil covered, slow-burning fire built during a soft drizzle or rain. This ash is higher in potash and other minerals because they do not readily escape into the atmosphere as the wood is consumed by fire. Wood ashes should be stored in a tight container until they are used. Exposure to light and air will destroy much of their nutriment value. Ashes from a fireplace may be used if they are from wood and not paper.

Manure is a microbiotic life stimulant and an animal and plant essence that has been "composted" both inside the animal and outside in a curing pile. Avoid using too much manure because steer and horse manures (which do not contain much sawdust or straw) are generally 2 parts nitrogen to 1 part phosphorus and 1 part potash, and contain an excess of salts. This is an unbalanced ratio in favor of nitrogen which in time results in weak and rank plant growth more susceptible to disease and insect attack. A ratio of 1 part nitrogen to 1 part phosphorus to 1 part potash is better. The biodynamic/French intensive method always uses as much or more phosphorus and potash as nitrogen in the fertilization process. This approach results in stronger and healthier plants. The use of a large amount of manure is recommended as an alternative to compost only when compost is not available. This is one way in which the combined biodynamic/French intensive techniques differ from the initial French intensive dependence on horse manure.

The heavy emphasis which the biodynamic/French intensive method places on compost should be noted. The demand for most organic fertilizers is going up while the supply available to each person in the world is decreasing. Soon, few fertilizers will be available at reasonable prices. Also, the materials used for the production of chemical fertilizers are becoming less available. Materials for biodynamic/French intensive method compost, on the other hand, consist of plants, animals and earth which can be produced in a sustained way by *living* soils. These compost-

able materials can be produced indefinitely if we take care of our soils and do not exhaust them. In fact, 96% of the total amount of nutrients needed for good plant growth processes can be obtained as plant and microbiotic life forms work on elements already in the air.¹⁴ Soil and compost can provide the rest.

The biodynamic/French intensive method has its roots 5,000 years into the past in Chinese intensive agriculture, 2,000 years

14. Joseph A. Cocannouer, *Farming With Nature*, University of Oklahoma Press, Norman, Oklahoma, 1954, p. 50.

The Balanced Eco-system. Nothing happens in living nature that is not in relation to the whole.



into the past in the Greek use of raised beds and more recently in European farming. Similar practices are still used today in the native agriculture of many countries, such as Guatemala. "The method" will extend its roots into a future where environmentally balanced resource usage is of the utmost importance. Compost made according to "the method" (the process will be discussed in the chapter on Compost) is usually high in phosphorous, potash and trace minerals. It also contains a small amount of nitrogen and, when made with nitrogen-fixing cover crops, can be high in nitrogen. Nitrogen is also obtained from the thin layer of manure added during the fertilization stage. Lastly, nitrogen is obtained for the garden system by the periodic growing of legumes such as peas, beans, clover, alfalfa and vetch in the planting beds. The nitrogen that they fix from the air is released in the decomposition of their roots, stems and leaves. Compost, bone meal, manure, wood ash, nitrogen from legumes and nutrients from the growth of certain kinds of weeds in the beds (which is discussed in the chapter on Companion Planting) make up the 4% of the plant diet not provided by the air.

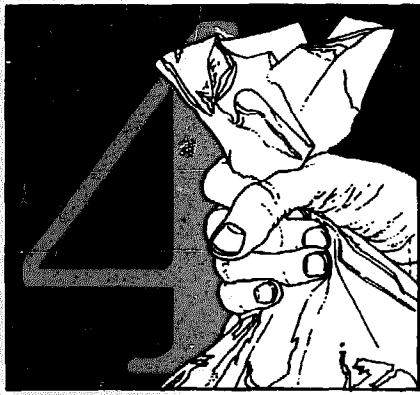

Compost

In nature, living things die and their death allows life to be reborn. Both animals and plants die on forest floors and in meadows to be composted by time, water, microorganisms, sun and air to produce a soil improved in texture and nutriment. Organic plant raising follows nature's example. Leaves, grass, weeds, prunings, spiders, birds, trees and plants should be returned to the soil and reused—not thrown away. Composting is an important way to recycle such elements as carbon, nitrogen, oxygen, sulfur, calcium, iron, phosphorus, potash, trace minerals and microorganisms. These elements are all necessary to maintain the biological cycles of life that exist in nature. All too often we participate instead in agricultural stripmining.

Composting in nature occurs in at least three ways: 1) In the form of manures, which are plant and animal foods composted inside the body of an animal (including earthworms) and then further aged outside the animal by the heat of fermentation. Earthworms are especially good composters. Their castings are 5 times richer in nitrogen, 2 times richer in exchangeable calcium, 7 times richer in available phosphorus and 11 times richer in available potassium than the soil they inhabit. 2) In the form of animal and plant bodies which decay on top of the soil in nature and in compost piles. 3) In the form of roots, root hairs and microbotic life which remain and decay beneath the surface of the soil after harvesting. It is estimated that one rye plant in good soil grows 3 miles of roots a day, 387 miles of roots in a season, and 6,603 miles of root hairs each season!¹⁵

Compost has a dual function. It improves the structure of the soil. This means the soil will be easier to work, will have good aeration and water retention characteristics and will be resistant to erosion. Compost also provides *nutriments* for plant growth, and its humic acid makes nutriments in the soil (espe-

15. Helen Philbrick and Richard B. Gregg, *Companion Plants and How To Use Them*, The Devin-Adair Company, Old Greenwich, Connecticut, 1966, pp. 75-76.

A CROSS SECTION OF THE FOREST FLOOR

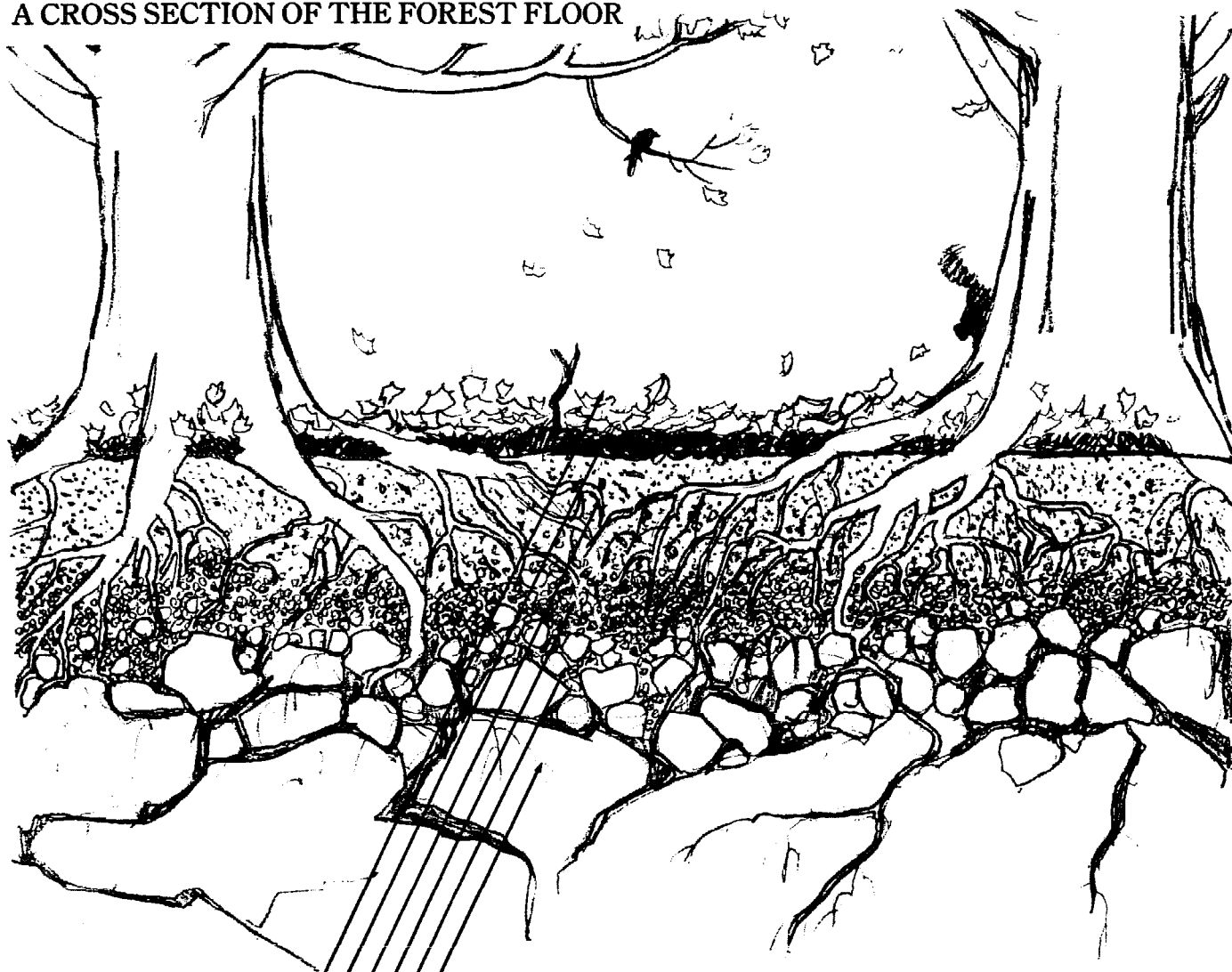

fresh materials
breaking down materials
topsoil
fine rock particles
larger rock pieces
rock

cially insoluble ones, such as bone meal) more available to plants. Less nutriment leaches out in a soil with adequate organic matter.

Improved texture, structure, and nourishment produce a healthy soil. A healthy soil produces healthy plants better able to resist insect and disease attacks due in part to a higher protein content in the plants. Most insects look for sick plants to eat. The best way to control insects and diseases in plants is with a living, healthy soil rather than with poisons which kill this beneficial soil life.

Compost keeps soil at maximum health with a minimum of expense. Generally, it is unnecessary to buy fertilizers in order to be able to grow with nature. At first, organic fertilizers may have to be purchased so that the soil can be brought to a satisfactory level of fertility in a short period of time. Once this has been done, the health of the soil can be maintained with compost, crop rotation, and small amounts of manure, bone meal and wood ash.

Compost is created from the decomposition and recombining of various forms of plant and animal life, such as leaves, grass, wood, garbage, natural fiber clothes, hair and bones. These materials are *organic matter*. Organic matter is

only a small fraction of the total material that makes up the soil—between 1 and 8%. Yet it is absolutely essential to the sustenance of soil life and fertility. Organic matter refers to dead plant and animal residues of *all* kinds and in *all* stages of breakdown or decay. Inseparable from these decaying dead residues are the living microorganisms which decompose, or digest, them.

Microscopic plant and animal life forms (bacteria, fungi, and actinomycetes) in the soil produce this recombining process. The result is *humus*. Heat energy is liberated during the process and this is the warmth felt in the compost pile. Most of the decomposition involves the formation of carbon dioxide and water as the organic material is broken down. As the available energy is consumed, the microbial activity slows down and their numbers diminish—the pile cools. Most of the remaining organic matter is in the form of *humus compounds*. As humus is formed, nitrogen becomes part of its structure. This stabilizes nitrogen in the soil, because the humus compounds are resistant to decomposition. They are worked on slowly by soil organisms, but the nitrogen and other essential nutrients are protected from too rapid solubility and dissipation.

Humus also acts as a site of nutrient absorption and exchange for plants in the soil. The surfaces of humus particles carry a negative electrical charge. Many of the plant nutrients, such as calcium, phosphorus, and magnesium, carry a positive electrical charge in the soil solution and are thereby attracted and adhere to the surface of humus. Some of the plant nutrients are not positively charged, such as the form of nitrogen that is available to plants. Fortunately, a good supply of these nutrients is safely tucked away in the center of the humus particles as they are being formed in the composting process.

As plant roots push through the soil in search of nutrients, they feed off of the humus. Each plant root is surrounded by a “halo” of hydrogen ions which are a by-product of the roots’ respiration. These hydrogen ions also carry a positive electrical charge. The root actually “bargains” with the humus, exchanging some of its positively charged hydrogen ions with positively charged nutrient ions stuck on to the surface of the humus. An active exchange is set up between humus and roots, the plants “choosing” which nutrients they need to balance their own inner chemistry.

Therefore, humus is the most reliable plant food, as the plants pull off whatever combinations of nutrients they “choose” from its surface. Chemical fertilizers are not as reliable. They are water soluble. Once dissolved in the soil water they are taken up by the plant roots in whatever combination they were added. Thus, if too much of one plant nutrient is added to the soil in this soluble form, too great a proportion of this nutrient will be taken in by the plant. It is

difficult for us to judge what the proper ratio of nutrients is for plants. The plant-humus relationship has evolved over many years.

The beauty of humus is that it feeds the plants with nutrients it picks up on its surface, and also safely stores nutrients in its center in forms which cannot be leached. In the center is much of the remainder of the original nitrogen that was put in the compost pile in the form of grass, kitchen wastes, and so on. The humus was formed by the resynthesizing activity of numerous species of microorganisms feeding off that original "garbage".

The microorganisms in the soil then continue to feed on the humus after the finished compost pile is spread on the soil. As they feed, the core nutrients are released in forms available to plant roots. Thus, the microorganisms are an integral part of the humus, as one cannot be found without the other. The only other component of the soil that holds onto and exchanges with plant roots is clay, but humus can hold onto and exchange a far greater amount of these nutrients.

It is also important to add to your compost pile. The soil contains a good starter supply of microorganisms. The organisms help in several ways. Some break down complex compounds into simpler ones the plants can utilize. There are five species of bacteria which fix nitrogen from the air in a form available to plants. One soil bacterium, *azotobacter*, converts atmospheric nitrogen into food for plants. All microorganisms tie up nitrogen surpluses. The surpluses are released gradually as the plants need nitrogen. An excessive concentration of available nitrogen in the soil (which makes plants susceptible to disease) is therefore avoided. There are predaceous fungi which attack and devour nematodes, but these fungi are only found in large amounts in a soil with adequate humus.

The microbiotic life provide a living pulsation in the soil which preserves its vitality for the plants. The microbes tie up essential nutrients in their own body tissues as they grow, and then release them slowly as they die and decompose. In this way, they help stabilize food release to the plants. These organisms are also continuously excreting a whole range of organic compounds into the soil. Sometimes described as "soil glue", these excretions help hold the soil structure together. The organic compounds also contain disease-curing antibiotics, and health producing vitamins and enzymes that are integral parts of biochemical reactions in a healthy soil.

It is important to note the difference between *fertilization* and *fertility*. There can be plenty of fertilizer in the soil and plants still may not grow well. Add compost to the soil and the humic acid it contains begins to release the hidden nutriment in a form available to the plants. This was the source of the amazing fertility of Alan Chadwick's garden at Santa Cruz.

The recipe for a biodynamic/French Intensive Method compost is *by weight*: 1/3 dry vegetation, 1/3 green vegetation and

KEY HUMUS FUNCTIONS

1. Feeds plants through nutrient exchange and nutrient release upon its decomposition.
 2. Is the most reliable fertilizer for plants because it feeds in proper ratios of nutrients.
 3. Humic acids in humus help dissolve minerals in the soil, making the mineral nutrients available to plants. Humic acids also increase the permeability of plant root membranes and therefore promote the uptake of water and nutrients by plant roots.
 4. Is the food of the soil organisms which are an integral part of soil health. In one gram of humus-rich soil there are several billion bacteria, one million fungi, ten to twenty million actinomycetes and 800,000 algae.
 5. The microbes which feed on soil humus temporarily bind the soil particles together. The fungi with their *thread-like* mycelia are especially important. They quite literally sew the soil together. The microbes secrete compounds into the soil as they live, metabolize, and ultimately decompose. Their secretions are a *glue* which holds soil particles, thus improving the structure. Structure is vital to soil productivity because it insures good aeration, good drainage, good water retention and erosion resistance.
 6. Is the key to soil structure, keeping it safe from severe erosion and keeping it in an open, porous condition for good water and air penetration.
-

kitchen wastes, and 1/3 soil—though we have found with our heavy clay soil that less soil produces better results. The ground underneath the pile should be loosened to a depth of 12–24 inches to expose the bottom layer of the pile to the bacteria and organisms in the soil and to provide good drainage. The materials should optimally be added to the pile in 1–2 inch layers with the dry vegetation on the bottom, the green vegetation and kitchen wastes second and the soil third (a 1/4–1/2 inch layer). You can, however, build a pile spontaneously, adding materials daily, or so, as they become available. This kind of pile will usually take a little longer to cure, but can be built more easily. Be sure to always cover kitchen wastes and fresh manures with soil to avoid flies and odors!

Green vegetation is 95 percent more effective than dry vegetation as a “starter” because its higher nitrogen content helps start and maintain the fermentation process. Dry vegetation is high in carbon content. It is difficult for the microbes in the compost pile to digest carbon without sufficient amounts of nitrogen. Unless you have a large household it may be necessary to save your kitchen scraps in a tight-lidded unbreakable container for several days to get enough material for the kitchen waste layer. Hold your breath when you dump them because the stronger smelling form of anaerobic decomposition process

A CROSS SECTION OF A BIODYNAMIC/FRENCH INTENSIVE COMPOST PILE

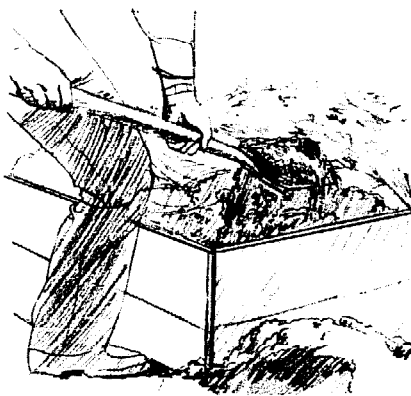
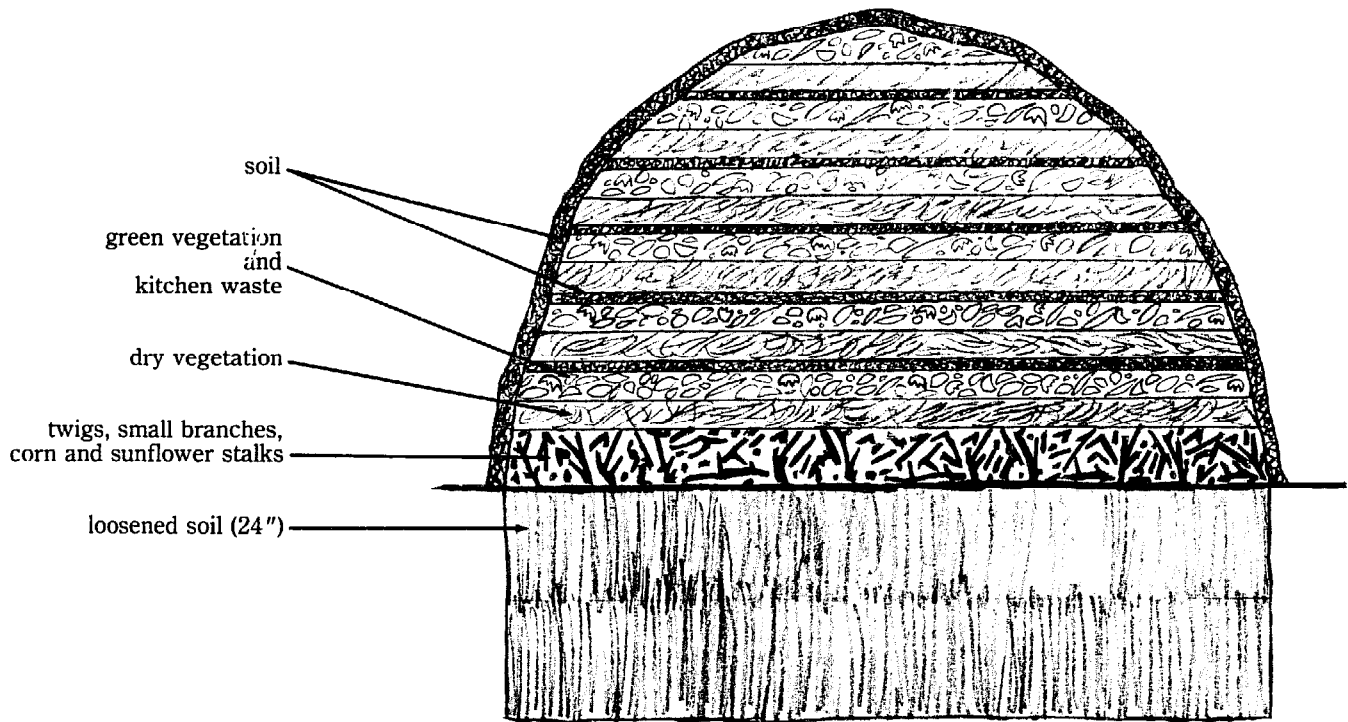

Soil is added to compost pile after green vegetation and kitchen waste layer.

has been taking place in the closed container. The smell will disappear within a few hours after reintroduction to air. All kitchen scraps may be added except meats and sizeable amounts of oily salad scraps. Be sure to include bones, tea leaves, coffee grounds and citrus rinds.

Add the soil layer immediately after the kitchen waste. It contains microorganisms which speed decomposition, keeps the smell down to a minor level and prevents flies from laying eggs in the garbage. The smell will be difficult to eliminate entirely when waste from members of the cabbage family is added. In a few days, however, even this soil minimized odor will disappear. As each layer is added, water it lightly so the pile is *evenly* moist—like a wrung-out damp towel that does not give out excess water when squeezed. Sufficient water is necessary for the proper heating and decomposition of the materials. Too little water results in decreased biological activity and too much simply drowns the aerobic microbiotic life. Water the pile when necessary as you water the garden. The particles in the pile should glisten. During the rainy season some shelter or covering may be needed to prevent overwatering and the less optimal anaerobic decomposition that occurs in a water-logged pile. (The conditions needed for proper functioning of a compost pile and those required for good plant growth in raised beds are similar. In both cases the proper mixture of air, soil nutrients, texture, microorganisms and water is essential.)

Compost piles can be built in a pit in the ground or in a pile above the ground. The latter is preferable, since during rainy periods a pit can fill up with water. A pile can be made with or

without a container. A container is not necessary, but can help shape a pile and keep the materials looking neat. The least expensive container is made of 12 foot long, 3 foot wide, 1 inch mesh, chicken wire with five 3 foot long, 1 inch by 2 inch boards and two sets of small hooks and eyes. The boards are nailed along the two 3 foot ends of the wire and at 3 foot intervals along the length of the wire (see illustration). The hooks and eyes are attached to the two end boards near the top and bottom. The unit is then placed as a circle on the ground, the hooks attached to the eyes, and the compost materials placed inside. The materials hold up the circle. After the pile is built, the wire enclosure may be removed and the materials will stay in place. You may now use the enclosure to build another pile, or you may use it later to turn the first pile into, if you decide to turn it to speed the decomposition process.

The least expensive type of compost container

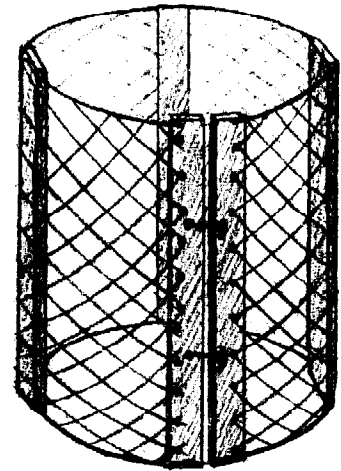

There are three ways to speed up the decomposition rate in a compost pile. One way is to *increase the amount of nitrogen*. The ratio of carbon to nitrogen is critical for the breakdown rate. Materials with a high carbon to nitrogen ratio, such as

Four kinds of compost piles

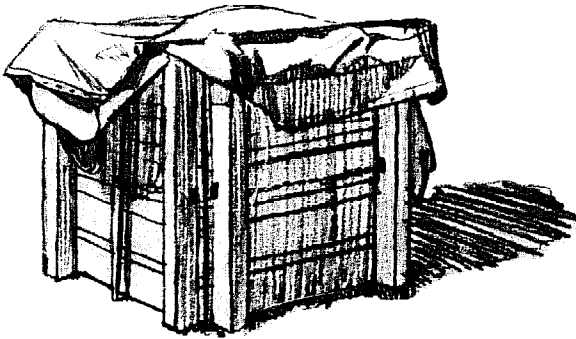

pallet type

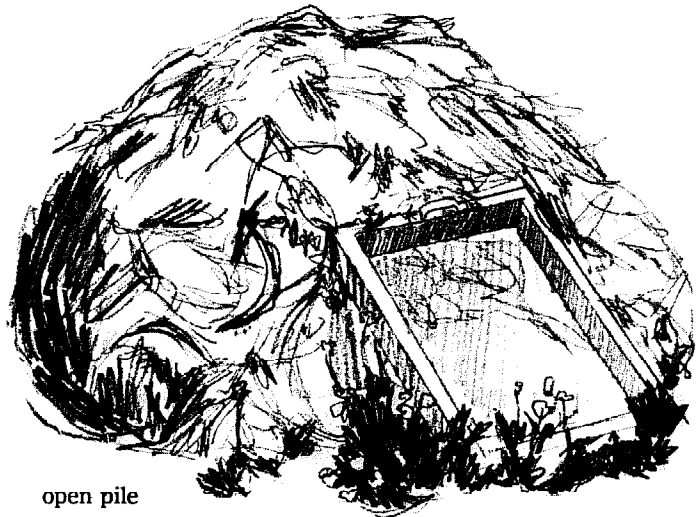

open pile



modular box type

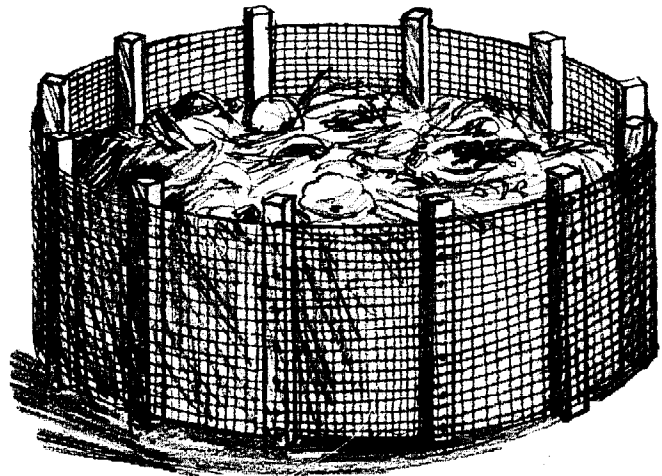

large wire-fabric type

wood, take a long time to decompose alone since they lack sufficient nitrogen-bearing materials upon which the bacteria depend for food. Such materials are sawdust, dry leaves, wood shavings, grainstubble and straw. To boost the rate of decay in carbonaceous materials, add nitrogen-rich materials such as newly cut grass, fresh manure, vegetable wastes, green vegetation or a fertilizer such as blood or fish meal. Three to five pounds of blood or fish meal per cubic yard of compost is probably a good amount of fertilizer with which to fortify a compost pile with a high carbon content. These fertilizers are lightly sprinkled on each layer as the pile is built.

A second method is to *increase the amount of air* (aeration). Beneficial aerobic bacteria thrive in a well aerated pile. Proper layering and periodic turning of the pile will accomplish this.

Third, the *surface area of the materials may be increased*. The smaller the size of the materials, the greater the amount of their exposed surface area. Broken up twigs will decompose more rapidly than twigs that are left whole. We discourage the use of power shredders because nature will do the job in a relatively short time and everyone has sufficient access to materials which will compost rapidly without resorting to a shredder. The noise from these machines is quite disturbing and spoils the peace and quiet of a garden. They also consume increasingly scarce fuel.

Note that at least *three different materials of three different textures* are used in the biodynamic/French intensive method compost recipe and many other recipes. The varied texture will allow good drainage and aeration in the pile. The compost will also have a more diverse nutriment content. A pile made primarily of leaves or grass cuttings makes the passage of water and air through the pile difficult without frequent turning because both tend to mat. Both good air and water penetration are required for proper decomposition. The layering of the materials further promotes a mixture of textures and nutriments and helps insure even decomposition.

A minimum pile size of 3 feet by 3 feet by 3 feet (1 cubic yard of lightly moist cured compost weighing about 1000 pounds) is recommended. (In colder climates a minimum pile size of 4 feet by 4 feet by 4 feet will be needed to properly insulate the heat of the composting process.) Smaller piles fail to provide the insulation necessary for proper heating (up to 160 degrees) and allow the penetration of too much air. It is all right to build piles up slowly to this size as materials become available, though it is best to build an entire pile at one time. A pile will cure to 1/2 to 1/3 its original size, depending on the materials used. A large pile size might be 6 feet high, 6 feet wide and 12 feet long.

The best time to prepare compost is in the *spring or autumn* when biological activity is highest. (Too much heat or cold slows down and even kills the microbiotic life in the pile.) The two high activity periods conveniently coincide with the maximum availability of materials in the spring, as grass and other plants begin to grow rapidly, and in the autumn, as leaves



An abundant garden starts with good compost made of "waste products" such as vegetable peelings, weeds and manures. With some knowledge and planning, the garden can produce all its needed fertilizer and organic matter.

fall and other plant life begins to die. The pile should optimally be built under a deciduous oak tree. This tree's nature provides the conditions for the development of excellent soil underneath it. And compost is a kind of soil. The second best place is under any other kind of deciduous tree (with the exception of walnut and eucalyptus). As a last resort, evergreen trees or any shady place in your backyard may be used. The shade and windbreak provided by the trees help keep the pile at an even moisture level. (The pile should be placed 6 feet away from the tree's trunk so it will not provide a haven for potentially harmful insects.)

Compost is ready to use when it is dark and rich looking. You should not be able to discern the original source of the materials from the texture, and the compost should crumble in your hands. Mature compost even smells good—like water in a forest spring! A biodynamic/French intensive pile should be ready to use in 2-1/2 to 3 months. Usually, no turning is needed as the materials used and their layering allow for good aeration and complete breakdown. But sometimes one turning will be needed at the 1-1/2–2 month point. The compost will then normally be ready about one month later. Compost for use in flats should be passed through a sieve of 1/2 inch or 1/4 inch wire fabric. In the garden a *minimum* maintenance dressing of 1/2 pound of compost per square foot should be added to the soil before each crop. Guidelines for *general* maintenance dressings are a 1 inch layer of compost, or 8 cubic feet, of compost per 100 square feet (about 3 pounds per square foot).

The biodynamic/French intensive method of compost making differs in particular from the biodynamic method¹⁶ in that it is simpler to prepare, normally uses no manure and usually uses no herbal solutions to stimulate microorganism growth. Manure used continually and in large amounts, is an imbalanced fertilizer, although it is a good texturizing agent because of its usual decomposed sawdust content. Weeds, such as stinging nettle, and plants, such as fava beans, are sometimes added in the preparation of special piles, however. Special mixtures are created to meet particular pH, texture and nutriment requirements. Separate compost piles are made of small tree branches since they can take two years to decompose.

The biodynamic/French intensive method of making compost differs from the Rodale compost method¹⁷ in the use of little or no manure and usually no rock powder fertilizers or nitrogen supplements. Fertilizers do not need to be added to the pile, since successful compost can be made from a mixture of ingredients. The nitrogen supplements do, however, speed up the decomposition process. Both the biodynamic and Rodale methods are good ones, proven by use over a long period of

16. For the biodynamic method of compost preparation, see pages 37 to 51 in *The Pfeiffer Garden Book*, Alice Heckel (Ed.), Biodynamic Farming and Gardening Association, Inc., Stroudsburg, Pennsylvania, 1967.

17. For the Rodale method of compost preparation, see pages 59 to 86 in *The Basic Book of Organic Gardening*, Robert Rodale (Ed.), Ballentine Books, New York, 1971.

time. Chadwick's biodynamic/French intensive recipe seems simpler to use and equally effective.

Some people use *sheet composting* (a process of spreading uncomposted organic materials over the soil and then digging them into the soil where they decompose). The disadvantage of this method is that the soil should not be planted for 3 months or so until decomposition has occurred. Soil bacteria tie up the nitrogen during the decomposition process, thereby making it unavailable to the plants. Sheet composting is beneficial if it is used during the winter in cold areas, because the tie-up prevents the nitrogen from leaching out during winter rains.

Other people use *green manure composting* (the growing of cover crops such as vetch, clover, alfalfa, bean, pea or other legumes until just before maturity when the plants are dug into the soil). This is an excellent way to bring unworked soil into a reasonable condition. Cover crops are rich in nitrogen, so they boost the nutriment quality of the soil without one's having to resort to the purchase of fertilizers. Their stems and leaves contain a lot of nitrogen and their roots support nitrogen-fixing bacteria. These bacteria take nitrogen from the air and fix it in nodules on the roots, which you can see when you pull the plants up. They also help you dig. Their roots loosen the soil and eventually turn into humus beneath the earth. Fava beans are exceptionally good for green manuring if you plan to plant tomatoes, because their decomposed bodies help eradicate tomato wilt organisms from the soil.

Due to their high nitrogen content, cover crops decompose rapidly. Planting can usually follow one month after the plants are dug into the soil. The disadvantage of the green manuring process is that the land is out of production during the period of cover crop growth and the shorter one month period of decomposition. In some areas, the long term improvement in the soil's nutritive content and structure compensates for this limitation.

The advantage of the small-scale biodynamic/French intensive method is that backyard composting is easily feasible. Even if you decide to use cover crop produce and not to dig the crop residues in, the growing process will put nitrogen into the soil and will make it possible to grow plants such as corn and tomatoes, which are heavy nitrogen feeders. (See Companion Planting chapter.) And the plant residues may be used in the compost pile.

Some materials should not be used in the preparation of compost:

- Plants infected with a disease or a severe insect attack where eggs could be preserved or where the insects themselves could survive in spite of the compost pile's heat.
- Poisonous plants, such as oleander, hemlock, and castor bean, which harm soil life.
- Plants which take too long to break down, such as magnolia leaves.

- Plants which have acids toxic to other plants and microbial life, such as eucalyptus, California bay laurel, walnut, juniper, acacia, and cypress.
- Plants which may be too acidic or contain substances that interfere with the decomposition process, such as pine needles. Pine needles are extremely acidic and contain a form of kerosene. (Special compost piles are often made of acidic materials, such as pine needles and leaves, however. This compost will lower the soil's pH and stimulate acid loving plants like strawberries.)
- Ivy and succulents, which may not be killed in the heat of the decomposition process and can regrow when the compost is placed in a planting bed.
- Pernicious weeds such as wild morning glory and bermuda grass, which will probably not be killed in the decomposition process and which will choke out other plants when they re-sprout after the compost is placed in a planting bed.
- Cat and dog manures, which can contain pathogens harmful to infants. These pathogens are not always killed in the heat of the compost pile.

Plants infected with disease or insects and pernicious weeds should be burned to be properly destroyed. Their ash then becomes a good fertilizer. The ash will also help control harmful soil insects, such as carrot worms, which shy away from the alkalinity of ashes.

Parts of a regular compost pile which have not broken down completely by the end of the composting period, should be placed on the bottom of a new pile. This is especially true for twigs and small branches which can use the extra protection of the pile's height to speed their decomposition in a situation of increased warmth and moisture.

FUNCTIONS OF HUMUS/COMPOST IN SOIL

Improved Structure—breaks up clay and clods, and binds together sandy soil. Helps make proper aeration in clayey and sandy soil possible.

Moisture Retention—holds 6 times its own weight in water. A soil with good organic matter content soaks up rain like a sponge and regulates the supply to plants. A soil stripped of organic matter resists water penetration thus leading to destructive compaction, erosion and flooding.

Aeration—plants can obtain 96% of the nutrients they need from the *air!* A loose healthy soil assists the diffusion of air into the soil, plus the exchange of nutrients and moisture. Carbon dioxide released by humus decomposition diffuses out of the soil and is absorbed by the canopy of leaves above in a raised bed mini-climate created by closely spaced plants.

Fertilization—compost contains some nitrogen, phosphorus and potassium but is especially important for trace elements. The important

principle is to return to the earth all which has been taken out by the use of plant residues and manures.

Nitrogen Storage—the compost pile is a storehouse for nitrogen. Tied up in the compost breakdown process, otherwise water soluble nitrogen does not leach out or oxidize into the air for a period of three to six months or more—depending on how the pile is built and maintained.

pH Buffer—a good compost will lower the pH of an alkaline soil and raise the pH of an acid soil.

Soil Toxin Neutralizer—important recent studies show that plants grown in organically composted soils take up less lead and other urban pollutants.

Nutrient Release—humic acids dissolve soil minerals and make them available to plants. As humus decomposes, it releases nutrients for plant uptake and for the soil microflora population.

Food for Microbiotic Life—good compost creates healthy conditions for soil organisms that live in the soil. Compost harbors earthworms and beneficial fungi that fight nematodes and other soil pests.

The Ultimate in Recycling—the earth provides us food, clothing, shelter, and we close the cycle in offering fertility, health, life through the shepherding of materials.

BUILDING A COMPOST PILE STEP-BY-STEP

1. Loosen soil under the pile area 12 inches deep with a spading fork.
2. Lay down *roughage* (brush, corn stalks or other material) 6 inches thick for air circulation, if they are available.
3. Put down 2 inch layer of *dry vegetation*—dry weeds, leaves, straw, grass clippings, hay, and old garden wastes.
4. Put down 2 inch layer of *green vegetation and kitchen waste*—fresh weeds, grass clippings, hedge trimmings, green cover crops, and kitchen waste you have saved. Cover lightly with *soil* to prevent flies and odors.
5. Add new layers of dry vegetation, green vegetation, kitchen waste, and soil as materials become available until pile is 3 to 6 feet high.
6. Let completed pile cure 3 to 6 months while building a new pile. Turn occasionally for faster decomposition.
7. Water completed pile regularly until ready for use. For planning purposes, remember that a 6 foot high compost pile will be only 2 to 3 feet high when it is ready to use.

Note: Materials with a high carbon content such as leaves, dry weeds and grass clippings, sawdust and wood chips are very slow to decompose, taking six months to three years. To hasten decomposition, keep moist and add materials high in nitrogen such as fresh manure or blood meal. Green weeds, fresh grass clippings and juicy kitchen waste are quick to decompose. Alone, these highly nitrogenous materials can break down in as little as two weeks BUT they can attract flies and cause offensive odors unless mixed with high-carbon materials.

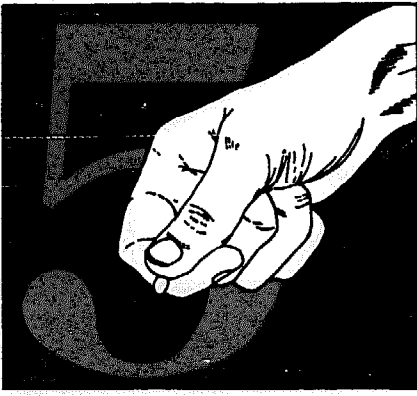

Seed Propagation

Now that we know a little about the body and soul of our Earth, we are ready to witness the birth of seedlings. For a minute close your eyes, pretend you are the seed of your favorite plant, tree, vegetable, fruit, flower or herb. You are all alone. You can do nothing in this state. Slowly you begin to hear sounds around you. The wind, perhaps. You feel warmth from the sun—the ground underneath you. What things do you need in relation to you for good growth? Think like a seed and ask yourself what a seed needs in nature—air, warmth, moisture, soil, nutriment, microorganisms. You need these things, at least, along with other plants, birds, insects, spiders, frogs and chickens. You need an entire microcosm of the world.

Generally the first elements fall into two categories: the terrestrial (soil and nutriment) and celestial (air, warmth, moisture). These elements cannot be completely categorized, however, since air, warmth and moisture come from the heavens to circulate through the soil and gases can be taken into plants through their roots as well as their leaves. Nutriment on the other hand, can be borne upon the air currents. In fact, the important trace mineral zinc is taken in more readily by citrus tree leaves, than by their roots. The parts that other elements in the plant and animal worlds play—the parts of other plants and insects, for example—will be discussed in the chapter on Companion Planting.

Seed Planting

Seeds should be planted as deep as the thin vertical dimension of each seed. Lima and fava beans may be planted on their sides. The root system, which emerges from the eye, will still be able to grow straight down. Preferably, the seed should be covered with sifted compost, which is similar to decomposed plant matter found over germinating seeds in nature. This compost stimulates the germination process.

The depth to which a seed is planted is equal to its vertical dimension.

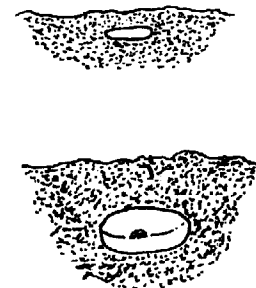

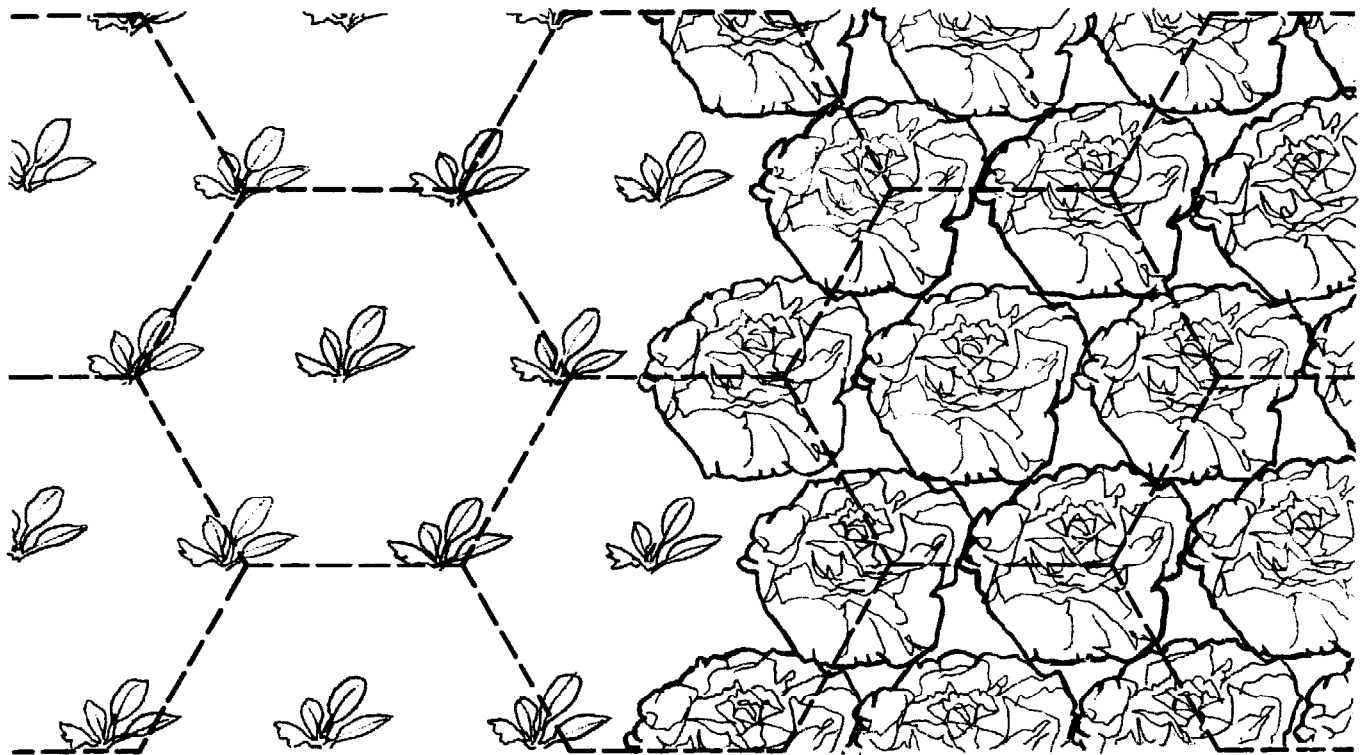

HEXAGONAL SPACING
Head lettuce—12 inch centers

The seeds, whether they are planted in beds or flats, should be planted in a diagonally offset or hexagonal spacing pattern with each seed the same distance from all the seeds nearest it. The spacings given in the chart later in this section show how far to place different plants from each other, so that when the plants are mature in the flats or the planting beds their leaves will barely touch and provide the living mulch mini-climate under the leaves so essential to balanced, uninterrupted growth. In general, the plant spacings for vegetables, flowers and herbs are the “within the row” spacings listed on the back of seed packets or sometimes $\frac{3}{4}$ of this distance. *Disregard* the “between rows” spacings. Spacing for plants normally grown on hills has to be determined by experimentation. Our best spacings to date for these are given in the spacing charts. Plants spaced accordingly form a *living mulch*, which retards weed growth and aids in the retention of soil moisture by shading the soil. When spacing seeds in flats, place the seeds so far apart that the seedlings’ leaves will barely touch when the seedlings are transplanting size. Try 1-inch to 2-inch spacings depending on the size of the seedling at its transplanting stage (see spacing chart at the end of this chapter).

To make the placement of seeds in the planting beds or flats easier, use frames with 1-inch and 2-inch mesh chicken wire stretched across them. The mesh is built on a hexagonal pattern, so the seeds can be dropped in the center of a hexagon and be on the proper center. Or, if a center greater than 1 inch is involved and you only have 1-inch mesh, just count past the proper number of hexagons before dropping the next seed. When transplanting or planting seeds on spacings of 3 inches

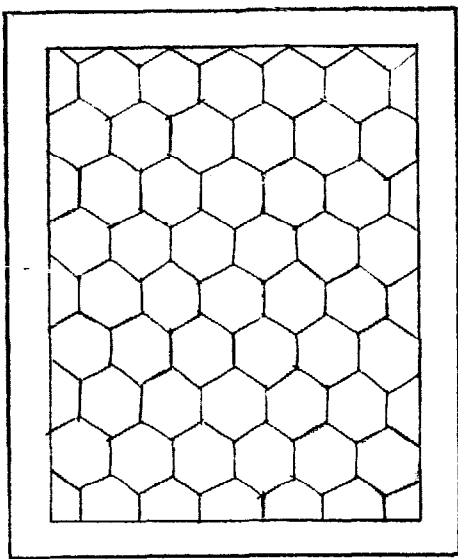

Spacing frame for placing seeds in flats.
Place seed in center of each space.



or more, try using measuring sticks cut to the required length to determine where the plant should be located. Drop a seed at each point of the triangulation process.

Once you have gotten the feel for plant spacing, you may want to practice broadcasting seeds by hand and eventually graduate to this method of sowing. Broadcasting is the method used by Alan Chadwick and his apprentices in both flats and growing beds. When you reach this stage, seeds should end up $1/4$ to $1/2$ inch apart in the first flat. This way the seeds can take advantage of complete mini-climate growth stimulation and health earlier in their life. It does require more time to do several transplantings though. When these seedlings' leaves are barely touching, they should be transplanted into other flats on $1/2$ to 1-inch centers. Approximately four flats will be filled by one flat of these broadcasted seeds. Or you can broadcast the seeds on $1/2$ to 1-inch spacings initially and thin the areas where plants are too close together. Sometimes little thinning is needed. Broadcasting on wider centers and thinning can also eventually be done in the growing beds. Thinning will probably take the same amount of time (or more) as placing seeds on their proper centers in the first place, but the health of plants from broadcast seeds will probably be better because of an earlier established mini-climate. You will also eventually learn to transplant with reasonable accuracy without measuring!

Cover the seeds in flats with a layer of the flat soil mixture described below. Seeds in a planting bed should normally be covered with soil taken from the bed itself *after* the double-digging has been completed and *before* the shaping and fertilization steps are begun. Or, large seeds may be poked into the soil

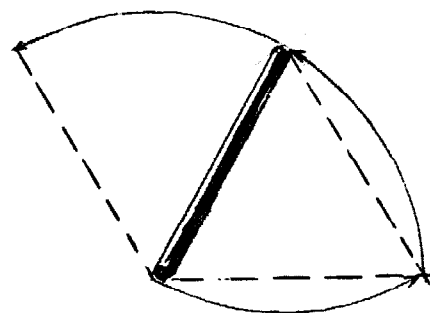

Spacing stick for placing seeds in beds.
3 inch to 36 inch sizes used according
to crop planted.

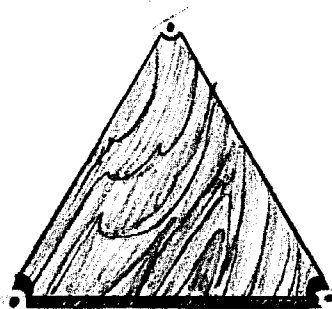

Triangular spacing template for placing
seeds in beds.

Seeding triangulation

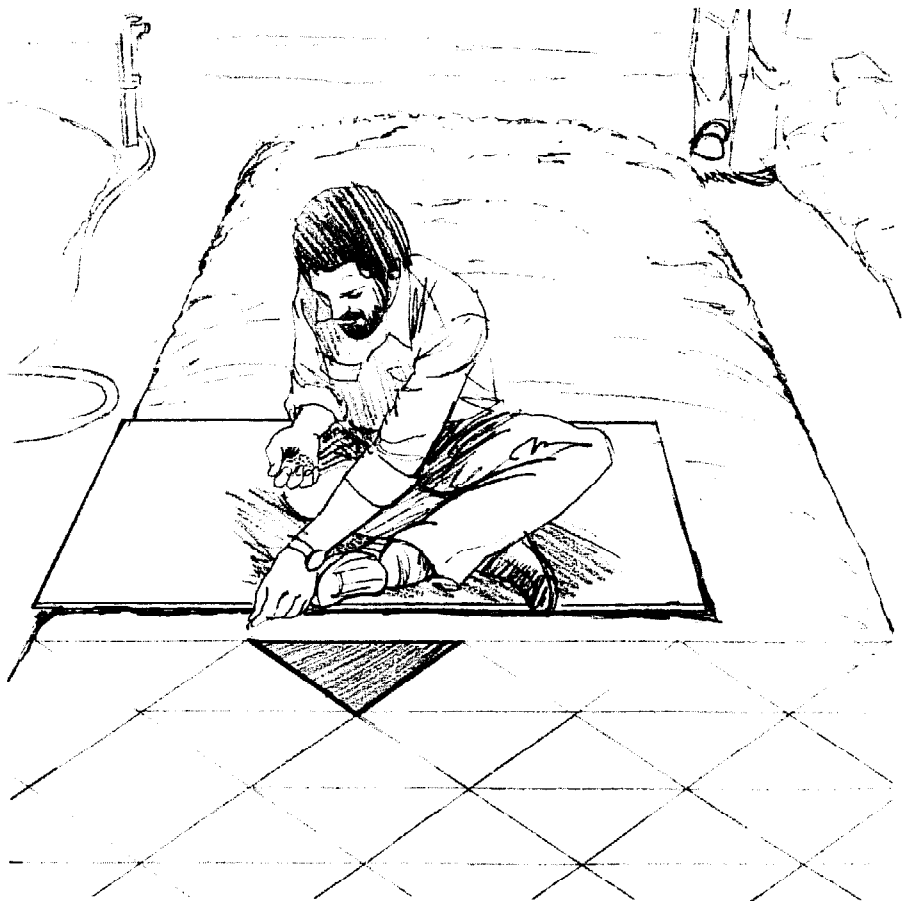

Seedling flat construction
Sides and bottom are of bender board

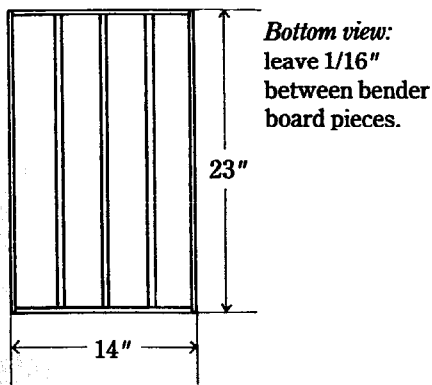

Ends are of 1" x 3", 1" x 6", and 1" x 10" redwood

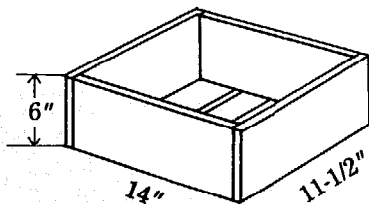
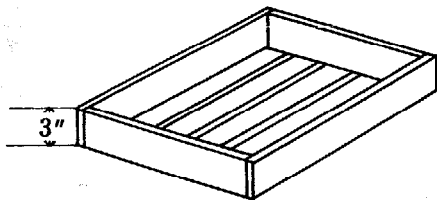

Deeper flat half as long to insure manageable weight

to the proper depth with your index finger. The hole may then be filled by pushing soil into it with your thumb and index finger.

Flats

If you build your own flats, the standard flat size is 3 inches deep by 14 inches wide by 23 inches long. The depth is critical since too shallow a depth allows the seedling roots to touch the bottom too soon. When this occurs, the plants believe they have reached the limit of their growth and they enter a state of "premature senility." In this state the plants begin to flower and fruit even though they are only transplanting size. We have experienced this with broccoli and dwarf marigolds. The broccoli heads were the size of a little fingernail. The length and width of the flat are not as critical. Their size should not become too large, however, if the flat is to be easy to carry in weight and size. If plants must remain in the container more than 4 to 6 weeks, a container 6 inches or more in depth should be used.

When planting seeds or seedlings, remember that the most important area for the plant is the 2 inches above and the 2 inches below the surface of the flat or the planting bed. This is because of the mini-climate created under the plants' leaves and because of the important protection of the upper roots in the flat or the bed by the soil. Without proper protection, the plants will develop tough necks at the point where the stem emerges from

the soil. A toughened neck slows the flow of plant juices and interrupts and weakens plant growth. These areas are also important because in a very real sense the roots are *leaves in the soil* and the leaves are *roots in the air*. The explanation for this dualism lies in the facts that the roots "breathe" in (absorb) gases in significant amounts as if they were leaves and that the leaves absorb moisture and nutriment from the air. Also, plant life activity varies above and below the ground according to monthly cycles. Root growth is stimulated more during the third quarter of each 28 day period and leaf growth is stimulated more during the second quarter in accordance with the phases of the moon. (See pages 52-53.)

The exact critical distance above and below the surface of the planting bed is not necessarily 2 inches. Obviously it will be different for radishes than for corn, since their leaves begin at different heights from the soil surface and because they have different depths to their root systems. Generally speaking though, the 2-inch—2-inch guideline helps us develop a sensitivity to the plants' needs above and below ground. (The need for proper conditions above and below ground was also noted in the comparison between the normal use of rows in gardening and farming and the use of raised beds for growing plants on pages 3 and 4). In particular, the mini-climate protects the feeder roots and the microbiotic life which are both concentrated in the upper soil.

Flat Soil

You are now ready to prepare the soil in which to grow these versatile plants. A good planting mixture to use for starting seeds in flats is 1/3 each *by weight* compost, sharp (gritty) sand and turf loam. The three ingredients provide a fertile, loose-textured mixture. These elements should be mixed thoroughly together and placed in the flat on top of a 1/8 inch layer of oak leaf mold (partially decayed oak leaves) or compost, which lines the bottom of the flat for drainage and additional nutriment. Crushed egg shells may also be placed above the oak leaf mold for calcium-

Planted seedling flats

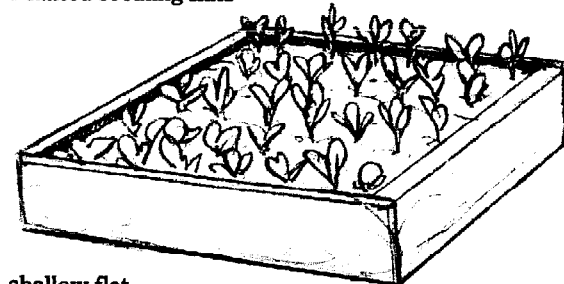

shallow flat

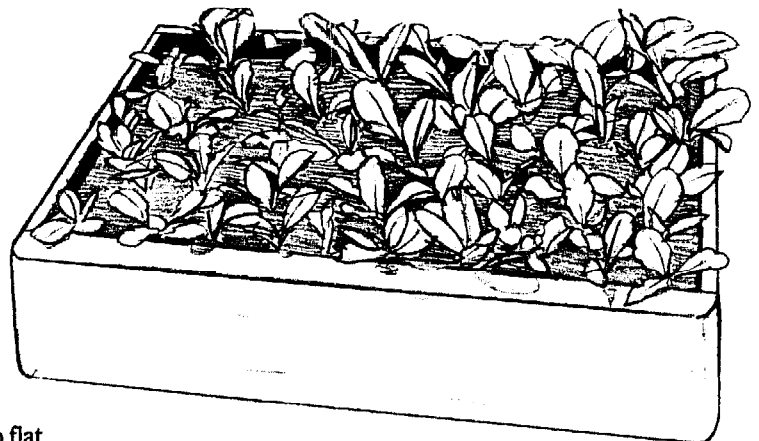

deep flat

The leaves are roots in the air . . .

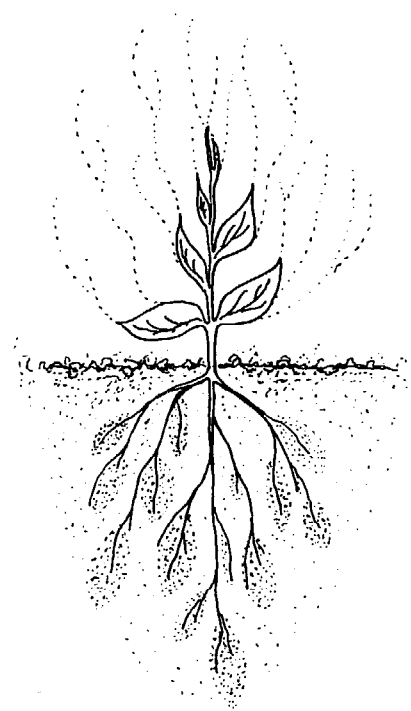

roots are leaves in the ground . . .

Turf loam compost pile

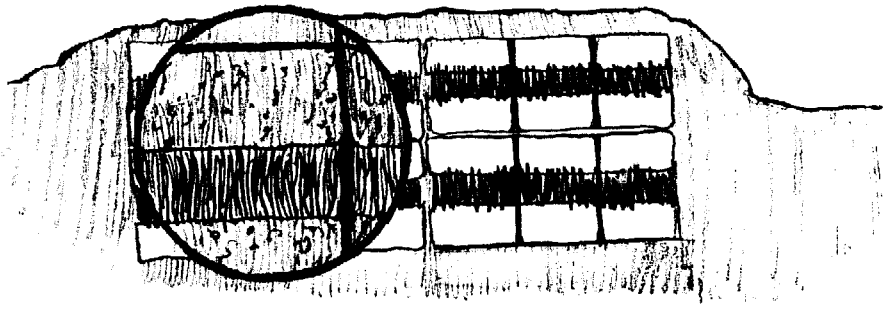

Loose soil with good nutriment enables roots to penetrate the soil easily and a steady stream of nutriment flows into the stem and leaves

loving plants such as carnations and members of the cabbage family. The egg shells should be lightly sprinkled so one-quarter of the total surface area will be covered. Turf loam is made by composting sections of turf grass grown in good soil. The sections are composted with the grass side of the sections together and the soil sections together within the pile. Good garden soil can be substituted for the turf loam.

Transplanting

Hold seedling by leaves.

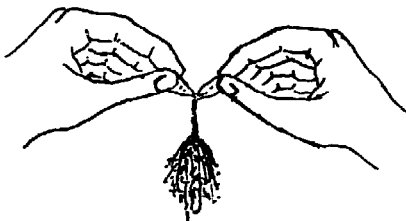

The biodynamic/French intensive method continually seeks to foster uninterrupted plant growth. Part of this technique is embodied in the "Breakfast-Lunch-Dinner!" concept stressed by Alan Chadwick. Frequently, seedlings are raised in a very good soil—in terms of nutriment and texture—only to be transplanted into an area which has little nutriment and a poor texture. The plant suffers root shock when it is uprooted from the flat and then encounters nutriment deficiency and physical impediment to growth in poor soil. Better results occur when seedlings are transplanted from a flat with a good planting mixture "Breakfast" into a second flat with a "Lunch" consisting of a similar mixture fortified with extra compost. The plant will forget its trauma in tasting the delectable new lunch treats in the second flat. This process minimizes shock and even fosters growth. In the biodynamic/French intensive method, transplanting stimulates growth rather than slowing it down. Finally, a splendid biodynamic/French intensive "Dinner" greets the plant in the growing bed! With this kind care and stimulated healthy plant growth there is less likelihood of insect and disease damage.

The hand fork



A biodynamic gardener once had a row of broccoli plants. Only two had aphids on them, and both were quite infested. The two plants were dug up and the gardener discovered the plants had experienced root damage during transplanting. The healthy broccoli, which had experienced uninterrupted growth, went untouched by the insects, while nature eliminated the unhealthy plants. When transplanting, it is important to handle the seedlings gently, and to touch them as little as possible. Plants do not like their bodies to be handled, though they do like to have human companionship and to have dead leaves removed from their stems. You should hold them only by the tips of their

leaves (if the plant must be touched) or by the soil around their roots. If the seedlings have been grown in flats, use a hand fork to gently separate a 4 square-inch section of soil and plants from the rest. Using the fork, gently lift the section from the flat and place it on the ground. Then carefully pull away one plant at a time from the section for transplanting. If it is particularly dry, hot or windy, the section should be placed on a wet towel and three of its sides should be protected from exposure by the towel. Always keep as much soil around the roots as possible. If the seedling has been grown in a pot, turn the pot upside down, letting the plant stem pass between your second and third fingers, and tap firmly on the bottom of the pot with your other hand. Or tap the lip of the pot on something solid. Optimally, transplanting should be done in the early evening, so the seedling will be more able to overcome transplanting shock at a time of more moderate climatic conditions. If transplanting is performed at other times some temporary shading may be needed.

In all cases, if the plants are root bound (roots so tightly grown together that with the soil they constitute a tight mass), gently spread the roots out in all directions. This process is important, because the plant would spend critical growth energy in sending out a new, wide-ranging root system for eating and drinking, when a good root system has already been produced. How much better if the energy goes into the natural flow of continuous growth rather than into the correction of an abnormal situation. In spreading the roots out, we physically minimize a problem which has occurred when the plant was kept in a starting flat or pot too long.

Be sure to place the seedling into a large enough hole so that the plant can be buried up to its first set of true leaves. This way, as the soil is packed down under the pressure of watering, the final soil level will remain high enough to cover the upper roots. Press the soil firmly around the seedling, but not too tightly. Tight packing will damage the roots and will not allow the proper penetration of water, nutrients and air. Too loose a soil will allow air and moisture to concentrate around the roots. This will cause root burn and decay. Firm contact of the plant's roots with the soil is necessary for the proper absorption of water and nutrient by the plant through the roots. Water the seedlings after transplanting to help settle the soil around the roots, to eliminate excess air spaces and to provide an adequate amount of water for growth.

A second reason for transplanting seedlings up to their first two leaves is to prevent them from becoming top-heavy and bending over during the early growth period. (This is especially true for members of the cabbage family.) If the plant bends over, it will upright itself, but a very tough neck will be created that will reduce the quality and size of the plant and vegetable. Onions and garlic, however, do better if the bulb does not have so much soil weight to push up against.

The correct way to unpot a seedling.

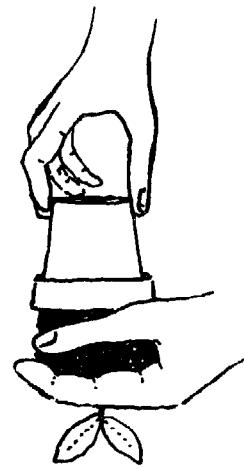

Spread rootbound plant roots out before transplanting into bed.

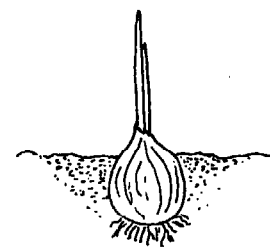

Most vegetables should be transplanted up to their first two leaves.

proper

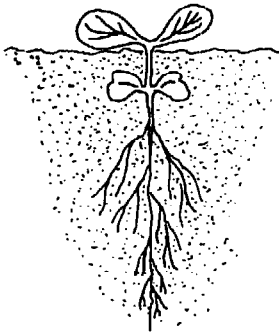

improper

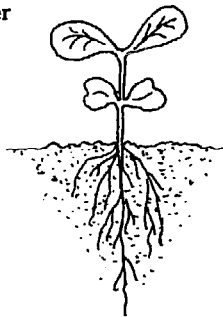

result

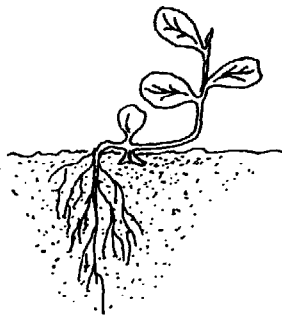

Transplanting should be used whenever possible. Space and water are conserved in this way, because seedlings in flats require less of both. More importantly, transplanting is a way to improve plant health. Beds become compacted as they are watered from day to day. Thus, if a seed is planted directly in the bed, some compaction will have occurred by the time it is a "child" a month later and, in some cases, so much so after two months when it is likely to be an "adolescent", that its "adulthood" may be seriously affected. If, instead, you transplant the one-month old "child" into the growing bed, a strong adult root system can develop during the next two months and a good adult life is likely. In fact, a study at the University of California at Berkeley in the 1950's indicated that a 2-4% increase in root health can increase yields 2 to 4 times.¹⁸

Planting by the Phases of the Moon

One of the most controversial aspects of the biodynamic/French intensive method is the planting of seeds and the transplanting of seedlings by phases of the moon. *Short and extra-long germinating seeds* are planted *two days before the New Moon*, when the first significant magnetic forces occur, and up to seven days after the New Moon. *Long germinating seeds* are planted *at the Full Moon* and up to seven days afterward. *Seedlings* are *transplanted at the same time*. Both planting periods take advantage of the full sum of the forces of nature, including gravity, light and magnetism. The greatest sum of increasing forces occurs at the New Moon. The lunar gravitational pull which produces high tides in the oceans and water tides in the soil is very high. And the moon, which is dark, gets progressively lighter. (See drawing.) The importance of the time of the month in planting seeds and transplanting is not so much in the exact day on which you perform the task, but rather in generally taking advantage of the impetus provided by nature.

18. Charles Morrow Wilson, *Roots: Miracles Below—The Web of Life Beneath Our Feet*, Doubleday and Company, Garden City, New York, 1968, p. 105.

PLANTING BY THE PHASES OF THE MOON

2 days before New Moon



Plant short and extra-long germinating seeds (most vegetables and herbs) into flats and/or beds

First 7 days



Balanced increase in rate of root and leaf growth

Moonlight +
Lunar Gravity -

Second 7 days



Increased leaf growth rate

Moonlight +
Lunar gravity +

By placing short germinating seeds in the ground two days before the lunar tide forces are greatest, the seed has time to absorb water. The force exerted on the water in the seed helps create a "tide" that helps burst the seed coat in conjunction with the forces produced by the swelling of the seed. No doubt you have wondered why one time beet seeds come up almost immediately and another time the germinating process takes two weeks in the same bed under similar conditions. Temperature and moisture differences, pH changes and humus levels may influence the seeds in each case, but the next time you note marked difference in germination time, check your calendar to determine the phase the moon was in when the seeds were sown. You may be surprised to find the moon had an influence.

Looking at the drawing, you can see that there are both increasing and decreasing lunar gravitational and light force influences that recur periodically during the lunar month. Sometimes the forces work against each other and sometimes they reinforce one another. When the lunar gravitational pull decreases and the amount of moonlight increases during *the first 7 days*, plants undergo a period of balanced growth. The decreasing lunar gravity (and the corresponding relative increase in the earth's gravity) *stimulates root growth*. At the same time, the increasing amount of moonlight *stimulates leaf growth*.

During *the second 7 days*, the lunar gravitational force reverses its relative direction and increases. This pull *slows down the root growth* as the earth's relative gravitational pull is lessened. The moonlight, on the other hand, continues to a peak and *leaf growth is especially stimulated*. If root growth has been sufficient during previous periods, then the proper amounts of nutriment and water will be conveyed to the above ground part of the plant and balanced, uninterrupted growth will occur. In this time of increasing gravitational, moonlight and magnetic forces, seeds which have not yet germinated receive a special boost from nature. If they did not germinate at the time of the New Moon, they should do so by the Full Moon. It is during this period that Alan Chadwick says seeds cannot resist coming up and in which mushrooms suddenly appear overnight.

KEY:

- New Moon
- ◐ First Quarter
- Full Moon
- ◑ Fourth Quarter
- + = Increasing
- = Decreasing

Full Moon

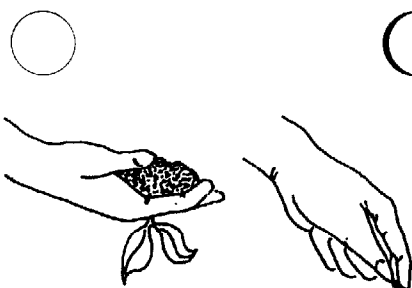

Transplant seedlings from flat into beds and plant long-germinating seeds (most flowers) into flats and/or beds

Third 7 days

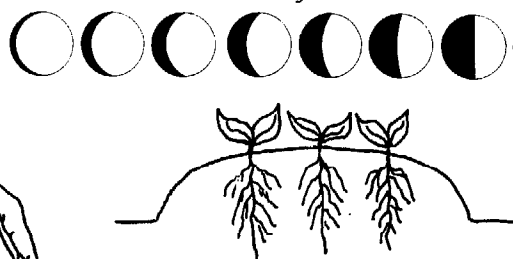

Increased root growth rate

Moonlight -
Lunar gravity +

Fourth 7 days

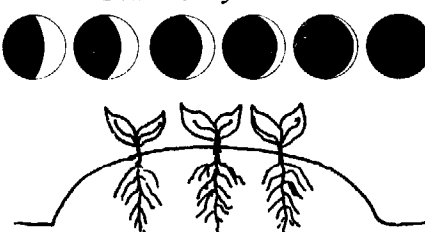

Balanced decrease in rate of root and leaf growth (resting period)

Moonlight +
Lunar gravity -

During *the third 7 days*, the amount of moonlight decreases along with the lunar gravitational pull. As the moonlight decreases, the above ground *leaf growth slows down*. The *root growth is stimulated* again, however, as the lunar gravitational pull decreases. This is a good time to transplant, since the root growth is active. The activity enables the plant to better overcome root shock and promotes the development of a good root system while leaf growth has been slowed down. Then, 21 days later, when leaf growth is at a maximum, there will be a developed root system that can provide the plant with sufficient nutriment and water. It is also the time to plant long germinating seeds. Seeds which take approximately two weeks to germinate will then be in a state which can take advantage of the boost from the high gravitational pull of the New Moon.

During *the last 7 days*, the lunar gravitational force increases and *root growth slows down*. The amount of moonlight also decreases and *slows down leaf growth*. This period is one of a balanced decrease in growth or a period of rest, just as the first 7 days in the lunar month is a period of a balanced increase in growth. The last 7 days, then, is a rest period which comes before the bursting forth of a period of new life. Short and extra-long germinating seeds are planted two days before the New Moon so they will be able to take advantage of this time of new life. (The extra-long germinating seeds take approximately one month to germinate.) The short, long and extra-long germinating seed varieties are given in the large chart later in this chapter.

In time, a planted seed bursts its seed coat around the twenty-eighth day of the lunar month and proceeds into a period of slow, balanced and increasing growth above and below ground, passes into a period of stimulated leaf growth, then goes into a period of stimulated root growth (getting ready for the next period of stimulated leaf growth) and then goes into a time of rest. This plant growth cycle repeats itself monthly. Plants are transplanted at the Full Moon, so they may begin their life in the growth bed during a time of stimulated root growth. The stimulation is important to the plant because root shock occurs during transplanting. It is also important for the plant's root system to be well developed, so it can later provide the leaves, flowers and vegetables with water and nutriment. The transplanted plant then enters into a time of rest before beginning another monthly cycle. The workings of nature are beautiful.

(It should be noted that planting by the phases of the moon is a nuance which improves the health and quality of plants. If you do not follow the moon cycles, your plants will still grow satisfactorily. However, as your soil improves and as you gain experience, the nuances will become more important and will have a greater effect. Try it and see.)

Watering

The watering of beds and flats in the biodynamic/French intensive method is performed in a way which approximates rainfall as much as possible. The fine rain also absorbs beneficial air born nutriments, as well as air, which help the growth process. For seeds and seedlings in flats, a special English Haws sprinkling can¹⁹ is used, which has fine holes in the sprinkler's "rose". The "rose" points up so that when you water, the shower first goes up into the air where much of the pressure built up (when the water is forced through the rose) is dissipated. The water then falls on the plants from above like rain with only the force of gravity pulling the water down. When watering planting beds, the same method of spraying the water into the air and letting it fall back down may be used, using a water gun unit with a fan spray nozzle²⁰ attached. Or, the fan may be used without the water gun. (If a water gun is used, a heavy duty hose will be required to contain the water pressure.) This method of spraying water into the air in a relatively fine rain means the soil in the bed will pack down less and that the plants will not be hit and damaged by a hard water spray. If you choose to point the fan downward, stand as far away from the plants a possible and/or keep the water pressure adjusted to a low point so soil compaction and water damage problems will be minimized.

Daily watering washes the dust, grime and insects from plant leaves and creates a deliciously moist atmosphere conducive to good plant growth and thriving microbotic life.

Some plants such as those of the cabbage family, like to have wet leaves. It is all right, and in fact beneficial, to water these plants from overhead. Other plants, such as tomatoes, peas and members of the squash and melon families can suffer from wilt, mildew and the rotting of their fruit when their leaves are wet, especially in foggy or humid climates. Care should normally be taken, when watering these plants, to water only the soil whenever possible. (In drier climates it will probably not matter.) To avoid spraying the leaves, the fan should be held just above the soil and be pointed sideways. A better method is to use a watering wand which will allow you to more easily place water under the plant's leaves.

The beds are watered lightly each day to keep them evenly moist. (Watering may be more or less frequent when the weather is warmer or cooler than normal.)

Mature plants in beds should be watered when the heat of the day first subsides. This is about two hours before sunset during the summer and earlier during the winter. However, weather conditions, especially cloud cover, may neces-

Haws watering can

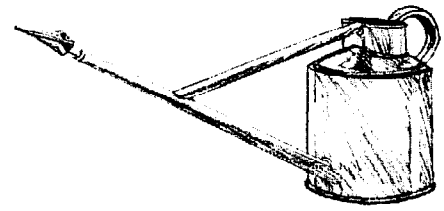

Close-up of special upward pointing Haws watering rose.

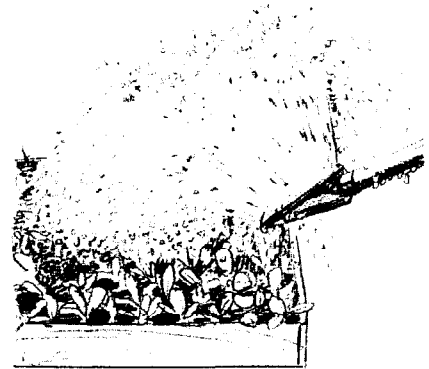

Ross watering fan attached to a variable water pressure gun.

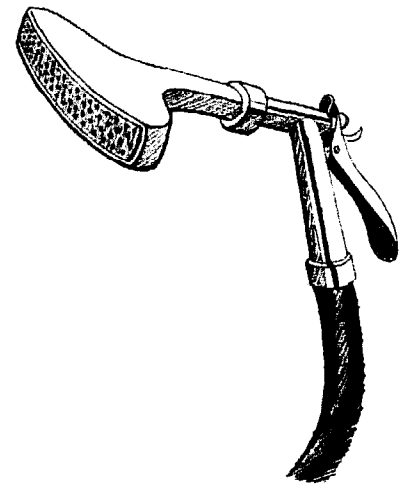

19. Available by mail order from: Walter F. Nicke, Box 667G, Hudson, NY 12534.

20. A Ross No. 20 from your local hardware store is the best one.

Watering with wand—Water falls in a circular pattern on the bed, landing approximately 3 feet from waterer at its closest point.



Watering with fan—Water falls in an oval pattern on the bed, landing approximately 10 feet away from the waterer. When watering closer, reduce water pressure.

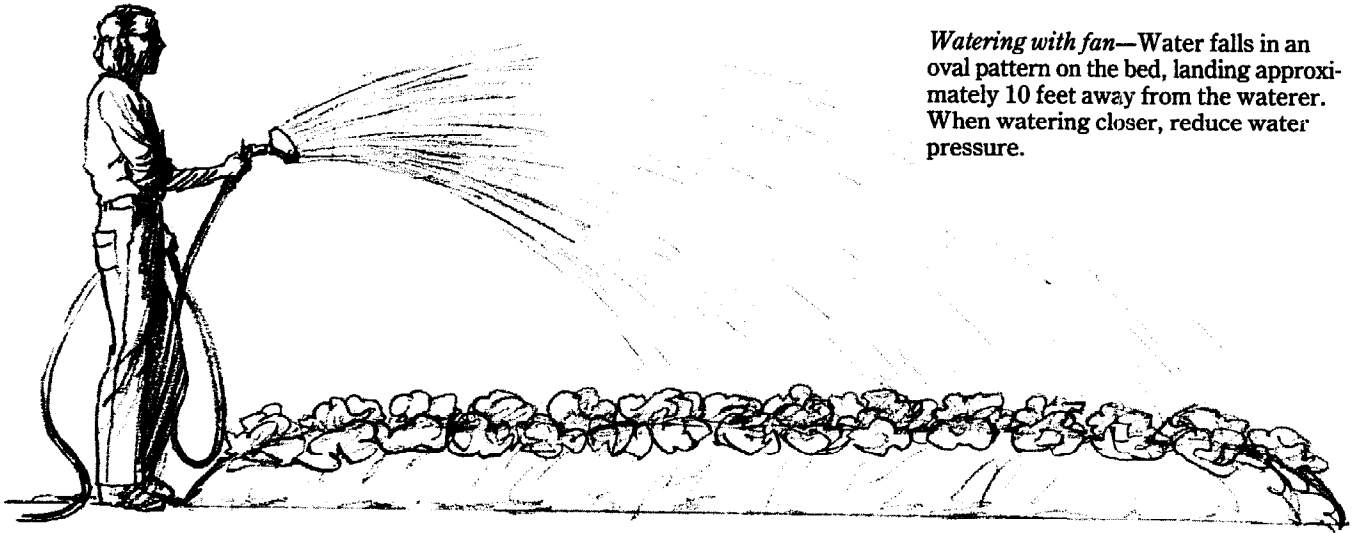

Technique for watering tomato plants using wand.

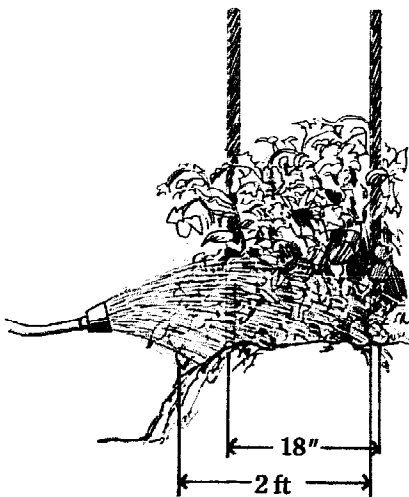

sitate earlier watering. The cool water is warmed by the warm soil and the water temperature is modified by the time it reaches the plant roots. The roots suffer less shock and the soil and plants have more time to absorb water during the cooler, less windy night. The availability of moisture is critical, since plants do a significant amount of their growing at night. If you water early in the morning, much of the water will be lost in evaporation caused by the sun and wind and the watering will be less effective. The loss will be even greater if you water at mid-day. If you water in the evening, the plants will be more susceptible to mildew and rust problems due to unevaporated water left on their leaves. By watering primarily in the late afternoon, you allow the water to percolate into the soil for a half day or more before the sun and wind reappear in strength. When they do, the bed will be a good reservoir of water from which the plants can draw.

Seeds and seedlings in flats and seeds and immature

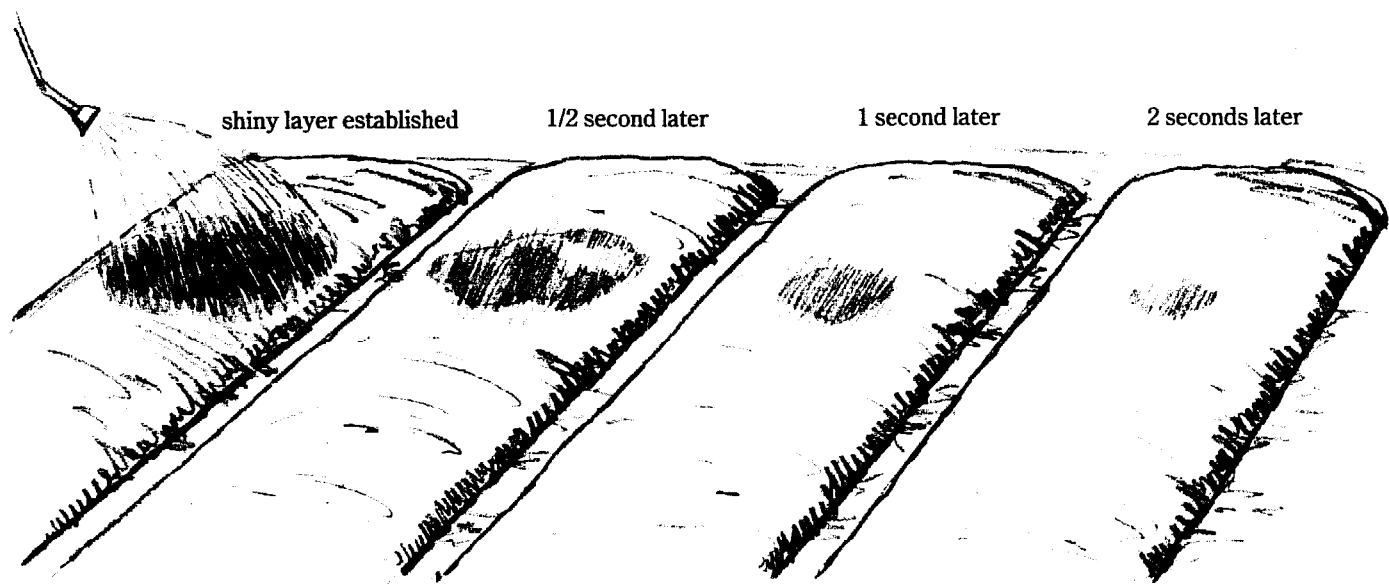

plants in the growing beds may have to be watered in the morning and at noon as well as late in the afternoon. Until the living mulch effect occurs, the flats and beds need more watering because they dry out more rapidly. As the leaves grow closer together, less watering will be required.

To determine how much water to give a bed each day, strive for a 1/2 to 15 second "shiny".²¹ When you first begin to water, a *shiny layer* of excess water will appear on top of the soil. If you stop watering immediately, the shiny layer will disappear quickly. You should water, then, until the shiny layer remains for 1/2 to 15 seconds after you have stopped watering. The actual time involved will differ depending on the texture of your soil. The more clayey the texture, the longer the time will be. A newly prepared bed with good texture and structure will probably have enough water when a 1/2 to 3 second "shiny" is reached. A newly prepared clayey bed may indicate enough watering has been done with a 3 to 5 second "shiny", since a clayey soil both retains more moisture *and* lets the water in less rapidly. A month old bed (which has compacted somewhat due to the watering process) may require a 5 to 8 second "shiny" and beds two to three months old may require a longer one.

A newly prepared bed is properly watered when the *shiny layer* of excess water disappears within 1/2 to 3 seconds after watering stops.

Eventually, the watering process will become automatic and you will not even have to think about when the bed has received enough water. You will know intuitively when the point has been reached. Remember to allow for the different natures of plants. Squash plants, for instance, will want a lot of water in comparison to tomato plants. One way to determine if you have watered enough is to go out the next morning and poke your finger into the bed. If the soil is evenly moist for the first two inches and continues to be moist below

21. Another simple way to estimate the amount of water a bed is receiving is to first measure the gallons delivered per minute. Turn the hose on and point the spray into a 1 gallon jar or 4 quart watering can. If, for example, it takes 15 seconds to fill the jar, then you know you are delivering 4 gallons per minute to the bed. Currently, in our moderately heavy clay, we find each 5' x 20' bed will take anywhere from 5-20 gallons daily (10 gallons on the average) depending on the weather, the size of the plants, the type of plant and the tightness of the soil.

this level, you are watering properly. If the soil is dry for part or all of the first two inches, you need more “shiny”. If the soil is soggy in part or all of the upper two inches, you need less “shiny”.

Remember also to adjust your watering according to the weather. A bed may lose more moisture on a cloudy, windy, *dry* day than on a hot, clear, *humid* and still one. And there are times when the flats and beds need no water or watering twice a day. It is important to note these differences and to become sensitive to the needs of the plants. You should water for good fruit, flower and vegetable production, not just so the plant will stay alive. Be sure to water the sides and edges of the planting beds more. These areas, which many people miss or under-emphasize, are critical because they are subject to more evaporation than the middle of the bed. Pay special attention to older beds. The soil tends to compact in older beds, so two light waterings may be required to get the proper penetration. Similarly, newly dug but still unplanted beds should be watered daily so they will not lose their moisture content. A transplant in a bed which has a low moisture level (except in the recently watered upper 2 inches or so) will have difficulty growing well because of the dry pan below. If you wait until plants are wilting and drooping to water, the plants will revive but they will have suffered some permanent damage—an open invitation for pests and diseases. Slight drooping, however, is not usually a sign you should water. Plants are just minimizing the water loss (due to transpiration) when they droop on a hot day and watering them at this time will increase water loss rather than lessen it. It will also weaken the plant through too much pampering.

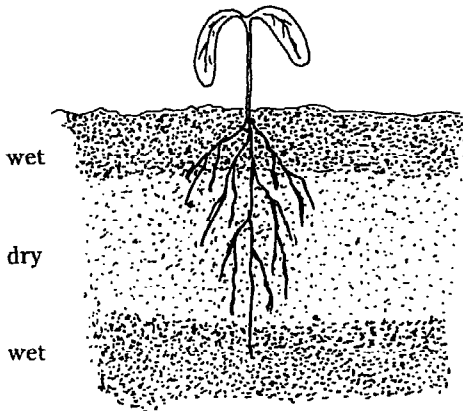

Dry pan

KEY WATERING FACTORS

The biodynamic/French intensive method is especially important for areas with scarce water. We have discovered that much more experimentation is needed in this area. Using the information below should assist you.

- Seventy-five percent of the Earth's land surface where food is generally grown receives 10 inches of rainfall or more.
- About *one-half* this rainfall can be retained in properly prepared soil for plant use.
- The biodynamic/French intensive method consumes an average of 10 gallons (a 5 to 20 gallon range) per 100 square feet while producing four times the food from that area in comparison with commercial agricultural practices. (Commercial food raising consumes about 20 gallons per day on the average for the same area.)

- Research by academic institutions has shown that soil which has living compost as 2% of its volume in the upper 11 inches of soil uses only about one-fourth the rainfall or irrigation required for poor soils! (Poor soils contain about one-half of 1% living compost in their upper soil area. "The method" utilizes an even higher amount of compost than the 2% amount.)
- Even under arid conditions, soil which is shaded can reduce evaporation up to 63% depending on soil type. The mini-climate from closely spaced plants provides good shading.
- Transpiration of water by the plant can be reduced as much as 75% in soils which contain good quantities of nutriment in the soil water. This biointensive method prepares the soil in a manner which provides for a high level of fertility.
- If one combines the upper three factors together, you find that water consumption can sometimes be reduced to 1/32 the level ($1/4 \times 1/2 \times 1/4$) normally experienced. We have found water consumption on the average to be 1/8 per pound of vegetable produced and about 1/3 per pound of grain produced once the soil is in reasonable shape.
- Native peoples in South Africa have been using a similar deep bed approach successfully with grains. They triple-dig(!) the soil, incorporating a lot of organic matter into it just before the seasonal rains. Immediately after the rains stop, seeds are planted. No more rain falls, yet crops are harvested at the end of the season. Others in the area are reportedly unable to grow crops well during this season.
- Using biointensive techniques, we feel people should be able to grow at least four times the yield under natural rainfall conditions (when not irrigating) than is obtained under the same conditions with commercial natural rainfall techniques. Let us know what works for you.
- American Indians in the Southwestern United States have used a number of approaches to grow food in limited rainfall areas. One is to make your growing area into large square-shaped diamonds on a slight slope with one point each being at the top and the bottom of the slope. Crops are planted in the bottom 1/4 to 1/2 of the square—depending on how much rainfall there is. (More water per unit of soil area has been concentrated in the bottom part of the square.)
- To determine how much of the above square to plant, use the following information: approximately 10 inches of water per unit of area are needed to grow one complete crop in well prepared soil (623 gallons per 100 square



Sloped beds on flat ground—side view

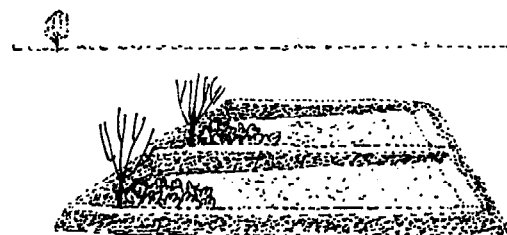

Indian diamond beds

feet) during the season. To have this amount of water retained in the soil, about 20 inches of rainfall must occur. If only 10 inches fall, you would have only 1/2 the water needed and so would plant only the bottom one-half of each diamond. If you had only 5 inches of rain, you would only have 1/4 the water needed for a crop and so would only plant the bottom 1/4 of the square (more or less). Experimentation will be required before you have optimum success. Be careful not to overplant. A soil with all water removed does not rewet or absorb water easily. This will lead to erosion. To be on the safe side start with a small area and plant 1/4 less crop than the 1/2 and 1/4 crop areas noted above to insure some moisture is retained in the soil. Once you are successful, the area under cultivation can be increased. Please share your experiences with us and others so this approach can be better understood.

- Be sure to realize that you are watering *the soil*, not the plant. Keeping the soil *alive* will retain water best and minimize the water consumed!
- See the *Dry Farming* book listed under "Water" in the Bibliography for more dry farming information.



Correct posture for easy weeding.

Weeding

Weeding intensively planted raised beds is not required as often as in other gardening methods due to the living mulch provided by the plants. Usually, weeding needs to be performed only once, about a month after the bed is planted. A bed prepared in a new area may have to be weeded more often at first, however, since many dormant seeds will be raised to a place in the soil where they can germinate readily. Over a period of time, as the soil becomes richer and more alive, you will probably have fewer weeds, since they tend to thrive more in poor and deficient soils rather than in healthy ones.

There really is no such thing as a "weed". A weed is just a plant which is growing in an area where you, the gardener, do not want it to grow. In fact, many so called weeds, such as stinging nettle, are quite beneficial to the soil and other plants. (This will be discussed in more detail in the chapter on Companion Planting.) Instead of weeding indiscriminately, the natures and uses of the different weeds should be learned so you will be able to identify and leave some of the most beneficial ones in the growing beds. The weeds taken out should be placed in the compost pile. They are rich in trace minerals and other nutrients, and will help grow good crops in the next season. And until taken out, the weeds help establish a faster, nourishing mini-climate for your current crops.

Weeds are generally heartier than cultivated plants since they are genetically closer to the parental plant stock and nearer to the origin of the plant species. They tend to germinate before cultivated plants. Usually you should wait to remove these plants from the beds until the cultured plants catch up with the weeds in height or until the cultured plants become established (about transplanting size)—whichever comes first. Weeding before this time is likely to disturb the germinating cultured plant seeds or to disturb the developing new plant root systems, causing interrupted plant growth and a weakened plant. Be sure to remove any grass plants which develop in the beds even after the first weeding. These plants put out incredibly large root systems which interfere with those of other plants in their competition for nutriment and water.

Planting in Season

Vegetables, flowers and herbs—all plants for that matter—should be planted in season. This is a good way to love your plants. If they are forced (grown out of season), much of their energy is used up straining to combat unseasonable weather in the form of cold, heat, rain or drought. Less energy is left for balanced growth, and a plant with limited reserves of energy is more susceptible to disease and insect attack. Plants are not unlike people.

SATISFACTORY (AND OPTIMAL) PLANT GROWING TEMPERATURE RANGES²²

Determine Planting Range Calendar For Your Own Area

Crop Season	Temp. Range	Optimal Temp. Range	Plant
<i>Cool Season Crops</i>	30 °F.		Asparagus • Rhubarb
	45-85 °F.	(55-75 °F.)	Chicory • Chive • Garlic • Leek • Onion • Salsify • Shallot
	40-75 °F.	(60-65 °F.)	Beet • Broad Bean • Broccoli • Brussels Sprouts • Cabbage • Chard • Collard • Horseradish • Kale • Kohlrabi • Parsnip • Radish • Rutabaga • Sorrel • Spinach • Turnip
	45-75 °F.	(60-65 °F.)	Artichoke • Carrot • Cauliflower • Celeriac • Celery • Chicory • Chinese Cabbage • Endive • Florence Fennel • Lettuce • Mustard • Parsley • Pea • Potato
<i>Warm Season Crops</i>	50-80 °F.	(60-70 °F.)	Bean • Lima Bean
	50-95 °F.	(60-75 °F.)	Corn • Cowpea • New Zealand Spinach
	50-90 °F.	(65-75 °F.)	Pumpkin • Squash
	60-90 °F.	(65-75 °F.)	Cucumber • Muskmelon
<i>Hot Season Crops</i>	65-80 °F.	(70-75 °F.)	Sweet Pepper • Tomato
	65-95 °F.	(70-85 °F.)	Eggplant • Hot Pepper • Okra • Sweet Potato • Watermelon

22. From James Edward Knott, *Handbook for Vegetable Growers*, John Wiley & Sons, Inc., New York, 1957, pp. 6-7.

SOIL TEMPERATURE CONDITIONS FOR VEGETABLE SEED GERMINATION²³

CROP	Minimum, °F.	Optimum Range, °F.	Optimum, °F.	Maximum, °F.
Asparagus	50	60-85	75	95
Bean	60	60-85	80	95
Bean, Lima	60	65-85	85	85
Beet	40	50-85	85	95
Cabbage	40	45-95	85	100
Carrot	40	45-85	80	95
Cauliflower	40	45-85	80	100
Celery	40	60-70	70*	85*
Chard, Swiss	40	50-85	85	95
Corn	50	60-95	95	105
Cucumber	60	60-95	95	105
Eggplant	60	75-90	85	95
Lettuce	35	40-80	75	85
Muskmelon	60	75-95	90	100
Okra	60	70-95	95	105
Onion	35	50-95	75	95
Parsley	40	50-85	75	90
Parsnip	35	50-70	65	85
Pea	40	40-75	75	85
Pepper	60	65-95	85	95
Pumpkin	60	70-90	95	100
Radish	40	45-90	85	95
Spinach	35	45-75	70	85
Squash	60	70-95	95	100
Tomato	50	60-85	85	95
Turnip	40	60-105	85	105
Watermelon	60	70-95	95	105

*Daily fluctuation to 60° or lower at night is essential.

23. From James Edward Knott, *Handbook for Vegetable Growers*, John Wiley & Sons, Inc., New York, 1957, p. 8.

Planning Charts

The large planning charts which follow should be helpful. They are in great part based on our experience. They are generally complete and accurate. As testing continues the information will be revised and the chance of error reduced. It should be noted that

- Maximum yields may not be reached in the first year. Also, one plant, grown alone, will probably not produce as large a yield as one plant grown among several under mini-climate conditions.
- Seeds grown out of season will take longer to germinate and/or may decompose before they do unless grown under special miniature greenhouse or shade netting house conditions.
- Closer spacing may be needed during the winter to make up for the slower plant growth during this period and to create a balanced winter mini-climate. (Try 3/4 or 1/2 the spacing distance with lettuce.) Closer spacing is sometimes also used to promote faster, balanced growth due to a more rapidly reached mini-climate. Extra plants are thinned to make room for larger plants. Baby carrots and beets are a delicacy!
- For more cultural detail about each crop, see also the Ten Speed Press edition of *The Vegetable Garden*.

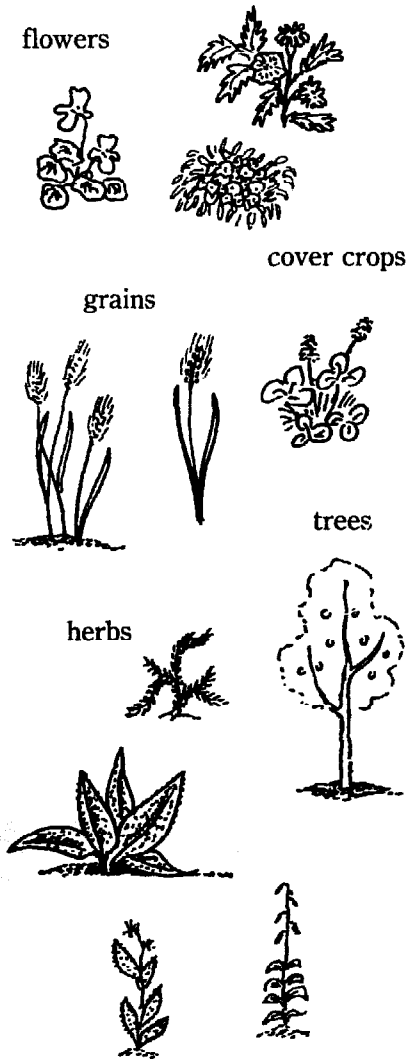

The planning charts on the following tables will let you expand from vegetable crops to the broad and more permanent scope of

- Grains, Protein Source, and Vegetable Oil Crops
- Cover, Organic Matter, and Fodder Crops
- Tree and Cane Food Crops
- Energy, Fiber, Paper, and Other Crops

Eventually, we hope to add Tree Crops for fuel and building materials. If you seek more information than is contained in these detailed charts, you can refer to the books listed in the Bibliography.

One of the exciting things about biointensive growing is its emphasis on the soil. Once you know how to prepare it well for vegetables, a whole world of crops becomes available. The bed preparation, fertilization, and watering approaches remain essentially the same—only the plant spacings are different!

There is a convenient soil improvement succession to know about. Vegetables the first year improve soil for grains

the second year, and the vegetables and grains for the even more permanent tree crops the third year. This follows an improvement in your skill as well.

If you want to study the learning process more closely, there are two Ecology Action booklets for this: a "Five to Ten Crop/Five Year Test and Learning" booklet including programs for vegetable, grain, fodder, and tree crops, and a "Soybean Test" booklet.

It is especially important to emphasize that a permanent crop-growing system begins with the soil. Even biological and tree cultivation systems can be environmentally unsound if improperly used. Dr. Hans Jenny, soil scientist emeritus at the University of California, Berkeley, pointed to this in *Science* magazine:

At the turn of the century, farsighted agricultural experiment stations set up permanent cultivation plots and monitored for decades the nitrogen and carbon balances. Stirring soil and removing crops initiated profound declines in nitrogen, carbon, and humus substances and caused deterioration of soil structure. Under these circumstances water infiltration is reduced and runoff and sheet erosion are encouraged. Crop yields suffer. While applications of nitrogen fertilizers boost yields, they have not restored the soil body. In central Europe, farmers used to remove forest litter and put it on their fields for manuring. Tree production declined markedly, documented by Aaltonen. . . ^{23a}

I am arguing against indiscriminate conversion of biomass and organic wastes to fuels. The humus capital, which is substantial, deserves being maintained because good soils are a national asset. The question will be raised, How much organic matter should be assigned to the soil? No general formula can be given. Soils vary widely in character and quality.

The growing of crops must be approached, then, with a sensitivity to how *the way* they are being grown affects the sustainability of the soil's vitality and health. An understanding of this proper relationship will take us all some time to develop and eventually will involve the growing of many different crops including a large number of trees. Trees beneficially modify our climate, bring up and make available nutrients from deep down in the soil, protect the soil from erosion, help maintain healthy water tables, and provide us with food and building materials.

These new charts are less developed than the ones for vegetables because we have done less work on the crops involved. They do provide a rough picture of what you can begin to accomplish in your own backyard or small farm-holding. (Also see Ecology Action's booklet, "Food From Your Backyard Homestead.") More information about additional

23a. V.T. Aaltonen, *Boden und Wald*. (Parey, Berlin, 1948)

special seed sources, harvesting, cleaning, grinding, storing, and preserving these crops will be included as time permits.

When planning, remember to look closely at *all* the factors involved. For example, sesame seeds are very high in nutrition, but they usually have low yields (compared with other protein crops), are somewhat difficult to harvest, and exhaust the soil. So on a per-square-foot, sustainable nutrition yield basis, sesame seeds are not particularly superior to other protein sources, even though they are great nutritionally and good to eat. A large harvest of sesame seeds would also require a very large growing area. It is important to examine each crop's total *practicality*.

As you begin to plant at an intermediate level, another factor to consider is the quantity of nutrients taken from the soil by each crop. Many "heavy givers" of nitrogen can exhaust the soil of other nutrients over time. Soybeans are "heavy giving" legumes, but continuous cropping of them has been demonstrated to wear out the soil. It is important to develop and work within natural sustainable cycles.

Food value columns have been added to the planning charts for protein, calories, and calcium for each crop. These are key, but many other ones are important—including iron, vitamins, and amino acids. Reference books are listed in the Bibliography so this area can be pursued further. Be sure to explore growing cover crops in between your trees to increase the friability of the soil and its nitrogen and organic matter content. An easy procedure for this is to remove about 1/4 inch of soil from the tree bed after digging it. Shape and fertilize the bed. Then run rake tines lightly over the soil to create small "furrows." Broadcast the seed into the bed, and cover the area with the light covering of soil removed earlier. Finish by tamping the bed with the digging board and water gently. Try medium red clover. It can be cut up to three times before it is dug in and has beautiful red flowers.

The spacings and other growing information for grains, fodder crops, fibers, bush and dwarf fruit trees, other tree crops, berries and grapes, and cover crops are under study by Ecology Action. Increasingly more people want to grow them. They are fun to try. One hundred square feet of grain may yield 4, 8, 12 or more pounds of edible seed. If you are in a cooler climate and wish to grow beans for eating, try varieties such as the peanut, yellow-eye, and cranberry beans available from the Vermont Bean Seed Company. Dwarf fruit trees, if nurtured properly can yield 50 to 100 pounds of fruit annually at maturity. Two trees on 8-foot centers in 100 square feet can yield as high as 200 pounds together, and the average person in the United States eats only about 162 pounds of tree fruit. Fava beans may yield the greatest amount of organic matter for you. Alfalfa and clover are also fun to use.

Our goal with wheat is to eventually get two, 26-pound crops in an 8 month period. This would make possible one 1-pound loaf of bread for every week in the year from 100 square feet! Then we could literally raise our own bread in our backyards. Wheat can be threshed easily with a mini-thresher^{23b} made available by a public organization in your area. Sound impossible? Yields close to this are already occurring in some parts of the world. Our highest wheat yield to date is at the rate of about 21 pounds per 100-square-foot bed using about 10 inches of water for the whole season, compost we grew ourselves for fertilizer, and a small amount of purchased organic fertilizers. The Zulus in South Africa use a technique similar to the biodynamic/French intensive method and grow grains with natural rainfall. See what you can do! Let us know if you get to 26 pounds—and how you do it!

23b. One good foot-treadle powered model is available from CeCe Co., P.O. Box 8, Ibaraki City, Osaka, Japan.

Bio-intensive techniques can be used to grow important protein crops. Research with wheat has been very promising. Tests with soybeans and other seeds, grains and beans will continue.



VEGETABLES AND GARDEN CROPS

PLANT		SEED			YIELD		
		B Approx. Seeds/Ounce ²⁴	C Minimum Legal Germination Rate ²⁵	D Ounces Seed/100 Sq. Ft. (Adj. for Germ. Rate, Offset Spacing, and Curv. Surf.) ^{26, 30}	E Possible B/FIM Pounds Yield/100 Sq. Ft. ^{27a}	F Possible B/FIM Pounds Yield/Plant ²⁸	G Avg. U.S. Pounds Yield/100 Sq. Ft. ²⁸
A	Plant						
1	Artichoke, Jerusalem	Sprouted 2 oz. tuber pieces	—, R	10.5 lbs.	100-206-420+	1.2-5+	D
2	Artichoke, Regular	From divided roots	D	3 roots	D	D	16.5
3	Asparagus	700	.70	32 or 159 roots	9.5-19-38	.06-.24	5
4	Beans, Broad, Fava	20-70	.70 ^R	22.8-6.5-22.8-6.5	5.9-18.1+ 50-180-360 Wet weight: above ground biomass	.015-.056 .28-1.1	D D
5	Beans, Lima, Bush	20-70	.70 ^R	44.3-12.7	11.5-17.2-23 Dry	.018-.037	5.7
6	Beans, Lima, Pole	20-70	.70 ^R	22.8-6.5	11.5+-17.2+-23+ Dry	.035+-0.071+	5.7+
7	Beans, Snap, Bush	100	.75 ^R	17.9	30-72-108	.022-.08	8.2
8	Beans, Snap, Pole ^N	100	.75 ^R	8.3	30+-72+-108+	.048+-0.171+	8.2+
9	Beets, Cylindra	1,600	.65 ^R	2.4	110-220-540 Roots 55-110-270 Tops	.044-.21 .021-.1	D D
10	Beets, Regular	1,600	.65 ^R	2.4	55-110-270 Roots 55-110-270 Tops	.02-.1 .02-.1	30 D
11	Broccoli	9,000	.75	.01	28-39-53 Heads 52+-78+-106+ Leaves	3-63 8-1.26	17.4 D
12	Brussels Sprouts	8,500	.70	.01	71-106-142	1.3-2.6	23.4
13	Cabbage, Chinese	9,500	.75	.03	96-191-383	.47-1.9	D
14	Cabbage, Regular	8,500	.75	.01	96-191-383	1.1-4.5	45
15	Carrots	23,000	.55 [#]	.46	100-150-1,080	.016-.18	58.9
16	Cauliflower	10,000	.75	.01	44-100-291	.52-3.4	23
17	Celery	70,000	.55	.016	240-480-959+	.38-1.5	110
18	Chard, Swiss	1,200	.65 ^D	.75	200-405-810	.62-2.5	D
19	Collards	8,000	.80	.025	96-191-383	6-2.4	D
20	Corn, Sweet	100-200	.75	11.55 1.4-1	17-34-68 Shelled, Wet	3.8 3-1.3	15.3
21	Cucumbers	1,000	.80	.2	158-316-581	1.0-3.6	20.6
22	Eggplant	6,000	.60	.015	54-108-163	1.0-3.0	35.6
23	Garlic	12 ^{ZZ}	.5 ^{ZZ}	26.1 lbs.	60-120-240+	.02-.096+	32
24	Horseradish	Live roots used	—	159 roots	D	D	D
25	Kale	10,000	.75	.01	78-114-153	3-1.8	16.0
26	Kohlrabi	8,000	.75	.22	67-135-270	0.7-2	D
27	Leeks	11,000	.60	.38	240-480-980	.095-.38	D
28	Lettuce, Head	25,000	.80	.007	75-150-300	.47-1.9	48.6
29	Lettuce, Leaf	25,000	.80	.016	135-202-540	.4-1.7	48.6

BEDS/FLATS							MATURITY		RE- MARKS	FOOD NEEDED	SEED YIELD	Heavy Giver (HG), Light Feeder (LF), Low Nitrogen User (LNU), Heavy Feeder (HF)
H	I	J	K	L	M	N	O	P	Q	R	S	
In BED Spacing In Inches	Maximum Number of Plants/100 Sq. Ft. ³⁰	Short/Long/ Extra-Long Germ. Rate	Plant Initially In Flats/Beds	In FLATS Spacing in Inches ³¹	Approx. Plants/Flat (Adj. for Germ. Rate) ^{31,32}	Approx. Time In Flats-In Weeks ^{31,33}	Approx. Weeks to Maturity	Harvesting Period In Weeks—Up To:	Remarks and Especially Good Varieties	Pounds Consumed/Year ³⁴ Avg. Person in U.S.	Approx. Max. Pounds Seed Yield/100 Sq. Ft. ⁴⁰	
15	84	L	F	1 2	187 60	4-6# 8-10 2-3	17-26	—	—	D	420+	HF
72	8	L	B	—	—	—	D, F	8	—	D	D	HF
12	159	L	F	1 2	175 60	4-6# 8-10 2-3	17-26	8	—	1.2	8.7	HF
8	320	S	B	—	—	—	11-26	8	Fast Beans	D	18.0	HG
6	621	S	B	—	—	—	9-11	12	—	1.3	17.8	HG
8	320	S	B	—	—	—	11-13	12	—		22.3	HG
4	1,343	S	B	—	—	—	8	12	—	8.5	17.0	HG
6	621	S	B	—	—	—	8-9	12	—		29.7	HG
3	2,507	S	B	—	—	—	8-9	—	Twice the Weight	1.9	30.6	LF
3	2,507	S	B	—	—	—	8-9	—	—		30.6	LF
15	84	S	F	1 2	187 60	4-6# 8-10 2-3	8-9	4-8	—	1.3	6.5	HF
18	53	S	F	1 2	175 60	4-6# 8-10 2-3	11-13	12	—	3	2.8	HF
10	201	S	F	1 2	187 60	4-6# 8-10 2-3	7-11**	—	—	D	6.1	HF
15	84	S	F	1 2	187 60	4-6# 8-10 2-3	9-16**	—	—	10.7	3.6	HF
2	5,894	S	B	—	—	—	9-11	—	—	8.4	17.8	LF
15	84	S	F	1 2	187 60	4-6# 8-10 2-3	8-12**	—	44a	1.3	1.0	HF
6	621	L/EL	F	1 2	157 60	4-6# 8-10 2-3	15-19	—	—	7.5	9.9	HF
8	320	S	B	—	—	—	7-8	44	Danger Forthook	D	29.0	HF
12	159	S	F	1 2	200 60	4-6# 8-10 2-3	12	24	44	D	D	HF
12	84	S	F	1 2	187 60	4-6# 8-10 2-3	9-13**	—	—	Shelled Wet 13.0	10.3	HF
12	159	S	F	2 —	48 —	3-4 —	7-10	26	—	3.1 Reg. 7.6 Pickle	4.1	HF
18	53	L/EL	F	1 2	150 60	6-8# 12-14 4-6# 8-12	10-11	13	—	.5	.6	HF
3	2,507	L	F	1 —	122 —	4-6 —	17-26	—	—	.3	240 (Bulbs)	LF
12	159	L	B	—	—	—	26	—	—	D	D	LF
15	84	S	F	1 2	187 60	4-6# 8-10 2-3	8-9	17	—	D	3.8	HF
4	1,343	S	F	1 —	157 —	4-6# 8-10 2-3	7-8	—	—	D	20.1	LF
3	2,507	S	F	1 —	150 —	4-6# 8-10 2-3	19	—	—	D	9.8	LF
12	159	S	F	1 2	200 60	4-6# 8-10 2-3	11-13	—	—	2.2	1.2	HF
8	320	S	F	1 2	200 60	2-3 1-2	6-13**	—	—		2.0	HF

**VEGETABLE
AND GARDEN
CROPS**
(Continued)

		FOOD NEEDED	MATERIALS NEEDED			
		B	C	D	E	F
PLANT	Plant	<i>Pounds You Select</i>	<i>Approx. Number Plants You Need³⁵</i>	<i>Approx. Sq. Ft. You Need³⁶</i>	<i>Approx. Flats You Need³⁷</i>	<i>Approx. Ounces/Seed You Need³⁸</i>
A						
1	Artichoke, Jerusalem					
2	Artichoke, Regular					
3	Asparagus					
4	Beans, Broad					
5	Beans, Lima, Bush					
6	Beans, Lima, Pole ^N					
7	Beans, Snap, Bush					
8	Beans, Pole ^N					
9	Beets, Cylindra					
10	Beets, Regular					
11	Broccoli					
12	Brussels Sprouts					
13	Cabbage, Chinese					
14	Cabbage, Regular					
15	Carrots					
16	Cauliflower					
17	Celery					
18	Chard					
19	Collards					
20	Corn, Sweet					
21	Cucumbers					
22	Eggplant					
23	Garlic					
24	Horseradish					
25	Kale					
26	Kohlrabi					
27	Leeks					
28	Lettuce, Head					
29	Lettuce, Leaf					

YIELDS		MISC.						NOTES
G	H	I	J	K	L	M	N	O
Your Actual Yield/100 Sq. Ft.	Your Yield Compared With U.S. Avg. ³⁹	Time of Year To Plant (SP, SU, FA, VI)	Special Seed Sources	Special Harvesting/Preparation/Storage Information	Protein Content/Pound In Grams (g) (454g/Pound) ^{44b}	Calorie Content/Pound ^{44b}	Calcium Content/Pound In Milligrams (mg) ^{44b}	
		SP	44c	See Notes	7.2 Raw.	22 Fresh 235 Stored	44 for a long time.	Used in alcohol production for gasahol. Good source of organic matter. Harvest when top is dead.
		FA	—	—	5.3 Raw.	16 Fresh 85 Stored	99 for a long time.	31% Refuse.
		SP	—	—	6.4 Raw.	66 44%	56 Refuse.	Excellent organic matter crop. CAUTION: Beans can be toxic to some people.
		FA, SP	—	—	13.0 113.9	162 1,533	42 463	:In Pods, 66% Refuse :Dry Beans
		SU	—	See Notes	92.5 Dry Seeds.	1,565	327	Pick when beans are bulging through pods so plants will set more beans.
		SU	—	See Notes				
		SP, SU	—	See Notes	7.6 Raw.	128	224 12% Refuse.	
		SP, SU	—	See Notes				
		SP, SU FA	—	—	5.1 Raw. Roots 30% "Refuse" (Tops.)	127	51	Excellent tops often mean too much nitrogen fertilizer and poor root growth. Cylindra variety can be a good organic matter crop.
		SP, SU FA	—	—	5.8 Raw. Greens	6.1	302 ^M	
		SP, FA	—	—	12.7 13.6	113 158	304 1,139	:Head, Raw, 22% Refuse. :Leaves, Raw. Contain more nutrition than head type.
		SP, FA	—	—	20.4 Raw.	188 8%	180 Refuse.	When sprout node begins to bulge, remove leaf below it for best growth.
		SP, FA	—	—	5.3 Raw.	62 3%	189 Refuse.	
		SP, FA	—	—	5.3 8.2	98 127	200 171	:Green, Raw 10% Refuse :Red Raw.
		SP, SU, FA	—	—	4.1 Raw.	156 Without tops.	134 18% Refuse.	Excellent tops often mean too much nitrogen fertilizer and poor root growth.
		SP, FA	—	—	12.2 Raw.	122	113	Cauliflower head often develops in just a few days.
		SP, FA	—	—	3.1 25%	56 Refuse.	133	
		SP, SU, FA	—	See Notes	16.0 Raw.	104 8%	397 ^M Refuse.	Harvest sequentially as leaves mature. Good organic matter crop.
		SP, FA	—	See Notes	16.3 Raw leaves and stems.	181	921	See above. Δ
		SU	—	See Notes	8.7 Raw.	240 45%	7 Refuse (cob).	Harvest when fluid in kernal is half way between clear and milky.
		SU	—	See Notes	3.9 Raw,	65 whole.	108 5% Refuse.	Harvest when swollen, but not yellowing for sweetest taste.
		SU	—	—	4.4 Raw.	92 19%	44 Refuse.	
		SP, FA	—	—	24.8 Raw.	547 12%	116 Refuse.	Most of bulb growth occurs in last 45 days. Contains antibiotics.
		SP, FA	—	—	10.6 Raw.	288 27%	464 Refuse.	
		SP, FA	—	—	14.1 Raw leaves and stems.	126	601 26% Refuse.	Good vitamin and mineral content.
		SP, FA	—	—	6.6 Raw.	96 27%	136 Refuse.	
		SP, FA	—	—	5.2 Raw.	123 48%	123 Refuse.	
		SP, FA	—	See Notes	3.9 Raw.	56 5%	86 Refuse.	Not very nutritious. Harvest in very early morning for best taste.
		SP, FA	—	See Notes	3.8 Raw.	52 36%	197 Refuse.	Harvest in very early morning for best taste.

VEGETABLE AND GARDEN CROPS
(Continued)

PLANT		SEED			YIELD		
		B Approx. Seeds/Ounce ²⁴	C Minimum Legal Germination Rate ²⁵	D Ounces Seed/100 Sq. Ft. (Adj. for Germ. Rate, Offset Spacing, and Curv. Surf.) ^{26, 30}	E Possible B/FIM Pounds Yield/100 Sq. Ft. ^{27, 27a}	F Possible B/FIM Pounds Yield/Plant ²⁸	G Avg. U.S. Pounds Yield/100 Sq. Ft. ²⁹
30	Melons	1,200	.75	.09	50-72-145	.6-1.7	^{20C} / _{36.5H}
31	Mustard	15,000	.75	.055	180-225-270	.29-.43	D
32	Okra	500	.50	.64	30-60-120	.19-.75	D
33	Onions, Bunching	9,500	.70 ^R	3.5	100-200-540	.004-.023	D
34	Onions, Regular	9,500	.70	.38	100-200-540	.04-.2	} 6.8
35	Onions, Torpedo	9,500	.70	.38	200-400-1,080	.08-.43	
36	Parsley	18,000	.60	.12	26-52-106	.02-.08	D
37	Parsnips	12,000	.60 [#]	3.5	119-238-479	.047-.19	D
38	Peas, Bush	50-230	.80 ^R	3.9 lbs. - 13.7 oz.	25-53-106	.01-.04	} 68.6
39	Pole ^N	50-230	.80 ^R	2.1 lbs. - 7.3 oz.	25+-53+-106+	.02-.08+	
40	Peppers, Cayenne	4,500	.55	.064	10-25-40	.06-.25	D
41	Peppers, Sweet, Green	4,500	.55	.064	36-83-131	2-.8	18.8
42	Potatoes, Irish	— ⁴⁷	—	23.25 lbs. - 31 lbs.	100-200-780	4-3.1	52.6
43	Potatoes, Sweet	— ⁴⁹	—	31 lbs. - 41.25 lbs.	82-164-492	.33-2.0	23.6
44	Pumpkin	110	.75	.16	48-96-191	3.4-13.6	D
45	Radishes	2,000	.75 ^R	3.9	100-200-540	.017-.09	D
46	Rhubarb	1,700 ^Y	.60 ^Y	.025	D	D	D
47	Rutabagas	12,000	.75	.07	200-400-960	.3-1.5	D
48	Salsify	1,800	.75 ^B	4.4	200-400-1,080	.03-.18	D
49	Shallots	8 ^N	.75 ^Y	26.3 lbs.	60-120-240+	.02-.01+	D
50	Spinach, New Zealand	350	.40	1.14	180-225-270	1.1-1.7	D
51	Spinach, Regular	2,800	.60	.8	50-100-225	.037-.17	12.1
52	Squash, Crook Neck	300 (Bush)	.75	.37	35-75-150	.4-1.8	D
53	Squash, Patty Pan	300 (Bush)	.75	.37	75-150-307	.9-3.6	D
54	Squash, Winter	100(Vine)	.75	.19	50-100-191	5.6-13.6	D
55	Squash, Zucchini	300 (Bush)	.75	.24	160-319-478+	3.0-9.0	D
56	Sunflowers	650 (In Shell) ^Y	.50+ ^Y	.08	2.5-5-10	.09-.37	2.4
57	Tomatoes	11,000	.75	.006/.004/.003	100-194-418	1.9-16.0	30.7
58	Turnips	13,000	.80 ^R	.24	100-200-360	.04-.14	D
59	Watermelon	225-300	.70	1.0-.76/34-.25/ 22-.17/.17-.12	50-100-320	.31-12.3	24.3

BEDS/FLATS							MATURITY		RE- MARKS	FOOD NEEDED	SEED YIELD	Heavy Giver (HG), Light Feeder (LF), Low Nitrogen User (LNU), Heavy Feeder (HF)
H In BED Spacing In Inches	I Maximum Number of Plants/100 Sq. Ft. ³⁰	J Short/Long/ Extra-Long Germ. Rate	K Plant Initially In Flats/Beds	L In FLATS Spacing in Inches ³¹	M Approx. Plants/Flat (Adj. for Germ. Rate) ^{31,32}	N Approx. Time In Flats-In Weeks ^{31,33}	O Approx. Weeks to Maturity	P Harvesting Period In Weeks—Up To:	Q Remarks and Especially Good Varieties	R Pounds Consumed/Year ³⁴ Avg. person in U.S.	S Approx. Max. Pounds Seed Yield/100 Sq. Ft. ⁴⁰	
15	84	S	F	2	45	3-4	12-17**	13	— ⁴⁵	7.8 ^C	2.9	HF
6	621	S	F	1	187	3-4	5-6	8	—	D	5.7	HF
12	159	L	F	1 2	125 60	6-8 3-4	7-8	13	—	D	9.3	HF
1	23,450	S	B	—	—	—	17	—	—	D	39.6	LF
3	2,507	S	F	1	175	10-12* 12-14	14-17	—	—	1.2	10.3	LF
3	2,507	S	F	1	175	10-12# 12-14	14-17	—	— ⁴⁶		10.3	LF
4	1,343	L/EL	F	1 2	150 60	8-12 6-8	10-13	40	—	D	24.8	HF
3	2,523	L	B	—	—	—	15	—	—	D	24.8	LF
3	2,523	S	B	—	—	—	8-10	12	—	5.9	21.6	HG
4	1,343	S	B	—	—	—	10-11	12	—		12.1	HG
12	159	L/EL	F	1 2	137 60	6-8# 12-14 4-6	9-11	17	—	D	.1	HF
12	159	L/EL	F	1 2	137 60	6-8# 12-14 4-6	9-12	17	—	2.5	.3	HF/LNU
9 centers 6 depth	248	L	Sprout in dark place	—	—	—	17	—	— ⁴⁸	133.4	200- 600	LF
9 centers 6 depth	248	L	F	3	30	3-4	26-34	—	—	6.2	492	LF/LNU
30	14	S	F	2	45	3-4	14-16	—	— ⁵⁰	.6	5.1	HF
2	5,894	S	B	—	—	—	3-9**	—	— ⁵¹	D	20.6	LF
24	26	L	F	1 2	150 80	D D	3 Years Roots 1 Yr.	D	— ⁵²	.03	D	HF
6	621	S	F	1	187	3-4	13	—	—	D	5.4	LF
2	5,894	S	B	—	—	—	17	—	—	D	27.7	LF
3	2,523	L	F	1	122	4-6	17-26	—	—	D	240	LF
12	159	L	F	2	24	3-4	10	42	Drought Resistant	D	17.2	HF
4	1,343	S	F	1	150	3-4	6-7	—	—	1.8	10.8	HF
15	84	S	F	2	45	3-4	10	17+	—	D	6.1	HF
15	84	S	F	2	45	3-4	7	17+	—	D	6.1	HF
30	14	S	F	2	45	3-4	11-17**	17+	—	D	5.7	HF
18	53	S	F	2	45	3-4	7-9	26	Burpee's Fordhook	D	6.1	HF
24	26	S	F	1 2	100 60	2-3 1-2	12	—	—	D	D	HF
18/21/24 T	59/35/26	S	F	1 2	187 60	6-8# 12-14 8-4	8-13	17+	—	31.1	5.5	HF
3	2,523	S	F	—	—	—	5-10**	—	—	D	14.7	LF/LNU
12/18/ 21/24 W	159/53 35/26	S	F	2	42	3-4	10-13	13	— ⁵³	13.9	2.6	HF

VEGETABLES AND GARDEN CROPS (Continued)

VEGETABLES AND GARDEN CROPS (Continued)		FOOD NEEDED		MATERIALS NEEDED		
		B	C	D	E	F
PLANT		<i>Pounds You Select</i>	<i>Approx. Number Plants You Need³⁵</i>	<i>Approx. Sq. Ft. You Need³⁶</i>	<i>Approx. Flats You Need³⁷</i>	<i>Approx. Ounces/Seed You Need³⁸</i>
A	<i>Plant</i>					
30	Melons					
31	Mustard					
32	Okra					
33	Onion, Bunching					
34	Onions, Regular					
35	Onions, Torpedo					
36	Parsley					
37	Parsnips					
38	Peas, Bush					
39	Peas, Pole ^N					
40	Peppers, Cayenne					
41	Peppers, Green					
42	Potatoes, Irish					
43	Potatoes, Sweet					
44	Pumpkin					
45	Radishes					
46	Rhubarb					
47	Rutabagas					
48	Salaty					
49	Shallots					
50	Spinach, New Zeland					
51	Spinach, Regular					
52	Squash, Crook Neck					
53	Squash, Patty Pan					
54	Squash, Winter					
55	Squash, Zucchini					
56	Sunflowers					
57	Tomatoes					
58	Turnips					
59	Watermelon					

YIELDS		MISC.						NOTES
G	H	I	J	K	L	M	N	O
Your Actual Yield/100 Sq. Ft.	Your Yield Compared With U.S. Avg. ³⁹	Time of Year To Plant (SP, SU, FA, WL)	Special Seed Sources	Special Harvesting/Preparation/Storage Information	Protein Content/ Pound In Grams (g) (454g/Pound) ^{44b}	Calorie Content/ Pound ^{44b}	Calcium Content/ Pound In Milligrams (mg) ^{44b}	
		SU	—	—	1.6 23	89 94	32 32	:Canteloup (50% Refuse). :Honeydew (37% Refuse).
		SP,FA	—	—	9.5 Raw	88 30%	681 Refuse	
		SU	—	—	9.4 Raw	140 14%	359 Refuse	
		SP, SU, FA	—	—	6.5 Raw	157 4%	222 Refuse	
		SP	—	—	6.2 Dry, raw.	157 99%	111 Refuse	
		SP	—	—	6.2 Dry, raw.	157 9%	111 Refuse.	
		SP	—	—	16.3 Raw.	200	921	
		SP,FA	—	—	6.6 Raw.	293 15%	193 Refuse.	
		SP,FA	—	See Notes	10.9 Green	145 62% Refuse (Pods).	45	Harvest when seeds are bulging in pods.
		SP,FA	—	—	10.9* Dry	1,542	290	Try Sugar Snap edible variety.
		SU	—	—	16.1 Raw	406 4%	126 Refuse.	
		SU	—	—	4.5 B.I.	82 112	33 47	:Green. 18% Refuse. :Red. 20% Refuse.
		SP,FA	44c	Harvest when tops dead	7.7 Raw.	279 19%	26 Refuse.	See above ^Δ
		SU	44d		6.6 6.2	375 430	118 118	
		SU	—	—	131.5 Raw	2,508 seeds.	231 Hulled.	Hulls 30% of unhulled weight. 3.2 83 67 Raw Fruit. 30% Refuse.
		SP,FA	—	—	4.1 Raw	69 without tops.	122	10% Refuse.
		SP	—	—	2.8 Raw	69 without leaves.	374 leaves.	14% Refuse. Green parts poisonous.
		SP,FA	—	—	4.2 Raw	177 15%	254 Refuse.	Very flavorful when biointensively grown.
		SP,FA	—	—	11.4 Raw	61 Fresh	185	Caloric content rises to 324 after being stored for some time.
		SP,FA	44e	—	10.0 Raw	287 12%	148 Refuse.	
		SP, SU, FA	—	—	10.0 Raw.	86	263	
		SP,FA	—	—	10.5 Raw.	85 28%	304 ^M Refuse.	
		SU	—	—	5.3 Raw.	89 2%	124 Refuse.	
		SU	—	See Notes	4.0 Raw.	93 2%	124 Refuse.	Harvest when bone white with only a little tinge of green left.
		SU	—	See Notes	4.3 4.5	167 177 117	107 102 57	:Acorn. Harvest when neck stem :Butternut: is dry. Raw. 24, 30 and :Hubbard: 34% refuse respectively.
		SU	—	See Notes	6.3 Raw	78 5%	121 Refuse	Harvest when 10 inches long. One pound contains a lot of protein and calcium.
		SU	—	—	108.9 Dry seeds	2,540 without hulls.	544	Hulls 46% of unhulled weight.
		SU	—	—	5.6	106	69	
		SP,FA	—	—	3.9 Raw.	117	152	
		SU	—	—	1.0 Raw.	54 54%	15 Refuse.	

GRAIN, PROTEIN SOURCE, VEGETABLE OIL CROPS

For protein also see: Beans, Lima — Beans, Broad, Fava — Buckwheat — Collards — Corn, Sweet — Garlic — Peas — Potatoes, Irish and Sweet — Squash, Zucchini — Sunflowers.

PLANT	SEED			YIELD		
	<i>Plant</i>	<i>Approx. Seeds/Ounce²⁴</i>	<i>Minimum Legal Germination Rate²⁵</i>	<i>Ounces Seed/100 Sq. Ft. (Adj. for Germ. Rate, Offset Spacing, and Curv. Surf.)^{26, 30}</i>	<i>Possible B/FIM Pounds Yield/100 Sq. Ft.^{27, 27a}</i>	<i>Possible B/FIM Pounds Yield/Plant²⁸</i>
1 Amaranth	53,400 <small>Grain type</small>	.70 ^A	.0014	Greens: 68-136-272+ Seed: 4-8-16+	1.3-5.1+ .075-.3+	D D
2 Barley, Beardless	900	.70 ^A	3.5-4.4	5-10-24	D	4.9
3 Beans, Kidney	50	.70 ^A	17.7	4-10-24	.003-.012	2.7
4 Beans, Lentil	600	.70 ^A	6.0	4-6-8+	.003-.019+	1.4
5 Beans, Mung	500	.70 ^A	3.8	4-10-24	.006-.038	2.7
6 Beans, Pinto	70	.70 ^A	12.7	4-10-24	.006-.038	2.7
7 Beans, Red	50-100	.70 ^A	17.7-8.3	4-10-24	.006-.038	2.7
8 Beans, White	90-180	.70 ^A	4.9-2.5	4-10-24	.006-.038	2.7
9 Chickpea (Garbanzo)	50	.70 ^A	38.4	4-10-24	.003-.012	D
10 Corn, Fodder	100-200	.75 ^A	7-35	11-17-23+	2-4+	11.3
11 Cowpea	150	.70 ^A	1.5/25/.08	4-10-24	.025-3.0	D
12 Grains, Perennial	The major work in this field is being performed by Wes Jackson at The Land Institute,					
13 Millet, Regular	2,200 <small>Unhulled</small>	.70 ^A	.28	4-10-30+	.009-.07+	D
14 Oats	950	.70 ^A	2.3-3.5	3-7-13+	D	3.3
15 Peanuts	20-70 Unshelled 30-90 Shelled	.70 ^A	11.8-3.9 Shelled	4-10-24	.016-.096	5.6
16 Pigeon Pea	D	.70 ^A	D	4-10-24	.003-.018	D
17 Rape	8,000	.70 ^A	D	D	D	D
18 Rice	1,100 <small>Unhulled</small>	.70 ^A	1.7	4-10-24	.003-.018	10.7
19 Rye, Cereal	1,300-1,700	.70 ^A	9.7	4-10-24	.005-.029	2.6
20 Safflower	640 Unhulled	.70 ^A	1.2	4-9-17+	.08-.33+	4.3
21 Sesame	11,000	.70 ^A	.08	1.5-3-6+	.007-.028+	D
22 Soybeans	100-180+	.75 ^A	8.3-4.6	4-8-14.4+	.006-.023+	3.6
23 Wheat, Duram	500 Hulled	.70 ^A	2.4	4-10-26	.005-.03	4.0
24 Wheat, Early Stone Age	800 Unhulled	.70 ^A	1.5	4-10-17+	.005-.02+	D
25 Wheat, Hard Red Spring	500 Hulled	.70 ^A	2.4	4-10-26	.005-.03	3.7
26 Wheat, Red Winter	500 Hulled	.70 ^A	2.4	4-10-26	.005-.03	4.3
27 Wheat, White	500 Hulled	.70 ^A	2.4	4-10-26	.005-.03	3.7

BEDS/FLATS							MATURITY		RE-MARKS	FOOD NEEDED	SEED YIELD	Heavy Giver (HG), Light Feeder (LF), Low Nitrogen User (LNU), Heavy Feeder (HF)
H	I	J	K	L	M	N	O	P	Q	R	S	
In BED Spacing In Inches	Maximum Number of Plants/100 Sq. Ft. ³⁰	Short/Long/ Extra-Long Germ. Rate	Plant Initially In Flats/Beds	In FLATS Spacing in Inches ³¹	Approx. Plants/Flat (Adj. for Germ. Rate) ^{31, 32}	Approx. Time In Flats-In Weeks ^{31, 33}	Approx. Weeks to Maturity	Harvesting Period In Weeks—Up To:	Remarks and Especially Good Varieties	Pounds Consumed/Year ³⁴ Avg. Person in U.S.	Approx. Max. Pounds Seed Yield/100 Sq. Ft. ⁴⁰	
18	53	S	F	1/2	175/42	3/2	17	4	—	D	16.0	HF
D	D	S	F	1/—	175/—	2/—	9-10	—	—	1.2	24.0	HF
6	621	S	B	—	—	—	12	8	—	6.3 All Dry Edible Beans	24.0	HG
3	2,507	S	B	—	—	—	12	8	—		8.0+	HF
4	1,343	S	B	—	—	—	12	8	—		24.0	HG
6	621	S	B	—	—	—	12	8	—		24.0	HG
6	621	S	B	—	—	—	12	8	—		24.0	HG
6	621	S	B	—	—	—	12	8	—		24.0	HG
4	1,343	S	B	—	—	—	9	8	—	D	24.0	HG
18	53	S	F	1/—	187/—	1-2/—	11-16	—	—	51.4 for Foodstuffs	22.6+	HF
12/24/ 36E	159/26 18	S	F	1/—	175/—	2/—	9-12	8	—	D	24.0	HG
Route 3, Salina, Kansas 67401. Send stamped, self-addressed envelope for publications information.												
7	432	S	F	1/—	175/—	2-4/—	10-13	—	—	D	30.0	HF
D	D	S	B	—	—	—	13-17	—	—	3.2 For Food Products	13.4+	HF
9	248	S	F	2/—	175/—	2-4/—	17	—	—	6.4	24.0	HG
4	1,343	S	B	—	—	—	8-10	8	—	D	24.0	HG
D	D	S	B	—	—	—	D	D	—	D	D	HF
4	1,343	S	F	1/—	175/—	2/—	17	—	Calrose	7.7	24.0	HF
5	833	S	F	1/—	175/—	2/—	17	—	—	.8	24.0	HF
18	53	S	F	1/—	175/—	2-3/—	17	—	—	D	17.4+	HF
6	621	L	F	1/—	175/—	3/—	13-17	8	—	D	5.6+	HF
6	621	S	F	1/—	187/—	2/—	8-9 Green 16-17 Dry	2-4	Altona	225.0	14.4+	HG
5	833	S	F	1/—	175/—	1-2/—	16-18	—	—	7.7 All Wheat	26.0	HF
5	833	L	F	1/—	175/—	2-3/—	16-20	—	—	D	17.0+	HF
5	833	S	F	1/—	175/—	1-2/—	16-18	—	—	7.7 All Wheat	26.0	HF
5	833	S	F	1/—	175/—	1-2/—	16-18	—	—		26.0	HF
5	833	S	F	1/—	175/—	1-2/—	16-18	—	—		26.0	HF

GRAIN, PROTEIN SOURCE, VEGETABLE OIL CROPS
(Continued)

		FOOD NEEDED	MATERIALS NEEDED			
		B	C	D	E	F
PLANT		<i>Pounds You Select</i>	<i>Approx. Number Plants You Need³⁵</i>	<i>Approx. Sq. Ft. You Need³⁶</i>	<i>Approx. Flats You Need³⁷</i>	<i>Approx. Ounces/Seed You Need³⁸</i>
A	<i>Plant</i>					
1	Amaranth					
2	Barley, Beardless					
3	Beans, Kidney					
4	Beans, Lentil					
5	Beans, Mung					
6	Beans, Pinto					
7	Beans, Red					
8	Beans, White					
9	Chickpea (Garbanzo)					
10	Corn, Fodder					
11	Cowpea					
12	Grains, Perennial					
13	Millet, Regular					
14	Oats					
15	Peanuts					
16	Pigeon Pea					
17	Rape					
18	Rice					
19	Rye, Cereal					
20	Safflower					
21	Sesame					
22	Soybeans					
23	Wheat, Duram					
24	Wheat, Early StoneAge					
25	Wheat, Hard Red Spring					
26	Wheat, Red Winter					
27	Wheat, White					

YIELDS		MISC.						NOTES
G	H	I	J	K	L	M	N	O
Your Actual Yield/100 Sq. Ft.	Your Yield Compared With U.S. Avg. ³⁹	Time of Year To Plant (SP, SU, FA, WI)	Special Seed Sources	Special Harvesting/Preparation/Storage Information	Protein Content/Pound In Grams (g) (454g/Pound) ^{44b}	Calorie Content/Pound ^{44b}	Calcium Content/Pound In Milligrams (mg) ^{44b}	
		SU	44e	—	15.9 69.5	200 1,775	1,212 2,224	:Greens: :Seed. Good calcium source. For latest information contact: R-dale Amaranth Project, 33 East Minor St., Emmaus, PA 18049
		SP, FA	—	—	37.2 43.5	1,583 1,579	73 154	:Light. :Pearled or Scotch.
		SU	44e	See Notes	102.1 Dry	1,556	499	} Harvest sequentially when seeds bulge through pods.
		SP	44i	See Notes	112.0 Dry	1,542	358	
		SU	44e	See Notes	109.8 Dry	1,542	535	
		SU	44e	See Notes	103.9 Dry	1,583	612	
		SU	—	See Notes	103.9 Dry	1,583	612	
		SU	44h	See Notes	101.2 Dry	1,542	653	
		SU	44g	See Notes	95.0 Dry	1,693	690	
		SU	44f	—	40.4 Dry	1,579	100	Also produces a lot of organic matter.
		SU	44i, 44h	See Notes	108.4 Dry	1,556	336	Harvest sequentially when seeds bulge through pods.
		—	—	—	—	—	—	
		SU	44f	—	44.9 Dry	1,483	91	High in iron.
		SP, FA	44e	—	64.4 Dry	1,769	240	
		SU	44i	—	117.9 Shelled	2,558 raw	313	Shells 27% of unshelled weight. Can be carcinogenic if not stored properly.
		SP	44h	See Notes	92.5 Dry	1,551	485	Hulls 61% of unhulled weight.
		SU	44f	—	D Dry	D	D	Helps eradicate weeds.
		SU	—	—	34.0 30.4	1,338 1,547	145 105	:Brown. :White.
		SP, FA	44e	—	54.5 Dry	1,615 White	172 Green	15% in wheat bread buffers phytates which otherwise tie-up iron.
		SU	44e	See Notes	86.8 Hulled	2,790 dry	—	Source of organic matter and vegetable oil. Harvest when 98-100% of heads dry. Hulls 49% of unhulled weight.
		SU	—	—	84.4 Dry	2,554	5,262	Exhausts soil. Very high in calcium.
		SU	44e	—	49.9 154.7	608 1,828	304 1,025	:Green. :Hulled, dry.
		SP, (FA)	—	—	57.6 Dry	1,506	168	
		SP, SU	44i	—	83.0 Dry	D	D	<i>Triticum monococcum var. Hornemanii</i> . Variety up to 12,000 years old.
		SP, (FA)	44e	—	63.5 Dry	1,497	163	
		FA	44e	—	55.8 46.3	1,497 1,497	205 193	:Hard Variety. :Soft Variety.
		SP	—	—	42.6 Dry	1,520	163	

COVER, ORGANIC MATTER, FODDER CROPS

For Organic Matter also see: Artichoke, Jerusalem — Beans, Broad, Fava — Beets, Cylindra — Beets, Tops

PLANT		SEED			YIELD			
		B Approx. Seeds/Ounce ²⁴	C Minimum Legal Germination Rate ²⁵	D Ounces Seed/100 Sq. Ft. (Adj. for Germ. Rate, Offset Spacing, and Curv. Surf.) ^{26, 30}	E Possible B/FIM Pounds Yield/100 Sq. Ft. <small>27, 27a</small>	F Possible B/FIM Pounds Yield/Plant ²⁸	G Avg. U.S. Pounds Yield/100 Sq. Ft. ²⁹	
A	Plant							
1	Alfalfa	14,000	.70 A	.75-.91	43-80-120 Air Dry Weight/3 Cuttings	D	13.6	
2	Beans, Be ¹⁷	700	.70 A	.65	90-180-320 Wet Weight: Above Ground Biomass	.28-1.1	D	
3	Buckwheat	1,000	.70 A	2.6	7-15-30 Grain	D	D	
4	Clover, Alsike	44,875	.70 A	3-.55+	12-25-38 Air Dry Weight	D	4.1	
5	Clover, Crimson	7,000	.70 A	.6+	12-25-38 Air Dry Weight	D	4.1	
6	Clover, Sweet, Hubam	11,400	.70 A	1.1+	12-25-38 Air Dry Weight	D	4.1	
7	Clover, Medium Red	14,500	.70 A	.36 For Hay .72 For Green Manure	25-50-75 Air Dry Weight	D	8.3	
8	Clover, Sweet, White	45,750	.70 A	1.1+	12-25-38 Air Dry Weight	D	4.1	
9	Clover, Timothy	82,500	.96 A	2.2-3.7	12-25-38 Air Dry Weight	D	4.1	
10	Comfrey, Russian	—	—	53 Roots	53-230-338 Wet Weight/3 Cuttings	1.7-6.4	63.6 World High (19 mo. season)	
11	Grass, Rye, Italian	16,875	.70 A	4.4-6.6	D	D	D	
12	Holy Hay (Sainfoin)	1,560 In Pods 2,040 Cleaned	.70 A	1.1 Hulled	25-50-75 Air Dry Weight/ Multiple Cuttings	D	D	
13	Kudzu	2,000	.70 A	Propagated by seeds, cuttings, and roots. More research needs to				
14	Millet, Pearl	2,200 Unhulled	.70 A	.3	230-560-1,120 Wet Weight: Above Ground Biomass	.65-2.0	280	
15	Roots, General	An important hidden cover crop beneath the ground. This information needs to						
16	Sorghum	1,000	.65 A	2.1	6.2-12.4-25 Seed 42-84-168 Wet Weight: Above Ground Biomass	.004-.018 .03-.12	6.2 42.6	
17	Sow Thistle	D	.70 A	D	D	D	D	
18	Straw and Chaff, Barley	See Protein Source Crops for General Information			12-30-72 Dry	D	7.3 Approx.	
19	Straw and Chaff, Oats				12-30-72 Dry	D	5.0 Approx.	
20	Straw and Chaff, Rice				12-30-72 Dry	.014-.086	16.0 Approx.	
21	Straw and Chaff, Rye				12-30-72 Dry	.014-.086	3.9 Approx.	
22	Straw and Chaff, Wheat, Early Stone Age				12-30-51 Dry	.014-.06	D	
23	Straw and Chaff, Wheat General				12-30-72 Dry	.014-.086	6.0 Approx.	
24	Teosinte	440	.70 A	.08	83-140-280 Wet Weight	2.4-8.0	83.0 Approx.	
25	Trifol, Narrow Leaf	35,000	.70 A	D	D	D	D	
26	Vetch, Hairy	800	.70 A	5.5	D	D	D	
27	Weeds, Amaranth, Green	D	.70 A	D	D	D	D	
28	Weeds, Dandelion, Greens	42,000	.70 A	D	D	D	D	
29	Weeds, Lamb's Quarters	52,000	.70 A	D	D	D	D	
30	Weeds, Purslane	104,000	.70 A	D	D	D	D	

BEDS/FLATS							MATURITY		RE- MARKS	FOOD NEEDED	SEED YIELD	
H In BED Spacing In Inches	I Maximum Number of Plants/100 Sq. Ft. ³⁰	J Short/Long/ Extra-Long Germ. Rate	K Flat Initially In Flats/Beds	L In FLATS Spacing in Inches ³¹	M Approx. Plants/Flat (Adj. for Germ. Rate) ^{31, 32}	N Approx. Time In Flats-In Weeks ^{31, 33}	O Approx. Weeks to Maturity	P Harvesting Period In Weeks -Up To:	Q Remarks and Especially Good Varieties	R Pounds Consumed/Year ³⁴ Avg. Person in U.S.	S Approx. Max. Pounds Seed Yield/100 Sq. Ft. ⁴⁰	T Heavy Giver (HG), Light Feeder (LF), Low Nitrogen User (LNU), Heavy Feeder (HF)
D	D	S	B	—	—	—	17 to First Cutting	3-50+ Years	—	730.7	1.1	HG
B	320	S	B	—	—	—	17-26	—	—	D	4.5	HG
D	D	S	B	—	—	—	9-13	—	—	D	30.0	HF
D	D	S	B	—	—	—	17-26	1 Cutting	—	228.0		HG
D	D	S	B	—	—	—	17-26	1 Cutting	—	Including Timothy		HG
D	D	S	B	—	—	—	17-26	1 Cutting	—		2.2+	HG
D	D	S	B	—	—	—	17 to First Cutting 9 Thereafter	2+ Cuttings	—			HG
D	D	S	B	—	—	—	17-26	1 Cutting	—			HG
D	D	S	B	—	—	—	17	D	—	228.0 Incl All Clovers	46+	HG
18	53	S	B	—	—	—	17 to first Cutting	Years	—	D	D	HF
D	D	S	B	—	—	—	D	D	—	D	6.9+	HF
D	D	S	B	—	—	—	17 to First Cutting 9 Thereafter	D	—	D	46+	HG
be performed. For some information see Kudzu book in Bibliography.												
7	432	L	F	1	175	2-4	17-21	—	—	D	18.3	HF
be developed.												
4	1,343	S	B	—	—	—	13	—	—	L	25.0	HF
D	D	S	B	—	—	—	D	—	—	D	D	HF
21	35	S	F	1	175	2-3	D	D	—	D	D	HF
D	D	S	B	—	—	—	D	D	—	D	D	HG
D	D	S	B	—	—	—	D	D	—	D	1.1+	HG
D	D	S	B	—	—	—	D	D	—	D	D	HF
D	D	L	B	—	—	—	D	D	—	D	D	HF
D	D	L	B	—	—	—	D	D	—	D	D	HF
D	D	L	B	—	—	—	D	D	—	D	D	HF

COVER, ORGANIC MATTER, FODDER CROPS (Continued)		FOOD NEEDED	MATERIALS NEEDED			
		B	C	D	E	F
PLANT						
A	<i>Plant</i>	<i>Pounds You Select</i>	<i>Approx. Number Plants You Need³⁵</i>	<i>Approx. Sq. Ft. You Need³⁶</i>	<i>Approx. Flats You Need³⁷</i>	<i>Approx. Ounces,³⁸ Seeds You Need</i>
1	Alfalfa					
2	Beans, Bell					
3	Buckwheat					
4	Clover, Alsike					
5	Clover, Crimson					
6	Clover, Sweet, Hubam					
7	Clover, Medium Red					
8	Clover, Sweet, White					
9	Clover, Timothy					
10	Comfrey, Russian					
11	Grass, Rye, Italian					
12	Holy Hay (<i>Sanfoin</i>)					
13	Kudzu					
14	Millet, Pearl					
15	Roots, General					
16	Sorghum					
17	Sow Thistle (<i>is. white straw)</i>					
18	Straw and Chaff, Barley					
19	Straw and Chaff, Oats					
20	Straw and Chaff, Rice					
21	Straw and Chaff, Rye					
22	Straw and Chaff, Wheat, Early Stone Age					
23	Straw and Chaff, Wheat, General					
24	Teosinte					
25	Trifol, Narrow Leaf					
26	Vetch, Hairy					
27	Weeds, Amaranth, Green					
28	Weeds, Dandelion, Greens					
29	Weeds, Lamb's Quarters					
30	Weeds, Purslane					

YIELDS		MISC.						NOTES
G	H	I	J	K	L	M	N	O
Your Actual Yield/100 Sq. Ft.	Your Yield Compared With U.S. Avg. ³⁹	Time of Year To Plant (SP, SU, FA, WI)	Special Seed Sources	Special Harvesting/Preparation/Storage Information	Protein Content/ Pound In Grams (g) (454g/Pound) ^{44b}	Calorie Content/ Pound ^{44b} 1 Therm = 1,000 Calories	Calcium Content/ Pound In Milligrams (mg) ^{44b}	
		SP	44f	See Notes	53.1* Air Dry	411 10% Bloom	667 point	Harvest when in 10-90% flowering range.
		FA, SP	—	See Notes	D	D	D	See above ^Δ
		SP, SU, FA	44e	—	53.1 Dry	1,520 Gram	517	Good honeybee plant. Fairly good organic matter crop.
		SP	44f	—	36.7*	496 Dry	522	See Voisin books in Bibliography for way to increase grazing yields significantly. Try 3-5 times the seeding rate for hay if growing crop seed. Roots can equal biomass weight above ground.
		SP	44f	—	44.5*	391 Dry	558	
		SP	44f	—	42.6*	355 Dry	567	
		SP	44f	—	51.3*	450 Before bloom	767	
		SP	44f	—	42.6*	355 Dry	567	
		SP	44f	—	18.6* Dry	D Early bloom	186	
		SP	44f	—	3.4	D	D	
		SP	44f	—	15.4*	D	—	Not good for soil.
		SP	44e	—	34.0* Dry	D	—	Does best in slightly dry climates.
		D	44i	—	13.3 11.3	D D	D D	:Dried Root. } Plus cloth can be made from the :Cured Hay. } root.
		SP	—	—	19.0*	D Dry	—	Can easily exhaust soil if not returned to it. Seeds form when days become shorter in about 45 days.
		—	—	—	—	—	—	—
		SU	44f	—	49.9 15.0*	1,506 351	127 154	:Grain. :Fodder, dry.
		SP, SU, FA	44i	—	D	D	D	Medium deep rooting system.
					3.2*	224 Dry	145	Roger Revelle, "The Resources Available for Agriculture", <i>Scientific American</i> , September, 1976, p. 168: "... most — perhaps all — of the energy needed in high yielding agriculture could be provided by the farmers themselves" from the crop residues of cereal grains!
					3.2*	233 Dry	86	
					2.7*	D Dry	86	
					—*	90 Dry	118	
					D	D	D	
					1.3*	100 Dry	95	
		D	44i	—	22.2*	D	—	
		SP	—	—	D	D	D	
		SP	44f	—	69.0*	D Dry	513	
		SU	—	—	3.5	36	287	Good biomass crops. Vitamins and minerals.
		SP, SU, FA	44e	—	2.7	45	187	
		SP, SU, FA	44e	—	4.2	43	309	
		SP, SU, FA	44e	—	1.7	21	103	

BEDS/FLATS							MATURITY		RE- MARKS	FOOD NEEDED	SEED YIELD	
H	I	J	K	L	M	N	O	P	Q	R	S	
<i>In BED Spacing In Inches</i>	<i>Maximum Number of Plants/100 Sq. Ft.³⁰</i>	<i>Short/Long/ Extra-Long Germ. Rate</i>	<i>Plant Initially In Flats/Beds</i>	<i>In FLATS Spacing in Inches³¹</i>	<i>Approx. Plants/Flat (Adj. for Germ. Rate)^{31, 32}</i>	<i>Approx. Time In Flats-In Weeks^{31, 33}</i>	<i>Approx. Weeks to Maturity</i>	<i>Harvesting Period In Weeks—Up To:</i>	<i>Remarks and Especially Good Varieties</i>	<i>Pounds Consumed/Year³⁴ Avg. Person in U.S.</i>	<i>Approx. Max. Pounds Seed Yield/100 Sq. Ft.⁴⁰</i>	<i>Heavy Giver (HG), Light Feeder (LF), Low Nitrogen User (LNU), Heavy Feeder (HF)</i>
										(596 All paper and paper-board)		
D	D	L	B	—	—	—	D	—	—	(94.7 All sugar.)	D	LF
Stir. Let sit for 5 minutes. Pour through cheese cloth lining a colander. Let drain until excess moisture is gone. Result: soft cheese.												
12	159	L	F	1 —	175 —	3-4 —	17-26	—	—	D	15.2	HF
3: Seed 4: Fiber	2,507 1,343	S	F	1 —	175 —	3 —	12-14	—	—	D	D	HF
around young children.												
Bibliography under Tools Section.												
										238 Lbs. (29% Gal.)		
										D		

TREE, CANE CROPS		SEED			YIELD		
		B	C	D	E	F	G
PLANT	Plant	Approx. Seeds/Ounce ²⁴	Minimum Legal Germination Rate ²⁵	Approx. Numbers of Plants/Acre	Possible B/FIM Pounds Yield/100 Sq. Ft. <small>27, 27a</small>	Possible B/FIM Pounds Yield/Plant ²⁸	Good U.S. Yield in Pounds/100 Sq. Ft.
A							
1	Almond	12-15	D	160	2.8-5.6-8.4+ In Shell	7.6-22.8+	2.8
2	Apple, Dwarf	600-1,000	D	681	50-75-100	50-100	54.1
3	Apple, Regular	600-1,000	.65 ^A	27	50-75-100	800-1,600	54.1
4	Apple, Semi-Dwarf	600-1,000	D	194	50-75-100	112-225	54.1
5	Apricot, Dwarf	18-20	D	681	25-50-100	25-100	24.3
6	Apricot, Regular	18-20	.90 ^A	70	25-50-100	156-625	24.3
7	Apricot, Semi-Dwarf	18-20	D	303	25-50-100	36-144	24.3
8	Blackberries	10,000	—	²⁷²³ Propagated by "cuttings"	24-36-48+	3.8-7.6+	23.8
9	Boysenberries	—	—	⁶⁸¹ Propagated by "cuttings"	26-39-52+	16.6-33+	25.7
10	Cherry, Sour, Bush	D	D	4,840	8-17-34	.8-3.0	D
11	Cherry, Sour, Dwarf	200-250	.80 ^A	681	17-34-51	11-32.6	16.5
12	Cherry, Sour, Regular	200-250	D	1,089	17-34-51	68-204	16.5
13	Cherry, Sweet, Bush	D	D	4,840	8-17-34	.8-3.0	D
14	Cherry, Sweet, Dwarf	150-160	D	681	17-34-51	11-32.6	16.5
15	Cherry, Sweet, Regular	150-160	.75 ^A	481	17-34-51	153-459	16.5
16	Chestnut	1	.72 ^A	27	3.5-7-15 In Shell	56-240	D
17	Currants, Black	—	—	²⁷²³ Propagated by "cuttings"	D	D	D
18	Dates	40	—	⁴³ Propagated by "cuttings"	23-46-70	207-630	22.9
19	Filbert	10-20	—	¹⁹⁴ Propagated by "cuttings"	13-27-55 In Shell	17-123	D
20	Fig	—	—	¹⁹⁴ Propagated by "cuttings"	12-24-36++	27-81++	11.9
21	Grapefruit	150-200	D	76	63-95-126	362-724	63.3
22	Grapes, Raisin	—	—	⁶⁸¹ Propagated by "cuttings"	38-57-76	24-48	45.4
23	Grapes, Table	—	—	⁶⁸¹ Propagated by "cuttings"	45-67-90	28.8-57.6	37.6
24	Grapes, Wine	—	—	⁶⁸¹ Propagated by "cuttings"	32-48-64	20.5-41	31.6
25	Guava	D	D	303	D	D	D
26	Hickory	¹⁴ Depends on variety	^{85-86 J} Depends on variety	27	D	D	D
27	Honey Locust	180	.50 ^J	27	Pods and Beans: 6-13-28+	128-320	D
28	Lemon	200-300	D	76	75-112-150	432-864	74.6
29	Lime	300-400	D	194	D	D	D

BEDS/FLATS							MATURITY			RE- MARKS	FOOD NEEDED	SEED YIELD		
H	I	J	K	L	M	N	O	P	Q					R
In. BED Spacing In Feet.	Sq. Ft. Required/ Plant ³⁰	Short/Long/ Extra-Long Germ. Rate	Plant Initially In Flats/Beds	In FLATS Spacing in Inches ³¹	Approx. Plants/Flat (Adj. for Germ. Rate) ^{31,32}	Approx. Time In Flats-In Weeks ^{31,33}	Approx. Years to Bearing	Harvesting Period In Weeks— Up To:	Remarks and Especially Good Varieties	Pounds Consumed/Year ³⁴ Avg. Person in U.S.	Approx. Max. Pounds Seed Yield/100 Sq. Ft. ⁴⁰	Heavy Giver (HG), Light Feeder (LF), Low Nitrogen User (LNU), Heavy Feeder (HF)		
16.5	272	L	F	4	D	D	3-4	D	D	—	.4	8.4 In Shell	HF	
8	64	EL	F	2	D	D	3	D	D	—	18.5	D	HF	
10	1,600	EL	F	2	D	162	5	10	35-50	—		D	HF	
15	225	EL	F	2	D	D	4	10	D	—		D	HF	
8	64	L	F	4	D	D	2	D	D	—	D	D	HF	
25	625	L	F	4	D	225	3	D	D	Manchurian		D	HF	
12	144	L	F	4	D	D	3	D	D	—		D	HF	
4	16	D	Deep Flat	6	D	D	2	D	D	6-10	—	D	D	HF
8	64	D	Deep Flat	6	D	D	2	D	D	6-10	—	D	D	HF
3	9	L	F	3	D	D	3	D	D	2 Varieties for Pollination	D	D	HF	
8	64	L	F	3	200	D	3	D	D	—	D	D	HF	
20	400	L	F	3	D	D	4	10-20	D	—	D	D	HF	
3	9	L	F	3	D	D	3	D	D	—	D	D	HF	
8	64	L	F	3	D	D	3	D	D	—	D	D	HF	
30	900	L	F	3	187	D	4	10-20	D	—	D	D	HF	
40	1,600	D	Deep Flat	6	180	D	D	D	D	—	D	15.0 In Shell	HF	
4	16	D	Deep Flat	6	D	D	3	D	D	20	—	D	D	HF
30	900	D	Deep Flat	9	D	D	5-6	10-15	D	—	D	D	HF	
15 (18-25)	225	D	Deep Flat	9	D	D	D	D	D	—	.97	55.0 In Shell	HF	
15	225	D	Deep Flat	9	D	D	D	D	D	17	—	D	D	HF
24	576	L	F	3	D	D	3	D	D	—	29.4 All Citrus	D	HF	
8	64	D	F	6	D	D	3	D	D	—	2.0 Dry Wt.	D	HF	
8	64	D	F	6	D	D	3	D	D	—	6.3	D	HF	
8	64	D	F	6	D	D	3	D	D	—	20.4	D	HF	
12	144	D	F	1	D	D	D	D	D	—	D	D	HF	
40	1,600	D	F	4	187-200	D	D	D	D	25-300	—	D	D	HF
40	1,600	D	F	4	125	D	D	D	D	10-100	—	D	D	HF
24	576	D	F	2	D	D	3	D	D	50+	—	29.4 All Citrus — Fresh	D	HF
15	225	D	F	2	D	D	3	D	D	—	D		D	HF

TREE, CANE CROPS (Continued)		FOOD NEEDED	MATERIALS NEEDED			
		B	C	D	E	F
PLANT	A	<i>Pounds You Select</i>	<i>Approx. Number Plants You Need³⁵</i>	<i>Approx. Sq. Ft. You Need³⁶</i>	<i>Approx. Flats You Need³⁷</i>	<i>Approx. Ounces/Seed You Need³⁸</i>
1	Almond					
2	Apple, Dwarf					
3	Apple, Regular					
4	Apple, Semi-Dwarf					
5	Apricot, Dwarf					
6	Apricot, Regular					
7	Apricot, Semi-Dwarf					
8	Blackberries					
9	Boysenberries					
10	Cherry, Sour, Bush					
11	Cherry, Sour, Dwarf					
12	Cherry, Sour, Regular					
13	Cherry, Sweet, Bush					
14	Cherry, Sweet, Dwarf					
15	Cherry, Sweet, Regular					
16	Chestnut					
17	Currants, Black					
18	Dates					
19	Filbert					
20	Fig					
21	Grapefruit					
22	Grapes, Raisin					
23	Grapes, Table					
24	Grapes, Wine					
25	Guava					
26	Hickory					
27	Honey Locust					
28	Lemon					
29	Lime					

YIELDS		MISC.						NOTES
G	H	I	J	K	L	M	N	O
Yow. Actual Yield/100 Sq. Ft.	Your Yield Compared With U.S. Avg. ³⁹	Time of Year To Plant (SP, SU, FA, WI)	Special Seed Sources	Special Harvesting/Preparation/Storage Information	Protein Content/ Pond. In Grams (g) (454g/Pound) ^{44b}	Calorie Content/Pound ^{44b}	Calcium Content/ Pound In Milligrams (mg) ^{44b}	
		Early SP	—	—	84.4 Shelled.	2,713	1,061	Shells 49% of unshelled weight.
		Early SP	44k	—	8 Raw.	242 8%	29 Refuse.	Spur-type yields higher.
		Early SP	—	—	8 Raw.	242 8%	29 Refuse.	
		Early SP	—	—	8 Raw.	242 8%	29 Refuse.	
		Early SP	—	—	4.3 Raw.	217 6%	72 Refuse.	A fall yielding variety also exists.
		Early SP	44k.	—	4.3 Raw.	217 6%	72 Refuse.	30 feet high.
		Early SP	—	—	4.3 Raw.	217 6%	72 Refuse.	
		Early SP	44i	—	5.3 Raw.	264	145	2 foot wide beds.
		Early SP	—	—	3.2 Canned.	163	86	2 foot wide beds.
		Early SP	44k, 44l	—	5.0 Raw.	242 8%	92 Refuse.	
		Early SP	—	—	5.0 Raw.	242 8%	92 Refuse.	
		Early SP	—	—	5.0 Raw.	242 8%	92 Refuse.	Bear in 3-5 years.
		Early SP	44k, 44l.	—	3.6 Canned.	195 Without	68 pits.	
		Early SP	—	—	3.6 Canned.	195 Without	68 pits.	One self-pollinating variety exists.
		Early SP	—	—	3.6 Canned.	195 Without	68 pits.	
		Early SP	—	—	30.4 Dried	1,710 and	236 shelled.	Shells (dried): 18% of unshelled weight. Problems with blight.
		Early SP	—	—	7.5 Raw.	240 2%	267 Refuse.	2 foot wide beds.
		Early SP	44i	—	10.0 Dry	1,245 and	260 pits.	1 male to 100 female plants for pollination. Pits: 13% of dried weight.
		Early SP	44i	—	67.2 Shelled.	2,576	843	Shells: 54% of unshelled weight.
		Early SP	—	—	5.4 Raw.	363	150	Drying ratio 3:1.
		Early SP	—	—	1.0 Raw.	84 55%	33 Refuse.	
		Early SP	—	—	11.3 Dry.	1,311 18%	281 moisture.	
		Early SP	—	—	2.4 Raw.	270 11%	48 Refuse.	
		Early SP	—	—	3.7 Raw.	197 37%	46 Refuse.	
		Early SP	44i	—	8.5 Raw.	273 2%	101 Refuse.	15 feet high.
		Early SP	44i	—	60.3 Shelled.	2,053	750	Shells: 65% of unshelled weight.
		Early SP	44l	—	72 D	D	D	Can make a flour from the beans. Pods and beans a good fodder. A very important tree. <i>Gleditsia triacanti</i> .
		Early SP	—	—	3.3	82 33%	79 Refuse.	
		Early SP	—	—	2.7	107 16%	126 Refuse.	

BEDS/FLATS							MATURITY		RE-MARKS	FOOD NEEDED	SEED YIELD		
H	I	J	K	L	M	N	O	P	Q	R	S		
In BED Spacing In Feet	Sq. Ft. Required/Plant ³⁰	Short/Long/Extra-Long Germ. Rate	Plant Initially In Flats/Beds	In FLATS Spacing in Inches ³¹	Approx. Plants/Flat (Adj. for Germ. Rate) ^{31, 32}	Approx. Time In Flats-In Weeks ^{31, 33}	Approx. Years to Approx Bearing	Harvesting Period In Weeks—Up To: Bearing Years	Remarks and Especially Good Varieties	Pounds Consumed/Year ³⁴ Avg. Person in U.S.	Approx. Max. Pounds Seed Yield/100 Sq. Ft. ⁴⁰	Heavy Giver (HG), Light Feeder (LF), Low Nitrogen User (LNU), Heavy Feeder (HF)	
30	900	D	F	2 I	D	D	D	D	—	D	D	HF	
8	64	D	B Sapling	—	—	—	3-4	8-12	—	D	D	HF	
15	225	D	F	4 I	D	D	D	D	—	D	D	HF	
22 24	448 576	D	F	2 I	D	D	3	D	—	D	D	HF	
8	64	D	B Sapling	—	—	—	3	D	—	D	D	HF	
15	225	D	F	4 I	D	D	3-4	8-12	—	D	D	HF	
8	64	D	B Sapling	—	—	—	3	D	—	D	D	HF	
16(-20)	256	EL	F	1 I	D	D	4	D	—	D	D	HF	
40(-70)	1,600	L	F	4 I	125	D	D	D	—	4	25.0+ In Shell	HF	
18	324	D	F	1 I	D	D	2-3	D	—	D	D	HF	
20	400	D	F	2 I	D	D	D	D	—	D	D	HF	
3	9	D	B Sapling	—	—	—	3	D	—	D	D	HF	
18(-24)	324	D	F	4 I	D	D	4	D	—	D	D	HF	
4	16	D	Deep Flat	6 I	D	D	2	D	—	D	D	HF	
1	1	D	F	1 2	D	D	2	D	—	4	D	HF	
20	400	D	F	1 I	3	D	3	D	—	29.4 All Citrus Fresh	D	HF	
20	400	D	F	1 I	D	D	3	D	—		D	D	HF
40	1,600	EL	F	4 I	100	D	D	D	—		46	11.6+ In Shell	HF
40	1,600	L	F	4 I	300	D	D	D	—	12.0+ In Shell		HF	
40	1,600	EL	F	4 I	125	D	D	D	—	18.0+ In Shell		HF	

TREE, CANE CROPS (Continued)		FOOD NEEDED	MATERIALS NEEDED			
		B	C	D	E	F
PLANT	Plant	<i>Pounds You Select</i>	<i>Approx. Number Plants You Need³⁵</i>	<i>Approx. Sq. Ft. You Need³⁶</i>	<i>Approx. Flats You Need³⁷</i>	<i>Approx. Ounces/Seed You Need³⁸</i>
A						
30	Mango					
31	Nectarine, Dwarf					
32	Nectarine, Regular					
33	Orange, Sweet					
34	Peach, Dwarf					
35	Peach, Regular					
36	Pear, Dwarf					
37	Pear, Regular					
38	Pecan					
39	Persimmon					
40	Pistachio					
41	Plum, Bush					
42	Plum, Regular					
43	Raspberries					
44	Strawberries					
45	Tangelo					
46	Tangerine					
47	Walnut, No. Calif. Black					
48	Walnut, English (Persian)					
49	Walnut, Eastern, Black					

YIELDS		MISC.						NOTES
G	H	I	J	K	L	M	N	O
Your Actual Yield/100 Sq. Ft.	Your Yield Compared With U.S. Avg. ³⁹	Time of Year To Plant (SP, SU, FA, WI)	Special Seed Sources	Special Harvesting/Preparation/Storage Information	Protein Content/Pound In Grams (g) (45.4g/Pound) ^{44b}	Calorie Content/Pound ^{44b}	Calcium Content/Pound In Milligrams (mg) ^{44b}	
		D	44i	—	2.1 33%	201 Refuse	30	90 feet high at maturity.
		Early SP	44j	—	2.5 8%	267 Refuse	263	8 feet high.
		Early SP	44j	—	2.5 8%	267 Refuse	263	25 feet high.
		Early SP	—	—	4.0 4.1	157 174	129 136	:Navels (winter bearing). 32% Refuse. :Valencias (summer bearing). 25% Refuse.
		Early SP	—	—	2.4 13%	150 Refuse	36	8 feet high.
		Early SP	—	—	2.4 13%	150 Refuse	36	25 feet high.
		Early SP	44j	—	2.9 9%	252 Refuse	33	8 feet high.
		Early SP	44j	—	2.9 9%	252 Refuse	33	30-40 feet high.
		Early SP	—	—	41.7 Shelled	3,116	331	Shell: 47% of unshelled weight.
		Early SP	44i	—	2.6 18%	286 Refuse	22	30 feet high.
		Early SP	44i	—	37.5 Shelled	2,694	594	30 feet high. Shell: 50% of unshelled weight.
		Early SP	44k, 44l	—	2.1 9%	272 Refuse	74	3 feet high.
		Early SP	44j	—	2.1 3.4	272 320	74 51	:Damson. 9% Refuse. :Prune. 6% Refuse.
		Early SP	—	—	6.6 5.3	321 251	132 97	:Black Refuse 3%. 2 foot wide beds. :Red
		Early SP	44m	—	3.0 4%	161 Refuse	91	Bear well second through fourth year. Use new plants on end of runners to renew bed.
		Early SP	—	—	1.3 44%	104 Refuse	—	30 feet high.
		Early SP	—	—	2.7 26%	154 Refuse	134	30 feet high.
		Early SP	44i	—	D	D	D	30-60 feet high.
		Early SP	—	—	33.0 Shelled	2,849 85%	449 Refuse	Up to 60 feet high.
		Early SP	—	—	37.3 Shelled	2,983 78%	Trace Refuse	Up to 150 feet high. A good tree to plant for your great-great grandchildren!
		Early						

CODES

- A** — Approximate germination rate sold by seed companies. No known minimum germination rate. Can be higher or lower.
- B** — In Beds.
- C** — Cantaloupe.
- D** — Do not know yet.
- E** — Spacing increases with warmth of climate.
- F** — In Flats.
- G** — Best "seed" is a seed packet of 2-6 seeds, of which approximately 1.62 germinate.
- H** — Honeydew.
- I** — Transplant into 1-5 gallon container as appropriate. Raise sapling until one year old. Then transplant into soil.
- J** — Germination average in laboratory.
- L** — Long Germinating Seed (8-21 days).
- M** — Cook to minimize oxalic acid, calcium tie-up.
- N** — Use narrow bed: 2 feet wide
- P** — Perennial.
- R** — Replant at points where germination fails. We call this "spotting".
- S** — Short Germinating Seed (1-7 days).
- T** — 18 inches for cherry tomatoes; 21 inches for regular tomatoes; 24 inches for large tomatoes. Sequential information in columns D,F,H and I should be used according to spacing chosen.
- V** — Approximate minimum.
- W** — 12 inches for midget varieties; remaining spacings experimental for regular varieties. Sequential information in columns: D,F,H and I should be used according to spacing chosen.
- Y** — Estimate.
- Z** — 15 inch spacing for non-hybrids; 18 inch spacing for hybrids. Sequential information in columns D,F,H and I should be used according to spacing chosen.
- EL** — Extra-Long Germinating Seed (22-28 days).
- FA** — Fall.
- SP** — Spring.
- SU** — Summer.
- WI** — Winter.
- ZZ** — Based on Ecology Action experience.
- * — Digestible Protein for animals.
- ** — Depending on variety selected.
- — Not Applicable.
- # — First set of figures: summer growing in lathhouse for fall set-out.
Second set of figures: winter growing in greenhouse for spring set-out.
Harden off for 2 days outside in flat before transplanting into bed.
- ## — Plant 2 seeds/center to compensate for low germination rate.
- + — Yield may be significantly higher.

FOOTNOTES

24. From James Edward Knott, *Handbook for Vegetable Growers*, John Wiley and Sons, Inc., New York, 1975, pp. 17; and other reference sources.
25. *Ibid.*, pp. 192 and 193; and other reference sources.
26. To determine amount divide Column I by Column B by Column C.
27. Estimates based on our experience and research. Use lower figure if you are a beginning gardener; middle, if a good one; third, if an excellent one. (The testing and development process is requiring a long time and has involved many failures. Its direction, however, has been encouraging over the years, as the soil, our skills, and yields have improved, and as resource consumption levels have decreased. There is still much left to be done.)
- 27a. The approximate plant yield averages are in some instances much lower than one would expect. For example, a beginning gardener will get carrots much larger than the ¼ ounce noted, but all of his or her carrots will probably not germinate as well as a good or excellent gardener's and will probably not be as large. Therefore, it is estimated that the average weight of the carrots would be ¼ ounce (based as if all 5,894 seeds germinated).
28. E ÷ I
29. From: U.S. Department of Agriculture, *Agricultural Statistics — 1972*, U.S. Government Printing Office, Washington, D.C., pp. 151-188; and other reference sources.
30. Curved surface adds about 20% to planting surface, so 159 plants fit in 120 square feet of curved surface on 12 inch (1 foot) centers, rather than fewer plants. The reason it is 159 plants rather than 120 is because the hexagonal "offset" spacing uses up less space than equidistant spacing.
31. Upper part of box is for initial seeding in flat. Lower part is for later transplanted spacing in another flat, when that is recommended.
32. Assumes Flat with internal dimensions of 13 inches by 21 inches (or 273 square inches) in which at least 250 plants fit on 1-inch centers and 60 plants on 2-inch centers.
33. From James Edward Knott, *Handbook for Vegetable Growers*, John Wiley and Sons, Inc., New York, 1957, p. 14 and from our experience and research.
34. U.S. Department of Agriculture, *Agricultural Statistics — 1972*, U.S. Government Printing Office, Washington, D.C., pp. 238, 239, 241, 242, 244, 245; and other sources.
35. B (p. 62) ÷ F (p. 60)
36. B (p. 62) ÷ E (p. 60). Use lower figure in E if you are a beginning gardener; middle, if a good one; third, if an excellent one.
37. C (p. 62) ÷ M (p. 61)
38. D (p. 62) ÷ D (p. 60)
39. G (p. 63) ÷ G (p. 60)
40. Based in part on standard yield figures from James Edward Knott, *Handbook for Vegetable Growers*, John Wiley and Sons, Inc., New York, 1975, pp. 198-199 in combination with a multiplier factor based on our research and experience, and other reference sources. The result, however, is preliminary, for your guidance, and is very experimental. Remember, if growing seed, to adjust for germination rate when determining amount to grow for your use.
41. Harvest after die-back of plants.
42. From James Edward Knott, *Handbook for Vegetable Growers*, John Wiley and Sons, Inc., New York, 1957, p. 14.
43. Can cut smaller heading secondary and tertiary side shoots also. In addition, leaves generally have twice the nutritive value of the "heads".
44. Contains the same amount of general protein (not amino acids) and 50-100% more calcium per cup as milk, yet may produce up to 6 times the cups per unit of area!
- 44a. The Redwood City Seed Company carries an interesting tropical variety, Snow Peak, which heads only in the summer. A good variety with small heads for out-of-season growing.
- 44b. United States Department of Agriculture, *Composition of Foods*, U.S. Government Printing Office, Washington, D.C., 1963, 190 pp., and other reference sources.
- 44c. Irish Potatoes: White Rose and Red LaSoda varieties. 100 pound orders or more. Order in September untreated for next Spring in 100 pound bags from Cal-Ore Seed Company, 1212 Country Club Blvd., Stockton, CA 95204, if your nursery does not carry seed potatoes. Ask for prices with a stamped, self-addressed return envelope.
- 44d. Sweet Potatoes: Jewel, Centennial, Garnett, Jersey varieties. Order in September untreated, number two size, for following Summer in 40 pound boxes from Joe Alvernaz, P.O. Box 474, Livingston, CA 95334. Ask for prices with a stamped, self-addressed return envelope.
- 44e. Johnny's Selected Seeds. (See Bibliography).
- 44f. R.H. Shumway Seed Company.
- 44g. Burpee Seed Company.
- 44h. Vermont Bean Seed Company.
- 44i. Redwood City Seed Company.
- 44j. Tree Crops Nursery.
- 44k. Hansen New Plants Company.
- 44l. Gurney's Seed Company.
- 44m. Nourse Farms.
- 44n. Stark Brother's Company.
- 44o. J.L. Hudson Seed Company.
45. Use French variety (Vilmorin's Cantaloupe — orange fleshed) or Israeli variety (Haogen — green fleshed). Both have smooth exterior without netting. This minimizes rotting.
46. Try the Torpedo onion. Its long shape is particularly suited to intensive raised bed gardening and farming, and it can produce twice the yield per unit of area.
47. 1.5—2.0 ounce pieces of slightly sprouted tubers use only 1 or 2 sprouted eyes left on potato piece.
48. Red "Lasoda" variety recommended. Note that stems and leaves are poisonous, as is any part of the tuber which has turned green. Get "seed" potatoes. Many in stores have been treated to retard sprouting.
49. Stem and root sections nicked in one piece from one end of sprouted tuber. About 3 to 4 of these "starts" will be obtained from each 8 ounce potato started in a flat. Get "seed" potatoes. Many in stores have been treated to retard sprouting.
50. Burpee's Triple Treat variety with hull-less seeds. No shelling of nutritious and tasty seeds!
51. Burpee's Sparkler variety: red top with white bottom half. Good looking.
52. Green parts poisonous.
53. Burpee's New Hampshire Midget variety.

NOTES ON PLANNING CHARTS

FLOWER SPACING CHART

Spacings vary for flowers depending on the variety and how the flowers are used. The following may help you start out with the most common flowers.

Annuals — replant each year from seed

	height	inches apart*		height	inches apart*
African Daisy	4-16"	12	Phlox	6-18"	9
Aster	1-3'	10-12	(<i>P. Drummondii</i>)**		
Calif. Poppy***	9-12"	12	Portulaca	6"	6-9
Columbine	2-3'	12	Pansy	6-9"	8-10
Calendula***	1½-2'	12	Scabiosa	2½-3'	12-18
Cosmos***	2-3'	12-18	Scarlet Sage	12-18"	12
Flowering Tobacco	3'	18-24	(<i>Salvia splendens</i>)		
Hollyhock***	4-6'	12	Schizanthus	1½-2'	12-18
Marigold, African	2-4'	12-24	Shirley Poppy	1½-2'	18
Marigold, French	6-18"	8-12	Snapdragons	1½-3'	12
Nasturtium, Dwarf***	12"	8	Stocks	12-30"	12
Nasturtium, Climbing***	Trails	10	Strawflower	2-3'	12-18
Petunia	12-16"	12	Sweet Peas	Climbing	12
			Zinnia	1-3'	12-18

Perennials — need a permanent space in the garden

Alyssum	4-6"	10-12	Gazania	6-12"	10
(<i>Lobularia maritima</i>)			Iceland Poppy	1'	12
Aubrieta	Trailing	12-15	Jacob's Ladder	6"-3'	12-15
Baby's Breath	3-4'	14-16	(<i>Polemonium caeruleum</i>)		
Bachelor Buttons	2'	12	Marguerite	2½-3'	18-24
Carnation	1'	12	Oriental Poppy	2½-3'	12-14
Chrysanthemum	2-3'	18-24	Pinks (<i>Dianthus</i>)	1'	12
Coral Bells	2'	12	Peony	2'	14-16
(<i>Heuchera sanguinea</i>)			Painted Daisy	3'	12
Coreopsis	2'	9-18	Scabiosa	2'	12
Delphinium	1-5'	24	Sea Pink (<i>Armeria</i>)	4-6"	10-12
Foxglove	3'	12	Shasta Daisy	2½-3'	12
Gaillardia	2-3'	12	Sweet William	1-2'	12

* These are spacings for standard-sized plants. For smaller varieties, the spacings should be reduced in proportion to the reduced plant size.

** Botanical Latin names also given when confusion might occur without it.

*** Reseed themselves easily by dropping many seeds on ground.

NOTE: Most flowers are long germinating seeds (8-21 days).



HERB SPACING CHART

Annuals—plant seed in spring for late summer harvest

	<i>height</i>	<i>inches apart</i>		<i>height</i>	<i>inches apart</i>
Anise	2'	8	Chervil	1½'	4
Sweet Basil	1-2'	12	Coriander	1-1½'	6
Borage	1½'	15	Dill	2½'	8
Caraway	2½'	6	Fennel	3-5'	12
Chamomile	2½'	6-10	Parsley	2½'	10
(<i>Matricaria chamomilla</i>)			Summer Savory	1½'	6

Perennials^{54a}—need a permanent place in the garden

Angelica	4-6'	36	Santolina	2'	30
*Bee Balm	3'	30	Winter Savory	1'	12
Burnet	15"	15	Southernwood	3-5'	30
Catnip	2-3'	15 (spreads)**	*Spearmint	2-3'	15 (spreads)**
*Chamomile, Roman	3-12"	12	Stinging Nettle	4-6'	24 (spreads)**
(<i>Anthemis nobilis</i>)			Tansy	4'	30
Chives	10-24"	5	Tarragon	2'	18
Costmary	2-6'	12	Thyme	1'	6
Comfrey	15-36"	15-36	Valerian	4'	18
*Feverfew	1-3'	10-15	*Woodruff	6-10"	8-12 (spreads)**
Horehound	2'	9 (spreads)**	Wormwood	3-5'	12
Hyssop	2'	12	Yarrow—Common	3-5'	12
Lavender	3'	24	(<i>Achillea millefolium</i>)		
Lemon Balm	3'	12 (spreads)**	*Yarrow—White, red		
Lemon Verbena	10'	24	or pink flowered	2½-3'	12
Lovage	6'	36	*Scented Geraniums		
Marjoram	1'	12	Rose	3'	30
*Oregano	2'	18-24	Lemon	2-3'	***
Peppermint	2½'	12 (spreads)**	Apple	10"	18
*Pineapple Sage	4'	36	Peppermint	2'	48
Rosemary	3'	36	Coconut	8-12"	18
Rue	3'	18	Lime	***	***
Sage	2'	18			

* Based on our experience. Others are from the *Herb Chari* by Evelyn Gregg, Biodynamic Farming and Gardening Assn., Wyoming, Rhode Island.

** Spreads underground—keep it contained or plant where it can keep going.

*** Do not yet know height and/or spacing information.

NOTE: Many herbs are long germinating seeds (22-28 days). Most perennials started from cuttings or root divisions; perennials started from seed take 1-4 years to reach full size.



54a. Normally started from cuttings or root divisions; often takes 1-2 years to reach full size from seed.

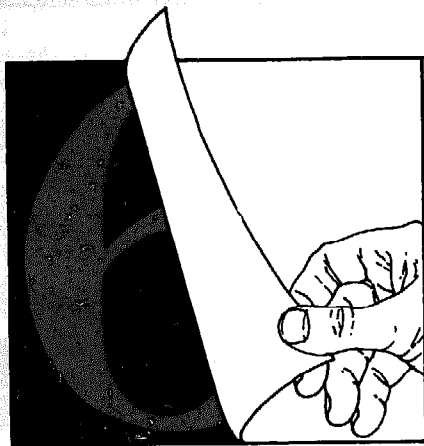

Making The Garden Plan

Now we come to the art of putting the theory into a garden plan. No book is detailed enough to make gardening foolproof. If growing plants did not involve real learning and *experimentation* it would not be nearly so satisfying. The plans that follow are meant to illustrate some of the considerations that make a successful garden. They are based on what the average American consumes each year, but do not take the precise amounts too seriously. Everyone has different tastes and your use of the "Average American Diet" changes rapidly when you have fresh abundant vegetables to use. You will probably want to eat many more fresh fruits and vegetables.

Before you start, there is some local information you will need. Talk to neighbors who garden, check with the county agricultural agent, or ask at the local nursery. You want to know:

Which vegetables grow well in your area?

When does the main planting season start?

What are the special requirements of your specific soil?

Are there any special climatic conditions to be aware of, such as heavy winds, hot dry spells or excessive rain?

How do people usually plan for this?

The first plan is for a one-person garden. The first year includes the easiest crops to grow in 100 square feet based on yields expected of a good gardener. The second year, *the square footage doubles* and more difficult crops are added. The third and fourth years, trees, herbs, strawberries and asparagus are included—these permanent plantings being placed in soil that has now been worked and improved for two years—and a third bed is added. After 3 or 4 years, the

skills gained may enable one to condense vegetable growing from 200 square feet to 100 square feet, leaving 100 square feet of improved soil for protein crops (wheat, rye, peanuts, lentils, soybeans and rice), fibers (cotton or flax), or special interest crops (chicken, goat or bee forage, grapes, blueberries, bamboo, herbs, nut trees, and so on).

Lastly, a garden plan for a family of four is shown. We recommend using a similar 3-4 year progression, starting with approximately 300 square feet the first year, and adding 300 more square feet each year until the entire garden is developed.

Buying seeds for a backyard garden easily runs up a \$10-20+ bill. At our garden supply store in Palo Alto we purchase seeds in bulk and sell them out of jars like penny candy using teaspoons and tablespoons to measure. One can easily spend less than \$2 in our store for 6 months of vegetables. You can take advantage of the same low prices by having bulk seeds ordered and carried at your favorite local co-op grocery store.

The plans specify twice as many seedlings as are needed in the garden beds. Plant the best ones and give any extras to a friend or save them in case of damage to first transplants. Leaf lettuce matures sooner than head lettuce. Planting both insures a continuous harvest. Similarly, half of the tomatoes planted should be an early variety (maturing in 65 days) for continuous harvesting. Save space by tying tomatoes up to stakes. Pumpkins take a lot of space. Plant them at the edge of the garden where they can sprawl over uncultivated areas. Corn is pollinated by the wind. A square block of 4 plants in each direction is the minimum for adequate pollination. In small plantings you may want to hand-pollinate it so all ears can fill out optimally.



THE GARDEN YEAR

Winter

- Plan Garden
- Order *untreated* seeds (allow 2 months for delivery if ordering by mail)
- Make flats, trellises, mini-greenhouses, and shade netting units^{54b}

Spring

- Plant flats so they can mature while soil is being prepared
- Start new compost piles with plentiful weeds and grass clippings
- Spread fall compost and dig garden beds
- Plant cool weather crops in early spring and warm and hot weather crops in late spring and early summer

Summer

- Plant summer crops
- Keep garden watered and weeded
- Harvest and enjoy the fruits of your work
- In mild winter areas, plant fall gardens of cool weather crops at the end of summer

Fall

- Start additional compost piles with plentiful leaves and garden waste
- Harvest summer crops.

^{54b} See Ecology Action's booklet on "Sophisticated Low-Technology Tools for Biointensive Food Raising," for miniature greenhouse and shade-netting house plans.

SIMPLE MINI-GARDEN, 6 MONTH GROWING SEASON 100-140+ SQUARE FEET

As early as possible in spring plant (optional):
1 bare root fruit tree—40+ square feet

6 weeks before last frost of spring _____ (date)

Start seedlings in flats:
leaf lettuce —12 seeds ^(S)
head lettuce — 6 seeds ^(S)
parsley — 4 seeds

2 weeks before last frost _____ (date)

Start seedlings in flat:
cherry tomatoes —16 seeds

Set out:
leaf lettuce —6 plants ^{(S)(M)} 2 sq. ft.
head lettuce —3 plants ^(S) 2 sq. ft.

Plant:
bush peas —252 seeds* 10 sq. ft.
carrots —206 seeds 1.75 sq. ft.
(2 seeds/center: thin to 1 plant/center)
bunching onions —234 seeds 1 sq. ft.
radishes — 15 seeds .25 sq. ft.

On last frost date _____ (date)

Plant:
red potatoes —75 starts 30 sq. ft.
(9.4 lbs.)

Start seedlings in flats:
cucumbers — 4 seeds
cantaloup —16 seeds
New Hampshire
midget water-
melons —32 seeds
dwarf marigolds — 4 seeds

2 weeks after last frost date _____ (date)

Set out:
cherry tomatoes
(18" centers) —8 plants 15 sq. ft.
parsley —1 plant 1 sq. ft.

Plant:
early corn
(15" centers) —34 seeds 20 sq. ft.
(2 seeds/center: thin to 1 plant/center)

4 weeks after last frost _____ (date)

Set out:
cucumbers — 2 plants — sq. ft.
cantaloup — 8 plants 10 sq. ft.
New Hampshire
midget water-
melon —16 plants 10 sq. ft.
dwarf marigold — 2 plants — sq. ft.

Plant:
pumpkins —4 seeds — sq. ft.
(thin to 2 plants)
sunflowers —4 seeds — sq. ft.
(2 seeds/center: thin to 1 plant/center)
zucchini —2 seeds — sq. ft.
(thin to 1 plant)
acorn winter
squash —2 seeds — sq. ft.
(thin to 1 plant)

8 weeks after last frost _____ (date)

As first planting comes out, plant:
red potatoes —75 starts 30 sq. ft.
(9.4 lbs.)

10 weeks after last frost _____ (date)

Plant:
bush beans —134 seeds* 10 sq. ft.

12 weeks after last frost _____ (date)

Start seedlings in flats:
leaf lettuce —12 seeds ^(S)
head lettuce — 6 seeds ^(S)
Plant:
early corn
(15" centers) —34 seeds 20 sq. ft.
(2 seeds/center: thin to 1 plant/center)

16 weeks after frost _____ (date)

Set out:
leaf lettuce —6 plants ^(S) 2 sq. ft.
head lettuce —3 plants ^(S) 2 sq. ft.
Plant:
chard — 2 seeds — sq. ft.
(thin to 1 plant)
carrots —206 seeds 1.75 sq. ft.
(2 seeds/center: thin to 1 plant/center)
radishes — 15 seeds .25 sq. ft.

⊙ = Stagger planting for a more continuous harvest.

* = Spot additional seeds later where seeds do not germinate.

Ⓜ = Numbers given are the maximum which should be required for each crop for area involved. Less may be needed.

NORTH

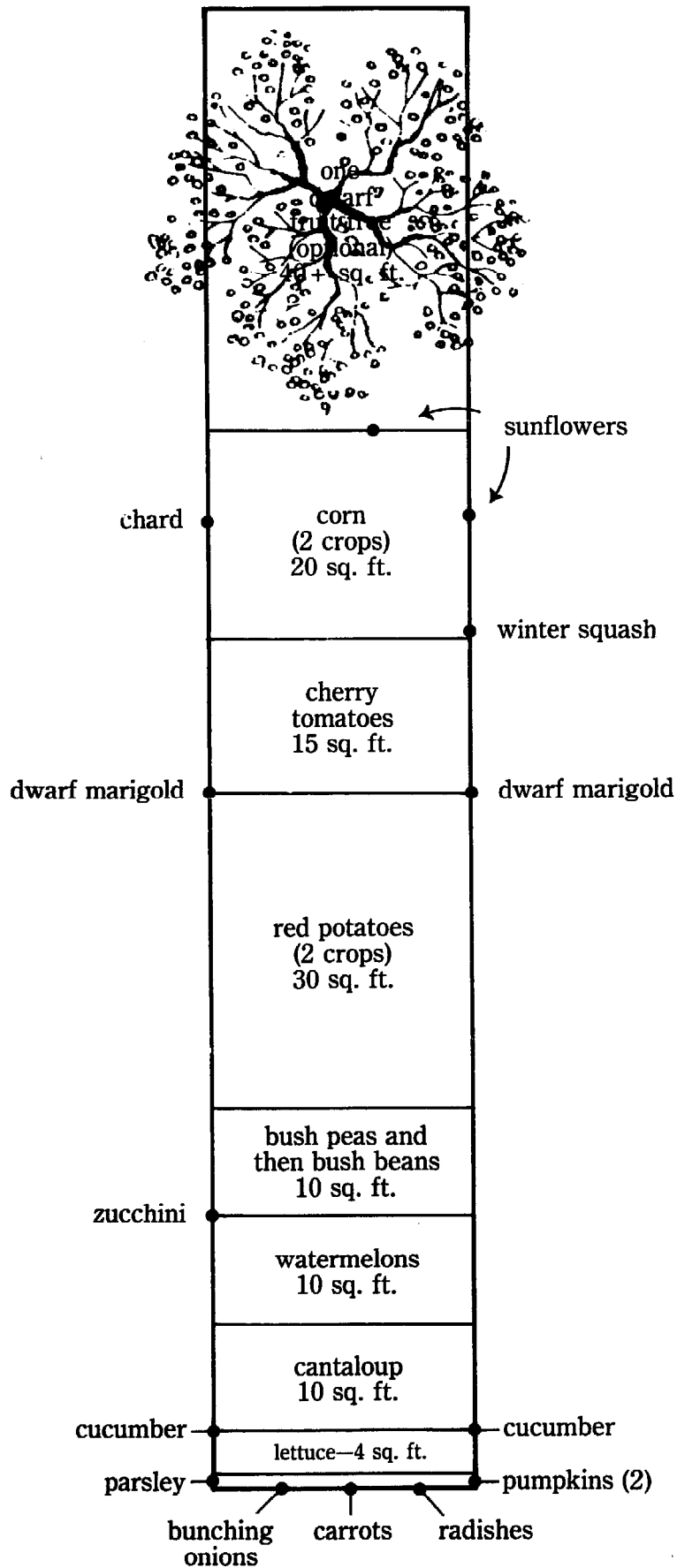

Scale: 5/16 inch to 1 foot

ONE PERSON MINI-GARDEN, *FIRST YEAR*, 6 MONTH GROWING SEASON 100 SQUARE FEET

6 weeks before last frost of spring _____
(date)

Start seedlings in flats:

cabbage -12 seeds
broccoli - 6 seeds
leaf lettuce -14 seeds[Ⓢ]
head lettuce -10 seeds[Ⓢ]

2 weeks before last frost of spring _____
(date)

Set out:

cabbage -6 plants[Ⓜ] 6.7 sq. ft.
broccoli -3 plants 3.2 sq. ft.
leaf lettuce -7 plants[Ⓢ] 5.25 sq. ft.
head lettuce -5 plants[Ⓢ]

Plant:

bush peas -172 seeds* 6.8 sq. ft.
carrots -354 seeds 3 sq. ft.
(2 seeds/center: thin to 1 plant/center)
cylindra beets - 25 seeds 1 sq. ft.
onions - 95 sets 3.8 sq. ft.
radishes - 15 seeds .25 sq. ft.

Start seedlings in flats:

tomatoes -10 seeds
peppers -12 seeds
sweet basil - 2 seeds
zinnias - 6 seeds
cucumbers -12 seeds

On last frost date _____
(date)

Plant:

potatoes -87 starts 35 sq. ft.
(10.9 lbs.)

2 weeks after last frost date _____
(date)

Set out:

tomatoes (21" centers) -5 plants 15 sq. ft.
bell peppers -6 plants 4 sq. ft.
sweet basil -1 plant 1 sq. ft.
cucumbers -6 plants 4 sq. ft.
zinnias -3 plants 3 sq. ft.

Plant:

pumpkins -2 seeds 6.3 sq. ft.
for 1 plant
zucchini -1 seed 2.3 sq. ft.
for 1 plant

6-8 weeks after last frost _____
(date)

As first crops come out, plant:

early corn (15" centers) -34 seeds 20 sq. ft.
(2 seeds/center: thin to 1 plant/center)
bush limas -56 seeds 9 sq. ft.
cosmos -- 1 seed 1 sq. ft.

14 weeks after last frost _____
(date)

As potatoes come out, plant:

early corn - 42 seeds 25 sq. ft.
(2 seeds/center: thin to 1 plant/center)
bush green beans -135 seeds* 10 sq. ft.

8-12 weeks before first frost _____
(date)

Start seedlings in flats:

leaf lettuce -24 seeds[Ⓢ]
head lettuce -14 seeds[Ⓢ]
broccoli - 2 seeds
stocks -10 seeds
calendulas -10 seeds

4-8 weeks before first frost of fall _____
(date)

As early corn comes out, set out:

leaf lettuce -12 plants[Ⓢ] 7.8 sq. ft.
head lettuce - 7 plants[Ⓢ]
broccoli - 1 plant 1.6 sq. ft.
stocks - 5 plants 5 sq. ft.
calendulas - 5 plants 5 sq. ft.

Plant:

carrots -318 seeds 2.7 sq. ft.
(2 seeds/center: thin to 1 plant/center)
bush peas -172 seeds* 6.8 sq. ft.
chard - 3 seeds 1 sq. ft.
radishes - 15 seeds .25 sq. ft.

Ⓢ = Stagger planting for a more continuous harvest.

* = Spot additional seeds later where seeds do not germinate.

Ⓜ = Numbers given are the maximum which should be required for each crop for area involved. Less may be needed.

**Spring
BED 1**

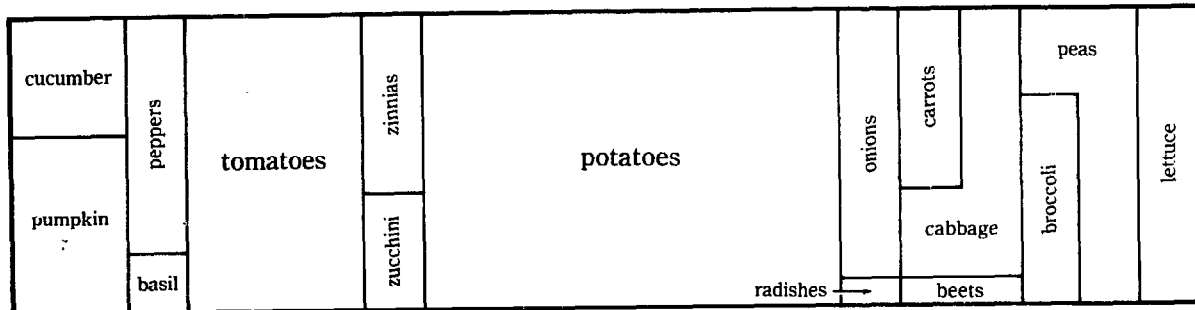

**Summer
(BED 1)**

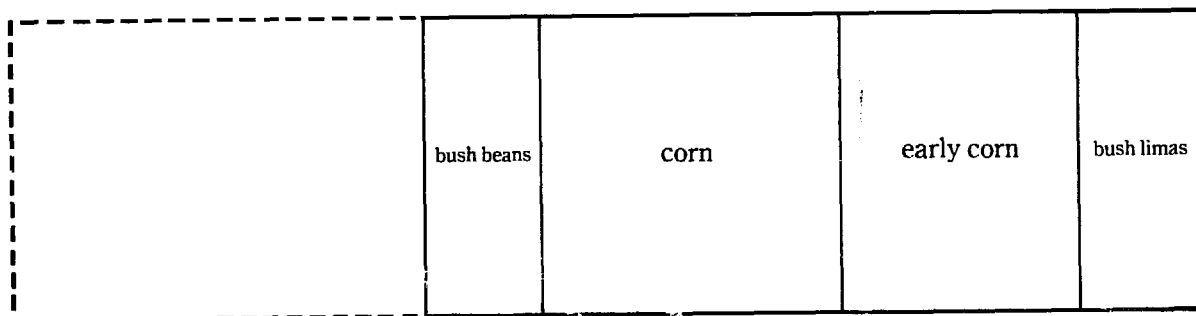

**Fall
(BED 1)**

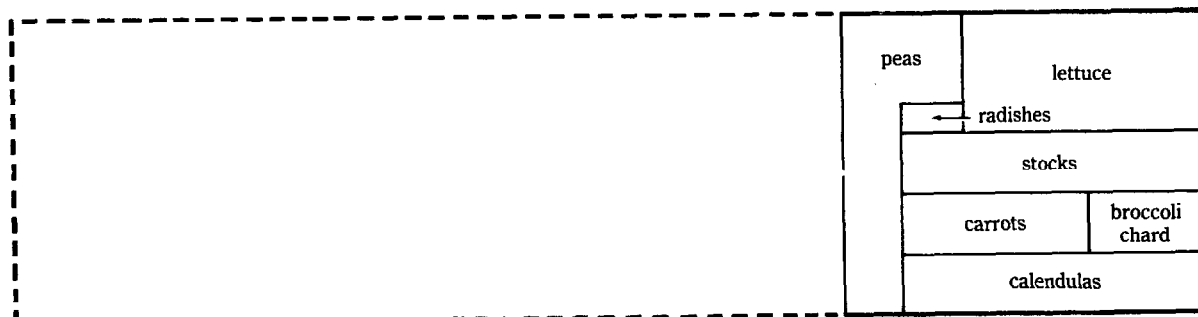

Scale: 5/16 inch to 1 foot

ONE PERSON MINI-GARDEN, SECOND YEAR, 6 MONTH GROWING SEASON 240 SQUARE FEET (including path)

6 weeks before last frost of spring _____ (date)

Start seedlings in flats:

cabbage	— 8 seeds
broccoli	— 4 seeds
brussels sprouts	— 2 seeds
cauliflower	— 2 seeds
leaf lettuce	—24 seeds (S)
head lettuce	—14 seeds (S)
celery	—24 seeds
parsley	— 4 seeds

2 weeks before last frost _____ (date)

Set out:

cabbage	— 4 plants (M)	5.2 sq. ft.
broccoli	— 2 plants	2.6 sq. ft.
cauliflower	— 1 plant	1.3 sq. ft.
brussels sprouts	— 1 plant	2.3 sq. ft.
leaf lettuce	—12 plants (S)	
head lettuce	— 7 plants (S)	7.8 sq. ft.

Plant:

spinach	— 60 seeds	2.2 sq. ft.
(2 seeds/center: thin to 1 plant/center)		
bush peas	—172 seeds*	6.8 sq. ft.
carrots	—318 seeds	2.7 sq. ft.
(2 seeds/center: thin to 1 plant/center)		
cylindra beets	— 25 seeds	1 sq. ft.
onion sets	— 95 sets	3.8 sq. ft.
radishes	— 15 seeds	.25 sq. ft.
garlic	— 8 cloves	.3 sq. ft.

Start seedlings in flats:

tomatoes	—14 seeds
bell peppers	—12 seeds
eggplant	— 2 seeds
dill	— 2 seeds

On last frost date _____ (date)

Plant:

potatoes	—100 starts	40.2 sq. ft.
	(12.5 lbs.)	

Start seedlings in flats:

cucumbers	—12 seeds
sweet basil	— 2 seeds
cantaloup	—10 seeds
honeydew melons	—10 seeds
New Hampshire midget water-melons	—50 seeds
zinnias	— 6 seeds
cosmos	— 6 seeds

2 weeks after last frost _____ (date)

Set out:

tomatoes		
(21" centers)	—7 plants	20 sq. ft.
eggplant	—1 plant	2.3 sq. ft.
bell peppers	—6 plants	4 sq. ft.
parsley	—1 plant	.7 sq. ft.

Plant:

early corn		
(15" centers)	—42 seeds	25 sq. ft.
	(2 seeds/center: thin to 1 plant/center)	

Move celery to deeper flat.

108 MAKING THE GARDEN PLAN

4 weeks after last frost _____ (date)

Set out:

cucumbers	— 6 plants	4 sq. ft.
sweet potatoes	—11 starts	4.5 sq. ft.
	(1.8 lbs.)	
dill	— 1 plant	.4 sq. ft.
sweet basil	— 1 plant	1 sq. ft.
cantaloup	— 5 plants	12.5 sq. ft.
New Hampshire midget honeydew melons	— 5 plants	16 sq. ft.
honeydew melons	—5 plants	
New Hampshire midget water-melons	—25 plants	
(12" centers)	—25 plants	16 sq. ft.
zinnias	— 3 plants	3 sq. ft.
cosmos	— 3 plants	3 sq. ft.

Set out:

celery	—12 plants	2 sq. ft.
--------	------------	-----------

Plant:

bush green beans	—188 seeds*	14 sq. ft.
bush lima beans	— 56 seeds*	9 sq. ft.
pumpkins	— 2 seeds	6.3 sq. ft.
	for 1 plant	
zucchini	— 2 seeds	2.3 sq. ft.
	for 1 plant	

8 weeks after last frost _____ (date)

As first planting comes out, plant:

potatoes	—100 starts	40.2 sq. ft.
	(12.5 lbs.)	

12 weeks after frost _____ (date)

Start seedlings in flats:

broccoli	— 2 seeds
cabbage	— 8 seeds
stocks	— 8 seeds
leaf lettuce	—24 seeds (S)
head lettuce	—14 seeds (S)
calendulas	— 8 seeds

14 weeks after frost _____ (date)

As first potatoes come out, plant:

early corn	—42 seeds	25 sq. ft.
	(2 seeds/center: thin to 1 plant/center)	

16 weeks after frost _____ (date)

Set out:

broccoli	— 1 plant	1.3 sq. ft.
leaf lettuce	—12 plants (S)	7.8 sq. ft.
head lettuce	— 7 plants (S)	2.7 sq. ft.
calendulas	— 4 plants	4 sq. ft.
stocks	— 4 plants	4 sq. ft.
cabbage	— 4 plants	5.2 sq. ft.

Plant:

chard	— 3 seeds	1 sq. ft.
radishes	— 15 seeds	.25 sq. ft.
peas	—172 seeds*	6.8 sq. ft.
carrots	—318 seeds	2.7 sq. ft.
	(2 seeds/center: thin to 1 plant/center)	
spinach	— 60 seeds	2.2 sq. ft.
	(2 seeds/center: thin to 1 plant/center)	

NOTE: By the second year, the curved bed surface gives you 120 square feet of planting area in each 100 square feet of bed.

Early Spring to Early Summer
BED 1

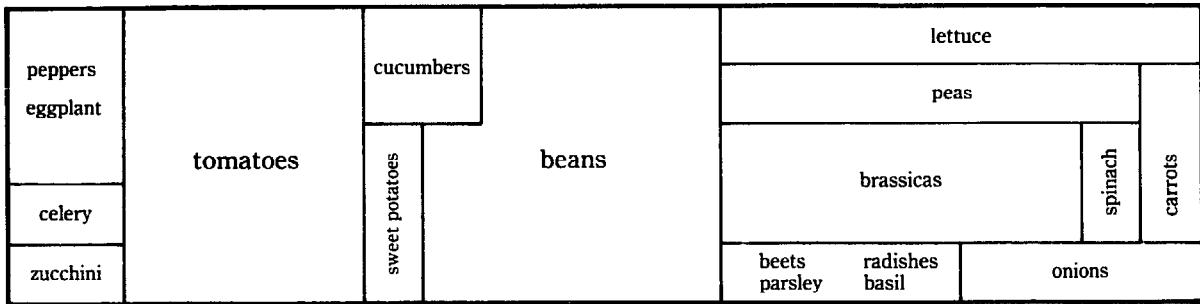

BED 2

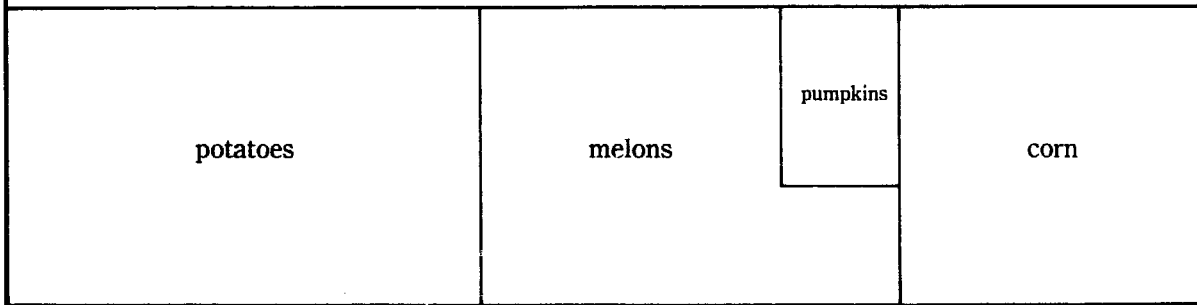

Summer to Late Summer
(BED 1)

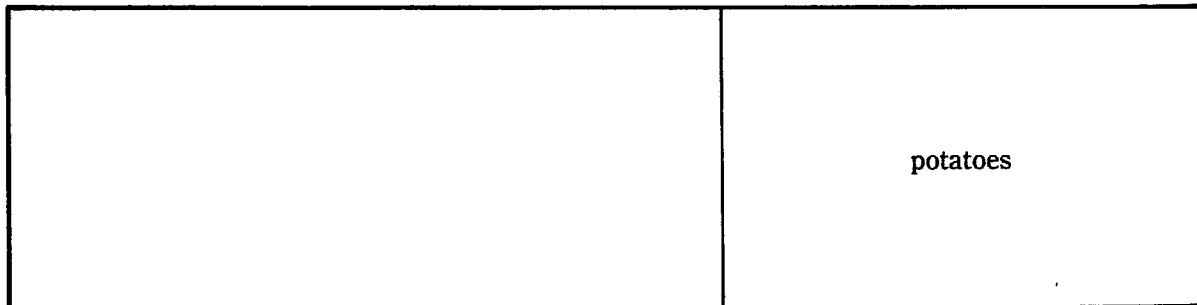

(BED 2)

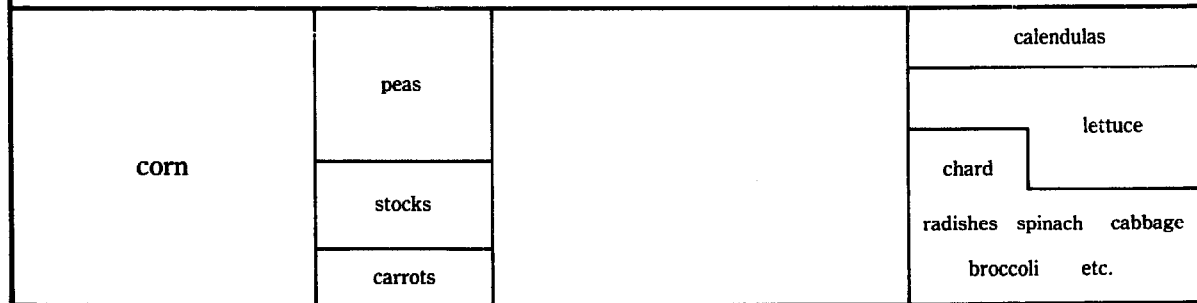

Scale: 5/16 inch to 1 foot

⊙ = Stagger planting for a more continuous harvest.

* = Spot additional seeds later where seeds do not germinate.

Ⓜ = Numbers given are the maximum which should be required for each crop for area involved. Less may be needed.

ONE PERSON MINI-GARDEN, *THIRD* YEAR, 6 MONTH GROWING SEASON

380 SQUARE FEET (including paths)

As early as possible in spring plant:

1 bare root dwarf fruit tree —64 sq. ft.
 13 asparagus roots — 8 sq. ft.
 32 strawberries —20 sq. ft.
 (12" centers)

6 weeks before last frost of spring _____ (date)

Start seedlings in flats:

cabbage — 8 seeds
 broccoli — 4 seeds
 brussels sprouts — 2 seeds
 cauliflower — 2 seeds
 leaf lettuce —24 seeds (S)
 head lettuce —14 seeds (S)
 celery —16 seeds
 parsley — 4 seeds

2 weeks before last frost _____ (date)

Start seedlings in flats:

tomatoes —14 seeds
 bell peppers —12 seeds
 eggplant — 2 seeds
 dill — 2 seeds

Set out:

cabbage — 4 plants 5.2 sq. ft.
 broccoli — 2 plants 2.6 sq. ft.
 cauliflower — 1 plant 1.3 sq. ft.
 brussels sprouts — 1 plant 2.3 sq. ft.
 leaf lettuce —12 plants (S)
 head lettuce — 7 plants (S) 7.8 sq. ft.

Plant:

spinach — 60 seeds 2.2 sq. ft.
 (2 seeds/center: thin to 1 plant/center)
 bush peas —172 seeds* 6.8 sq. ft.
 carrots —318 seeds 2.7 sq. ft.
 (2 seeds/center: thin to 1 plant/center)
 beets — 25 seeds 1 sq. ft.
 onions — 95 sets 3.8 sq. ft.
 radishes — 15 seeds .25 sq. ft.
 garlic — 8 cloves .3 sq. ft.

On last frost date _____ (date)

Plant:

potatoes —124 starts 50 sq. ft.
 (15.5 lbs.)

Start seedlings in flats:

cucumbers —12 seeds
 sweet basil — 2 seeds
 cantaloup —10 seeds
 honeydew melons —10 seeds
 New Hampshire
 midget water-
 melons —50 seeds
 zinnias —10 seeds
 cosmos —10 seeds

2 weeks after last frost _____ (date)

Set out:

tomatoes
 (21" centers) —7 plants 20 sq. ft.
 eggplant —1 plant 2.3 sq. ft.
 bell peppers —6 plants 4 sq. ft.
 parsley —1 plant .7 sq. ft.

Plant:

early corn
 (15" centers) —84 seeds 50 sq. ft.
 (2 seeds/center: thin to 1 plant/center)

Move celery to deeper flat

4 weeks after last frost _____ (date)

Set out:

cucumbers — 6 plants 4 sq. ft.
 sweet potatoes —11 starts 4.5 sq. ft.
 (1.8 lbs.)
 dill — 1 plant .4 sq. ft.
 sweet basil — 1 plant 1 sq. ft.
 cantaloup — 5 plants
 honeydew melons — 5 plants 12.5 sq. ft.
 New Hampshire
 midget water-
 melons —25 plants 16 sq. ft.
 zinnias — 5 plants 5 sq. ft.
 cosmos — 5 plants 5 sq. ft.
 celery —12 plants 2 sq. ft.

Plant:

bush green beans —188 seeds* 14 sq. ft.
 bush lima beans — 56 seeds* 9 sq. ft.
 pumpkins — 2 seeds 6.3 sq. ft.
 for 1 plant
 zucchini — 2 seeds 2.3 sq. ft.
 for 1 plant

8 weeks after last frost _____ (date)

As first planting comes out plant:

potatoes —75 starts 30 sq. ft.
 (9.4 lbs.)

12 weeks after frost _____ (date)

Start seedlings in flats:

broccoli — 2 seeds
 cabbage — 8 seeds
 stocks — 8 seeds
 leaf lettuce —24 seeds (S)
 head lettuce —14 seeds (S)
 calendulas — 8 seeds

16 weeks after frost _____ (date)

Set out:

cabbage — 4 plants 5.2 sq. ft.
 stocks — 4 plants 4 sq. ft.
 calendulas — 4 plants 4 sq. ft.
 broccoli — 1 plant 1.3 sq. ft.
 leaf lettuce —12 plants (S)
 head lettuce — 7 plants (S) 7.8 sq. ft.

Plant:

chard — 3 seeds 1 sq. ft.
 carrots —318 seeds 2.7 sq. ft.
 (2 seeds/center: thin to 1 plant/center)
 radishes — 15 seeds .25 sq. ft.
 bush peas —172 seeds* 6.8 sq. ft.

**Spring
BED 1**

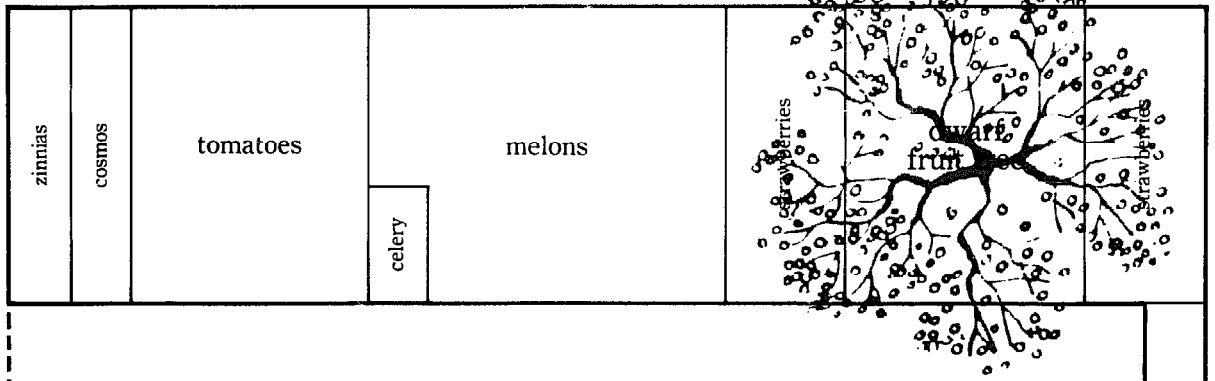

**Spring
BED 2**

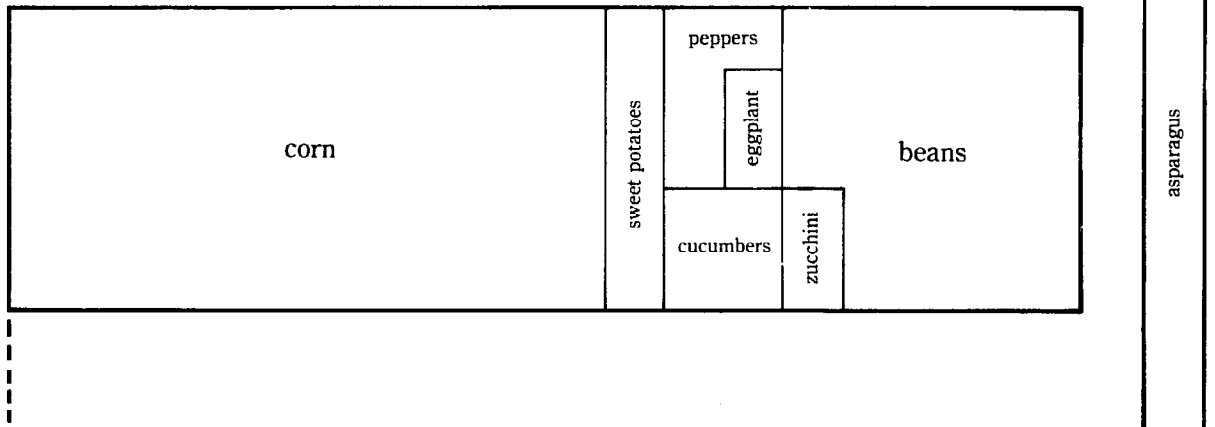

**Spring
BED 3**

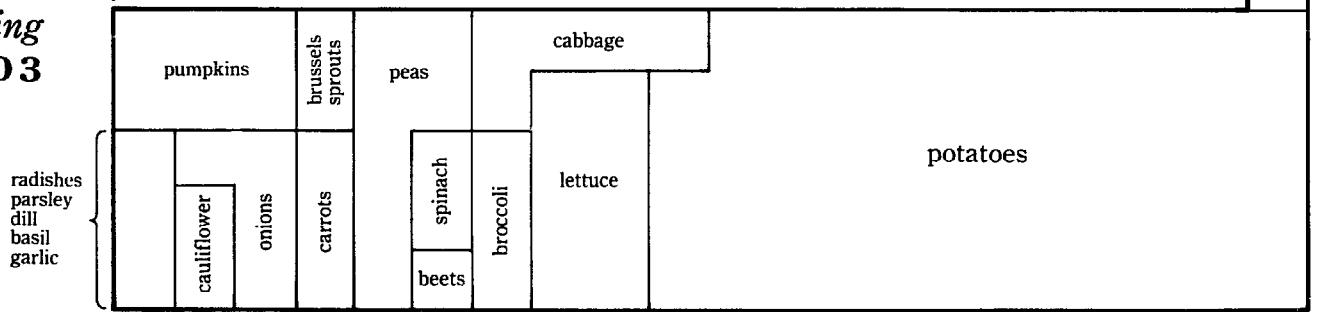

followed by potatoes in Early Summer

**Early
Fall
(BED 2)**

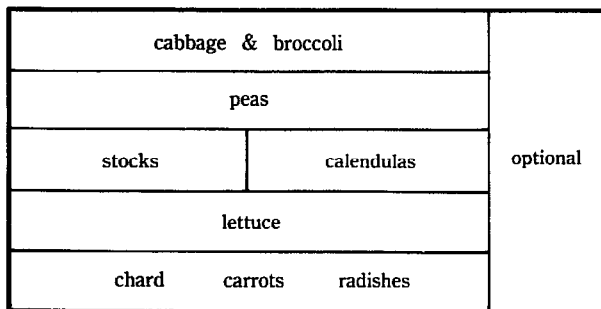

Scale: 5/16 inch to 1 foot

- Ⓢ = Stagger planting for a more continuous harvest.
- * = Spot additional seeds later where seeds do not germinate.
- Ⓜ = Numbers given are the maximum which should be required for each crop for area involved. Less may be needed.

ONE PERSON MINI-GARDEN, *FOURTH* YEAR, 6 MONTH GROWING SEASON 380 SQUARE FEET (including paths)

As soon as possible in spring, plant:

An additional bare root		
dwarf fruit tree — 1 tree	64	sq. ft.
relocate		
strawberries — 32 plants ^(M)	20	sq. ft.
lavender — 1 plant	4	sq. ft.
sage — 1 plant	2.3	sq. ft.
marjoram — 1 plant	1	sq. ft.
chives — 3 plants	.5	sq. ft.
<i>OR whatever herbs desired</i>		

5 weeks before last frost of spring _____ (date)

Start seedlings in flats:

cabbage — 8 seeds		
broccoli — 4 seeds		
brussels sprouts — 2 seeds		
cauliflower — 2 seeds		
leaf lettuce — 24 seeds ^(S)		
head lettuce — 14 seeds ^(S)		
celery — 16 seeds		
parsley — 4 seeds		

2 weeks before last frost _____ (date)

Set out:

cabbage — 4 plants	5.2	sq. ft.
broccoli — 2 plants	2.6	sq. ft.
cauliflower — 1 plant	1.3	sq. ft.
brussels sprouts — 1 plant	2.3	sq. ft.
leaf lettuce — 12 plants ^(S)		
head lettuce — 7 plants ^(S)	7.8	sq. ft.

Plant:

bush peas — 172 seeds*	6.8	sq. ft.
carrots — 318 seeds	2.7	sq. ft.
(2 seeds/center: thin to 1 plant/center)		
beets — 25 seeds	1	sq. ft.
onions — 95 sets	3.8	sq. ft.
radishes — 15 seeds	.25	sq. ft.
garlic — 8 sets	.3	sq. ft.

Start seedlings in flats:

tomatoes — 14 seeds		
bell peppers — 12 seeds		
eggplant — 2 seeds		
lill — 2 seeds		

On last frost date _____ (date)

Plant:

potatoes — 99 starts	40	sq. ft.
(12.4 lbs.)		

Start seedlings in flats:

cucumbers — 12 seeds		
sweet basil — 2 seeds		
cantaloup — 10 seeds		
New Hampshire midget water-melons — 10 seeds		

1 weeks after last frost _____ (date)

Set out:

tomatoes (21" centers) — 7 plants	20	sq. ft.
eggplant — 1 plant	2.3	sq. ft.
bell peppers — 6 plants	4	sq. ft.
parsley — 1 plant	.7	sq. ft.

Plant:

early corn (15" centers) — 42 seeds	25	sq. ft.
(2 seeds/center: thin to 1 plant/center)		

Move celery to deeper flat

4 weeks after last frost _____ (date)

Set out:

cucumbers — 6 plants	4	sq. ft.
sweet potatoes — 11 starts	4.5	sq. ft.
(1.8 lbs.)		
dill — 1 plant	.4	sq. ft.
sweet basil — 1 plant	1	sq. ft.
cantaloup — 5 plants		
honeydew melons — 5 plants	12.5	sq. ft.
New Hampshire midget water-melons — 25 plants	16	sq. ft.
celery — 12 plants	2	sq. ft.

Plant:

bush green beans — 188 seeds*	14	sq. ft.
bush lima beans — 56 seeds*	9	sq. ft.
pumpkins — 2 seeds	6.3	sq. ft.
for 1 plant		

8 weeks after last frost _____ (date)

As first planting comes out plant:

potatoes — 99 starts	40	sq. ft.
(12.4 lbs.)		

12 weeks after frost _____ (date)

Start seedlings in flats:

broccoli — 2 seeds		
cabbage — 8 seeds		
stocks — 10 seeds		
leaf lettuce — 24 seeds ^(S)		
head lettuce — 14 seeds ^(S)		
calendulas — 10 seeds		

14 weeks after frost _____ (date)

As first potatoes come out plant:

early corn (15" centers) — 42 seeds	25	sq. ft.
(2 seeds/center: thin to 1 plant/center)		

16 weeks after frost _____ (date)

Set out:

broccoli — 1 plant	1.3	sq. ft.
leaf lettuce — 12 plants ^(S)	7.8	sq. ft.
head lettuce — 7 plants ^(S)		
cabbage — 4 plants	5.2	sq. ft.
stocks — 5 plants	5	sq. ft.
calendulas — 5 plants	5	sq. ft.

Plant:

carrots — 318 seeds	2.7	sq. ft.
(2 seeds/center: thin to 1 plant/center)		
chard — 3 seeds	1	sq. ft.
radishes — 15 seeds	.25	sq. ft.
bush peas — 172 seeds	6.8	sq. ft.
spinach — 60 seeds	2.2	sq. ft.
(2 seeds/center: thin to 1 plant/center)		

**Spring
BED 1**

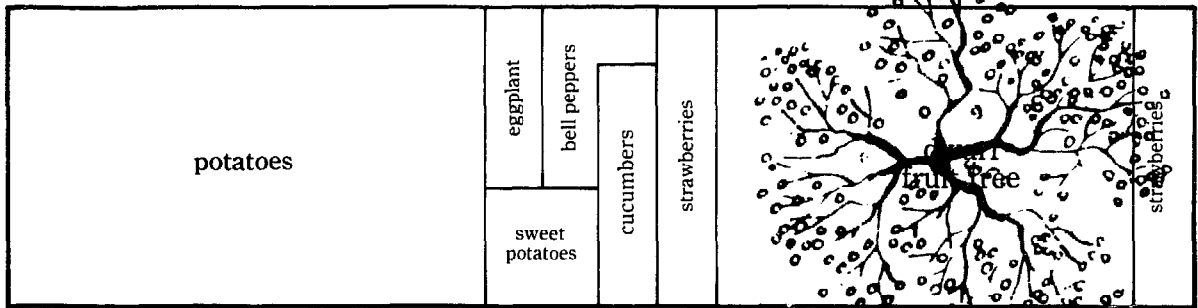

**Spring
BED 2**

basil
beets
dill
garlic
parsley
radishes

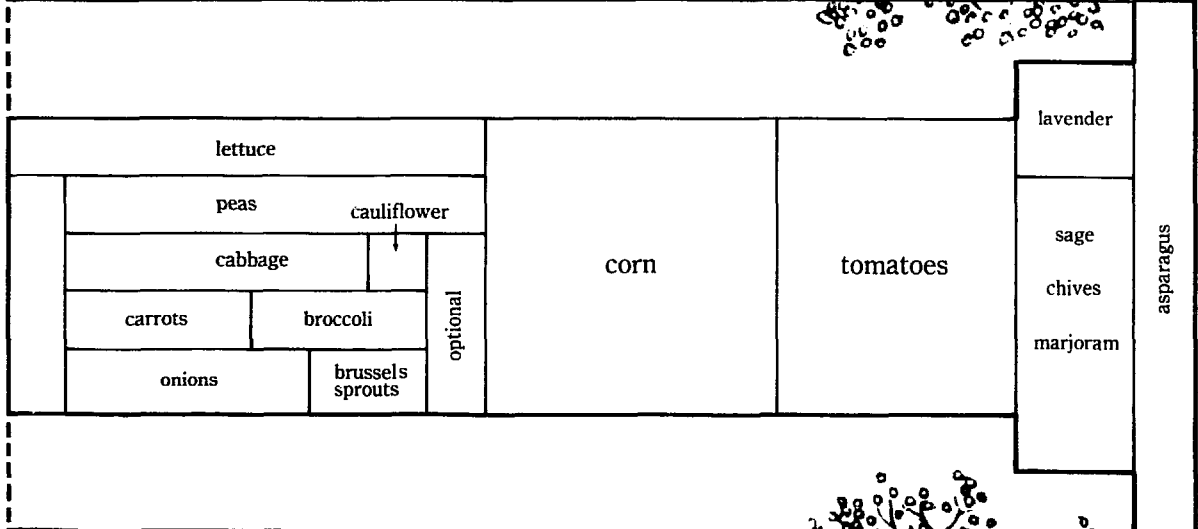

**Spring
BED 3**

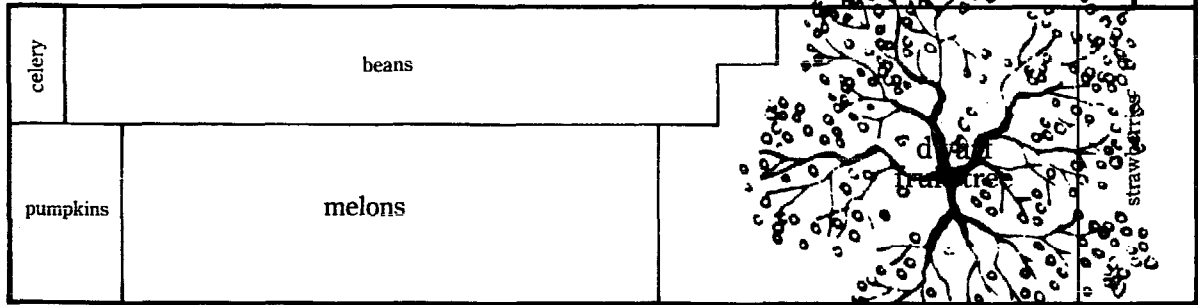

**Summer/
Early
Fall
(BED 1)**

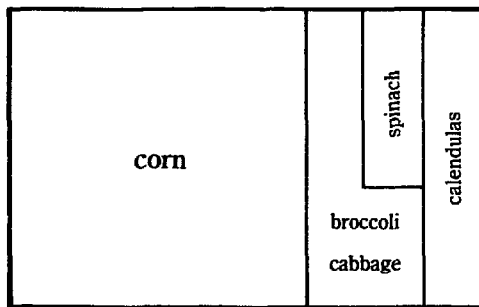

⊙ = Stagger planting for a more continuous harvest.

* = Spot additional seeds later where seeds do not germinate.

Ⓜ = Numbers given are the maximum which should be required for each crop for area involved. Less may be needed.

**Summer/
Early
Fall
(BED 2)**

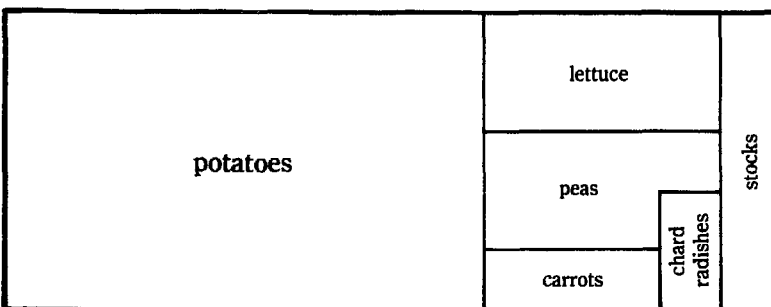

Scale: 5/16 inch to 1 foot

FOUR PERSON FAMILY FOOD GARDEN, 6 MONTH GROWING SEASON
1,302 SQUARE FEET (including paths)

As soon as possible in spring, plant:
 7 bare root dwarf fruit trees—448 sq. ft.

6 weeks before last frost of spring _____
 (date)

Start seedlings in flats:
 cabbage —32 seeds
 broccoli —16 seeds
 brussels sprouts — 8 seeds
 cauliflower — 8 seeds
 head lettuce —96 seeds (S)
 leaf lettuce —56 seeds (S)
 celery —96 seeds
 parsley —16 seeds

2 weeks before last frost _____
 (date)

Set out:
 cabbage —16 plants (M) 45.6 sq. ft.
 broccoli — 8 plants
 cauliflower — 4 plants
 brussels sprouts — 4 plants
 leaf lettuce —48 plants (S)
 head lettuce —28 plants (S) 31.2 sq. ft.

Plant:
 spinach — 234 seeds 8.8 sq. ft.
 (2 seeds/center: thin to 1 plant/center)
 bush peas —1,370 seeds* 54.4 sq. ft.
 carrots —1,414 seeds 24 sq. ft.
 (2 seeds/center: thin to 1 plant/center)
 beets — 100 seeds 4 sq. ft.
 onions — 380 sets 15.2 sq. ft.
 radishes — 60 seeds 1 sq. ft.
 garlic — 32 cloves 1.2 sq. ft.
 chard — 12 seeds 4 sq. ft.

Start seedlings in flats:
 tomatoes —56 seeds
 bell peppers —48 seeds
 eggplant — 8 seeds
 dill — 8 seeds

On last frost date _____
 (date)

Plant:
 potatoes —546 starts 220 sq. ft.
 (68.25 lbs.)

Start seedlings in flats:
 cantaloup — 40 seeds
 honeydew — 40 seeds
 New Hampshire
 midget water-
 melons —160 seeds
 cucumbers — 48 seeds
 sweet basil — 8 seeds
 zinnias — 20 seeds
 cosmos — 24 seeds

2 weeks after last frost _____
 (date)

Set out
 tomatoes
 (21" centers) —28 plants 80 sq. ft.
 eggplant — 4 plants 9.2 sq. ft.
 bell peppers —24 plants 16 sq. ft.
 parsley — 4 plants 2.8 sq. ft.

Plant:
 early corn
 (15" centers) —168 seeds 100 sq. ft.
 (2 seeds/center: thin to 1 plant/center)

Move celery to deeper flat

4 weeks after last frost _____
 (date)

Set out:
 cucumbers —24 plants 16 sq. ft.
 celery —48 plants 8 sq. ft.
 sweet potatoes —44 starts 18 sq. ft.
 (7.2 lbs.)
 dill — 4 plants 1.6 sq. ft.
 sweet basil — 4 plants 4 sq. ft.
 zinnias —10 plants 10 sq. ft.
 cosmos —12 plants 12 sq. ft.

Plant:
 pumpkins —8 seeds 25.2 sq. ft.
 (2 seeds/center: thin to 1 plant/center)
 zucchini —8 seeds 9.2 sq. ft.
 (2 seeds/center: thin to 1 plant/center)
 sunflowers —8 seeds 15 sq. ft.
 (2 seeds/center: thin to 1 plant/center)

6 weeks after last frost _____
 (date)

As peas and carrots come out, replant bed with:
 cantaloup —20 plants
 honeydew —20 plants } 50 sq. ft.
 watermelons —80 plants }

As early brassicas and lettuce come out, replant bed with:
 bush green beans —752 seeds* 56 sq. ft.
 bush lima beans —224 seeds* 36 sq. ft.

12 weeks after last frost _____
 (date)

As first corn comes out, plant:
 potatoes —248 starts 100 sq. ft.
 (31 lbs.)

14 weeks after last frost _____
12 weeks before first frost of fall) (date)

As first potatoes come out plant:

early corn —168 seeds 100 sq. ft.
(15" centers) (2 seeds/center: thin to 1 plant/center)

Start seedlings in flats:

broccoli —16 seeds
cabbage —32 seeds
stocks —20 seeds
leaf lettuce —96 seeds (S)
head lettuce —56 seeds (S)
calendulas —20 seeds

18 weeks after last frost _____
8 weeks before first fall frost) (date)

As last potatoes come out:

Set out:

broccoli — 4 plants 5.2 sq. ft.
leaf lettuce —48 plants (S) 31.2 sq. ft.
head lettuce —28 plants (S)
calendulas —10 plants 10 sq. ft.
stocks —10 plants 10 sq. ft.
cabbage —16 plants 20.8 sq. ft.

Plant:

chard — 12 seeds 4 sq. ft.
radishes — 60 seeds 1 sq. ft.
spinach —240 seeds 8 sq. ft.
(2 seeds/center: thin to 1 plant/center)

(S) = Stagger planting for a more continuous harvest.

* = Spot additional seeds later where seeds do not germinate.

(M) = Numbers given are the maximum which should be required for each crop for area involved. Less may be needed.

Family Food Garden—Spring

Scale: 1/4 inch to 1 foot

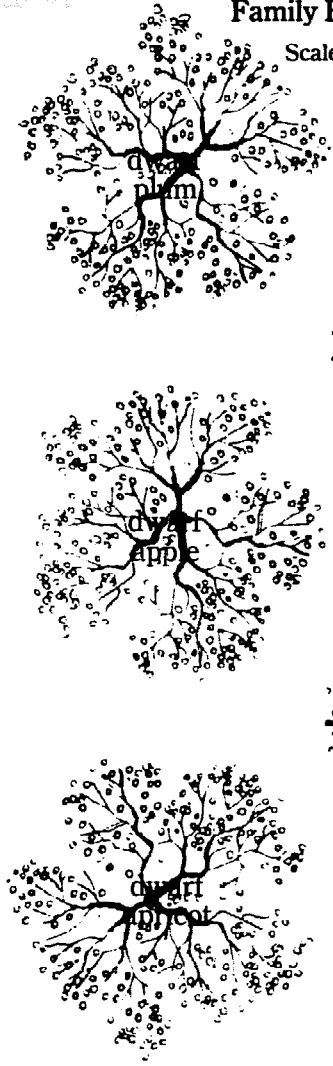

compost	compost
---------	---------

potatoes

corn

potatoes 120 sq. ft.

eggplant
basil dill parsley garlic
tomatoes

spinach	beets	chard	optional
radishes →			
carrots			
peas			

onion sets
lettuce
brassicas

sunflowers	pumpkins
celery	
sweet potato	
cucumbers	
zucchini	
bell peppers	

Family Food Garden—*Summer/Fall*

Scale: 1/4 inch to 1 foot

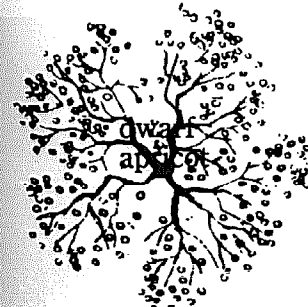
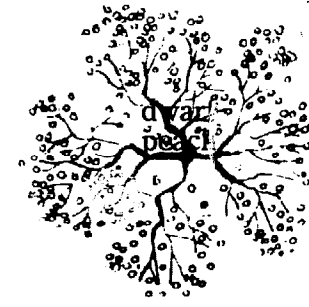
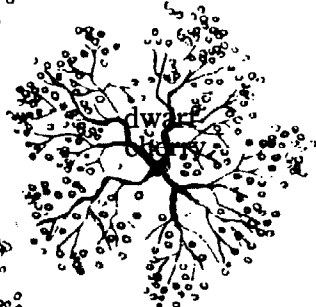
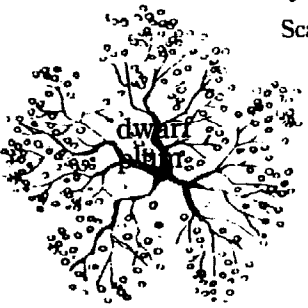

compost	compost
---------	---------

stocks
spinach
broccoli
calendulas
chard
cabbage
calendulas
lettuce

potatoes

cosmos zinnias
corn 100 sq. ft.

unchanged from Spring

melons

beans

unchanged from Spring



Companion Planting

Like the relationships among people, certain plants like and dislike each other, depending on the specific natures involved. Seedlings of transplanting size begin to relate more and more with the plants around them. These relationships become especially important as adult plants develop distinct personalities, essences and aromas. Green beans and strawberries, for example, thrive better when they are grown together than when they are grown separately. To get really good tasting bibb lettuce, one spinach plant should be grown for every four bibb lettuce plants.

In contrast, no plants grow well near wormwood due to its toxic leaf and root excretions. However, wormwood tea repels black fleas, discourages slugs, keeps beetles and weevils out of grain and combats aphids. So wormwood is not a totally noxious herb. Few plants are. Instead, they have their place in the natural order of things. Tomatoes are narcissistic. They like to be grown in compost made from their own bodies. They also like to be grown in the same area for a five year period.

Weeds are often specialists and doctors in the plant community. They take very well to a sick soil which needs to be built up and almost seem to seek it out. Where cultivated garden plants could not manage, weeds are able to draw phosphorus, potash, calcium, trace minerals and other nutrients out of the soil and subsoil and concentrate them in their bodies. Plants seem to have uncanny instincts.

Weeds can be used to concentrate nutrients for future fertilization or to withdraw noxious elements, such as unwanted salts, from the growing area. A deficient soil is often enriched by the use of weeds in man-made compost or by the return of their dead bodies to the soil in nature.

Companion planting is the constructive use of plant relationships by the gardener, horticulturist and farmer. A scientific definition of companion planting is the placing together of

plants having complementary physical demands. A more accurate, living and spiritual description is the growing together of all those elements and beings which encourage *life* and *growth*: the creation of a microcosm that includes vegetables, fruits, trees, bushes, wheat, flowers, weeds, birds, soil, microorganisms, water, nutriment, insects, toads, spiders and chickens.

Companion planting is still an experimental field in which much more research needs to be performed. The age of the plants involved and the percentage of each of the types of plants grown together can be critical, as can be their relative proximity to one another. Companion planting should, therefore, be used with some caution and much observation. You may want to study the causes of some of these beneficial relationships. Are they due to root excretions, plant aroma or the pollen of composite flowers that attract certain beneficial predatory insects? Companion planting is a fascinating field.

Some of the companion planting techniques you can eventually try and experience are ones for Health; Nutrition; Physical Complementarity; and Weed, Insect and Animal Relationships.

Health

Better Growth—The growing together of green beans and strawberries and bibb lettuce and spinach has already been mentioned. On the other side of the spectrum, onions, garlic, chives and shallots seriously inhibit the growth of peas and beans. In between the extremes, *bush* beans and beets may be grown together with no particular advantage or disadvantage to either plant. *Pole* beans and beets, on the other hand, do not get along well. The nuances are amazing. What is the difference between bush and pole beans? No one appears to know the scientific reason yet, but the difference can be observed. Ehrenreid Pfeiffer developed a method known as crystallization from which one can predict in advance whether or not plants are good companions. In this technique, part of a plant is ground up and mixed with a chemical solution. After the solution dries, a crystalline pattern remains. Different plants have distinct, representative patterns. When two plant solutions are mixed, the patterns increase, decrease or stay the same in strength and regularity. Sometimes, both patterns improve, indicating a reciprocal, beneficial influence. Or both may deteriorate in a reciprocal negative reaction. One pattern may improve while another deteriorates, indicating a one-sided advantage. Both patterns may remain the same, indicating no particular companion advantage or disadvantage. And one plant pattern may increase or decrease in quality while the other undergoes no change. Two plants, which suffer a decrease in quality on a one-to-one basis, may show an increase in strength in a one-to-ten ratio.

Spacing for Better Companions—Using French intensive spacing with the plant leaves barely touching allows good companions to be better friends.

All Round Beneficial Influence—Certain herbs and one tree have a beneficial influence on the plant community. These plants and their characteristics are:⁵⁵



Stinging nettle and tomatoes. Good garden companions.

- Lemon Balm
Creates a beneficent atmosphere around itself and attracts bees. Part of the mint family.
- Marjoram
Has a “beneficial effect on surrounding plants”.
- Oregano
Has a “beneficial effect on surrounding plants”.
- Stinging Nettle (*Urtica dioica*)
“Helps neighboring plants to grow more resistant to spoiling”. Increases essential oil content in many herbs. “Stimulates humus formation”. Helps stimulate fermentation in compost piles. As a tea, promotes plant growth and helps strengthen plants. Concentrates sulfur, potassium, calcium and iron in its body.
- Valerian (*Valeriana officinalis*)
“Helps most vegetables”. Stimulates phosphorus activity in its vicinity. Encourages health and disease resistance in plants.
- Chamomile (*Chamomile officinalis*)
A lime specialist. “Contains a growth hormone which . . . stimulates the growth of yeast”. In a 1:100 ratio helps growth of wheat. As a tea, combats diseases in young plants such as damping off. Concentrates calcium, sulfur and potash in body.
- Dandelion (*Taraxacum officinale*)
Increases “aromatic quality of all herbs.” “In small amounts” helps most vegetables. Concentrates potash in its body.
- Oak Tree
Concentrates calcium in its bark (bark ash is 77% calcium). In a special tea, it helps plants resist harmful diseases. The oak tree provides a beneficial influence around it which allows excellent soil to be produced underneath its branches. An excellent place to build a compost pile for the same reason, but keep the pile at least 6 feet from the tree trunk so an environment will not be created near the tree which is conducive to disease or attractive to harmful insects.

Note: Lemon balm, marjoram, oregano, and valerian are perennials. They are traditionally planted in a section along

55. Helen Philbrick and Richard B. Gregg, *Companion Plants and How to Use Them*. The Devin-Adair Company, Old Greenwich, Connecticut, 1966, pp. 16, 57, 58, 60, 65, 84, 85, 86, 92.

Rudolf Steiner, *Agriculture—A Course of Eight Lectures*. Biodynamic Agricultural Association, London, 1958, pp. 93–95, 97, 99, 100.

one end of the bed so they need not be disturbed when the bed is replanted.

Soil Life Stimulation—Stinging Nettle helps stimulate the microbial life and this helps plant growth.

Soil Improvement—Sow Thistle (*Sonchus oleraceus*) brings up nutrients from the subsoil to enrich a depleted topsoil. After years of dead Sow Thistle bodies have enriched the top soil, heavier feeding grasses return. This is part of nature's recycling program in which leached out nutrients are returned to the topsoil as well as a natural method for raising new nutrient to the upper layers of the soil. It has been estimated that *one* rye plant grown in good soil produces an average of 3 miles of roots per day, 387 miles of roots during a season and 6,603 miles of root hairs. Plants are continuously providing their own composting program underground. In one year 800-1500 pounds of roots per acre are put into the soil by plants in a small garden, and red clover puts 1200-3850 pounds of roots into the soil in the same period of time.⁵⁶

Nutrition

Over Time—Companion planting "over time" has been known for years as "crop rotation". After proper preparation of the soil, heavy feeders are planted. These are followed by heavy givers and then light feeders. This is a kind of *agricultural recycling* in which man and plants participate to return as much to the soil as has been taken out.

Heavy feeders, most of the vegetables we like and eat, (including corn, tomatoes, squash, lettuce, and cabbage) take a large amount of nutrient, especially nitrogen, from the soil. In the biodynamic/French intensive method, after heavy feeders have been harvested, phosphorus and potash are returned to the soil in the form of compost. This is supplemented with some bone meal (calcium, phosphorus and a little nitrogen), and a small amount of wood ash (potash and some trace minerals). To return nitrogen to the soil, heavy givers are grown. Heavy givers are nitrogen-fixing plants or legumes: such as peas, beans, alfalfa, clover and vetch. Fava beans are good for this purpose. Not only do they bring large amounts of nitrogen into the soil, they also excrete substances which help eradicate tomato wilt causing organisms. (*Caution:* some people of Mediterranean descent *are fatally allergic* to fava beans even though they are very popular and widely eaten by these people. People on certain medications experience the same reaction. Check with your physician first.) After heavy givers, light feeders (all root crops) should be planted to give the soil a rest before the next heavy feeder



Plant root systems improve the topsoil by bringing up nutrients from the subsoil.

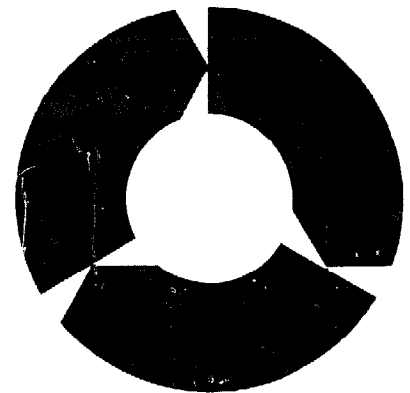

AGRICULTURAL RECYCLING

⁵⁶ Helen Philbrick and Richard B. Gregg, *Companion Plants and How To Use Them*, The Devin-Adair Company, Old Greenwich, Connecticut, 1966, pp. 75-76.

onslaught. Three vegetables are low nitrogen lovers: turnips (a light feeder), sweet potatoes (a light feeder) and green peppers (a heavy feeder of nutrients other than nitrogen). The two light feeders would normally be planted after heavy givers, which put a lot of nitrogen into the soil. You may find it useful to have them follow a heavy feeder instead. It would also be good to have the green pepper follow a heavy feeder. (It normally comes after a heavy giver and a light feeder.) You should experiment with these out of sequence plantings.

In Space—Companion planting of heavy feeders, heavy givers and light feeders can be done in the same growing area at the same time. For example, corn, beans and beets can be intermingled in the same bed. Just as with companion planting “over time”, the gardener should proceed with care. In the above combination, the beans must be bush beans, since pole beans and beets do not grow well together. Also, pole beans have been reported to pull ears off the corn stalks. Pole beans have been grown successfully with corn, however; and a vegetable such as carrots may be substituted for the beets to allow you to use the tall beans. When different plants are grown together, you sacrifice some of the *living mulch* advantage to companion planting “in space” because of the different plant heights. One way to determine the spacing for different plants grown together, is to add their spacing together and divide by two. If you grow corn and beets together, add 15 inches to 3 inches for a total of 18 inches. Divided by 2, you

TWO CROP COMPANION PLANTING

Circles show average root growth diameters.

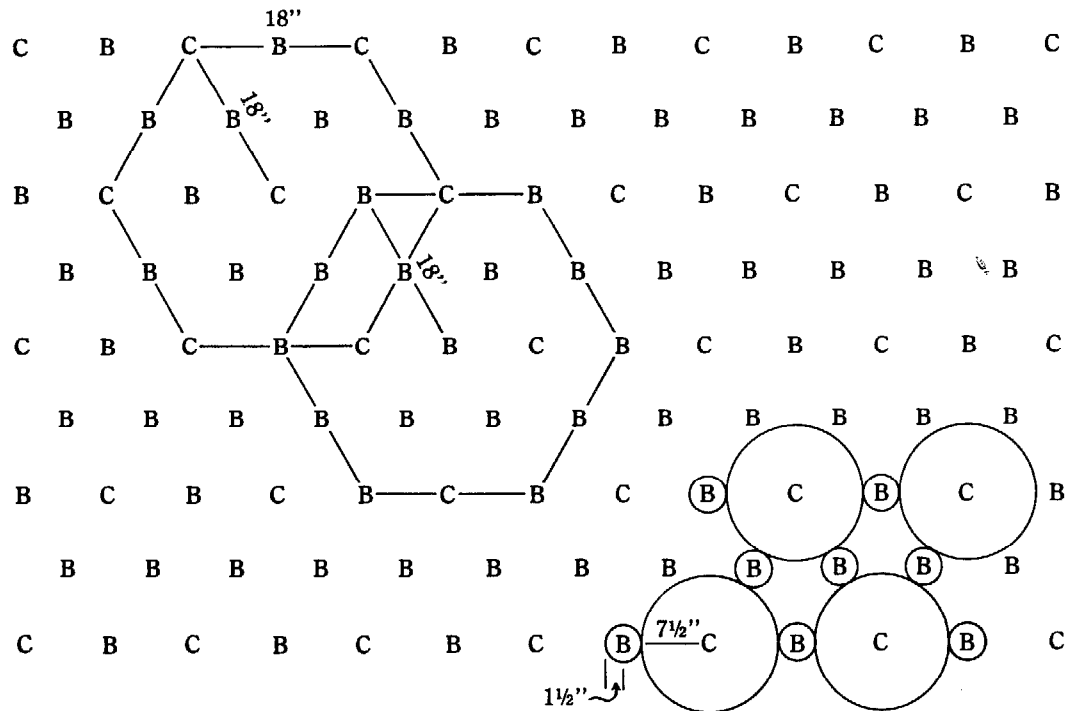

get a per plant spacing of 9 inches. The beets, then, would be 9 inches from each corn plant and vice versa. Each corn plant will be 18 inches from each corn plant and most beet plants will be 9 inches from the other beet plants nearest to them. In the drawing below, note that each corn plant gets the 7-1/2 inches in each direction that it requires for a total of a growing area with a "diameter" of 15 inches. Each beet plant, at the same time, gets the 1-1/2 inches it requires in each direction for a growing space with a 3 inch "diameter". (See diagram on page 122.)

An easier, and probably just as effective method of companion planting "in space" is to divide your planting bed into separate sections (or beds within a bed) for each vegetable. In this method, a grouping of corn plants would be next to a group of bush beans and a group of beets. In reality, this is a kind of companion planting "over time" since there are heavy feeder, heavy giver and light feeder sections within a bed. Plant roots extend 1 to 4 feet around themselves, so it is also companion planting "in space". *We recommend you use this approach.* Additional spacing patterns no doubt exist and will be developed for companion planting "in space".

MULTI-CROP COMPANION PLANTING "IN SPACE"

corn	bush beans	beets	corn	bush beans	beets
------	------------	-------	------	------------	-------

A spacing example for 3 crops grown together—corn (a heavy feeder), bush beans (a heavy giver) and beets (a light feeder)—is given on page 124. You should note that this approach to companion planting in space uses more bush bean and beet plants than corn and also contains some gaps in which still more bush beans and beets can be planted.

Compromise and Planning—You can see by now that companion planting involves selecting the combination of factors which works best in your soil and climate. Fortunately, the myriad of details fall into a pattern of simple guidelines. Within the guidelines, however, there are so many possible combinations that the planning process can become quite complex. Be easy on yourself. Only do as much companion planting as is easy for you and comes naturally. What you learn this year and

THREE CROP COMPANION PLANTING

Circles show average root growth diameters.

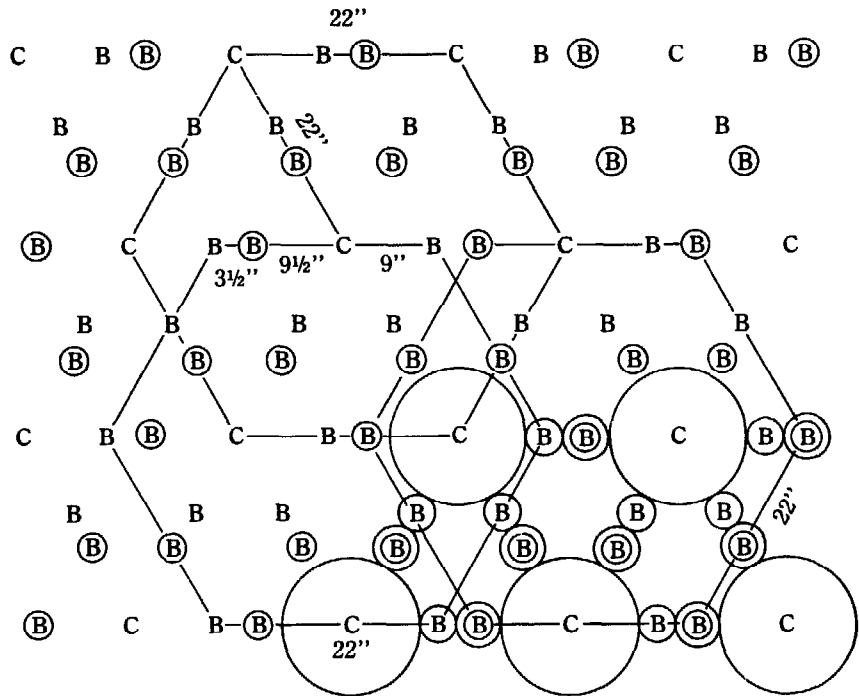

Using the sun/shade technique is one way to make the most of your plants' physically complementary characteristics.

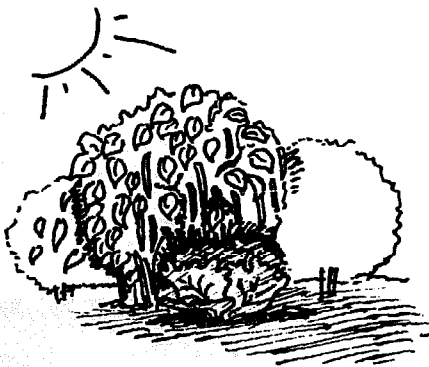

Lettuce plants can be nestled among other larger plants for partial shade.



Corn can provide the shade which cucumbers enjoy.

become comfortable with, can be applied next year and so on. An easy place to start is with salad vegetables since these are generally companions. Also, it is easier to companion plant over time rather than in space. Since you probably will not have enough area to use an entire bed for each crop, you might create several heavy feeder, heavy giver and light feeder sections within each bed. You may want to grow a preponderance of crops from one group such as the heavy feeders. (It is unlikely that you will want to grow 1/3 of each crop type.) Therefore, you will need to make adjustments, such as adding extra fertilizer and compost, when you follow one heavy feeder with another. Due to lack of space, you may have to grow some plants together that are not companions. If so, you may need to be satisfied with lower yields, lower quality vegetables and less healthy plants. Or, you might try to alter your diet to one which is still balanced but more in line with the balances of nature. At any rate, you can see it is useful to plan your garden in advance. You will need to know how many pounds of each vegetable you want during the year, how many plants are needed to grow the weight of vegetables you require, when to plant seeds both in flats and in the ground, when and how to rotate your crops and when to raise and transplant herbs so they will be at the peak of their own special influence. Use the charts at the end of the Seed Propagation chapter to assist in this work. To have their optimum effect as companions, herb plants should be reasonably mature when transplanted into a bed for insect control or

general beneficial influence. It is easiest to plan your garden 12 months at a time and always at least 3 months in advance.

Physical Complementarity

Sun/Shade—Many plants have a special need for sunlight or a lack of it. Cucumbers, for example, are very hard to please. They like heat, moisture, a well-drained soil and some shade. One way to provide these conditions is to grow cucumbers with corn. The corn plants, which like heat and sun, can provide partial shade for the cucumber plants. Lettuce or carrot plants nestled among other plants for partial shade is another example. Sunflowers, which are tall and like lots of sun, should be planted at the north side of the garden. There they will not shade other plants and will receive enough sun for themselves.

Shallow/Deep Rooting—There is no good, detailed example available. A dynamic process does occur over time, however, as plants with root systems of differing depths and breadths work different areas of the soil in the planting bed.⁵⁷

Fast/Slow Maturing—The French intensive gardeners were able to grow as many as four crops in a growing bed at one time due to the staggered growth and maturation rates of different vegetables. The fact that the edible portions of the plants appear in different vertical locations also helped. Radishes, carrots, lettuce and cauliflower were grown together in one combination used by the French to take advantage of these differences.

Vertical Location of the Plant's Edible Portion—See Fast/Slow Maturing example.

Weed, Insect and Animal Relationships

"Weed" Control—The growth of beets, members of the cabbage family, and alfalfa are slowed down significantly by the presence of "weeds". To minimize the "weed" problem for sensitive plants, you can grow other plants during the previous season that discourage "weed" growth in the soil. Two such plants are kale and rape. Another example is the *Tagetes minuta*, a Mexican Marigold.⁵⁸ "In many instances it has killed even couch grass, convolvulus (wild morning glory), ground ivy, ground elder, horsetail and other persistent weeds that defy most poisons. Its lethal action works only on starch roots and had no effect on woody ones like roses, fruit bushes and shrubs. Where it had grown, the soil was enriched as well as cleansed, its texture was refined and lumps of clay

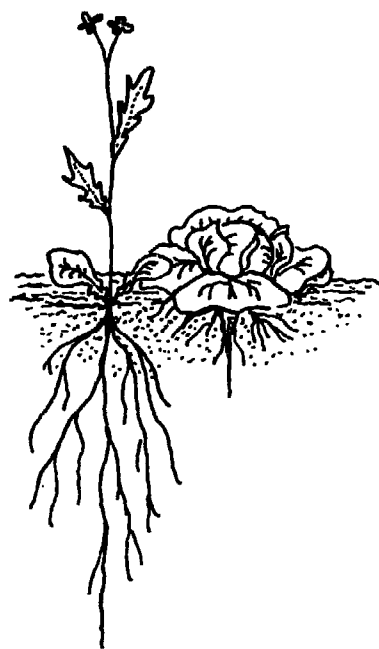

Sow thistle grown with lettuce is one example of shallow/deep rooting symbiosis.

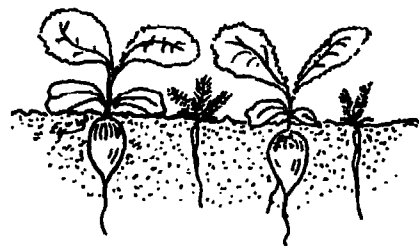

An example of using fast/slow maturing to advantage is to interplant carrots with radishes.

57. Also see Emanuel Epstein, "Roots", *Scientific American*, May, 1973, pp. 48-58.

58. Illegal in California, where it is considered a noxious weed which aggressively takes over cattle lands and prevents fodder from growing. It is probably also toxic to the cattle.

were broken up.”⁵⁹ Some care should be taken when using this marigold, however, since vegetable crops might also be killed by it and the plant does give off toxic excretions. Tests should be performed to determine how long the influence of these excretions stay with the soil. But to cleanse a soil of pernicious weeds and thereby get it ready for vegetables, *Tagetes minuta* appears to be a useful plant.

Insect/Pest Control—At least two elements are important in companion planting for insect control. Older plants with well developed aroma and essential oil accumulations should be used. You want the insects to know the plant is there. Second, it is important to use a large variety of herbs. Five different herbs help discourage the Cabbage Worm Butterfly, although one herb may work better than another in your area. Testing several herbs will help you determine the ones that work best. The more “unpleasant” plants there are in the garden, the sooner harmful insects will get the idea that your garden is not a pleasant place to eat and propagate. The use of a large number of herbs also fits in with the diversity of plant life favored by nature. Much more research needs to be performed to determine the optimum ages for control plants and number of control plants per bed which provides optimum control. Too few plants will not control an insect problem and too many may reduce your yields. Some insect controls are:

- *White flies*: Marigolds—but not Pot Marigolds (*Calendula*)—and Flowering Tobacco. The first is supposed to excrete substances from its roots which are absorbed by the other plants. When the White Flies suck on the other plants, they think they are on a strong tasting marigold and leave. The Flowering Tobacco plant has a sticky substance on the underside of its leaves, where White Flies stick and die when they come there for a meal.
- *Ants*; Spearmint, Tansy and Pennyroyal. (Mint often attracts White Flies so you may want to grow a few Marigolds around for control, but not so many as to possibly impair the taste of the mint and certainly not one of the more poisonous Marigolds. This is another area for compromise. A few insects are probably less of a problem than mint with a strange taste.)
- *Nematodes and Root Pests*—Mexican Marigold (*Tagetes minuta*) “eliminates all kinds of destructive eelworms . . . wireworms, millepedes and various root eating pests from its vicinity.” The French marigold, *Tagetes patula*, eliminates some “plant-destroying nematodes . . . at up to a range of three feet . . . The beneficial . . . eelworms which do not feed on healthy roots were not affected.”⁶⁰

59. From the book, *How to Enjoy Your Weeds*, Audrey Wynne Hatfield, 1971, by Sterling Publishing Co., Inc., New York, ©1969 by Audrey Wynne Hatfield.

60. *Ibid*, p. 17.

- *Aphids*—*Yellow Nasturtiums* are a *decoy* for Black Aphids. They may be planted at the base of tomatoes for this purpose. Remove the plants and aphids before the insects begin to produce young with wings. Spearmint, Stinging Nettle, Southernwood and Garlic help repel aphids.
- *Tomato Worms*—Borage reportedly helps repel tomato worms and/or serves as a decoy. Its blue flowers also attract bees.
- *Gophers*—Elderberry cuttings placed in gopher holes and runs reportedly repel these animals. Daffodils, castor beans, and gopher plant (*Euphorbia lathyris*) are all poisonous to gophers. Be careful with the latter two, however, as they are also *very* toxic to children, especially infants.

Birds, Bees & Animals—Sow Thistle attracts birds. Some birds are vegetarian and some are omnivorous. The omnivorous birds may stay for a main course of insects after a seed snack. If you are having trouble with birds eating the berries in your berry patch you could erect a wren house in the middle of it. Wrens are insectivores and they will not bother the berries. But they will attack any bird, however large, that comes near the nest.

Hummingbirds are attracted to red flowers. They especially like the tiny red, torch-like flowers of the Pineapple Sage in our garden. Bees may be attracted by Hyssop, Thyme, Catnip, Lemon Balm, Pot Marjoram, Sweet Basil, Summer Savory, Borage, Mint and *blue* flowers. Once in the garden they help pollinate.

Animals are good for the garden. Their manures can be used as fertilizers. Chickens are one of the few reliable controllers of earwigs, sowbugs, pill bugs, snails, grasshoppers, and maggots, though you may have to protect young seedlings from chickens pecking tasty plant morsels.

Companion planting in all its aspects can be a complex and often mind boggling exercise—if you worry too much about the details. Nature is complex and we can only assist and approximate her in our creations. If we are gentle in relation to her forces and balances, she can correct our errors and fill in for our lack of understanding. As you gain more experience, sensitivity and feeling, more companion planting details will come naturally. Don't let too much planning spoil the fun and excitement of working with nature!

Birds and plants can work together too. The *sonchus* plant seeds attract the finch which afterwards eats aphids from the cabbage.



**A LIST OF COMMON GARDEN VEGETABLES, THEIR COMPANIONS
AND THEIR ANTAGONISTS⁶¹**

	COMPANIONS	ANTAGONISTS
Asparagus	Tomatoes, parsley, basil	
Beans	Potatoes, carrots, cucumbers, cauliflower, cabbage, summer savory, most other vegetables and herbs	Onions, garlic, gladiolus
Bush Beans	Potatoes, cucumbers, corn strawberries, celery, summer savory	Onions
Pole Beans	Corn, summer savory	Onions, beets, kohlrabi, sunflowers
Beets	Onions, kohlrabi	Pole Beans
Cabbage Family (Cabbage, cauliflower, kale, kohlrabi, broccoli)	Aromatic plants, potatoes celery, dill, camomile, sage, peppermint, rosemary, beets, onions	Strawberries, tomatoes, pole beans
Carrots	Peas, leaf lettuce, chives, onions, leeks, rosemary, sage, tomatoes	Dill
Celery	Leeks, tomatoes, bush beans cauliflower, cabbage	
Chives	Carrots	Peas, beans
Corn	Potatoes, peas, beans cucumbers, pumpkins, squash	
Cucumbers	Beans, corn, peas, radishes, sunflowers	Potatoes, aromatic herbs
Eggplant	Beans	
Leeks	Onions, celery, carrots	
Lettuce	Carrots and radishes (lettuce, carrots and radishes make a strong team grown together), strawberries, cucumbers	
Onions (and garlic)	Beets, strawberries, tomatoes, lettuce, summer savory, camomile (sparsely)	Peas, beans

61. From *Organic Gardening and Farming*, February, 1972, p. 54.

	COMPANIONS	ANTAGONISTS
Parsley	Tomatoes, asparagus	
Peas	Carrots, turnips, radishes, cucumbers, corn, beans, most vegetables and herbs	Onions, garlic, gladiolus, potatoes
Potatoes	Beans, corn, cabbage, horseradish (should be planted at corners of patch), marigold, eggplant (as a lure for Colorado potato beetle)	Pumpkins, squash, cucumbers, sunflowers, tomatoes, raspberries
Pumpkins	Corn	Potatoes
Radishes	Peas, nasturtiums, lettuce, cucumbers	
Soybeans	Grows with anything, helps everything	
Spinach	Strawberries	
Squash	Nasturtiums, corn	
Strawberries	Bush beans, spinach, borage, lettuce (as a border)	Cabbage
Sunflowers	Cucumbers	Potatoes
Tomatoes	Chives, onions, parsley, asparagus, marigolds, nasturtiums, carrots	Kohlrabi, potatoes, fennel, cabbage
Turnips	Peas	

A COMPANIONATE HERBAL FOR THE ORGANIC GARDEN⁶²

A list of herbs, their companions, their uses, including some beneficial weeds and flowers.

Basil	Companion to tomatoes, dislikes rue intensely. Improves growth and flavor. Repels flies and mosquitoes.
Beebalm	Companion to tomatoes; improves growth and flavor.
Borage	Companion to tomatoes, squash and strawberries; deters tomato worm; improves growth and flavor.
Caraway	Plant here and there; loosens soil.

62. From *Organic Gardening and Farming*, February, 1972, pp. 52 and 53.

Catnip	Plant in borders; deters flea beetle.
Camomile	Companion to cabbage and onions; improves growth and flavor.
Chervil	Companion to radishes; improves growth and flavor.
Chives	Companion to carrots; improves growth and flavor.
“Dead” Nettle	Companion to potatoes; deters potato bug; improves growth and flavor.
Dill	Companion to cabbage; dislikes carrots; improves growth and health of cabbage.
Fennel	Plant away from gardens. Most plants dislike it.
Flax	Companion to carrots, potatoes; deters potato bug, improves growth and flavor.
Garlic	Plant near roses and raspberries; deters Japanese beetles; improves growth and health.
Horseradish	Plant at corners of potato patch to deter potato bug.
Henbit	General insect repellent.
Hyssop	Deters cabbage moth; companion to cabbage and grapes. Keep away from radishes.
Lamb’s Quarters	This edible weed should be allowed to grow in moderate amounts in the garden, especially in corn.
Lemon Balm	Sprinkle throughout garden.
Lovage	Improves flavor and health of plants if planted here and there.
Marigolds	The workhorse of the pest deterrents. Plant throughout garden; it discourages Mexican bean beetles, nematodes and other insects.
Mint	Companion to cabbage and tomatoes; improves health and flavor; deters white cabbage moth.
Marjoram	Here and there in garden; improves flavors.
Mole Plant	Deters moles and mice if planted here and there.
Nasturtium	Companion to radishes, cabbage and cucurbits*; plant under fruit trees. Deters aphids, squash bugs, striped pumpkin beetles. Improves growth and flavor.
Petunia	Protects beans.

Pot Marigold (Calendula)	Companion to tomatoes, but plant elsewhere in garden too. Deters asparagus beetle, tomato worm and general garden pests.
Purslane	This edible weed makes good ground cover in the corn.
Pigweed	One of the best weeds for pumping nutrients from the subsoil, it is good for potatoes, onions and corn. Keep weeds thinned.
Peppermint	Planted among cabbages, it repels the white cabbage butterfly.
Rosemary	Companion to cabbage, beans carrots and sage; deters cabbage moth, bean beetles and carrot fly.
Rue	Keep it far away from Sweet Basil; plant near roses and raspberries; deters Japanese beetle.
Sage	Plant with rosemary, cabbage and carrots; keep away from cucumbers. Deters cabbage moth, carrot fly.
Southernwood	Plant here and there in garden; companion to cabbage, improves growth and flavor; deters cabbage moth.
Sowthistle	This weed in moderate amounts can help tomatoes, onions and corn.
Summer Savory	Plant with beans and onions; improves growth and flavor. Deters bean beetles.
Tansy	Plant under fruit trees; companion to roses and raspberries. Deters flying insects, Japanese beetles, striped cucumber beetles, squash bugs, ants.
Tarragon	Good throughout garden.
Thyme	Here and there in garden. It deters cabbage worm.
Valerian	Good anywhere in garden.
Wild Morning Glory**	Allow it to grow in corn.
Wormwood	As a border, it keeps animals from the garden.
Yarrow	Plant along borders, paths, near aromatic herbs; enhances essential oil production.

*Plants in the gourd family.

**We discourage the growing of wild morning glory anywhere in your garden, since it is a pernicious weed. Cultured morning glory is fine, however.

This information was collected from many sources, most notably the Bio-Dynamic Association and the herb Society of America.

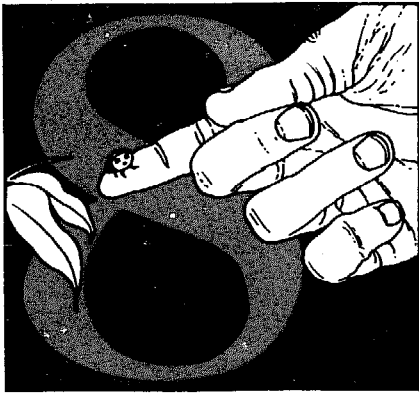

A Balanced Natural Backyard Ecosystem and Insect Life

Insects and people are only one part of the complex, inter-related world of life. Both are important, integral parts of its living dynamism. Insects are an important part of the diet for many birds, toads, frogs and other insects in nature's complex food chain. With the biodynamic/French intensive method comes a realization that every time you relate to an insect you are relating with the whole system of life, and that, if you choose to dominate the insect world system of life, rather than work in harmony with it, part of the system dies. For example, we depend on insects for pollination of many of our vegetables, fruits, flowers, herbs, fibers and cover crops. When we choose dominating, death-oriented control, then the scope and depth of our life becomes narrower and smaller. So, in reality, we are detracting from our own lives rather than adding to them. In trying to isolate an insect and deal with it separately out of relation to the ecosystem in which it lives, we work against the whole life support system, which in turn works against us in counterproductive results.

When an excess of insects appears in a garden, nature is indicating a problem exists in the life of that garden. In each case, we need to become sensitive to the source of the imbalance. Observation and gentle action will produce the best results. In contrast, when poisons are used, beneficial predators are killed as well as the targeted harmful insects. Spraying trees to eliminate worms or beetles often results in a secondary outbreak of spider mites or aphids because ladybugs and other predators cannot reestablish themselves as quickly as the destructive species.

Paying attention to the soil and plant health, planning a varied environment, and leaving a few wild spaces for unexpected benefactors minimizes pest losses more effectively

than the use of poisons. Also, in order to have beneficial insects in your food producing area, there must be their food—some of the harmful ones! If there are no harmful insects, then there will be few, if any, beneficial insects ready to act as a seed population of friendly guardians. This seeming paradox—the presences of both kinds of insects for the most healthy garden—is symbolic of nature's balances. Not too much moisture, but enough. Not too much aeration, but enough. Not too many harmful insects, but enough. You find the need for these balances everywhere—in the compost pile, in the soil, in the mini-climate, and in the backyard microcosm as a whole.

In a small backyard garden ecosystem or mini-farm it is especially important to welcome all life forms as much as possible. Ants destroy fruitfly and housefly larvae and keep the garden cleaned of rotting debris. Have you ever squashed a snail and watched how the ants come to whisk the remains away almost within a day? Earwigs are carnivorous and prey on other insects. Tachinid flies parasitize caterpillars, earwigs, tomato worms, and grasshoppers by laying their eggs in them. We've found cabbage worms immobilized and bristling with cottony white torpedoed the size of a pinhead—larvae of the braconid wasp which will hatch and go in search of more cabbage worms. Toads eat earwigs, slugs and other pests. Chickens control earwigs, sowbugs and flies. Even the ancient, but fascinating, snails have a natural predator: humans!

The first step in insect control is to cultivate strong vigorous plants by cultivating a healthy place in which they can grow. Normally (about 90% of the time), insects only attack unhealthy plants. Just as a healthy person who eats good food is less susceptible to disease, so are healthy plants that are on a good diet less susceptible to plant diseases and insect attack. It is *not* the insect which is the source of the problem, but rather an unhealthy soil. The soil needs your energy, not the insect. The uninterrupted growth stressed by the biodynamic/French intensive method is also important to the the maintenance of plant health. In short, we are shepherds providing the conditions our plants need for healthy, vigorous growth.

Some elements to consider:

- is the soil being dug properly?
- are the proper plant nutriment available in the soil?
- is enough compost being used?
- is the soil pH within reasonable limits for the plant being grown?
- are the seedlings being transplanted properly?

- are the plants being watered properly?
- is weeding being done effectively?
- is the soil being maintained in a way which will enable it to retain moisture and nutriment?
- are the plants receiving enough sun?
- are the plants being grown in season?

Another method of providing for plant health and for minimizing insect and disease problems is to keep a correct balance of phosphorus and potash in the soil in relation to the amount of nitrogen present. (See page 30.) The optimal ratio among these elements is still to be determined. Research also needs to be completed to determine the *minimum* amounts of these elements (in pounds per 100 square feet) which should be in the soil. (Smaller amounts of organic fertilizer elements are required in comparison with soluble synthetic chemical fertilizers, since they break down more slowly and remain available to the plants for a longer period of time.)

Proper planning of the garden can eliminate many insect and disease problems!

- Use seeds which grow well in your climate and soil.
- Use plant varieties which are weather hardy, insect resistant, and disease resistant. New strains, especially hybrids (whether developed for higher yields, disease resistance or other reasons) should usually be avoided. Some hybrids produce food of lower nutritive value in comparison with older strains, and often use up nutriment from the soil at a more rapid rate than a living soil can sustain over time. Hybrids are also often very susceptible to a few diseases even when they are greatly resistant to many prevalent ones.
- Companion plant: grow vegetables and flowers together that grow well with each other.
- Normally, do not put the same vegetable in the same growing bed each year. This practice invites disease.
- Rotate your crops: follow heavy feeders with heavy givers and then light feeders.

Encourage natural insect control by enlisting the aid of nature:⁶³

Birds—some are vegetarians. Others are omnivorous. A bird which stops for a seed snack may remain for an insect dinner. A house wren feeds 500 spiders and caterpillars to her

63. Beatrice Trum Hunter, *Gardening Without Poisons*, Berkeley Publishing Corp., New York, 1971, pp. 31, 37, 42, 43, 48. The Berkeley Edition was published by arrangement with the Houghton Mifflin Company, who are the original publishers of *Gardening Without Poisons*.

young in one afternoon, a brown thrasher consumes 6,000 insects a day, a chickadee eats 138,000 canker worm eggs in 25 days and a pair of flickers eat 5,000 ants as a snack. A Baltimore Oriole can consume 17 hairy caterpillars a minute. The presence of birds may be encouraged by the use of moving water, the planting of bushes for their protection, the planting of sour berry bushes for food and the growing of plants that have seeds the birds like to eat.

Toads, Snakes and Spiders—also eat insects and other garden pests. Toads eat as many as 10,000 insects in three months including cutworms, slugs, crickets, ants, caterpillars and squash bugs.

Lady Bugs—are good predators since they eat one particular pest, aphids, and do not eat beneficial insects. Ladybugs eat 40–50 insects per day and their larvae eat even more.

Praying Mantids—are predators which should only be used in infestation emergencies, since they eat beneficial as well as harmful insects. They are not selective and even eat each other.

Trichogramma Wasps—lay their eggs in hosts such as moth and butterfly larvae which eat leaves. When they hatch, the wasp larvae parasitize the host larvae, which fail to reach maturity. Up to 98 percent of the hosts are rendered useless in this way.

Trachinid Flies—are parasites which help control caterpillars, Japanese beetles, earwigs, gypsy moths, brown tail moths, tomato worms and grasshoppers.

Syrphid Flies—are parasites that prey upon aphids and help pollinate crops.

After you have done everything possible to provide a healthy, balanced garden for your plants, you may still have insect problems. If so, you should approach the insects involved with the idea of *living control* rather than elimination. Minimization of the pest allows dynamic living control to occur: beneficial predators need the harmful insects as a food source. Total elimination of the insect would disrupt nature's balances.

If there is a problem, identify the pest and try to determine if an *environmental change* can solve the problem. In our research garden, we have minimized (not eliminated though!) gophers by introducing gopher snakes.

The pocket Golden Guides on *Insects and Insect Pests* are invaluable guides for getting to know the creatures that inhabit your garden with you. Out of the 86,000 species of insect in the United States, 76,000 are considered beneficial or friendly.⁶⁴ So be careful! An insect which looks ugly or mali-

⁶⁴ *Ibid.*, p. 28.

cious may be a friend. If you can't seem to find an obvious culprit, try exploring at night with a flashlight. Many are active then.

Ask yourself if the *damage is extensive* enough to warrant a "policing" effort. During 1972 bush beans were grown in one of our test beds. The primary leaves were almost entirely destroyed by the 12-spotted cucumber beetle. But in most cases the damage was not so rapid as to prevent the development of healthy secondary leaves. The less tender secondary leaves were ultimately attacked and became quite heavily eaten. About 80 percent of the secondary leaf area remained, however, and very tasty, unblemished beans were harvested. The yield in pounds was still 3.9 times the United States average! Recent tests have shown that leaf damage of up to 30% by insects can actually increase the yield of some crops. At another extreme you may wish to sacrifice some yield for beauty: many destructive caterpillars become beautiful butterflies. To get the yield you want and/or to encourage the presence of butterflies, you can plant extra plants of the crop they like.

We often underestimate the ability of plants to take care of themselves. The damage done by insects is often a very small percentage of the edible crop. Because of this, many biodynamic gardeners plant a little extra for the insect world to eat. This practice is beautiful, mellow and in keeping with life-giving forms of insect control. Furthermore, extensive research has shown that beneficial organisms found in soil and ocean environments can withstand stress, in the form of temperature, pressure, pH and nutriment fluctuations, to a much greater degree in an organically fertilized medium than in a synthetically fertilized medium. I suspect researchers will come to a similar conclusion about plant resistance to insect attack.

Any time an insect or other pest invades your garden, there is an opportunity to learn more about nature's cycles and balances. Learn why they are there and find a *living control*. Look for controls that will affect only the one harmful insect. Protect new seedlings from birds and squirrels with netting or chickenwire, trap earwigs in dry dark places, wash aphids off with a strong spray of water, or block ants with a sticky barrier of vaseline, tanglefoot or tack trap. While you are doing this, continue to strive for a long-term natural balance in your growing area.

At our Common Ground Research Garden the only three pest problems we have had to put a lot of energy into are snails, slugs and gophers. The first few years we primarily trapped gophers. A lot of time was spent checking and resetting traps and worrying about them, yet the damage they did was probably only about 5%. We later found that in addition to gopher snakes they really do not like certain things placed

in their holes (sardines, garlic juice, fish heads, male urine, and dead gophers). Here a combination of approaches and gentle persistence has paid off. Gopher snakes are, of course, the preventers of a population explosion. Finally, gophers may be blocked with strips of daffodils. Daffodils contain arsenic in their bulbs and thereby can discourage these animals.

We have a simple routine for snails and slugs. At the end of the spring rains we go out at night with flashlights and collect gallons of them. The snails are then dropped in buckets of soapy water which will kill them. If you use soap that is quick to degrade, they can be dumped on the compost pile the next day. Most of them are caught in the first three nights. Going out occasionally over the next two weeks catches new ones that were too small in the first sweep or which have just hatched from eggs laid in the soil. Such a concentrated clean-up can be effective for several months. There is also the red-bellied snake (*Storeria occipitomaculata*) in Canada, which eats large numbers of slugs.

Another kind of problem has been solved through observation. For example, one year a cherry tomato bed was wilting. Several people, including a graduate student studying insects, told us it was caused by nematodes. When we dug down into the soil to look for the damage, we discovered the real source. The soil was bone dry below the upper eight inches. A good soaking took care of the problem and we learned not to take gardening advice on faith, but to always check it out for ourselves—as we hope you will.

Some other living control approaches to try are:

Hand-picking the insects from the plants once you are certain the insect involved is *harmful* and the source of the problem. Consult a book, such as *Insect Pests* (see Bibliography), which has color drawings of insects in their several stages (nymph, larva, adult). Some insects are harmful in only one stage and can even be beneficial in others.

Spraying. In general, insects may be divided into two categories—those which chew and bite plants and those which suck juices from them. *Chewing or biting insects*, include caterpillars, flea beetles, potato bugs, cankerworms, cutworms, and grasshoppers. *Aromatic and distasteful* substances such as garlic, onion and pepper sprays can discourage them. *Sucking Insects* include aphids, thrips, nymphs of the squash bug, flies and scale insects. Soap solutions (not detergents which would damage the plant and soil as well as the insects), clear miscible oil solutions and other solutions which asphyxiate the insects by coating their tender bodies and preventing respiration through body spiracles or breathing holes, help control these insects.



Traps, such as shredded newspaper in clay pots turned upside down on sticks in the garden, will attract earwigs during daylight hours. Snails and slugs can be trapped under damp boards. They retreat to these places in the heat and light of the day.

Barriers, such as the sticky commercial Tanglefoot substance, will catch some insects crawling along tree trunks during part of their life cycle. When insects are caught in this manner, infestation of the tree in a later season is often prevented. (Tanglefoot barriers must be applied to apple tree trunks in July to catch codling moth larvae leaving the tree. This will minimize codling moth infestation the following spring. Plan ahead!) Plant barriers and decoys can also be used. Grow a vegetable or flower preferred by a particular insect away from the garden to attract it to another location. Place repellent plants near a vegetable or flower that needs protection.

Companion Plants. You may also wish to plant some herbs in your beds for insect control. The age and number of plants used per 100 square feet determine the herb's effectiveness. A young plant does not have an aroma or root exudate strong enough to discourage harmful insects or to attract beneficial ones. Similarly, too few herbs will not control a pest or attract a needed predator. Too many herbs may retard vegetable growth and yield. Composite flowers, such as Pot Marigolds (Calendulas) and Sunflowers are excellent attractants for predatory insects because their large supplies of pollen serve as predator food sources. A few (2-4) plants per 100 square foot bed will probably suffice. We have not done many experiments with them yet, however, since accurate testing can take two to three years for one herb grown with one food plant to control one insect. This requires more time and funding than we have. You may wish to try some of these biodynamic observations though. It's a lot of fun to try and see for yourself!

Probably the most important form of insect control with plants is just diverse cropping. The biodynamic/French intensive method uses diverse cropping and we have only experienced 5 to 10 percent crop loss due to pests when we are performing "the method" properly. Biodynamic gardeners and farmers also use diverse cropping and have suggested that one plant 10 percent more area to make up for crop losses. In contrast, the monocropped acreage of today's commercial agriculture provides an ideal uniform habitat for widespread attack by pests which favor a single crop. Pesticides have been recommended to counteract the problem inherent in monocropping. Yet, the Environmental Protection Agency estimates "that thirty years ago American farmers used 50 million pounds of pesticides and lost 7 percent of



INSECT PESTS AND PLANT CONTROLS⁶⁵

Insect Pest	Plant Control
Ants	— Spearmint, Tansy, Pennyroyal
Aphids	— Nasturtium, Spearmint, Stinging Nettle, Southernwood, Garlic
Mexican Bean Beetle	— Potatoes
Black Fly	— Intercropping, Stinging Nettle
Cabbage Worm Butterfly	— Sage, Rosemary, Hyssop, Thyme, Mint, Wormwood, Southernwood
Striped Cucumber Beetle	— Radish
Cutworm	— Oak leaf mulch, Tanbark
Black Flea Beetle	— Wormwood, Mint
Flies	— Nut Trees, Rue, Tansy, spray of Wormwood and/or Tomato
June Bug Grub	— Oak leaf mulch, Tanbark
Japanese Beetle	— White Geranium, Datura
Plant Lice	— Castor Bean, Sassafras, Pennyroyal
Mosquito	— Legumes
Malaria Mosquito	— Wormwood, Southernwood, Rosemary
Moths	— Sage, Santolina, Lavender, Mint, Stinging Nettle, Herbs
Colorado Potato Beetle	— Eggplant, Flax, Green Beans
Potato Bugs	— Flax, Eggplant
Slugs	— Oak leaf mulch, Tanbark
Squash Bugs	— Nasturtium
Weevils	— Garlic
Woolly Aphis	— Nasturtium
Worms in Goats	— Carrots
Worms in Horses	— Tansy leaves, Mulberry leaves

their crop before harvest. Today, farmers use twelve times more pesticides yet the percentage of the crops lost before harvest has almost doubled."⁶⁶ In fact, many pesticides targeted for one pest species actually cause increases in the numbers of non-targeted pests. By their action on the physiology of the plant, pesticides can make a plant more nutritionally favorable to insects, thereby increasing the fertility and longevity of feeding pests.⁶⁷

65. Helen Philbrick and Richard B. Gregg, *Companion Plants and How to Use Them*, The Devin-Adair Company, Old Greenwich, Connecticut, 1966, pp. 52-53. This book and others should be consulted for the proper use and application rates of these plant remedies. Improper use or application can cause problems and could be harmful to you, your plants and animals.

66. See James S. Turner, *A Chemical Feast: Report on the Food and Drug Administration* (Ralph Nader Study Group Reports) New York: Grossman, 1970 cited in *Food First*, by Frances Moore Lappe and Joseph Collins, Boston: Houghton Mifflin Company, 1977, p. 49.

67. Francis Chaboussou, "The Role of Potassium and of Cation Equilibrium in the Resistance of the Plant," Chaboussou is the Director of Research at the French National Institute for Agricultural Research, Agricultural Zoology Station of the South-West, 22 PONT DE LA MAYE, FRANCE.



It is becoming more evident that pesticides are not an effective solution for crop loss due to pests. It seems that *diverse* cropping without pesticides may be able to reduce total pest losses more than monocropping with pesticides, even in large-scale agriculture. Using standard agricultural practices, Cornell University Researchers, in a five-year study completed in 1970, found that without pesticides the insect population could be cut in half when only two crops were grown together.⁶⁸ You will make this, and even more, possible when you grow a diversity of plants in your backyard with life-giving techniques!

Only a brief introduction to insect control has been given here. An emphasis has been placed on philosophy and general approaches. *The Bug Book*, *Companion Plants* and *Gardening Without Poisons* (see Bibliography) have already vigorously explored in detail the spectrum of organic insect control. These books give companion planting combinations, recipes for insect control solutions, and addresses from which predatory insects can be obtained.

I hope each person who reads this book will try at least one small, 3 foot by 3 foot biodynamic/French intensive growing bed. You should find the experience fun and exciting beyond your wildest expectations!

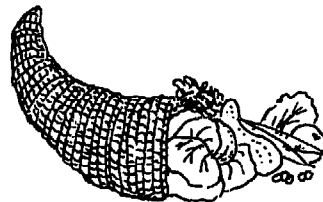

68. See Jeff Cox, "The Technique That Halves Your Insect Population", *Organic Gardening and Farming*, May, 1973, pp. 103-104.

Bibliography

Books marked with an asterisk (*) may be mail-ordered from Ecology Action, 2225 El Camino Real, Palo Alto, CA 94306. Write for current prices and to inquire about other titles. Ecology Action publishes several research papers on the biodynamic/French intensive method and has books, booklets, and information on beekeeping, mini-farming, homesteading, and related topics. Use the books listed here to make up your own mini-course(s) for study of those areas which interest you most.

Animals

- Bement, C.U. *The American Poultryer's Companion*. New York: Harper & Brothers, 1871. 304 pp.
- Craig, John A. and Marshall, F.R. *Sheep Farming*. New York: Macmillan.
- Cuthbertson, Sir David (Chairman). *The Nutrient Requirements of Farm Livestock—No. 2 Ruminants*. London: Agricultural Research Council, 1965. 264 pp.
- de Bairaacle Levi, Juliette. *Herbal Handbook for Farm and Stable*. London: Faber & Faber, 1973. 320 pp.
- Devenóra, C., and Burns, Marca. *Goat Production in the Tropics*. Commonwealth Agricultural Bureaux, Farnham Royal, Bucks, England, 1970. 177 pp.
- Jordan, Whitman, H. *The Feeding of Animals*. New York: Macmillan, 1903. 450 pp.
- McKay, G.L., and Larsen, C. *Principles and Practice of Butter-Making*. New York: John Wiley & Sons, 1908. 351 pp.
- Mackenzie, David. *Goat Husbandry*. London: Faber & Faber, 1970. 336 pp.
- Morrison, Frank B. *Feeds and Feeding*. (21st edition.) Ithaca, NY: Morrison Publishing, 1949. 1,207 pp.
- Watson, George C. *Farm Poultry*. New York: Macmillan.

Bed Preparation

- Sunset, "Getting Started with the French Intensive Method." September, 1972, p. 168.

Companion Planting

- *Cocannouer, Joseph A. *Weeds: Guardians of the Soil*. New York: Devin-Adair, 1948. 179 pp. How weeds help your garden.
- Crowhurst, Adrienne. *The Weed Cookbook*. New York: Lancer Books, 1973. 198 pp.
- *de Bairaacle Levi, Juliette. *The Herbal Handbook for Farm and Stable*. Emmaus, PA: Rodale Press, 1976. 320 pp.
- Epstein, Emanuel. "Roots." *Scientific American*, May 1973, pp. 48-58.
- Gregg, Evelyn S. *Herb Chart*. Biodynamic Farming and Gardening Association, Wyoming, Rhode Island. Detailed cultural notes.
- *Hatfield, Audrey W. *How to Enjoy Your Weeds*. New York: Sterling, 1971. 192 pp. Delightful. Includes an herbal lawn, flower salads and other charming ideas.
- Howes, F.N. *Plants and Beekeeping*. London: Faber & Faber, 1945. 224 pp.
- *Hylton, William H. (ed.). *The Rodale Herb Book*. Emmaus, PA: Rodale Press, 1974. 653 pp.
- Maeterlinck, Maurice. *The Life of the Bee*. New York: Dodd, Mead & Co., 1916. 427 pp.

- *Martin, Alexander C. *Weeds*. New York: Golden Press. 160 pp. Inexpensive identification guide.
- Muenschler, Walter C., and Hyypio, Peter A. *Weeds*. Ithaca, NY: Cornell University Press, 1980. 586 pp.
- Newman, L. Hugh. *Create a Butterfly Garden*. World's Work Ltd. (Kingswood, Fodworth, Surrey, England), 1969. 115 pp.
- *Philbrick, Helen, and Gregg, Richard B. *Companion Plants and How to Use Them*. Old Greenwich, CT: Devin-Adair, 1966. 113 pp.
- Pfeiffer, Ehrenfried. *Sensitive Crystallization Processes*. Spring Valley, NY: Anthroposophic Press, 1936. 59 pp.
- *_____. *Weeds and What They Tell*. Wyoming, RI: Biodynamic Farming and Gardening Association, 1970. 96 pp. Reading soil conditions by the weeds.
- Sunset Editors. *Attracting Birds to Your Garden*. Menlo Park, CA: Sunset-Lane, 1974. 96 pp.
- *_____. *How to Grow Herbs*. Menlo Park, CA: Sunset-Lane, 1974. 80 pp.
- *Tomkins, Peter. *The Secret Life of Plants*. New York: Harper & Row, 1972. 402 pp. Fascinating.
- Tomkins, Peter, and Bird, Christopher. "Love Among the Cabbages." *Harper's*, November 1972, pp. 90ff.

- *Watts, Mag T. *Reading the Landscape of America*. New York: Collin Books, 1975. 354 pp.
- Weaver, John E. *Prairie Plants and Their Environment*. Lincoln, NE: University of Nebraska Press, 1968. 276 pp.
- _____. *Root Development of Field Crops*. New York: McGraw-Hill, 1926. 291 pp.
- _____. *Root Development of Vegetable Crops*. New York, McGraw-Hill, 1927. 351 pp. Excellent diagrams of root systems.
- White, John T. *Hedgerow*. New York: William Morrow & Co., 1980. 46 pp.
- Wilson, Charles M. *Roots: Miracles Below*. New York: Doubleday, 1968. 234 pp.

Composting

- Alther, Richard, and Raymond, Richard O. *Improving Garden Soil with Green Manures*. Charlotte, VT: Garden Way Publishing, 1974. 44 pp. Contains good 2-page chart.
- * *Composting for the Tropics*. Bocking, England: Henry Doubleday Research Association, 1963. 28 pp. Useful pamphlet for humid areas.
- Cox, Jeff. "What You Should Know About Nitrogen." *Organic Gardening and Farming*. June 1972, pp. 69-74. See also insert on page 68.
- Denison, William C. "Life in Tall Trees." *Scientific American*, June, 1973, pp. 75-80.
- *Golueke, Clarence G. *Composting: A Study of the Process and Its Principles*. Emmaus, PA: Rodale Press, 1972. 110 pp. For those with an advanced interest.
- Hodges, R.D. (ed.). *Composting in Tropical Agriculture*. Ipswich, England: International Institute of Biological Husbandry, 1979. 32 pp.
- *Koepf, H.H. *Compost*. Wyoming, RI: Biodynamic Farming and Gardening Association, 1966. 18 pp. Short, detailed pamphlet.
- McGarey, Michael G., and Stainforth, Jill (eds.). *Compost, Fertilizer, and Biogas Production from Human and Farm Wastes in the People's Republic of China*. Ottawa, Canada: International

- Development Research Centre, 1978. 94 pp.
- Minnich, Jerry, et al. *The Rodale Guide to Composting*. Emmaus, PA: Rodale Press, 1979. 405 pp.
- Raabe, Robert D. *The Rapid Composting Method*. Berkeley, CA: California Cooperative Extension Service, 1981. 4 pp.
- Soucie, Gary. "How You Gonna Keep It Down on The Farm." *Audubon*, September 1972, pp. 112-115.
- *Van Der Ryn, Sim. *The Toilet Papers*. Santa Barbara, CA: Capra Press, 1978. 124 pp.

Cover/Fodder/Organic Matter Crops

- Coburn, F.D. *The Book of Alfalfa*. New York: Orange Judd Co., 1907. 344 pp.
- Hills, Lawrence D. *Comfrey*. New York: Universe Books, 1976. 253 pp.
- Hitchcock, A.S. *Manual of the Grasses of the United States*. Washington, DC: U.S. Dept. of Agriculture, Government Printing Office, 1935. 1,040 pp.
- Hodgson, Harlow J. "Forage Crops." *Scientific American*, February 1976, pp. 60-75.
- Hunter, Peter J.P. *Hunter's Guide to Grasses, Clovers, and Weeds*. Chester, England: James Hunter Ltd.
- Lewis, Rebecca, et al. *Making Pastures Produce*. Emmaus, PA: Rodale, 1980. 43 pp.
- Piper, Charles V. *Forage Plants and Their Culture*. New York: Macmillan, 1924. 671 pp.
- Shaw, Thomas. *Clovers and How to Grow Them*. New York: Orange Judd, 1922. 349 pp.
- _____. *Grasses and How to Grow Them*.
- Shurtleff, William, and Aoyagi, Akiko. *Kudzu*. Autumn Press (7 Littell Road, Brookline, MA 02146), 1977. 102 pp.
- Staten, Hi W. *Grasses and Grassland Farming*. New York: Devin-Adair, 1958. 319 pp.
- United States Department of Agriculture. *Grass—The Yearbook of Agriculture 1948*. Washington, DC: US Government Printing Office, 1948. 892 pp.
- Voisin, Andre. *Better Grassland Sward*. Crosby Lockwood &

Son Ltd. (26 Old Brompton Road, London SW7, England), 1960. 341 pp. A unique approach to greatly increased fodder production.

_____. *Grass Productivity*. Philosophical Library (15 East 40th Street, New York, NY 10016), 1959. 353 pp.

Experiences

- Bromfield, Louis. *Malabar Farm*. New York: Ballantine Books, 1970. 470 pp.
- Brown, Lester R. *The Twenty-Ninth Day*. New York: W.W. Norton, 1978. 363 pp.
- Burns, Scott. *The Household Economy*. Boston: Beacon Press, 1974.
- Dorf, P. *Liberty Hyde Bailey: An Informal Biography*. Ithaca, NY: Cornell University Press, 1956. 257 pp.
- Faulkner, Edward H. *Plowman's Folly*. Norman, OK: University of Oklahoma Press, 1943. 155 pp.
- King, F.H. *Farmers of Forty Centuries*. Emmaus, PA: Rodale Press, 1972. 441 pp.
- McRobie, George. *Small Is Possible*. New York: Harper & Row, 1980.
- Nearing, Helen, and Nearing, Scott. *Continuing the Good Life*. New York: Schocken Books, 1979. 194 pp.
- *_____. *Living the Good Life*. New York: Schocken Books, 1970. 213 pp.
- Rifkin, Jeremy. *Entropy*. New York: Bantam Books, 1981. 302 pp.
- *Schumacher, E.F. *Small Is Beautiful*. New York: Harper & Row, 1973. 305 pp.
- _____. *Good Work*. New York: Harper & Row, 1979. 223 pp.
- *Seshadri, C.V. *Biodynamic Gardening: Monograph Series on Engineering of Photosynthetic Systems, Vol. 4*. Shri AMM Murugappa Chettier Research Centre (Tharamani, Madras, India), 1980. 38 pp.
- Seymour, John. *I'm a Stranger Here Myself*. London: Faber & Faber, 1978. 140 pp. Absorbing personal account.
- Smith, Marney. *Growing Your Own Food*. Save the Children Federation (48 Wilton Road, Westport, CT 06880), 1980. 35 pp.

- Teale, Edwin Way (ed.). *The Wilderness World of John Muir*. Boston: Houghton Mifflin, 1964. 332 pp.
- Thomas, William L, Jr. *Man's Role in Changing the Face of the Earth—Volumes 1 & 2*. Chicago: University of Chicago Press, 1956. 1,193 pp.
- Wells, Kenneth McNeil. *The Owl Pen Reader*. New York: Doubleday, 1969. 445 pp.
- Zwinger, Ann. *Beyond the Aspen Grove*. New York: Random House, 1970. 368 pp.

Films and Video Tapes

- Bullfrog Films, Dept. F., Oley, PA 19547. Good selection of films on food, farming, and land use—including "Gardensong," a PBS special on Alan Chadwick and the biodynamic/French Intensive method. Send 2 stamps for catalog.
- National Video Portrait Library, 1869 Kirby Rd., McLean, VA 22101. 55 minute, B&W, 3/4" video cassette of a spontaneous philosophical interview with the late Alan Chadwick. Send 2 stamps when inquiring.

Flowers

- Anderson, E.B., et al. *The Oxford Book of Garden Flowers*. New York: Oxford University Press, 1963. 207 pp.
- Blamey, Marjorie. *Flowers of the Countryside*. New York: William Morrow, 1980. 224 pp.
- Crockett, James U. *Crockett's Flower Garden*. New York: Little, Brown, 1981. 311 pp.
- Crowhurst, Adrienne. *The Flower Cookbook*. New York: Lancer Books, 1973. 198 pp.
- *Foster, Catharine O. *Organic Flower Gardening*. Emmaus, PA: Rodale Press, 1975. 305 pp. Excellent!
- Hatfield, Audrey W. *Flowers to Know and Grow*. New York: Scribner's, 1950. 174 pp.
- Huxley, Anthony (ed.). *Garden Annuals and Bulbs*. New York: Macmillan, 1971. 208 pp.
- _____. *Garden Perennials and Water Plants*. New York: Macmillan, 1971. 216 pp.
- *Kasperski, Victoria R. *How to Make Cut Flowers Last*. New

- York: William Morrow, 1975. 191 pp.
- Kramer, Jack. *The Old-Fashioned Cutting Garden*. New York: Macmillan, 1979. 160 pp.
- MacNicol, Mary. *Flower Cookery*. New York: Collier Books, 1967. 262 pp.
- Squires, M. *The Art of Drying Plants and Flowers*. New York: Bonanza, 1958. 258 pp.
- Sunset Editors. *Garden Colors: Annuals and Perennials*. Menlo Park, CA: Sunset-Lane, 1981. 96 pp.
- White, Edward A. *The Principles of Floriculture*. New York: Macmillan, 1931. 467 pp.
- Wilder, Louise B. *The Fragrant Garden*. New York: Dover, 1974. 407 pp.

Food & Nutrition

- Agricultural Research Service, US Department of Agriculture, *Composition of Foods*. Agriculture Handbook No. 8. Washington, DC: US Government Printing Office, 1963. 190 pp.
- Board of Directors. "Position Paper on the Vegetarian Approach to Eating." *The American Dietetic Association Reports*, July 1980, pp. 61-69.
- Brown, Edward E. *The Tassajara Bread Book*. Boulder, CO: Shambhala Publications, 1971. 145 pp.
- Gussow, John. *The Feeding Web*. Palo Alto, CA: Bull Publishing, 1978. 457 pp.
- Ford Heritage. *Composition and Facts About Foods*. Health Research (70 Lafayette Street, Mokelumne Hill, CA 95245), 1971. 121 pp.
- Church, Charles F., and Church, Helen W. *Food Values of Portions Commonly Used*. Philadelphia: Lippincott, 1970. 180 pp.
- *Hertzberg, Ruth, et al. *Putting Food By*. New York: Bantam Books, 1973. 565 pp.
- Hewitt, Jean. *The New York Times Natural Foods Cookbook*. New York: Avon Books, 1971. 434 pp.
- Higginbotham, Pearl, and Pinkham, Mary Ellen. *Mary Ellen's Best of Helpful Hints—Fast/Easy/Fun Ways of Solving Household Problems*. New York: Warner Books, 1979. 119 pp.

- Hur, Robin. *Food Reform: Our Desperate Need*. Heidelberg Publishers (3707 Kerbey Lane, Austin, TX 78731), 1975. 260 pp.
- *Katzen, Mollie. *The Moosewood Cookbook*. Berkeley, CA: Ten Speed Press, 1977. 240 pp. Tasty recipes for lots of fresh vegetables.
- *Lappé, Frances M. *Diet for a Small Planet*. New York: Friends of the Earth/Ballantine Books, 1971. 301 pp.
- Linder, Maria C. "A Review of the Evidence for Food Quality." *Biodynamics*, Summer 1973, pp. 1-11.
- Macmaniman, Gen. *Dry It*. Fall City, WA: Living Food Dehydrators, 1973. 58 pp.
- *Robertson, Laurel, et al. *Laurel's Kitchen*. New York: Bantam Books, 1978. 641 pp.
- Root, Waverly. *Food—An Authoritative and Visual History and Dictionary of the Foods of the World*. New York: Simon & Schuster, 1980. 602 pp.
- Santa Clara County California Planned Parenthood. *Zucchini Cookbook*. Planned Parenthood (421 Ocean Street, Santa Cruz, CA 95060).
- Simmons, Paula. *Zucchini Cookbook*. Seattle, WA: Pacific Search, 1974. 127 pp.
- Stoia, Rose Greer, R.D. *Feeding the Vegetarian Infant*. Dandelion (4165 Fowler, Bellbrook, OH 45305), 1978. 6 pp.
- *Stoner, Carol. *Stocking Up*. Emmaus, PA: Rodale Press, 1973. 351 pp.
- Thomas, Anna. *The Vegetarian Epicure, Book One*. New York: Vintage Books, 1972. 305 pp.
- _____. *The Vegetarian Epicure, Book Two*. New York: Knopf, 1978. 401 pp.
- Twelve Months Harvest*. Ortho Book Division, Chevron Chemical Co., San Francisco, CA. 1975. 96 pp. Covers canning, freezing, smoking, drying, cheese, cider, soap, and grinding grain. Many good tips.

General

- Bailey, L.H. *The Farm and Garden Rule-Book*. New York: Macmillan, 1915. 586 pp.

- _____. *The Forcing Book*. New York: Macmillan, 1903. 266 pp.
- _____. *The Horticulturalist's Rule-Book*. New York: Macmillan, 1909. 312 pp.
- _____. *Manual of Gardening*. New York: Macmillan, 1914. 541 pp.
- _____. *Principles of Agriculture*. New York: Macmillan, 1909. 336 pp.
- Balfour, Lady E.B.* *The Living Soil and The Haughley Experiment*. London: Faber & Faber, 1943, 1975. 383 pp.
- Bennett, Charles F., Jr. *Man and Earth's Ecosystems*, New York: Wiley, 1975. 331 pp.
- *Berry, Wendell. *The Unsettling of America: Culture and Agriculture*. San Francisco: Sierra Club, 1977. 226 pp. Eloquent and passionate view of the sociological aspects of farming.
- Biodynamics Journal*. Richmond Townhouse Road, Wyoming, RI 02898.
- Bronson, William. "The Lesson of a Garden." *Cry California*, Winter 1970-71.
- *Carter, Vernon G., and Dale, Tom. *Topsoil and Civilization*. Norman, OK: University of Oklahoma Press, 1955. 292 pp. Describes how flourishing civilizations have fallen into decay by not maintaining their agricultural health and soil.
- Cocannouer, Joseph A. *Farming With Nature*. Norman, OK: University of Oklahoma Press, 1954. 147 pp.
- Cuthbertson, Tom. *Alan Chadwick's Enchanted Garden*. New York: Dutton, 1978. 199 pp. Captures the flavor of working under the originator of the biodynamic/French intensive method.
- Foster, Catharine O. *The Organic Gardener*. New York: Random House, 1972. 234 pp. Excellent, chatty, experienced. New England area especially.
- Fukuoka, Masanobu. *The One-Straw Revolution*. Emmaus, PA: Rodale Press, 1978. 181 pp. Natural farming from a Japanese philosopher/farmer. One of the few to address a sustainable grain culture.
- *Heckel, Alice (ed.). *The Pfeiffer Garden Book—Biodynamics in the Home Garden*. Wyoming, RI: Biodynamic Farming and Gardening Association, 1967. 199 pp.
- *Howard, Sir Albert. *The Soil and Health*. New York: Devin-Adair, 1956. 307 pp. A cornerstone of the organic movement.
- Huxley, Anthony. *An Illustrated History of Gardening*. New York: Paddington Press, 1978. 352 pp.
- *Hyams, Edward. *Soil and Civilization*. New York: Harper & Row, 1976. 312 pp. Reprint from 1952.
- Jeavons, John C. "New Ways from Old." *Cry California*, Winter 1973-74.
- *Jobb, Jamie. *My Garden Companion*. San Francisco: Sierra Club, 1977. 350 pp. Especially for beginners.
- King, F. H. *Farmers of Forty Centuries*. Emmaus, PA: Rodale Press, 1972. 441 pp. First-hand observations of Chinese agriculture.
- *Knott, James E. *Handbook for Vegetable Growers*, New York: John Wiley, 1957. 245 pp. Useful charts for small farmers. Heavy chemical orientation.
- *Koepef, Herbert H., Peterson, B. D., and Schauman, Wolfgang. *Biodynamic Agriculture: An Introduction*. Spring Valley, NY: Anthroposophic Press, 1976. 429 pp.
- Kraft, Ken, and Kraft, Pat. *Growing Food the Natural Way*. New York: Doubleday, 1973. 292 pp. California-area orientation.
- Lowdermilk, W. C. "Conquest of the Land Through Seven Thousand Years." *Agricultural Information Bulletin No. 99*. Washington, DC: U.S. Government Printing Office, 1975. 30 pp.
- *Merrill, Richard (ed.) *Radical Agriculture*. New York: Harper & Row, 1976. 459 pp. Philosophical and political aspects of food production.
- O'Brien, R. Dalziel. *Intensive Gardening*. London: Faber & Faber, 1956. 183 pp. Useful for potential mini-farmers.
- Perelman, Michael J. "Farming With Petroleum." *Environment*, October 1972, pp. 8-13.
- _____, and Shea, Kevin P. "The Big Farm." *Environment*, December 1972, pp. 10-15.
- Pfeiffer, Ehrenfried. *Biodynamic Farming and Gardening—Soil Fertility Renewal and Preservation*. Spring Valley, NY: Anthroposophic Press, 1943. 240 pp.
- _____. *Biodynamic Farming—Articles 1942-1962*. Wyoming, RI: Biodynamic Farming and Gardening Association. 150 pp.
- *Philbrick, John, and Philbrick, Helen. *Gardening for Health and Nutrition*. Blauvelt, NY: Rudolf Steiner Publications, 1971. 93 pp.
- Pratt, Anne. *Flowering Plants, Grasses, Sedges and Ferns of Great Britain*. London: Frederick Warne & Co., 1905. 4 volumes.
- Rateaver, Bargyla, and Rateaver, Gylver. *The Organic Method Primer*. Published by the authors, Pauma Valley, CA 92061, 1973. 257 pp. Packed with detailed information.
- *Rodale, J. I. (ed.) *The Encyclopedia of Organic Gardening*. Emmaus, PA: Rodale Press, 1959. 1,145 pp. and
- *_____. *How to Grow Fruits and Vegetables by the Organic Method*. Emmaus, PA: Rodale Press, 1961. 926 pp. Two excellent references. Many prefer the encyclopedia format, but we find the second to be more complete.
- *Rodale, Robert (ed.). *The Basic Book of Organic Gardening*. New York: Ballantine Books, 1971. 377 pp. Condensed information includes 14-day compost and nationwide planting dates.
- Salisbury, E. J. *The Living Garden (or The How and Why of Garden Life)*. London: G. Bell & Sons, 1946. 232 pp. An excellent book.
- *Seymour, John. *The Complete Book of Self Sufficiency*. London: Faber & Faber, 1976. 256 pp. Coffee-table size.
- _____. *John Seymour's Gardening Book (for Children)*. G. Whizzard Publications Ltd. (105 Great Russell Street, London WC1, England), 1978. 61 pp.
- _____. *The Self-Sufficient Gardener*. London: Faber & Faber, 1978. 256 pp. Coffee-table size. Seymour has long been a popular back-to-the-land advocate in England, both doing it and writing about it in his own humor-

ous style. His new "productions" are gorgeously illustrated, accurate, and uncluttered. The first includes grains, livestock, energy and skills such as spinning, metalwork, and thatching, as well as raising fruits and vegetables. The third listed concentrates on smaller-scale food production.

Smith, Marney. *Gardening With Conscience*. New York: Seabury Press, 1981. 86 pp.

Smith, Thomas. *French Gardening*. London: Utopia Press, 1909. 128 pp.

Soper, John. *Studying the Agriculture Course*. Bio-Dynamic Agricultural Association (35 Park Road, London NW1-6XT, England), 1976. 88 pp.

*Steiner, Rudolf. *Agriculture—A Course of Eight Lectures*. London: Bio-Dynamic Agricultural Association, 1958. 175 pp. The basis of the biodynamic movement. Advanced reading.

*Storl, Wolf. *Culture and Horticulture*. Wyoming RI: Biodynamic Farming and Gardening Association, 1979. Biodynamics and organic agricultural history explained simply.

Struever, Stuart (ed.). *Prehistoric Agriculture*. Garden City, NY: Natural History Press, 1971. 733 pp.

*Sunset Editors. *Sunset's New Western Garden Book*. Menlo Park, CA: Sunset-Lane, 1979. 512 pp. Indispensable descriptions and cultural directions for flowering plants, trees, and landscaping. For West Coast gardeners. Not organic.

Tiedjens, Victor A. *The Vegetable Encyclopedia and Gardener's Guide*. New York: Garden City Publishing, 1943. 215 pp.

United States Department of Agriculture. *Report and Recommendations on Organic Farming*. Office of Governmental and Public Affairs USDA, Washington, DC 20205, 1980. 94 pp.

Grains

Cole, John N. *Amaranth*. Emmaus, PA: Rodale Press, 1979. 311 pp.

Hunt, Thomas F. *The Cereals in America*. New York: Orange Judd, 1912. 421 pp.

*Leonard, Warren H., and Martin, John H. *Cereal Crops*. New York: Macmillan, 1963. 824 pp.

*Logsdon, Gene. *Small-Scale Grain Raising*. Emmaus, PA: Rodale Press, 1977. 305 pp.

Montgomery, E.G. *The Corn Crops*. New York: Macmillan, 1916. 347 pp.

Rodale, Robert. *Amaranth Round-up*. Emmaus, PA: Rodale Press, 1977. 48 pp.

Greenhouse Culture

*Abrahams, Doc, and Abrahams, Katy. *Organic Gardening Under Glass*. Emmaus, PA: Rodale Press, 1975. 308 pp.

Anderson, Phyllis. "Gardening Under a Roomy Tent You Make with Shadecloth or Plastic Over PVC Pipe." *Sunset*, Southern California edition, March 1980, pp. 200-1.

Antill, David. *Gardening Under Protection*. EP Publishing Ltd. (East Ardsley, Wakefield, West Yorkshire WF3-2JN, England), 1978. 72 pp.

*Aquatias, A. *Intensive Culture of Vegetables*. Solar Survival Press (Harrisville, NH 03450), 1978. 192 pp. Reprint from 1913 on raising food under glass.

Bailey, L. H. *The Forcing Book*. New York: Macmillan, 1903. 259 pp.

_____. *The Nursery-Manual*. New York: Macmillan, 1923. 456 pp.

Chase, J. L. H. *Cloche Gardening*. London: Faber & Faber, 1948. 195 pp.

Colebrook, Binda. *Winter Gardening in the Maritime Northwest*. Tilth Association (Rt. 2, Box 190-A, Arlington, WA 98223), 1977. 128 pp.

*Fisher, Rick, and Yanda, Bill. *The Food and Heat Producing Solar Greenhouse*. John Muir Publications (Santa Fe, NM 87501), 1976. 161 pp. Detailed.

Lawrence, William J. C. *Better Glasshouse Crops*. London: Allen & Unwin.

_____. *Science and the Glasshouse*. Oliver & Boyd (98 Great Russell Street, London WC1, England), 1950. 175 pp.

_____, and Newell, J. *Seed and Potting Composts*. London: Allen & Unwin, 1941. 136 pp.

McCullagh, James C. (ed.). *The Solar Greenhouse Book*. Emmaus, PA: Rodale Press, 1978. 328 pp.

Nearing, Helen, and Nearing, Scott. *Building and Using Our Sun-Heated Greenhouse: Grow Vegetables All Year-Round*. Charlotte, VT: Garden Way, 1977. 148 pp.

Rieke, Dr. Paul E., and Warncke, Dr. Darryl D. *Greenhouse Soils*. Chestertown, MD: LaMotte Chemical Products Co., 1975. 36 pp.

Homesteading

Cary, Mara. *Useful Baskets*. Boston: Houghton Mifflin, 1977. 132 pp.

Editors of "The American Agriculturist." *Broom-Corn and Brooms*. New York: Orange Jud, 1906. 59 pp.

Insect Life

Barclay, Leslie W. et al. *Insect and Disease Management in the Home Orchard*. Berkeley, CA: California Cooperative Extension Service, 1981. 39 pp.

Carlson, Rachel. *Silent Spring*. Boston: Houghton Mifflin, 1962.

Carr, Anna. *Rodale's Color Handbook of Garden Insects*. Emmaus, PA: Rodale Press, 1979. 241 pp.

*Fichter, George S. *Insect Pests*. New York: Golden Press, 1966. 160 pp.

Fish and Wildlife Service, U.S. Department of the Interior. *Attracting and Feeding Birds*. Conservation Bulletin No. 1, U.S. Government Printing Office, Washington, DC, revised 1973. 10 pp.

*Hunter, Beatrice Trum. *Gardening Without Poisons*. New York: Berkeley Publishing, 1971. 352 pp. Comprehensive survey of insect control methods.

*Levi, Herbert W. *Spiders*. New York: Golden Press, 1968. 160 pp.

Milne, Lorus, and Milne, Margery. *The Audubon Society Field Guide to North American Insects and Spiders*. New York: Knopf, 1980. 1,008 pp. Small format. Excellent color photographs!

*Mitchell, Robert T. *Butterflies and Moths*. New York: Golden Press, 1962. 160 pp.

- *Philbrick, John, and Philbrick, Helen (eds.). *The Bug Book*. Charlotte, VT: Garden Way, 1974. 126 pp.
- Schwartz, P.H., Jr. *Control of Insects on Deciduous Fruits and Tree Gnats in the Home Orchard—Without Insecticides*. Hyattsville, MD: U.S. Dept of Agriculture Research Service, 1975. 36 pp.
- *Yepson, Roger B., Jr. *Organic Plant Protection*. Emmaus, PA: Rodale Press, 1976. 688 pp.
- *Zim, Herbert S. *Insects*. New York: Golden Press, 1956. 160 pp.
- Rincon-Vitova Insectories*, P.O. Box 95, Oak View, CA 93022. Predatory insect source.

Learning/Teaching

- Bailey, L. H. (ed.). *Cornell Nature Study Leaflets*. Albany, NY: J. B. Lyon Co., Printers, 1904. 607 pp.
- _____. *Cyclopedia of American Agriculture in Four Volumes*. New York: Macmillan, 1907. 2,675 pp. including many illustrations.
- _____. *The Standard Cyclopedia of Horticulture in Three Volumes*. New York: Macmillan, 1944. 4,056 pp. including 4,000 + engravings and other illustrations.
- _____. *The Training of Farmers*. New York: Macmillan, 1909. 263 pp.
- Bieny, D. R. *The Why and How of Home Horticulture*. San Francisco: W. H. Freeman, 1980. 513 pp.
- Chittenden, Fred J. (ed.) *Dictionary of Gardening in Three Volumes*, (Second Edition). Oxford, England: Royal Horticulture Society, Clarendon Press, 1977. 2,316 pp.
- Hilgard, E. W., and Osterhout, W. J. V. *Agriculture for Schools of the Pacific Slope*. New York: Macmillan, 1927. 428 pp.
- Osterhout, W. J. V. *Experiments With Plants*. New York: Macmillan, 1911. 492 pp.
- Synge, Patrick M. (ed.). *Dictionary of Gardening—Second Edition Supplement*. Oxford, England: Royal Horticulture Society, Clarendon Press, 1979. 554 pp.

Other Crops

- Arora, David. *Mushrooms Demystified*. Berkeley, CA: Ten Speed Press, 1979. 668 pp.
- Bailey, L. H. *The Garden of Gourds*. New York: Macmillan, 1937. 134 pp.
- Beard, Benjamin H. "The Sunflower Crop." *Scientific American*, May 1981, pp. 150-161.
- Cox, Jeff. "The Sunflower Seed Huller and Oil Press." *Organic Gardening*, April 1979, pp. 58-61.
- Erickson-Brown, Charlotte. *Use of Plants for the Past Five Hundred Years*. Breezy Creeks Press (Box 104, Aurora, Ontario, Canada L4G-3H1), 1979. 510 pp.
- Fraser, Samuel. *The Strawberry*. New York: Orange Judd, 1926. 120 pp.
- Hand, F.E. and Cockerham, K.L. *The Sweet Potato*. New York: Macmillan, 1921. 261 pp.
- Harris. *The Sugar Beet in America*. New York: Macmillan.
- Knowles, Paul F., and Miller, Milton D. *Safflower*. Circular 532. Davis, CA: California Agricultural Experiment Station Extension Service, 1965. 51 pp.
- Meeker, John. "Backyard Bamboo." *Organic Gardening*, October 1980, pp. 88-99.
- van den Heuvel, Kick. *Wood and Bamboo for Rural Water Supply*. Delft, The Netherlands: Delft University Press, 1981. 76 pp.
- Wicherley, W. *The Whole Art of Rubber-Growing*. Philadelphia: Lippincott, 1911. 151 pp.

Seed Catalogs

- Abundant Life Seeds*, P.O. Box 772, Port Townsend, WA 98368. Small Seed exchange for residents of the Pacific Northwest and California only. Catalog 50¢.
- American Bamboo Co.*, 345 West Second Street, Dayton, OH 45402.
- Burpee Seed Co.*, Clinton, IA 52732. Large well-known company with wide selection of most vegetables and flowers.
- J. A. Demouchaux*, 827 North Kansas, Topeka, KS 66608. Gourmet vegetable seeds im-

- ported from Vilmorin and other French seed houses.
- Di Giorgi Co.*, Council Bluffs, IA 51501. Forage crops, old-fashioned lettuce and other vegetables, open-pollinated corn.
- Early Seed and Feed, Ltd.*, P.O. Box 3024, Saskatoon, Saskatchewan S7K-3S9, Canada. Grain, fodder and cover crops.
- Epicure Seeds*, Avon, NY 14414. Choice varieties from gourmet seed houses of Europe.
- Exotica Seed Co.*, 8033 Sunset Blvd., Suite 125, Los Angeles, CA 90046.
- Gurney's*, Yankton, SD 57078. Unusual vegetables. Cold-weather vegetables and fruit trees.
- Hansen New Plants*, Whiteriver, WI 53190. Carries specialized fruit trees and fruit bushes.
- Hart Seed Co.*, Wethersfield, CT 06109. Largest selection of old-fashioned and non-hybrid vegetables. Many hard-to-find varieties available on request.
- Hillier Nurseries Ltd.*, Ampfield, Ramsey, Hants S05-9PA, England. Excellent tree and plant supplier.
- J. L. Hudson Seed Co.*, P.O. Box 1058, Redwood City, CA 94064. One of the world's largest selections of flower and herb seeds. Catalog, \$1.
- Johnny's Selected Seeds*, Albion, ME 04910. Small seed company with integrity. Carries native American crops, select oriental vegetables, grains, short-maturing soybeans. Catalog, 50¢.
- Henry Lenthardt*, East Moriches, Long Island, NY 11940. Specializes in old-fashioned varieties of apple trees, pear trees, and grapes.
- Meadowbrook Herb Garden*, Rt. 138, Wyoming RI 02898. Biodynamically grown spices, herbs, teas, and herb seeds.
- Merry Gardens*, Camden, ME 04843. Good herbal plant selection including fruit-scented sage.
- Nichols Garden Nursery*, 1190 North Pacific Highway, Albany, OK 97321. Unusual specialties: elephant garlic, luffa sponge, winemaking supplies, herbs.

Nource Farms, Inc., P.O. Box 485, R.F.D., South Deerfield, MA 01373. Strawberry, raspberry, asparagus, rhubarb starts source.

George W. Park Seed Co., Greenwood, SC 29647. The best selection of flowers. Gorgeous, full-color catalog available free.

Redwood City Seed Co., P.O. Box 361, Redwood City, CA 94064. Basic selection of non-hybrid, untreated vegetable and herb seeds. Expert on locating various tree seeds, including redwoods. Basic catalog, 50¢. Tree crops catalog, \$1.

Sanctuary Seeds, 1913 Yew Street, Vancouver, BC V6K-3G3, Canada.

Sassafras Farms, P.O. Box 1007, Topanga, CA 90290. Two dozen organically-grown vegetable varieties and miscellaneous roots. Poster-catalog, \$1.

Seed Savers Exchange, Kent Whealy, Rural Rt. 2, Princeton, MO 64673. Exchange listings published yearly for \$2. Good source of heirloom varieties. Listing includes seed saving guide.

Seeds Blum, Idaho City Stage, Boise, ID 83706. Heirloom varieties plus good information on seed collection.

R. H. Shumway, Rockford, IL 61101. Good selection of grains, fodders, and cover crops.

Southmeadow Fruit Gardens, 2363 Filbury Place, Birmingham, MI 48009. Large fruit tree selection.

Stark Brothers, Louisiana, MO 63353. Specializes in fruit trees, especially dwarfs and semi-dwarfs. Carries many developed by Luther Burbank.

Stokes Seeds, P.O. Box 548, Buffalo, 14240. Carries excellent varieties of many vegetables, especially carrots.

Sunnybrook Farms Nursery, 9448 Mayfield Road, Chesterland, OH 44026. Scented geranium source.

Suttons Seeds, London Road, Earley, Reading, Berkshire RG6 1AB, England. For gourmet gardeners. Excellent, tasty varieties; hot-house vegetables.

Tree Crops Nursery, Rt. 1, Box 44B, Covelo, CA 95428. Excellent fruit tree stock—known and rare.

True Seed Exchange, RR 1, Princeton, MO 64673. Exchange for home-grown seed. To join (i.e., to list your own or to receive listings), send \$2.

Vermont Bean Seed Co., P.O. Box 308, Bomoseen, VT 05732. All kinds of beans for those who want to start growing more protein crops.

Vilmorin Andrieux, 4, quai de la Megisserie, 75001 Paris, France. Old, respected seed house specializing in high-quality gourmet vegetables. Catalog in French. Expensive minimum order.

Wilson Brothers Floral Co., Roachdale, IN 46172. Scented geranium source.

Dave Wilson Nursery, Hughson, CA 95328. Good fruit trees.

Arthur Yates & Co., P.O. Box 72, Revesvy 2212, New South Wales, Australia. Specializes in tropical varieties suitable for the southern hemisphere. International seed catalog free.

Seed Propagation

Bailey, L. H. *How Plants Got Their Names*. New York: Dover, 1963. 181 pp.

Brickell, Christopher (ed.). *Fruit*. New York: Simon & Schuster, 1980. 96 pp.

_____. *Plant Propagation*. New York: Simon & Schuster, 1979. 96 pp.

_____. *Vegetables*. New York: Simon & Schuster, 1980. 96 pp.

*Dremann, Craig. *Vegetable Seed Production*. Redwood City Seed Co. (P.O. Box 360, Redwood City, CA 94064), 1974. 6 pp. For moderate climates. Expanded version planned.

Hawthorn, Leslie, and Pollard, Leonard H. *Seed Production*. New York: The Blakiston Co., 1954. 626 pp. A classic.

Healey, B. J. *A Gardener's Guide to Plant Names*. New York: Scribner's, 1972. 284 pp.

Heiser, Charles B., Jr. *Seed to Civilization*. San Francisco: W. H. Freeman, 1973. 243 pp.

Johnson, A. F., and Smith, H. A. *Plant Names Simplified*. Landsmans Bookshop Ltd. (Buckenhill, Bromyard, Herefordshire, England), 1972. 120 pp.

Johnston, Robert, Jr. *Growing Garden Seeds*. Johnny's Selected Seeds (Albion, ME 04910), 1976. 32 pp. Culture of plants for saving seed.

*Miller, Douglas C. *Vegetable and Herb Seed Growing for the Gardener and Small Farmer*. Bullkill Creek Publishing (Hersey, MI 49639), 1977. 46 pp. A good book to start with.

Reilly, Ann. *Park's Success With Seeds*. George W. Park Seed Co. (Greenwood, SC 29647), 1978. 364 pp.

*Rogers, Marc. *Growing and Saving Vegetable Seeds*. Charlotte, VT: Garden Way, 1978. 140 pp.

United States Department of Agriculture. *Seeds—The Yearbook of Agriculture, 1961*. Washington, DC: U.S. Government Printing Office, 1961. 591 pp.

Wilkes, H. Garrison, and Wilkes, Susan. "The Green Revolution." *Environment*, October 1972, pp. 32-39.

Soil

Albrecht, William A. *The Albrecht Papers*. Raytown, MI: Acres USA, 1975. 515 pp.

Brady, Nyle C. *The Nature and Properties of Soils*. Eighth edition. New York: Macmillan, 1974. 639 pp.

Farb, Peter. *Living Earth*. New York: Harper Colophon, 1959. 175 pp. Easy-to-read peek at the life under the soil.

Faulkner, Edward H. *Plowman's Folly*. Norman, OK: University of Oklahoma Press, 1943. 155 pp. Classic.

Hall, Sir A.D. *The Soil—An Introduction to the Scientific Study of the Growth of Crops*. New York: E.P. Dutton, 1920. 352 pp.

**Handbook on Soils*. Brooklyn, NY: Brooklyn Botanic Garden, 1956. 81 pp. Some photos of root systems in the soil.

Jackson, Wes. *New Roots for Agriculture*. San Francisco: Friends of the Earth, 1980. 155 pp. Addresses the importance of developing sustainable agricultural systems including perennial seed producing plants.

King, F. H. *The Soil*. New York: Macmillan, 1895. 303 pp.

Pauli, F. W. *Soil Fertility: A Biodynamic Approach*. Adam Hilger Ltd. (98 St. Pancras Way, London NW1, England), 1976. 204 pp.

Lyon, T. Littleton, and Buckman, Harry O. *The Nature and Properties of Soils*. New York: Macmillan, 1929. 428 pp. First edition only for more organic treatment.

_____. *The Nature and Properties of Soils*. Fourth edition. New York: Macmillan, 1949. 499 pp.

Waksman, Selam A. *Humus*. Baltimore, MD: Williams and Wilkins Co., 1938. 526 pp.

United States Department of Agriculture. *Soils and Men—The Yearbook of Agriculture, 1938*. Washington, DC: U.S. Government Printing Office, 1938. 1,232 pp.

Tools

Blackburn, Graham. *Woodworking Handtools*. New York: Simon & Schuster, 1974. 238 pp.

Branch, Diana S. *Tools for Homesteaders, Gardeners, and Small-Scale Farmers*. Emmaus, PA: Rodale Press, 1978. 512 pp.

Jones, Bernard E., (ed.). *The Complete Woodworker*. Berkeley, CA: Ten Speed Press, 1980. 408 pp.

Joseph, Stephen, et al. *Wood Conserving Cookstoves: A Design Guide*. Maryland: VITA, 1981.

McCullagh, James C. *Pedal Power*. Emmaus, PA: Rodale Press, 1977. 133 pp.

_____. *The Solar Greenhouse Book*. Emmaus, PA: Rodale Press, 1978. 328 pp.

Tresemmer, David. *The Scythe Book—Mowing Hay, Cutting Weeds, and Harvesting Small Grains With Hand Tools*. Brattleboro, VT: Hand and Foot Ltd., 1981. 120 pp.

*Jackson, Albert, and Day, David. *Tools and How to Use Them*. New York: Knopf, 1979. 252 pp.

Apopka Growers Supply, Drawer 1147, Apopka, FL 32703. Six-year KDA clear vinyl plastic film for constructing mini-greenhouses. Available in 50-inch wide, 100-foot long rolls only.

Arts Machine Shop, Harrison at Oregon Trail, American Falls, ID 83211. Good quality soil corers.

The C. S. Bell Co., 170 W. Davis St., Tiffin, OH 44883. Grain mills and shellers.

J. A. Cissell Co., Squunkum-Yellowbrook Road, Farmingdale, NJ 07727. Five-to-ten year bird netting.

Composite Growing Systems, P.O. Box 343, Skyline Blvd., La Honda, CA 94020. Learning Boxes (4-tiered microcosm of garden bed for teachers).

Countryside General Store, 103 N. Monroe St., Waterloo, WI 53595

Cumberland General Store, Rt. 3, Box 479, Crossville, TN 38555.

Ecology Action, 2225 El Camino Real, Palo Alto, CA 94306. Mail-order La Motte soil test kits.

Hand and Food Ltd., P.O. Box 611, Brattleboro, VT 05301. Grain harvesting, other hand tools, and relevant publications.

Happy Valley Ranch, P.O. Box 9153, Yakima, WA 98909. Cider, fruit and wine presses.

Hersey Products, Inc., 250 Elm Street, Dedham, MA 02026. Moderately priced water meter that measures in tenths of gallons. Order number: QOH 0201-MVR-30A-COMPACT-10-SCG-B-L/ CONN-RZ-BOTTOM.

Intermediate Technology, 556 Santa Cruz Avenue, No. 6, Menlo Park, CA 94025. An excellent "Small Is Beautiful/Small Is Possible" networking and information group. Membership consulting service and publications discount. This group is especially interested in small scale, locally financed and controlled industry, particularly in rural areas: such as small paper mills using kenaf and other alternatives to pulpwood, smaller scale wool processing technology, and so on. They are also interested in helping individuals and groups establish county-level local resources information, action centers, and marketplaces.

Jacobs Brothers Co., 8928 Sepulveda Blvd., Sepulveda, CA 91343. Fifteen-year shade and pest (3%) netting in various percentages of shading capacity.

Kerr Enterprises, P.O. Box 27417, Tempe, AZ 85281. A very good solar box cooker. Send \$4 for plans and other materials.

Martin Processing, Inc., Film Division, P.O. Box 5068, Martinsville, VA 24112. Fifteen-year Lumar plastic film for constructing mini-greenhouses.

Walt Nicke's Garden Talk, P.O. Box 667 G, Hudson, NY 12534. Catalog of Haws watering cans and other high quality small tools. Also carries Spyn-gydes which guide hoses easily around corners of growing areas.

Nitragin, Inc., 3101 West Custer Avenue, Milwaukee, WI 53209. Source of many kinds of inoculants for seeds, so you can maximize the fixing of nitrogen in the soil by legumes, and obtain higher yields and higher protein contents.

Northeast Carry Trading Company, 110 Water St., Hallowell, ME 04347.

Organic Farm and Garden Center, 840 Potter Street, Berkeley, CA 94710. Mail-order fertilizers, including "clod-buster."

Smith and Hawken, 68 Homer Lane, Drawer 52, Palo Alto, CA 94301. Superbly crafted D-handled spades and forks from England.

Stratoflex, Inc., 220 Roberts Cut-Off, P.O. Box 10398, Fort Worth, TX 76114. Excellent heavy-duty water hoses. (We like the #230-12.)

Trees

Bailey, L. H. *The Apple Tree*. New York: Macmillan, 1922. 117 pp.

_____. *The Cultivated Conifers in North America*. New York: Macmillan, 1933. 404 pp.

_____. *The Principles of Fruit-Growing*. New York: Macmillan, 1897. 516 pp.

_____. *The Pruning Manual*. New York: Macmillan, 1954. 320 pp. Constantly revised for 50 years and now out of print.

- Baker, Richard St. Barbe. *Dance of the Trees*. Oldbourne Press (121/128 Fleet Street, London EC4, England), 1956. 192 pp.
- _____. *Green Glory*. New York: A. A. Wyn, Inc., 1949. 253 pp.
- * _____. *My Life—My Trees*. Findhorn Publications (The Park, Forres IV36-OTZ, Scotland), 1970. 167 pp.
- _____. *The Redwoods*. Lindsay Drummond Ltd. (2 Guilford Place, London WC1 England), 1945. 95 pp.
- _____. *Sahara Challenge*. London: Lutterworth Press, 1954. 152 pp. Important book.
- Brickell, Christopher. *Pruning*. New York: Simon & Schuster, 1980. 96 pp.
- Brockman, Frank. *Trees of North America*. Racine, WI: Golden Press, 1979. 280 pp.
- Brooks, Reid, and Hesse, Claron. *Western Fruit Gardening*. Berkeley, CA: University of California Press, 1953. 287 pp. Old but still good.
- Cheyney, E. G. *Farm Forestry*. New York: Macmillan.
- Cheyney, E. G., and Wentling, J. P. *The Farm Woodlot*. New York: Macmillan, 1919. 343 pp.
- Clark, F. B. *Planting Black Walnut for Timber*. Washington, D.C.: U.S. Dept. of Agricultural Forest Service, 1976. 10 pp.
- Coit, J. Eliot. *Citrus Fruits*. New York: Macmillan, 1917. 520 pp.
- Collingwood, G. H., and Brush, Warren D. *Knowing Your Trees*. The American Forestry Association, 1978. 389 pp.
- Commission on International Relations. *Firewood Crops*. Washington, DC: National Academy of Sciences, 1980. 237 pp.
- Cord, Fred W. *Bush Fruits*. New York: Macmillan, 1909. 537 pp.
- Douglas, J. S. and Hart, Robert A. de J., *Forest Farming*. Emmaus, PA: Rodale, 1976. 193 pp. Excellent.
- Downing, A. J. *The Fruits and Fruit Trees of America*. New York: John Wiley, 1862. 760 pp.
- Food and Agriculture Organization of the United Nations (FAO-UN). *Forest Tree Seed Directory*. New York: United Nations, 1975. 283 pp.
- Foster, Ruth. *Landscaping That Saves Energy Dollars*. New York: David McKay, 1978.
- Friends of the Trees Society*, Star Route, Box 74, Oroville, WA 98844. Good tree information.
- Garner, R. J. *The Grafters Handbook*. New York: Oxford University Press, 1979. 319 pp.
- *Giono, Jean. *The Man Who Planted Hops and Grew Happiness*. Friends of Nature (Winchester, MA 01890), 1967. 17 pp. True account of a one-man tree planting program. Inspirational.
- Hartmann, Hudson T., et al. *Propagation of Temperate-Zone Fruit Plants*. Davis, CA: University of California Cooperative Extension Service, 1979. 63 pp.
- The Harvard Forest Models*. Cambridge, MA: Harvard College, 1941. 48 pp.
- Hillier Nurseries. *Manual of Trees and Shrubs*. London: David and Charles Publishers. A key publication.
- Hudson, Roy L. *Sunset Pruning Handbook*. Menlo Park, CA: Lane, 1952. 80 pp.
- Hume, H. H. *The Cultivation of Citrus Fruits*. New York: Macmillan, 1954. 561 pp.
- Huxley, Anthony (ed.). *Deciduous Garden Trees and Shrubs*. New York: Macmillan, 1973. 216 pp.
- _____. *Evergreen Garden Trees and Shrubs*. New York: Macmillan, 1973. 216 pp.
- Johnson, Hugh. *The International Book of Trees*. New York: Bonanza Books, 1980. 288 pp. Good background.
- Kraft, Ken, and Kraft, Pat. *Fruits for the Home Garden*. New York: Morrow, 1968. 287 pp.
- _____. *Grow Your Own Dwarf Fruit Trees*. New York: Walker, 1974. 218 pp.
- Lorette, Louis. *The Lorette System of Pruning*. London: Martin Hopkinson & Co., Ltd., 1925. 164 pp. Practiced by Chadwick. Fruit trees are gently pinched and trained during summer.
- Martin, R. Sanford. *How to Prune Fruit Trees*. Published by author (10535 Las Lunitas Avenue, Tujunga, CA 91042), 1978. 90 pp. Best and simplest book on pruning for West Coast gardeners.
- Mollison, Bill, and Holmgren, David. *Permaculture One*. Corgi Books (Trans-World Publishers Ltd., Century House, 61-61 Uxbridge Road, Ealing W5-5SA, England), 1978. 128 pp.
- _____. *Permaculture Two*. Tagari Books (P.O. Box 96, Stanley, Tasmania 7331, Australia).
- Moore, S. W. *Practical Orchard-ing On Rough Lands*. Akron, OH: New Werner Company, 1911. 289 pp.
- North American Fruit Explorer's Quarterly*, Henry Converse, 2317 Seneca Lane, Paducah, KY 42001.
- Paddock, Whipple. *Fruit Growing in Arid Regions*. New York: Macmillan, 1913. 395 pp.
- Moore, S. W. *Practical Orchard-ing on Rough Lands*. Akron, Ohio, 1911. 289 pp.
- Rivers, Thomas. *The Miniature Fruit Garden*. New York: Orange Judd, 1866. 133 pp.
- Sheat, W. G. *Propagation of Trees, Shrubs, and Conifers*. New York: Macmillan, 1957.
- *Smith, J. Russell. *Tree Crops, Key to a Permanent Agriculture*. Old Greenwich, CT: Devin-Adair, 1953. 408 pp. Classic work on an important concept.
- Sunset Editors. *Garden Trees*. Menlo Park, CA: Lane, 1975. 96 pp.
- _____. *Pruning Handbook*. Menlo Park, CA: Lane, 1976. 96 pp.
- Titmuss, F. H. *A Concise Encyclopedia of World Timbers*. New York: Philosophical Library, 1949. 156 pp.
- Tukey, Harold Bradford. *Dwarfed Fruit Trees*. Ithaca, NY: Cornell University Press, 1964. 562 pp. Definitive work on the subject.
- United States Department of Agriculture. *Trees—The Yearbook of Agriculture, 1949*. Washington, DC: U.S. Government Printing Office, 1949. 944 pp.
- University of California Extension Service. *Avocado Care in the Home Orchard*. 1975. 3 pp.
- Walheim, Richard R. L. *Citrus—How to Select, Grow, and Enjoy*. H P Books (P.O. Box 5367, Tucson, AZ 85703), 1980. 176 pp.