

AT MICROFICHE REFERENCE LIBRARY

A project of Volunteers in Asia

Equipment for Rural Workshops

by: John Boyd

Published by:

Intermediate Technology Publications, Ltd.
9 King Street
London WC2E 8HN
United Kingdom

Paper copies are 2.95 British pounds.

Available from:

Intermediate Technology Publications, Ltd.
9 King Street
London WC2E 8HN
United Kingdom

Reproduced by permission of Intermediate
Technology Publications, Ltd.

Reproduction of this microfiche document in any
form is subject to the same restrictions as those
of the original document.

EQUIPMENT FOR RURAL WORKSHOPS

by John Boyd

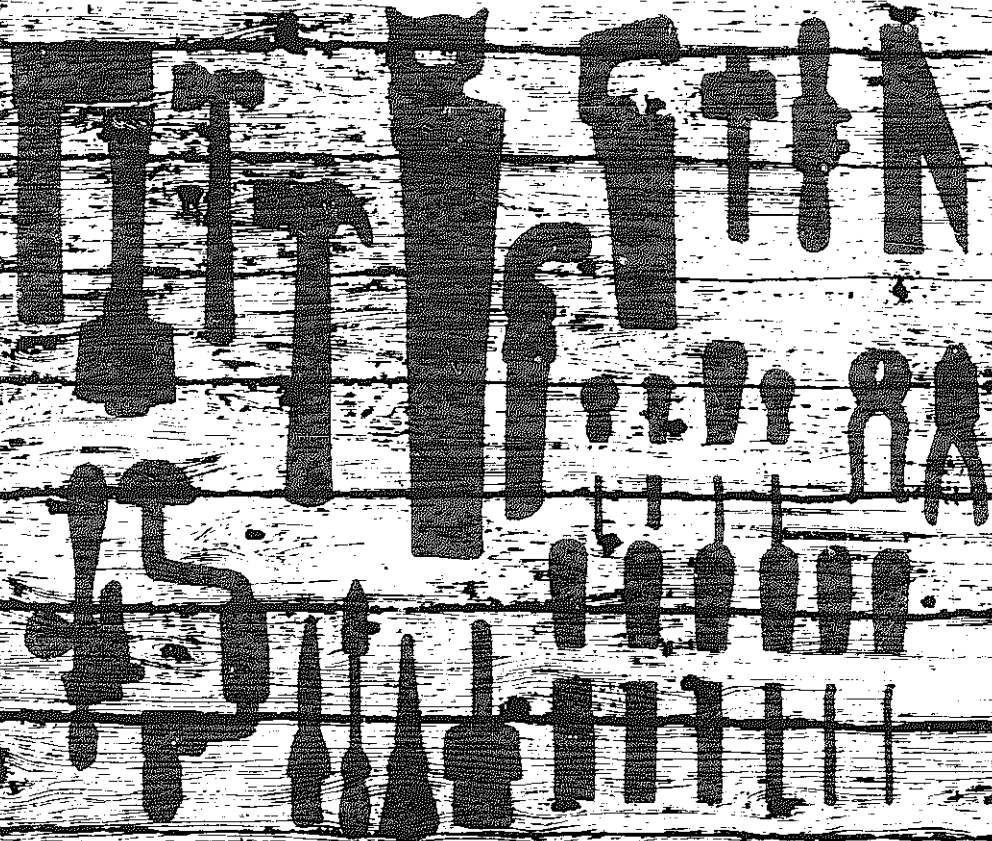

Workshops in the rural areas of developing countries can range from a wattle and daub shack set up under a tree by the roadside, to a much more sophisticated brick building which may even have electricity laid on. But whatever the standard of the building use, if the workshop is to be of practical use, it has to have suitable tools and equipment.

This book is a guide to anyone who wishes to equip a workshop, from the basic tools required for a one or two man carpentry workshop without power to the more sophisticated establishment requiring power equipment for both wood and metal working. Only well-known and reliable equipment is listed here, and the prices given may soon be out of date, but they give an inexperienced person some idea of the budget required for a particular size of workshop.

The tools specified are all illustrated and workshop layouts are suggested. There are also photographs of various sizes of workshop in different countries, as well as some pictures of farming equipment that has been manufactured at some of the workshops. Suppliers' addresses are also given in an appendix.

This publication will be of immense value to any practical field worker involved in the rural areas of developing countries.

John Boyd is an agricultural engineer with wide experience of developing countries. From 1972 to 1976 he was Agricultural Projects Officer of the Intermediate Technology Development Group. During that time he advised on tropical farm mechanisation and small scale engineering projects. His published works include *Tools for Agriculture: A Buyer's Guide to Low Cost Farm Implements; Eight Simple Surveying Levels;* and *Report on Farm Equipment Development Project, Daudawa, Nigeria* (Intermediate Technology Publications).

Steve Bonnist, John Collett, Tony Mallett and Harold Pearson also contributed to this publication and are members of the Intermediate Technology Development Group.

ISBN 0 903031 45 0

Intermediate Technology Publications Ltd.

Equipment for Rural Workshops

*by J.E.L. Boyd,
Agriculture Unit,
Intermediate Technology
Development Group*

*with additional material by
S.A. Bonnist, J.R. Collett,
A. Mallett and H.S. Pearson*

Intermediate Technology Publications Ltd

**Exclusive Distributor:
ISGS, Inc.
P. O. Box 555
Forest Grove, OR 97116**

© 1978, Intermediate Technology Publications Ltd.
Published by Intermediate Technology Publications Ltd,
9 King Street, London WC2E 8HN, U.K.

ISBN 0 903031 45 0

Acknowledgement

The publication of this booklet has been made possible by grants from The Claremont Trust; The Action for World Development Committee of the Episcopal Church of Scotland; and the Ministry of Overseas Development, U.K. The Intermediate Technology Development Group gratefully acknowledges their generosity.

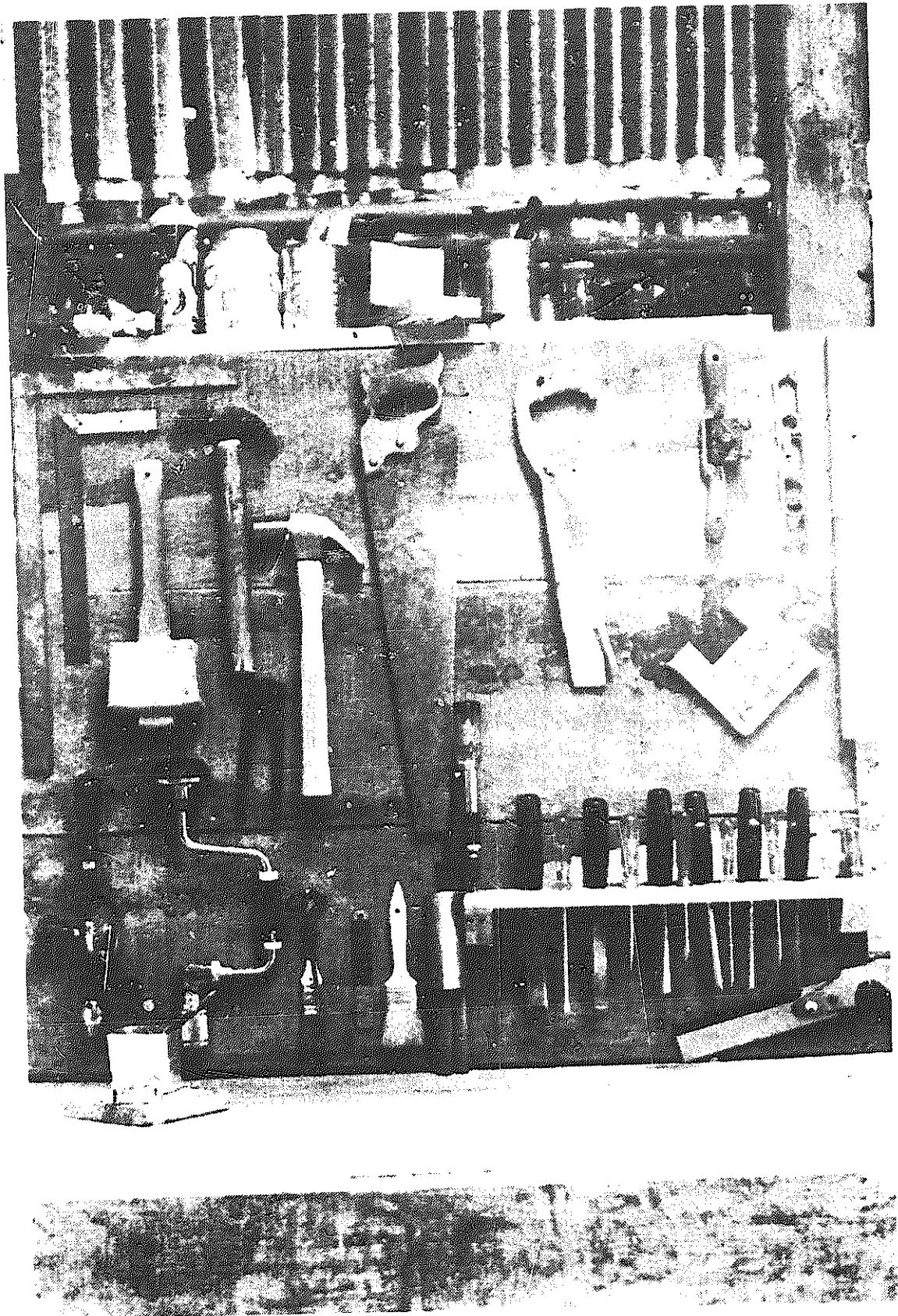

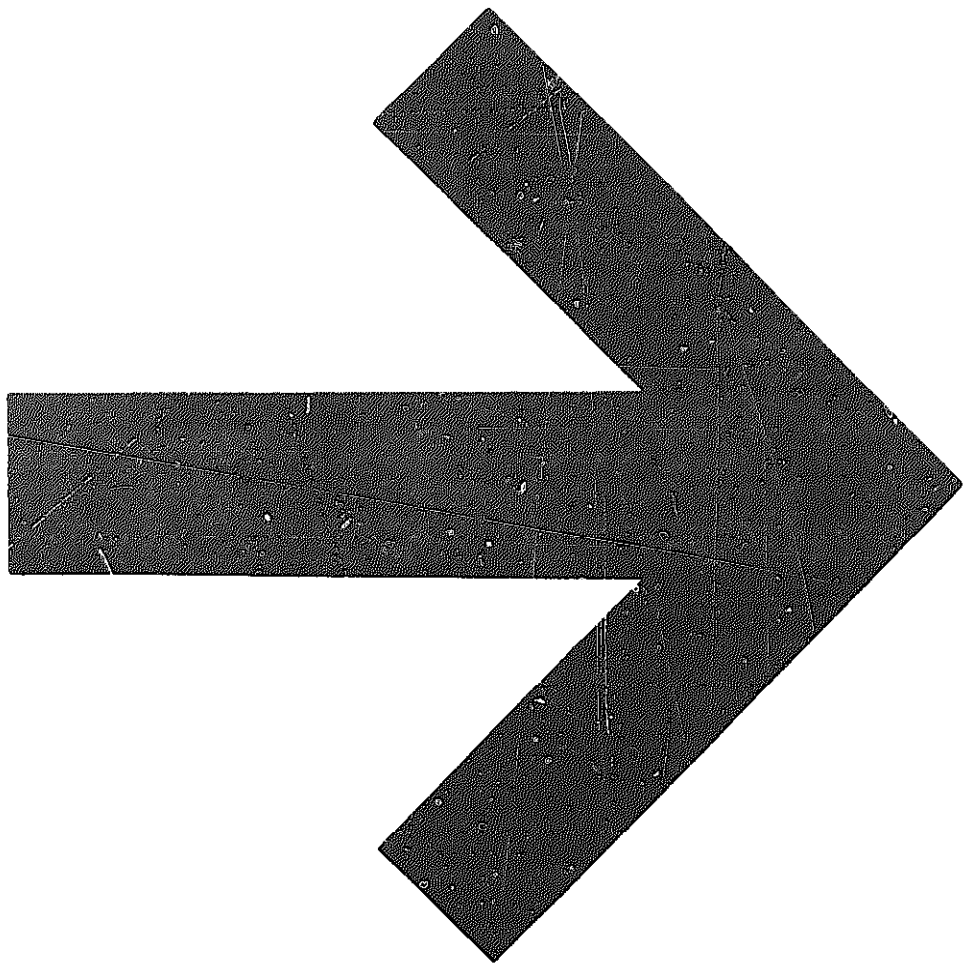

Contents

1. Introduction	7
2. Workshop building for one or two craftsmen	9
3. Basic equipment for a 1-2 man workshop without power supply	
3.1 Basic woodworking equipment	12
3.2 Basic metal working equipment	23
4. Additional useful equipment for a 1-2 man workshop without power supply	
4.1 Additional useful woodworking equipment	34
4.2 Additional useful metal working equipment	37
5. Small power tools for use in a 1-2 man workshop	
5.1 Power woodworking equipment	46
5.2 Power metal working equipment	49
6. Workshop buildings for 4-6 craftsmen	51
7. Power equipment for a 4-6 man workshop	
7.1 Power woodworking equipment – machine tools	54
7.2 Power metal working equipment – machine tools	57
8. Power supply for the workshop	60
9. Bibliography on small scale workshops	61
Appendix I Suggested list of workshop equipment	62
Appendix II List of equipment which can be made within the workshop	67
Appendix III Notes on metal-working equipment	70
Appendix IV Rural blacksmith entrepreneurs and their capabilities	72
Appendix V Tools and prices	76
Appendix VI Suppliers' names and addresses	90

List of Photographs

Village workshop at an Ujaama village in Tanzania	9
Watutsi refugees – formerly cattle herders – learning carpentry skills under ILO guidance at the Kayongozi Refugee Centre in Burundi	13
Forge and anvil	24
Trainees at Stereke Boys Centre, Nairobi, learning welding skills	45
Power hacksaw driven by a hand drill in a rural workshop equipped with electricity	48
Sharpening a drill bit (Mezan Teferi Workshop, Ethiopia)	49
Workshop in Magoye, Zambia	51
Gurage Water Development Project workshop, Ethiopia	51
Cutting angle iron in the Gurage workshop	52
Power drill press stand for metal-working	59
Tie ridger attachments made at the Intermediate Technology workshop Magoye	68
Double ox yoke made in the Magoye workshop	68
Various items made at the Magoye workshop	69
Triangular harrow	69

Introduction

It is hoped that this equipment guide will assist the man in the field who is required to set up a training workshop, a workshop for his own use, or attempting to assist local people in the purchase of equipment.

In many cases field staff with very little knowledge of machine shop equipment and costs are landed with the job of equipping a workshop and locating suitable tools. The prices given here will, of course, soon be out of date, but they will give the inexperienced person some idea of the size of budget required for setting up a small machine shop.

Only well-known and reliable equipment is listed. Anyone setting up a workshop in a remote part of a developing country should select well-known makes of equipment wherever possible. They should not make the mistake of buying cheap equipment, such as ex-public works or old stock, unless the manufacturer is still producing spare parts for the machinery. The same applies to foreign makes which may no longer be imported for one reason or another. This is not so critical as far as hand tools are concerned, providing the quality is good.

Hand power tools are used a great deal these days. When buying these tools ask the manufacturer or dealer if there is a heavy duty range available. Heavy duty tools are often much stronger than the handyman range and more suitable for use in a workshop.

The tools recommended are those which would be suitable for general purpose wood working and metal working enterprises, which might be called on to make or repair a very wide variety of goods. Specialist workshops would require rather different equipment; for example, a workshop repairing motorised farm machinery would need the equipment listed in *Agricultural Machinery Workshops – Design, Equipment and Management* (F.A.O. Agricultural Development Paper No. 66).

It is most important to ensure, *before the tools are bought*, that they can be fully used by the workshop. The hand tools in the lists of basic equipment can be used to do the same work as the much more costly power tools listed in later sections of the book, with the single exception of welding. Power tools only speed up the work, and are not economic unless there is enough work to keep them in use for a substantial part of each day.

An approximate indication of prices in the United Kingdom in mid-1977 has been given. In general, the more complex equipment will be imported into a developing country and will be more expensive than in the United Kingdom.

Simple hand tools may well be made within the developing country and may be cheaper than in the United Kingdom. Prices of tools are related to their quality and there is sometimes a very wide range. For example, in the U.K. a carpenter's cross cut hand saw could be priced from £2 (for a cheap saw suitable for occasional use or for an unskilled operator) to £15 (for a top quality saw which will last a lifetime in the hands of a skilled craftsman).

This booklet is intended to help people choose appropriate tools and equipment. It is *not* an instructional textbook on workshop technology.

The Intermediate Technology Development Group has had experience in helping small craftsmen to set up their own workshops and operate them successfully as, indeed, have persons and organisations listed in the bibliography in Section 9. This manual contains information arising from the Group's experience in the field.

In case of difficulty in obtaining any items, write to: Intermediate Technology Development Group Industrial Services, Myson House, Railway Terrace, Rugby CV21 3HT, U.K.

Safety and First Aid

In case of fire, buckets filled with sand or earth should be kept in accessible areas ready for use.

Every workshop should have a first aid kit for treating minor cuts and burns. Each worker should know where it is kept, and the kit should be put back in the same place after use. The basic essentials for a first aid kit are: purified water; eye bath; cotton wool; plasters; bandages; scissors; safety pins for fastening dressings; disinfectant and antiseptic. The first aid box should be regularly inspected and replenished as necessary.

Section 2

Workshop Building for One or Two Craftsmen

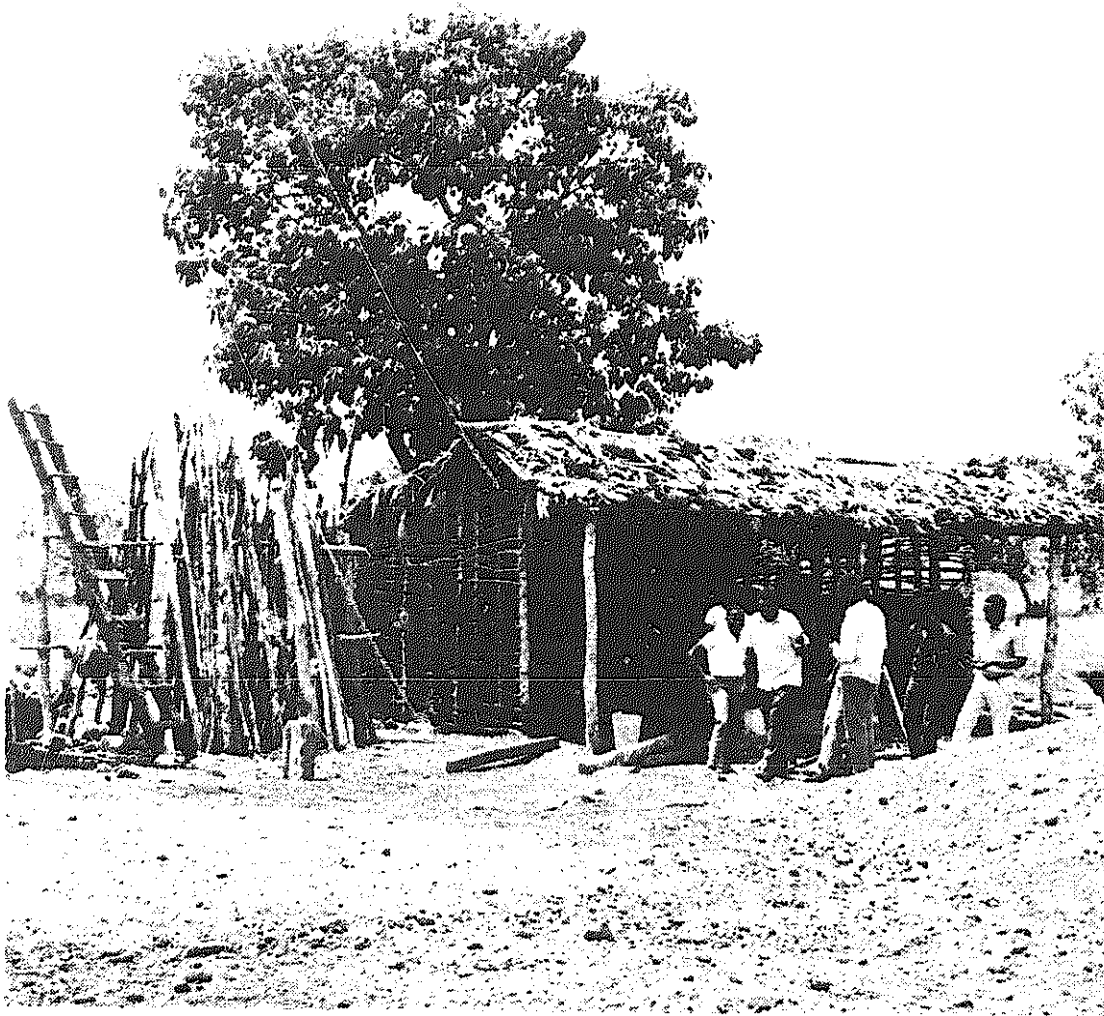

Village workshop at an Ujaama village in Tanzania, built by local men and women, using local skills and materials. It provides an excellent work environment — quiet, cool and dry. It cost only a few shillings cash and provides a workplace for at least four people. (Photo: G.A. Macpherson).

Workshop tools are expensive, liable to be stolen and easily ruined if they become rusty. Therefore, the workshop must be waterproof and secure against theft. To reduce the cost a small workshop can be open-sided and the tools and materials kept in a secure store, perhaps a room of the craftsman's house. However, it is better if the complete workshop can be locked. Windows should let in as much light as possible but should not face the afternoon sun. Blacksmithing is best done away from direct sunlight, so that the colour of hot metal may be seen easily. Blacksmithing and welding may cause a fire if they are done in a wooden building. For the same reason, the woodworking section of a general purpose workshop should be as far as possible from the blacksmithing and welding sections. Blacksmithing and welding produce quantities of unpleasant fumes and should therefore be done in a well-ventilated area. Concrete or stone floors are easiest to keep clean, but tools may be easily broken if dropped onto hard floors. Rammed earth is a cheap method of flooring a small workshop. The best way to store tools is on boards with the silhouette of each tool painted so that missing tools can be identified immediately. Materials are liable to be stolen and should be kept in a secure store. Timber must be kept dry and stored so that it can be easily inspected for termite damage. Rust on steel is bad for cold metal cutting tools; rust on steel for blacksmithing is less serious. Steel and timber are often supplied in lengths from 3m to 6m, which are best stored horizontally on racks. Shorter lengths can be stored upright. Shelving with compartments is necessary for storing small items such as different sizes of screws, nails, bolts and nuts.

Some important features of the general purpose workshop illustrated opposite are:

1. The doors are 2m wide so that large objects made inside the workshop can be carried out.
2. The horizontal racks for storing long lengths of wood and metal are located so that the materials can be brought in through the door and stacked without being turned.
3. There are vertical storage racks for short lengths of material.
4. Small tools are hung on boards over the workbenches.
5. The benches receive light from the windows.
6. The blacksmithing area is near the door (for ventilation), away from direct sunlight and away from the woodwork area.
7. Tools and small parts which might be stolen by customers or onlookers are stored as far as possible from the door.
8. Equipment used for both wood and metal work (e.g. a post drill) is located between the woodwork and metalwork benches.

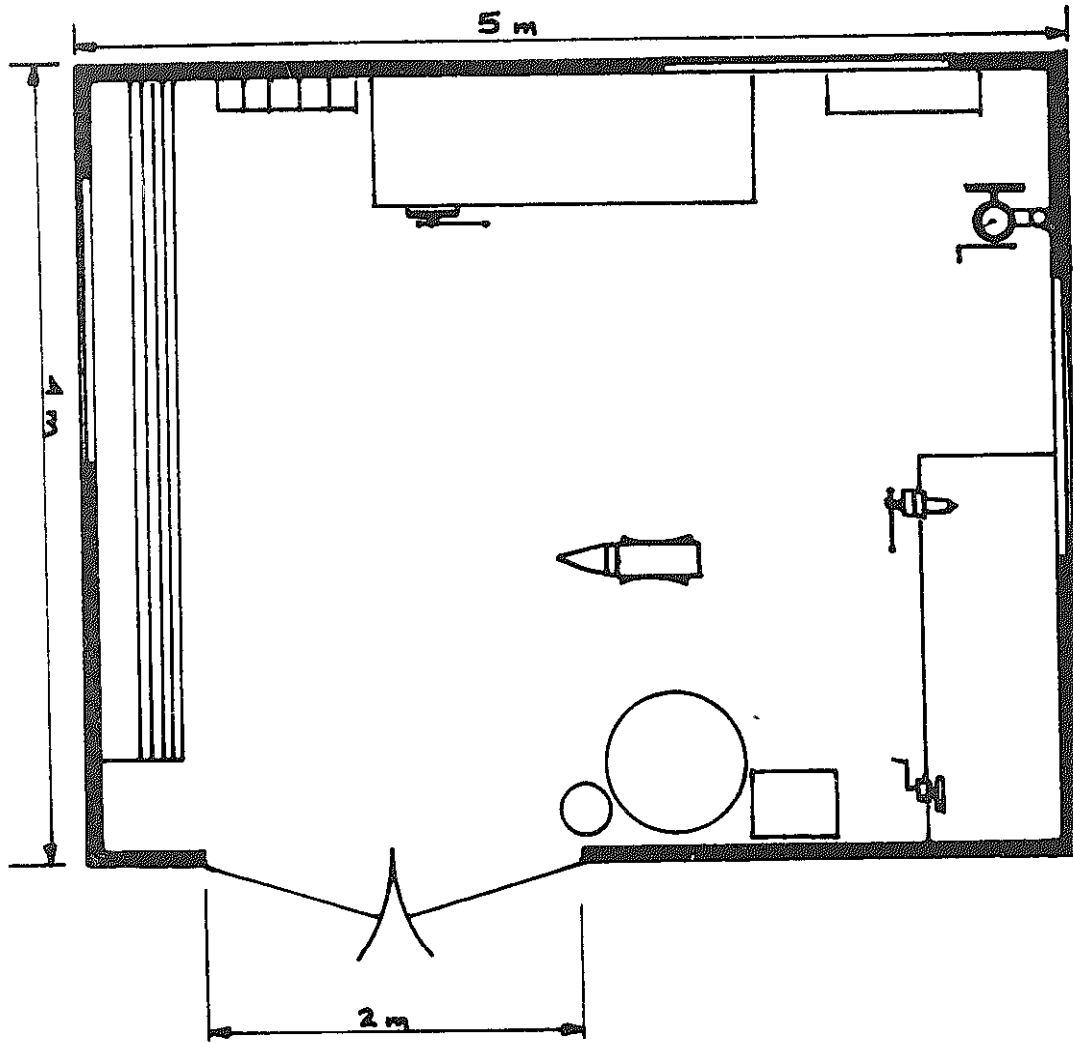
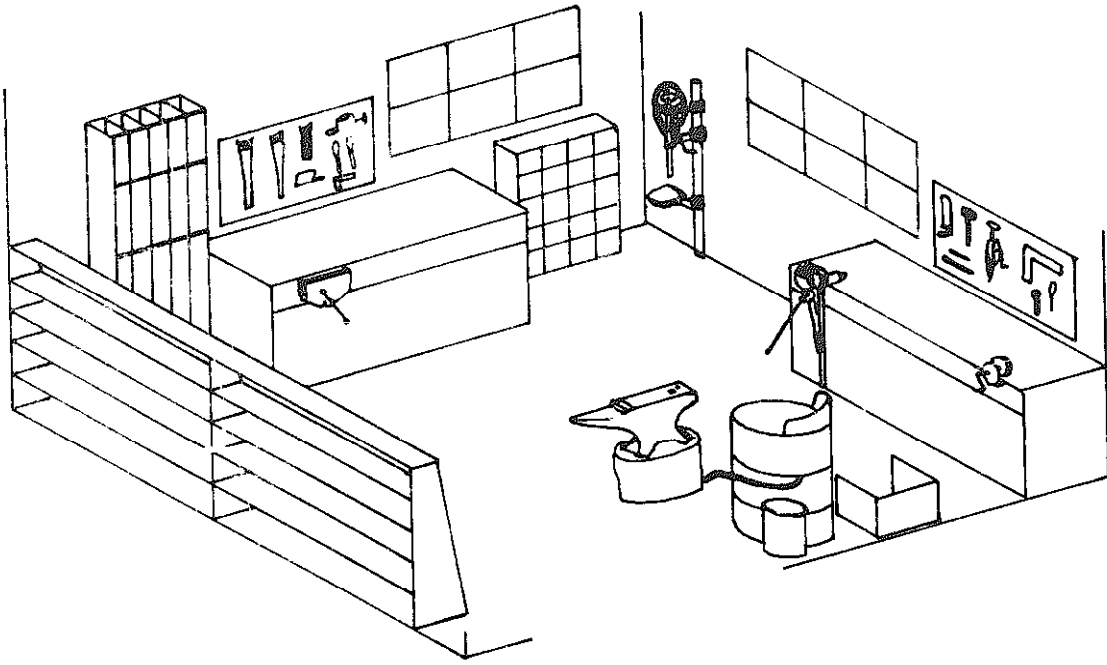

Basic Woodworking Equipment

(for 1-2 man workshop without power supply)

It is assumed that the craftsman would make his own work bench, sawing horses and bench hook. The remaining items listed could be bought in the United Kingdom for about £170 in mid-1977.

Work bench (800mm high, 650mm wide and 2500mm long)

The bench must be as rigid as possible. Accurate work cannot be done at a bench which moves while the craftsman is working. It is often best to bolt the bench firmly to the wall of the workshop. The height of the bench top will depend on the user, but 800-900mm is suitable for most men.

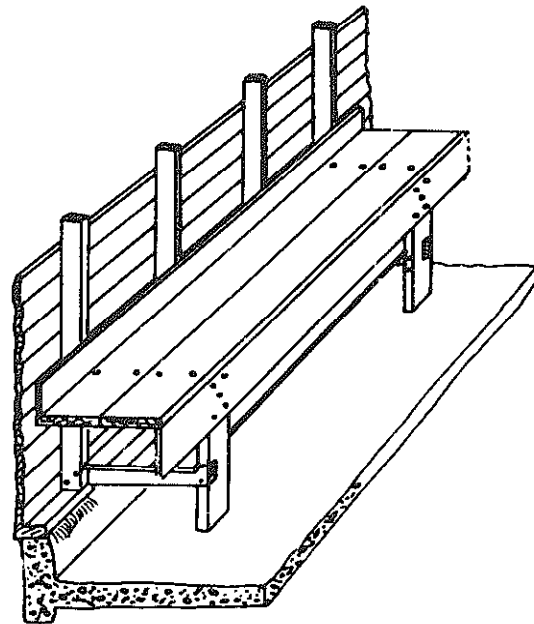

Bench fixed to the workshop wall

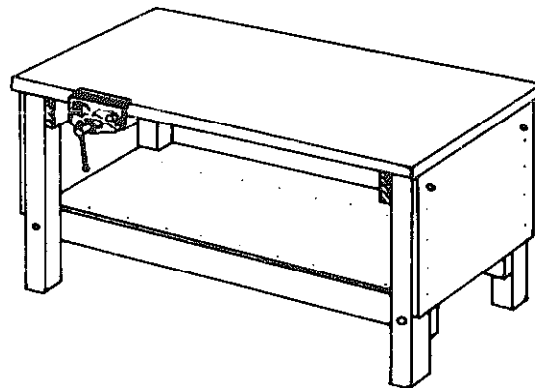

Free-standing work bench

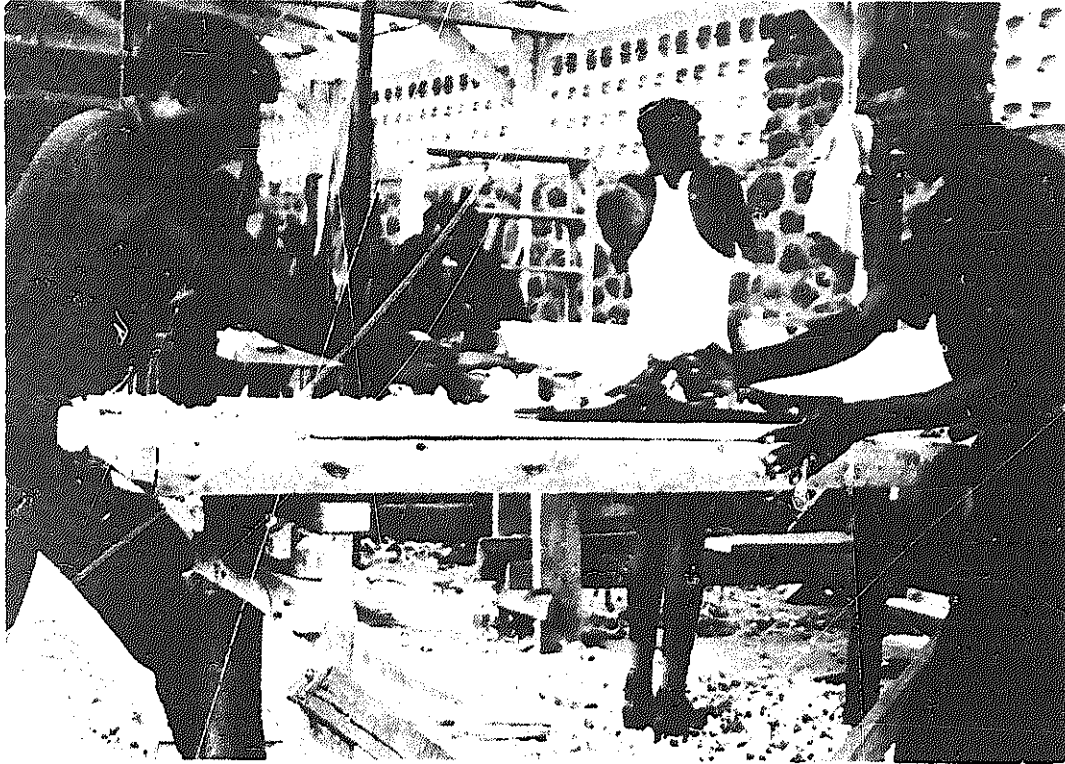

Watutsi refugees – formerly cattle-herders – learning carpentry skills under ILO guidance at the Kayongozi Refugee Centre in Burundi. (Photo: ILO).

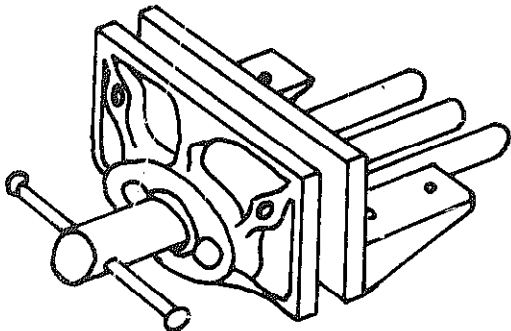

Cast iron woodworking bench vice

Woodworking vice (Cast iron bench vice with 200mm wide jaws)

Various types of vice can be used to hold the wood firmly when working. The most convenient is the bench-mounted screw vice. All-wooden screw vices can be obtained, but most modern vices are made from cast iron. The cast iron vice can easily be broken if roughly handled. A modern vice can be obtained with a quick opening action at extra cost.

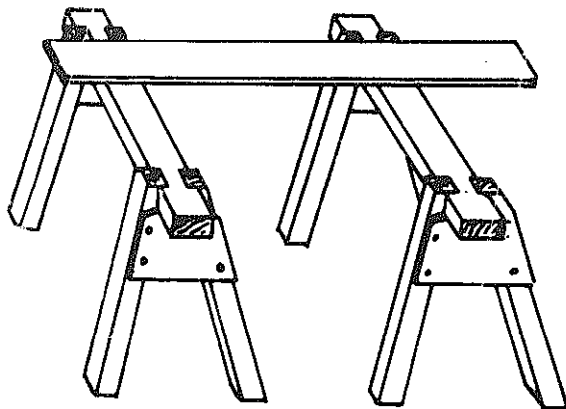

Sawing horses

Sawing horses (pair)

These are used to support planks while they are being cut with a hand saw. They can be made in the workshop.

Cross cut hand saw with 700mm blade

This is used to cut across the grain.

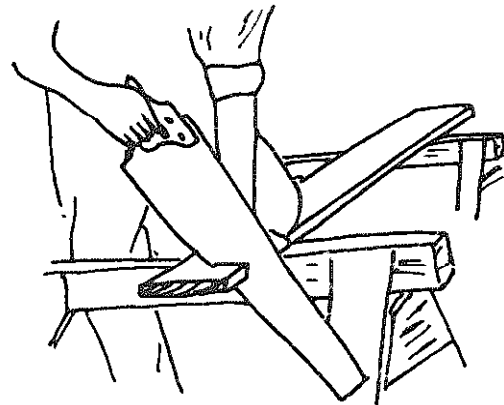

Cutting across the grain with a cross cut hand saw

Bow type log saw

This bow log saw has a tubular steel frame and large teeth. It is suitable for sawing newly-felled timber.



Bow type log saw

Rip hand saw with 800mm blade

This is used to cut along the line of the grain.

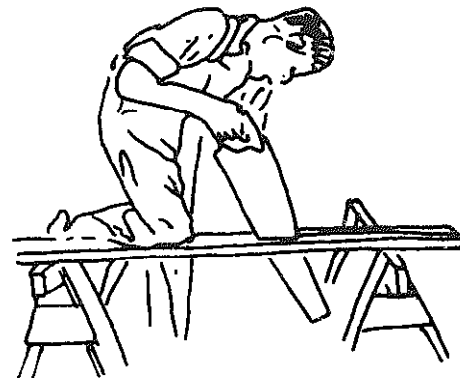

Cutting along the grain with a rip hand saw

Tenon saw (300mm blade)

The tenon saw has a strengthening piece along the back of the blade to keep it rigid. It is used for accurate work cutting across the grain.

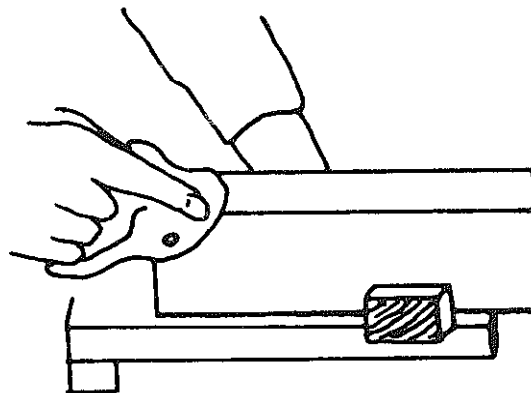

Cutting across the grain with a tenon saw

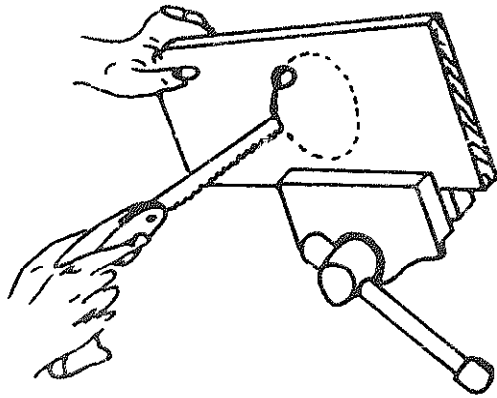

Cutting a large circular hole in a plank with a compass saw, starting from a small drilled hole

Compass saw (300mm blade)

Narrow bladed saws are used to cut along curved lines. The compass saw can be used to cut holes in the middle of large pieces of wood because its blade is self-supporting. The compass saw usually has fairly large teeth.

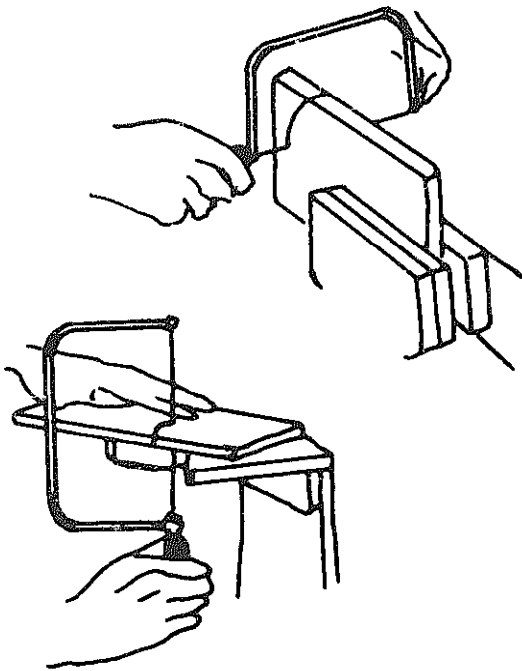

Sawing along curved lines with a coping saw

Coping saw (200mm blade)

The coping saw has small teeth and is particularly suitable for cutting thin boards and plywood.

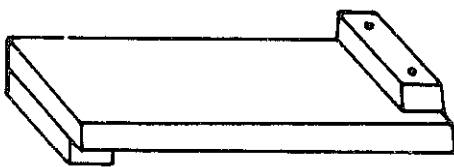

Bench hook

Bench hook

The bench hook is used to hold small pieces of wood on top of the bench while they are being cut with a tenon saw. It can easily be made in the workshop from wood.

Mitre box

This is used to guide the blade of a tenon saw when cutting off wood accurately at 90° or 45° . A wooden mitre box can be made in the workshop, but will wear fairly quickly and lose its accuracy. Factory made mitre boxes are either all-metal or of wood with metal guides for the saw blade.

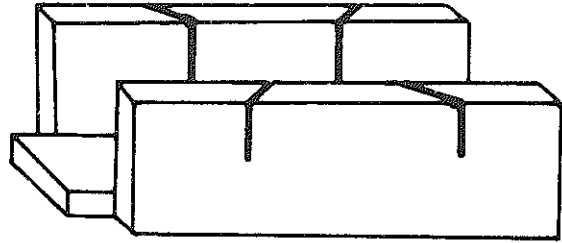

Mitre box

Felling axe

A felling axe is used for cutting down trees.

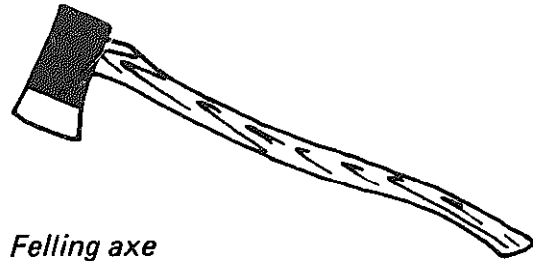

Felling axe

Hand axe

A small hand axe is useful for roughly shaping pieces of wood.

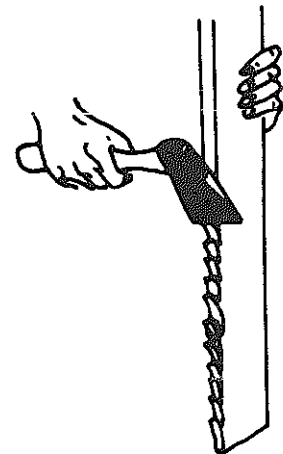

Hand axe

Drawknife

This is used for shaping curved or tapered surfaces.

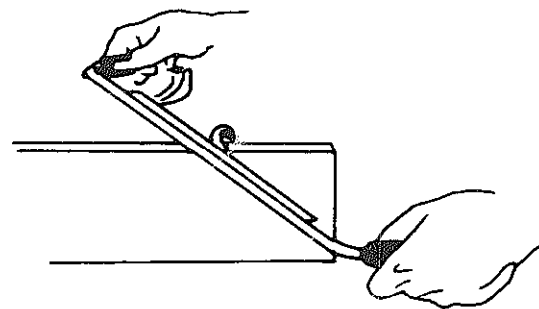

Drawknife



Wood rasp with perforated blade



Wood rasp – solid type

Wood rasp *either* solid, half round, *or* with interchangeable flat and half round perforated blades.

A rasp can often be used instead of a plane. It is cheaper, and less skill is needed to use it. The older type of wood rasp is of solid construction. Many modern rasps have replaceable blades with perforations through which the cut shavings can pass.

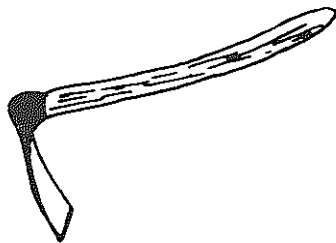

Adze

Adze

Often the very smooth surface left by a plane is not necessary and an adze is cheaper, simpler and faster to use.

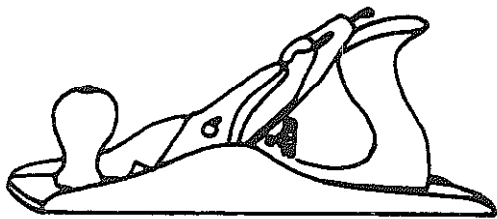

Iron jack plane

Jack plane (350mm long)

Planes can be made of wood or metal. The modern cast iron plane is much easier to adjust, but it will break if dropped from the bench onto a stone or concrete floor. Wooden planes can be made or repaired by a skilled carpenter. Long planes are used to make very straight edges and short planes to smooth out minor irregularities.

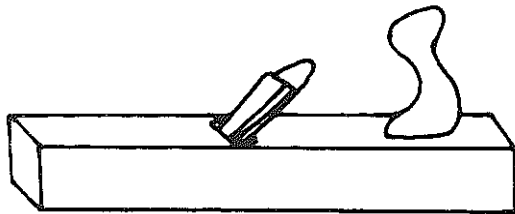

Wooden jack plane

Claw hammer (0.5kg)

The claw hammer can be used both for driving nails and for pulling them out.

Claw hammer

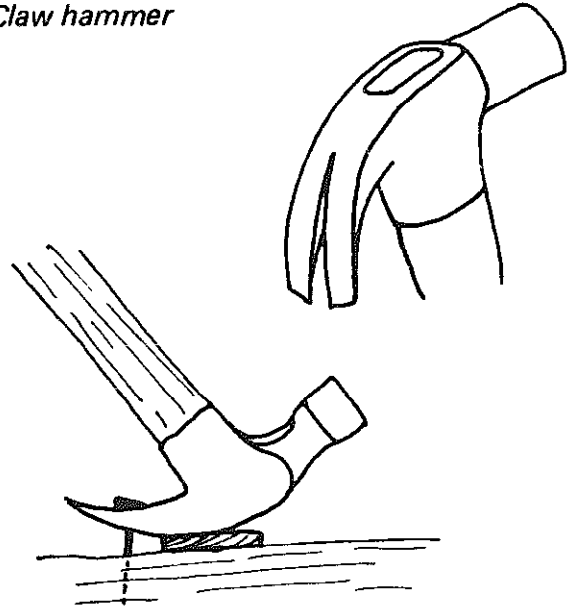

Square edged firmer chisels (5mm wide blade, 25mm wide blade)

Chisels to be used with hand pressure only can be either square edged or bevel edged. Bevel-edged chisels are useful for making some types of joints, but are more easily broken. The square edged types are better for general work.

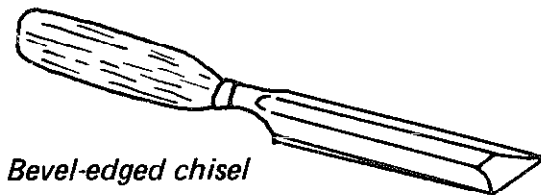

Bevel-edged chisel

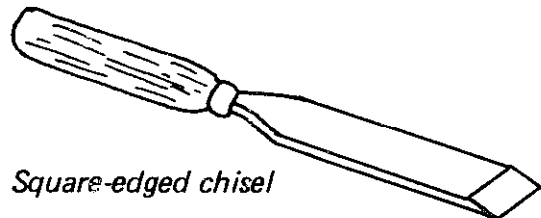

Square-edged chisel

Mortice chisel (5mm wide)

Mortice chisels are much more strongly made so that they can be hit with a mallet when slots (mortices) are cut through boards.

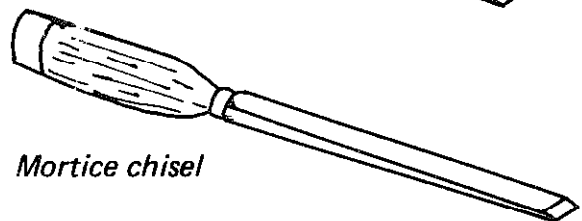

Mortice chisel

Wooden mallet

A wooden mallet is used for driving mortice chisels and for fitting tight wood joints. A mallet can be made in the workshop.

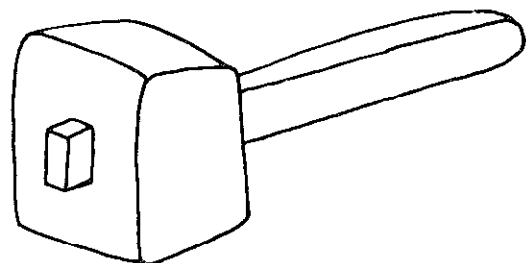

Wooden mallet

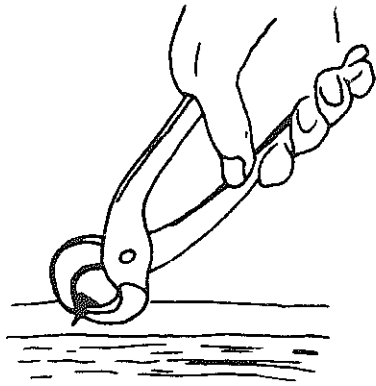

Using pincers to remove a nail

Pincers with 150mm long handles

These are used for removing nails from wood.

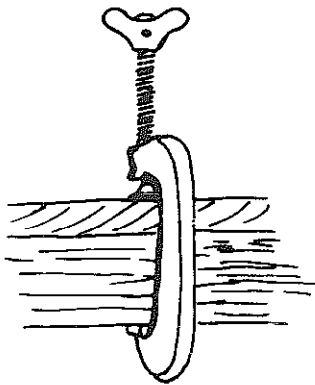

G-cramp

G-cramps (two, 300mm long)

These are used to hold pieces of wood together while they are being glued, drilled or sawn.

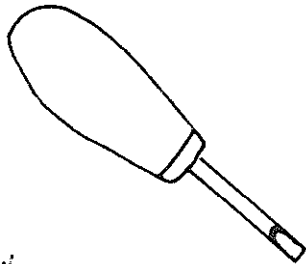

Bradawi

Bradawl (2mm wide blade)

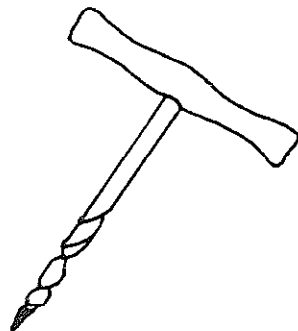

Gimlet

Gimlet (3mm diameter)

Very small holes can be made with a bradawl or gimlet.

Carpenter's ratchet brace

Auger bits (5mm, 10mm, 15mm, 25mm)

The carpenter's brace can be either fixed or ratchet drive type. The ratchet brace is useful for making holes in confined spaces. The brace is used with drill bits having a square section tapered shank. The most common wood drilling bits are of the auger type.

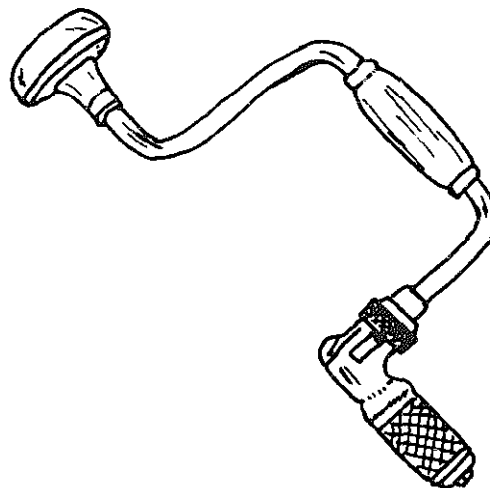

Carpenter's ratchet brace

Expanding bit for holes from 15mm to 30mm diameter

Expanding bits can be adjusted to make different sized holes after loosening a screw which locks the cutting point in position.

Countersink bit

This is fitted in the brace for countersinking (making depressions in wood for screw heads).

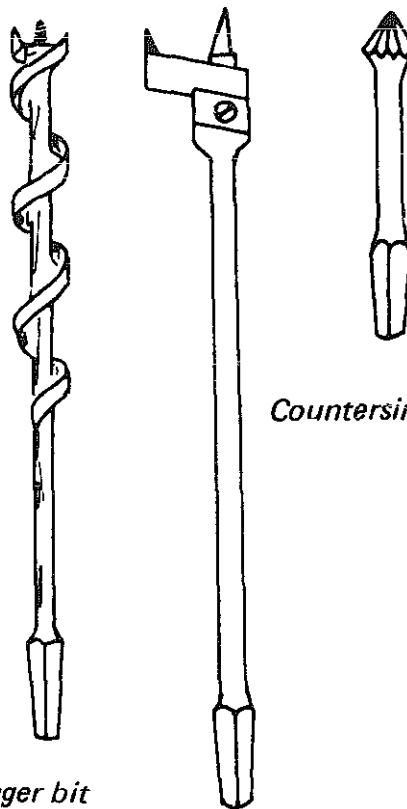

Auger bit

Countersink bit

Expanding bit

Screwdrivers

(150mm long, 3mm wide blade)
(250mm long, 5mm wide blade)



Screwdriver

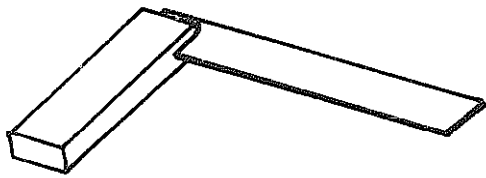

Set square

Set squares (200mm, 500mm)

Small set squares usually have one thin metal blade and the other member is thicker and made of wood or metal. Large set squares are made from one piece of metal and have measurements scribed on them.

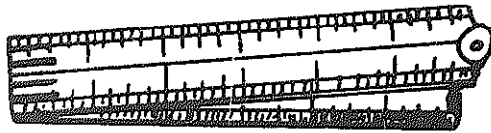

Folding wooden rule

Rule (1m folding)



Metal roll-up tape

Tape (2m metal roll-up tape)

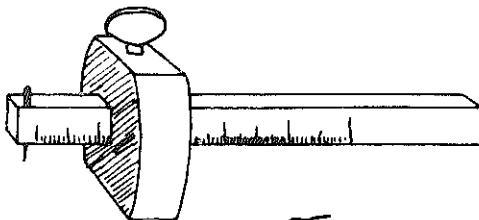

Marking gauge

Marking gauge

Marking gauges are used to mark out lines parallel to the edge of a piece of wood. A mortice gauge is similar, but has two scribes to mark a double line.

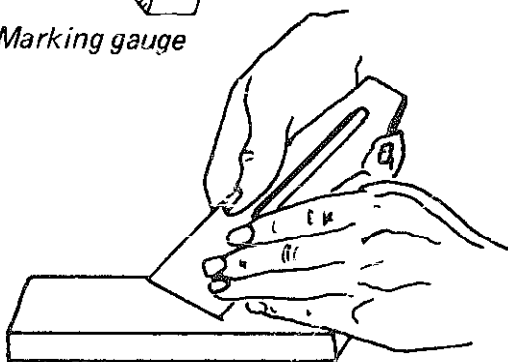

Sharpening a plane blade on an oil stone

Carborundum oil stone with coarse and fine grit sides 200mm long and 50mm wide

Oil stones are used for fine sharpening of the blades of planes, chisels spoke-shaves etc. Natural stones are occasionally used, but manufactured carborundum stones are most popular.

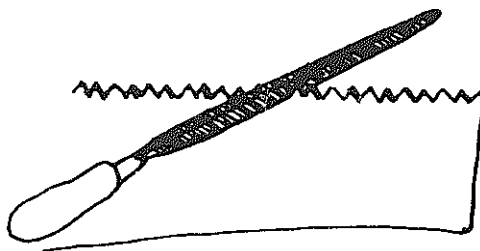

Triangular file (100mm long)

Very small files are used to sharpen auger bits. Small files are also needed if the carpenter sharpens his own saws.

Sharpening an auger bit using a small file

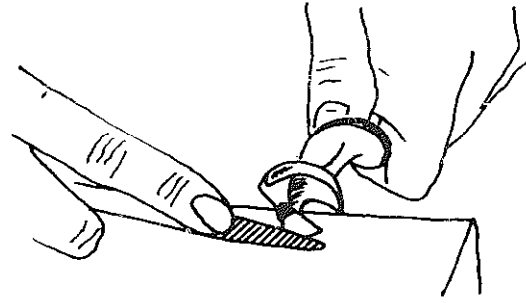

Grinding wheel, either hand or treadle operated with carborundum or sandstone wheel

Sharpening saw teeth using a small triangular file

There are three types of manually operated grinding wheel suitable for tool sharpening:

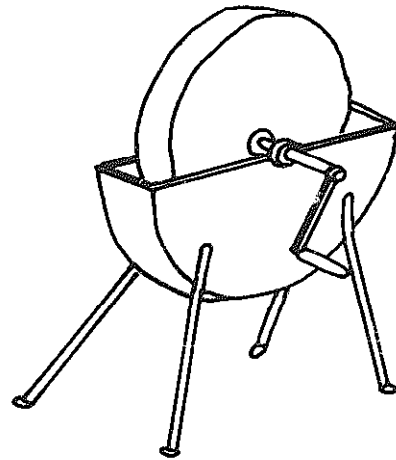

- 1) Large diameter sandstone wheel, either hand or treadle operated.
- 2) Small diameter hand turned, gear driven, carborundum wheel.
- 3) Small diameter, vertical axis carborundum wheel driven by ratchet treadle mechanism.

Any of these is suitable for sharpening carpenter's tools.

Large diameter, hand turned, sandstone grinding wheel

Goggles

Goggles must always be worn to protect the eyes from flying pieces of grit or metal when grinding is done.

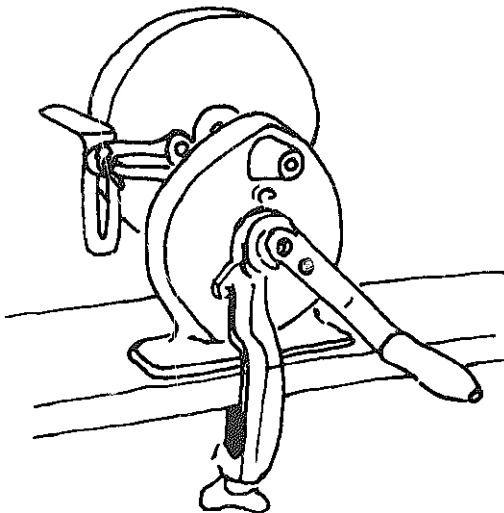

Small diameter, hand turned, carborundum grinding wheel

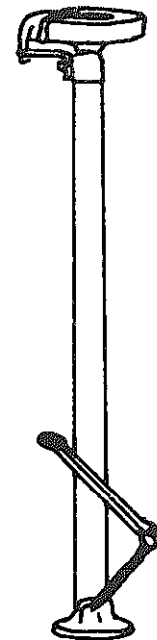

Small diameter treadle operated carborundum grinding wheel

Basic Metalworking Equipment (for 1-2 man workshop without power supply)

It is assumed that the craftsman would make his own work bench and forge. Prices in the United Kingdom in mid-1977 would be approximately £70 for the anvil, £60 for the leg vice and a further £150 for the other items listed.

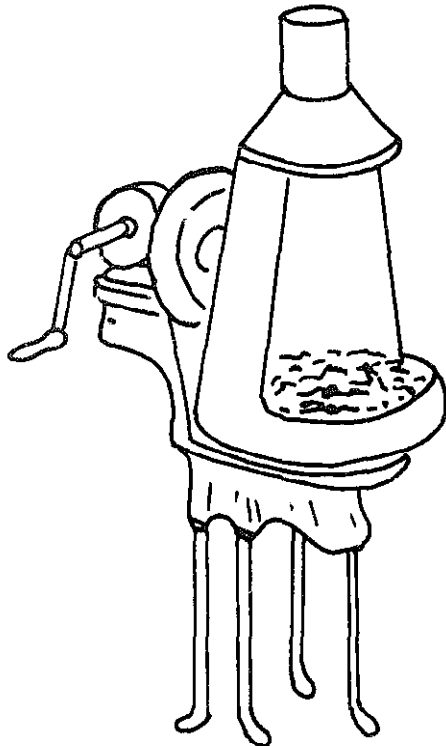

Forge, 700mm above ground level

Traditional forges in developing countries often have bellows made from goat skins. If carefully made, these can be very efficient. Traditional forges are usually set at ground level. If the anvil is to be raised for use in the standard position, then the forge should be at the same height so that hot metal can be quickly taken to the anvil. The traditional forge could be mounted on top of an earth mound. Western type forges usually have either concertina-type leather bellows or a rotary fan to provide the draught. These are often arranged so that the blacksmith himself can work the bellows but this may not be an advantage in countries where there is plenty of labour. Some forges are portable and can be taken and used away from the workshop when necessary.

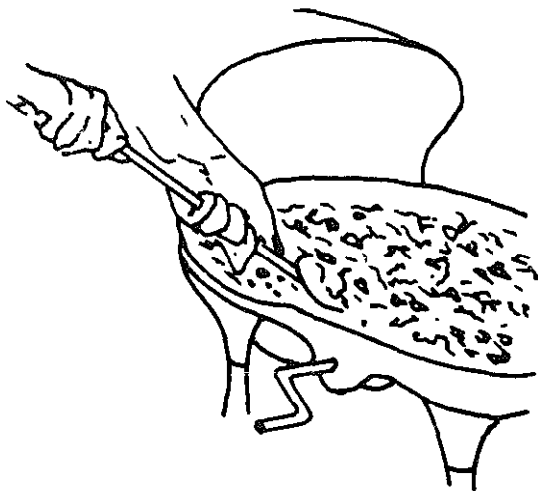

Factory made forges with rotary fans

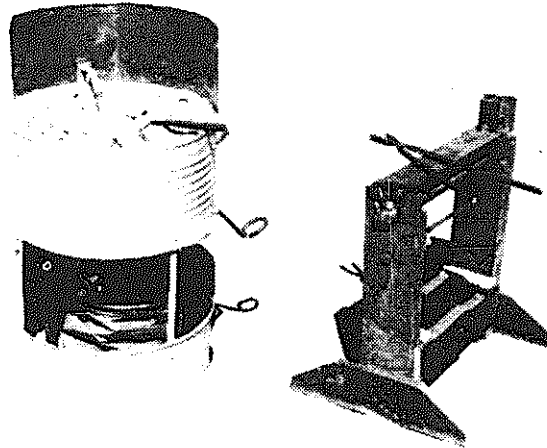

Oil drum forge designed by ITDG, and anvil. (Photo: ITDG).

Anvil, "London" pattern, minimum weight 70kg mounted on wooden or iron stand

The simplest anvil is a large, hard stone on the ground. Another type often seen is a length of round iron bar, approximately 150mm diameter, sunk vertically into the ground. A heavy piece of scrap metal, such as an old cast iron lorry engine block, is sometimes used. It is much easier to strike heavy, accurate blows while standing up, therefore it is best to have the anvil mounted well above the ground. Ideally the anvil should be of such a height that the blacksmith can just place his clenched fist on top of it when standing up. An anvil for light work can be made from a length of railway line mounted in a wooden stand. The most useful anvil is the "London" pattern. It is made in sizes weighing from 20kg to 150kg. This type of anvil is expensive to transport. An anvil weighing about 70kg is suitable for most purposes. Ideally it should be mounted on a tree trunk

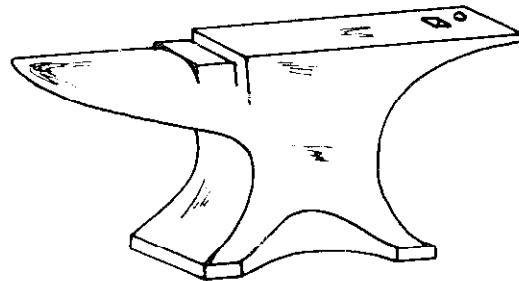

"London" pattern anvil

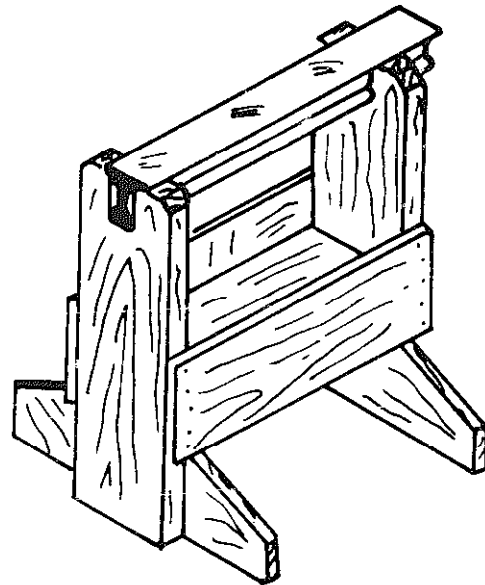

Anvil made from railway line

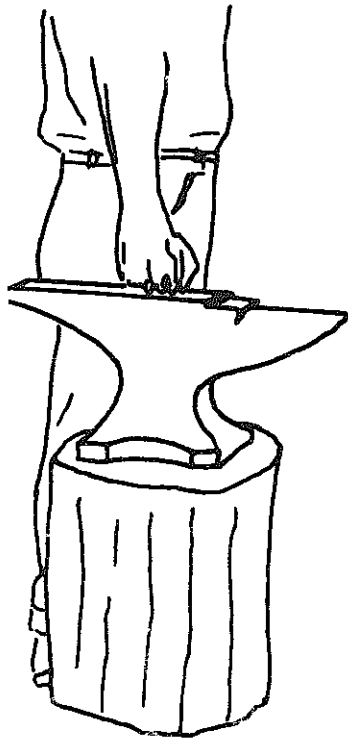

Correct height for an anvil

which is sunk into the ground to a depth of at least 1m, but it can be mounted on an angle iron stand.

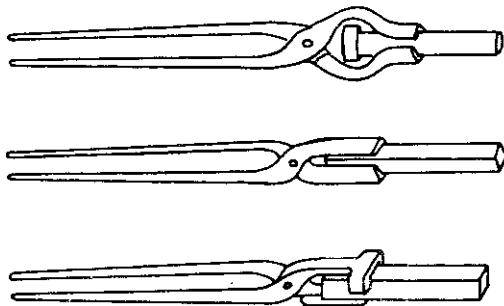

Blacksmith's tongs

Tongs

(for flat bars up to 25mm thick)
(for round bars up to 25mm diameter)

Various shapes of blacksmiths' tongs are available for holding hot metal. These can be made in the workshop by a skilled blacksmith.

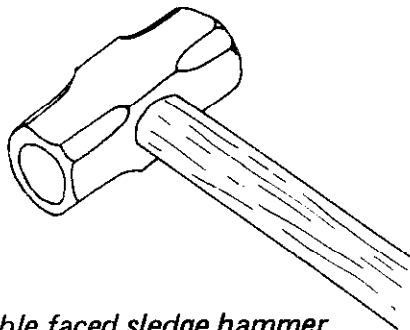

Double faced sledge hammer

Sledge hammer, double faced 3kg

Ball pein hand hammer 1 kg

Hammers can be divided into sledge hammers, used with both hands by the blacksmith's assistant, and hand hammers which the blacksmith holds in one hand.

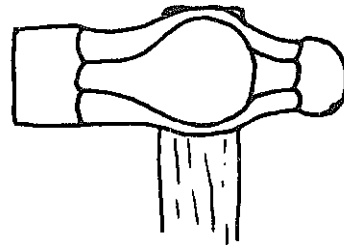

Ball pein hammer

Cold chisels

(Flat chisels – 10mm wide, 25mm wide)

(Slitting chisel)

The most common type is the flat chisel, although cross cut, diamond point, half round and slitting chisels are sometimes used. The slitting chisel is useful for cutting out sections of sheet metal from oil drums, etc.

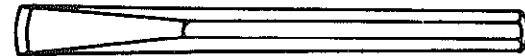

Flat chisel

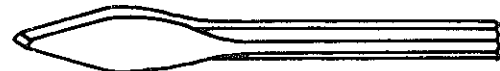

Cross cut chisel

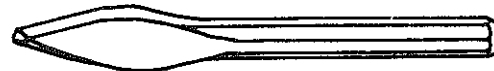

Half round chisel

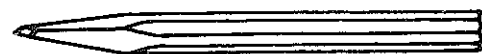

Diamond point chisel

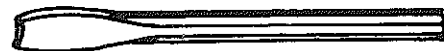

Slitting chisel

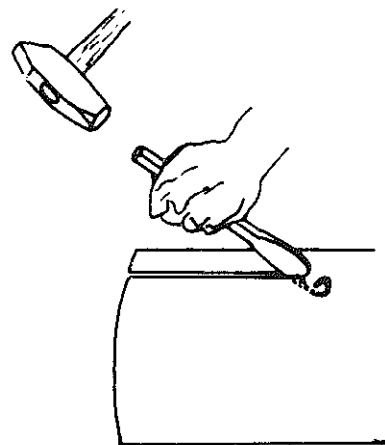

Using a slitting chisel

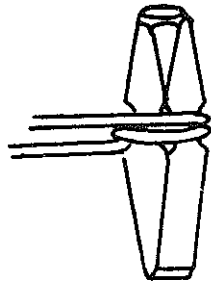

Cold set with steel rod handle

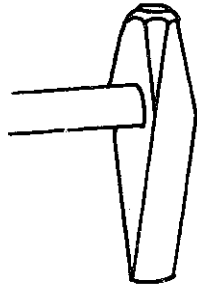

Hot set with wooden handle

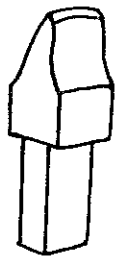

Hardie

Hot chisel (25mm)

Hot chisels are used to cut red hot metal and do not have to be as sharp as cold chisels.

Cold set (40mm with steel rod handle)

Cold sets are used like cold chisels, but hit with a sledge hammer. The sets are fitted with handles, sometimes wooden shafts as on hammers, but usually made of steel rods.

Hot set (40mm with wooden handle)

Hot sets are used like hot chisels, but hit with a sledge hammer.

Hardie (40mm to fit square hole in anvil)

This is a chisel fitted into a hole in the anvil with its cutting edge at the top.

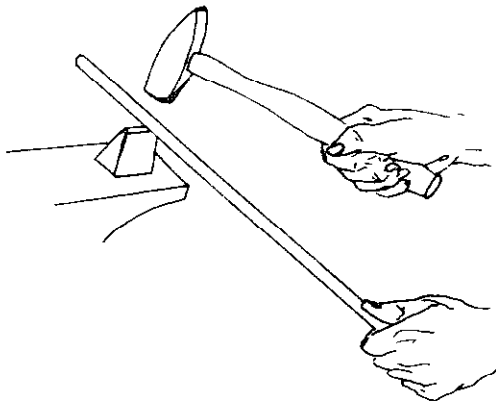

Cutting a steel bar using a hardie

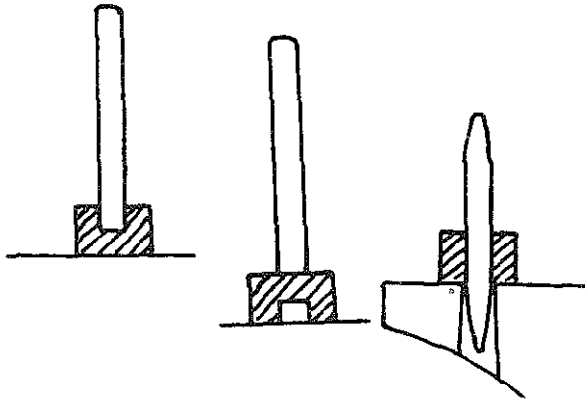

- (i) *Punching a hole half way into a red hot steel bar*
- (ii) *Inverting the bar to punch the hole through*
- (iii) *Hammering a drift through the punched hole to enlarge and smooth it*

Hot punches (set of three for holes from 5mm to 20mm diameter)

These are hammered through red hot metal to make holes. They may be round, square or any other shape depending on the shape of hole required.

Drifts made in the workshop as required

Drifts are tapered pieces of steel which are hammered through punched holes to enlarge and smooth them.

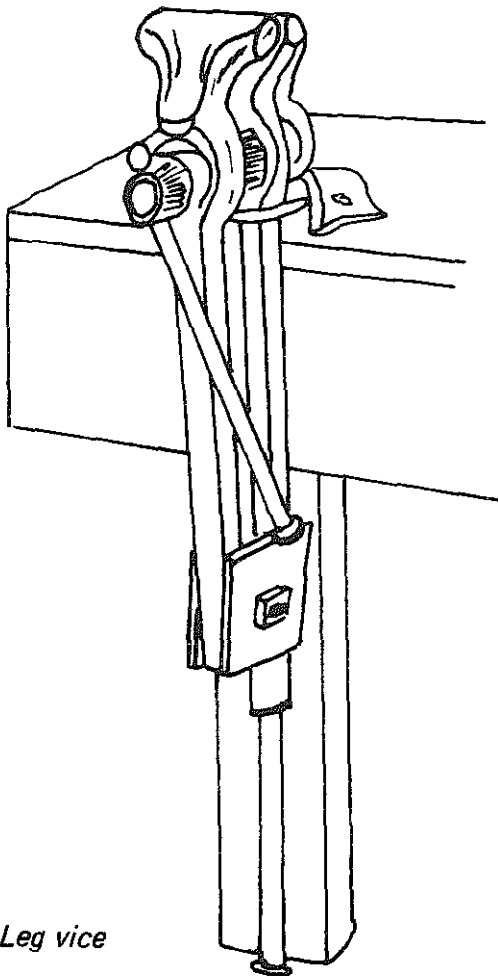

Leg vice

Work bench (800mm high, 650mm wide and 2500mm long)

Work benches for metal work are made in the same way as wood working benches. It is better not to use the same bench for both wood and metal work, because metal splinters will become embedded in wood and damage the woodworking tools.

Leg vice (or solid box vice with 150mm wide jaws)

Leg vices are made of steel and have a leg going down to the workshop floor. They can be used for heavy hammering and bending. The jaws do not have parallel movement and therefore cannot always grip parallel-sided work firmly.

Wire frame (Junior) Hacksaw

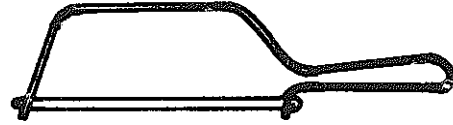

Small wire frame hacksaw

Hacksaw frame for standard 300mm blades

The smallest hacksaws have a spring wire frame which holds the blade in tension. Larger hacksaws have blades which are tensioned by a wing nut. Fine toothed blades are used for thin sheet metal and thin-walled pipe, while coarse toothed blades are faster for work on thicker pieces of metal.

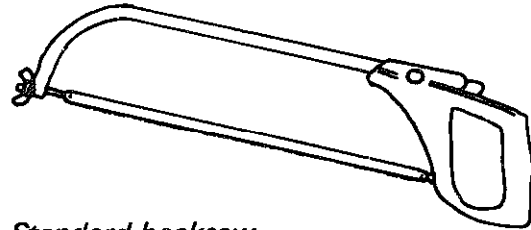

Standard hacksaw

Tin snips

- Straight blade 200mm
- Straight blade 300mm
- Curved blade 200mm

These are used for cutting thin sheet metal (less than about 1mm thick). Various sizes are available with straight or curved blades.

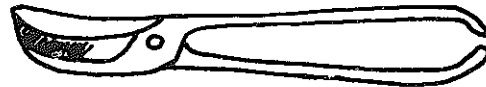

Tin snips

Files

- Flat 250mm second cut
- Triangular 150mm smooth
- Half round 250mm bastard
- Round 150mm second cut

Various lengths and shapes are manufactured in the following grades of roughness: rough, bastard, second cut, smooth, dead smooth. The most common are bastard, second cut and smooth.



Flat file



Triangular file



Half round file

Breast drill with 12mm capacity chuck

The breast drill is made for use with bits having straight shanks up to 12mm diameter. The weight of the user's body helps to push the drill against the work.

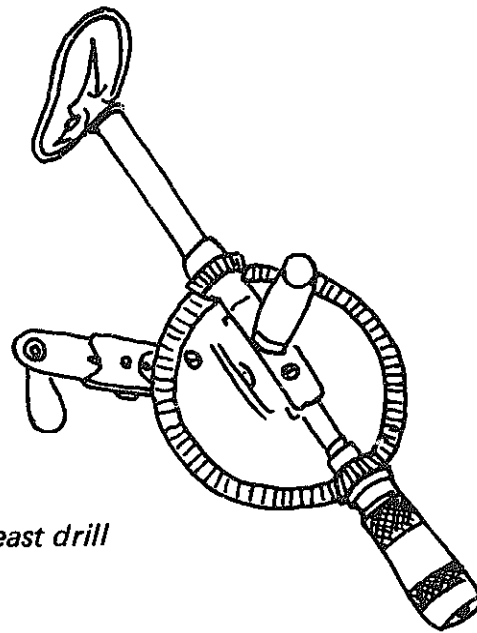

Breast drill

Set of twist drills from 2mm to 12mm diameter

These are frequently kept in a drill stand.

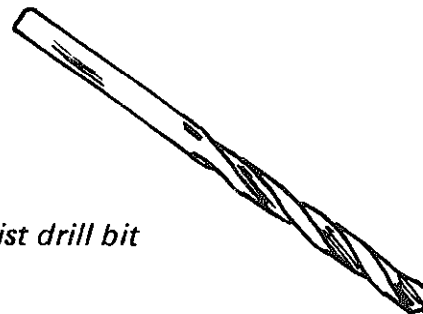

Twist drill bit

Centre punch

A centre punch is used to make a mark in which a drilled hole can be started.

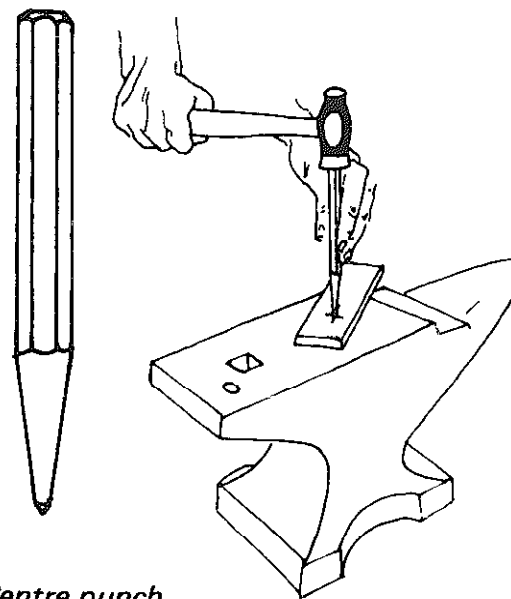

Centre punch

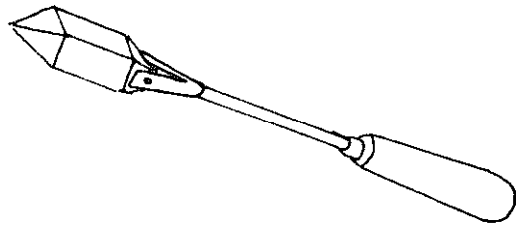

Soldering iron

Soldering iron (1kg straight type)

A soldering iron must hold a lot of heat and for fairly large jobs one with a 1kg copper bit is suitable.

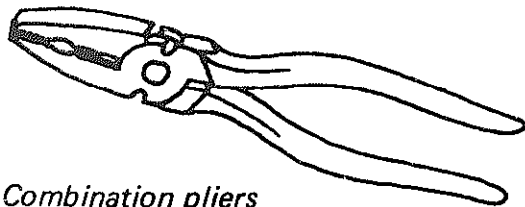

Combination pliers

Combination pliers (200mm long)

Various shapes of pliers are available but the standard type are called combination pliers and can be used for gripping and wire cutting.

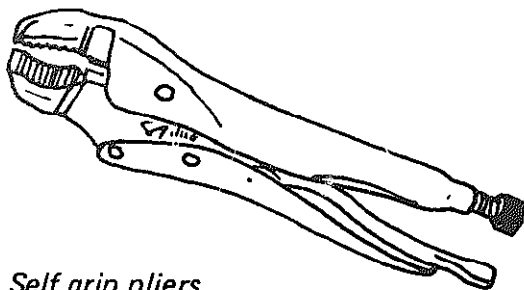

Self grip pliers

Self grip pliers (200mm long)

These can be used as an emergency spanner where the correct size is not available or to grip a damaged nut; to grip round bars, studs or small pipes; and to clamp two pieces of metal together.

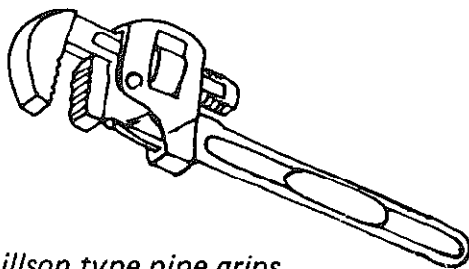

Stillson type pipe grips

Stillson type pipe grip (450mm long)

Pipe grips are essential if much pipe work is done. In a general purpose workshop a Stillson type pipe grip 450mm long is very useful.

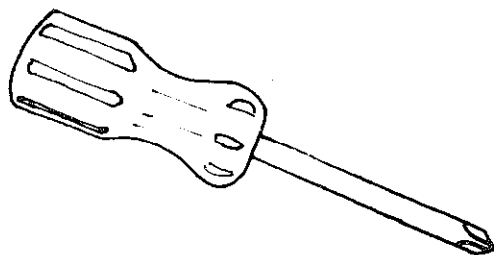

Cross point screwdriver

Screwdrivers

- 150mm long, 3mm wide
- 250mm long, 5mm wide
- 200mm long, cross point

Cross point screwdrivers are often necessary for repairs to mass-produced goods.

Set of open ended spanners to fit the nut sizes most common in the locality.

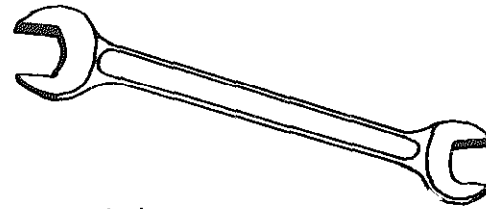

Open ended spanner

Adjustable spanner

Many different types of spanners are available. The size of spanners are specified in different ways according to the origin of the nuts and bolts they are used on. In a workshop it may be necessary to have a set each of:-

- 1) British (spanner marked by the diameter of the appropriate bolt, i.e. a $\frac{1}{4}$ inch B.S.W. spanner fits the nut on a $\frac{1}{4}$ inch diameter B.S.W. threaded bolt) used on most British equipment made before 1955.
- 2) A/F (spanner marked with width of nut across the flats in inches). Used on American and Canadian equipment and on most British equipment made after 1955.
- 3) Metric (spanner marked with width of nut across flats in millimeters). Used on equipment from continental Europe and on some recent British equipment.

If the workshop does a lot of motor vehicle repair work, then a wide selection will be necessary, otherwise a set of open ended spanners to fit nuts from approximately 5mm to 25mm measured across the flats and one adjustable spanner 250mm long will be adequate.

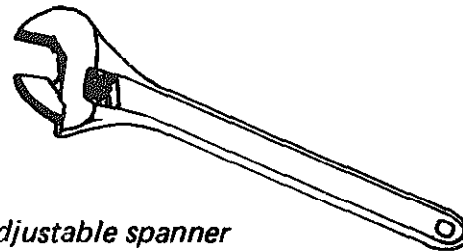

Adjustable spanner

Scriber

Metal surfaces are marked out with a steel scriber.

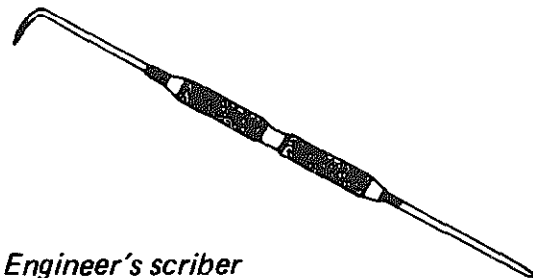

Engineer's scriber

Set squares (200mm, 500mm)

As described under woodworking equipment.

Hand or treadle operated carborundum wheel

Carborundum wheels as described on page 34 are used to sharpen metal working tools.

Steel rule (300mm)

Rules for cold metal work are normally made of steel to resist damage from the scriber.

Brass rule (500mm)

Blacksmith's rules should be made of brass to prevent rusting in the heat, steam and sulphurous fumes.

Section 4:1

Additional useful Woodworking Equipment (for 1-2 man workshop without power supply)

The equipment listed in this section would cost about £100 in the United Kingdom in mid-1977 and would supplement the equipment listed in Section 3.1.

Two man log saw (1.5m long)

This is for cutting across large tree trunks.

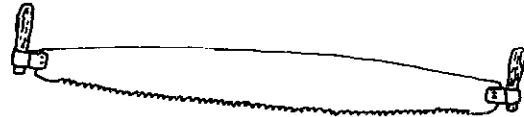

Two man log saw

Bow saw

The bow saw tensioned by a twisted rope (not to be confused with the tubular framed bow type log saw) can be used to cut along curved lines. It is faster than the coping saw and easier to control than the compass saw.

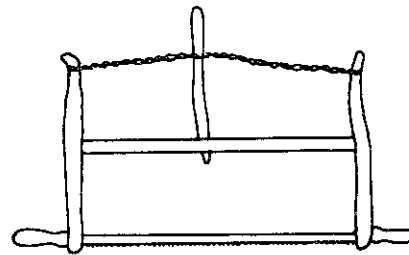

Bow saw

Spring saw set

A spring saw set can be used like a pair of pliers to apply the correct "set" or lateral displacement to saw teeth.

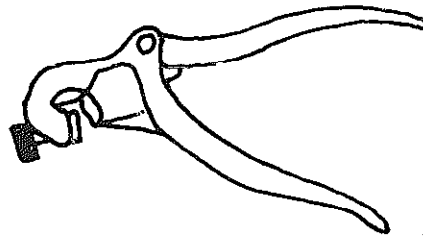

Spring saw set

Block plane (150mm long)

This is particularly useful for cutting across the end grain of planks.

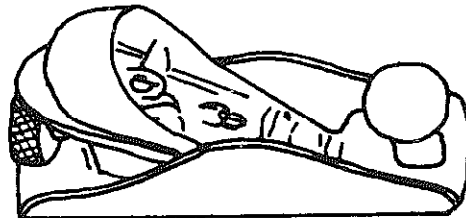

Block plane

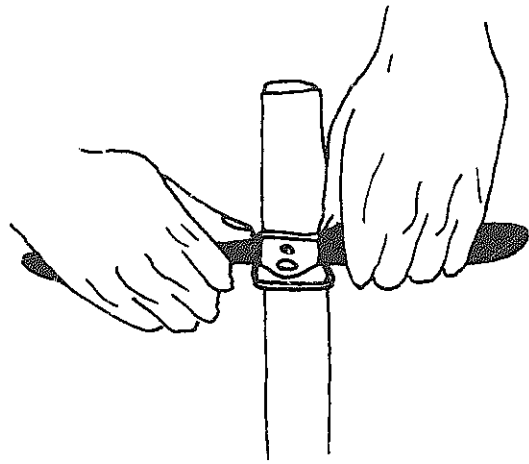

Spokeshave

Spokeshave

This is used for smoothing curved and irregular surfaces.



Cross pein hammer

Cross pein hammer (0.1kg)

This is useful for driving small nails.

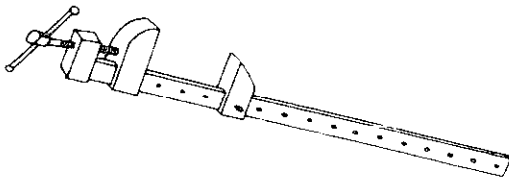

Bar-mounted clamps

Bar mounted clamps (2m long)

Square edged chisels (10mm wide, 15mm wide)

Additional sizes of chisel enable some work to be done faster.

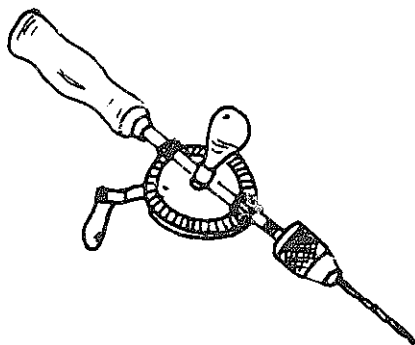

Hand drill

Mortice chisel (10mm wide)

Hand drill (with 6mm capacity chuck)

The hand drill is useful for making small holes and is faster than the brace. It is used with straight shank drill bits and a typical hand drill has a chuck for holding bits with shank diameters up to 6mm.

**Set of straight-fluted bits or twist bits
(from 1mm to 6mm diameter)**

The most suitable bits for drilling wood are straight-fluted bits. Twist bits are more generally available and can also be used to drill metal, but tend to become clogged up with wood particles.

**Breast drill (with 12mm capacity
chuck)**

As described on page 30.

**Set of flat drill bits (for 10mm, 15mm,
20mm, 25mm diameter holes)**

Small holes are drilled with straight-fluted or twist drills. Larger holes can be made with flat drill bits.

**Hand operated post drill (with 12mm
capacity chuck)**

Most hand operated post drills can hold drill bits with shanks up to 12mm diameter, although larger sizes are available. The pressure on the drill bit is applied automatically and is adjustable. Vertical holes can be drilled accurately with a post drill.



Straight fluted drill bit



Flat drill bit



Flat drill bit

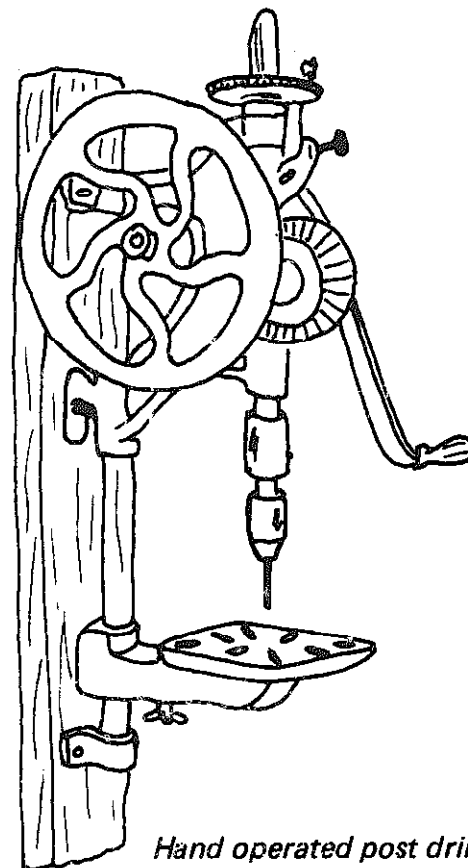

Hand operated post drill

Additional useful Metalworking Equipment (for 1-2 man workshop without power supply)

The equipment listed in this section would cost in the United Kingdom in mid-1977 about £300 of which £150 would be for the oxy-acetylene welding set. It would supplement the equipment listed in Section 3.2.

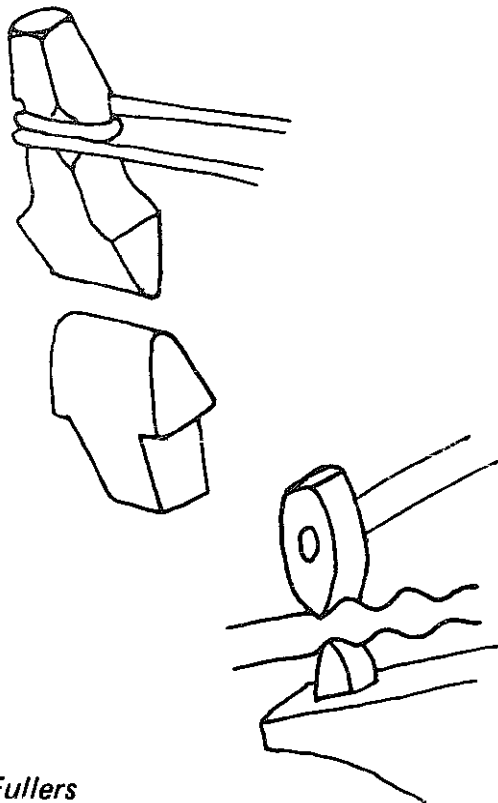

Fullers (12mm radius)

These are like blunt nosed chisels and are used to reduce the thickness of hot metal. They may be hand held or fitted with a rod handle. Bottom fullers may be inserted in the square hole of the anvil. For occasional use, fullers can be improvised from round mild steel bar.

Fullers

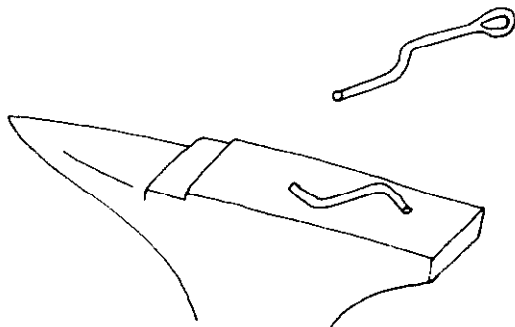

Fullers improvised from mild steel rod

Flatter, (50mm square face)

Flatters are used under a sledge hammer to flatten and smooth metal, particularly after its thickness has been reduced using fullers.

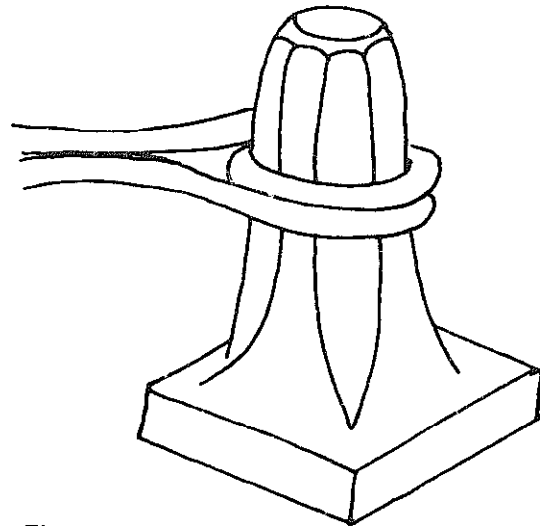

Flatter

Swages (10mm and 25mm diameters)

These are used in pairs to shape hot metal. The bottom swage is placed in the square hole of the anvil and the top swage is hit with a sledge hammer.

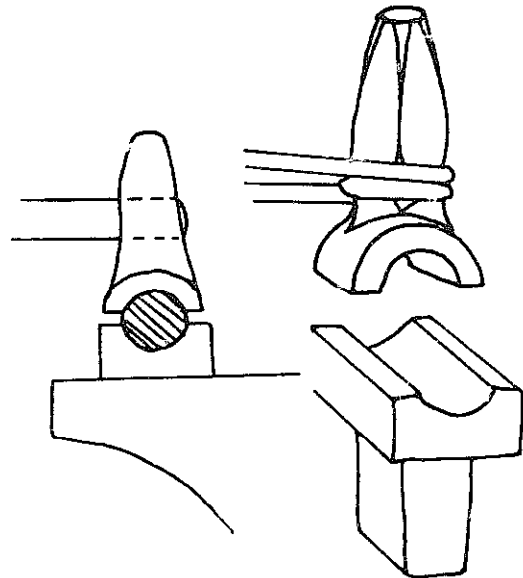

Swages

Bench vice (steel or cast iron, with 150mm wide jaws)

Steel bench vices are strong enough to hold metal while it is bent or hammered, but all forces have to be taken by the bench top. The jaws have parallel movement and grip the work firmly. Steel bench vices are expensive. Cast iron bench vices are intended for careful fitting work. They are not suitable for heavy hammering and bending, are easily broken if roughly treated and are very difficult to repair. The jaws have parallel motion and are often provided with quick opening action. Cast iron vices are much cheaper than similar-sized steel vices.

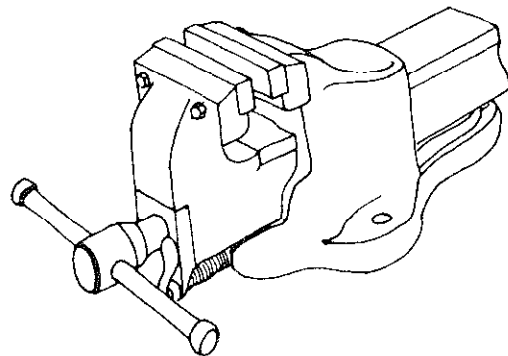

Cast iron bench vice

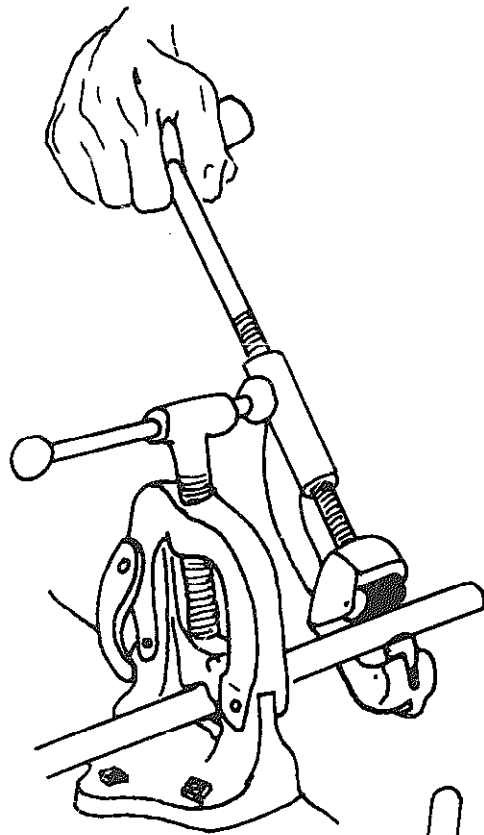

Pipe vice and pipe cutters

Pipe vice (with 75mm diameter capacity)

Pipe vices are only used when cutting and threading pipes. They are usually mounted on a portable tripod.

Pipe cutters (for pipes up to 75mm diameter)

These enable pipes to be cut easily and quickly at right angles by unskilled operators. They are usually used together with a pipe vice. They are essential if a lot of plumbing or pipe work is done in the workshop.

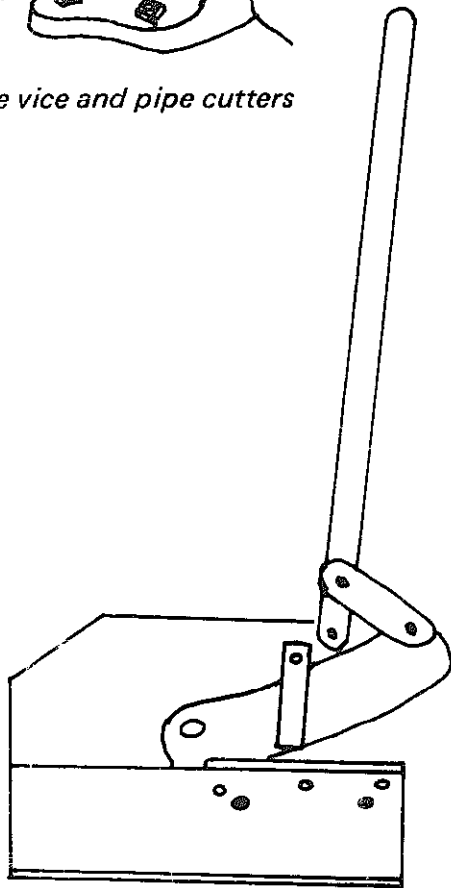

Guillotine

Guillotine (with 250mm long blades)

A lever operated guillotine is very useful if the workshop has to cut large quantities of sheet metal of 1-3mm thickness, which is too thick to cut with hand shears and too flexible for easy hacksawing.

Hand drill (with 6mm capacity chuck)

Hand operated post drill (with 12mm capacity chuck)

Ratchet brace and twist drill bits from 12mm to 25mm

Large holes can be drilled by hand using a ratchet brace. This is slow, but is the only means of drilling large holes in metal without using power drills. Large drill bits are expensive and for very occasional holes it may be better to punch them using blacksmithing methods or to drill a ring of small holes and file these out into a smooth large hole.

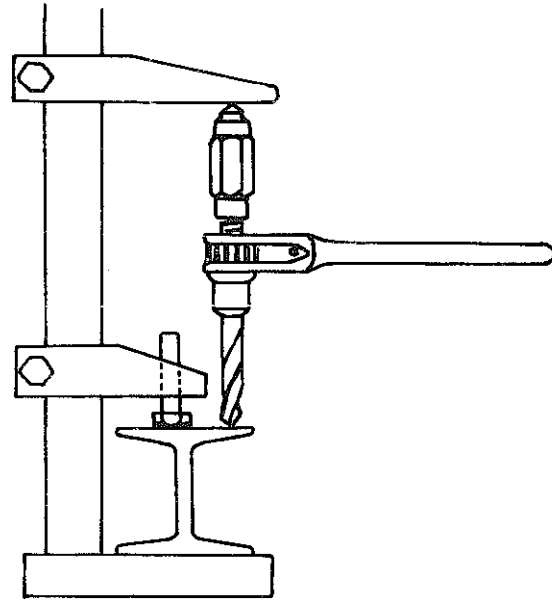

Engineer's ratchet brace

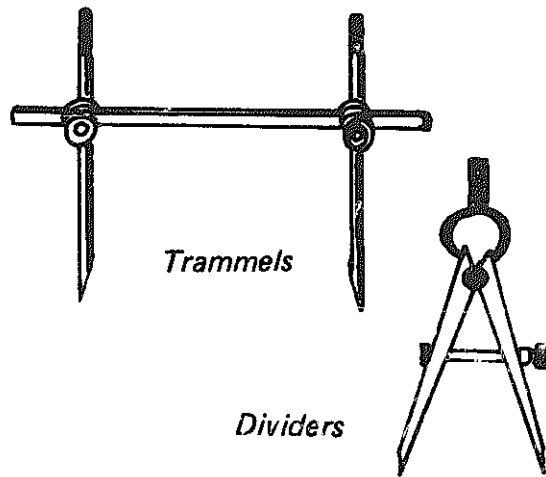

Trammels

Dividers

Dividers

Dividers are used to mark out circles on metal surfaces. Larger circles are marked out with trammels.

Bevel

A bevel can be set to any angle and used in the manner of a set square to check angles other than 90°.

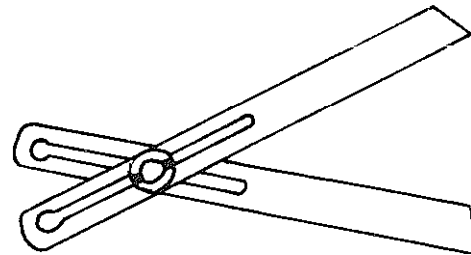

Bevel

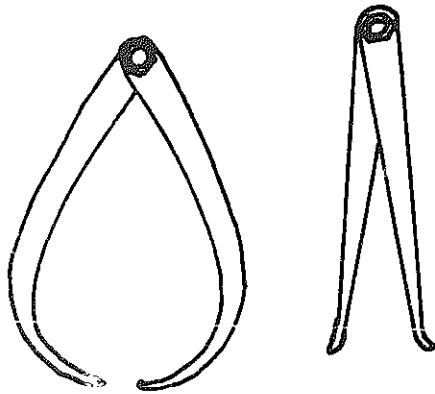

External calipers

Internal calipers

Calipers

Calipers are used to measure internal and external diameters of circular parts.

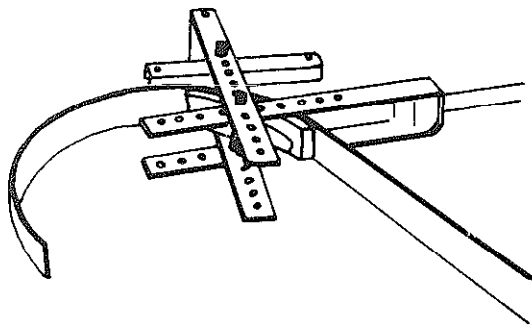

Lever type bender being used to make an ox cart wheel rim from flat steel bar

Metal bending equipment. Occasional bending work can be done using blacksmithing equipment. Pipes can be prevented from kinking by filling them with sand and plugging the ends before heating and bending. Thin sheet metal can be bent if held between two lengths of iron (see illustration). For longer lengths, one angle iron can be fitted permanently to the work bench and another bolted to it to clamp the sheet metal. Special sheet metal folding machines are manufactured commercially.

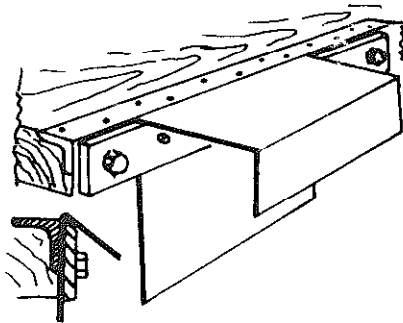

Simple bench fitting for folding sheet metal

Sheet metal folder made from angle iron bolted to bench

Lever operated bender

Bar and pipe bending equipment is usually operated either by a long hand lever, by a screw mechanism or by a hydraulic ram. Flat bars can be bent around simple formers, but special formers must be used with pipes to prevent kinking on tight bends.

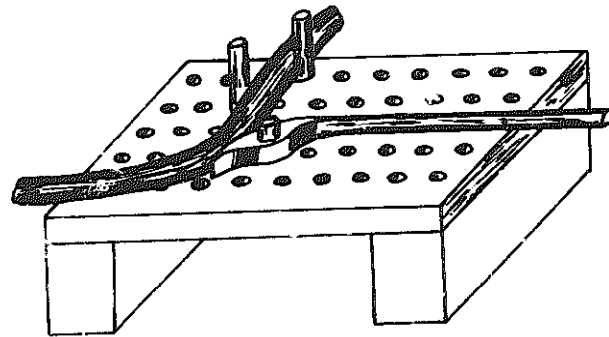

Lever operated bender

Bending frame built around hydraulic bottle jack

A simple press can be made using a hydraulic lorry jack inside an angle iron frame.

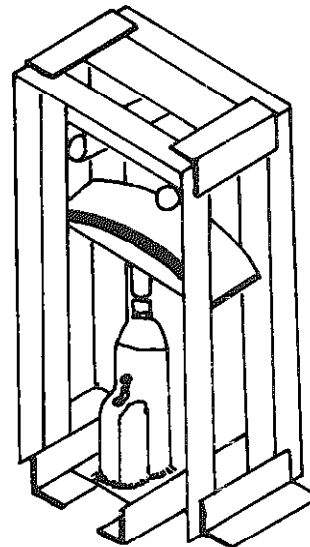

Bending machine for ox cart wheel rims made from a hydraulic lorry jack

Roller operated bender

A more complex piece of equipment used for bending steel sections to a specific radius.

Set of taps and dies (for the threads commonly used in the locality from approximately 6mm to 12mm diameter)

Dies are used to cut external threads on the outside of rods or bolts. Taps

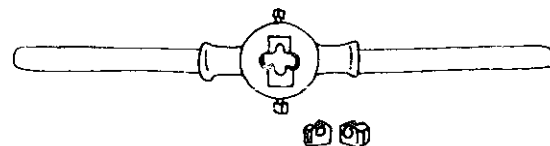

Die stock and dies

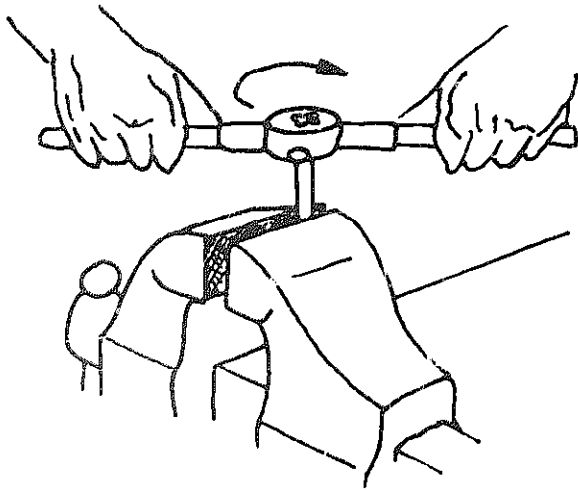

Cutting a thread on a rod using dies

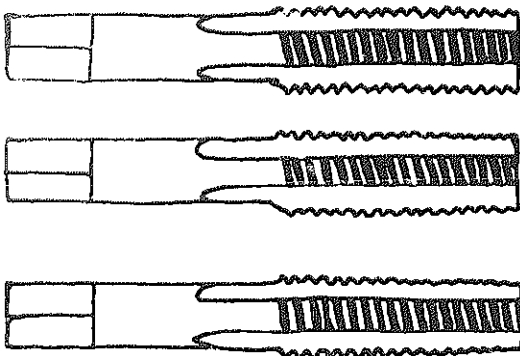

Set of taps for one size of thread

- (i) *Taper tap for starting the thread*
- (ii) *Finishing tap*
- (iii) *Tap for finishing a thread in a blind hole*

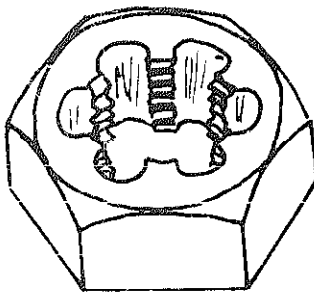

Die nut

are used to cut internal threads inside holes. Often the correct length of bolt is not available. In this case, dies can be used to extend the threads on a longer bolt and the excess length cut off. Alternatively, instead of using an ordinary bolt, one can cut plain round bar to the correct length, thread each end and fit a nut at each end. Taps and dies are expensive to buy (particularly in large sizes) and require skilled operation. Pipe threading equipment also consists of taps and dies. It is very expensive and can only be justified if a lot of pipe work is done.

Many types of thread are in use. The most common are:-

- B.S.W. (British Standard Whitworth)
- B.S.F. (British Standard Fine)
- U.N.C. (Unified coarse)
- U.N.F. (Unified fine)
- B.A. (British Association)
- B.S.P. (British Standard Pipe)
- Metric

Each thread type requires a set of taps and dies for each diameter, hence a comprehensive set of thread cutting equipment would be extremely expensive. Many countries are standardising on metric threads and a set of taps and dies for 6mm, 8mm, 10mm and 12mm diameters would suffice for most purposes.

Die nuts for restoring used threads

External threads often have to be repaired. This can be done using thread restoring files. Alternatively a die nut can be screwed onto the damaged thread to repair it. Internal threads can only be repaired using taps, but they are not damaged as often as external threads.

Thread restoring files for locally used threads

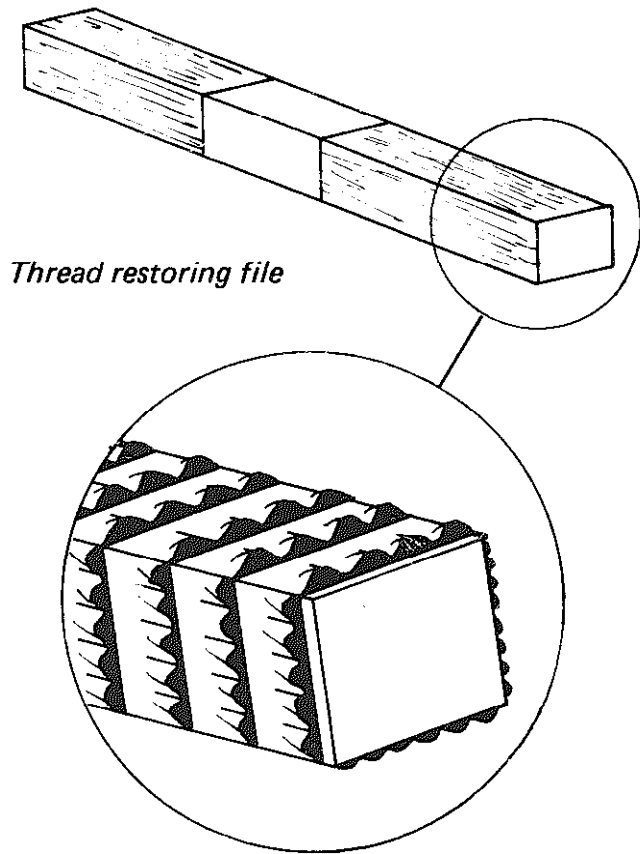

Oxy-acetylene welding and cutting set with regulators; gauges; gas hoses; welding torch; nozzles for welding steel up to 10mm thick; cutting attachment; nozzles for cutting steel up to 25mm thick; spark igniter; cylinder key; nozzle cleaners; goggles

Oxy-acetylene equipment can be used by a skilled operator to heat, weld, and cut a range of metals. However, it is expensive to use for welding thick sections and in unskilled hands can be expensive even for welding thin sheets. The equipment can be very dangerous if not handled properly. The gases (oxygen and acetylene) are supplied in returnable cylinders. In addition to the cost of the gas, there is normally a deposit charge for each cylinder and a

rental charge for each month the cylinder is kept. Gas welding equipment thus costs money even when it is not in use. The supplies of cylinders are not always reliable in places a long way from the gas manufacturing depots. Acetylene can be made in the workshop by the action of water on calcium carbide and this is usually cheaper than buying it in cylinders but cylinders of oxygen must still be bought. Oxy-acetylene equipment can normally be justified only where the workshop does a considerable amount of:

- 1) Welding steel less than 2mm thick (e.g. car body repairs)
- 2) Cutting complex shapes from thick steel plate.
- 3) Repairing small castings.

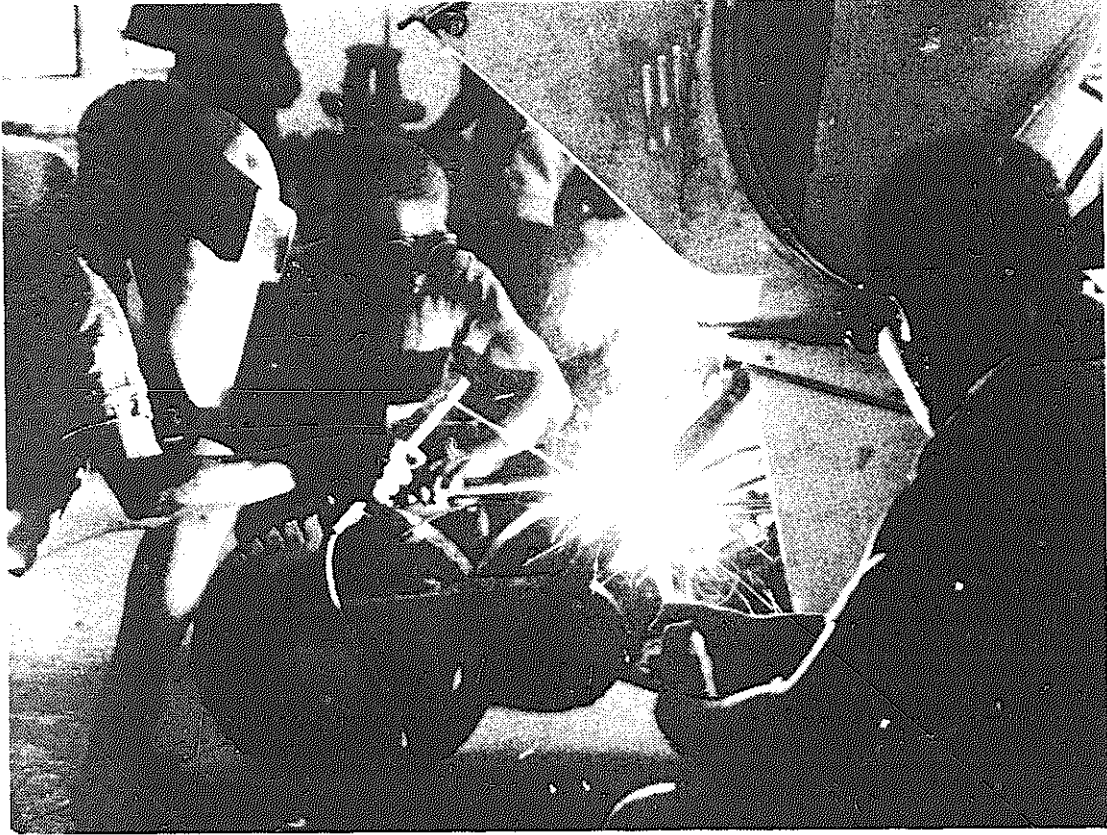

Trainees learning welding skills at Stereke Boys' Centre, Nairobi. (Photo: Ray Parnell/Oxfam).

Power Woodworking Equipment (for use in a 1-2 man workshop)

The equipment listed in this section would cost about £90 in the United Kingdom in mid-1977 and would supplement the items listed in Sections 3.1 and 4.1.

Electric hand drill (with 12mm capacity chuck)

Electric hand drills are available with chucks taking drill bits up to 25mm diameter. The larger sizes are very expensive, but there is a wider choice of cheaper drills with 12mm capacity chucks. The better quality drills often have two speed (more rarely four speed) gearboxes. Most manufacturers offer heavy duty models which are more suitable for a commercial workshop than the lighter versions.

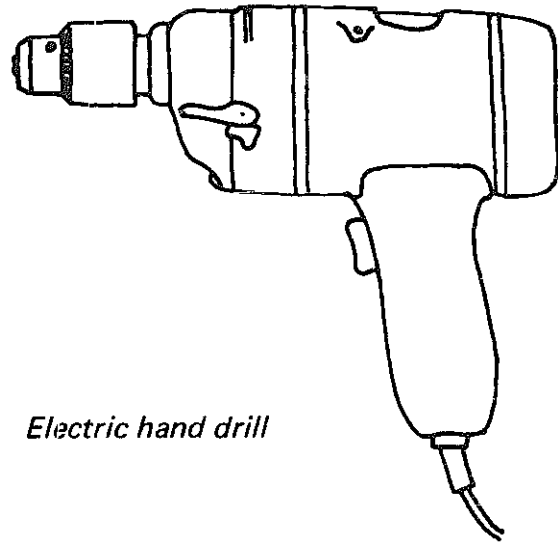

Electric hand drill

Vertical drill press stand for electric hand drill

A vertical drill press stand converts the electric hand drill into a bench mounted drill press.

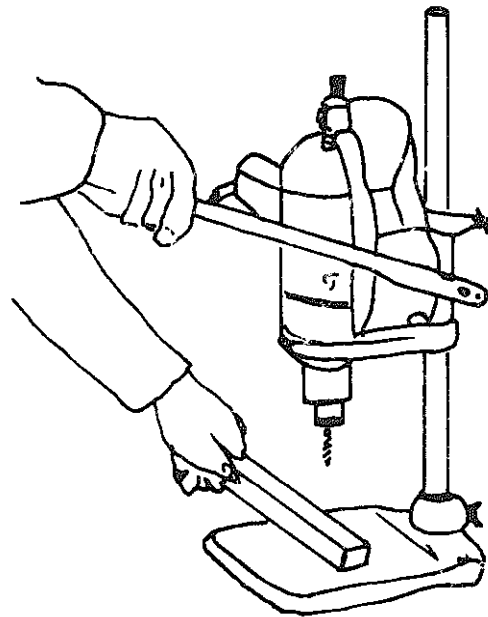

Electric drill with vertical press stand

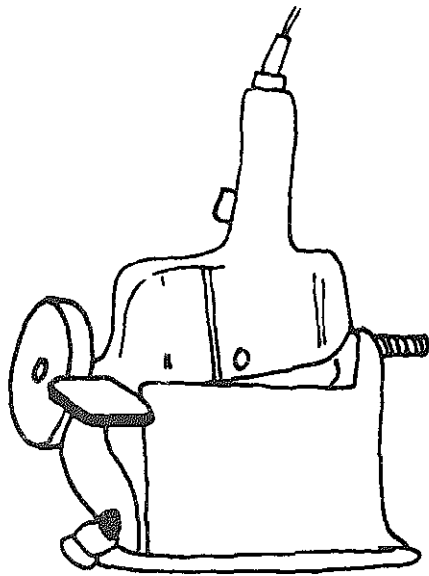

Electric drill with horizontal stand and grinding wheel

Horizontal bench stand and 75mm diameter carborundum wheel for electric hand drill

A horizontal bench stand is used to hold the drill so that a small grinding wheel can be held in the chuck and used for tool sharpening.

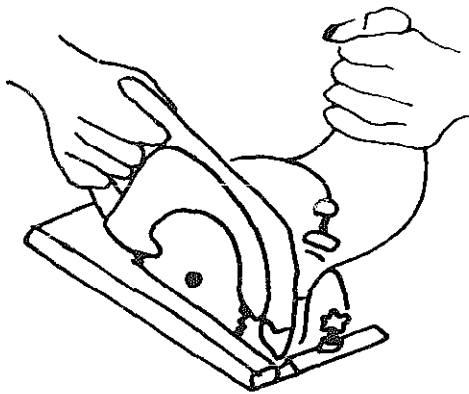

Electric drill with circular saw attachment

Circular saw attachment for electric hand drill

A circular saw attachment enables the drill to be used for cutting boards up to about 25mm thick.



Electric drill with jig saw attachment

Jig saw attachment for electric hand drill

A jig saw attachment enables the drill to be used for cutting along curved lines in boards up to about 25mm thick.

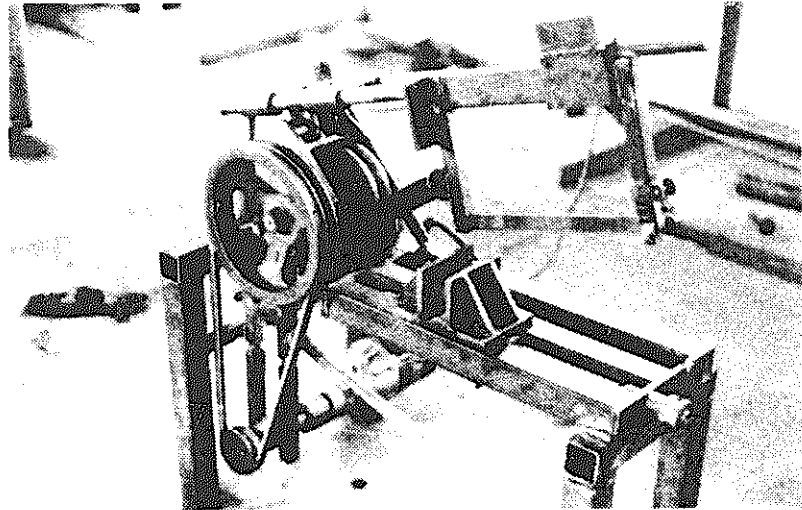

*Power hacksaw driven
by a hand drill in a rural
workshop equipped with
electricity. (Photo:
ITDG).*

Power Metalworking Equipment (for use in a 1-2 man workshop)

The equipment listed in this section would cost in the United Kingdom in mid-1977 about £240 of which £180 would be for the welding set, and would supplement the items listed in Sections 3.2 and 4.2.

Electric hand drill (with 12mm capacity chuck)

The electric drill for metal work should be chosen with the slowest possible chuck speeds.

Vertical drill press stand for electric hand drill

As described on page 46.

Horizontal bench stand and 75mm diameter carborundum wheel for electric hand drill

As described on page 47.

Transformer type a.c. welder oil cooled with outputs adjustable up to 180 amps at 50 volts and 130 amps at 80 volts. Set of accessories — cables, electrode holder, earth clamp, slag chipping hammer, wire brush, face shield.

Transformer type a.c. welders are run from the main a.c. power supply (they cannot be used from a d.c. mains supply). They are generally very simple and reliable because they need have no moving parts. The smaller sizes (up to 140 amp. output) are often air cooled. These air cooled sets are light and easily portable, but will overheat if used for long periods.

Some larger welders up to 180 amp. output are cooled by a built-in electric fan. Oil cooled welders are generally more suitable for prolonged use and for hot climates, but much heavier than air cooled welders of similar output. Oil cooled welders are available in all sizes, but the most widely used sizes are from 110 amp. to 250 amp.

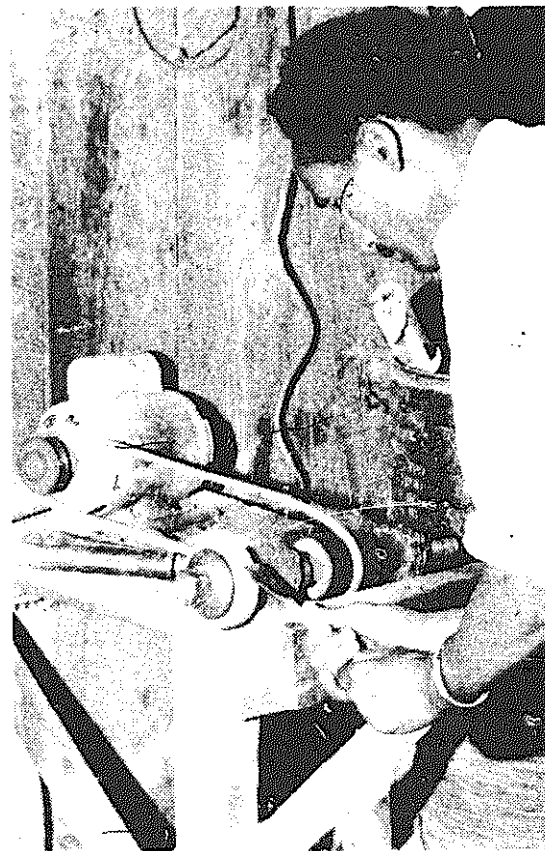

Sharpening a drill bit (Mezan Teferi Workshop, Ethiopia). (Photo: John Morgan).

output. Cheap transformer welders often have an open circuit voltage of about 50 volts, which is satisfactory for welding mild steel. More expensive welders can have open circuit voltages of 70-90 volts, and can be used more easily with special electrodes for welding cast iron, high tensile steel and stainless steel, for applying wear-resisting surfaces to mild steel and for welding thin sheet steel. The high open circuit voltage feature is particularly important in a repair workshop, which may have to weld many different types of metal.

Twin carbon arc torch and head shield for transformer welder

A very useful attachment for a transformer welder is a twin carbon arc torch. This produces a very intense flame which can be used for heating, fusion welding or bronze welding. It is possible to weld with a carbon arc torch almost any material which can be welded with an oxy-acetylene flame, but much greater skill is required. In most workshops the carbon arc torch would be used for heating (for which it is much faster and cheaper than a gas flame) and for bronze welding thin steel sheet.

Section 6

Workshop Buildings for 4-6 Craftsmen

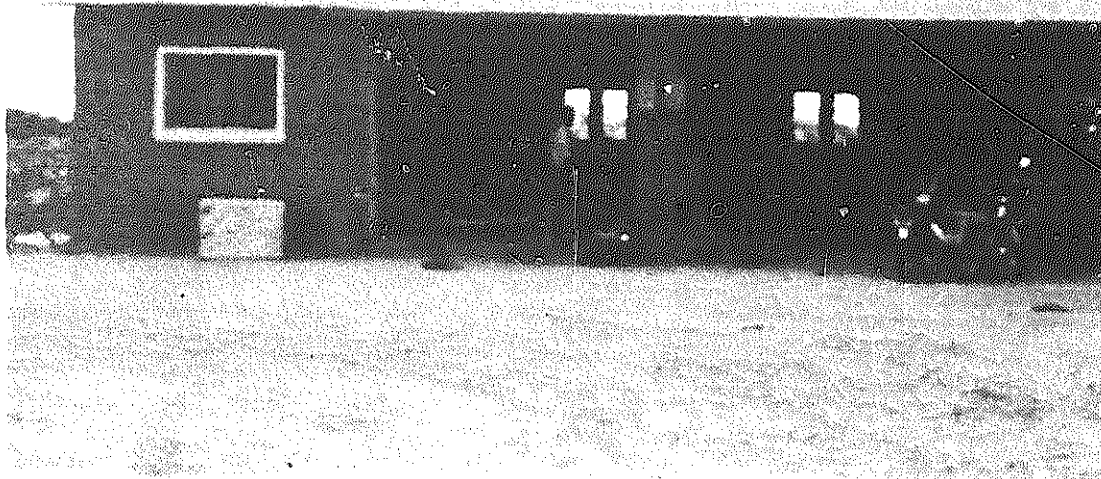

Intermediate Technology Development Group workshop at Magoya, Zambia. (Photo: ITDG).



Garage Water Development Project workshop in Ethiopia. Originally this workshop had only two window openings and one narrow door. It was improved to include seven glazed windows, with shutters, alternating skylights on both sides of the roof slopes, and a pair of double doors. (Photo: S. Bonnist).

The principles of workshop layout are the same as those used to design the small workshop for one or two craftsmen. Features of the workshop for four to six men which is illustrated opposite are:

1. The doors are 3m wide so that large objects and motor vehicles can enter the workshop.
2. The welding equipment is close to the door so that it can be taken outside for work on large objects.
3. The pedestal grinder is located near the welder because it will be used to prepare metal for welding.
4. The power hacksaw is located so that long pieces of metal can be taken from the storage racks and sawn with minimum effort.
5. The circular saw has its greatest advantage over hand tools when ripping (sawing along the line of the grain) and it is therefore located for easiest rip sawing.
6. Fire extinguishers are placed near each door.
7. A workshop of this size will need to keep proper accounts. A desk, wash basin and first aid kit are located in what is likely to be the cleanest part of the workshop.



Cutting angle iron in the Garage workshop. (Photo: ITDG).

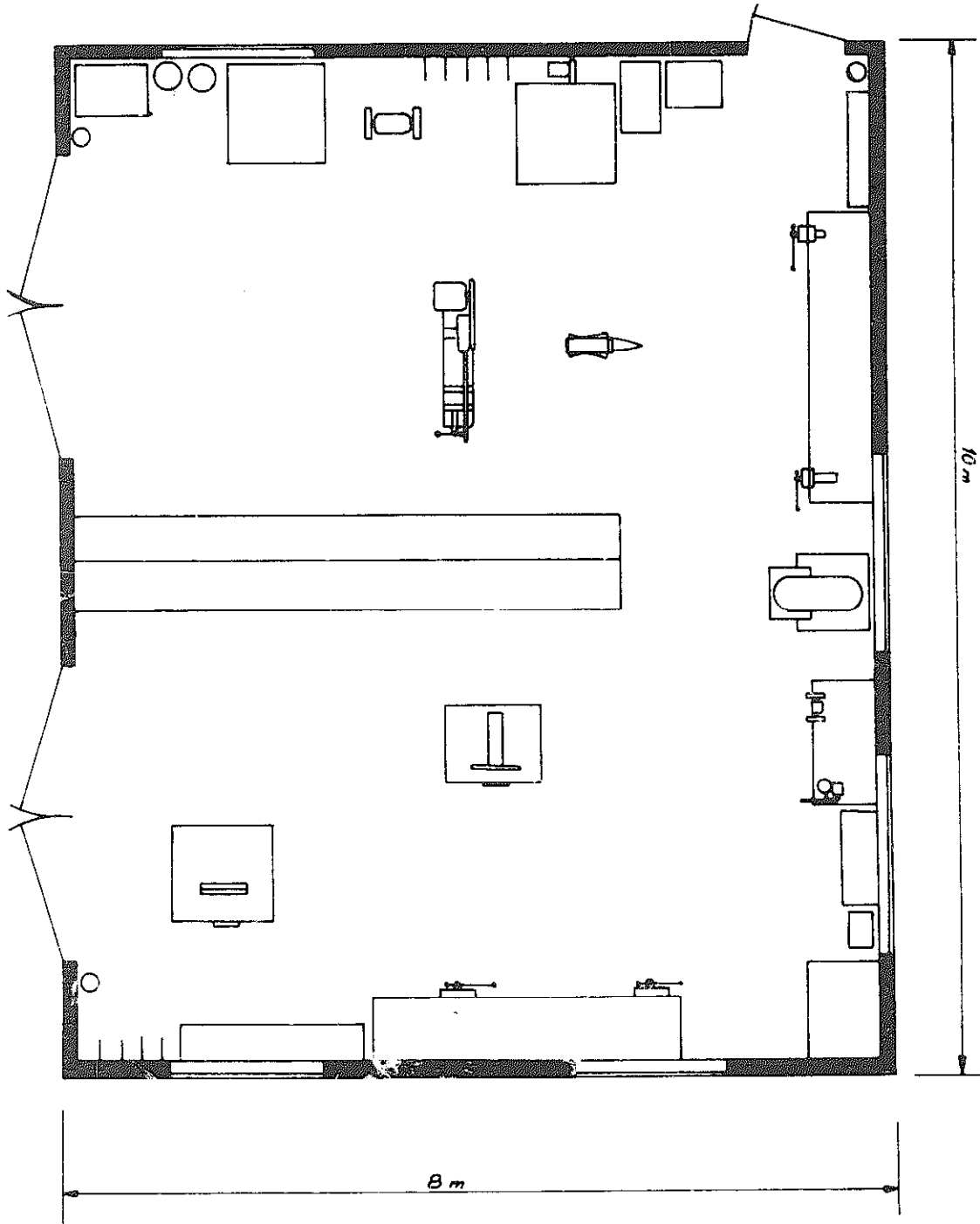

Section 7:1

Power Woodworking Equipment: Machine Tools

(for use in 4-6 man workshop)

Some of the equipment listed in this section might be justified in a large, busy workshop. The complete list would cost in the region of £2,500 in the United Kingdom in mid-1977.

Bench mounted drilling machine (with 12mm capacity chuck and morticing attachment)

Single purpose drilling machines with chuck capacities up to 12mm are usually bench mounted, larger sizes are floor mounted. Morticing attachments enable the drilling machine to cut slots for mortice and tenon joints very quickly.

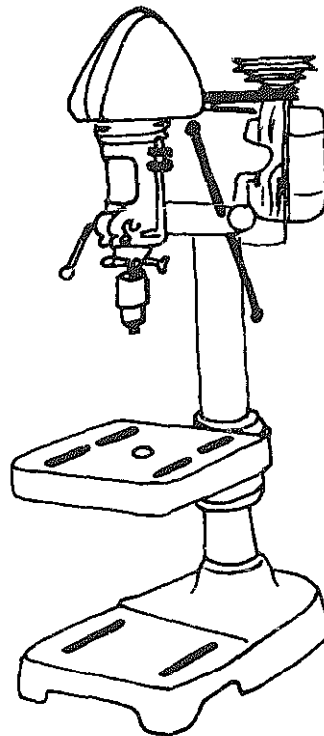

Bench mounted drilling machine

Bench grinder (with 150mm diameter coarse and fine carborundum wheels)

A small electric bench-mounted grinder is the most useful device for sharpening hand tools.

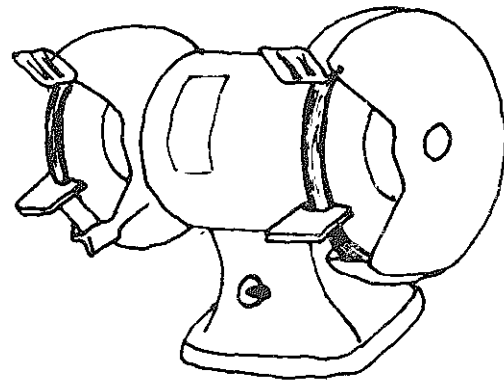

Bench mounted grinder

Single purpose electric hand held circular saw

Single purpose electric hand held jig saw

The sanders and saws can be obtained as single purpose tools. These are more robust and more suitable for large amounts of work than attachments fitted to an ordinary electric hand drill.

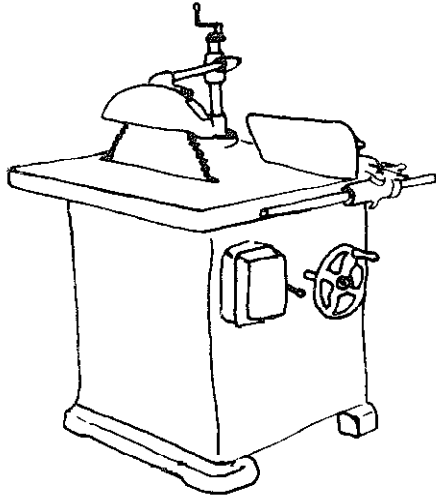

Circular saw (with 250mm diameter blade)

This can be used for rip sawing and cross cut sawing and also for cutting grooves and tenons. The table can usually be tilted for cutting bevels.

Circular saw

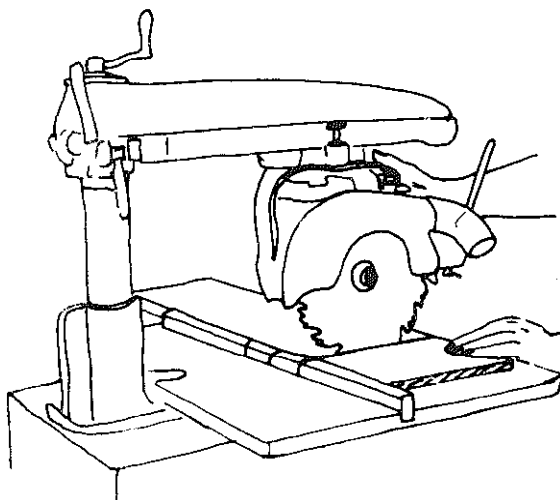

Radial arm saw (with 250mm diameter blade)

This is a very versatile machine in which a circular saw blade is mounted on the shaft of an electric motor. The motor and blade can be tilted in any direction and used for ripping, cross cut sawing, and cutting mitres and bevels. The saw blade can be replaced with various shaped heads for moulding and cutting grooves.

Radial arm saw

Band saw

The band saw is very useful if much sawing along curved lines is necessary.

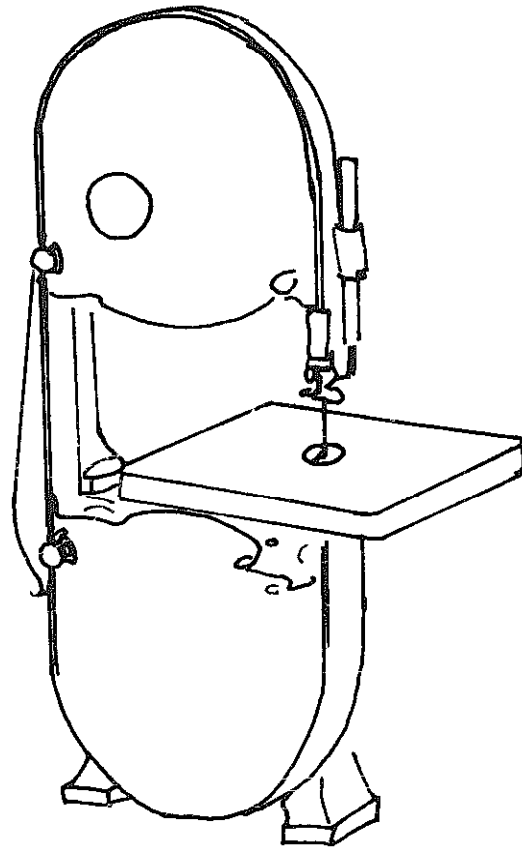

Bandsawing machine

Planing machine (with capacity 300mm wide boards)

The surface planer and thicknesser is used to smooth large boards. A good machine is likely to be the most expensive single piece of equipment in the workshop.

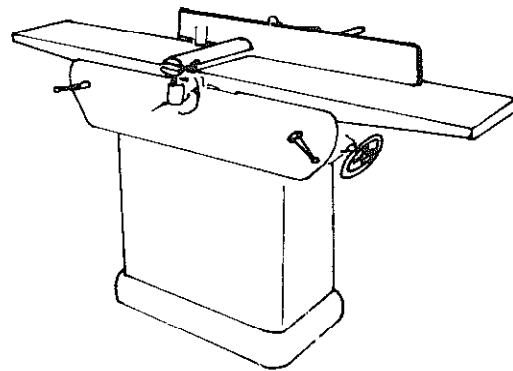

Planing machine

Section 7:2

Power Metalworking Equipment: Machine Tools

(for use in 4-6 man workshop)

Some of the equipment listed in this section might be justified in a large, busy workshop. The complete list would cost in the region of £1,700 in the United Kingdom in mid-1977.

**Bench mounted drilling machine (with
12mm capacity chuck)**

See section 7.1.

**Floor mounted pillar drilling machine
(with morse taper fitting set of twist
drills from 12mm to 25mm diameter)**

A medium duty machine with variable
speeds suitable for a wide range of
drilling operations.

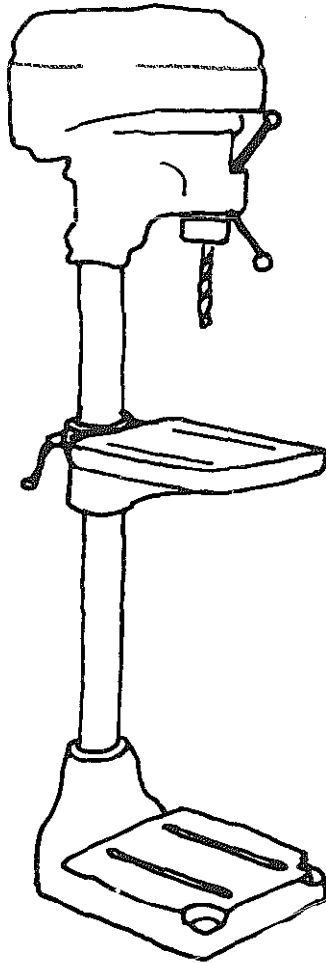

Floor mounted pillar drill

Bench mounted grinder (with 150mm diameter wheels)

Pedestal grinder (with 250mm diameter wheels)

Small grinders are often bench mounted, while larger models are fitted to a floor mounted pedestal. Small grinders are suitable only for light work and tool sharpening. Large grinders can be used to shape metal and are particularly useful for preparing parts to be welded.

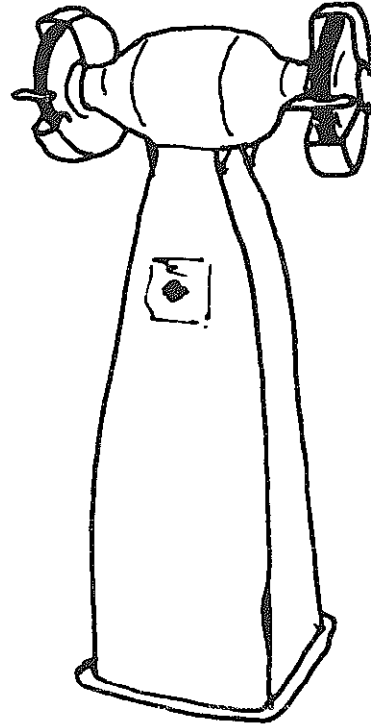

Pedestal grinder

Twist drill sharpening attachment for bench grinder

A drill grinding jig used in conjunction with a bench or pedestal grinder facilitates accurate re-sharpening of twist drills.

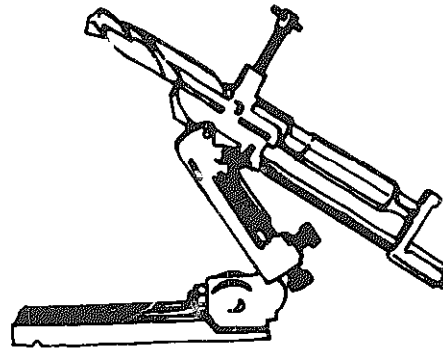

Drill grinding jig

Angle grinder (with 230mm diameter disc)

An angle grinder is a hand-held machine which can save a lot of time preparing and finishing welded components. It can be used as a cutting machine for rough cutting and dismantling work. A cut-off attachment converts it to a rigid-bench device, which may be considered as an alternative to a power hacksaw.

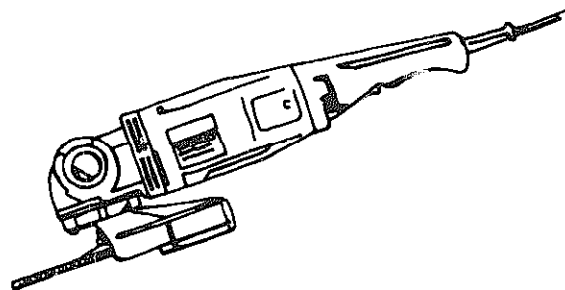

Angle grinder

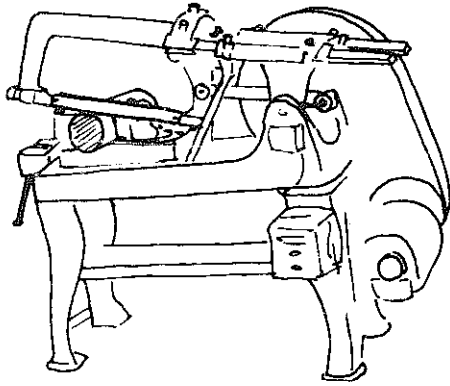

Power hacksaw

Power hacksaw (with capacity up to 100mm x 100mm)

A power hacksaw saves a great deal of time and effort and is more accurate than hand sawing. The hacksaw can be left running while other work is done.

Air cooled transformer a.c. welder with output adjustable up to 110 amps.

Most welders of up to 110 amp output can be used from any ordinary 200/220 volt, 13/15 amp power point, hence a small, portable, air-cooled welder can be useful to take around for repairs to fixed equipment.



Power drill press stand for metal-working. (Photo: ITDG).

Section 8

Power Supply for the Workshop

In many cases there will be no mains electricity supply available and alternative power sources may be considered. Wind power would hardly ever be reliable enough to operate workshop equipment as and when it were needed. Water power from a perennial stream might be harnessed using a water wheel or turbine, but a small workshop probably could not justify the cost.

Small workshops sometimes use petrol or diesel engines as a power source. In the past it was common for several workshop machines to be driven by shafts and belts from one engine. It is difficult to use this technique now because most machines are fitted with individual electric motors and belt driven machines are rarely obtainable.

Small engine-powered electrical generators are readily available. Machines such as an electric hand drill, a small bench drilling machine, a small bench grinder or a power hacksaw could be operated by a 1kVA generator. However, it would rarely be economic to buy a generator just for those machines. Much larger generators are needed to operate the other machines and a 5kVA generator would be needed for a workshop having a circular saw, planing machine, pillar drill, large pedestal grinder and 180 amp arc welder. A metal working shop may use an engine-driven arc welder which can also be used as a generator to power other workshop machines.

Engine-driven generators are expensive and need good maintenance. They can only be economically justified if the workshop is kept very busy. However, a very busy workshop is likely to be located in a town with a mains electrical supply. In general, if a town has no electricity supply there is probably insufficient work to justify a workshop with its own generator.

Section 9

Bibliography on Small Scale Workshops

CoSira

The Blacksmith's Craft

CoSIRA, 35 Camp Road, Wimbledon, London SW19

Dyer H.J.

How to Work Sheet Metal 1963

Model & Allied Publications Ltd., 13/35 Bridge St., Hemel Hempstead, Hertfordshire, U.K.

F.A.O.

Agricultural Machinery Workshops – Design, Equipment and Management.

Agricultural Development Paper No.66, 1960. F.A.O., Via delle Terme di Caracalla, 00100 Rome, Italy.

Jones, M.M.

Shopwork on the Farm 1955

McGraw-Hill Book Co., 1221 Avenue of the Americas, New York 10020, U.S.A.

Lillico, J.W.

Blacksmith's Manual Illustrated 1960

Technical Press, Elm Farm, Freeland, Oxford, U.K.

Macpherson, G.A.

First steps in Village Mechanisation 1975

Tanzania Publishing House, P.O. Box 2318, Dar-es-Salaam, Tanzania.

Weygers, A.G.

The Making of Tools 1973

Van Nostrand Reinhold Co., 450 W.33 Street, New York 10001, U.S.A.

Appendix I

Suggested List of Workshop Equipment

Essential equipment: woodworking

Work bench	800mm high, 650mm wide and 2500mm long
Vice	Cast iron bench vice with 200mm wide jaws
Bow type log saw	
Rip hand saw	800mm blade
Cross cut hand saw	700mm blade
Tenon saw	300mm blade
Compass saw	300mm blade
Coping saw	200mm blade
Sawing horses (pair)	
Bench hook	
Mitre box	
Felling axe	
Hand axe	
Jack plane	350mm long
Adze	
Draw knife	
Wood rasp	<i>Either solid, half round, or with interchangeable flat and half round perforated blades</i>
Square edged chisels	5mm wide; 25mm wide
Mortice chisel	5mm wide
Claw hammer	0.5kg
Wooden mallet	
Pincers	With 150mm long handles
G-cramps	Two, 300mm long
Bradawl	2mm
Gimlet	3mm
Carpenter's ratchet brace	
Auger bits	5mm; 10mm; 15mm; 25mm
Expanding bit	For holes from 15mm to 30mm diameter
Countersink bit	
Screwdrivers	150mm long, 3mm wide blade 250mm long, 5mm wide blade
Rule	1m, folding
Tape	2m metal roll-up tape
Set squares	200mm; 500mm
Marking gauge	
Grinding wheel	Either hand or treadle-operated with carborundum or sandstone wheel

Carborundum oil stone	With coarse and fine grit sides, 200mm long and 50mm wide
Triangular file	100mm long

Essential equipment: metalworking

Goggles	For eye protection
Forge	700mm above ground level
Anvil, "London" pattern	Minimum weight 70kg mounted on wooden or iron stand
Tongs	For flat bars up to 25mm thick; For round bars up to 25mm diameter
Sledge hammer	Double faced, 3kg
Ball pein hand hammer	1kg
Cold chisels	Flat chisel 10mm wide; flat chisel 25mm wide; slitting chisel
Hot chisel	25mm
Cold set	40mm with steel rod handle
Hot set	40mm with wooden handle
Hardie	40mm to fit square hole in anvil
Hot punches	Set of three for holes from 5mm to 20mm diameter
Drifts	Made in the workshop as required
Work bench	800mm high, 650mm wide and 2500mm long
Leg vice	With 150mm wide jaws
Wire frame (Junior) hacksaw	
Hacksaw frame	For standard 300mm blades
Tin snips	Straight blade, 200mm Straight blade, 300mm Curved blade, 200mm
Files	Flat, 250mm, second cut Triangular, 150mm, smooth Half round, 250mm, bastard Round, 150mm, second cut
Breast drill	With 12mm capacity chuck
Set of twist drills	From 2mm to 12mm diameter
Centre punch	
Soldering iron	1kg straight type
Combination pliers	200mm long
Self grip pliers	250mm long
Set of open ended spanners	To fit the nut sizes most common in the locality
Adjustable spanner	250mm long
Stillson type pipe grip	450mm long
Screwdrivers	150mm long, 3mm wide 250mm long, 5mm wide 200mm long, crosspoint
Set squares	200mm; 500mm
Hand or treadle operated carborundum wheel	

Scriber	
Steel rule	300mm
Brass rule	500mm

Other useful equipment: woodworking

Two man log saw	1.5m long
Bow saw	
Saw set	
Block plane	150mm long
Spokeshave	
Cross pein hammer	0.1kg
Bar mounted cramps	2m long
Square edged chisels	10mm wide; 15mm wide
Mortice chisel	10mm wide
Hand drill	With 6mm capacity chuck
Set of straight-fluted bits or twist drills	From 1mm to 6mm diameter
Breast drill	12mm capacity
Set of flat drill bits	For 10mm, 15mm, 20mm, 25mm diameter holes
Hand operated post drill	With 12mm capacity chuck

Other useful equipment: metalworking

Fullers	12mm radius
Flatter	50mm square face
Swages	10mm and 25mm diameters
Bench vice	Steel or cast iron, with 150mm wide jaws
Set of taps and dies	For the threads commonly used in the locality from approximately 6mm to 12mm diameter
Die nuts	For restoring locally used threads
Thread restoring files	For locally used threads
Pipe vice	With 75mm diameter capacity
Pipe cutters	For pipes up to 75mm diameter
Guillotine	With 250mm long blades
Ratchet brace and twist drill bits	From 12mm to 25mm
Dividers	
Bevel	
Calipers	
Lever operated bar bender	
Bending frame built around hydraulic bottle jack	
Oxy-acetylene welding and cutting set	With regulators; gauges; gas hoses; welding torch; nozzles for welding steel up to 10mm thick; cutting attachment; nozzles for cutting steel up to 25mm thick; spark igniter; cylinder key; nozzle cleaners; goggles

Additional equipment for workshop with electric power supply: woodworking

Electric hand drill with 12mm capacity chuck
Vertical drill press stand
Horizontal bench stand and 75mm diameter carborundum wheel for electric hand drill
Circular saw attachment and saw table for electric hand drill
Jig saw attachment for electric hand drill

Additional woodworking equipment for larger workshop

Bench mounted drilling machine with 12mm capacity chuck and morticing attachment
Bench grinder with 150mm diameter coarse and fine carborundum wheels
Single purpose electric hand held circular saw
Single purpose electric hand held jig saw
Circular saw with 250mm diameter blade
Radial arm saw with 250mm diameter blade and 1¼ h.p. motor
Band saw
Planing machine with capacity for 300mm wide boards

Additional equipment for workshop with electric power supply: metalworking

Electric hand drill	With 12mm capacity chuck
Vertical drill press stand	For electric hand drill
Horizontal bench stand and 75mm diameter carborundum wheel for electric hand drill	
Transformer type a.c. welder	Oil cooled with outputs adjustable up to 180 amps at 50 volts and 130 amps at 80 volts. Set of accessories – cables, electrode holder, earth clamp, slag chipping hammer, wire brush, face shield
d.c. welder	
Welder for workshop without mains power supply	<i>Either</i> engine driven a.c. generator minimum 5kVA and transformer welder as above <i>or</i> engine driven welding generator preferably with 110V or 220V A.C. output to run other workshop tools

Additional metal working equipment for larger workshop

Bench mounted drilling machine	With 12mm capacity chuck
Floor mounted pillar drilling machine	With morse taper fitting set of twist drills from 12mm to 25mm diameter

Bench mounted grinder
Pedestal grinder
Twist drill sharpening
attachment
Angle grinder
Power hacksaw
Twin carbon arc torch
Air cooled transformer
a.c. welder

With 150 diameter wheels
With 250mm diameter wheels
For bench grinder

With 230mm diameter disc
With capacity up to 100mm x 100mm
And head shield for transformer welder
With output adjustable up to 110 amps

Appendix II

List of Equipment which can be made within the Workshop

A carpenter can easily make the following items for himself:

Work bench	Mitre box
Sawing horses	Mallet
Bench hook	

A blacksmith can easily make his own:

Forge	Punches
Chisels	Drifts
Sets	Fullers

A more skilled blacksmith can also make:

Tongs	Flatter
Hammers	Swages
Hardie	Screwdrivers

A blacksmith working together with a carpenter can make the following carpenter's tools:

Felling axe	Chisels
Hand axe	Claw hammer
Adze	Pincers
Wooden plane	Bradawl
Drawknife	Screwdrivers
Spokeshave	Flat drill bits

Agricultural implement made in the Intermediate Technology Development Group Workshop at Magoye, Zambia, are illustrated overleaf.

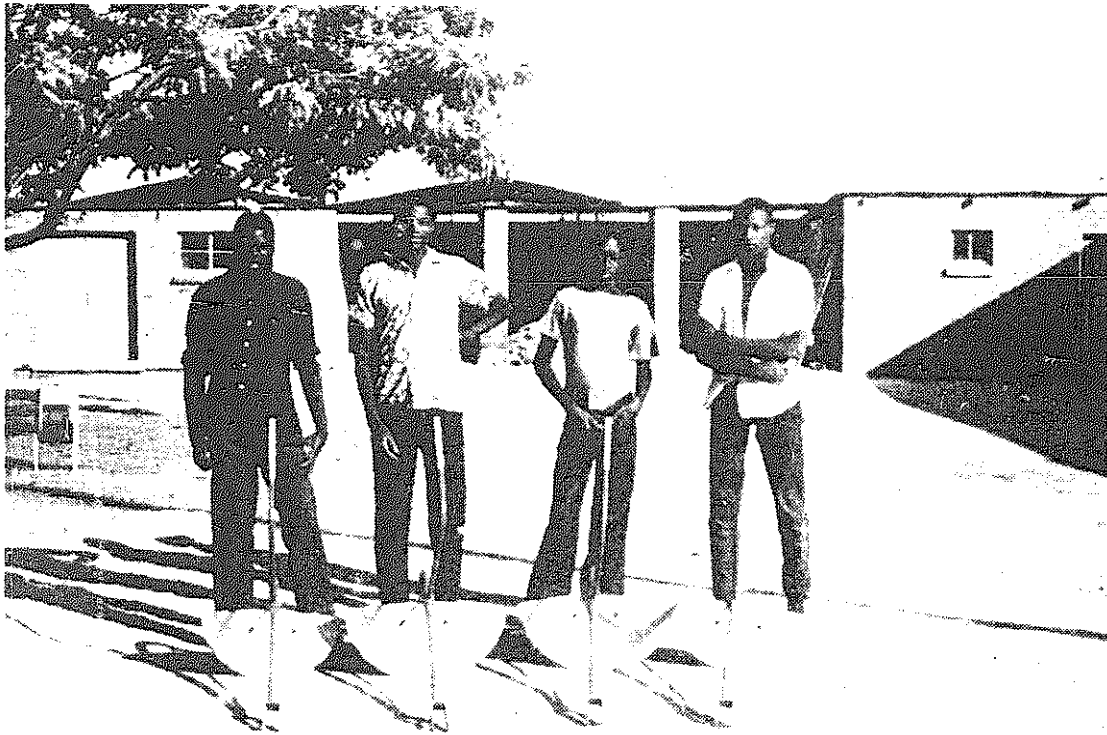

Tie ridge attachments (Photo: ITDG).

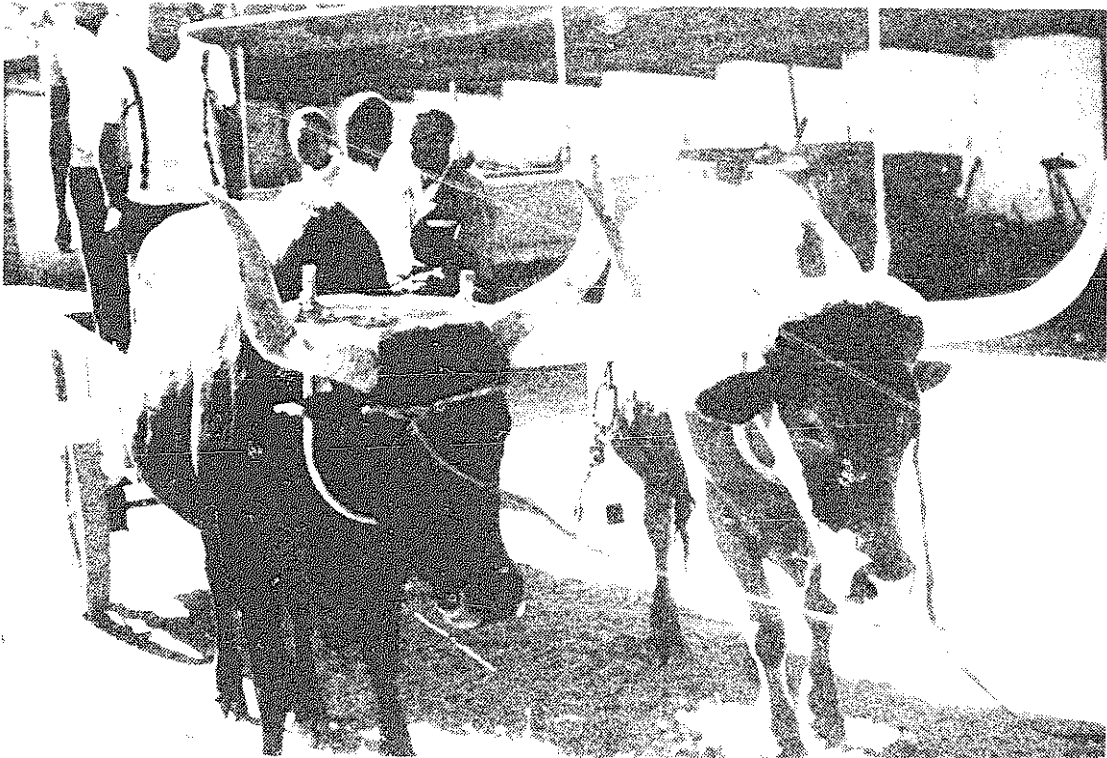

Double ox yoke (Photo: ITDG).

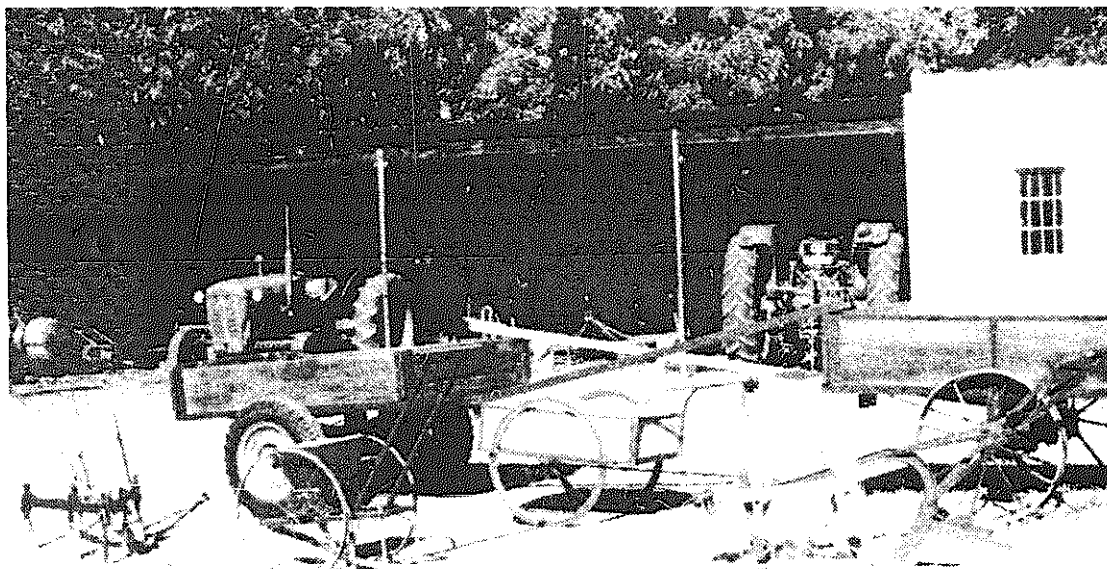

Various items made in the Magoye workshop. (Photo: ITDG).

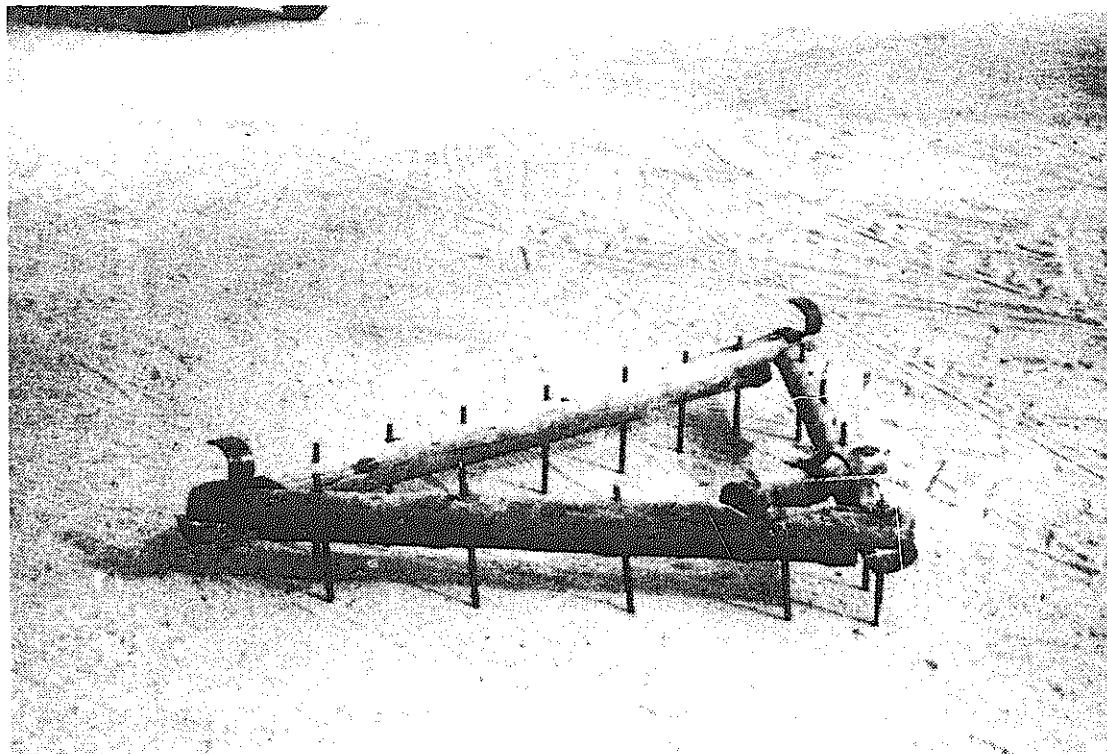

Triangular harrow (Photo: ITDG).

Notes on Metal Working Equipment

The electric arc welding machines can be the single most important piece of equipment in a workshop. With intelligent use the whole business can be run by use of the arc welder and very little else. It is, therefore, very important to take great care when choosing a welder for the workshop. The A.C. oil-filled range is the most reliable, and will run for years with very little maintenance. D.C. welders are air-cooled. The smaller ones have a cut-out switch in case of overheating; they cannot be used for long periods. Larger D.C. machines are fan-cooled and have a longer duty cycle. The moving parts on this type of welder makes them more prone to breakdowns than the oil-cooled type, but they are easier to use. Most engine-driven welders are of the D.C. type.

What is a suitable size of welder? From experience, 200 amps is a very good size; a larger size would be an advantage; and a smaller size could restrict the capacity of the workshop should the workshop expand its operations. Small jobs can be welded with a big machine, but not large work with a small welder. Small handy-man welders powered by 12 volt batteries are of no practical use at all other than for rapid discharge of the battery. One warning: *never* use an arc welder on a motor vehicle fitted with an alternator. If in doubt, remove the earth terminal of the battery. In addition, the earth clamp must be as close as possible to the joint being welded to prevent arcing through various ball races in the vehicle.

In many cases, electricity will not be available and an engine driven generator will be required. The size of the generator will depend on the amount and size of the equipment in the workshop, three or single phase. It is best to obtain all available information on the electrical equipment to be installed in the workshop and send it off to the generator manufacturer for advice. As a rule, diesel driven generators are more expensive than petrol driven ones, but well worth the extra expense in terms of life and reliability.

if possible a machine hacksaw should be included in the list. Cutting up steel section is not easy work and will soon dampen enthusiasm if it has to be done by hand. Gas cutting is not always practical and is expensive. A machine hacksaw will be well worth the investment.

Gas welding equipment

Gas welding equipment is not included in this guide for various reasons: Bottled gas would have to be available within the country; (if gas is available, equipment will also be obtainable).

Assuming that bottled gas and equipment are available, various other problems will arise. The gas bottles have to be hired from a gas producing firm. This hire

charge can be expensive. Other problems are:

- a) Transport will be needed for returning empty bottles and collecting full ones.
- b) The gauges are very delicate and are easily damaged; they are also expensive to replace.
- c) A high degree of training is required, particularly in the safe handling of the equipment. Misuse can be very dangerous.

Bearing in mind the above comments, it is recommended that gas welding equipment should not be included amongst the equipment in the smaller, privately owned workshop, operating out of easy reach of bottled gas supplies.

Harold Pearson

Rural Blacksmith Entrepreneurs and their Capabilities

Local blacksmiths using simple hand tools are capable of producing a variety of items and workable pieces of equipment that serve the local community quite well for many years. Until transport and well-stocked stores are developed in these communities the local blacksmith has the opportunity of being one of the essential entrepreneurs in the community.

The entrepreneur must have the desire and ability to improve his business. Improving the equality of the entrepreneur's products often takes little or no additional equipment – following the advice of a more experienced technician may be all that is required. While additional equipment may be needed to assist a good entrepreneur to expand it should be noted that no amount of the best equipment will do anything to improve the quality of the work or the production of an incapable entrepreneur.

Blacksmiths' shops can be categorised as follows:

Blacksmith's Shop, Category A

This is the basic (indigenous) rural "shop". Hand hoes, axes, knives and other small farm hand tools are manufactured at this level. Workshop equipment consists of:-

- | | |
|-------------|--|
| 1) Workshop | Usually a round earth-walled, thatch-roofed building 16' to 18' in diameter. |
| 2) Forge | Indigenous type, floor operation using goat-skin bellows. |
| 3) Anvil | Iron stake in the ground with a rounded head – possibly 4" round or square. |
| 4) Hammer | Bowling-pin shaped beating iron 3 to 4lb. |
| 5) Tongs | Locally made. |
| 6) Punches | Drift, square, countersink, locally made. |

Blacksmith's Shop, Category B

With the addition of a few tools, jigs and patterns, a capable enterprising blacksmith could make the following after some training:

- 1) Plough bolts (from machine bolts)
- 2) Groundnut lifter attachment
- 3) Weeding attachment
- 4) Other miscellaneous items

The additional tools required would be

- | | |
|-----------------------------|---|
| 1) Ball pein hammer 2lb | 6) Hack saw and 10 blades |
| 2) Carpenter's steel square | 7) Adjustable spanners 8" to 10" |
| 3) Steel tape 6' flexible | 8) Assorted files |
| 4) 6" bench vice | 9) Taps and dies -- 3/8" and 1/2" Whitworth |
| 5) Anvil 100lb | |

Blacksmith's Shop, Category C

The more progressive Category B blacksmiths, after attending further training, should be interested in improving their workshops and up-grading them to Category C. They should generally be able to accomplish this from the profits of their existing business, provided they are competent managers. The progressive blacksmiths' shop should contain all the equipment listed in A and B Categories.

Tools required to up-grade to Category C:

- | | |
|-------------------------|--|
| 1) Workshop | Good location. Minimum size 15' x 20' building, concrete floor, locking doors, good lighting and sound roof. There should also be an open area for forge work and welding (a dirt floor would do for this area). |
| 2) Forge | Must be off the floor -- use same goat-skin bellows and section of an oil drum on legs for hearth. |
| 3) Anvil | Must be off the floor, mounted on section of tree trunk. |
| 4) Workbench | Minimum 3' x 6' x 30" high. |
| 5) 6" solid box vice | |
| 6) Driller | Hand bench type, 1/2" capacity. |
| 7) Bench grinder | Hand powered 5" x 3/4" wheel. |
| 8) Hand drill | |
| 9) Open end spanners | 8 pieces |
| set 3/8" to 1" | |
| 10) Self grip pliers 8" | |
| 11) Tap and die set | 1/4" to 1/2" BSW. |
| 12) Drills set | 1/4" to 1/2" |

Blacksmith's Welding Shop, Category D

A blacksmith may be ready to include an arc welder and other related items in his shop equipment after he has acquired the items listed under A, B and C.

- | | |
|----------------------------|--|
| 1) Arc welder | 200 amp oil-cooled (if available, fitted with battery charger) |
| 2) C Clamps | 2 x 6", 2 x 10" |
| 3) Vice grip pliers | 2 x 8" |
| 4) Bench grinder | 6" |
| 5) Portable electric drill | 3/8" capacity |

- | | |
|-----------------------|---|
| 6) Drills | $\frac{1}{16}$ " to $\frac{1}{2}$ " by $\frac{1}{64}$ " |
| 7) Pipe wrenches | 1 x 10", 1 x 18" |
| 8) Pipe taps and dies | $1\frac{1}{4}$ " to $2\frac{1}{4}$ " |

If electricity is not available additional finance would be required for an engine driven generator.

A blacksmith equipped to Category D would be capable of manufacturing such things as:

- | | |
|------------------|--------------------------------------|
| a) Plough shares | f) Groundnut lifters |
| b) Plough wings | g) Weeding attachments |
| c) Hand ploughs | h) Plough bolts |
| d) Hand hoes | i) Ox carts |
| e) Axes | j) Miscellaneous repairs and welding |

Training

Training courses should last a maximum of five days. If longer periods than this are proposed the entrepreneur's interest wanes due to a number of factors:

- 1) No man likes to be away from his home area too long.
- 2) While he is training he is not earning cash at home.
- 3) As most of the participants cannot read or write, all instruction has to be by practical example and "saturation point" is soon reached.

With encouragement and visits to the workshop locations, the entrepreneur gets a feeling that he is receiving special treatment. In the early stages enthusiasm is often great and this must be harnessed and directed carefully to ensure maximum benefits for the participants and the local community. This means the training unit must know the needs of any given community and must guide the entrepreneur to meet these needs within the specified objectives.

Blacksmith's equipment

Blacksmithing equipment is a key feature of any rural or training workshop, the forge being the most important single piece of equipment. A forge provides a cheap and efficient means of heating metal prior to bending and shaping. For the manufacture or repair of agricultural equipment, blacksmithing facilities are essential.

Some of the equipment shown in the lists can be made in the workshop and need not be bought; for example, chisels, punches, tongs and forge. In most tropical countries charcoal is used as a fuel for the forge. Charcoal is very good, though advice may be required from local people as to the most suitable type, since some charcoal used for cooking does not last very long in a forge.

Machine Tools

The machine tool section of this guide has been kept to a minimum. The range given indicates machines suitable for the small training/development or produc-

tion workshop. Machine tools are very expensive – beware of bargains or little-known makes.

When equipping a workshop on a limited budget, it is better to purchase one good machine tool, a lathe say, than to equip the workshop with light-weight machines (model making type machines). A good lathe can be used as a milling machine or a heavy duty drilling machine for gear cutting and slotting. A very serious mistake, often made by the inexperienced when equipping a workshop with machine tools, is neglecting to see that the machine tool has the accessories which enable it to be used to its full capacity.

Machine tools should not be recommended in a situation where the users are unskilled or where instructors are not available. Powerful motor-driven machine tools can be very dangerous to the user if abused. Many people are injured each year (sometimes fatally) in industrial accidents involving machine tools. The people injured are often skilled or semi-skilled. It would be even more dangerous for unskilled people to attempt to use powerful machine tools. Once in Northern Nigeria the author witnessed an expensive new lathe on a mud floor in a grass-roofed workshop. The machine was propped up with wooden wedges to prevent movement and the bed, being a useful flat surface, was used as an anvil!

Harold Pearson with
John Collett

Appendix V

Tools and Prices

These prices were compiled in mid-1977 and may have increased since then. An allowance should be made for shipping costs. The names and addresses of suppliers and their distributors are given in Appendix VI (page 90).

Woodwork tools

Price Source: Buck and Hickman Ltd.

Wood chisels:	Firmer	
	¼" (6mm)	£1.29
	⅜" (10mm)	£1.29
	½" (12mm)	£1.38
	¾" (18mm)	£1.49
	1" (25mm)	£1.69
	Bevel edge chisels: similar prices	
Electric glue pots:	1pt capacity	£26.00
	220/250 volt a.c. Other sizes available.	
Bench boxwood rules'	1" (25mm) wide x 3ft (1m)	£1.79
	1 metre length x 25mm width	£2.13
Spokeshaves:	iron body	
	adjustable cutter	£2.15
	flat face	
Planes:	Smooth plane 10¼" (260mm) long	£8.96
	2⅜" (60mm) cutter	
	Jack plane 15" (380mm) long	£9.95
	2⅜" (60mm) cutter	
	Jointer plane 24" (610mm) long	£15.54
	2⅝" (70mm) cutter	
	Full range available.	
Hand saws:	20" (500mm)	£4.07
	22" (550mm)	£6.00
	24" (600mm)	£6.18
	28" (700mm)	£7.85
	Full range includes: Tenon	
	Coping	
	Pad	
	Log saws	

Saw set:	Fully adjustable for setting the teeth of hand saws	£4.42
Carpenters' braces:	ratchet brace alligator jaws plated finish 12" sweep	£5.93
Set of brace bits:	set ¼" (6mm) to 1" (25mm) in bit roll of 13 bits	£21.35
	set ¼" (6mm) to 1" (25mm) in bit roll of 6 bits	£10.11
	Larger sizes and types available.	
Screwdrivers:	Full range available: Cabinet, Electric (Tester type), Engineers', Ratchet "Yankee", Philips, Posidrive	
	Prices from —	60p to £8.00
Marking squares:	All steel squares	
	6" (152mm)	£2.26
	9" (230mm)	£3.17
	Combination try and mitre squares	
	12" (300mm)	£3.99
Bevels:	9" (230mm)	£2.35
	Other sizes available	
Marking gauges:	Prices from	90p to £4.90
Pocket steel tapes:	6ft to 26ft 2m to 8m	
	Prices from	£0.78 to £5.98
Measuring tapes:	33ft to 100ft 10m to 30m	
	Prices from	£4.32 to £12.08
Spirit levels:	Builders' type aluminium 24" (60mm)	£5.82
	Carpenters' hardwood type	
	6" (150mm)	£0.78
	12" (300mm)	£1.44
Carpenters' mallets:	Beechwood 4" (100mm)	£0.90
	5" (127mm)	£1.01
	6" (153mm)	£1.12
Hammers:	claw	
	polished face 16oz	£3.45
	hickory handle 20oz	£3.71
	24oz	£3.85
	Full range available: engineers'	
	pin	
	joiners'	
	boiler	
	sledge, etc.	

Cramps	Standard G cramps 4" (100mm)	£1.62
	8" (200mm)	£2.84
	12" (300mm)	£6.89
	Sash (bar) cramps from 24" to 6'	£5.47
	(600mm to 1500mm)	to £8.31
	Other types include T-bar, carverrack cramps, corner and flooring cramps.	
Self-grip wrenches:	Standard 10" (250mm)	£2.73
	7" (180mm)	£2.51
	This type of clamp is available with various types of jaw shapes for special jobs. The standard wrench is a must for any workshop.	
Pliers:	Engineers' combination 8" (200mm)	£1.96
	Full range of other types available include: round nose, radio, electrical, end or top cutters, water pump, circlip, chain pliers, etc.	
Bench vices:	Woodworkers' 10.5" (265mm) jaw width	£17.61
	15" (380mm) opening	
	Mechanics' 6" (150mm) jaw width	£20.53
	light to 8" (205mm) opening	
	medium duty	
	Engineers' heavy 6" (150mm) jaw width	£53.52
	duty castings 7¼" (185mm) opening	
	guaranteed	
	against break-	
	age). Dual action	
	quick grip	
	Pipe, fitters', table types also available.	
Machine vices:	For use on machine tools, drillers, milling and shaping machines.	
	Universal machine vice	
	6" (150mm) jaw width	£171.50
	5" (125mm) opening	
	Drilling machine vice	
	4" (100mm) jaw width	£9.60
	3" (75mm) opening	
Chain saws:	Danarm Model 110 automatic saw. Two stroke engine 110cc capacity. 20" (510mm) cutter	£165.00
Engineers' tools	<i>Price Source: Buck and Hickman Ltd.</i>	
Files:	Files are graded by shape (flat, hand, round, square, half round, triangular – or three square-knife, warding and pillar), by type of cut (bastard second cut, and smooth), and by length. When ordering specify shape, type of cut,	

and length. Files range in length (the length being the cutting surface), from 4" (100mm) to 14" (350mm) in 2" increments. Prices vary from 50 pence to £2.76. Special files are available for fine work and are known as "precision" or round-handle-needle files, used by locksmiths, gunsmiths, tool makers, etc., for very fine work. These files can be purchased in sets of 12 for about £5.00. File handles have to be ordered separately. Wood fitted with strong ferrules are supplied in ½" sizes from 3" to 6" at £5.90 to £9.25 per hundred.

Stanley Surform tools:

These tools are a form of plane, fitted with a removable blade. The blade is thin and looks like a rough file. The cutting edges are punched through the blade and do not block. Surforms are used for the most part on wood or soft metals. From 6" (150mm) to 10" (250mm) long. Cost £1.40 to £2.59. Various cuts of blade to suit different materials are available. Blades are 52 pence to 60 pence each.

Hacksaws and blades:

Pistol grip, tubular frame to take 10" (250mm) or 12" (300mm) blades.

Frame £2.50. Other models available from £1.42.

Blades – high speed steel blades are commonly used, although special alloy blades are available. Graded as hard or flexible, single or double edge. When ordering, one should specify length, width, thickness and number of teeth per inch.

12" (300mm) long x ½" (13mm) wide, £23.98 per 100
14, 18, 24, or 32 teeth per inch (25mm)

Low alloy, flexible blades suitable for training workshops, sizes as above £7.20 per 100

Junior saw blades 6" (150mm) long £0.26 per 10

Junior saw frame £0.34

Machine hacksaw blades

14" (335mm) long x 1¼" (32mm) wide

6 or 10 teeth per inch (25mm) £13.65 per 10

When selecting blades, the thinner the material, the more teeth per inch per blade. If possible at least 3 teeth should be in contact with the surface of the work being cut. Angle the saw on thin material to give a greater cutting area.

Cold chisels:

Flat cut

Blade width ¼" (6mm) x 4" (100mm)

length £0.38

Blade width ½" (12mm) x 8" (200mm)

length £0.56

Blade width ¾" (18mm) x 12" (300mm)

	length	£1.00
	Other types available include: diamond, crosscut, and half-round. Up to 24" (600mm) long by 1" (25mm) wide.	
Punches:	Centre punches, $\frac{3}{16}$ " (5mm) diameter, 4" (100mm) length	£0.48
	Parallel pin punches 4" (100mm) x $\frac{1}{8}$ " (3mm)	£0.34
	4" (100mm) x $\frac{1}{4}$ " (6mm)	£0.40
	Other sizes available.	
Spanner sets:	Open-end Whitworth from $\frac{1}{8}$ " to $\frac{1}{2}$ "	
	Set of 7 spanners	£7.70
	Ring spanners as above	£9.42
Socket Sets:	$\frac{1}{2}$ " square drive full set from $\frac{1}{8}$ " to $\frac{3}{4}$ " Whitworth and $\frac{3}{8}$ " to 1 $\frac{1}{4}$ " AF (35 pieces) with accessories	£57.50
	$\frac{1}{4}$ " square drive set, $\frac{3}{16}$ " to $\frac{7}{16}$ " AF (12 pieces) with accessories	£20.85
	Other sets available	
Adjustable spanners:	4 $\frac{1}{4}$ " (110mm)	£2.56
	10" (255mm)	£4.80
Box spanners:	Tubular box spanner sets of 6, up to:	£3.70
Twist drills:	High speed steel, straight shank	
	Fractional set, $\frac{1}{16}$ " to $\frac{1}{2}$ " in increments of $\frac{1}{64}$ " (29 drills) in retractable steel case	£16.35
	Wire gauge number drills, set, 1 to 60 (60 drills) in retractable steel case.	£13.43
	A to Z set	
	Metric set 1mm to 13mm in 0.5mm steps (25 drills) in retractable steel case.	£14.29
	Individual price, $\frac{1}{8}$ " (3mm)	£0.13
	$\frac{1}{4}$ " (6mm)	£0.32
	$\frac{1}{2}$ " (13mm)	£1.12
Drill sharpener:	For $\frac{1}{8}$ " (3mm) to $\frac{1}{2}$ " (13mm) twist drills (metal-cutting HSS and carbon drills)	£3.40
	For larger drills use drill grinding jig in conjunction with a bench grinder	
	$\frac{1}{4}$ " (6mm) to 1" (25mm)	£16.35
Morse taper shank twist drills:	For use in machine tools, giving a more accurate location	
	$\frac{1}{8}$ " (3mm)	£1.00
	$\frac{3}{16}$ " (5mm)	£1.08
	$\frac{1}{4}$ " (6mm)	£1.17
	$\frac{3}{8}$ " (10mm)	£1.67
	$\frac{1}{2}$ " (13mm)	£2.05
	$\frac{3}{4}$ " (19mm)	£3.61
	1" (25mm)	£6.11

	1¼" (32mm)	£9.66
	1½" (38mm)	£14.76
	Sizes up to 2" may be obtained in increments of 1/64". From 2" to 3" increments are by 1/32".	
	Equivalent range available in metric.	
Drill sleeves:	Morse taper	
	Hardened and ground 1-2	£1.13
	1-3	£1.54
	1-4	£2.20
	2-3	£1.41
	2-4	£2.13
	3-4	£2.13
	4-5	£3.51
	Extension sockets in the above sizes are available from £2.43 to £5.15	
Reamers:	High speed steel, spiral flute, parallel hand reamers.	
	3/16" (5mm)	£1.44
	¼" (6mm)	£1.55
	½" (12mm)	£2.61
	5/8" (15mm)	£3.32
	¾" (19mm)	£4.22
	1" (25mm)	£6.88
High speed parallel machine reamers (morse taper shank):	In sizes as above. £1.83, £1.94, £2.78, £3.50, £4.11, £7.55	
	Full range of both types available from 1/8" to 1 3/8" in increments of 1/16"	
	Next largest machine reamer is 1½" (metric available)	
Expanding reamers:	Adjustable in 1/32" (1mm) increments	
	Set of reamers to cover all sizes from 3/8" (9mm) to 1 3/16" (31mm)	
	12 reamers	£70.00
	These reamers are more suitable for general use than are the solid type.	
Measuring equipment:	V blocks, cast iron 5" x 3½" x 1¼" (125mm x 90mm x 45mm) — per matched pair £15.98	
	Engineers' try squares, precision ground to BSS No.939 1962 (grade B)	
	Blade lengths 4", 6", 9", 12", 18", 24".	
	Prices, £2.30, £2.70, £4.80, £7.00, £34.00	
	£52.00. Also in metric.	
Calipers and Dividers:	Outside/inside calipers and dividers are all similarly priced. Leg lengths 3", 4", 5", 6", 8", 10", 12". Respective prices are £1.36, £1.50, £1.56.	

Radius gauges:	£1.66, £2.24, £2.38, £2.78. Also in metric $\frac{1}{32}$ " to $\frac{1}{2}$ ", 20 gauges	£2.34
Feeler gauges:	Also in metric and decimal 1½, 2, 3, 4, 6, 8, 10, 12, 15, 25 thousandths, 10 tapered blades 3" long. Each set £1.56.	
Precision vernier calipers:	Also in metric sizes. Metric and English measures, 24" (600mm) capacity reading by vernier to 0.001" and 0.02mm.	
	Complete in case	£203.30
	6" (150mm) reading capacity. Reading by vernier to .001" and 0.02mm	£13.12
Vernier height gauge:	Metric and English scales, measuring capacity 18" (460mm) readings in 0.001" and 0.02mm Each gauge is in a wood case complete with offset and straight scribes with clamp, depth rod, magnifying glass, universal dial indicator adaptor	£225.44
Eclipse magnetic bases:	No.903 base $1\frac{5}{8}$ " x $1\frac{7}{8}$ " x $1\frac{15}{16}$ " Height $9\frac{5}{16}$ "	£12.36
Depth gauges:	$3\frac{1}{2}$ " stock, 6" rule, marked in $\frac{1}{64}$ " and mm With 12" blade	£3.28 £4.00
Drill gauges:	All types, fraction, A to Z, No. and mm sizes	£4.14 to £8.28
Surface gauges:	3" base, 9" and 12" pillar. Square base, vee grooved on bottom	£10.74 and £10.84
Combination set:	With hardened blade and drop forged steel head. Complete set, with protractor, square head, centre head and rule. 12" blade available in metric	£27.06
	Parts if sold separately:	
	12" rule	£3.08
	Square head	£6.18
	Centre head	£4.56
	Protractor head	£15.64
Surface plates:	Grade A and B. Grade A are hand scraped. Grade B are machine scraped. Grade A, sizes: 12" x 8" (306mm x 204mm) 12" x 12" (306mm x 306mm) 18" x 18" (457mm x 457mm)	£30.00 £56.00 £99.40
	These plates are used as an accurate datum surface for marking out and inspection. They must have a cover over working surface to prevent damage to surface when not in use.	
Micrometers:	<i>External micrometers</i>	

Pearl chrome plated with ratchet thimble and locknut. Supplied in hinged pocket case.

0"-1" (0-25mm) £10.26

1"-2" (25-50mm) £14.50

Enamelled frames:

2"-3" (50-75mm) £12.08

3"-4" (75-100mm) £13.20

4"-5" (100-125mm) £14.30

5"-6" (125-150mm) £14.84

Internal micrometers

1"-2" 2 rods £11.82

25mm-55mm 3 rods £12.26

2"-8" 6 rods £16.34

50mm-210mm 8 rods £18.30

Adjustable depth gauge micrometers

0"-6" with 6 rods, base 2½" £23.00

0-150mm 6 rods, base 63.5mm £23.00

Engineer's straight edges:

Bevelled edge

Length (mm)	Width (mm)	Thickness (mm)	Price each
500	45	6.5	£16.00
1000	60	8	£27.00
1500	70	10	£51.00
2000	80	12	£69.00

Precision steel rules:

Marked 16ths, 32nds, 64ths, mm and half mm.

Rustless 6" £1.26

12" £2.54

Precision English/metric conversion rule:

10"/254mm x 25mm wide x 1mm thick

Rustless £2.42

Folding steel rule:

2ft two fold, marked 16ths and mm

Rustless £2.60

Permanent magnet chucks:

255mm x 125mm £62.50

350mm x 150mm £95.58

12" (305mm) £166.94

Other sizes available

Threading equipment: (Taps and dies)

¼", 5/16", 3/8", 7/16", ½", 5/8", ¾", 7/8", 1"

B.S.W. or B.S.F. per set £56.00

All the above sizes available in U.N.C. or U.N.F. per set £56.00

2mm, 2.5mm, 3mm, 3.5mm, 4mm, 5mm, 6mm per set £13.45

5mm, 6mm, 7mm, 8mm, 9mm, 10mm, 11mm, 12mm per set £23.92

14mm, 16mm, 18mm, 20mm, 22mm, 24mm. Set £48.92

	0, 1, 2, 3, 4, 5, 6, 7, 8, 9, 10 B.A. per set	£18.48
	Each of the above sets consists of a circular adjustable split die and two taps for each size, with die stock for every diameter of die and tap wrenches for all taps.	
Hand drills:	3 jaw $\frac{5}{16}$ " (8mm) capacity chuck, double pinion	£5.84
Breast drill:	3 jaw chuck $\frac{1}{2}$ " (13mm) capacity chuck, two speed	£12.67
Soldering irons:	Weller instant heat gun with 275 watt heavy duty model in kit form with supply of resin cord solder, spanner, 2 spare bits, brush, soldering aid tool, all in fitted case	£10.86
	Straight copper soldering irons 10"	£2.94
	20"	£6.29
Portable power tools	<i>Price source: Stanley/Bridges Ltd.</i>	
XJ 502	$\frac{1}{2}$ " (13mm) drill, two speed, 500 watt	£34.95
XJ 505	$\frac{1}{2}$ " (13mm) drill, four speed, 500 watt (speeds 690, 900, 2200, 3100)	£36.95
NRS	6" (153mm) diameter blade, portable rip saw. Supplied with 6" 30 tooth blade and incorporates calibrated ripping fence and guide marker	£12.95
JS	Jig saw. For fast straight or contour sawing. Cuts up to $1\frac{1}{2}$ " (38mm) soft wood 1" (25mm) hardwood and up to $\frac{1}{8}$ " (3mm) non ferrous metal	£11.95
No.89	NRS and JS are accessories using drills XJ 502 or XJ 505 as power units 9" (230mm) heavy duty saw. High temperature insulation, depth and angle controls 2 hp	£98.00
	<i>Price source: Wolf Electric Tools Ltd.</i>	
3521	$\frac{3}{8}$ " (10mm) Sapphire super-duty 2 speed drill	£49.95
3692	$\frac{5}{8}$ " (16mm) Sapphire super-duty back handle 4 speed drill	£83.00
3391	$\frac{3}{4}$ " (19mm) Sapphire super-duty 4 speed drill available with chuck or No.2 morse taper spindle	£125.00
0421	Stand for drill 3391	£70.00
4130	7" (178mm) Sapphire super-duty angle grinder	£87.00
21708	4" (100mm) Grinderette kit	£49.95
5205 'B'	Sapphire orbital super fine finishing sander	£65.00

Price source: Black and Decker Ltd.

Model no.

HD 1060	$\frac{3}{8}$ " (10mm) Holgun drill. Suitable for industry or trade use. No load speed 1000 r.p.m.	£46.00
GD 25	$\frac{1}{2}$ " (12mm) drill. Drilling capacity: steel $\frac{1}{2}$ ", masonry $\frac{3}{4}$ "; wood 1". No load speed 625 r.p.m.	£49.00
SAG 500	4 $\frac{1}{2}$ " (115mm) Grindermite (4 $\frac{1}{2}$ " diameter sanding disc). Suitable for grinding or disc sanding operations. No load speed 9000 r.p.m. Weight 3 $\frac{1}{2}$ lbs.	£54.00
HD 1270	7" (180mm) angle grinder. No load speed 6000 r.p.m. Weight 14lbs.	£98.00
HD 1215	9 $\frac{1}{4}$ " (235mm) heavy duty portable circular saw (wood). Calibrated depth adjustment. Up to 45° cutting angle.	£96.00

This is only a small selection of the range of portable power tools available in Britain. These tools are manufactured to the highest safety standards and are very suitable for use under difficult conditions. Manufacturers are more than willing to give advice about their products and how best to apply them.

Blacksmith's tools

Price source: Vaughans of Dudley

Leg vice:	4"	£43.38
(Forged steel jaws)	4" with stand	£80.00
	6"	£57.50
	6" with stand	£89.13
Flatteners	2.5"/wood handle	£5.25
	2.5"/iron handle	£5.00
Swage (top)	up to and including 1"/wood handle	£4.54
	up to and including $\frac{1}{2}$ "/iron handle	£4.15
	above $\frac{1}{2}$ " to 1" inclusive/iron handle	£4.45
Swage (bottom)	up to and including $\frac{1}{2}$ "	£3.40
	above $\frac{1}{2}$ " to 1" inclusive	£4.04
Fullers (top)	up to and including 1"/wood handle	£4.13
	up to $\frac{1}{2}$ " inclusive/iron handle	£3.78
	above $\frac{1}{2}$ " to 1" inclusive/iron handle	£4.05
Fullers (bottom)	up to $\frac{1}{2}$ " inclusive	£3.10
	above $\frac{1}{2}$ " to 1" inclusive	£3.68
Hardie	1.5" blade	£2.51
Hot set	3lb.	£3.50
Poker	18"	£1.00
Shovel	18"	£1.38
Rake	18"	£1.13
	22"	£3.51

		Price	
Sledge hammers (bright face, handled):	weight	w/cross pein	straight
	4lb	£2.97	£2.70
	7lb	£4.27	£3.85
	10lb	£5.69	£5.18
	12lb	£6.57	£5.92
	14lb	£7.24	£6.59
	20lb	£10.23	£9.31
	28lb	£16.58	£13.86
Ball pein hammers (Ash handles)	1lb		£1.80
	1½lb		£2.23
	2lb		£2.59
	2½lb		£2.94
	3lb		£3.29
Cross pein hammers (Ash handles)	1lb		£1.96
	1½lb		£2.39
	2lb		£2.74
	other weights available		
Round punch	¼"-½"		£4.38
	⅝"-1"		£4.63
Square punch	¼"-½"		£3.91
	⅝"-1"		£4.13
Cold chisels		Flat	Half round
	6 x ¼"	£0.28	£0.34
	6 x ⅜"	£0.30	£0.38
	6 x ½"	£0.41	£0.51
	8 x ⅝"	£0.53	£0.66
	10 x ¾"	£0.80	£1.00
	10 x ⅞"	£1.03	£1.28
	10 x 1"	£1.23	£1.53
	12 x 1"	£1.35	£1.69
		18"	22"
Tongs	Universal	£4.03	£4.34
	Pick-up	£4.03	£4.34
	Chisel	£4.16	£4.48
	Close mouth	£3.94	£4.24

Other types available to customers' requirements.

Vaughans offer three complete blacksmiths' kits.

Number 2 is comprised of the following:

Set No.2

All tools fitted with handles where necessary.

1-7lb sledge hammer

1-10lb sledge hammer	
1-1½lb hand hammer	
1-2lb hand hammer	
1-3lb hand hammer	
4 Pairs top and bottom swages (assorted)	
2 Pairs top and bottom fullers (assorted)	
1 Flattener	
1 Hardie	
1 Set hammer	
1 Hot set	
1 Cold set	
2 Round punches	
2 Square punches	
2 Cold chisels	
1 Poker	
1 Shovel	
4 Pairs tongs (Assorted patterns)	
Weight: 100lbs nett	Price £100.00
Extra, timber box, with hasp, staple, lock and 2 carrying handles	<u>15.50</u>
	£115.50

Hand Operated Forges

Price source: Vaughans

<i>Model No.</i>	<i>Pan size</i>	<i>Nett Ex-works price</i>
PF 213	18" diameter	£74.67
PF 219	24" diameter	£76.27
PF 231	24" x 18"	£90.13
PF 237	30" x 24"	£97.60
PF 231B	24" x 18"	£90.67
PF 237B	30" x 24"	£98.13
To be introduced:		
PF677	20" x 18" x 4"	Price on application

Power Operated Forges

Price source: William Alldays' Co.

<i>Model No.</i>	<i>Pan size description</i>	<i>Price</i>
MF 237	Backblast, single phase 30" x 24" x 6"	£163.00
MF 237B	Bottomblast, single phase 30" x 24" x 6"	£165.00
MF 151	3 phase 30" x 27" x 8"	£358.00
MF 151	Single phase 30" x 27" x 8"	£332.00

Price source: Cast steel one piece, single bick "London"
Vaughan's pattern hardened tempered face.
 Anvils

56lb	£28.36
100lb	£44.13
168lb	£66.96
196lb	£77.95
224lb	£87.46
392lb	£146.22

Machine tools for larger workshop

Woodworking

Bench mounted drilling machine:	Wolf combined mortise stand and drill with selected mortiser accessories	£200.00
Bench mounted grinder:	Wolf model 8750 6" (150mm) Motor rating 0.35hp 3-phase. Supplied with eyeshields, adjustable tool rests, one coarse and one fine grinding wheel	£80.00
Single purpose hand-held circular saw:	Wolf Sapphire super duty model 6089B with selected accessories	£120.00
Single purpose hand-held jig saw:	Wolf Sapphire model 6528 with selected accessories	£80.00
Tilt arbor saw bench:	Startrite TA/SP 175 Table size 28" x 28" (711mm x 711mm) Table height 34" (864mm) Blade size 10" (254mm) Depth of cut 3 ¹ / ₈ " (79.5mm) Motor 2hp 3-phase Other models available	£375.00
Radial arm saw:	De Walt 10" (250mm) Depth of cut 3" (76mm) Motor 1 ¹ / ₄ hp 3-phase	£336.00
Band saw:	Startrite medium duties series Table size 19" x 19" (480mm x 480mm) Motor 1.25hp 3-phase Model 14S1 (single speed) Model 14S5 (five speed)	£400.00 £420.00
Planing machine:	Surface planer and thicknesser Capacity 12" (305mm) wide x 9" (228mm) deep	£850.00

Metal Working

Bench mounted drilling machine :	Elliot progress No.1 Drilling capacity ½" (12mm) Spindle travel 4" (100mm) Spindle speeds (5) 340-2580 r.p.m. Tilting table 13" x 13" (330mm x 330mm) Motor ½hp 3-phase	£240.00
Floor mounted pillar drilling machine:	Meddings MF5 Drilling capacity 1" (25mm) Spindle travel 5" (127mm) Spindle speeds (8) 100-3000 r.p.m. Table 11" x 10" (280mm x 250mm) Motor 1hp 3-phase	£350.00
Bench mounted grinder:	As listed under Woodworking Machine Tools.	
Pedestal grinder:	Harrison Union model JG10 double ended grinding machine Wheel size 10" (250mm) Spindle speed 2100 r.p.m. Motor ¾hp 3-phase	£250.00
Twist drill sharpening attachment:	Reliance drill grinding jig Three sizes: 1/8"-½" ½"-1" ¼"-2"	£6.30 £16.35 £32.60
Angle grinder:	Wolf Sapphire super duty model 4397 Grinding disc 9" (230mm) 3/16"-3/8" (5mm-10mm) thick Full load watts 2300 Cut-off attachment	£93.00 £70.00
Power hacksaw:	Rapidor Manchester 6" x 6" (152mm x 152mm) light duty model with coolant equipment Motor ½hp 3-phase	£350.00
Air-cooled portable transformer a.c. welder:	Trojan 100 air-cooled arc welder. Welding current 25-100 amps. Input voltage 240V/50Hz/1ph	£55.00

The prices shown are those available from 1977 catalogues and are exclusive of V.A.T. Goods are sold at the prices ruling at the date of invoice. Minimum order clauses sometimes apply to suppliers' terms of business. Suppliers can provide quotations upon receipt of specific inquiries.

Compiled by S. Bonnist, J. Collett
and A. Mallett

Appendix VI

Suppliers' Names and Addresses

	Power tools		
	<i>Wolf Electric Tools Ltd.</i>	<i>Kenya</i>	R.S. Campbell & Co. (1950) Ltd. Box 41155 Nairobi.
<i>Barbados</i>	Central Foundry Ltd. P.O. Box 240 Bridgetown.	<i>Nigeria</i>	C. Zard & Co. Ltd. P.O. Box 818 184 Adeniji Adele Road Lagos.
<i>Brazil</i>	Cobrasfer Rua Sena Madureira 172 Vila Clementino Caixa Postal 4153 Sao Paulo.	<i>Singapore</i>	F.E. Zuellig (Trading) PTE Ltd. P.O. Box 725 Singapore 1.
<i>Dubai</i>	Saasa Traders P.O. Box 1451 Dubai United Arab Emirates.	<i>Thailand</i>	Louis T. Leonowens Ltd. P.O. Box 791, 723 Siphya Road Bangkok.
<i>Egypt</i>	A.Z. Soliman-Elliott Ltd. P.O. Box 641 7, Ahmed Orabi Street Alexandria.	<i>U.K.</i>	Wolf Electric Tools Ltd. P.O. Box 379 Hanger Lane London W5 1DS.
<i>Ghana</i>	Busi & Stephenson (Ghana) Ltd. P.O. Box 1913 Accra.	<i>Venezuela</i>	Distribuidora Bella Vista Apartado 51.283 Caracas 105.
<i>Hong Kong</i>	Auto Electric Ltd. P.O. Box 20641 Hong Kong.	<i>Zambia</i>	Automotive Equipment Ltd. P.O. Box 1759 Lusaka.
<i>India</i>	Rallis India Ltd. 21 Ravelin Street P.O. Box 166 Bombay 1.	<i>Black & Decker Ltd.</i>	
<i>Iran</i>	Bamik Co. Ltd. P.O. Box 11-1659 Roosevelt Shomali Avenue Koutche Darafsh Nos. 38/40 Teheran.	<i>Brazil</i>	Black & Decker (Brazil) Ltd. Rua Clodomiso Amazonas Caixa Postal No.9223 Sao Paulo
		<i>Egypt</i>	Al Farabi Company P.O. Box 1032 Cairo.

<i>India</i>	Kulkarni – Black & Decker Ltd. Project Office Industrial Estate Sangli 41646.	<i>Stanley Power Tools Ltd.</i>	
		<i>Angola</i>	Zuid-Afrikaansch Handelshuis C.P. 1258 Luanda.
<i>Kenya</i>	Black & Decker (Kenya) Ltd. P.O. Box 46827 Nairobi.	<i>Dubai</i>	Sh. Mohd. Rafi Faqhi Awazi & Bros. P.O. Box 122 Dubai United Arab Emirates.
<i>Nigeria</i>	Black & Decker (Nigeria) Ltd. 119 Western Avenue Iponri P.M.B. 3042 Surulere Lagos .	<i>India</i>	Crystal Co. 149 Hatim Manzil Frere Road Carnac Bridge Bombay Crystal Col. 5 Clive Row Calcutta Crystal Co. P.O.B. 544 23 Narindra Place Parliament Street Delhi
<i>Panama</i>	Black & Decker Inter- america SA P.O. Box 4066 Colon Free Zone Colon.		
<i>Puerto Rico</i>	Black & Decker Inc. P.O. Box "Y" Caparra Heights Puerto Rico 00922.		
<i>U.K.</i>	Black & Decker Ltd. Cannon Lane Maidenhead Berks SL6 3PD.	<i>Iran</i>	Gloria Co. Ltd. P.O. Box 12/1598 Teheran.
<i>Venezuela</i>	Black & Decker de Venezuela C.A. Calle Chicago 19 Edificio Black & Decker Urb Los Ruices California Sur Caracas 107.	<i>Jordan</i>	E.S. Abuyaghi P.O. Box 783 Amman.
		<i>Kuwait</i>	Haji Haidar Behbehani & Fils. P.O. Box 53 Kuwait.
<i>Zambia</i>	Black & Decker (Zambia) Ltd. P.O. Box 252 Kitwe.	<i>Libya</i>	Gurgi Trading Association P.O. Box 3415 Tripoli.
		<i>Madagascar</i>	Malagasy-Mivotra-Mividy B.P. 3914 Tananarive Malagasy.

Note: The contact address for the Ivory Coast, Sierra Leone and the Sudan is Black & Decker Ltd, Maidenhead, U.K.

<i>Morocco</i>	Paul Henry B.P. 5029 Casablanca.		P.O. Box 2183 Dacca. Contact: Mr. J. Gomes
<i>Mozambique</i>	Emil Abegg & Cia. Lda. C.P. 78 Maputo.	<i>Canada</i>	Vector Holdings Ltd. 246 Mare Avenue Mississauga Nr. Toronto Canada L56 ITI Contact: M.A. Smith
<i>Oman</i>	General Trading Co. P.O. Box 84, Muscat.		
<i>Qatar</i>	Ibrahim Mohamed Qassem Fakhroo Trading Estate P.O.B. 77 Doha.	<i>Greece</i>	John H. Fenagiotakis 7 Nirvana Street Ned Fahron Piraeus. Contact: Mr. Panagiotakis
<i>Sudan</i>	Al Berero Trading & Engineering P.O. Box 78 Khartoum.	<i>Indonesia</i>	P.T. Sande Jaya Indonesia Speed Building Jalan Gajah Mada 18 Jakarta. Contact: Mr. Ridwan Hadikusur
<i>Tunisia</i>	Jegham Mohamed B.P. 271 Tunis.		
<i>Turkey</i>	Isak Garih B.P. 869 Istanbul.	<i>Jordan</i>	Munir Sukhtian Ltd. P.O. Box 1027 Amman. Contact: Mr. N. Sukhitian
<i>U.K.</i>	Stanley Power Tools Ltd. Nelson Way Cramlington Northumberland NE23 9JS.	<i>Kenya</i>	Alibhai Shariff Ltd. P.O. Box 40382 Nairobi. Contact: Mr. Shariff
<i>Zaire</i>	RUF Zaire B.P. 14199 Kinshasa.		United Auto Tools Ltd. P.O. Box 40995 Nairobi. Contact: Mr. R. Patel
<i>Zambia</i>	N.I.E.C. Agencies P.O. Box 1384 Lusaka.	<i>Malawi</i>	John Short P.O. Box 991 Blantyre. Contact: Mr. J. Short
Smithy Equipment			
<i>Vaughans (Hope Works) Ltd.</i>		<i>Malaysia</i>	Scott & English Ltd. P.O. Box 324 468 Ipoh Road Kuala Lumpur 13-04. Contact: Mr. Yap Sin Bin
<i>Bangladesh</i>	Purbadesh Prokausuali Ltd. 51 Motijheer C.A. Akhtar Building		

<i>Nigeria</i>	Stokvis (Nigeria) Ltd. 1 Dawodu Lane Ebute Metta Lagos. Contacts: Mr. H. Kroon — Lagos Mr. Daramola — Kano	<i>U.K.</i>	Vaughans (Hope Works) Ltd. P.O. Box 2 Hope Street Dudley West Midlands DY2 8RD.
<i>Pakistan</i>	A. Sulemanji & Co., 38 Sir Jehangir Kothari Building M.A. Jinnah Road P.O. Box 226 Karachi 0127. Contact: Mr. M. Husain	<i>USA</i>	Milwaukee Tool & Equipment Co. Ltd. P.O. Box 2039 Milwaukee Wisconsin 53201. Contact: M.R. Gutenkust
<i>Qatar</i>	Mars Trading Ltd. P.O. Box 148 Doha. Contact: Mr. Abdul Gani	<i>Zambia</i>	John Short P.O. Box 2549 Lusaka. Contact: Mr. J. Short
<i>Saudi Arabia</i>	Munir Sukhtian Ltd. P.O. Box 1027 Riyadh. Contact: Mr. N. Sukhitian	Wood and engineering Tools	
<i>Singapore</i>	Scott & English Ltd. M & E Centre 154-170 Clemenceau Avenue Singapore 9. Contact: Mr. T. Poon	Buck & Hickman Ltd. Export Division Sterling Industrial Estate Rainham Road South Dagenham Essex RH10 8TA U.K.	
<i>South Africa</i>	Cape Province & Namibia	Stanley Tools Woodside Sheffield S3 9PD U.K.	
	Cape Hardware Tool & Supply Co. Ltd., 11 Lower Burg Street Cape Town Contact: Mr. Van Der Hoff	<i>or</i>	
<i>Transvaal,</i> <i>Orange Free</i> <i>State & Natal</i>	E.W. Tarry Ltd. P.O. Box 254 Eloff Street Springfield Johannesburg. Contact: Mr. J.S. Wooton	Stanley Bridges Ltd. Nelson Way Cramlington Northern Ireland NE23 9JS U.K.	
		Spear & Jackson (Ashbury) Ltd Bowling Green Street Sheffield S3 85Y	

Hand tools – wood/metal

James Neill (Sheffield) Ltd.
Napier Street
Sheffield S11 8HB
U.K.

Power forges

William Allday & Co. Ltd.,
Alcosta Works
Stanport on Severn
Worcestershire
U.K.

(Address of overseas agents available
on request)

Compiled by S. Bonnist