

AT MICROFICHE
REFERENCE
LIBRARY

A project of Volunteers in Asia

A Manual on Sharpening Hand Woodworking Tools

by: J.K. Coggin, L.O. Armstrong, and G.W. Giles

Published by:

The Interstate Printers & Publishers, Inc.
19-27 North Jackson Street
P.O. Box 594
Danville, IL 61832-0594 USA

Paper copies are \$11.00.

Available from:

The Interstate Printers & Publishers, Inc.
19-27 North Jackson Street
P.O. Box 594
Danville, IL 61832-0594 USA

Reproduced by permission of The Interstate
Printers & Publishers, Inc.

Reproduction of this microfiche document in any
form is subject to the same restrictions as those
of the original document.

A MANUAL
on
SHARPENING
Hand Woodworking
TOOLS

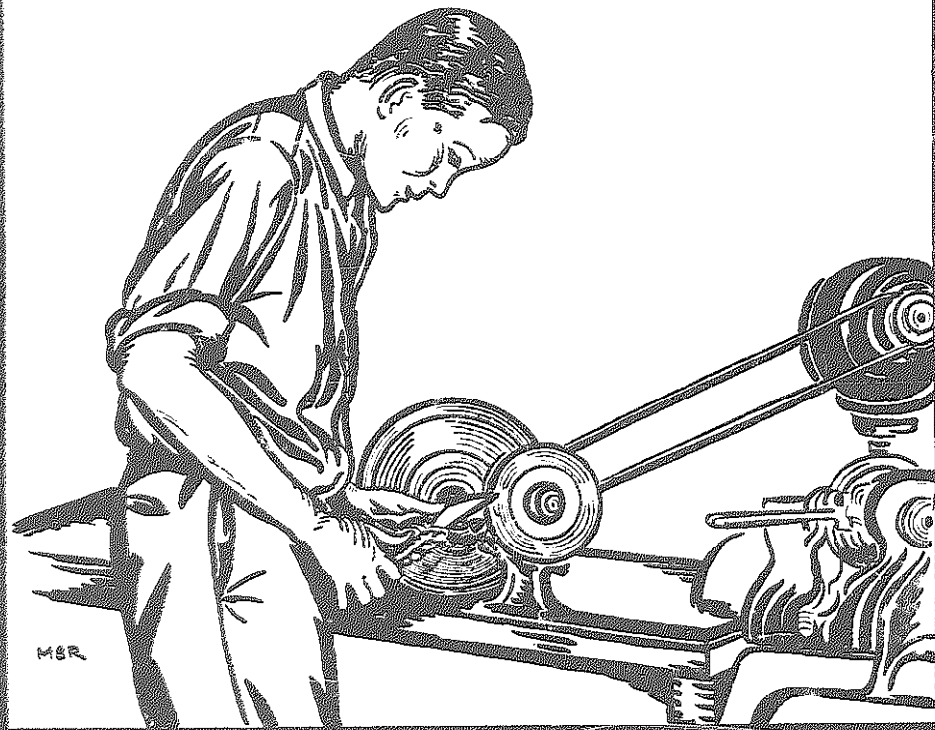

COGGIN
ARMSTRONG
GILES

All Rights Reserved
by
THE INTERSTATE
Printers & Publishers, Inc.
Danville, Illinois

A Manual
on
Sharpening Hand Woodworking Tools

By

J. K. COGGIN
Professor of Agricultural Education

L. O. ARMSTRONG
Associate Professor of Education in Charge of Visual Instruction

G. W. GILES
Associate Professor of Agricultural Engineering

North Carolina State University
at Raleigh

ACKNOWLEDGMENTS

The full-page charts in this book, except page 37, were taken from Bulletin 2, "Helps on Sharpening Hand Woodworking Tools," prepared by the same authors and published by the Department of Education, North Carolina State University at Raleigh.

The demand for the above bulletin has been far greater than the supply. Only a limited number of copies have been available to teachers of vocational agriculture in North Carolina. No copies have been available to teachers or students outside the State.

The original charts have been supplemented by full directions on methods of sharpening each woodworking tool and additional visual aids have been added for both the teacher and the student.

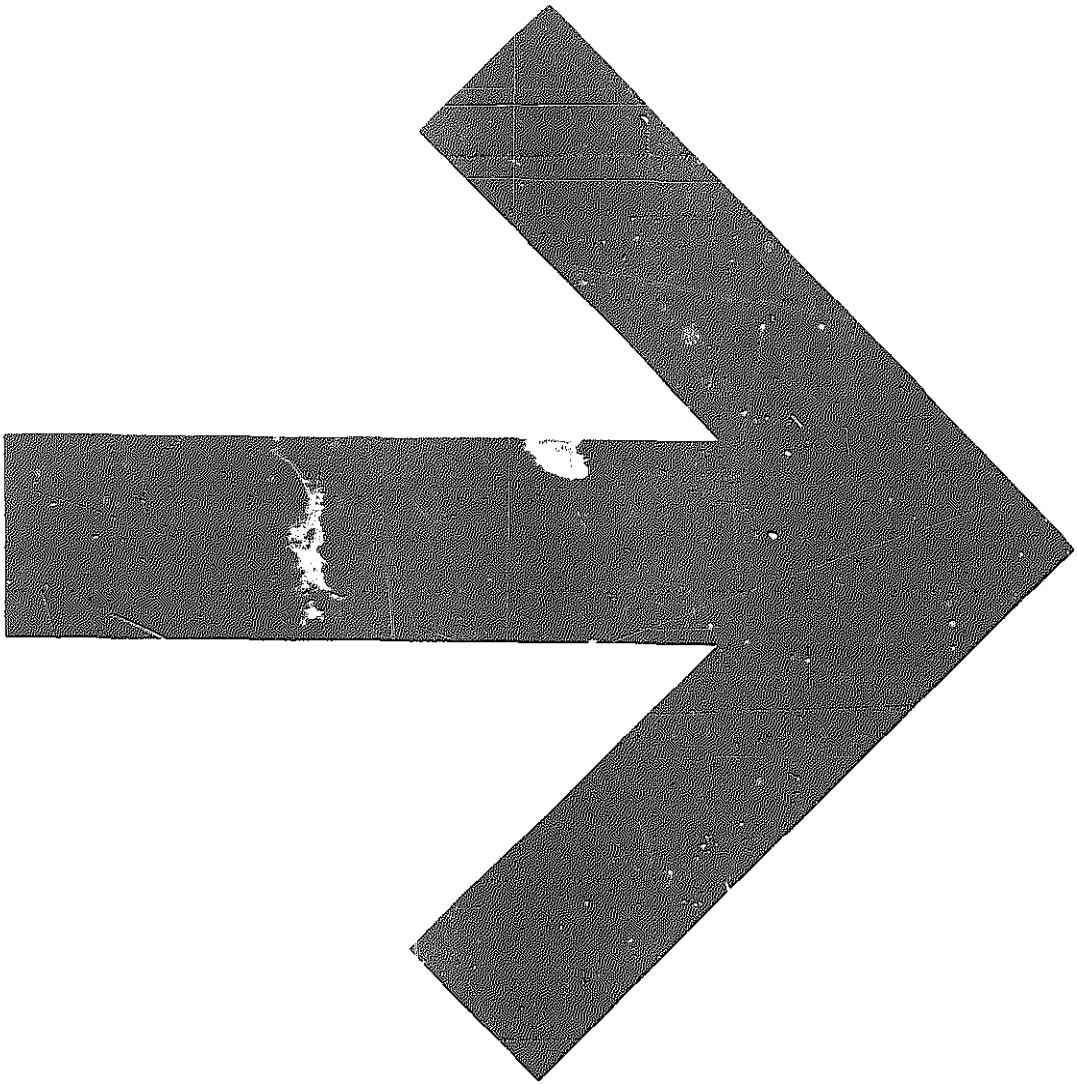

INDEX

Acknowledgments.....	2
Preface.....	4
Suggestions to the student.....	6
Suggestions to the teacher.....	6
Hand tools.....	7
Grinding a wood chisel.....	11
Grinding a plane iron.....	13
Whetting a plane iron and a wood chisel.....	17
Cutting hand saw teeth.....	21
Sharpening hand saws — crosscut and rip.....	25
Sharpening crosscut timber saw.....	31
Sharpening auger bit.....	35
Sharpening knives.....	37
Sharpening axe and hatchet.....	39
Sharpening cabinet scraper.....	43
Grinding screw driver.....	45
Glossary.....	46

Preface

Education comes through experience. There are two kinds of experience—that within the individual, the familiar; and that without the individual, the unfamiliar. Those things with which he is familiar, which he knows or can do, we shall call “old” experiences. Those things with which he is not familiar, which he does not know or cannot do, we shall call “new” experiences.

We always use the “old” with the “new” in a learning situation. A satisfactory learning situation is usually had when there is a balance between the old and the new—when there is not too much new in proportion to the old. There must be interaction of the old and the new if we are to learn. Teaching and learning is, therefore, a continuous process of remaking experience.

One of the problems of the teacher, especially the shop teacher, is to delay actual practice by the student long enough for him to develop an understanding through observation and study of the correct procedure. The greatest weakness in our shop instruction is allowing the student to “practice the doing” before he is prepared to do it—before he understands what he is to do, before he has built up sufficient “new experience” to proceed with the doing intelligently.

The following outline, “Total Experience Necessary in Learning to File a Saw,” affords an excellent illustration of the necessity for building up “new experience” before attempting actually to do the job. Usually the student will go direct from his old experience (outlined under I) to the complex new experience (outlined under III). He is hopelessly lost. He lacks the previous observation, and in this case, practice in cutting out saw teeth (outlined under II) to enable him to proceed with filing the saw intelligently. The required “new experience” for doing the job is out of balance with his “old experience.”

If we expect the boy to learn to file the saw, we must first provide him with a way to “see” and understand what saw teeth are like and just how they should be shaped to do good cutting. He must have a fixed pattern in mind toward which to work. Cutting out larger teeth serves this purpose.

A job thoroughly understood is usually very simple. Doctors sometimes say, “This man’s case is hopeless. His disease is incurable.” What they should say is, “We do not understand this disease. We cannot cure this man.” The method for the prevention of typhoid fever was not understood many years ago. Today, the prevention of this disease is a very simple procedure.

TOTAL EXPERIENCE NECESSARY IN LEARNING TO FILE A SAW. For A Given Farm Boy —

I. "OLD" EXPERIENCE

<u>SPECIFIC</u>	<u>GENERAL</u>
A Saw Has Teeth And Handle; It Cuts And Binds, etc.	How To Measure; Count Spaces; Mark; Angles; 90°, 45°, etc.

II. "NEW" EXPERIENCE

<u>INFORMATION</u>	<u>APPLICATION</u>
What, How And Why Of Size, Shape, Set; Jointing, Setting, etc. Of Saw Teeth	Lay Out, Cut Out, Joint, File And Set The Teeth On A Large Model Of Saw Teeth.

III. "NEW" EXPERIENCE FOR SKILL DEVELOPMENT
Select A Saw Which Needs Filing And Joint It;
Shape, Set And File The Teeth.

IV. PRACTICE FOR FURTHER SKILL DEVELOPMENT
Repeat Practice Until A Reasonable Degree Of Skill Has Been Developed.



The correct method for filing a saw is not understood by many boys or men. Many attempt to file before they understand and failure results. Study and observation must precede the practice—practice in accordance with tested methods. Follow the correct method and the job becomes very simple.

Emphasis is given to the "why" and the "how" in all the sharpening procedures set up in this book. The text materials should be studied before undertaking the practices.

Suggestions to the Student:

This little book has been prepared to help you properly sharpen some of the more common woodworking tools. The directions and methods of sharpening these tools were developed especially for students in farm shop classes in rural schools and in industrial arts and woodworking classes. It should also be equally helpful to home craftsmen.

A sharp tool is necessary in order to do any type of woodwork with accuracy and satisfaction. In starting the construction part of a woodworking job the first thing to do is to sharpen your tools. Study these illustrations and directions carefully before trying to sharpen the tools. In some cases considerable practice will be required to develop the necessary skill's. Follow the full directions and avoid short cuts. Ask your teacher for help on points you do not understand and on the skills you have difficulty developing.

REMEMBER IT IS A GOOD RULE NEVER TO WORK WITH A DULL TOOL.



Suggestions to the Teacher:

Methods for properly sharpening the common woodworking tools are given and illustrated step by step in this book. However, the teacher should not expect these directions to take his place as instructor.

It is suggested that the methods be demonstrated as outlined, showing the student each step in the sharpening process. This will aid the student to understand more clearly the steps he is to take. The student must understand the new skills to be learned before he can properly practice them and test his results. Careful demonstration by the teacher prepares the student to do the job with understanding. The student should be constantly supervised as he attempts the more difficult operations.

In using this book it is suggested that the teacher do the following:

1. Read the full directions for sharpening the tool at hand.
2. Study the illustrations of methods step by step.
3. Practice the steps until he is sure he can do the job according to the directions.
4. Demonstrate to the student the steps of sharpening the tool. Call attention to the more difficult operations; repeat the demonstration of the more difficult steps for emphasis in order that the student may more clearly understand.
5. Supervise the student in his practice.
6. Stress the importance of doing the job well.
7. Evaluate the student's practice and give encouragement for progress made.

HAND TOOLS

Why They Cut

The hand tool is one of man's oldest implements. The first tool was perhaps a stone hammer, but man's ingenuity soon led to the development of cutting tools made from flint stone.

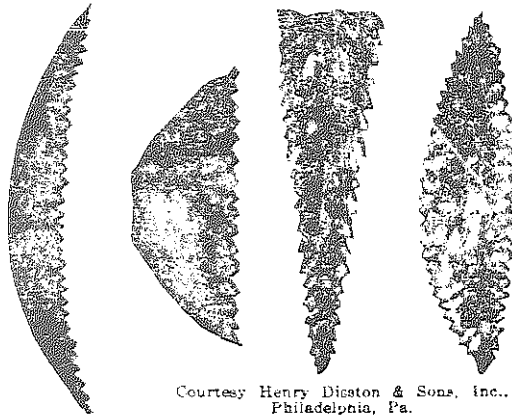

Courtesy Henry Disston & Sons, Inc., Philadelphia, Pa.

Figure 1.

However, the edge of the modern tool is sharper. Ordinarily the tool is held so the cutting edge digs in instead of sliding over the material. Thus the tool cuts the fibers rather than scratches or tears them out. Figure 3 shows this principle as applied to a common wood chisel.

Metal in Hand Tools

Great strides have been made in developing our modern tools from the primitive stone tool. The most nota-

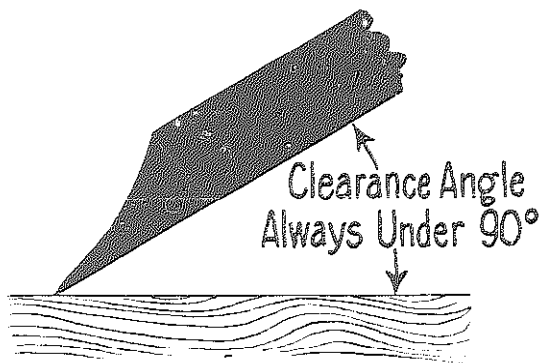

Figure 3.

ble advancement is in the use and treatment of steel for particular jobs. The following explanation does not tell the complete story of iron and steel as known by the metal specialists. The average shop worker does not need to know the technical details.

Iron is a product of nature mined from the earth. It is found in combination with various other elements, one of which is carbon. This mixture is called iron ore. When these elements are removed the product is a metal called iron. Steel is made from iron by purifying it and changing the carbon content. Elements such as carbon, manganese, tungsten and nickel are added to secure desirable properties depending upon the use of the tool.

Modern cutting tools, whether hand or power, work on this same principle.

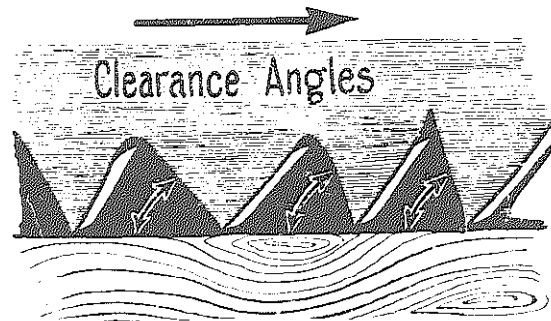

Figure 2.

Iron is a product of nature mined from the earth. It is found in combination with various other elements, one of which is carbon. This mixture is called iron ore. When these elements are removed the product is a metal called iron. Steel is made from iron by purifying it and changing the carbon content. Elements such as carbon, manganese, tungsten and nickel are added to secure desirable properties depending upon the use of the tool.

Iron is a product of nature mined from the earth. It is found in combination with various other elements, one of which is carbon. This mixture is called iron ore. When these elements are removed the product is a metal called iron. Steel is made from iron by purifying it and changing the carbon content. Elements such as carbon, manganese, tungsten and nickel are added to secure desirable properties depending upon the use of the tool.

A good tool metal should be:

1. Hard: A hard metal will resist wear and the cutting edge will remain sharp.
2. Tough: A tough metal will stand greater strains and shocks without breaking.

Steel, if properly treated, will be harder and tougher than iron. There are various grades and qualities of wood. Likewise, there are various grades and qualities of steel. However, the grades and qualities of steel may be controlled by man. In general there are two types of steel: (1) carbon steel and (2) alloy steel.

Carbon steel owes its hardness and toughness to the amount of carbon it contains and its treatment under heat. It is known as "high carbon" or "low carbon" depending upon the amount present.

Alloy steel is a carbon steel with the addition of other elements such as nickel, chromium, copper, vanadium, etc. These elements affect the hardness and toughness of the steel.

Up to a certain amount the more carbon in either type of steel the harder and more brittle (less tough) it becomes. Any high carbon steel may be changed in hardness and toughness by giving it a heat treatment. It may be (1) hardened, (2) tempered, or (3) annealed.

(1) Hardened:

When a high carbon steel is heated to a cherry red color and suddenly cooled by plunging in water it becomes hard and brittle.

(2) Tempered:

This hardened steel would probably break if hit because it is too brittle. To toughen, it must be made less brittle. This process is called tempering. Unfortunately the process softens the metal. A small amount of heat is applied to soften the metal. After it is properly softened the steel is quickly cooled again.

(3) Annealed:

A steel that has been hardened may be softened back to its original condition by simply heating the steel to a cherry red color and allowing it to cool slowly.

The addition of an element such as nickel to the carbon steel permits the steel to be hardened by slower cooling. As a result the metal is not as brittle and is less likely to crack. Our best tools are made of alloy steel. They are harder and tougher. The first cost of good tools is greater but they will last much longer and in use will retain a sharp edge longer.

General Principle of Sharpening a Hand Tool

All tools are sharpened by other cutting tools. The material in the sharpening tool is harder than the material being sharpened. Various kinds of stone and files are the most common sharpening tools. A stone is a mass of very small crystals called grit. Each crystal has sharp edges (Fig. 4) that cut like the stone saw of the early ages. The action

of the file is similar. The rate at which these tools cut depends upon (1) coarseness and sharpness of the grit or teeth, and (2) speed at which the cutting edge moves and (3) amount of pressure applied.

In some stones fast cutting is secured by a high rate of speed such as in the motor grinder. The friction in this cutting action causes heat. This heat if not controlled will cause the tool to become soft or annealed. We say it has lost its temper. Actually it has been tempered because tempering is a softening process. Excessive heat will cause the metal to become blue. We say it is burned. Actually, this blue color is merely a surface indication that the metal is soft.

When a tool is sharpened on a whetstone or with a file, the speed is not great enough to cause excessive heat. Water is used on a slow speed revolving stone to keep the metal cool. Slow sharpening is an ideal way to sharpen any cutting tool.

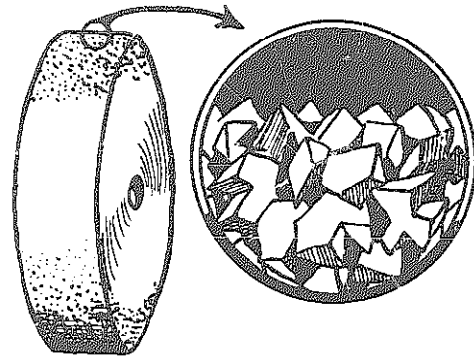
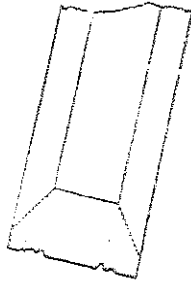

Figure 4.

GRINDING WOOD CHISEL



GRIND.

① WHEN EDGE IS NICKED, —

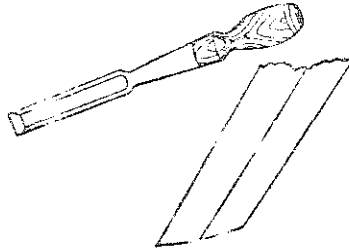

② WHEN CONCAVE BEVEL HAS BEEN REMOVED BY WHETTING —

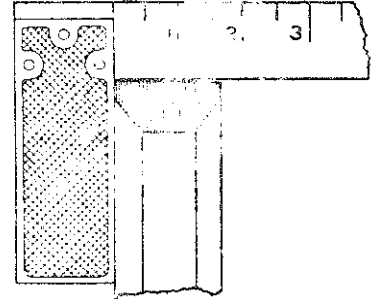

③ WHEN EDGE IS NOT SQUARE

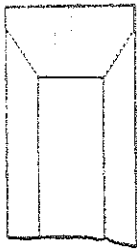

④ SHAPE CUTTING EDGE THUS:

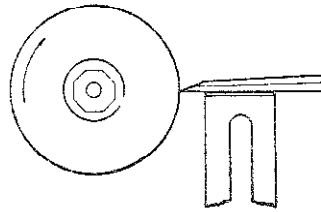

For Jointing

⑤ PLACE IRON AT LEVEL OF CENTER OF STONE,

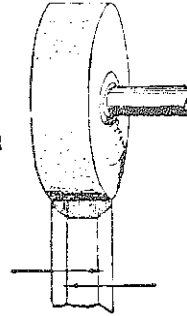

MOVE IRON RIGHT & LEFT,

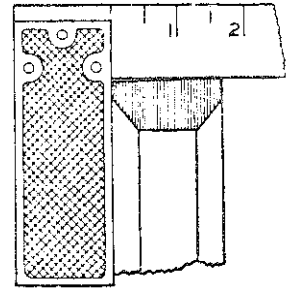

TEST EDGE FREQUENTLY FOR SQUARENESS.

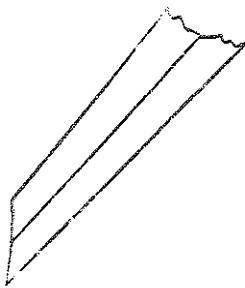

USE:

⑥ BLUNT BEVEL FOR MORTISING

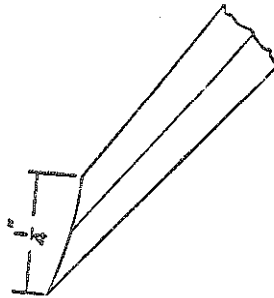

⑦ MEDIUM BEVEL FOR GENERAL WORK

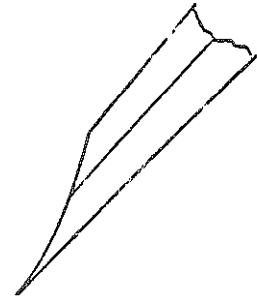

⑧ AND A LONG BEVEL FOR FINE PARING WORK

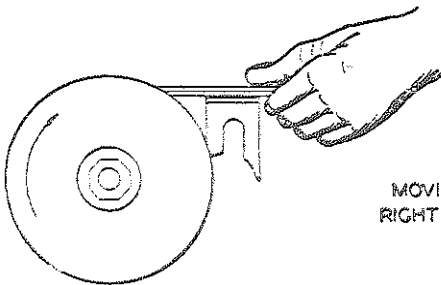

⑨ GRIND THE BEVEL WITH GRINDER TURNING TOWARD CUTTING EDGE —

MOVING IRON RIGHT & LEFT

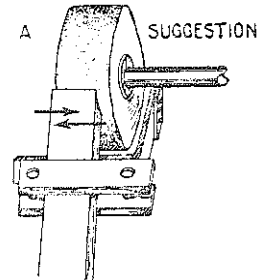
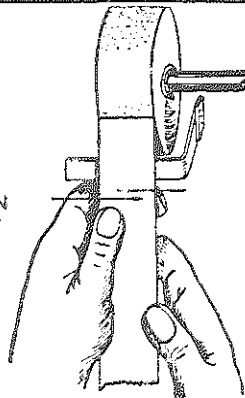

⑩ LIGHT STRAP IRON OR HEAVY GALVANIZED IRON

Chart 1

GRINDING A WOOD CHISEL

Chart 1, Page 10

Problem

- To learn the difference between grinding and whetting.
- To learn how to grind.

Words to Look up in the Glossary

Concave, convex, bevel, whetting, grinding, nick, gap, wire edge, temper, jointing, keen.

Note:

The wood chisel may be sharpened either by grinding and whetting or by whetting, depending upon its condition. The cutting end of a wood chisel has one flat side and one beveled side (Fig. 5). The beveled side is concave and is put on the chisel during the grinding operation.

When and Why to Grind:

Grind a wood chisel when:

1. The edge is nicked (Chart 1, No. 1).*
2. The concave bevel has been removed by whetting (No. 2).
3. The edge is not square (No. 3).

If the chisel is nicked or gaped, it does not enter wood easily and the gaps leave ridges in the wood.

A chisel is whetted frequently in order to maintain a keen edge. This repeated whetting tends to change the concave bevel to a straight or even a convex bevel, thus making the chisel blunt and dull. A concave bevel forms a sharper wedge and enters wood very easily.

A chisel which is not reasonably square tends to move sideways when forced into wood, making it impossible to do smooth and accurate work.

Materials Needed

Wood chisel, try square, water for cooling, grinder. The grinder must be smooth and round with its face clean and parallel with the tool rest.

How to Grind

Adjust the tool rest to the level of the center of the stone. Place the flat side of the chisel on the tool rest (No. 5) and grind the cutting edge until the nicks are removed and

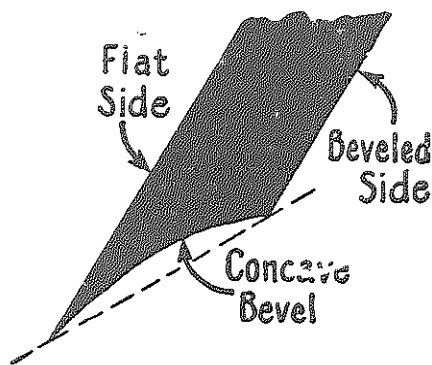

Figure 5.

*All reference subsequently to No. 1 or No. 2, etc., refers in each instance to the drawing of that number in the chart accompanying that chapter.

the edge is square. Move the chisel right and left to wear the stone and the chisel uniformly. Cool the edge frequently by dipping in water. Heat caused by friction will remove the temper from the metal and soften it. Soft metal will not hold its edge. Blue color appearing while grinding is proof that the temper is damaged. Check the edge for squareness (No. 3).

The proper length of concave bevel is next ground on the blade (No. 9). If the chisel is always placed on the stone at exactly the same angle, the roundness of the stone will produce the desired concave bevel. The angle at which the chisel contacts the stone determines the length of the bevel. A blunt bevel (No. 6) less than $\frac{1}{4}$ inch in length is better for heavy work and hard wood where strength in the cutting edge is required. A long bevel (No. 8) greater than $\frac{1}{4}$ inch in length gives an extremely keen cutting edge and is better for fine paring work. A medium bevel (No. 7) about $\frac{1}{4}$ inch long is recommended for the average shop job. This bevel should seldom be changed except for special jobs.

Adjust the tool rest so the chisel will make the proper angle with the stone. If the tool rest cannot be adjusted, place the chisel against the rest to make the proper angle. Use the fingers of the left hand against the tool rest as a guide to replace the chisel at the same angle after each cooling. With practice one can tell by the feel when the chisel is replaced so that the concave bevel fits the roundness of the stone. The suggestion in No. 10 is helpful with either kind of tool rest.

Grind the bevel by having the grinder turn towards the cutting edge (No. 9). There will be less wire edge formed. Slowly move the chisel right and left to wear the stone and the chisel evenly. Do not bear too hard as this may remove the temper.

Don't Hurry. Cool Frequently. Continue the grinding until a wire edge is produced on the flat side and the bevel is of the correct length.

Final Test

Check with try square (No. 5) to determine if the edge of the chisel is square. Run the thumb along the edge on the flat side to determine if the wire edge extends the entire length of the edge.

See page 19 for directions on whetting, the second and final step in sharpening a wood chisel.

GRINDING A PLANE IRON

Chart 2, Page 14

Problem

To learn the difference between grinding and whetting.
To learn how to grind.

Words to Look up in the Glossary

Concave, convex, bevel, whetting, jointing, keen, grinding, nick, gap, wire edge, temper.

Note:

The plane iron is simply a wood chisel which is held in a frame so the depth of cut may be controlled. It may be sharpened either by grinding and whetting, or by whetting alone, depending on its condition. The cutting end of a plane iron has one flat side and one beveled side (Fig. 6). The beveled side is concave and is put on the plane iron during the grinding operation.

When and Why to Sharpen

Sharpen a plane iron when:

1. The edge is nicked (No. 1).
2. The concave bevel has been removed by whetting (No. 2).
3. The edge is not square (No. 3).

If the plane iron is nicked or gapped, it does not enter wood easily and the gaps leave ridges in the wood.

A plane iron is whetted frequently in order to maintain a keen edge. The repeated whetting tends to change the concave bevel to a straight or even a convex level, thus making the edge blunt and dull. A concave bevel forms a sharper wedge and enters wood very easily.

If the plane iron is not reasonably square, it is difficult to adjust it so that it will make an even cut.

Material Needed

Plane iron, try square, plane iron cap, water for cooling, grinder. The grinder must be smooth and round with its face clean and parallel with the tool rest.

How to Grind

Three shapes of the cutting edge are shown in No. 4. A slightly curved cutting edge is best for fast and rough work. This edge when set deep cuts the wood fibres on the sides instead of tearing them (Fig. 7). For general work, where a deep cut is unnecessary, grind the edge square and round the corners slightly. This insures an even cut necessary for a fine fit. The cutting edge shaped for general work should seldom be changed except for a special job.

To produce any of these edges, adjust the tool rest to the level of the center of the stone. Place the flat side of the plane iron on the tool rest and joint as shown in No. 5.

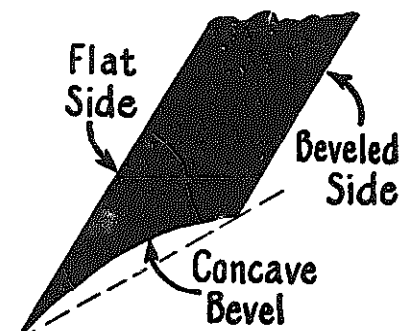
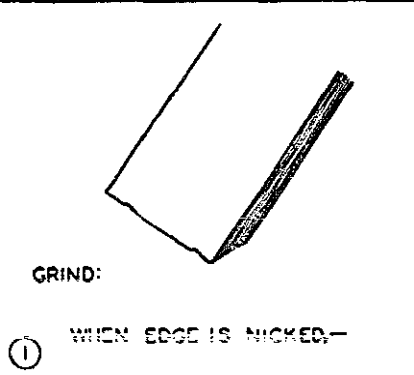

Figure 6.

GRINDING PLANE IRON

GRIND:



① WHEN EDGE IS NICKED.—

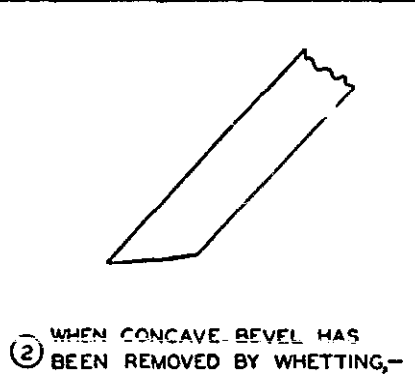

② WHEN CONCAVE BEVEL HAS BEEN REMOVED BY WHETTING,—

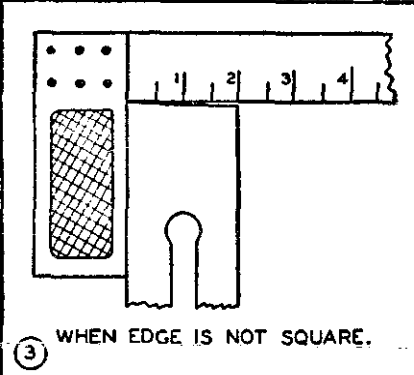

③ WHEN EDGE IS NOT SQUARE.

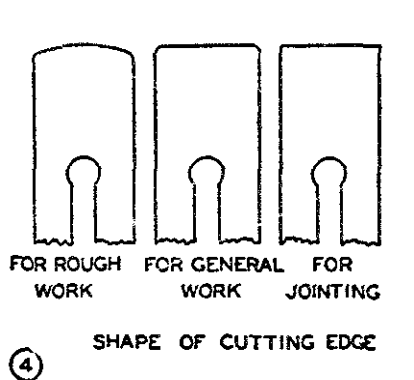

④ SHAPE OF CUTTING EDGE
FOR ROUGH WORK FOR GENERAL WORK FOR JOINTING

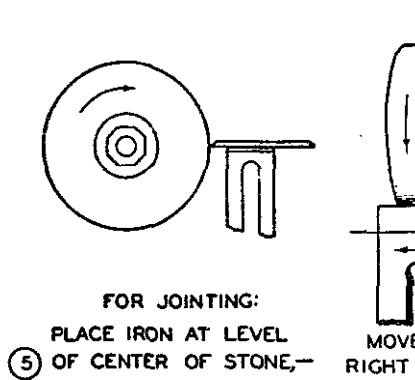

⑤ FOR JOINTING:
PLACE IRON AT LEVEL OF CENTER OF STONE,—
MOVE IRON RIGHT & LEFT,—

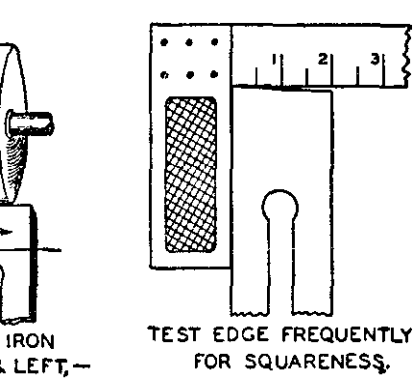

⑥ TEST EDGE FREQUENTLY FOR SQUARENESS.

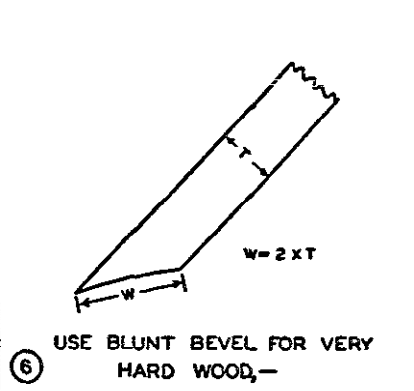

⑥ USE BLUNT BEVEL FOR VERY HARD WOOD,—

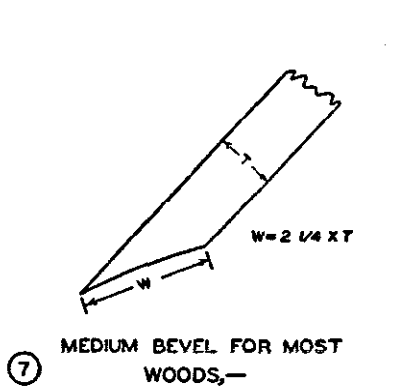

⑦ MEDIUM BEVEL FOR MOST WOODS,—

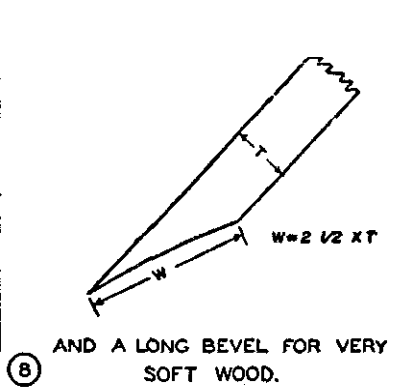

⑧ AND A LONG BEVEL FOR VERY SOFT WOOD.

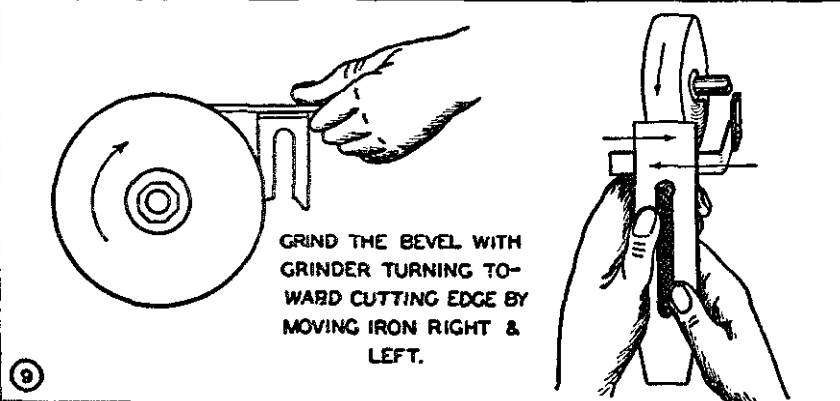

⑨ GRIND THE BEVEL WITH GRINDER TURNING TOWARD CUTTING EDGE BY MOVING IRON RIGHT & LEFT.

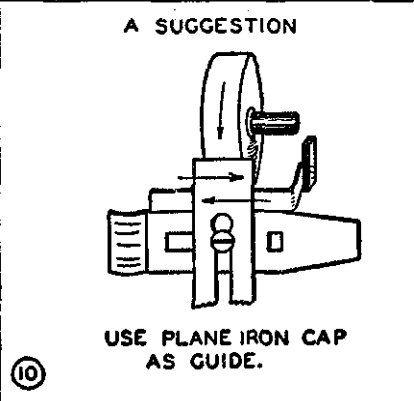

⑩ A SUGGESTION
USE PLANE IRON CAP AS GUIDE.

Chart 2

Grind until the desired shape of cutting edge is attained and the nicks are removed. Move the plane iron right and left to wear the stone and the plane iron uniformly. Cool the edge frequently by dipping it in water. Heat caused by friction will remove the temper from the metal and soften it. Soft metal will not hold its edge. Blue color appearing while grinding is proof that the temper is damaged. Check the edge for squareness (No. 5).

We are now ready to grind the bevel.

Different lengths of concave bevels are shown in Nos. 6, 7 and 8. A blunt bevel (No. 6) is better for heavy work and hardwood where strength is required for cutting. A long bevel (No. 8) gives an extremely keen cutting edge and does fine work in soft wood where strength is unnecessary. A medium bevel (No. 7) is recommended for ordinary work or average wood. This bevel should seldom be changed except for special jobs.

The angle at which the plane iron contacts the stone determines the length of the bevel. If the plane iron is always placed on the stone at exactly the same angle, the roundness of the stone will produce the desired concave bevel.

Adjust the tool rest so the plane iron will make the proper angle with the stone. If the tool rest cannot be adjusted, place the plane iron against the tool rest to make the proper angle. Number 10 shows how the plane iron cap may be used as a guide with any type of tool rest.

Grind the bevel by having the grinder turn towards the cutting edge (No. 9). There will be less wire edge formed. Slowly move the plane iron right and left to wear the stone and the plane iron evenly. Do not bear too hard as this may remove the temper. **Don't Hurry. Cool Frequently.** Continue the grinding until a wire edge is produced on the flat side and until the bevel is of the correct length.

Final Test

Check with try square (No. 5) to determine if the edge of the plane iron is square. Run thumb along edge on flat side to determine if wire edge extends entire length of edge.

See page 18 for directions on whetting, the second and final step in sharpening a plane iron.

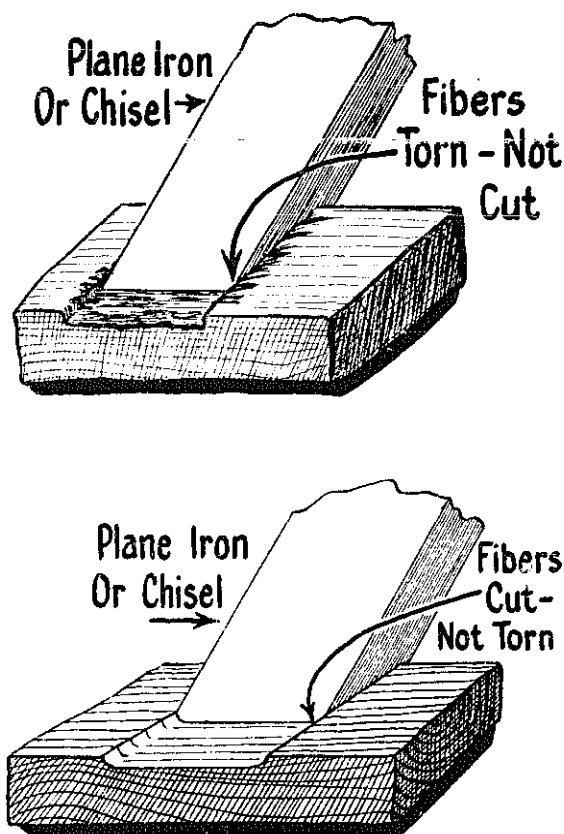
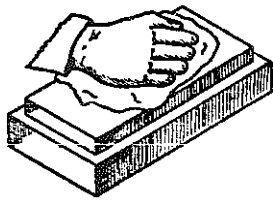

Figure 7.

WHETTING PLANE IRON AND WOOD CHISEL

WHET

1. AFTER GRINDING.
2. WHEN DULL BUT DOES NOT REQUIRE GRINDING



CLEAN OILSTONE THOROUGHLY WITH RAG.

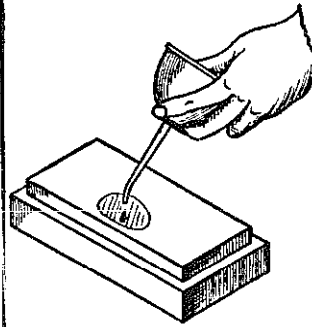

APPLY CLEAN LIGHT OIL TO STONE.

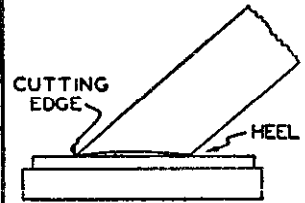

PLACE IRON ON STONE KEEPING CUTTING EDGE IN CONTACT. HEEL LIGHTLY IN CONTACT OR SLIGHTLY RAISED.

①

②

③

④

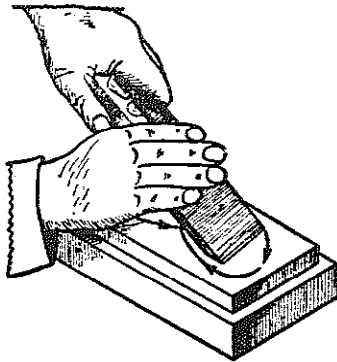

WHET WITH CIRCULAR MOTION—

⑤

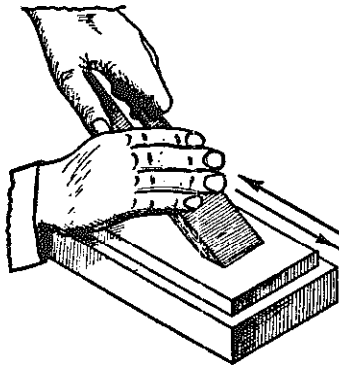

OR WITH BACK AND FORTH MOTION.

⑥

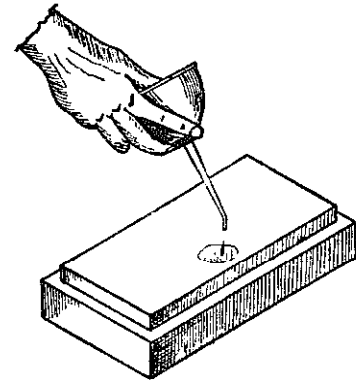

ADD FRESH OIL AS NEEDED.

⑦

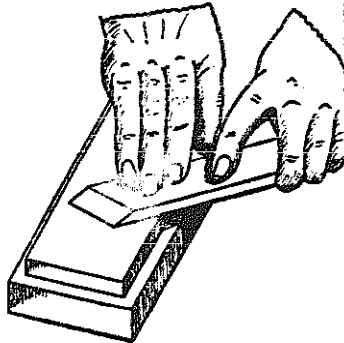

BEGIN REMOVAL OF WIRE EDGE WITH UNBEVELED SIDE FLAT ON STONE.

⑧

REPEAT OPERATIONS SHOWN IN FIGURES 5 AND 8.

⑨

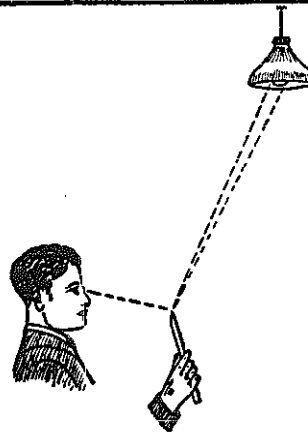

UNTIL EDGE DOES NOT REFLECT LIGHT—

⑩

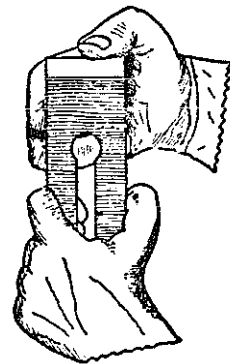

OR UNTIL EDGE FEELS SMOOTH AND KEEN UNDER THUMB TEST.

⑪

Chart 3

WHETTING A PLANE IRON AND A WOOD CHISEL

Chart 3, Page 16

Problem

To learn how to whet a plane iron and a wood chisel.

Words to Look up in the Glossary

Whetting, wire edge, glazed, grit, edge tool.

When and Why to Whet

Whet plane iron or chisel (No. 1):

1. After grinding.
2. When it is dull but does not require grinding.

After grinding, the cutting edge is left rough and is called a wire edge. A keen cutting tool must have this wire edge removed by whetting.

When an edge tool becomes slightly dull, the edge will look bright due to the fact that it is rounded rather than sharp (Fig. 8). This dullness may be removed by whetting.

Materials Needed

Wood chisel or plane iron, oilstone, light oil, cotton waste or rags.

Preparing the Stone

The oilstone should be thoroughly cleaned with a piece of cotton waste or soft rag (No. 2). The use of gasoline is helpful. A stone saturated with oil will collect dust. If this dust is not removed before whetting, it will be rubbed into the stone. The whetting process is one of cutting away metal. This cutting action depends upon the little sharp points of each small particle in the stone. Dust mixed with oil will gum the pores of the stone and prevent the sharp particles from doing their work.

Apply clean light oil to the stone (No. 3). The purpose of the oil is to float off particles of metal as they are cut from the blade. If these particles are not floated away, they will become imbedded in the pores of the stone, producing a glazed surface that will not cut. A penetrating oil or any light non-gumming oil is very good for this purpose. Light engine oil mixed half and half with kerosene is satisfactory.

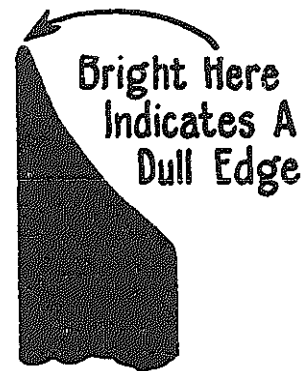

Figure 8.

How to Whet

Place the bevel of the tool on the stone so that the cutting edge is in contact and the heel is in contact or is slightly raised. Maintaining this position, use either a circular motion (No. 5) or a back and forth motion (No. 6). **ONLY A FEW STROKES ARE NECESSARY.**

Utilize as much of the stone as possible so as to prevent the stone's becoming hollow in the center. It is impossible to keep a square cutting edge on a tool unless the stone is perfectly flat.

Keep plenty of oil on the stone (No. 7).

Whet the flat side of the blade. Be certain the blade is held absolutely flat on the stone. If it is raised the slightest amount, a bevel will be produced on the flat side. **ONLY A FEW STROKES ARE NECESSARY.** After a few strokes on the stone remove the excess wire edge by rubbing the cutting edge across the grain of a piece of hardwood. This leaves fewer metal particles to clog the stone and shortens the process of whetting. Continue with a few whetting strokes to produce a keen edge. Test the edge for sharpness (No. 10 or 11). If necessary, repeat the process of whetting on either or both sides to produce a keen edge. Unnecessary whettins oil and metal particles.

Clean stone after using to remove excess will remove the concave bevel.

Final Tests

The edge may be tested for sharpness by either of two methods:

1. Look at the edge in a bright light (No. 10). If the edge is sharp, it will not reflect light, that is, you cannot see the edge. A dull edge will look bright.
2. Draw the thumb or finger lightly across the edge (No. 10). If the edge is sharp, it will feel smooth and stick to the finger. If the edge is smooth, it simply means that some wire edge or some minute gaps are still present.

CUTTING HAND RIP SAW TEETH

WHEN HANDSAW TEETH HAVE BEEN BROKEN OFF GRIND DOWN TO BASE OF TEETH AND CUT NEW TEETH.

SUGGESTION: — BEFORE WORKING ON A GOOD SAW PRACTICE ON AN OLD SAW BLADE OR PIECE OF 12 GAUGE SHEET METAL.

①

5 POINTS PER INCH
4 TEETH PER INCH

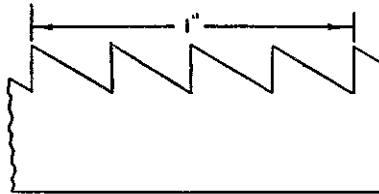

SELECT NUMBER OF POINTS PER INCH WANTED.

②

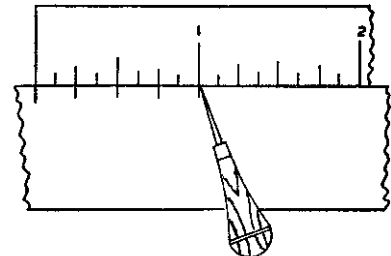

SPACE THE TEETH ACCURATELY.

③

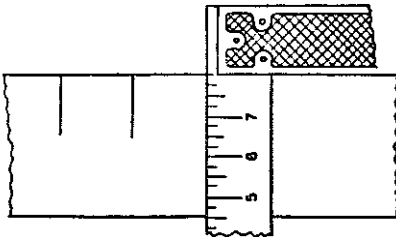

LAY OFF FRONT OF TEETH ON BOTH SIDES.

④

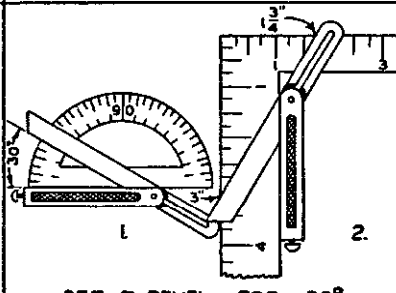

SET T-BEVEL FOR 30°
1. BY USE OF PROTRACTOR
2. BY USE OF FRAMING SQUARE.

⑤

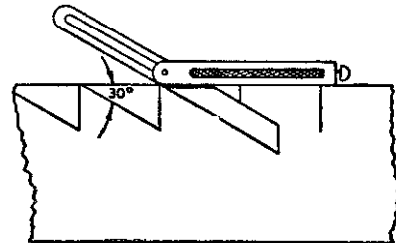

LAY OFF BACK OF TEETH ON BOTH SIDES.

⑥

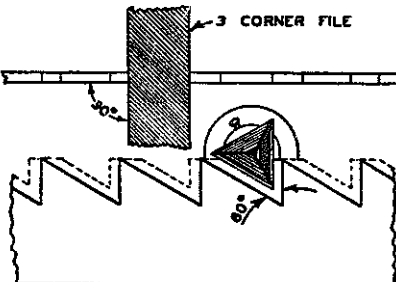

REMOVE $\frac{3}{4}$ OF METAL BETWEEN MARKS FILING FROM ONE SIDE.

⑦

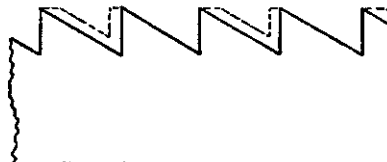

REMOVE ACCURATELY REMAINDER OF METAL FROM EVERY OTHER GULLET FILING FROM ONE SIDE.

⑧

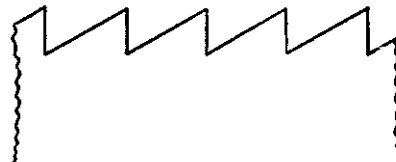

REVERSE BLADE IN VISE AND REMOVE REMAINING METAL. BRING TEETH TO SHARP POINT AT TOP LINE.

⑨

RETOUCH WITH LIGHT STROKES TO PRODUCE KEENNESS.

⑩

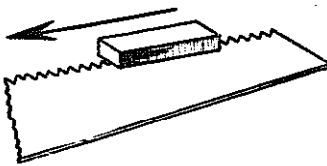

REMOVE WIRE EDGE BY MAKING LIGHT STROKES WITH AN OILSTONE OR MILLFILE TOWARD HANDLE OF SAW.

⑪

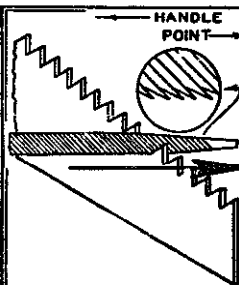

A FILE CUTS IN ONE DIRECTION ONLY—FORWARD.

⑫

SUGGESTIONS

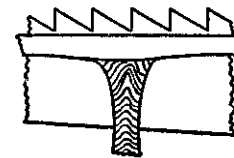

TO PREVENT SCREECHING, CLAMP BLADE IN VISE JAWS AS CLOSE TO BASE OF TEETH AS POSSIBLE.

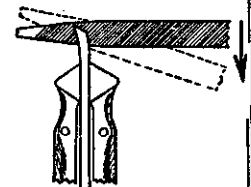

IF NECESSARY DROP FILE HANDLE SLIGHTLY.

Chart 4

CUTTING HAND CROSSCUT SAW TEETH

WHEN HANDSAW TEETH HAVE BEEN BROKEN OFF GRIND DOWN TO BASE OF TEETH AND CUT NEW TEETH.

SUGGESTION: — BEFORE WORKING ON A GOOD SAW PRACTICE ON AN OLD SAW BLADE OR PIECE OF 12 GAUGE SHEET METAL.

①

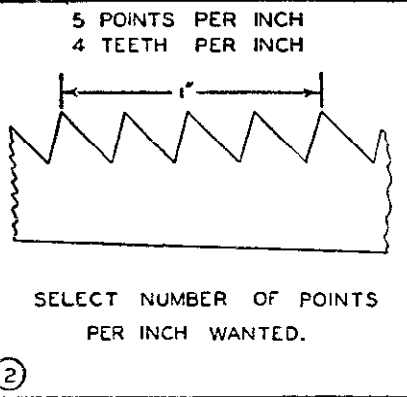

②

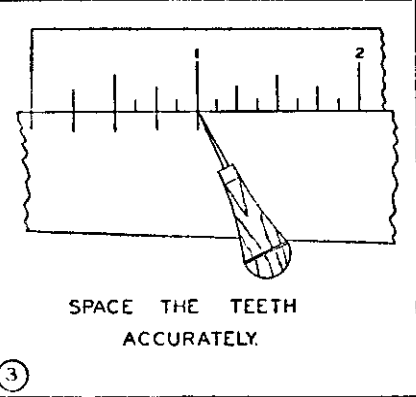

③

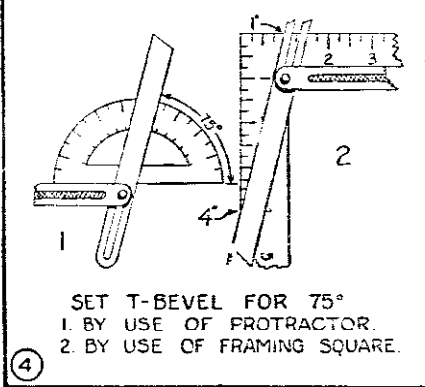

④

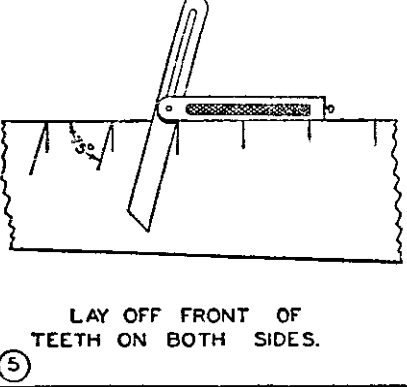

⑤

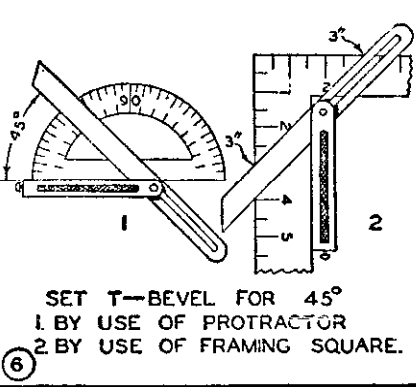

⑥

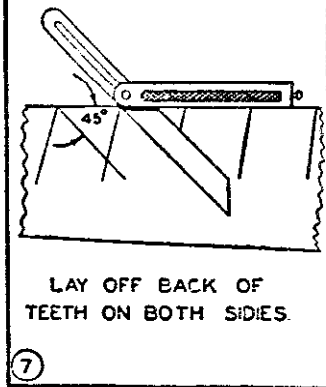

⑦

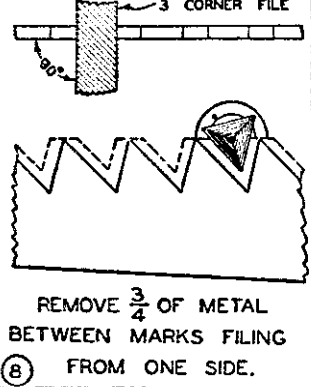

⑧

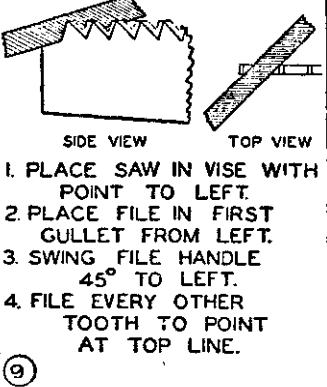

⑨

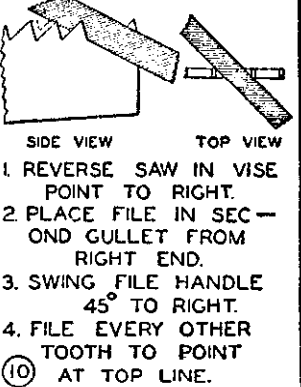

⑩

RETOUCH WITH LIGHT STROKES TO PRODUCE KEENNESS.

⑪

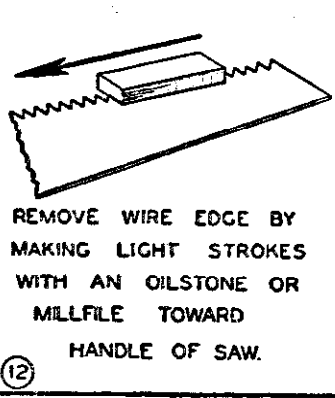

⑫

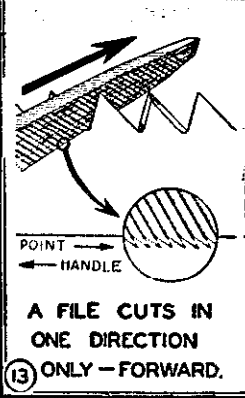

⑬

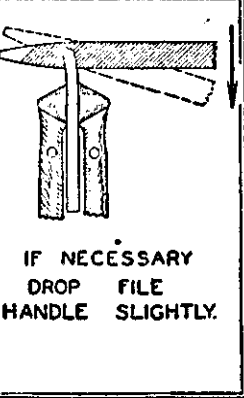
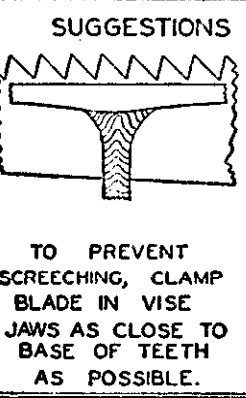

Chart 5

CUTTING HAND SAW TEETH

Chart 4, Page 19, and Chart 5, Page 20

Problem

To learn the proper shape of both rip and crosscut saw teeth.

To learn how to cut new teeth.

Words to Look Up in the Glossary

Gullet, filing, crosscut, rip.

When and Why to Cut Saw Teeth

1. A beginner can learn the shape of hand saw teeth and can get clearly in mind what he is to produce when filing a saw if he lays out and cuts a few teeth on a thin piece of metal.
2. Occasionally some saw teeth are broken. The remaining teeth need to be removed by grinding or filing. New teeth are then laid out and cut.

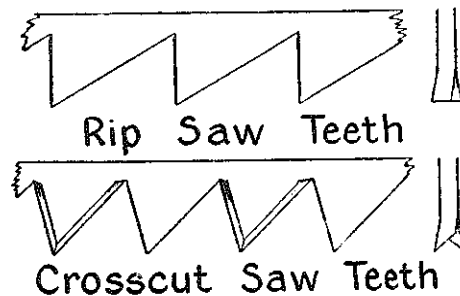

Materials Needed

1" x 4" piece of 12-gauge sheet metal, T-bevel, carpenter square, scratch awl, triangular file, saw clamp or vise, try square.

How to Lay Out the Teeth

Select the number of points per inch. For the beginner, it is suggested that this be 5 points (4 teeth) per inch or a spacing of $\frac{1}{4}$ inch per tooth (No. 2). These teeth will be larger than those on the average saw and easier to work with. The smaller the teeth the greater the skill required.

Locate the points of the teeth, using a rule and a scratch awl (No. 3). It is suggested that the metal be covered with chalk so that the scratches made by the awl may be easily seen. The uniformity of the teeth in the finished job depends upon the accuracy with which the teeth are laid out.

At each point lay off the front of the tooth on both sides of the blade. For rip saw teeth see No. 4, Chart 4, and for crosscut saw teeth see No. 4 and No. 5, Chart 5.

From each of these same points lay off the back of each tooth on both sides of the blade. For rip saw teeth see Nos. 5 and 6, Chart 4, and for crosscut saw teeth see Nos. 6 and 7, Chart 5.

How to Cut the Teeth

Select a triangular file with sides slightly greater in width than the length of the back of the tooth. If the file is too small, it will not cut the entire length of the tooth on each

stroke. If the file is too large, it is difficult to observe the work and the middle part of each side of the file will not be used.

Any two sides of a triangular file will form an angle of 60° (Fig. 9). Observe that the gullet formed by the back of one tooth and the front of another is 60° . The file will therefore cut the back of one tooth and the front of the other on each stroke.

Clamp the metal as near the base of the outlined teeth as possible. (No. 12, Chart 4). Remove approximately $\frac{3}{4}$ of the metal between the outlined marks of the teeth. File from one side only (No. 7, Chart 4, No. 8, Chart 5).

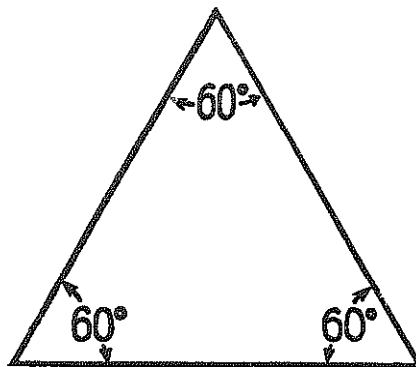

Figure 9.

The file is held horizontally. If this causes screeching lower the file handle slightly (No. 12). The file is held so that one cutting side is parallel to the back of one tooth and another cutting side is parallel to the front of the adjoining tooth. Remember that a file is simply a series of small chisels arranged to cut only on the forward stroke (No. 12). Therefore, do not press on the file on the back stroke as this will dull the file.

The remaining metal is filed from every other gullet. **File to the marks and stop.** If the point of the teeth are not sharp, retouch lightly with the file. Be cautious, as too much filing on any one tooth will shorten it below a straight top line.

Remove the wire edge on each side of the blade by making light strokes with an oil-stone or mill file. If the stroke is made against the cutting edge of the teeth, the rule, "Sharpen against the edge," is observed.

SHARPENING HAND SAW RIP

SHARPEN WHEN TEETH ARE DULL IRREGULAR IN SHAPE OR—

①

PROPERLY SET TEETH WORN SAW BINDS

WHEN "SET" IS WORN.

②

JOINTING

BEFORE AFTER

TOP JOINT WITH FLAT FILE UNTIL SHORTEST TEETH ARE LIGHTLY TOUCHED.

③

SHAPING NEEDED

SHAPING NOT NECESSARY

SHAPE IF NECESSARY.

④

FILE HERE AND HERE

NOT HERE

SHAPE BY FILING FROM ONE SIDE AT RIGHT ANGLE TO BLADE.

⑤

REPEAT TOP JOINTING AND SHAPING UNTIL ALL TEETH ARE UNIFORM.

⑥

SAW SET HAMMER

SAW SET ANVIL

BEND UPPER $\frac{1}{3}$ TO $\frac{1}{2}$ OF EACH TOOTH WITH SAW SET.

⑦

SET EVERY OTHER TOOTH TO THE RIGHT—
REMAINDER TO THE LEFT.

⑧

POINT TEETH BY LIGHTLY STROKING EVERY OTHER TOOTH REVERSE SAW AND POINT REMAINING TEETH.

⑨

REMOVE WIRE EDGE BY MAKING LIGHT STROKES WITH AN OILSTONE OR MILLFILE TOWARD HANDLE OF SAW.

⑩

Chart 6

SHARPENING HAND CROSSCUT SAW

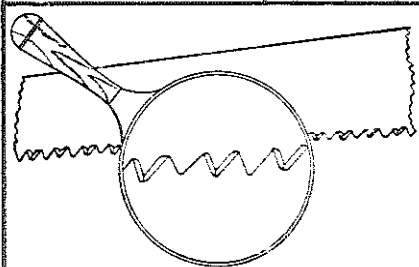

SHARPEN WHEN TEETH ARE DULL IRREGULAR IN SHAPE OR—

①

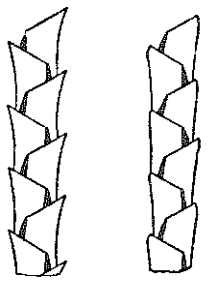

PROPERLY SET WORN SAW BINDS

—WHEN SET IS WORN.

②

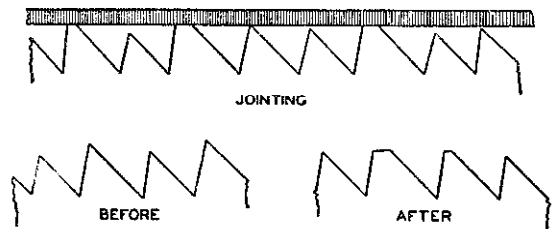

JOINTING

BEFORE

AFTER

TOP JOINT WITH FLAT FILE UNTIL SHORTEST TEETH ARE LIGHTLY TOUCHED BY—

③

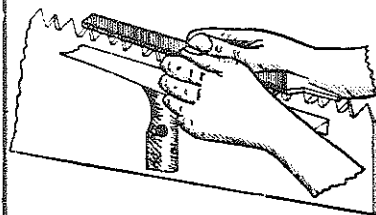

JOINTING

—HOLDING FILE THUS

④

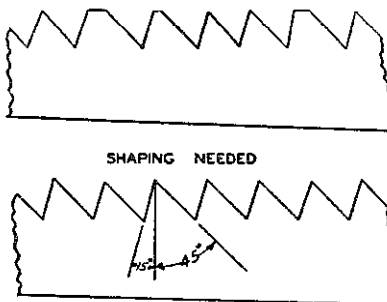

SHAPING NEEDED

SHAPING NOT NECESSARY

SHAPE IF NECESSARY.

⑤

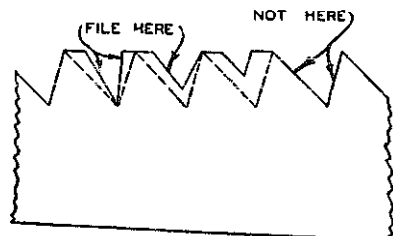

SHAPE BY FILING FROM ONE SIDE AT RIGHT ANGLE TO BLADE.

⑥

REPEAT TOP JOINTING AND SHAPING UNTIL ALL TEETH ARE UNIFORM.

⑦

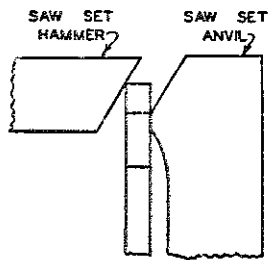

BEND UPPER $\frac{1}{3}$ TO $\frac{1}{2}$ OF EACH TOOTH WITH SAW SET.

⑧



SET EVERY OTHER TOOTH. REVERSE THE SAW AND SET REMAINDER.

⑨

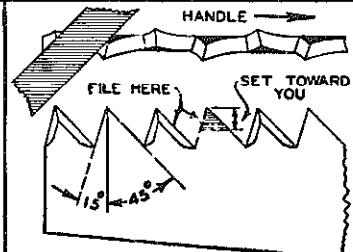

PLACE FILE 45° IN GULLET TO LEFT OF FIRST TOOTH SET TOWARD YOU. FILE EVERY OTHER GULLET

⑩

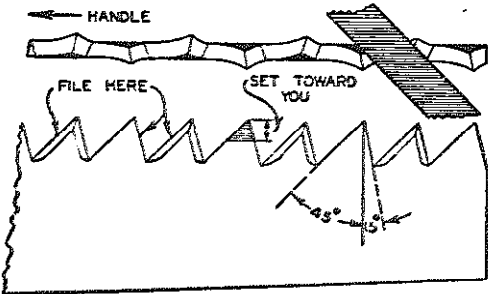

REVERSE SAW.

FILE REMAINING GULLETS AT 45°

⑪

NOTE:
FILE MUST POINT TOWARD HANDLE OF SAW.

⑫

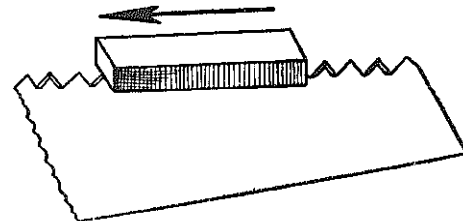

REMOVE WIRE EDGE BY MAKING LIGHT STROKES WITH AN OILSTONE OR MILLFILE TOWARD HANDLE OF SAW.

⑬

SHARPENING HAND SAWS

Chart 6, Page 23, and Chart 7, Page 24

Problem

To learn how to sharpen a hand saw.

Words to Look Up in the Glossary

Set, gullet, wire edge, kerf, jointing, crosscut, rip.

Note:

There are two processes in the sawing operation, first, cutting the small wood chips and, second, removing them.

A saw is simply a series of small chisels called "teeth" shaped to cut on the forward stroke (Fig. 10). It cuts smoothly when these teeth are even so that the points are perfectly in line.

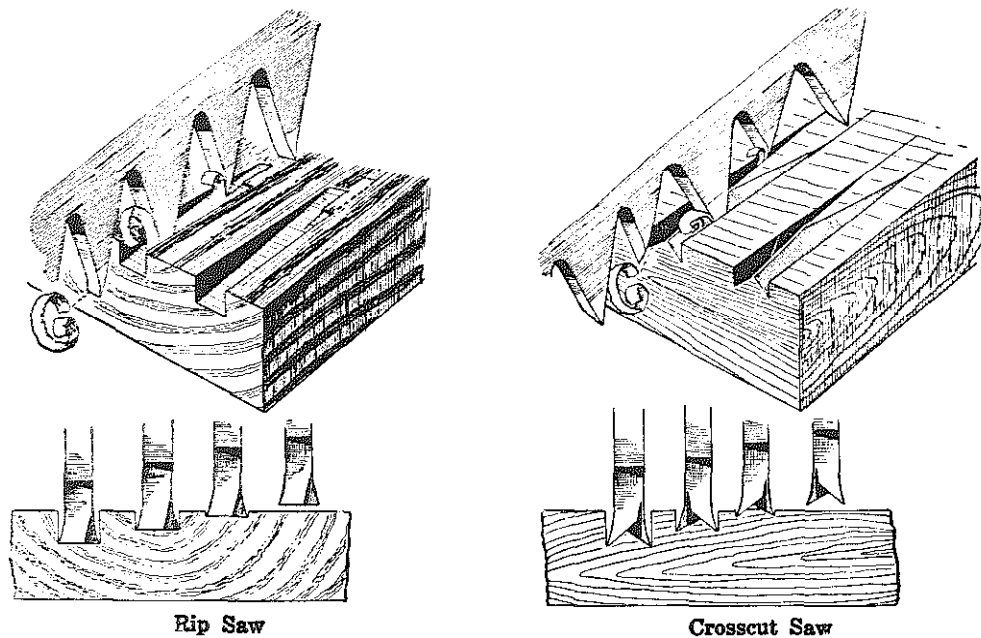

Figure 10.

When and Why to Sharpen

A saw should be sharpened when:

1. The teeth are dull (No. 1).
2. The teeth are irregular in shape (No. 3).
3. The set is worn (No. 2).

Like the cutting edge of the chisel the sharp edge of the saw teeth become rounded and dull and do not enter wood easily.

In a saw with teeth of irregular length and size, the longer teeth do all the work. When in use, a saw with irregular teeth cuts with a jumpy effect causing a rough ragged cut. This is because the longer teeth prevent the shorter teeth from touching the wood. This condition also prevents fast cutting because the gullet quickly fills with sawdust. The combined gullet capacity of the small teeth, when all are allowed to cut, is greater than the gullet capacity of a few long teeth (Fig. 11).

When the teeth become dull, part of the set is worn off, causing the saw to bind. One cannot steer or guide a saw that has no set.

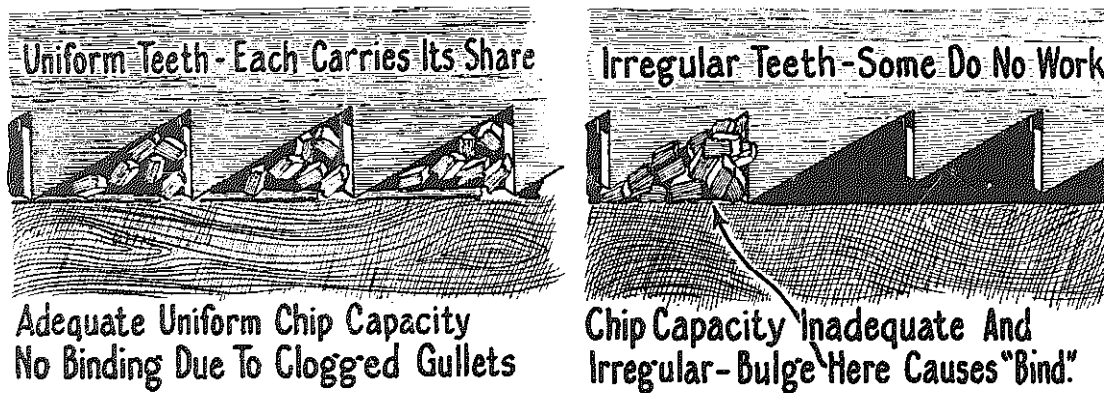

Figure 11.

Materials Needed

Saw, vise, flat file, saw set, triangular file.

How to Joint

If the teeth are not regular in size and shape (No. 3), the saw will require jointing. The file is held with the thumbs on top and the index fingers under the file and snug against the saw blade and pointing back. Hold the file level and make long strokes the entire length of the blade. **Don't Hurry.** Remember that a file cuts only in one direction. A jointing tool may be used to hold the file in top jointing. Top joint until the shortest teeth are lightly touched. Additional top jointing will mean more work in filing. If the teeth are very uneven, file only the longer teeth to the same height during the first jointing. Proceed with the operation of shaping and repeat the operation of top jointing until all the teeth are in line.

A properly sharpened saw must have all teeth the same height. The secret of accomplishing this in the finished job is to always top joint previous to filing even though the teeth are of the same height. In filing the saw, if each tooth is brought to a sharp point at the top line, then all teeth will be in a perfect line. Actually the teeth should not be in a straight line but slightly curved (Fig. 12).

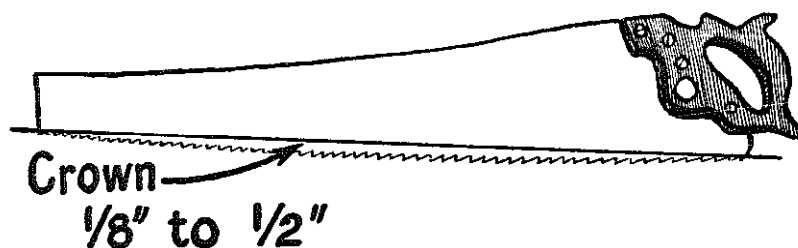

Figure 12.

How to Shape the Teeth

The correct shape of the rip saw tooth is shown in Fig. 4, Chart 6, and the correct shape of crosscut saw tooth is Fig. 5, Chart 7. The front or cutting edge of teeth in a rip saw is at right angles to the line of the points of the teeth. In the crosscut saw the angle is fifteen degrees more than a right angle. This angle, often spoken of as the "hook" or "pitch" of the saw, partly determines the speed at which the saw cuts. The rip saw has more hook than the crosscut saw.

If the teeth are fairly uniform in shape this operation may be omitted. (See Fig. 4.) The teeth are brought to the correct shape by filing from one side and at right angles to the blade (Fig. 5, Chart 6, and Fig. 6, Chart 7). Do not bevel the crosscut teeth at this time. Adjust the pressure on the file so that the cutting will take place on the larger tooth. Bring the teeth to a point at the top line. Additional filing means uneven teeth. If all teeth are still not uniform in size and shape, repeat top jointing and shaping (Fig. 6, Chart 6, and Fig. 7, Chart 7).

How to Set the Teeth

Every other tooth is set to the right and the remainder to the left to produce a "kerf." All teeth must be at the same height or the set will never be uniform. Green wood will require more set than dry wood. The amount of set is generally regulated by the depth (Fig. 13) at which the tooth is bent. For average work the upper one-third to one-half of the tooth is bent (Fig. 13). For crosscut saw teeth the depth of set may be more than one-half, due to the bevel of the tooth causing the hammer of the saw set to slip off the tooth.

How to Point the Teeth

Suggestion: In order to keep the teeth at the same height, it is helpful to lightly top joint previous to pointing. This is especially helpful with crosscut saws where shaping is required.

Rip Saw

Lightly stroke every other tooth from one side (No. 9). Make the stroke so that the wire edge will be left on the inside of the tooth. The file should cut against the front of the tooth that is set toward you. Reverse the saw in the vise and point the remaining teeth. Repeat this procedure if necessary.

Crosscut Saw

Place the saw in the vise with the point to your left and the handle to your right

(No. 10). Place the file in the first gullet to the left of the first tooth set toward you. This will be the correct filing position. Notice that the file will be cutting against the front of the tooth set toward you, and the back of the tooth set from you. The wire edge will be left on the inside of the cutting edge of the tooth. We are applying the rule, "Sharpen against the edge." Reverse the saw in the vise and file the remaining teeth with the file, swinging the file 45° to the right. It will be observed that the file is always pointing toward the handle of the saw (No. 12).

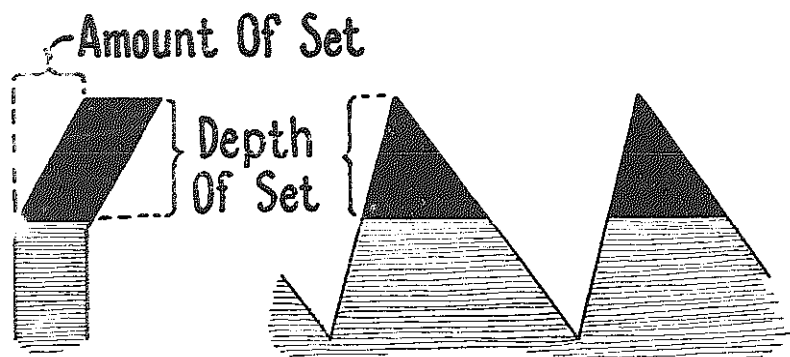

Figure 13.

How to Side Joint

Remove the wire edge and true-up the set by making light strokes with an oilstone or mill file (No. 10, Chart 6; No. 13, Chart 7). If the stroke is made against the cutting edge of the teeth, the rule, "Sharpen against the edge," is observed.

Final Test

Lay off a straight line on a board and try the saw. If the saw does not easily follow the line, then side joint lightly on the side toward which it tends to go.

NOTES

SHARPENING CROSSCUT TIMBER SAW

RAKER TOOTH
CUTTING TEETH

① MOST TIMBER SAWS HAVE TWO TYPES OF TEETH.

DULL
IRREGULAR

② SHARPEN WHEN CUTTING TEETH ARE DULL, IRREGULAR IN SHAPE.

CUTTING TEETH PROPERLY SET
SET WORN CAUSING BIND
RAKER TEETH ARE NOT SET

③ WHEN SET IS WORN

④ WHEN RAKER TEETH ARE SAME HEIGHT OR LONGER THAN CUTTING TEETH

GRIND HERE
NOT HERE

GUM THE SAW BY GRINDING IN EACH GULLET. CHANGE GULLETS FREQUENTLY TO PREVENT OVER HEATING.

⑤

⑥ FLARE BY STRIKING EACH TOOTH.

TOP JOINTED

⑦ USE CROSSCUT SAW FITTING TOOL. TOP JOINT WITH FLAT FILE UNTIL SHORTEST CUTTING TEETH ARE LIGHTLY TOUCHED.

LONG POINTED TEETH FOR SOFT WOOD
SHORT POINTED TEETH FOR HARD WOOD

⑧ FILE CUTTING TEETH TO A POINT

FIRST POSITION FILE HERE
REVERSED FILE HERE

⑨ FILE EVERY OTHER TOOTH TO A POINT AT TOP LINE. REVERSE SAW AND FILE REMAINING TEETH.

FILE TO HERE

⑩ REPEAT IF NECESSARY UNTIL FLAT TOP OF TOOTH IS JUST BROUGHT TO A POINT OVER CENTER OF TOOTH.

⑪ USE CROSSCUT SAW FITTING TOOL FILE DOWN THE RAKER TEETH. FOR HARD WOOD FILE 1/64" TO 1/90" SHORTER THAN CUTTING TEETH. FOR SOFT WOOD FILE 1/32" TO 1/40" SHORTER.

FILE HERE

FILE VERY LIGHTLY FOR KEENNESS

⑫ FILE RAKER TEETH UNTIL FLAT TOP IS JUST BROUGHT TO A POINT.

3/16" 1/32"

ANVIL

⑬ SET CUTTING TEETH BY BENDING THE UPPER 3/16" TO 1/4" OF EACH TOOTH.

GAUGE

TEETH
SAW BLADE

⑭ SUGGESTIONS: IT IS HELPFUL TO CHECK SET WITH A GAUGE.

⑮ LIGHTLY RETOUCH THE TEETH TO PRODUCE KEENNESS. RECHECK THE RAKER TEETH FOR HEIGHT.

SHARPENING CROSSCUT TIMBER SAWS

Chart 8, Page 30

Problem

To learn how to sharpen a crosscut timber saw.

Words to Look Up in the Glossary

Set, gullet, wire edge, kerf, jointing, gumming, crosscut, flare.

Note:

There are three types of crosscut timber saws, Lance tooth, Champion tooth and Peg tooth (Fig. 14).

The lance tooth and champion tooth types are most widely used. Each has two kinds of teeth, cutting teeth and raker teeth. The cutting teeth scratch two parallel marks. The raker teeth remove the wood between these marks.

The peg tooth type has cutting teeth only. It cuts much slower than the other types and is not generally used. One who learns to sharpen the first two types will have no difficulty in sharpening the peg tooth type.

When and Why to Sharpen

A timber saw should be sharpened when:

1. The teeth are dull or irregular in shape (No. 2).
2. The set is worn (No. 3).
3. The raker teeth are even or higher than the cutting teeth (No. 4).

Like the cutting edge of the chisel the sharp edges of the cutting teeth and of the raker teeth become rounded and dull through use and do not enter wood easily.

In a saw with teeth of irregular length and size, the longer teeth do all the work. When in use a saw with irregular teeth cuts with a jumpy effect, causing a rough ragged cut. This is because the longer teeth prevent the shorter teeth from touching the wood.

If the set is worn the saw will bind. One cannot steer or guide a saw that has no set.

The raker teeth should be slightly shorter than the cutting teeth (No. 4). If of equal length they prevent the shorter teeth from cutting into the wood. If longer they not only

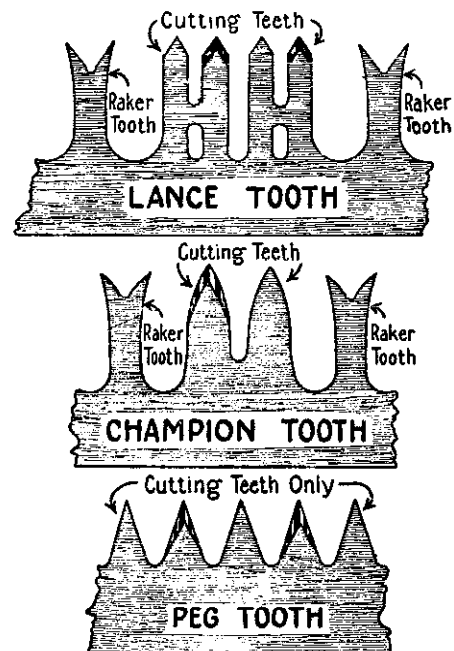

Figure 14.

hold the cutting teeth away from the wood but they "dig in," producing a rough ragged cut and causing the saw to jump.

Material Needed

Timber saw vise, 10" flat file, gumming wheel, hammer and anvil, crosscut saw fitting tool. A setting gauge is desirable.

How to Gum the Saw

The gullets between the raker teeth and the cutting teeth should be deep enough to carry all the saw dust cut out by the raker teeth during one stroke of the saw. Frequent sharpening will shorten the teeth, thus reducing the gullet space. The smaller gullets become filled with sawdust which packs against the sides of the kerf. The saw binds and pulls hard.

Gum the saw by grinding the gullets until the teeth are the original length (No. 5). Hold the saw at the level of the center of the stone. Use care in pressing the saw against the side of the gumming wheel as the wheel is thin and will break easily. Change gullets frequently to prevent overheating.

How to Flare the Raker Teeth

The raker tooth is actually two small chisels arranged to cut in opposite directions. These teeth cut out and remove the wood between scratches made by the cutting teeth. Like any good cutting tool, the raker teeth should operate with a clearance angle of less than 90 degrees (Fig. 15). After many filings it is sometimes necessary to flare the two points in order to produce the desired clearance angle. Clamp the saw in a metal vise with about $\frac{3}{4}$ inch of the tooth projecting above the jaw of the vise. Strike each point a light blow with a smooth faced hammer. Deliver the blow at an angle so as to produce as much flare as possible without battering the point (No. 6).

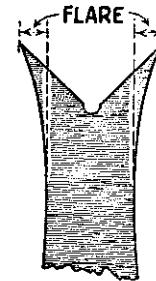

Figure 15.

How to Joint the Teeth

If the cutting teeth are not regular in size and shape (No. 2) the saw will require jointing (No. 7). It is best that a crosscut saw fitting tool be used to hold the flat file for top jointing (No. 7). Make the strokes the entire length of the saw. Remember the file cuts in one direction only. Top joint until the shortest cutting teeth are lightly touched.

A properly sharpened saw must have all cutting teeth of the same height. The secret of accomplishing this in the finished job is to always top joint previous to filing even though the teeth are of the same height. In filing the saw, if each tooth is brought to a sharp point at the top line, then all teeth will be in a line. The teeth should not actually be in a straight line but in a convex curve called the crown.

How to File the Cutting Teeth

File both bevels of every other tooth from one side of the saw. Reverse the saw and file the remaining teeth (No. 9). File against the inside edge of the tooth that is set from you. This is contrary to our rule, "Sharpen against the edge," but is necessary to prevent vibration. It will leave a wire edge on the outside (cutting edge) of the tooth.

File a long pointed tooth if the saw is to be used in soft wood. File a short pointed tooth if the saw is to be used in hard wood (No. 8). For general purpose work, file a medium point. Bring the teeth to a point at the top line and stop filing when this point is reached. Additional filing may not change the bevel, but will shorten the tooth. The tooth cuts in both directions, therefore the point should be in the center of the tooth.

How to Joint the Raker Teeth

File down the points of the raker teeth (No. 11). The file is held at right angles to the saw blade. The crosscut saw fitting tool is used as a guide to insure uniform height of the raker teeth. For hardwood set the fitting tool so the raker teeth will be 1/64 to 1/40 of an inch below the points of the cutting teeth. For soft wood, the raker points should be 1/40 to 1/32 of an inch below the points of the cutting teeth.

How to File the Raker Teeth

File the two points of each raker tooth to a sharp edge (No. 12). File only on the top inside of the tooth to maintain the flare. File until the flat top is just brought to a point. This will insure a uniform height to the teeth and the proper distance below the cutting teeth. Stroke outside of tooth very lightly to produce a keen edge.

How to Set the Cutting Teeth

The cutting teeth are set. The raker teeth are not set. Every other tooth is set (bent) to the right and the remainder to the left to produce a kerf. The set is determined by the depth at which the tooth is bent and the amount of the bend. Usually the tooth is bent about 3/16 of an inch down from the point and about 1/32 of an inch out. The distance between points properly set is about twice the thickness of the saw blade. For soft green wood increase the set. A setting tool or beveled piece of heavy metal may be used. A bevel may be filed on an anvil for this purpose. The tooth is extended over this bevel and hit with a hammer (No. 13). To insure a more uniform set it is best to check with a setting gauge (No. 14).

How to Retouch the Teeth

After setting, file the cutting teeth and the raker teeth very lightly to produce keenness. It is best to re-check the points of the raker teeth for a uniform distance below the point of the cutting teeth.

SHARPENING AUGER BIT

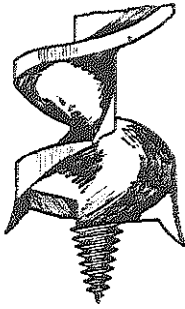

SHARPEN WHEN SPURS ARE BENT—

①

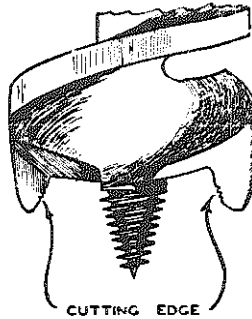

WHEN SPURS ARE DULL OR NICKED—

②



OR WHEN CUTTING LIPS ARE DULL OR NICKED.

③

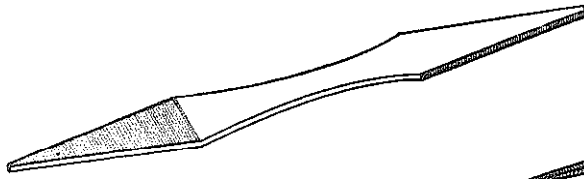

AUGER BIT FILE SHOULD BE USED ON ALL SIZE BITS—

④

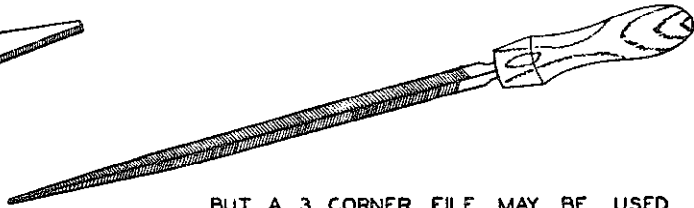

BUT A 3 CORNER FILE MAY BE USED ON LARGER BITS.

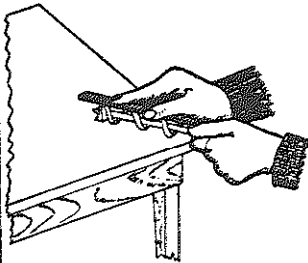

IF SPURS ARE BENT OUTWARD FILE LIGHTLY WITH FLAT FILE UNTIL DIAMETER AND SPURS ARE EQUAL. KEEP FILE FLAT

⑤

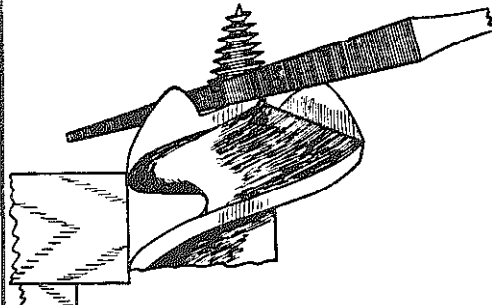

FILE CUTTING EDGE OF SPURS ON INSIDE. FILE TOWARD CUTTING EDGE.

⑥

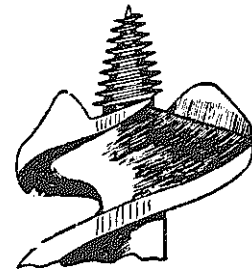

NOTE— CUTTING EDGE OF LIP SHAPED LIKE A CHISEL— ONE SIDE FLAT ONE SIDE BEVELED.

⑦

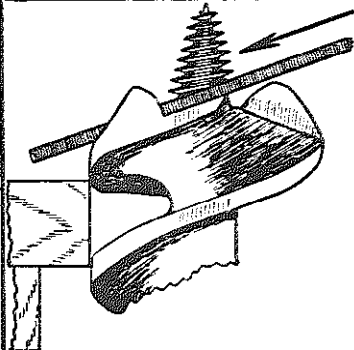

FILE FLAT SIDE OF LIPS.

⑧

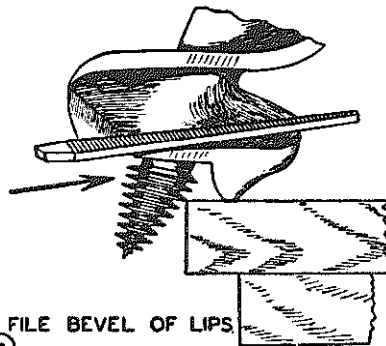

FILE BEVEL OF LIPS

⑨

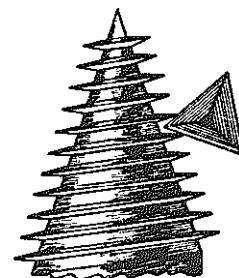

RUN 3 CORNERED FILE AROUND THREADS OF FEED SCREW IF DAMAGED.

⑩

SHARPENING AUGER BIT

Chart 9, Page 34

Problem

To learn how to sharpen an auger bit.

Words to Look Up in the Glossary

Spurs.

Note:

An auger bit is simply two chisels, called cutting lips, arranged to cut in a circle. The feed screw guides and draws the chisels into the wood. The spurs, one on the outer end of each chisel, cut a circle inside of which the chisels remove the wood. The twist delivers the shavings out of the hole.

When and Why to Sharpen

Sharpen an auger bit when:

1. The spurs are bent, dull, or nicked (Nos. 1 and 2).
2. The cutting lips are dull or nicked (No. 3).

If the spurs are bent outward, the diameter of the hole will be too large and will include more wood than the cutting lips can reach. If the spurs are bent inward, they will cut too small a diameter which will cause the twist to bind. If the spurs are nicked or dull, they will not cut a smooth circle and will cause the bit to turn hard.

If the cutting lips are nicked or dull, they will not cut smoothly and will not enter wood easily, causing the bit to turn hard. If the spurs or cutting lips are dull, they may cause the feed screw to tear out of the threaded grooves unless excessive pressure is applied to the bit.

The threads of the feed screw must be regular, smooth, and sharp in order to enter wood easily and firmly and thus pull and regulate the cutting of the spurs and cutting lips.

Material Needed

Auger bit file, mill or flat file, and possibly a three-cornered file.

How to Sharpen

Spurs: If the spurs are bent outward, file them down to the same diameter as the twist. Hold the bit as shown in No. 5. File the spurs with a flat file lying flat on the auger bit. Use light strokes to bring the spur down to its correct diameter.

If the spurs are bent inward or are nicked or dull, file the front or cutting edge on the inside, as if they were round edged chisels. File toward the cutting edge. Hold the bit against the edge of the table with the feed screw up (No. 6).

Cutting Lips: File the flat side of the cutting lips. Make this side flat, not beveled (No. 8). Now turn the bit and file the other side of the cutting lips to a bevel and a keen edge (No. 9). Push the file against the cutting edge. Notice the arrow in No. 9. Filing in the opposite direction produces too much wire edge which will quickly break off, leaving the edge blunt.

Feed Screw: If the threads of the feed screw are damaged, nicked, bent, or dull, run a three-cornered file around the threads (No. 10). Roll the auger bit as you file the feed screw.

Final Test

Try the bit in a piece of wood. If all three parts are properly sharpened, the bit enters without pressure and cuts a clean smooth hole.

SHARPENING KNIVES

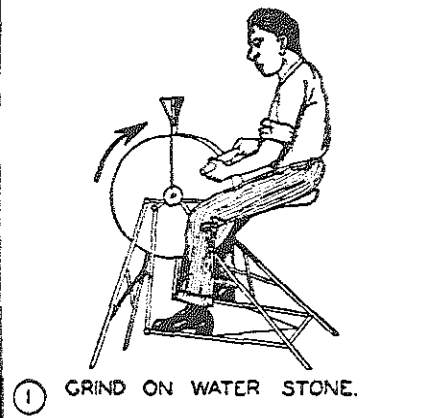

① GRIND ON WATER STONE.

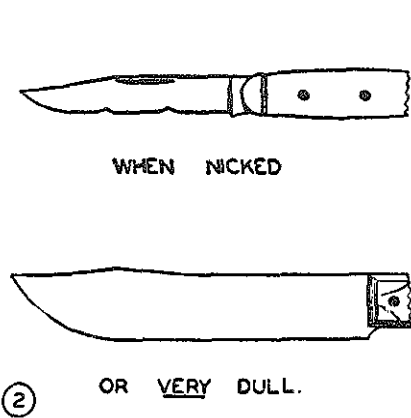

② WHEN NICKED
OR VERY DULL.



③ WHET ON OILSTONE WHEN
SLIGHTLY DULL AND
AFTER GRINDING.

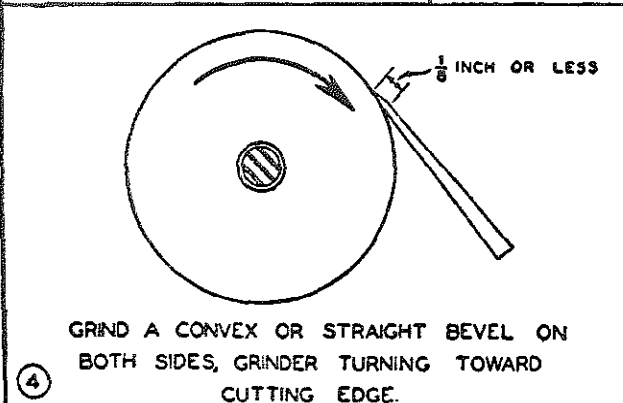

④ GRIND A CONVEX OR STRAIGHT BEVEL ON
BOTH SIDES, GRINDER TURNING TOWARD
CUTTING EDGE.

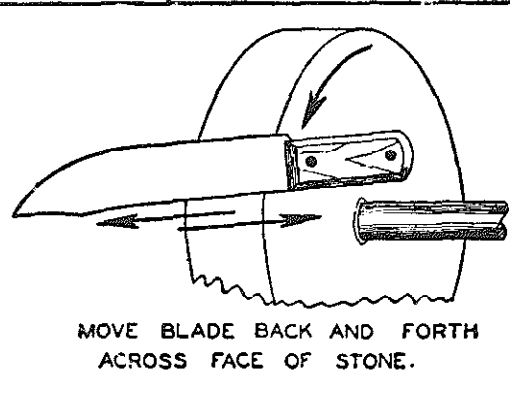

MOVE BLADE BACK AND FORTH
ACROSS FACE OF STONE.

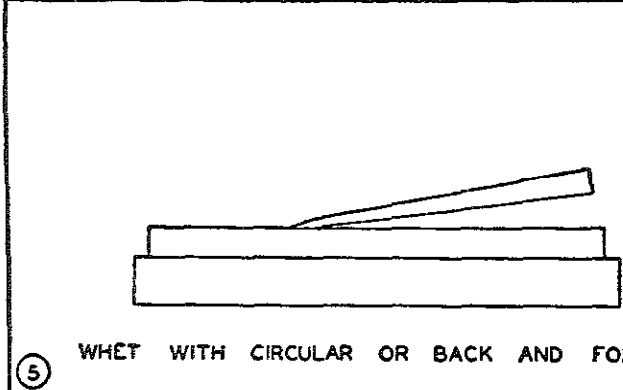

⑤ WHET WITH CIRCULAR OR BACK AND FORTH MOTION. USE ENTIRE SURFACE OF STONE.

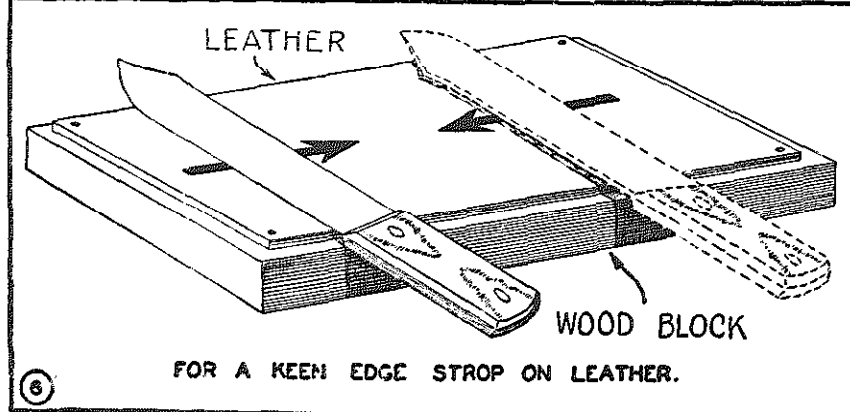
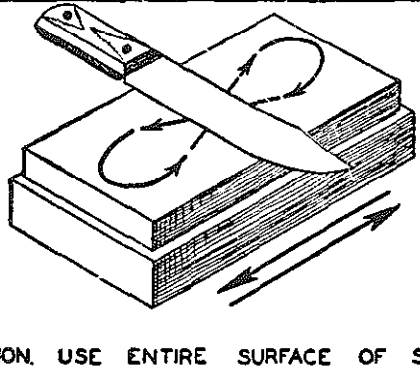

⑥ FOR A KEEN EDGE STROP ON LEATHER.

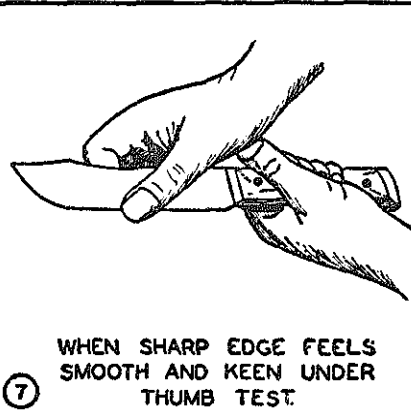

⑦ WHEN SHARP EDGE FEELS
SMOOTH AND KEEN UNDER
THUMB TEST.

SHARPENING KNIVES

Chart 10, Page 36

Problem

To learn how to grind and whet knives.

Words to Look Up in the Glossary

Convex, nick, strop.

When and Why to Grind and Whet

Knives are used more generally perhaps than any of the edge tools. They are sharpened by grinding and whetting or by whetting, depending on the condition of the blade. Unlike the chisel or plane iron, ordinary knives are ground and whetted the same on both sides of the blade.

1. The blade should be ground when nicked or when very dull (No. 2).
2. Whetting is sufficient if the blade is only slightly dull and not nicked.

Constant use and whetting reduce the bevel, thus making the edge blunt and dull. Grinding is then necessary to restore the bevel. Whetting, of course, is always necessary to produce a keen edge after grinding.

Materials Needed

Slow-speed water stone, oilstone, leather strop, oil, cotton waste or rags.

How to Grind

The length of the bevel is determined by the width and thickness of the blade. Generally, the thicker and wider the blade the longer the bevel to grind. One-eighth of an inch or less is a general guide. An edge too thin will "turn" when cutting hard materials. **Caution: Avoid excessive grinding.**

In grinding, place the blade against the slow-speed water stone to obtain the desired bevel (Nos. 1 and 4). Turn the stone toward the cutting edge, and move the blade back and forth across the face of the stone (No. 4). Grind until all nicks are removed and a very slight wire edge is formed along the entire length of the blade.

How to Whet

Place the knife blade on a clean oilstone with the ground bevel of the blade flat on the surface of the stone. Whet both sides with a circular or a back and forth motion, using the entire surface of the stone (No. 5). Continue whetting until the wire edge is removed or until the edge is keen (No. 7).

How to Strop

For a very keen edge strop on leather after whetting. Pull or push the knife across the leather away from the cutting edge of the blade. Keep the bevel flat on the surface of the leather.

Final Test

Draw the thumb or finger lightly across the edge (No. 7). If the edge is sharp, it will feel smooth and will tend to stick to the thumb. If the edge is not smooth, some of the wire edge or small gaps are still present.

SHARPENING AXE AND HATCHET

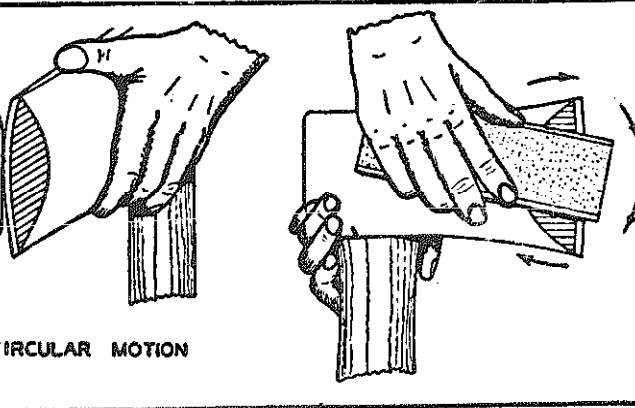
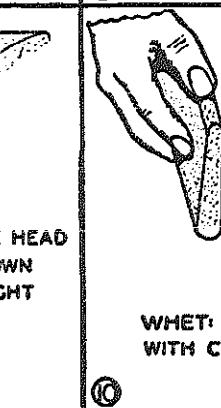
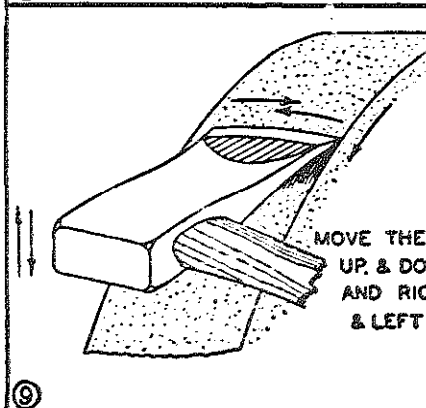
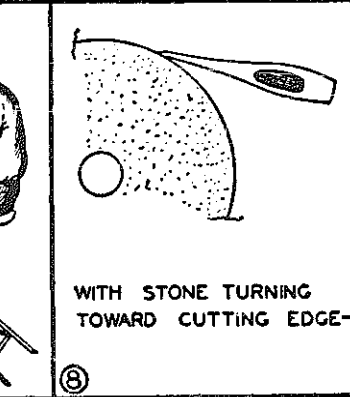
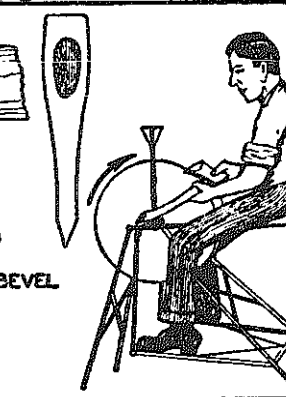
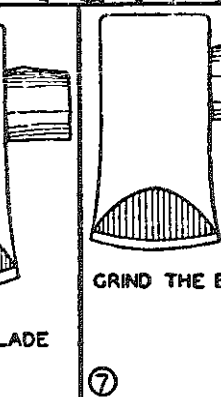
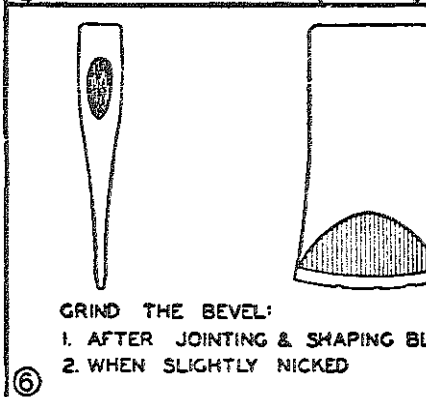
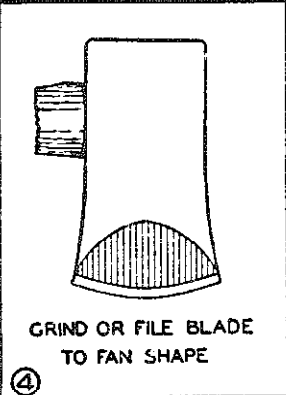
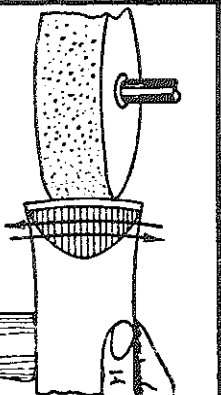
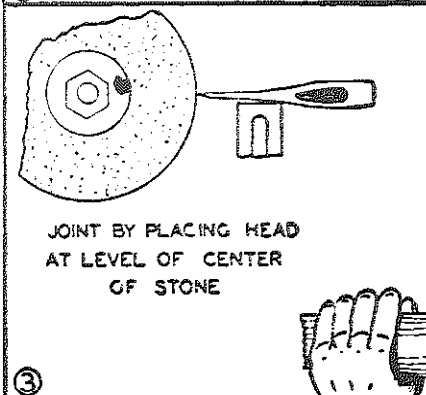
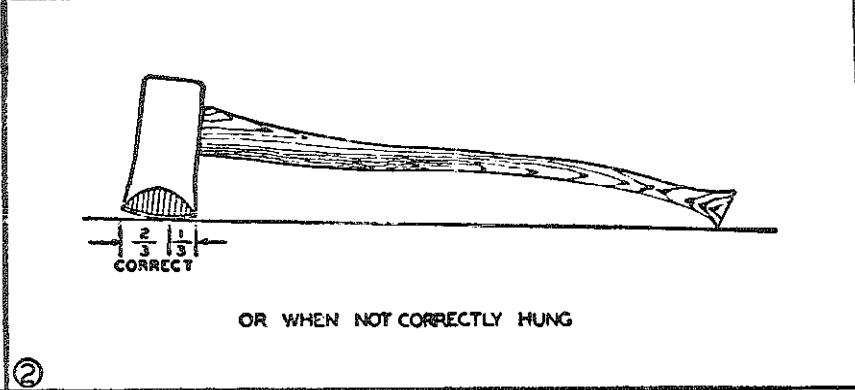
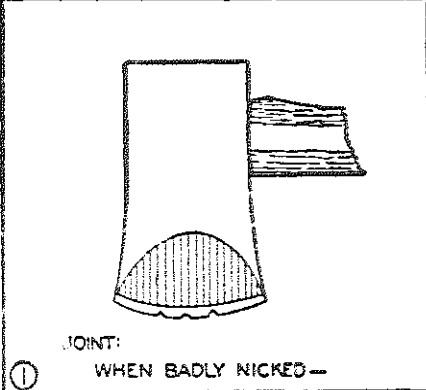

Chart 11

Local construction of equipment for small farms in rural areas is now being encouraged in many developing countries. To ensure the proper fabrication and maintenance of locally-built equipment it is imperative that blacksmithing facilities are established in these areas.

This publication, *How to make a metal-bending machine* describes a machine which has been specifically designed so that it can be constructed locally at a low cost. It is fabricated from mild steel flat, angle, bar and pipe materials, all of which are usually available in developing countries.

Using simple plans and photographs the booklet describes the construction and assembly of the machine. As its main feature is the ability to form wheel rims from cold flat mild steel, there is a special section on Building a Wheel, complete with plans: this wheel can be used on farm carts and other basic agricultural equipment. The metal-bending machine can also bend notched angle iron and flat mild steel to any required angle. Additionally, the booklet contains a plan of an ox-cart, showing the wheel and axle design in place.

With its clear plans and useful step-by-step photographs, this publication should prove most useful to all involved in rural blacksmithing.

ISBN 0 903031 29 9