

# DICTIONARY OF WATER & WASTE MANAGEMENT

PAUL G. SMITH  
JOHN S. SCOTT

# **Dictionary of Water and Waste Management**

To Suzanne and Stephanie

# Dictionary of Water and Waste Management

**Paul G. Smith**

*Professor of Civil and Environmental  
Engineering, University of Paisley, Scotland*

*and*

**John S. Scott**

*Formerly Consultant and Technical Author*

**IWA**  
Publishing

**B**UTTERWORTH  
**H**EINEMANN

OXFORD AUCKLAND BOSTON JOHANNESBURG MELBOURNE NEW DELHI

Butterworth-Heinemann  
Linacre House, Jordan Hill, Oxford OX2 8DP  
225 Wildwood Avenue, Woburn, MA 01801-2041  
A division of Reed Educational and Professional Publishing Ltd

 A member of the Reed Elsevier plc group

First published 2002

Original text © Paul G. Smith and John S. Scott 1981  
New/revised text © Paul G. Smith 2002

All rights reserved. No part of this publication may be reproduced in any material form (including photocopying or storing in any medium by electronic means and whether or not transiently or incidentally to some other use of this publication) without the written permission of the copyright holder except in accordance with the provisions of the Copyright, Designs and Patents Act 1988 or under the terms of a licence issued by the Copyright Licensing Agency Ltd, 90 Tottenham Court Road, London, England W1T 4LP. Applications for the copyright holder's written permission to reproduce any part of this publication should be addressed to the publishers

**British Library Cataloguing in Publication Data**

A catalogue record for this book is available from the British Library

**Library of Congress Cataloguing in Publication Data**

A catalogue record for this book is available from the Library of Congress

ISBN 0 7506 4638 1

ISBN (IWA Publishing) 1 84339 015 9

Co-published by IWA Publishing,  
Alliance House, 12 Caxton Street,  
London SW1H 0QS, UK  
Tel. +44 (0) 20 7654 5500  
Fax +44 (0) 20 7654 5555  
Email [publications@iwap.co.uk](mailto:publications@iwap.co.uk)  
Web [www.iwapublishing.com](http://www.iwapublishing.com)

Typeset in India by Integra Software Services Pvt. Ltd., Pondicherry 605 005, India  
[www.integra-india.com](http://www.integra-india.com)

PLANT A  
TREE



FOR EVERY TITLE THAT WE PUBLISH, BUTTERWORTH-HEINEMANN  
WILL PAY FOR BTCV TO PLANT AND CARE FOR A TREE.

# Preface

Water and waste management covers the design, building and operation of plants for water treatment and supply, sewerage, wastewater treatment and disposal, and solid waste treatment and disposal. It aims to understand and control pollution of air, water and land, and to improve amenity. This book, with many cross-references, explains its terminology and should help laymen, as well as scientists and engineers qualified in other subjects, to understand its literature. It touches on a variety of many branches of engineering—chemical, civil, electrical, environmental, mechanical, structural and water as well as the various branches of environmental science including aspects of chemistry, biology, hydrology, microbiology, and virology, to name only a few. The book also covers relevant public health terminology.

The predecessor to this book was entitled *Dictionary of Waste and Water Treatment* and it was published in 1981. The inception for that book was John Scott who is now deceased. This text is a further development of his idea. Much has changed in this subject area over the last twenty years and the terminology of the USA has become more prevalent. New terms are now in common use and new topic areas have become established. Consequently this dictionary is 50% larger than the 1981 book and the scope of the book has been widened to cover terminology related to reclamation and re-cycling of waste, pipeline rehabilitation, contaminated soil remediation, environmental impact assessment and environmental management systems.

In this dictionary, the convention for biological Latin is followed where the genus and species is written in italics. All other terms concerned with biological classification are printed in roman type. All cross-references are printed in bold italic type. UK English is used but reference is made to USA spellings.

The information given in this dictionary is illustrative and must not be used for design or operational purposes.

I would like to thank Professor Mike Jackson, University of Strathclyde for his permission to use some of his material in this book and Dr Colin Clark, Highland Council, for his constructive comments on the final draft.

Paul G. Smith  
Aberfoyle, Scotland  
December 2001

This Page Intentionally Left Blank



**AAO process, A2O process** An adaptation of the *A/O process*. It is an *activated sludge* process that can achieve *nitrification*, *denitrification* and *biological phosphorus removal* as well as BOD removal. The three stage process involves an anaerobic zone of about one hour retention followed by an *anoxic* zone of similar size and finally an aerobic (oxidation) zone of 4 to 6 hours retention (*see Figure A.1*). In the process the third zone is used for BOD removal and nitrification. The recycle from the end of the third (aerobic) zone back to the inlet of the second (anoxic) zone results in the nitrate being mixed with the wastewater in the anoxic zone and the nitrate is denitrified to nitrogen gas. The return activated sludge from the sedimentation tank is fed back to the start of the anaerobic zone. The first zone is required in order to obtain biological phosphorus removal. The percent removal can be in excess of 95% for nitrogen and 90% for phosphates.

**AAS** *Atomic absorption spectrometer*.

**abattoir wastewater** *See meat processing wastewater*.

**abiotic** Description of the non-living part of an *ecosystem*.

**A-B process** A wastewater treatment process used in Europe that uses two *activated sludge* plants in series, i.e. aeration tank, sedimentation tank, aeration tank, sedimentation tank. Each sedimentation tank returns the sludge to the accompanying aeration tank. The first aeration tank is highly loaded at an *F : M ratio* of 3 to 5  $\text{d}^{-1}$  and removes about 60% of the BOD. The second aeration tank is loaded at an *F : M ratio* of about 0.15  $\text{d}^{-1}$ .

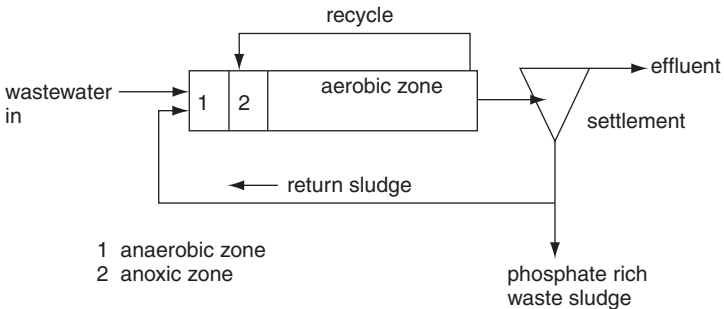

**Figure A.1** AAO process, flow diagram.



**ABS** (1) *Alkyl benzene sulphonate*. (2) *Acrylonitrile-butadiene-styrene*.

**absolute filter** A *high efficiency air filter*.

**absolute filter rating** The size of particles that are 99.9% removed by the filter.

**absolute viscosity** A term for dynamic *viscosity*.

**absorption** The entry of a fluid into a solid, gas into a liquid, etc. Various air pollution control devices are based on the principle of absorption, for example *spray chambers* or *packed towers*. Absorption also has the meaning of the entry of radiant energy into a material.

**absorption pit, seepage pit, absorption well, disposal pit, dumb well** A hole in the ground for disposal of rainwater, *sullage* or treated wastewater effluent. It is dug in porous soil, a *water table* not less than 2m below ground and no other danger of contaminating water supplies. *See soakaway, subsurface irrigation*.

**absorption tower** A *tower reactor* used as a *packed bed scrubber* (1) or a *plate tower scrubber*.

**absorption trench** *See soakaway*.

**abstraction** (verb **abstract**) Removal of water from a river, lake, well, borehole or other source to a waterworks or *impounding reservoir*.

**Acanthamoeba** A protozoa that can be found in water and wastewater. Some species can be pathogenic. *A. castellani* and *A. culbertsoni* and some other species can cause acanthamoebiasis, which is a form of *amoebic meningoencephalitis*. It enters the human body via abrasions or as a secondary infection.

**acaricide** A chemical that kills mites (achari).

**accelerated clarifier** A *solids contact clarifier*.

**accelerated composting** *In-vessel composting*.

**accelerated gravity separation** The use of centrifugal forces in order to increase the rate of separation of particles from the air or liquid flow e.g. a *cyclone*, a *vortex grit separator*.

**accelerated stabilisation of a landfill** *See flushing bioreactor landfill*.

**acceptable daily intake, ADI** The daily intake of a particular substance that does not cause any adverse health effect. It is derived by dividing the *NOEL* (no observed effect level) or *NOAEL* (no observed adverse effect level) by a safety factor such as 10. *See reference dose*.

**access eye** An access hole at a bend in a drain pipe, ordinarily covered by a metal plate wedged or bolted over it, which enables the pipe to be rodded. *See rodding*.

**acclimatisation, acclimatization, acclimation** Adaptation of a micro-organism or animal to an altered environment.

**accumulation tank** A tank used to store water or wastewater.

**acenaphthene** One of the *polycyclic aromatic hydrocarbons*.

**acenaphthylene** One of the *polycyclic aromatic hydrocarbons*.

**acetogens, acetogenic bacteria, acid formers** The formation of simple organic acids, such as acetic acid, by the biodegradation of more complex organic material. It is an important stage in anaerobic biodegradation, e.g. in *anaerobic sludge digestion* or a *landfill* site.

**ACGIH** The *American Conference of Governmental Industrial Hygienists*.

**Achari** Mites.

**Achorutes subviaticus** See *Hypogastrura viatica*.

**Achromobacterium** A genus of bacteria commonly found in *activated sludge, trickling filters, denitrification* processes and *anaerobic sludge digestion*.

**acid** See *acidity*.

**acid dewpoint** Small amount of acids, particularly sulphuric acid, can raise the *dewpoint* substantially. This can cause acid corrosion of components in air pollution control devices even though the temperature is well above 100 °C.

**acid fermentation** One stage of *anaerobic* decomposition, resulting in the biodegradation of complex organic compounds to simpler organic acids, as in *anaerobic sludge digestion*. See below and *biodegradable*.

**acid formers** A group of facultative and *obligate anaerobes*, capable of *hydrolysis*, which can ferment complex organic compounds to organic acids, including acetic acid, CH<sub>3</sub>COOH, and propionic acid, CH<sub>3</sub>CH<sub>2</sub>COOH. For effective *anaerobic digestion* they should be in equilibrium with the *methanogenic bacteria*. The main acid formers are the *obligate anaerobes*, which are 10 to 100 times more numerous in digesting sludge than the facultative anaerobes.

**acid hydrolysis** *Hydrolysis* of a chemical by the addition of an acid. For example, wastes high in cellulose (e.g. waste straw or paper) can be pulped in water. The addition of a strong acid and steam (to raise the temperature) hydrolyses the cellulose in the pulp into sugars which can then be separated out and fermented into alcohol fuels.

**acidification of lakes** *Acid rain* has a low pH and can cause a drop in the pH value in the lake. Acidification may cause a change in the ecology of the lake. In particular, trout and salmon are very sensitive to low pH levels. Acidification may release toxic aluminium ions into the water.

**acidising** *Stimulation of a well* in dolomite or limestone with acid, to remove incrustation.

**acidity** Acidity of a water is measured by hydrogen ion concentration, usually called *pH*. Waters with pH below 7.0 are acid. In unpolluted water, acidity comes from dissolved carbon dioxide or organic acids leached from the soil. Atmospheric pollution also may cause acidity. Acid waters corrode metal or concrete. See *alkalinity*.

**acid mine drainage** Polluted mine drainage water is often acidic. The pyrite (iron sulphide) present in mines (especially coal or sulphide mines) is oxidised by air, water and bacteria (*Thiobacillus*) to sulphuric acid and ferrous sulphate. Consequently the water leaving the mine may contain from 100 to 6000 mg/l of sulphuric acid and from 10 to 1500 mg/l of ferrous sulphate, FeSO<sub>4</sub>. Treatment of the water may include *sedimentation* after *neutralisation* by lime or limestone. See *discharge prevention, iron in water, oxidation prevention*.

**acidophiles** Micro-organisms that grow in strongly acidic conditions.

**acid rain** Rainwater is slightly acidic due to the dissolution of CO<sub>2</sub>. Rain dissolves acidic air pollutants such as SO<sub>x</sub> and NO<sub>x</sub> and so the rain

becomes more acid. Values as low as pH 3.0 have been recorded. Acid rain can make lakes and rivers acid and damage plant life such as trees.

**acid soot, a. smut** Large soot particles that contain sulphurous or sulphuric acids formed in a furnace where sulphur in the fuel burns to  $\text{SO}_x$ . Emissions of acid soot can be reduced or eliminated by reducing the amount of excess air, by using low sulphur fuel, by raising *flue gas* temperature, etc.

**Acinetobacter** A bacterium that is able to accumulate polyphosphate to over 20% of its cell mass. It is important in *biological phosphorus removal*.

**AC pipe** *Asbestos cement pipe*.

**acre-foot** The volume of water required to cover 1 acre of land by one foot of water. It is equal to  $1233 \text{ m}^3$ .

**acrylamide,  $\text{CH}_2\text{CHCONH}_2$**  The monomer of *polyacrylamide*. Acrylamide is toxic to the nervous system in humans and may be present at trace levels in the polymer which is used as a coagulant aid in water treatment and also as a sludge conditioner. The WHO guideline maximum value is  $0.5 \mu\text{g}/\text{l}$  in drinking water. The EU Drinking Water Directive states a mandatory maximum of  $0.1 \mu\text{g}/\text{l}$ . The *USEPA* does not state a concentration for the *MCL* for drinking water, but states a specified treatment technique to ensure it is not present in the drinking water. This includes certification of the level of acrylamide dosed into the water when polyacrylamide is used in the treatment.

**acrylonitrile-butadiene-styrene, ABS** A type of *thermoplastic* that can be used for pipes.

**actinomyces** Unicellular organisms that are ordinarily listed as bacteria, although they may reproduce like fungi. They are common in earth and may be responsible for unpleasant taste or smell in drinking water, and may also be found in *aerobic biological treatment processes* or compost. Some species cause illness such as diphtheria, leprosy and *tuberculosis*. See *foaming* (2).

**activated alumina** Alumina ( $\text{Al}_2\text{O}_3$ ) that has been treated to increase its surface area and thus to enhance its adsorptive properties. It can remove phosphate and *arsenic* compounds from liquid wastes and can dry gases.

**activated biofilter** A *high rate trickling filter* usually followed by an aeration tank and always a sedimentation tank. Some of the sludge from the sedimentation tank is recycled to the filter. This enables a high concentration of biofilm growth in the filter and therefore the BOD loadings on the filter can be much higher than conventional design. This system may be used for a *roughing filter* giving about 60% removal for loadings up to  $4 \text{ kg BOD per m}^3$  of filter.

**activated biosolids** *Activated sludge*.

**activated carbon** A type of carbon that has been derived from charcoal made from wood, peat, etc., by treatment of the charcoal with steam at  $900^\circ\text{C}$ , or by with phosphoric acid at  $600^\circ\text{C}$ , or in some other way, to increase its porosity and its surface area. Its large surface area per unit mass (up to  $1400 \text{ m}^2/\text{g}$ ) enables it to adsorb trace organics and other undesirable

components of a water intended for drinking, or from a malodorous air. It is expensive. It can be used in water treatment as a filter of **granular activated carbon** (GAC) in a **carbon adsorption bed**. Alternatively it may be added as **powdered activated carbon** (PAC) into the water, after which it is removed by filtration. GAC is larger than 100  $\mu\text{m}$  whereas PAC is usually less than 50  $\mu\text{m}$ . Activated carbon can be used in air pollution control to remove toxic organics from gaseous effluents, such as incinerator waste gases. Activated carbon is widely used for odour control, with the odorous gas being passed through beds of GAC.

**activated carbon bed** A **carbon adsorption bed**.

**activated carbon block** A block moulded or extruded from a mix of activated carbon and a suitable binder. The block can be used as a cartridge filter.

**activated carbon filter** See **carbon adsorption bed**.

**activated silica** A **coagulant aid** that, added to water, forms a long chain inorganic polymer. It is prepared by adding a small quantity of acid to sodium silicate.

**activated sludge** A biomass made by continuous recirculation of the sludge from the **secondary sedimentation tank** to the **aeration tank**, thus acquiring many active aerobic bacteria, from 100 to 1000 million per millilitre of mixed liquor. The bacteria are embedded in or on a slime that forms 90% of the solids content of the sludge. The slime, mainly **polysaccharides**, is produced by the bacteria as they consume the **BOD<sub>5</sub>**. **Protozoa**, especially **ciliate protozoa**, may also be present in the sludge, feeding on the bacteria. See below.

**activated sludge—powdered activated carbon treatment** **PACT process**.

**activated sludge process** A continuous, aerobic biological treatment for wastewater dating from 1913, that uses a culture of bacteria suspended in the wastewater in an **aeration tank** to adsorb, absorb and biodegrade the organic pollutants. **Flocs** are formed that may reach 0.1 mm in diameter in the aeration tank. These are kept in suspension either by air blown into the bottom of the tank (**diffused air system**) or by **mechanical aeration** (see *Figure A.2*). The mixture of the activated sludge and the wastewater in the aeration tank is known as the mixed liquor. The concentration of mixed liquor is known as mixed liquor suspended solids (**MLSS**), but is also

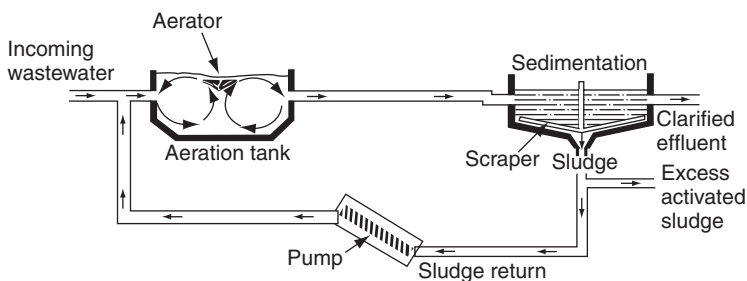

**Figure A.2** Activated sludge process, flow diagram.

measured as mixed liquor volatile suspended solids (*MLVSS*). The mixed liquor flows from the aeration tank to a sedimentation tank, where the activated sludge flocs combine together into larger particles that settle as a sludge. Most of the sludge from the sedimentation tank returns to the aeration tank. The dissolved oxygen in the aeration tank should be at least 0.5 mg/l, preferably 1 to 2 mg/l (see *oxygen activated sludge*). The aeration tank may be designed on *aeration period*, preferably on *F:M ratio* or *mean cell residence time*. If the ammonia present is to be oxidised to nitrate, the plant must be designed for *nitrification*. In municipal wastewater, the activated sludge process is usually preceded by *primary sedimentation*. In the start up of an activated sludge plant, the time needed for establishing the appropriate bacteria and protozoa can be greatly reduced by *seeding* the new aeration tank with sludge from one that is working well. Activated sludge treatment demands only about one seventh of the land occupied by *trickling filters*. It also does not suffer from *filter flies* and has little smell. The operating cost of the aeration tank can be high and skilled attention is essential. Many varieties of activated sludge treatment exist, including *contact stabilisation*, *extended aeration*, *modified aeration*, *oxygen activated sludge*. See also *oxygenation efficiency*, *return activated sludge*, *sludge production*, *suspended immobilised biomass reactors*.

**activated sludge settling tank** A *sedimentation tank* that follows after an *activated sludge* plant. The tank is used to settle out the *biomass* that has formed in the biological reactor from the treated effluent. Most of the settled activated sludge is returned back to the aeration tank. In a traditional treatment plant for domestic wastewater, activated sludge settling tanks are known as *secondary sedimentation tanks*. Tanks are typically 2.5 to 4 m and the *surface loading rate* is from 20 to 45 m<sup>3</sup> per day per m<sup>2</sup> of tank surface area. The *solids loading rate* is from 80 to 140 kg/m<sup>2</sup>.d.

**active carbon** See *activated carbon*.

**actyl hydroxide** *Peroxyacetic acid*.

**acute toxicity** A toxic effect that has clear symptoms that occur rapidly after the exposure to the toxic substance. Acute toxicity can be measured by median lethal concentration or dose. See *LC50*.

**adenosine triphosphate, ATP** The energy storing substance required to carry out the biochemical reactions in a cell. When its energy is released, it breaks down to adenosine diphosphate (ADP), ready again to capture energy that will raise it to the level of ATP.

**ADF** *Alternating double filtration*.

**ADI** *Acceptable daily intake*.

**adiabatic** A description of something that occurs without heat transfer to or from the surroundings.

**adiabatic lapse rate** A *lapse rate* under *adiabatic* conditions, which is calculated as about 0.4°C temperature drop per 100 m of climb for air saturated with water vapour at 20°C and 1°C per 100 m climb for dry air. A sub adiabatic lapse rate (involving less cooling of the air with height) makes for *stability* of the air. An atmosphere with a *superadiabatic* lapse

- rate (when the temperature drops more than adiabatically) is unstable and so disperses pollutants quickly. *See inversion.*
- adit, sough** A tunnel driven into a hillside or from a well into water bearing ground, at a slight upward slope so that groundwater drains naturally out of the soil. Adits of disused mines can be used as suppliers of raw water, as can *ghantas*.
- admixture** An additive to concrete, mortar or grout used to improve its workability.
- ADR/RID** Regulations for the transport of hazardous waste in the European Union. ADR means European Accord relating to the transport of Dangerous materials by Road and RID means Regulation International concerning the transport of Dangerous materials by railways. ADR/RID gives a classification to the waste and thereby defines the requirements for its safe transportation.
- adsorbate** The component that is adsorbed on to a solid surface.
- adsorption** (verb *adsorb*) Adhesion of gases, vapours, liquids or solids on to a solid surface, the adsorbent (e.g. *activated alumina, activated carbon*). The substance adsorbed, the adsorbate, can thus be extracted from the liquid or gaseous stream. Adsorbents can be used once and then discarded, or used and reactivated (*see regeneration*). In biological treatment it is an important mechanism for BOD removal. For example, within about 30 min of entering an *aeration tank* the solid and liquid organics are adsorbed on to the *flocs* of *activated sludge*. After this adsorption, extracellular *enzymes* can start to break down the organics in such a way that they are absorbed and biodegraded by the bacteria. Chemisorption is adsorption by chemical bonding on to the surface of the adsorbent. In air pollution control, adsorption can be used to remove hydrocarbons or H<sub>2</sub>S or SO<sub>2</sub>.
- adulticide** A *pesticide* that kills adult insects.
- advanced wastewater treatment AWT, advanced treatment** Further action on wastewater effluent that has undergone biological treatment. *Denitrification* is one part of AWT, although it may have already begun in the *secondary treatment*. AWT may include *ammonia stripping, activated carbon, deep bed filters, ion exchange* or *membrane processes*.
- advancing face** The workface in a landfill operation where the new refuse is being tipped and compacted.
- advection** Heat transfer carried by a flow of liquid or gas.
- Aedes aegypti* A *mosquito* that carries viral diseases including *dengue* and *yellow fever*.
- aerated channel** (1) An *aerated grit channel*. (2) An *aerated launder*.
- aerated contact bed** A *trickling filter*.
- aerated grit channel, a. g. chamber, spiral flow grit chamber** A *grit channel* that is aerated with coarse bubbles so as to separate the grit from the wastewater (*see Figure A.3*). The airflow imparts a spiral motion to the wastewater. The velocity or the spiralling flow governs the size of particle of a given specific gravity that is removed. Adjustment of the airflow can produce almost 100% clean grit. Retention times of three minutes at maximum flow are common.

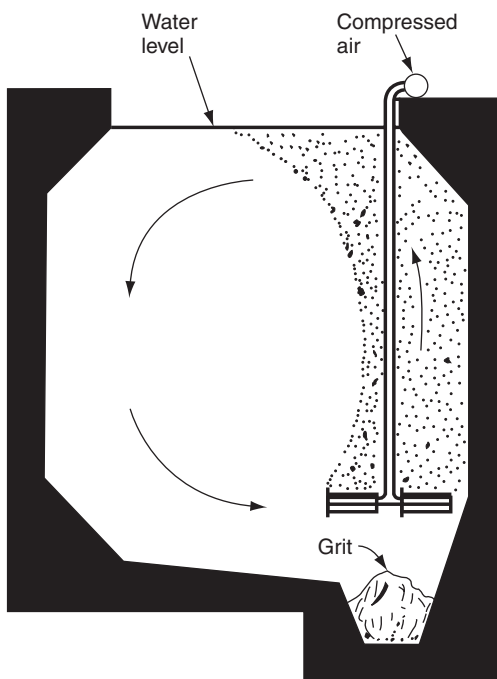
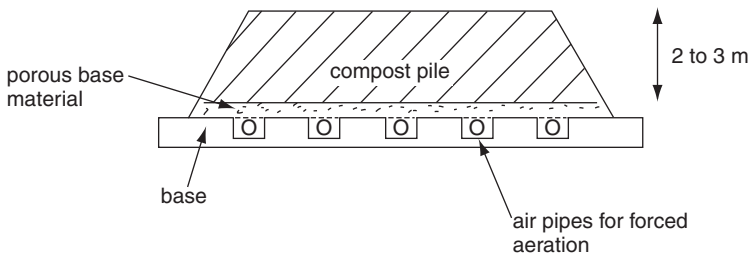

Figure A.3 Aerated grit channel (cross section).

**aerated lagoon** A pond or lagoon through which wastewater flows and is supplied with air by floating surface aerators or from diffusers or from submerged air pipes. It is an approach to a *completely mixed reactor* for aerobic biological treatment. The aeration is stopped for a period to allow the bacterial rich sludge to settle and some effluent can be decanted. It is a common treatment option for *landfill leachates*. If aeration is not sufficiently widespread, it is possible for parts of the lagoon to become anaerobic. See *high rate aerobic lagoon*.

**aerated launder, a. channel** A channel for distributing wastewater at a treatment works, with air injected throughout its length along the bottom to hold the solids in suspension. The velocity in the channel is then not critical and the wastewater is well oxygenated. Aerated launders also may be used for distributing *mixed liquor* to settling tanks.

**aerated static pile** A method of *composting* that includes pipes laid under the waste material. The pile height is about 2 to 3 m high (see Figure A.4). The pile is not turned and so this composting process takes up less room than *wind-rowing*. Three options exist for operation to keep the compost aerobic. Either the pipes are put under a slight vacuum so that air is pulled through the pile, or air is pumped into the pipes and air is pushed through the pile or the aeration system can be alternated between pressure and vacuum. It has been



**Figure A.4** Aerated static pile for composting. Compost pile may be covered with screened finished compost.

used for composting solid waste and wastewater sludge. The sludge is mixed with a bulking agent such as wood chips. Composting is completed in about 20 to 40 days. *See closed composting system, in-vessel composting, windrowing.*

**aeration** Addition of air to water or wastewater so as to raise its dissolved oxygen level or to purge gases from the water. *See activated sludge process, air stripping (2).*

**aeration period** The retention time in an aeration tank.

**aerated submerged fixed film reactor** A *biological aerated filter*.

**aeration tank** A tank for mixing and aerating wastewater in an *activated sludge process*—normally 3 to 5 m deep. Tanks may be divided into square pockets three times as deep as their width. Alternatively they may be continuous rectangular or oval channels or *oxidation ditches*.

**aerator** A machine or other device to dissolve oxygen in water or wastewater.

It may also purge unwanted gases (*see air stripping (2)*). Various types exist—*cascade aerators, diffused air, packed bed aerators, spray aerators* and *surface aerators*. All types create turbulence at the air water interface.

**aerial sewer** A sewer supported above the ground.

***Aerobacter Facultative*** bacteria that flourish both in *activated sludge* and in *anaerobic sludge digestion tanks*.

**aerobe** (adjective *aerobic*) A micro-organism that needs free or dissolved oxygen to develop (in *aerobiosis*).

**aerobic anaerobic pond, aerobic anaerobic lagoon** *Facultative waste stabilisation pond*.

**aerobic biological oxidation, aerobic oxidation** The reactions where *aerobes* oxidise compounds, e.g. carbon dioxide produced from the biodegradation of organic compounds; nitrate from the oxidation of ammonia, etc. *See anoxic*.

**aerobic biological treatment** Any treatment process that uses *aerobes* to biodegrade or oxidise or remove the unwanted organic or inorganic compounds. In the treatment of wastewaters, the processes can be divided into *suspended growth processes* (e.g. *activated sludge process, Figure A.2*) or *attached growth processes* such as *rotating biological contactors (Figure R.9)* or *trickling filters (Figure T.3)*. *See biological aerated filter (Figure B.6)*.

**aerobic digester** An *aeration tank* that treats waste activated *humus* or *primary sludges* or a mixture of them. The high cost of aeration and the absence of



fuel gas are disadvantages compared with *anaerobic sludge digestion*, but the reduction of *volatile solids* is about equal and the *supernatant liquid* has a lower BOD. Also, the sludge has no smell, is stable and more easily dewatered, there are fewer operational problems and the retention time is shorter than with anaerobic digestion. *See below.*

**aerobic digestion** The breaking down of complex organic material into simpler compounds by *aerobiosis* as in an *aerobic digester* or in *composting*.

**aerobic lagoon** A term that can mean *aerated lagoon*, *high rate aerobic pond* or *maturation pond*.

**aerobic oxidation** *See aerobic biological oxidation.*

**aerobiosis** Any life process that must have free or dissolved oxygen, usually with the production of carbon dioxide, CO<sub>2</sub>; nitrate, NO<sub>3</sub><sup>-</sup>; sulphate, SO<sub>4</sub><sup>2-</sup>; phosphate, PO<sub>4</sub><sup>3-</sup>; etc.

**Aeromonas** A bacterium that may be found in water. Some species can result in illness particularly in immunocompromised patients.

**aerosol** Fog, mist, smoke or any other dispersion of solid or liquid particles so small that they remain suspended in the air. *See respirable dust.*

**aesthetic contaminants** Components in water which affect the aesthetics (e.g. taste or colour) but do not have adverse health effects.

**aestivate** To be dormant during the summer or dry season.

**afterburner** A device fitted in the flue gas circuit of some incinerators between the furnace and the chimney, so as to complete the burning of tars and other volatiles. It may be oil or gas fired. *See also two stage incinerator.*

**A/F ratio** *Air to fuel ratio.*

**African sleeping sickness, A. trypanosomiasis** *See trypanosomiasis.*

**afteruse** The ultimate use of a *landfill* site or contaminated land after the site has been rehabilitated or reinstated. Because landfill sites settle over a number of years, the afteruse is more likely to be recreational, such as park land, rather than a building development.

**agar-agar** A substance made from seaweed and used in solid culture *medium* for bacteria and fungi.

**ageing of lakes** Lakes may become marsh and eventually dry up because of the stimulation of their plant life by natural *eutrophication*. The addition of human wastes or farm fertilisers may accelerate the ageing by increasing the nutrient input to the ecosystem.

**Agenda 21** A global environmental agenda for sustainable development which was set at the *Rio Earth Summit 1992*. It includes conservation and management of natural resources. The implementation of this agenda at the local level is known as Local Agenda 21.

**agent orange** A strong herbicide and defoliant that is a mixture of *2,4,5-T* (2,4,5, trichlorophenoxyacetic acid) and *2,4-D* (2,4 dichlorophenoxyacetic acid). It was used extensively in the Vietnam War. It was contaminated with extremely dangerous *dioxins*.

**agglomeration** Coalescence or *flocculation*.

**aggressive index, AI** A corrosion index established by the American Water Works Association (AWWA). The AI = pH + log<sub>10</sub> (total alkalinity × hardness).

**aggressiveness of water** *Corrosiveness of water.*

**agitated bed in-vessel composting, agitated bay composting** *See in-vessel composting.*

**agrochemical** Chemicals that are used in agriculture.

**agricultural drain** A *land drain.*

**agricultural runoff** The water that flows from cultivated land. It can also be a source of nitrate, phosphate or pesticides in surface waters or groundwaters.

**agricultural wastewater** This wastewater is one of the largest contributors to waste disposal to land. It includes liquid runoff from slurry pits which are likely to be high in organic and nutrient content and can be beneficial when spread on land. However runoff can be a major cause of water pollution in rural areas. *See cowshed wastewater, dairy and milk bottling wastewater, piggery wastewater, poultry house wastewater, silage liquor.*

**AI** *Aggressive index.*

**air binding** Air becoming stuck in the media of a *rapid deep bed filter* and thereby reducing the efficient operation of the filter.

**airborne dust** Dust larger than 10 microns settles quickly in air. At 1 micron size, however, dust settles so slowly (about 0.03 mm/s, varying with density) that it can be considered airborne at and below this size. *See fume.*

**air breakthrough** If *landfill gas* is being extracted through gas wells, the partial vacuum in the well may cause some net flow of air from the surface into the fill and into the well. This air breakthrough must not be allowed to occur because landfill gas can have 50 to 60% methane and the air methane mixture can be explosive.

**air chamber, a. vessel** An air pocket near the outlet from a reciprocating pump, or in a water main, etc., which smooths out *pressure surges in pipe flow.*

**air changes** One change is a volume of fresh air equal to the volume of the room in question. In an industrial kitchen 20 or more changes per hour may be required. A library or office may need only two changes per hour.

**air classification, a. separation** Separating materials by an air blast on falling particles, usually in *countercurrent.* Although called *classification*, it is a true separation. Air classifiers (*see Figure A.5*) may be used in the separation of mixed domestic refuse. *See materials recycling facility.*

**air cleaning plant** *See gas cleaning plant.*

**air/cloth ratio, gas/cloth r.** A variable in the design of a *fabric filter*, expressed in m<sup>3</sup>/min of gas filtered per m<sup>2</sup> of filter surface. Having thus the dimension metre/minute, it is the average speed of the gas through the fabric. Values may range from 0.6 m/min to 3 m/min, depending on type of cloth, type of dust, etc.

**air column separator** A vertical pipe in which an upward air current separates paper, plastics film, etc., by blowing them up away from the 'heavies', which fall to the bottom of the pipe. The speed of the air current may be adjustable in two ways: (a) by the fan speed; (b) by adjusting the width of the pipe. This unit is well suited to separating all the lights from all the heavies. *See floating velocity.*

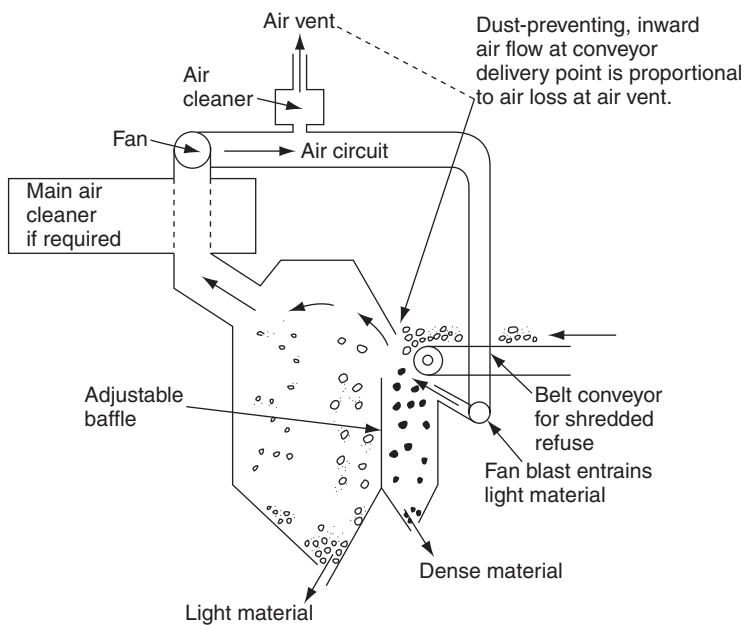

**Figure A.5** Air classifier showing one method of circulating air to reduce pollution by dust.

**air curtain** Bubbling of air from perforated pipes in order to control the spreading of an oil slick.

**air diffuser** A *diffuser*.

**air drying** The use of *lagoons*, *sludge drying beds*, etc. for drying sludge.

**air emissions abatement** See *air pollution control*.

**air filter** A device that catches dust from air passing through it, on a mesh of textile fabric, felt, wire, paper, etc., rather than by *dust arrestors*. Filters are used either for measuring the amount of dust in the air or for reducing it. Their use in *activated sludge* plants reduces blocking of the *diffusers*. See *fabric filter*.

**air flotation** See *dissolve air flotation*.

**air gap protection** A way of preventing contamination of mains water by *back siphonage*. The water outlet is above the appliance (e.g. toilet cistern above the toilet pan, taps are above the overflow outlet from the sink or bath). Therefore the soiled water cannot come into contact with the water in the supply pipes.

**air injection, oxygen i.** (1) Air is injected into long sewers to keep the wastewater *aerobic*, especially in pumped rising mains and in the rising limbs of siphons, both of which run full and may become *anaerobic*. Pure oxygen has been used because the volume to be blown in to provide a given dissolved oxygen level is only one fifth of the corresponding volume of

- air. But this option can be expensive. See *sulphide corrosion*. (2) *Diffused air system*. (3) See *air sparging*.
- air lift pump** A pump with no moving parts, consequently useful for lifting abrasive material such as gritty water. Two pipes of different diameter hang in the well. The smaller is sometimes within the larger. Air is blown down the smaller pipe and from it passes up the larger one. Air bubbles and water rise together in the larger pipe. Large volumes of very dirty fluid can be pumped though at high expense in compressed air and at low mechanical efficiency. For pumping wastewater, the air lift pump has the advantage of *aeration* of the water.
- air lift reactor** An *activated sludge* aeration tank which is deep and air is injected at the bottom into an inner draft tube. The *mixed liquor* flows down the outer part of the reactor. The *deep shaft process* is an example.
- air padding** Pumping air into a vessel to assist the withdrawal of a liquid.
- air pollutants** The bulk of air pollutants produced by human activity come from furnaces, the internal combustion engine and the smelting of metals, mainly *fly ash, sulphur dioxide, nitrogen oxides, carbon monoxide, hydrocarbons and ozone*. See also *acid smut, aerosol propellant, dust, fume, hydrogen sulphide, particulate, smog, smoke*.
- air pollution control technology** See *flue gas cleaning*.
- air pressure test** A method for testing of drainage installations. It involves filling the water seals and closing off the ends of the stacks and outlets into the main sewer. An air pressure of 38 mm of water gauge should be maintained for 3 minutes without further pumping.
- air pulse cleaning** *Pulsed air cleaning* of fabric filters.
- air quality assessment** See *ambient air quality assessment*.
- air quality control regions AQCR** In the USA, a state is divided into AQCRs. The state is required to set ambient standards for air quality in each AQCR.
- Air Quality Framework and Daughter Directive, 1999** This EU Directive places a legal obligation on member States to achieve the various limit values for air quality by the specified dates. Standards are listed under *carbon monoxide, lead, nitrogen oxides, ozone, particulates, sulphur dioxide*.
- air quality management areas, AQMA** In the UK, a local authority is legally obliged to monitor ambient air quality in its local area and publish the data.
- air quality standards** See *ambient air quality standards*.
- air release valve, air relief v., air v.** A valve in a water main that allows air to be automatically vented from the pipe. They are required so that air locks do not occur in the pipe system. They are placed at regular intervals throughout the distribution system and particularly at any high points. They may also be designed to allow air into the pipe during emptying.
- air sampling** See *Ringelmann chart, sampling train, tape sampler*.
- air saturation value** The solubility of dissolved oxygen in water, in equilibrium with air. It decreases as the temperature and *salinity* increase. The solubility of oxygen in water decreases also with decreasing atmospheric pressure

(and increasing altitude). At 15 °C and sea level the value is 10.1 mg/l but at 0 °C it reaches 14.6 mg/l.

**air scouring** An air flow up through a filter bed, such as a *rapid deep bed filter* or a *biological aerated filter* to loosen dirt or *biofilm* from the filter. This operation may take about 10 minutes and precedes *back-washing*.

**air separation** See *air classification*.

**air sparging** A *soil vapour extraction* technique where air is pumped into and passes up through saturated soil in order to remove the *VOCs* from the soil or groundwater. The air is forced into the ground, below the water table, via wells placed into saturated soil. See *biosparging*.

**air stripping** (1) The removal of unwanted gases from a water or wastewater by use of a *cascade aerator* or *packed tower aerator* with the contaminated water flowing down the tower and air being passed up through the tower. The towers have diameters between 0.5 to 3 m and heights from 1 to 15 m. The process can be used for removal of *VOCs* or *ammonia*. (2) Blowing air into a tank, lagoon, etc. containing water, wastewater, etc. to remove unwanted gases, such as carbon dioxide, hydrogen sulphide, *VOCs*, etc. See *ammonia stripping*.

**air to cloth ratio** *Air/cloth ratio*.

**air to fuel ratio** **A/F ratio** In the petrol (gasoline) engine, the correct A/F ratio is 15:1. If the mixture is rich, i.e. a low A/F ratio, the exhaust contains an increase in hydrocarbons and carbon monoxide. Rich mixtures as low as 11:1 may be obtained during acceleration. If the mixture is lean, i.e. a high A/F ratio, the exhaust is low in hydrocarbons and carbon monoxide. With lean mixtures, the *NO<sub>x</sub>* increases but at very lean mixtures the *NO<sub>x</sub>* decreases. At A/F ratios of greater than 17:1, the petrol air mixture fails to ignite properly.

**air toxics** See *hazardous air pollutants*.

**AISI sampler** The *tape sampler* devised by the American Iron and Steel Institute.

**Aitken nuclei** Tiny particles a few nanons across, produced when anything solid burns. They can amount to a few hundred thousand per ml in the air near a large boilerhouse.

**alachlor** A herbicide that is carcinogenic to humans. The *USEPA MCL* in drinking water is 2 µg/l and the WHO guideline maximum value is 20 µg/l. The EU Drinking Water Directive states a mandatory maximum of 0.1 µg/l. The EU lists it as a *priority substance* in relation to aquatic discharges.

**ALARA** As Low As is Reasonably Achievable, a concept that is applied to radiation exposure.

**albedo** The fraction of the radiation that is reflected from a surface.

**albuminoid nitrogen analysis** An obsolescent but quick analysis of wastewater—determining the fraction of the combined organic nitrogen that is easily decomposed by alkaline potassium permanganate, *KMnO<sub>4</sub>*, after the release of any ammonia by distillation.

*Alcaligenes Facultative anaerobic bacteria* that grow well in *activated sludge*, *trickling filters* and *anaerobic sludge digesters*.

**aldehydes** Organic compounds that can be formed when hydrocarbons are incompletely burnt, as often happens in petrol engines. Consequently they occur in photochemical smog. *See formaldehyde*.

**aldicarb** An insecticide that is toxic to humans affecting the nervous system. The *USEPA MCL* in drinking water is 3 µg/l, but 2 µg/l for aldicarb sulphone. The WHO guideline maximum value is 10 µg/l in drinking water. The EU Drinking Water Directives states a mandatory maximum of 0.1 µg/l.

**aldrin** A *cyclodiene* insecticide that is toxic to humans affecting the human nervous system and kidneys. It can undergo *biomagnification* in food chains. The WHO guideline maximum value in drinking water is extremely low at 0.03 µg/l. The EU Drinking Water Directive states a mandatory maximum of 0.03 µg/l.

**alga** (plural *algae*) A large group of simple *photosynthetic* autotrophic organisms. They are single celled or multicellular. Thus a water containing algae suffers diurnal variations in dissolved oxygen, and in sunlight its CO<sub>2</sub> content falls. The CO<sub>2</sub> originates from bacteria (*see symbiosis*) or from bicarbonates releasing hydroxyl ions (OH<sup>-</sup>) which tend to raise the pH of water:

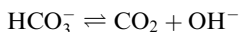

For *facultative waste stabilisation ponds* to function well, algae such as *Chlamydomonas*, *Chlorella*, *Euglena* are needed to supply oxygen to aerobic *heterotrophic* bacteria that consume and oxidise the wastewater. The most important classes of freshwater algae are the *green algae* (Chlorophyta) including *Chlorella*, the motile, bright green flagellate unicellular *Euglenophyta* including *Euglena*; and the yellow-green or golden brown, usually unicellular *Chrysophyta*. Freshwater algae are usually microscopic, although they can form a dense mat (a *bloom*) on the surface of a nutrient rich water. They can give the water an unpleasant taste and smell. They may release poisonous *endotoxins* into the water. Some seawater algae (the brown algae) may grow to a large size. Marine *dinoflagellates* can bloom and releases *endotoxins* causing *red tide* in the sea. *Pfiesteria piscicide* is an estuarine dinoflagellate that release endotoxins. Algae in reservoirs can be reduced by aerating the water in order to reduce the CO<sub>2</sub> content. Copper is a strong algicide and so addition of copper salts (e.g. copper sulphate) kills algae in water. Algae may be found in *waste stabilisation ponds*. *Cyanobacteria* used to be considered as blue green algae but they are now considered to be a group of bacteria even though they are capable of photosynthesis. *See destratification of lakes*.

**algal bloom** *See bloom*.

**algal harvesting** The growing of *algae* (e.g. in a lagoon of wastewater or effluent) so as to reduce its nitrogen and phosphorus concentrations. The algae are periodically removed. *See single cell protein*.

**algal pond** A *waste stabilisation pond* treating raw wastewater or effluent, to which an oxygen rich effluent containing *algae* is added.

**algicide** A chemical to kill algae. Copper salts (e.g. copper sulphate) are the most common.

**alkali, alkaline** *See alkalinity.*

**Alkali Inspectorate, Alkali and Clean Air I.** UK qualified chemists or chemical engineers, first collected together as a group under the Alkali Act of 1863 and are now incorporated into the Health and Safety Executive.

**alkaline fermentation** In *anaerobic digestion, methane fermentation.*

**alkalinity** Alkalinity in water has at least two meanings, as follows. (1) Any water with a *pH* value above 7.0, but *see also caustic alkalinity* and *total alkalinity*. (2) More often it means the total of the alkaline substances present (i.e. the bicarbonates,  $\text{HCO}_3^-$ ; carbonates,  $\text{CO}_3^{2-}$ ; and hydroxides,  $\text{OH}^-$ , all of which react with acids.  $\text{Ca}(\text{HCO}_3)_2$  is the commonest of these but analyses are normally quoted as 'alkalinity as  $\text{CaCO}_3$ ', meaning the total of substances determined by titration to *pH* 4.5 and expressed as the equivalent of  $\text{CaCO}_3$ . The commonest causes of alkalinity,  $\text{Ca}(\text{HCO}_3)_2$  and  $\text{Mg}(\text{HCO}_3)_2$ , are the main cause of *carbonate hardness*. Consequently, when the figure of alkalinity equals the figure of hardness, all the hardness is carbonate. *See acidity.*

**alkali stabilisation of sludge** *Lime stabilisation.*

**alkanes** Chemicals of the group ethane, propane, butane, etc.

**alkenes** Chemicals of the group ethene (ethylene), propene (propylene), etc.

**alkyl benzene sulphonate, ABS** A 'hard' *surfactant* that has been less used in *synthetic detergents* since 1964, when it began to be replaced by the more *biodegradable* (soft) surfactant *linear alkyl sulphonate*, LAS. ABS consists of a benzene ring with a sulphonate ( $\text{SO}_3$ ) group substituted into it and a branch saturated carbon chain (normally 12 carbon atoms) attached to it. Bacteria have difficulty in attacking the branched carbon chain.

**alkylphenol ethoxylates, APEs** A group of chemicals that are used in wool scouring and may be found in polluted water. Some of them are *endocrine disrupters*.

**alligator shears** A unit of scrapyard plant with jaws like an alligator's or crocodile's that hold and chop heavy steel pieces to a length (1.5 m maximum) that can be fed into a steel furnace. It is also used for cutting thick timber or other bulky wastes before incineration or *shredding*. It may have one or several pairs of jaws.

**allochthonous material** Material that has moved from one environment to another. *Compare autochthonous material.*

**allyl thiourea, ATU, thiourea** A chemical that has a strongly inhibiting effect on *nitrifying* organisms. *See BOD.*

**alpha activity** The *USEPA* maxima for drinking water is 15 picocuries per litre for alpha radiation.

**alpha factor** For an *aerator* in an activated sludge plant, the rate of oxygen transfer in clean water divided by the rate of transfer in mixed liquor. *See oxygenation capacity.*

**alpha particle** A particle emitted in *radioactivity*, which consists of two protons with two neutrons—i.e. a helium nucleus.

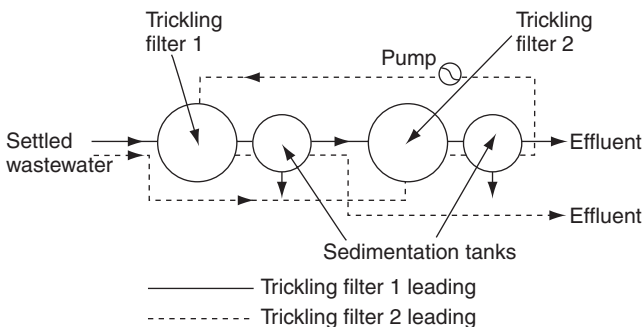

**Figure A.6** Alternating double filtration, flow diagram.

**alternating double filtration, ADF** To increase the organic load on a *trickling filter*, and to avoid *ponding*, two filters can be placed in series, with a *humus tank* after each. When the primary filter shows signs of ponding, or after a set time (e.g. 1 week), the two filters are reversed, with the second filter operating before the first one. (See Figure A.6.) There is an additional pumping cost, but in a plant with several filters and humus tanks there may be no need to build extra humus tanks. To obtain an effluent of BOD<sub>5</sub>: SS quality 25:35, organic loads up to 0.25 kg/d of BOD<sub>5</sub> per m<sup>3</sup> can be used. *Compare two stage filtration.*

**alum** The commercial grade of aluminium sulphate Al(SO<sub>4</sub>)<sub>3</sub>. It is a common *coagulant* for water treatment. It dissolves in water and precipitates a range of aluminium hydroxide compounds if alkalinity is present. See *alum sludge, coagulation.*

**alumina, aluminium oxide** Al<sub>2</sub>O<sub>3</sub> See *activated alumina.*

**alumina fibre** A *refractory* made of alumina, Al<sub>2</sub>O<sub>3</sub>, that can withstand furnace temperatures up to 1600 °C.

**aluminium** The UK spelling of aluminium.

**aluminium chlorohydrate**, Al<sub>2</sub>(OH)<sub>2</sub>Cl<sub>2</sub> A *conditioning* chemical that may be added to sludge before *dewatering of sludge.*

**aluminium in water** Aluminium is uncommon in natural freshwaters but carry over of aluminium from the water treatment works can result in significant aluminium concentrations in treated water. The health problems associated with aluminium in water are mainly in the use of kidney dialysis machines. High concentrations of aluminium in water can be toxic to fish. Acidification of water by acid rain or runoff from conifer plantations releases aluminium from the soil into the water. See *Table D.2 Drinking water standards.*

**aluminium recycling** About 30% of aluminium drink cans are recycled in the UK. In the USA, over 50 000 million aluminium cans are recycled. The aluminium scrap is sorted and graded before being smelted into aluminium ingots.

**aluminium sulphate** See *alum.*

**alumino-ferric** A chemical containing 92% hydrated aluminium sulphate, the remainder being mostly ferric sulphate, used as a *coagulant* for clarifying water.



**aluminum** The USA spelling of aluminium.

**alum sludge** A *waterworks sludge* formed when *alum* is the *coagulant*. The sludge is usually conditioned by adding *polyelectrolytes*, thickened and then dewatered mechanically, typically in a *filter plate press*.

**alveoli** (singular *alveole* or *alveolus*) The millions of small openings (sacs) in the lung where blood gives up carbon dioxide and takes up oxygen. Particles in the range 1 to 2 µm may be deposited in the alveolar region.

**amber list waste** Waste that is considered to be safe under the EU *Waste Shipment Regulations 1994* and requires prior consent for transfrontier shipment for recovery.

**ambient** In environmental matters, the environmental surroundings.

**Ambient Air Quality Assessment and Management Directive 1996** An EU Directive that requires Member States to monitor air quality and inform the public of the information. It also requires objectives to be set in order to improve air quality.

**ambient air quality standards** For the EU, *see above* and *Air Quality Framework and Daughter Directive, 1999*. For the UK, *see below*. For the USA, *see National Ambient Air Quality Standards*.

**Ambient Air Quality Standards and Objectives** As part of the UK *Environment Act 1995*, the UK has established a *National Air Quality Strategy*. Local Authorities are required to review their ambient air quality against these objectives and implement appropriate action to achieve these objectives if they are not met.

**ameba, amebiasis** The USA spelling of *amoeba, amoebiasis*.

**American Conference of Governmental Industrial Hygienists, ACGIH** Together with the *OSHA*, they determine the allowable occupational exposure concentrations for some pollutants in the USA.

**American Petroleum Institute** *See API separator*.

**American trypanosomiasis** *Chaga's disease*.

**American Water Works Association, AWWA** A non-profit scientific and educational society dedicated to the improvement of drinking water quality and supply, founded in 1881.

**Ames test** A test used to predict whether a chemical is carcinogenic. It is based on the mutagenic activity of the chemical on bacteria or animal tissue. About 85% of chemicals that are mutagenic are also carcinogenic so the test is not a perfect predictor for carcinogenicity.

**amino acids** Organic compounds that are the building blocks of proteins. Free amino acids contain an amino group (—NH<sub>2</sub>) and a carboxyl group (—COOH) and are therefore *amphoteric*.

**ammonia, NH<sub>3</sub>** Bacteria readily decompose *urea* and *proteins* in wastewater to form ammonia which may later be oxidised to *nitrites* and *nitrates*. It exists in water either as the ammonium ion, NH<sub>4</sub><sup>+</sup>, or as dissolved ammonia, NH<sub>3</sub>, thus:

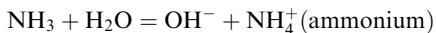

The equilibrium moves to the left as the pH rises. Domestic wastewater has typically 20 to 40 mg/l of ammonia. Ammonia can be in land-

- fill *leachates* up to several hundred mg/l. Ammonia exerts an oxygen demand in the wastewater or river as it is biochemically oxidised to nitrate. Ammonia can be toxic to some fish. Ammoniacal discharges to a river can cause stringy growth of bacteria and fungi along the river banks. The reactions of ammonia with chlorine are important in the *chlorination* of water. Ammonia can be removed from water and wastewaters by *ammonia stripping*, chlorination, *ion exchange*, *nitrification-denitrification*, etc. See *Table D.2 Drinking water standards*.
- ammoniacal liquor** Part of the liquid wastes from coke making, containing many pollutants, including ammonia, *phenols*, *cyanide compounds*. The ammonia is distilled off, leaving the waste product, *spent liquor*. See *coke plant wastewater*.
- ammoniacal nitrogen** Nitrogen as  $\text{NH}_3$ , ammonia, or  $\text{NH}_4^+$ , ammonium ion.
- ammonia oxidisers** *Nitrifying bacteria*.
- ammonia stripping, air s.** Removal of ammonia from wastewater by allowing it to flow down a *stripping tower* some 7 m high, up which 1500 times or more of its own volume of air is blown. The effluent is first made alkaline with lime to a pH of 11.0 so that the ammonia then exists all as  $\text{NH}_3$ . The method is very inefficient in cold weather and cannot be used if the water is likely to freeze in the tower. Ammonia stripping can also be undertaken in shallow aerated lagoons of the high pH wastewater.
- ammonification** The production of ammonia by biodegradation of organic nitrogen.
- ammoxidation** A reaction between the vapours of ammonia and hydrocarbons in the presence of oxygen.
- amoeba** A group of protozoa of the class of *rhizopods* including the genus *Amoeba*. Some of them produce diseases such as dysentery in humans. Others occur in *trickling filters* and possibly in *activated sludge*.
- amoebiasis, amoebic dysentery** A disease caused by *Entamoeba histolytica* that can have various symptoms with a wide range of severity from a mild abdominal pain to an acute fever with bloodstained diarrhoea followed by abscesses in the liver and possibly also in the lungs and brain. Contaminated water is the usual means of transmission although various contaminated foods or direct contact with contaminated faeces might also be involved. Carriers who show no symptoms may disseminate the infection. Improved sanitation is the most effective form of control of the spread of the disease. The disease is less common than other waterborne protozoal diseases such as *cryptosporidiosis* or *giardiasis*.
- amoebic cyst** A *cyst* of an *amoeba*.
- amoebic meningoencephalitis** A severe illness caused by pathogenic protozoa such as *Naegleria fowleri* and some species of *Acanthamoeba*. These protozoa can be found in the water and wastewater and enter the human body via nasal inhalation or via abrasions or as a secondary infection.
- Amphipoda** *Freshwater shrimps*.
- ampholytic** Description of a substance that carries positive and negative charges.
- amphoteric** Description of substances that act as both acid and alkali.

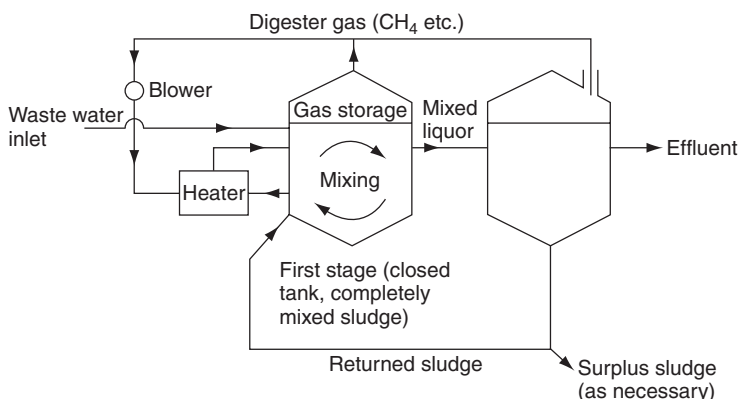

**Figure A.7** Anaerobic contact process, flow diagram.

***Anabaena flos-aquae*** A strain of *cyanobacteria* (blue green algae) that can form *blooms* on nutrient rich water. It has been associated with the production of *endotoxins*.

**anabatic wind** An uphill wind, caused in the daytime by the sun warming a hillside.

**anabolic metabolism, anabolism** The synthesis of *metabolism*, forming cell walls, *protoplasm*, nuclei etc. Compare *catabolic metabolism*.

**anaerobe** (adjective **anaerobic**) A micro-organism that needs no free oxygen to develop (in *anaerobiosis*).

**anaerobic activated sludge process** *Anaerobic contact process*.

**anaerobic attached growth process** *Anaerobic filter*.

**anaerobic biological oxidation** *See anaerobic oxidation*.

**anaerobic biological treatment** *Anaerobic treatment*.

**anaerobic contact process, anaerobic activated sludge process** Industrial wastewater with high BOD can be treated by an *anaerobic suspended growth system*. The wastewater is fed into a completely mixed *anaerobic digester* which is followed by a sedimentation or flotation tank from which the sludge is returned to the digester. *See Figure A.7*.

**anaerobic digestion** The breaking down of complex organic material into simpler compounds by *anaerobiosis* as in *anaerobic sludge digestion*.

**anaerobic digestion of municipal waste** Municipal waste can be mixed with wastewater effluent to produce a slurry of about 20 to 40% solids. This is sometimes known as dry digestion due to the low water content compared to conventional sludge digestion. The organic material in this slurry can then be treated by anaerobic digestion. The liquid from the digestion process may be recycled to the digester or incoming waste in order to enhance the biodegradation process. This is known as leach bed digestion.

**anaerobic fermentation** *Anaerobiosis*.

**anaerobic filter, anaerobic packed bed reactor** A tank, filled with packing media, which is flooded and without air. It can be used to treat a high

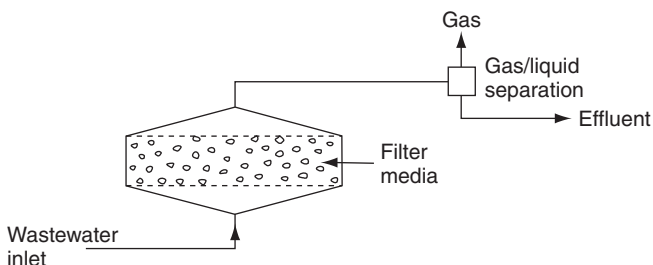

Figure A.8 Anaerobic filter, flow diagram.

BOD wastewater and *anaerobes* grow on the media (see Figure A.8). See *expanded bed anaerobic process*. Compare *anoxic filter*.

**anaerobic lagoon** See *anaerobic waste stabilisation pond*.

**anaerobic oxidation, a. biological o.** The reactions in an anaerobic process that produce methane and carbon dioxide can be described as anaerobic oxidation, since, in the absence of air, oxygen from various organic and inorganic compounds are used to produce  $\text{CO}_2$ . The process has two stages, the first being acid fermentation in which facultative and obligate anaerobes break down complex organics to form simpler low molecular weight substances such as acetic acid. In the second stage, methanogenic bacteria can form methane and  $\text{CO}_2$  from the organic acids or other simple organics. The acid fermentation tends to reduce the pH but methane formers exist above pH 6.5. Therefore the pH should be kept above 7 to obtain methane. The process is slow at low temperatures, e.g. less than  $10^\circ\text{C}$ . See *anoxic*.

**anaerobic pond** See *anaerobic waste stabilisation pond*.

**anaerobic sludge blanket** See *upflow anaerobic sludge blanket*.

**anaerobic sludge digestion** The *anaerobic digestion* of wastewater sludge. It is common to maintain a temperature of around  $35^\circ\text{C}$  (*mesophilic digestion*). The process may be operated as a single stage process (e.g. *slow rate anaerobic sludge digestion*). But it is normally a two stage process (sometimes known as high rate anaerobic sludge digestion) with the heated primary digestion tank mixed either mechanically or by pumping the *sludge gas* back through the digester or by pumping around the digesting sludge (Figure A.9). Most of the digestion takes place in the primary digester. Primary digestion is followed by an open unheated tank for *secondary digestion* which allows the digestion process to finish and the digested sludge to settle and thicken. The design of the primary tank is either on retention time (e.g. 15 days) or on the loading of volatile suspended solids, VSS (e.g.  $1.5 \text{ kg VSS per day per m}^3$  of tank). Complete digestion reduces the *volatile solids* in the raw sludge by up to 70%. This is equivalent to a 50% reduction in the total sludge solids, assuming that 70% of the raw sludge solids are volatile. Many of the problems of operating anaerobic digestion arise from the difficulty of maintaining an

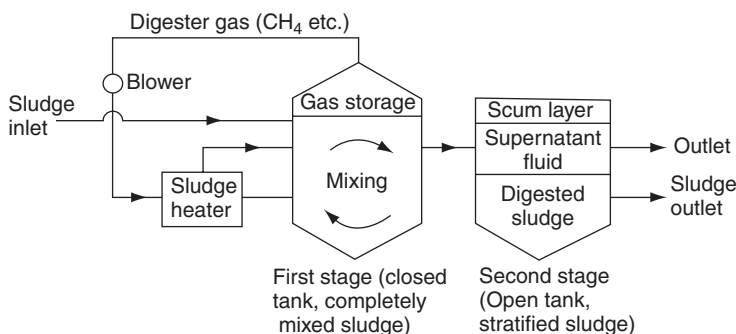

**Figure A.9** Anaerobic sludge digestion, flow diagram of two-stage process.

adequate population of methanogenic bacteria. They are seriously affected by small quantities of toxic materials in the sludge. If the methanogenic bacteria are killed, the sludge is left in an obnoxious half digested state. Starting an anaerobic digester can be difficult and pH control is critical to enable the methanogenic bacteria to flourish. The ratio of the concentration of organic acids to *total alkalinity* (both expressed as equivalents per litre) should be under 0.5, preferably about 0.2. *See also acid formers, anaerobic contact process, cold digestion, digested sludge, methane fermentation, sludge gas, thermophilic digestion.*

**anaerobic sludge digestion tank, a.s. digester** A tank for *anaerobic sludge digestion*. It is normally heated to around 35°C (*mesophilic digestion*) or possible 55°C (*thermophilic digestion*). The *sludge gas* is collected and used as a fuel to heat the sludge. Primary tanks usually have scum breakers and a roof that may be floating or fixed. If the roof is floating, it forms a gasometer to hold the methane. The primary digester normally is mixed by recirculating either the sludge or the gas or both. Sludge is heated by circulating it through an external heat exchanger. Tanks are usually circular, not less than 7.5m deep at the centre or less than 6m diameter, but up to 35m diameter and 14m deep. If a floating roof is provided, it has to be gastight round the rim where it meets the tank wall. *See cold digestion, egg shaped digester.*

**anaerobic suspended growth process** In wastewater treatment, a process in which *anaerobes* are suspended and mixed with the wastewater in an anaerobic reactor. Examples include *anaerobic contact process, anaerobic sludge digestion, upflow anaerobic sludge blanket.*

**anaerobic treatment, a. biological t.** Any treatment process that uses *anaerobes* to remove unwanted organic or inorganic compounds. In the treatment of wastewaters, the processes can be divided into *anaerobic suspended growth process* (e.g. *upflow anaerobic sludge blanket, Figure U.2*) or *attached growth process* such as the *anaerobic filter (Figure A.8).*

**anaerobic waste stabilisation pond** A *waste stabilisation pond* with a high organic load e.g. higher than 250 kg of BOD per hectare of pond per day, which

- gives about three to five days retention time. About 50% of the BOD is removed. If the pond is in stable alkaline condition there is little smell because the sulphide is present as  $S^{2-}$  and not  $H_2S$ . For full treatment, the anaerobic pond is followed by *facultative waste stabilisation ponds* and *maturation ponds*. Anaerobic ponds are 2 to 4 m deep and are desludged every 3 to 5 years.
- anaerobiosis** Life in the absence of free or dissolved oxygen, typically resulting in the production of methane, *ammonia*, *hydrogen sulphide*, and, like *aerobiosis*, also of carbon dioxide, due to *anaerobic oxidation*.
- Ankylostoma duodenale* and *A. ceylanicum* See *Ankylostoma duodenale*.
- angiosperms** Flowering plants.
- Ångström** or **ångström** A unit of length,  $10^{-10}$  m,  $10^{-4}$  micron, 0.1 *nanon*.
- anion** A negative *ion*, one that moves to the *anode* in *electrolysis*.
- anion exchange** Replacement of acid radical ions such as  $NO_3^-$  by  $OH^-$  (hydroxyl ions) in water by using *ion exchange*.
- anion exchange capacity** The ability of a material or soil etc. to exchange anions. In soil, it is small compared to the *cation exchange capacity*. See *ion exchange*.
- anion exchange resin**
- anion exchange resins** See *ion exchange*.
- anionic detergent** See *synthetic detergent*.
- Anisopus fenestralis* *Sylvicola fenestralis*.
- Ankylostoma duodenale* The hookworm responsible for ankylostomiasis. See *hookworm disease*.
- annelid, Annelida** Small segmental worms that may be found in *trickling filters*, which feed on the *biofilm*. *Polychaeta* annelids are important in marine *bioassays*.
- anode** (adjective **anodic**) The positive *electrode* in *electrolysis*, attracting *anions*.
- anopheline mosquito, Anopheles genus of mosquito** *Vectors* of *malaria* and sometimes *filariasis*, which carry the parasitic *spore forming protozoa* that live in the blood and cause the illness. See *mosquitoes*.
- anoxic (noun: anoxia)**. Description of conditions without free oxygen, but *aerobic biological oxidation* exists. Oxygen is available for respiration from dissolved inorganic substances such as nitrate ions. It is not *anaerobiosis* and no methane is produced. Anoxic sections in *activated sludge* plants may be used for *denitrification*.
- anoxic filter** A *denitrifying filter* in which a tank is filled with media and flooded, into which is fed a *nitrified effluent* and a source of organic food. The bacteria that grow in the filter, metabolise the organic material, use the oxygen in the nitrate as the oxygen source and  $N_2$  is produced. The effluent is thereby denitrified. Denitrification of a nitrified effluent can be achieved by locating an anoxic filter after secondary sedimentation. Methanol or other carbon sources may be added to the secondary effluent to act as an organic carbon source for the denitrifying bacteria. Compare *anaerobic filter*.
- ANSI** American National Standards Institute.
- antagonism** (1) Interaction of two or more substances such that their total effect is less than the sum of their effects separately. (2) Prevention of the growth of an organism by the products or activities of another. Compare *synergism*.

**anthracene** A *polycyclic aromatic hydrocarbon* with three benzene rings attached to one another (see *Figure P.10*). The EU lists it as a *priority substance* (under review for possible re-grading as priority hazardous substance) in relation to aquatic discharges.

**anthracite capping** The replacement of the top 150 to 400 mm of sand in a *rapid gravity sand filter* with anthracite to make a *dual media filter*. Anthracite is a hard coal of low volatile content (less than 10%) and a specific gravity of about 1.4. Its low density compared with sand (s.g. 2.3) allows it to be used in a coarse size in the top layer of a downflow filter, where it remains after *backwashing*. This makes possible the practice of *coarse to fine filtration* in downflow filters.

**anthrax** A disease caused by the bacterium *Bacillus anthracis* that can be contracted by ingestion of, inhalation of or skin contact with the bacteria spores.

**anthropogenic** Associated or created by the activities of man.

**anticyclone** An area of the earth's atmosphere with the highest atmospheric pressure at the centre. The winds blow in the opposite direction from a *cyclone*—i.e. clockwise north of the equator, anticlockwise south of it. Anticyclones usually bring calm weather. See *inversion*.

**antifoaming agent** A chemical added to an *aeration tank* to stop the production of foam. It usually consists of a mineral oil and a spreading agent.

**antiknock** In a petrol (gasoline) engine, if the petrol burns unevenly or too rapidly in the cylinder, a distinct metal knocking or pinking sound can be heard. In order to control this effect, antiknock agents are added to the petrol thereby increasing the octane number. The main agents were tetra-methyl and tetraethyl lead which resulted in lead being emitted to the atmosphere from car exhausts.

**antimony, Sb** A toxic chemical that can affect the blood chemistry. See *Table D.2 Drinking water standards*.

**A/O process** An adaptation of the *activated sludge* process that can achieve *biological phosphorus removal* as well as BOD removal. The two stage process involves an anaerobic zone followed by an aerobic (oxidation) zone, which is used for BOD removal. The return activated sludge from the sedimentation tank is fed back to the start of the anaerobic zone. The first anaerobic zone is required in order to obtain biological phosphorus removal. See also *AAO process*.

**APEs** *Alkylphenol ethoxylates*.

***Alphanizomenon flos-aquae*** A strain of *cyanobacteria* (blue green algae) that can form *blooms* on nutrient rich water. It has been associated with the production of *endotoxins*.

**aphotic** Without light.

**API separator.** API is the American Petroleum Institute and this separator is used to remove oil from wastewaters. The tank is rectangular, 2 m deep and a length 10 times its width. The wastewater flows into one end and at the other end the effluent flows from the base of the tank. The oil floats on the tank and is skimmed off.

**Applicable or Relevant and Appropriate Requirements, ARAR** In solid waste disposal, ARARs are USA environmental standards for programmes other than those covered by *CERCLA* and *SARA*.

**application factor** A factor applied to the concentration of a toxicant that is considered to make it safe. The factor can vary from a tenth to a hundredth or more of the 96 h or 48 h *LC50* figure. It is sometimes found by dividing the 96 h *LC50* by the *maximum acceptable toxicant concentration*.

**appurtenant water right** Water rights that belong to a specific property or piece of land.

**APWA** American Public Works Association.

**AQCR** See *air quality control regions*.

**AQMA** See *air quality management areas*.

**aquaculture** The farming of fish or other aquatic animals, or possibly the farming of aquatic plants.

**aqua privy** A low cost toilet system in which squatting plate is directly above a *septic tank* (see *Figure A.10*). The down pipe is at least 100 mm below the top of the septic tank contents which assists in stopping odours going up into the squatting area. The overflow from the septic tank is normally discharged to a *soakaway*. The aqua privy is used in various rural and urban parts of Asia and Africa.

**aquatic** Concerned with water.

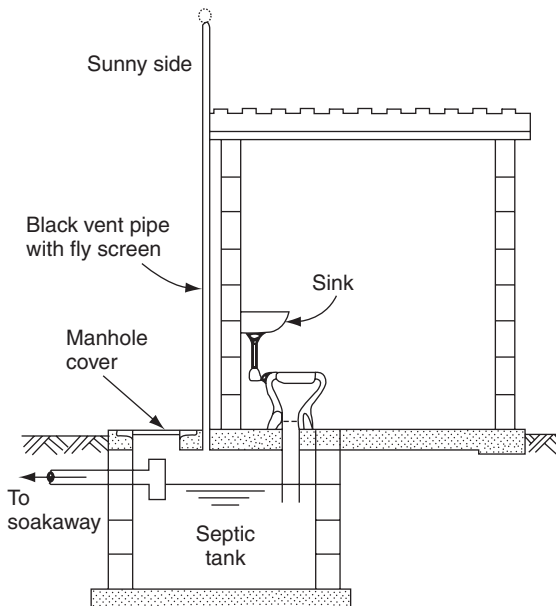

**Figure A.10** Aqua privy with a toilet. A squatting plate may be more usual.



**aquatic based natural treatment systems** Any treatment of wastewater or, more probably, wastewater effluent based on the aquatic natural environment such as *reed bed treatment*, *floating aquatic plant treatment system* and *constructed wetlands*. These treatment schemes are part of a range of *natural treatment systems*. See also *land treatment*.

**aqueduct** A conduit for water which may include lengths of tunnel or bridge. See *ghanat*.

**aquiclude** See *aquitard*.

**aquifer** Rock or soil that not only contains quantities of water, but also yields it easily to a pipe or well entering it (see *Figure A.11*). It must therefore be porous—i.e. of high *permeability* like uniformly sized gravel or sandstone or limestone.

**aquifuge** A rock or soil that neither contains nor transmits water in useful quantities.

**aquitard, aquiclude** A rock or soil of low *permeability* that delays the flow of water out of it. Even if it contains quantities of water, it releases water too slowly to be considered an *aquifer*. For clay this is shown by its high *wilting coefficient*.

**arachnid, Arachnida** A class of invertebrate animals that includes spiders, scorpions and mites, a subdivision of *arthropods*.

**ARAR** See *Applicable or Relevant and Appropriate Requirements*.

**arbitrary flow** Partial mixing of a fluid, resulting in a flow pattern that is intermediate between *plug flow* and a *completely mixed*.

**arbitrary flow reactor** A term used to describe a wastewater treatment process that is between a *plug flow* reactor and *completely mixed reactor*.

**arboviral diseases** A large group of viral diseases that can be acquired by man. Many of these infections are acquired from mosquitoes or ticks.

**Archimedean screw** A helix rotating in a close fitting cylinder or semicircular channel. The lower end is immersed in the liquid or grains to be raised. The *screw pump* is one type (see *Figure S.2*).

**ardenvirus** A virus that can cause respiratory illness or conjunctivitis. The most common route for transmission is person to person.

**areal extent** In hydrology, the area over which rainfall can be assumed to be applicable. For example, the area of land that contributes to the surface water in calculating water balances and flows for a landfill design.

**area method of landfilling** A common method of operating a *landfill*. The waste is deposited on the surface in layers of 2 to 3 m deep, compacted and, at the end of the day, covered with inert material or soil (see *daily cover*). The waste is often tipped into a *cell* (1).

**Arenicola** See *lugworm*.

**Arochlor** A common trade name for *polychlorinated biphenyls*.

**aromatic compounds, aromatics** Organic compounds that include one or more benzene rings. See *polycyclic aromatic hydrocarbons*.

**arroyo** A gully or ravine in an arid area that is carved by the water that occasionally flows through the gully.

**arsenic, As** Arsenic can be present in natural waters by leaching of arsenic deposits. Over one million Bangladeshis drink groundwater that contains

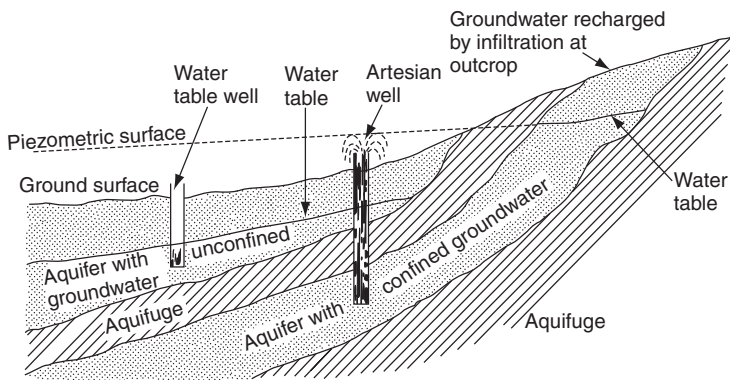

**Figure A.11** Artesian well and water table well.

arsenic. This can give rise to *arsenosis*. Arsenic removal from water can be achieved by coagulation when the soluble arsenic species are either incorporated into or adsorbed onto the hydroxide precipitate. Removal in conjunction with ferric hydroxide precipitation is successful. Other removal techniques include the adsorption onto a metal oxide in fixed bed filters or *ion exchange*. Aquatic animals, such as clams and shrimps, may accumulate arsenic from water and produce dangerous levels of arsenic for human consumption. See **Table D.2 Drinking water standards**.

**arsenosis** A disease caused by the exposure to arsenic that gives rise to skin lesions, melanosis, keratosis and a range of other symptoms.

**artesian well** A well, nowadays usually a borehole to *confined groundwater*, from which water flows without pumping because the *piezometric surface* is above ground level, implying that the water is under pressure (see **Figure A.11**). If water is withdrawn too quickly from artesian wells they may become pumped wells.

**arthropod, Arthropoda** The largest *phylum* of invertebrate animals. Arthropods have segmented bodies and jointed limbs and include centipedes, *crustaceans*, *arachnids*, etc. Some can be vectors of disease e.g. mosquitoes, ticks.

**artificial recharge** Replenishment of *groundwater* artificially through shafts, wells, pits, trenches, etc. If wastewater effluent is used for recharging, heavy bacterial growth may clog the *aquifer*. See **disposal well, spreading area**.

**artificial water body** A body of surface water created by human activity.

**asbestos** Many types of asbestos have been used for insulating steam pipes, etc. The most dangerous type to lungs is amphibole, particularly crocidolite, which is lavender blue. Amosite, chrysotile and tremolite are also a hazard. Thorough wetting of asbestos lagging reduces the amount of dust generated when it is stripped. A slurry of blue asbestos should not be allowed to dry out but should be disposed of immediately in double-sealed, thick polythene bags into a *landfill* site.

**asbestos cement pipe** Pipe made of 10 to 15% asbestos fibre, bound with cement. It is stronger than concrete pipe but more expensive. Cutting or

- drilling may produce dangerous *respirable dust*. Asbestos fibres may be found in the drinking water from these pipes if they start to corrode.
- ascariasis** An intestinal illness, especially of children, caused by nematode *Ascaris lumbricoides*. The worms' eggs (ova) are transmitted in human faeces and the illness can be acquired by consuming contaminated water. The ova may remain viable in the soil for several years. Ascariasis is common in humid climates if the population has poor sanitation facilities.
- Ascaris lumbricoides* A **nematode** round worm which is a **parasite** in humans, causing *ascariasis*. Its eggs can survive in the soil for months.
- ASCE** American Society of Civil Engineers.
- Ascoidea rubescens* A fungus that is common in the top 15 cm of **trickling filters**.
- Asellus aquaticus*, **common water louse**, **hog louse** A **crustacean** that likes moderately polluted water and may be used in a **biotic index**. It is not harmful but may harbour **viruses**.
- ASFF** Aerated submerged fixed film reactor, i.e. a **biological aerated filter**.
- aspergillosis** A disease caused by the fungus *Aspergillus*. *Aspergillus fumigatus*, *A. niger* and *A. flavus* are common causes of aspergillosis. It may cause non-infections illness, e.g. asthma, but in immuno-compromised individuals, the disease can be life-threatening.
- Aspergillus spp* Various species of this fungus commonly found in soil that may be found in wastewater treatment processes and compost.
- Aspergillus niger* A fungus that has been used as a tracer for estimating the growth of fungus in **trickling filters**. It has also been found that it can break down the pods of the carob bean to form **single cell protein**.
- asphalt planings** Asphalt taken off a tarmac road. It can be reused.
- Aspidisca* A free swimming **ciliate protozoon** that is often found in **trickling filters** and sometimes in **activated sludge**, especially if the effluent is of high quality.
- assemblage** A collection of organisms or objects, e.g. a fish assemblage is the group of fish that live in a specific water body.
- assimilative capacity** Of a receiving water, its ability to receive discharges of wastes without suffering pollution. *See self purification*.
- ASTM** American Society for Testing Materials.
- asymptomatic carrier** A carrier of a disease, who shows none of its symptoms or signs.
- atmospheric stability** *See lapse rate*.
- A2O process** The *AAO process*.
- atomic absorption spectrometer, a. a. spectrophotometer, AAS** An analytical technique widely used for measuring metal ion concentrations in water or wastes. A light source of a wavelength readily absorbed by the metal ion is directed through a flame in which the liquid sample is being atomised. The intensity of light absorbed is related to the concentration of that element in the sample. The sample may require digestion in acid to make the clear liquid sample that is required for analysis by AAS. The method is quick and generally free from interference between elements, but it requires a different light source for each element. *See flame photometry, ICP*.

**ATP** See *adenosine triphosphate*.

**atrazine** A herbicide of the triazine group, slightly more water soluble than *simazine*. It is widely used, particularly as a weed killer on land but it is not used for agriculture. It is long lasting and can migrate into the water system. The **USEPA MCL** in drinking water is 3 µg/l. The WHO guideline maximum value is 2 µg/l in drinking water. The EU Drinking Water Directive states a mandatory maximum of 0.1 µg/l. The EU lists it as a **priority substance** (under review for possible re-grading as a priority hazardous substance) in relation to aquatic discharges.

**attached growth process, a. g. reactor** A biological treatment process or reactor where the bacteria grow on a solid medium to form a **biofilm**. The biofilm adsorbs, absorbs and biodegrades the organic material in the wastewater. An attached growth process is also known as a fixed film reactor. The term **biofilter** is an attached growth process where the medium is stationary. **Trickling filters** or **rotating biological contactors** are examples of aerobic attached growth processes. Anaerobic processes may be used to treat high BOD wastewaters from industry as in the **anaerobic filter** process. See **activated biofilter, biofilter—activated sludge process, biological aerated filter, denitrification, plastic media filter, trickling filter solids contact**.

**attenuation** Artificial cooling—e.g. of flue gases.

**attenuation** The decrease in the concentration of a pollutant as the pollutant passes through soil or moves overland. The decrease may be due to chemical reactions e.g. precipitation of metals ions by reaction with components in the soil, or by biochemical activity such as the decrease in BOD or oxidation of ammonium ions to nitrate.

**auger boring** The use of an auger with a rotating cutting head to bore a tunnel in soil. The spoil is removed backwards out of the hole. The equipment may have reasonable steering ability and is then known as guided auger boring.

**auger MTBM** The use of **auger boring** together with a microtunnel boring machine (MTBM).

**autecology** The ecology of one species.

**autochthonous material** Indigenous material.

**autoclave** A laboratory autoclave is a 'pressure cooker' that reaches a pressure slightly above 1 atmosphere, at a steam temperature of 115 to 125 °C, sufficient to kill **endospores**. It sterilises apparatus or chemicals. See also **tyndallisation**.

**autogenous** Self sustaining in combustion.

**autolysis, self digestion** The disintegration of cells by the action of their own hydrolytic **enzymes**, part of the **endogenous phase of growth**.

**automatic sampler** A device that can sample either continuously or intermittently at set intervals. A **sampler** may be operated by electric battery or clockwork, or simply by immersing a hollow container in the fluid to be sampled and restricting the rate of displacement of the air from it.

**automobile emissions** The gases and solids mainly from automobile exhaust pipes but also from their petrol tanks, crankcase breathers, etc. Carbon dioxide, water and nitrogen form the vast bulk of the emissions. The emissions also contain **carbon monoxide** and oxides of nitrogen, NO<sub>x</sub>, as

well as unburnt and partly burnt hydrocarbons. Automobile emissions of all types are thought to contribute 60% or more of total *air pollutants* in western countries, *See also air to fuel ratio, lean burn engine.*

**autotroph, autotrophic organism** An organism that uses carbon dioxide as a source of the carbon it needs for building new cells. Autotrophs do not, like *heterotrophs*, need organic carbon. They can consume dissolved nitrates or ammonium salts and they include nitrifying bacteria and algae.

**autotrophy** The generation of organic matter into an aquatic system from internal sources, e.g. plant growth and decay.

**autumn turnover** *See thermal stratification.*

**available chlorine** *See chlorine residual.*

**available dilution, dilution factor** The rate of flow of a *receiving water* divided by the rate of flow of an effluent entering it.

**available residual chlorine** *See chlorine residual.*

**AWT** *Advanced wastewater treatment.*

**AWWA** *American Water Works Association.*

**axenic culture** A *culture* that is grown in the absence of foreign or unwanted organisms.

**axial flow pump, propeller p.** A rotodynamic pump which forces the water out in the same way as a ship's propeller. The passage between the blades is restricted, so this type is usually considered unsuitable for pumping water containing solids. It is most efficient for pumping large volumes of clean water or effluent against a low head.

**axial inlet cyclone** A *cyclone* in which the dirty gas is given a tangential spin by vanes at the inlet (*see Figure A.12*).

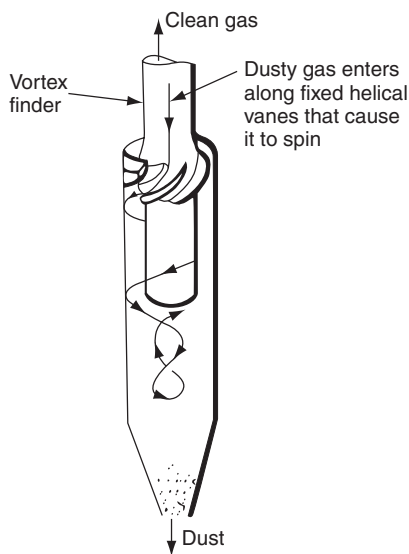

**Figure A.12** Axial inlet cyclone.

***Azolla filiculoides*, water velvet** A free floating fern which can fix atmospheric nitrogen. It can be used in ***floating aquatic plant treatment systems*** to enhance nutrient removal.

***Azotobacter*** One of the most important nitrogen fixing bacteria. It extracts nitrogen from the air and may be present in ***activated sludge***. *Compare nitrifying bacteria.*

**B2A process** A type of backwash *biological aerated filter* that uses upward flow. The sunken media are in three different sizes and layers so that *coarse to fine filtration* is achieved.

**BAC** *Biological activated carbon.*

**Bacillariophyta** *Diatoms.*

**bacillary dysentery** *Shigellosis.*

**bacillus** A rod-shaped bacterium, but *see* below.

**Bacillus** A genus of bacteria that are *facultative anaerobes*, common in *trickling filters, activated sludge* and sludge digestion. They form **endospores**. *See also* below.

**Bacillus anthracis** The bacterium that causes *anthrax*.

**Bacillus coli** An old name for *coliform group*.

**back corona** A local discharge of current in an *electrostatic precipitator* caused by the layer of fly ash.

**back drop, drop connection, d. manhole, sewer chimney, tumbling bay.** A connection from a branch drain or sewer to a much deeper sewer. The wastewater from the branch enters the *manhole* through a vertical pipe which may be inside or outside it but in any case has *access eyes* built in for *rodding* (*see Figure B.1*). Back drops prevent excessive scour and splashing in the manhole.

**back end** The chimney end of a boiler or furnace.

**backflow** The flow of water in the direction opposite to that intended e.g. back siphonage.

**backflow preventer** A *non-return valve* that prevents *back siphonage* in a water main.

**background level, b. concentration** Of a pollutant, its concentration in air or water, excluding nearby sources of that pollutant.

**back reamer** A cutting head attached to the drill that then enlarges the bore when the cutting head is pulled back.

**back siphonage, back suction** Reversed flow in a water main caused by suction of water from a sink, bath, etc., into the main. Back siphonage can be prevented by ensuring that the lowest outlet from any tap is above the highest point that the dirty water can reach. Otherwise, if a tap submerged in dirty water is open while other taps below it are also open, the dirty water could be sucked into it. One defence against back siphonage is by *air gap protection*. Water sucked back into mains can be caused by pressure drop in mains supply e.g. fire pumping or mains leakage.

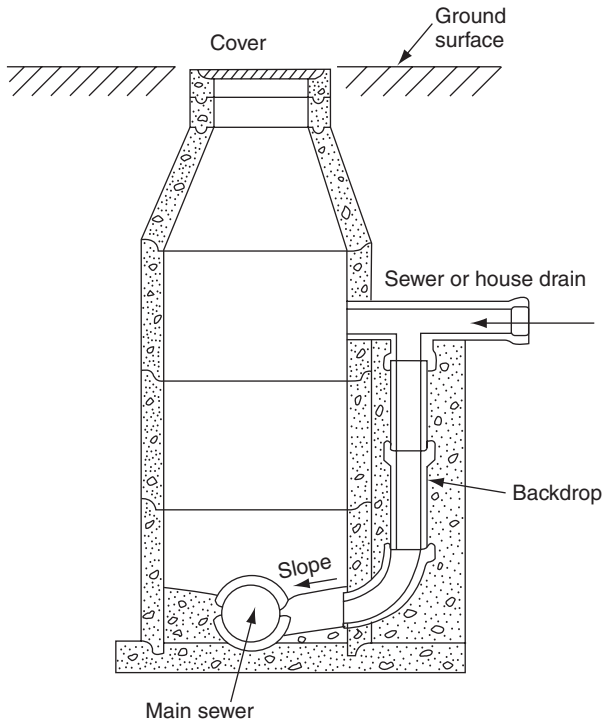

**Figure B.1** Manhole with backdrop.

**backwash BAF** See *biological aerated filter*.

**backwashing** (1) *Rapid deep bed filters* are equipped with underdrains that collect water in a downflow filter or distribute water in an upflow filter. When the filter becomes excessively clogged with solid material, the filter bed needs washing. Treated water flows from the underdrains up through the bed and the backwash water is run to waste (see *Figure R.2*). The rate of backwash water normally expands the bed by 20 to 40%. In a waterworks, the rapid deep bed filters may be backwashed for 10 to 20 minutes once per day. The backwash may be preceded by *air scouring*. The quantity of backwash water should be minimised as this is a loss of treated water. Some *biological aerated filters* are operated with a backwash to remove excess *biofilm* from the filter. (2) Separating a mixed bed of *ion exchange resins* into its components to prepare it for *regeneration*.

**backwater curve** The curve of the water surface in a river or open channel, held up behind a dam, weir or other obstruction to the flow. See *Figure B.2*.

**bacteria** (singular *bacterium*) Single celled microscopic organisms that multiply by splitting in two (binary fission). In order to multiply they need carbon, obtained from carbon dioxide if they are *autotrophs*, or from



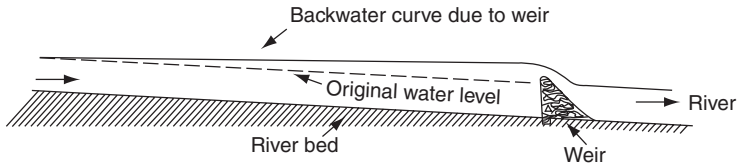

**Figure B.2** Backwater curve from introducing a weir into a river.

organic compounds if they are *heterotrophs*. Their energy comes either from sunlight if they use *photosynthesis* or from chemical reactions if they use *chemosynthesis*. They occur in air, water, earth, rotting vegetation and the intestines of animals, and are fundamental to the biological treatment of wastewater or sludge, and in the self purification of rivers and lakes. Some bacteria cause illness in man.

Bacteria average about 1  $\mu\text{m}$  long but vary typically from 0.5 to 10  $\mu\text{m}$  and are classified by shape mainly into the following five groups: bacilli (singular bacillus), resembling rods; cocci (singular coccus), resembling spheres; spirilla (singular spirillum), resembling curved or spiral bacilli; spirochaetes, which are filament shaped, spiral and flexible, some of which are responsible for *leptospirosis*; and *Vibrio*, which are curved. Bacteria under ideal conditions may divide every 20 minutes, but they take up food so quickly that they are likely soon to be limited by shortages of food or oxygen or water. In domestic wastewater there are about 10 million bacteria per ml, 100 per ml in spring water or 10 000 per ml in a polluted river. Bacteria may be *aerobic* or *anaerobic*. They may be *obligate aerobes*, *obligate anaerobes*, *facultative anaerobes*, etc. (see Figure B.3.) See *microbial growth curve*.

**bacteria bed** A *trickling filter*.

**bacteria corrosion** See *iron bacteria*, *sulphide corrosion*, *Thiobacillus*, *tuberculation*.

**bacteria count** See *bacteriological examination*.

**bacterial dysentery** *Shigellosis*.

**bacterial growth curves** See *microbial growth curve*.

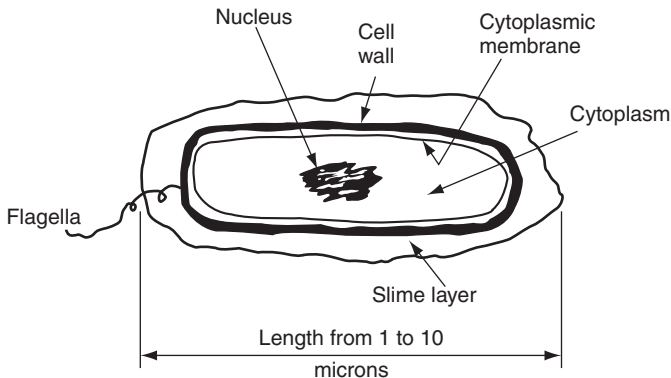

**Figure B.3** Bacterial cell.

- bacteria tracer** Any distinctive bacteria used to monitor water movements.  
*See tracer.*
- bactericide** Something that kills bacteria.
- bacteriological examination** Drinking and other waters are examined for their content of bacteria by the *membrane filtration* method, *most probable number (MPN)* and *plate counts*. *See coliform group.*
- bacteriology** The study of bacteria.
- bacteriophage, phage** Any virus that attacks bacteria.
- bacteriostatic** Description of a substance that prevents bacterial growth but does not kill bacteria.
- bacterium** Singular of bacteria.
- Bacterium dysenteriae*** *Shigella dysenteriae*, *see shigellosis.*
- Bacterium tularensis*** One of the bacteria that cause *tularaemia.*
- Bacteroides Obligate anaerobe*** bacteria that can form sulphides from protein in *anaerobic digestion.*
- Baetis rhodani*** A stone dwelling *mayfly* which favours mildly polluted rivers. Most mayfly dislike pollution.
- BAF** A *biological aerated filter.*
- baffle** A board in a conduit for gas or liquid, which diverts or reduces flow, prevents eddying, etc.
- baffle channel flocculator** A tank in which baffles are placed so that the water and chemicals are flocculated. The flow in the channel should be between 0.2 and 0.7 m/sec.
- baffle side weir** A weir alongside a sewer, over which the wastewater is encouraged to flow by a *baffle* across the main sewer. The baffle can be a vertical, square plate having its bottom edge level with the crest of the side weir, so that the flow over the weir increases as the wastewater level rises in the main sewer.
- baffle type scrubber** A type of *wet scrubber* that is a *gravity settling chamber* with baffles that varies the direction of flow (*see Figure G.1*) plus sprays within the chamber to assist in removing the particulates or to scrub out unwanted gaseous pollutants.
- bag cleaning** Filter bags in *fabric filters* must be cleaned regularly to reduce the gas pressure needed when they are dirty. The extra power consumed when bags are dirty is expensive; so is a bag burst because of excess pressure. Many methods exist, including mechanical shakers for shaking the dust off the bags (shake-deflate baghouse) or pulses of compressed air in the opposite direction from the general flow, (pulse jet baghouse). Bags through which the flow is normally outwards can be cleaned by collapsing them in momentary reversals of flow.
- bag filter** A *fabric filter.*
- baghouse** The steel gas tight housing around the *fabric filter.* It contains tubular bags that filter flue gas, air or other dusty gas, either to remove pollutants or to recover dust. *See Figure F.1, bag cleaning.*
- balanced draught** In a furnace, a condition of the gas pressure within it such that the furnace, flues and chimney are under slight suction and any leakage is inwards. *Compare forced draught fan, induced draught fan.*

**balancing reservoir** A reservoir into which there may be a variable delivery and from which the flow is steady. It provides steady working conditions for the *filters* and other plant downstream of it.

**balancing tank, equalisation (or equalization) basin, e. tank** A tank or basin designed to reduce and even out the variations in the flow or chemical characteristics prior to the wastewater treatment plant. The tank may store the wastewater at high flows and release at low flows. Alternatively the tanks may be used in industry to balance out the variations in the nature of the wastewater that emanates from differing activities. This may occur prior to onsite treatment or discharge to a sewer. Many water and wastewater treatment processes operate most efficiently at a relatively constant flow. Flow balancing can be particularly important in treating wastewaters from small communities which can generate erratic flows. *See package wastewater treatment plants.*

**Balantidium coli** A pathogenic protozoa that can cause balantidiosis (balantidiasis or balantidial dysentery) in humans. It is found in wastewater and a common route of transmission is *faecal-oral*.

**bale breaker** A *hammer mill* that opens bales.

**balefill** The operation of a *landfill* site by stacking bales of refuse. This is sometimes considered an easier option compared to loose tipping of the refuse at the landfill followed by on site compaction by a *steel wheeled compactor*.

**baling** Reducing the volume and increasing the density by compacting refuse into wired or strapped blocks with a hydraulic press. This makes the refuse easier to handle and stacked at the *landfill* (*see balefill*). The baling plant is located at a *transfer station*. The density of the bale is about 1 tonne per m<sup>3</sup> and the bales require some wire strapping in order for the bail to maintain its shape after leaving the press. High density baling can produce bales with greater than 1 tonne per m<sup>3</sup> and these bales may require no strapping after leaving the press.

**ballistic separator** (1) A type of *inertial separator* that makes use of the differences in fall velocity and fall path of materials (e.g. paper and metal) when they are thrown and fall freely. (2) A means of extracting from a *hammer mill* any objects that it cannot break. They are driven round by the hammers until they reach an opening and a chute intended for them.

**ball valve** (1) or **globe valve** A valve containing a bored ball that can be rotated to stop the flow through a pipe. (2) **ball float valve** A floating ball attached to a valve. As the ball reaches a certain level the arm pushes the valve to shut off the flow.

**BANANA** Build Absolutely Nothing Anywhere Near Anyone; a phrase that indicates the increasing difficulty in siting wastewater treatment works or landfill sites or incinerators near human habitation. *See NIMBY.*

**Bancroft disease** *See filariasis.*

**band dryer** A *dryer* which dries sludge cake by hot air after pulverisation. It contains several horizontal conveyor belts of wire mesh above one another, with the sludge falling from the end of one to the beginning of the next, until it is removed by a screw conveyor at the foot.

**band screen** A *belt screen*.

**Banks filter** A *pebble bed clarifier*.

**bankside storage** *Raw water storage* in a reservoir on the river bank. River water may have several days of bankside storage before treatment. This allows solids to settle and some bactericidal action from ultraviolet radiation. The river intake can be closed to allow unusual river pollution to pass downstream.

**bank storage** The ability of water to flow into the bank of a river at high water and to return to the river at low water, acting as groundwater in the interval. Gravelly or other porous soils have greater bank storage than clays, silts or impervious soils.

**BaP** *Benzo(a)pyrene*.

**Bardenpho process** An adaptation of the *activated sludge* process that can achieve *nitrification* and *denitrification* in a four stage process (see *Figure B.4a*). In the process the second stage is the main zone for BOD removal and nitrification. The recycle from the end of the second zone back to the inlet of the first zone results in the nitrate being mixed with the wastewater in the *anoxic* zone. The nitrate is denitrified to nitrogen gas. Although most of the nitrate formed in the second zone is recycled to the first zone, some of the nitrate may miss this recycle and pass to the third zone which is also anoxic allowing denitrification. The fourth zone is aerobic in order to freshen the sludge prior to flowing into the sedimentation tank. The five stage Bardenpho process incorporates an extra zone at the beginning of the process (see *Figure B.4b*). This zone is anaerobic and allows *biological phosphorus removal*. The percent removal can be in excess of 95% for nitrogen and 90% for phosphates. A three stage Bardenpho process is synonymous with the *AAO process*.

**barium** A chemical that can increase blood pressure. See *Table D.2 Drinking water standards*.

**barometric damper** A *draught stabiliser*.

**bar rack** See *bar screen*.

**Barr and HR Wallingford tables** See *Wallingford tables*.

**bar screen, b. rack** A *screen* (see *Figure S.1*) that uses parallel bars to give coarse or fine screening to a water or wastewater. The bars may be horizontal, vertical or at a slope. They are often cleaned mechanically but hand raking may be used. The term bar rack usually means a coarse screen with the gaps between the bars up to 40 mm. The bars are typically about 20 mm in diameter. The term bar screen may infer a medium screen, with the gaps more typically in the 15 to 25 mm range

**base exchange** *Cation exchange*.

**base flow** In a stream, the part of the *runoff* that comes from the *groundwater*, long-term lake storage, etc.

**basin lag** See *time lag of a catchment*.

**basket bowl centrifuge** See *imperforate basket centrifuge*.

**BAT Best Available Techniques** The use of BAT is a requirement of the EU Directive on *Integrated Pollution Prevention and Control* of 1996. The Directive states that 'best available techniques' shall mean the most effective

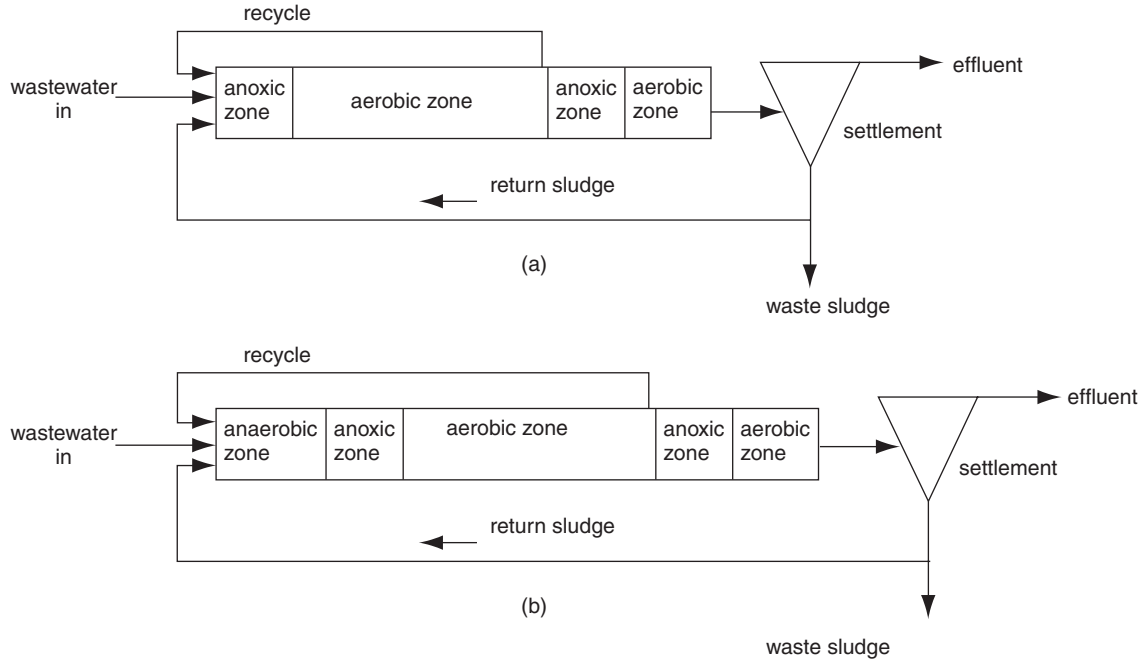

**Figure B.4** Bardenpho process, flow diagram (a) four stage process; (b) five stage process.

and advanced stage in the development of activities and their methods of operation which indicate the practical suitability of particular techniques for providing in principle the basis for emission limit values designed to prevent and, where that is not practicable, generally to reduce emissions and the impact on the environment as a whole: 'best' shall mean most effective in achieving a high general level of protection of the environment as a whole.

(1) 'available' techniques shall mean those developed on a scale which allows implementation in the relevant industrial sector, under economically and technically viable conditions, taking into consideration the costs and advantages, whether or not the techniques are used or produced inside the Member State in question, as long as they are reasonably accessible to the operator,

(2) 'techniques' shall include both the technology used and the way in which the installation is designed, built, maintained, operated and decommissioned.

**batch reactor** A reactor used for *batch treatment*. See *sequencing batch reactor*.

**batch treatment** Any treatment in which the process is completed and the products are discharged before more raw material can be taken in.

**BATEA** Best Available Technology Economically Achievable. A USA term for the treatment of a waste stream, whether gaseous, liquid or solid, that does not involve excessive cost applied to waste producer.

**Bathing Water Directive 1976** The EU Directive that set the acceptable standard for a range of physical, chemical and microbiological quality parameters for inland and coastal bathing areas in EU countries.

**bathythermograph** An instrument that measures ocean temperature at depth.

**BATNEEC Best Available Techniques Not Entailing Excessive Cost** In England and Wales this approach is used to minimise releases from processes prescribed for *Integrated Pollution Control*. The overall objective is to prevent, minimise or render harmless polluting releases. Examination of techniques embrace both the plant in which the process is carried on and the operation of the process itself and cover matters such as numbers and qualifications of staff as well as working methods, training and supervision. BATNEEC will be superseded by *BAT* as existing processes and new installations are permitted under the *IPPC* regime.

**Bayer tower** A type of *tower reactor* (1).

**BBP** Butyl benzyl phthalate. See *phthalates*.

**BCT** Best Conventional Treatment, a term that can be applied to the treatment of wastes, whether gaseous, liquid or solid.

***Bdellovibrio bacteriovirus*** A bacterium that can destroy other bacteria.

**beamhouse wastewater** In a tannery for cattle hides, the beamhouse work includes curing (drying the skin), fleshing (removal of fat), washing, de-hairing, bating (raising the pH by adding ammonium salts), pickling and de-greasing. The skins then are tanned and the wastes are combined with *tannery wastewater*. See *fellmongering*.

**beaver fever *Giardiasis***. The beaver is a carrier of *Giardia* cysts and drinking water contaminated with the cyst may give the disease.

**becquerel, Bq** The SI unit of radioactivity. It is equal to one disintegration per second. One *curie* equals  $3.7 \times 10^{10}$  Bq.

**bedding** Sand or other material on which a pipe, landfill liner, etc. is placed so that the pipe or liner is located firmly on a material that does not damage the pipe or liner.

**bed load** The weight or volume of silt, sand and gravel that rolls or slides or bounces (*saltation*) along a stream bed. *Compare sediment load.*

**beet sugar wastewater** Some 70% of the water used in extracting sugar from beets is spent in washing them. Wastewater is also produced in dewatering the pulped beets and in lime slurry residues and condensate from evaporators. Typical mixed wastewaters have 400 to 500 mg/l of BOD<sub>5</sub>, up to 5000 mg/l of suspended solids, 250 mg/l of alkalinity and a pH of 8.0.

**Beggiatoa** A *filamentous organism*, a sulphur oxidising bacterium. It can grow as *heterotroph* or *autotroph* but cannot be purely autotrophic, because it can be cultured only if organics are present. Hydrogen sulphide, H<sub>2</sub>S, stimulates its growth and the H<sub>2</sub>S is oxidised to sulphur, but it can be grown in the absence of sulphides.

**bellmouth chamber** A chamber at a junction between two or more large sewers, in which the side of the outgoing sewer forms a tangent to the incoming sewers.

**belt filter press, belt p., filter belt p.** A method for the *mechanical dewatering of sludge*. Conditioned sludge is placed onto a belt (typically 2 m wide) to allow drainage of liquid from the sludge. This belt then meets a second belt. The two belts with the sludge sandwiched between them pass round a series of rollers to introduce increasing shear and compressive forces on the sludge (*see Figure B.5*). Wastewater sludge can be dewatered to 20 to 35% solids. It is a continuous process unlike the *filter plate press*.

**belt screen** In water and wastewater treatment, a *screen* that is a sloping conveyor belt with holes in the belt to allow the water to flow through. Some solids are caught on the belt and drop off into a container at the top of the belt. The holes are often about 6 mm wide and 20 mm or more in length.

**belt thickening** *See gravity belt thickening.*

**belt vacuum filter** *See vacuum filter.*

**benching** The concrete or brick surround to a sewer channel in a *manhole*, etc. The benching slopes uniformly upwards away from the channel at a slope of about one horizontal in six vertical.

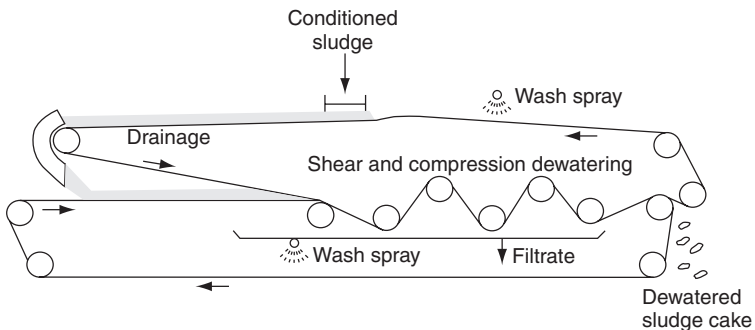

**Figure B.5** Belt filter press.

**benchmarking** This is a comparison and evaluation tool that is used in the water and wastewater industry in different countries. The cost and performance data for the specific water or wastewater utility are established. The data collected depends on the utility but may consist of water consumption, metering practices, water distribution and sewerage performance, water and wastewater treatment efficiency, staffing, customer relations etc. Targets based on best practices are established for a range of organisation specific parameters that are deemed to be appropriate for improving the competitiveness, performance, and efficiency of the utility. The trends are monitored together with the achievement of targets.

**beneficial re-use** The re-use of treated wastewater effluent or wastewater sludge for the benefit of the local inhabitants.

**benthic deposits** *Bottom sediments* that originate from dead or decaying organic material.

**benthic zone** The zone in which the benthic deposits accumulate.

**bethos, bethon** The community of plants and animals living on the bed of a sea, stream, lake, pond, etc. Many insects or other benthic life are biological indicators, since the bed collects the sediments from the water.

*Compare nekton, neuston, plankton.*

**bentonite** A clay material, mainly montmorillonite clay, that is used to reduce the permeability of soil or rock. *See slurry walls.*

**benzene, C<sub>6</sub>H<sub>6</sub>** An organic chemical that is a ring structure of 6 carbon atoms each with one hydrogen atom. Chemicals that contain one or more benzene rings are known as aromatic. Benzene is carcinogenic to humans. The *USEPA MCL* for benzene in drinking water is 5 µg/l. The WHO guideline maximum value is 10 µg/l in drinking water. The EU Drinking Water Directive states a mandatory maximum of 1 µg/l. The EU lists it as a *priority substance* in relation to aquatic discharges. For the ambient outside air, EU legislation proposes a limit of less than 10 µg/m<sup>3</sup>, averaged over a year. *See polycyclic aromatic hydrocarbons.*

**benzene hexachloride, BHC** *Hexachlorocyclohexane.*

**benzo(a)pyrene, benz(a)pyrene, B(a)P** This chemical is often considered as the most dangerous to human health of the compounds known as *polycyclic aromatic hydrocarbons* (see *Figure P.10*). B(a)P is strongly carcinogenic. It is found in tobacco smoke. The *USEPA MCL* for B(a)P in drinking water is 0.2 µg/l. The EU Drinking Water Directive states a mandatory maximum of 0.01 µg/l. The WHO guideline maximum value is 0.7 µg/l for drinking water. The EU lists it as a *priority hazardous substance* in relation to aquatic discharges.

**benzo(b)fluoranthene, benz(b)fluoranthene, benzo(b)fluoroanthene** *See polycyclic aromatic hydrocarbons.*

**benzo(ghi)perylene, benz(ghi)perylene** *See polycyclic aromatic hydrocarbons.*

**benzo(k)fluoranthene, benz(k)fluoranthene, benzo(k)fluoroanthene** *See polycyclic aromatic hydrocarbons.*

**Berkfield filter** A domestic drinking water filter consisting of a metal cylinder containing compressed *diatomite* through which the water flows. It can be cleaned by *backwashing*.



**beryllium, Be** Beryllium compounds are rare in water but highly toxic to humans. See *Table D.2 Drinking water standards*.

**best management practices, BMPs** Originally an agricultural term used to describe the best methods for reducing erosion from farmland and improve crop yield. The term is now also used to describe the best methods for reducing and controlling pollution in runoff from both rural and urban areas. Non-structural BMPs reduce the contact between the rainfall and pollutants by good management practices (e.g. effective street cleaning). Structural BMPs involve the construction of facilities to achieve urban drainage management. See *urban pollution management*.

**Best Practicable Environmental Option, BPEO** The outcome of a systematic and decision-making procedure which emphasises the protection and conservation of the environment across land, air and water. The BPEO procedure establishes, for a given set of objectives, the option that provides the most benefit or least damage to the environment as a whole, at acceptable cost, in the long term as well as the short term.

**beta activity** In 1962–63 the total beta radiation in UK rivers and lakes was often around 20 picocuries per litre but, with the lower frequency of nuclear explosions, this has now diminished to about one-tenth (1 or 2 pCi/l). The *USEPA MCL* in drinking water is 4 millirem/year for beta particles and photons.

**beta factor** The ratio of the *air saturation value* in an *activated sludge* to that in pure water at the same temperature and pressure.

**beta particle** A particle emitted during *radioactivity*, which may be positive (positron) or negative (electron).

**BHA** *Butylated hydroxyanisole*.

**BHC** Benzene hexachloride, i.e. *hexachlorocyclohexane*.

**BHT** *Butylated hydroxytoluene*.

**bicarbonate process** *Carbonate hardness*.

**biflow filter** A *sand filter* with upward flow in the lower half of the bed and downward flow in the upper half. The outlet pipes are in the middle of the sand bed and raw water is fed to the top and bottom of the filter. It is an attempt to obtain the advantages of an upflow filter while using the downflow to restrain the lower half of the bed. The backwashing is upward flow through the whole bed. See *reverse current filter*.

**bifurcate** To split into two.

**big gun sprinkler** A *rain gun*

**bilharzia, bilharziasis** *Schistosomiasis*.

**billion** One thousand million,  $10^9$  (although in Europe, formerly  $10^{12}$ , one million million). One trillion =  $10^{12}$ .

**bimodal size distribution** A *particle size distribution* in which most of the grains are concentrated around two sizes.

**binary fission** Dividing in two—the reproductive method of many bacteria. It exists also in *radioactivity*.

**binary sorter** In a *mechanical sorting plant*, the usual device that divides the material into two parts, one with and one without the constituent being sorted.

- bioaccumulation** All living organisms accumulate food, nutrients and trace elements that are required for their existence. However, accumulation of unwanted toxic pollutants can also occur in the living organism.
- bioassay** A trial of a chemical or a pollutant, made by testing how much of it can be tolerated by a living organism. *See LC50.*
- bioassessment** The assessment of the quality of a river, lake, etc. by studying the range of aquatic plants and animals that are resident. *See biotic index.*
- bioaugmentation** The addition of bacterial or other microbial cultures to biological treatment processes in order to improve the performance of the process.
- bioavailability** The extent to which a chemical is available to be taken up by an organism.
- Biocarbone** A type of backwash *biological aerated filter* that uses downward flow. The submerged media is expanded shale of 2 to 6 mm in size, depending on the application.
- biocenose** *See biocoenosis.*
- biochemical** Description of the chemical reactions of life, including growth etc.
- biochemical oxidation, biological o.** The oxidation of a chemical by microbial processes. Numerous examples exist including bacterial oxidation of organics, sulphur oxidising bacteria or bacteria that oxidise ferrous iron salts to ferric iron salts, *nitrification* of ammonia to nitrate etc. *See aerobic biological oxidation, anaerobic oxidation, anoxic.*
- biochemical oxygen demand** *See BOD.*
- biochemistry** The chemistry of living beings.
- biocide** A chemical or other agent that kills living organisms, although the term may be used to mean a *pesticide*.
- biocoenosis, biocenose** The community present in a *biotope*. Thus, the water biocoenosis means all the water life.
- bioconcentration** A term that normally means *bioaccumulation* but may be used to mean *biomagnification*.
- bioconversion** The conversion of waste by biochemical activity.
- biocriteria** The criteria in terms of the resident plant and animal life, that defines a particular community in a particular environment, e.g. the plants and animals living in a clean unpolluted river. The criteria may be narrative (narrative biocriteria) or numeric as in a *biotic index*.
- biodegradable** Description of something that breaks down, decomposes, by biochemical changes often involving bacteria. This is usually taken to be desirable in a waste product, but some decomposition products may be dangerous. *Compare non-biodegradable.*
- biodenitrification** *Denitrification.*
- Biodisc** Trade name of a *rotating biological contactor*. With primary and secondary settlement zones, it is a *packaged wastewater treatment plant* suitable for communities of 50 to 1000 people. The discs are about 3 m diameter.
- biodiversity** The range of different organisms plants and animals that exist in a specific locality. *See diversity index.*
- biofilm** A film or slime that can grow on a solid which is in contact with organic rich water. The slime contains a variety of microbes together with

their metabolic products such as polysaccharides. See *attached growth process*.

**biofilter** (1) A type of *attached growth process* for biological treatment of a wastewater. The bacteria grow on a stationary solid medium to form a *biofilm*. *Trickling filters* are an example of aerobic biofilters. Anaerobic processes may be used to treat high BOD wastewaters from industry as in the *anaerobic filter* process. Other examples include *denitrifying filter* and *nitrifying filter*. See *activated biofilter*, *biofilter—activated sludge process*, *biological aerated filter*, *plastic media filter*, *trickling filter solids contact process*. (2) A *bioscrubber*. (3) In air pollution, beds of peat or other organic material can be used to remove or control odour by passing the malodorous air up through beds. The adsorbing material may have to be kept moist using a sprinkler system.

**biofilter—activated sludge process** An aerobic biological treatment system that consists of an aerobic *biofilter* (1) followed by an *activated sludge* process (i.e. an aeration tank and a sedimentation tank). The sludge recycle from the sedimentation tank is returned either to the aeration tank or biofilter. See *activated biofilter*, *trickling filter solids contact process*.

**biofiltration** The adsorption and subsequent oxidation of a pollutant from air or wastewater by a *biofilm*.

**Biofix process** See *suspended immobilised biomass reactors*.

**bioflocculation** Flocculation of a microbial suspension containing bacteria or algae, etc.—e.g. flocculation of *activated sludge* in a secondary sedimentation tank.

**Biofor** A type of backwash *biological aerated filter* that uses upward flow. The process uses a submerged plastic medium.

**biofouling** The growth of unwanted *biofilms* on surfaces.

**biogas** Gas from biochemical activity, such as methane and carbon monoxide from *anaerobic digestion* or *landfill* etc.

**biogenic** Produced by biological processes.

**biological activated carbon** (1) *Granular activated carbon* on which microbes grow. The microbes enhance the treatment of the water or wastewater. See *carbon adsorption bed*. (2) A combination of *ozonation* and granular activated carbon used to remove dissolved organic material from water.

**biological aerated filter, BAF** An aerobic biological wastewater treatment system which is an *attached growth process*, i.e. it contains a *biofilm* attached to a solid medium. The medium is submerged in the wastewater and diffused air is bubbled into the base of the reactor to maintain an aerobic microbial process. Some micro-organisms are suspended in the liquid in the reactor and so, in part, it is also a *suspended growth process*. The medium may be high voidage plastic medium or expanded polystyrene beads or expanded shale particles or sand. The medium may be fixed or mobile (see *Figures B.6a and 6b*) using upwards or downwards flow. The depth of medium may be 2 to 3 m, but up to 6 m depths have been used. BAF plants can operate at high BOD loads (e.g. 4 to 7 kg BOD/d per m<sup>3</sup> of tank) and regular *backwashing* of the BAF reactor is required to remove excess biofilm. The high organic loadings for a backwash BAF

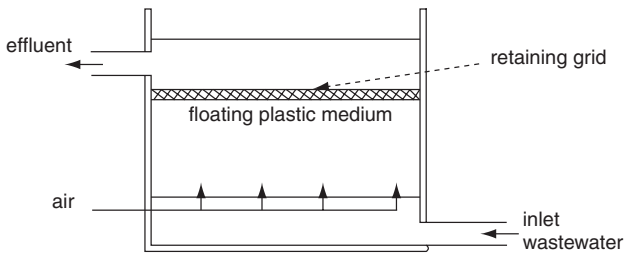

(a) floating bed, upward flow  
during the backwash cycle, effluent is passed up through the bed and the outlet at the top is diverted to the waste sludge stream.

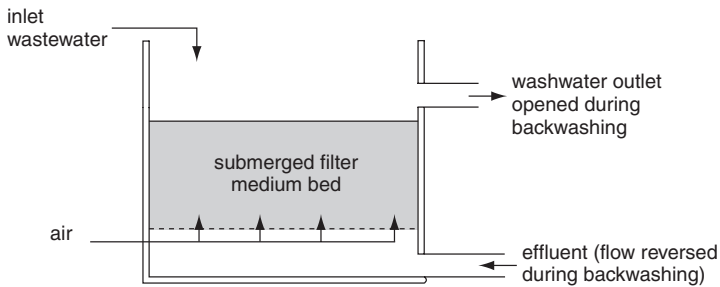

(b) submerged fixed bed, downflow  
during the backwash cycle, effluent is passed up through the bed and the wastewater is diverted to the waste sludge stream.

**Figure B.6** Two configurations of backwash biological aerated filters.

reactor results in smaller treatment systems compared to *activated sludge* plants. The main disadvantage of backwash BAF reactors is the complex operation of backwashing, which must be carefully controlled to retain and maintain a healthy biomass. One method of backwashing is to stop the inflow of wastewater and then increase the airflow by two or three times to achieve *air scouring*. The backwash effluent that passes through the reactor removes the loosened biofilm. The reactor is then returned into operation. Backwash BAF systems do not require a sedimentation tank after the BAF reactor. Backwashing may be required once a day for BAF systems designed to treat high organic loading. BAF systems designed for *nitrification* or for *tertiary treatment* may only require backwashing once a month. BAF systems have various trade names such as *B2A*, *Biostyr*, *Biocarbone*, *Biofor*. Non-backwash BAF systems are often termed submerged aerated filters (SAF). The BOD loading for a SAF system is about 0.4 kg BOD/d per m<sup>3</sup> of aeration tank. In a SAF system the biomass in the reactor is controlled by air scouring of the plastic medium. The biofilm

that sloughs off the medium is then settled in a sedimentation tank. This eliminates the need (and cost) of backwashing. This can give a simple treatment process and is suitable for small treatment works.

**biological amplification** *Biomagnification*.

**biological denitrification** *See denitrification, nitrification—denitrification*.

**biological film** A *biofilm*.

**biological filter** A *biofilter* (1).

**biological fluidised bed** A biological treatment process in which a fine medium of about 0.3 to 0.5 mm diameter, (such as sand) moves up through the tank with the water or wastewater. A *biomass* grows in the reactor including a *biofilm* on the sand. The sand is removed from near the top of the reactor. The sand, which may be cleaned in a sand washer, is replaced into the base of the reactor. The effluent flows from the top of the reactor. If a substantial quantity of biomass flows out with the effluent, the effluent flows to a settling tank and the sand and sludge from the tank are recycled to the reactor (*see Figure B.7*). In wastewater treatment, for BOD removal and *nitrification*, aerobic conditions have to be maintained by bubbling in air or oxygen into the reactor. If used for *denitrification*, aeration is not present. For nitrate removal from a drinking water, a carbon source (e.g. methanol) and phosphoric acid may be dosed into the inlet so that the bacteria have the appropriate nutrients for growth. Small plastic media may be used instead of sand in the biological fluidised bed. *Biological aerated filter* systems that use a mobile medium can also be considered to be a biological fluidised bed process. *See expanded bed anaerobic process*.

**biological hydrolysis** *See enzymatic hydrolysis*.

**biological indicator (or index) of pollution** A *biotic index*.

**biological iron and manganese removal** The use of bacteria that oxidise iron or manganese and thereby produce a precipitate of iron or manganese compounds. The bacteria can be grown in a *packed bed filter* using sand or plastic

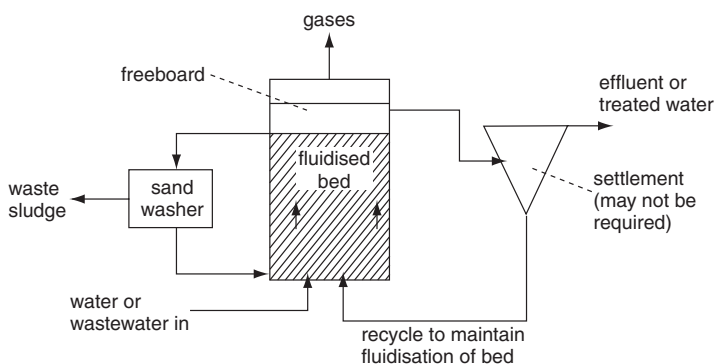

**Figure B.7** Biological fluidised bed, flow diagram. Air may also be injected into the bottom of the reactor if aerobic biological oxidation is required. Various chemicals may have to be added at the inlet to ensure successful growth of the bacteria.

- media. The filter must be kept aerobic in order for the appropriate bacteria to grow. The process has been used to remove iron and manganese from water.
- biological monitoring** Repeatedly surveying plants and animals at a site to determine their abundance, at least roughly, and noting the physical, chemical and biological changes with time, as in a *transect*.
- biological nitrification, b. nitrate removal** See *nitrification, nitrification—denitrification*.
- biological nutrient removal** See *biological phosphorus removal, denitrification, nitrification—denitrification*.
- biological odour control** Malodorous air can be passed through shallow beds of moist soil or compost or peat (see *peat bed filter* (2)). The micro-organisms are able to oxidise some or all of the compounds causing the odours. Soil depths of 3 m can remove hydrogen sulphide concentrations of up to 20 mg/l from an airflow rate of 0.6 m<sup>3</sup> per m<sup>2</sup> of bed surface per minute. See *bioscrubber*.
- biological oxidation** *Biochemical oxidation*.
- biological phosphorus removal, BPR** Removal of phosphates from the wastewater by incorporation into *activated sludge*. Normally up to 30% of the phosphates in the influent can be removed in a conventional aerobic biological treatment process due to the normal requirements for growth of the micro-organisms. This phosphorus removal can be substantially increased by utilising certain bacteria, such as *Acinetobacter*, that are able to accumulate 6% or more of phosphorus by dry weight in the sludge (enhanced BPR or luxury uptake of phosphorus). This is far in excess of their requirements for growth. In order for this to occur the micro-organisms must be exposed to anaerobic and aerobic conditions. A range of other factors influence the process, such as nitrate: BOD ratio; P: BOD ratio; concentration of *volatile fatty acids*. The *Bardenpho process, AAO process, UCT process* or *VIP process* are examples of the utilisation of biological phosphorus removal and can achieve effluent standards less than 1 mg/l of P from the domestic wastewater. Phosphate may be released from the waste biological sludge during storage or treatment of the sludge See *PhoStrip process*.
- biological slime** A *biofilm*.
- biological stabilisation of sludge** Wastewater *sludge stabilisation* by use of micro-organisms to biodegrade the organics in the sludge. The most biological common is *anaerobic sludge digestion*, but *aerobic digestion*, such as *composting*, may also be used.
- biological treatment** Any treatment process that uses micro-organisms to remove the unwanted organic or inorganic compounds. See *aerobic biological treatment, anaerobic treatment, anoxic*.
- biological treatment of contamination land** Normally *bioremediation* or possibly *phytoremediation*.
- biomagnification** Multiplication of the concentration of a chemical, possibly toxic, as it moves up the food chain, eventually to the larger predators. Non-biodegradable pesticides may remain in natural waters for a long time and be taken up by bacteria, algae, etc. Fish may eat the contaminated plankton and then birds or humans eat the fish. The concentration

of the toxic chemical in the fish may be many times greater than the concentration in the water.

**biomass** The mass of a biological population, usually expressed in terms of dry weight. The term is used to describe the mass of biological solids growing in a wastewater treatment process.

**biomass reactor** See *suspended growth process*.

**biomass separator** A *sedimentation tank* that follows after biological treatment of a wastewater and is used to settle out the *biomass* that has formed in the biological reactor from the treated effluent. In a traditional treatment plant for domestic wastewater, the separator is known as *secondary sedimentation tanks*. See *activated sludge settling tank, humus tank*.

**biomat** A thick slime that can grow on a solid (e.g. a soil) which is in contact with organic rich water. The mat contains a variety of microbes together with their metabolic products such as polysaccharides.

**biomethanisation** Methane gas production from biochemical activity, such as *anaerobic digestion* or *landfill* etc.

**bio-oils** Oils that are produced from heat treatment of organic waste, such as in *pyrolysis*.

**biooxidation** *Biological treatment*.

**biooxidisable** *Biodegradable*.

**biopiles** See *soil heaping*.

**bioproducts** In wastewater and waste treatment, useable products from the treatment of the waste, such as compost.

**bioreactive waste** Wastes that are biodegradable.

**bioreactor** Any tank or vessel in which wastes are treated by use of micro-organisms.

**bioremediation** The use of bacteria or other micro-organisms to degrade organic pollutants. The term is mainly used in association in the remediation of contamination land. The soil may be treated *in situ* or it may be extracted and treated in a bioreactor as a slurry (slurry phase treatment) or as a soil (solid phase treatment e.g. *composting, landfarming, soil heaping*). Whether *in situ* or *ex situ*, the treatment may require the addition of appropriate micro-organisms and chemicals to ensure appropriate levels of nutrients, correct pH etc. Plants can be used in bioremediation which is known as *phytoremediation*. See *bioventing*.

**bioretention** For stormwater, the use of vegetated soil to slow down runoff and thereby maximise infiltration. The vegetation removes some pollutants from the runoff.

**bioretention area** A *detention basin* designed for *bioretention*.

**bioscrubber** A method of *biological odour control* in which the malodorous air is passed up through a filter containing plastic media in a conjunction with a downflow of liquid effluent. The *biofilm* grows on the solid media. The biofilm adsorbs and oxidises some gaseous pollutants (e.g. *VOCs*) as the contaminated air passes through the scrubber. The effluent supplies the nutrients for microbial growth. It is also known as a biofilter. It has been successfully used for hydrogen sulphide removal.

**bioslurry reactor** See *slurry phase treatment*.

- biosolids** The biological solids growing in or wasted from a wastewater treatment process. The term often means the sludge separated from the wastewater. The term may mean the beneficial use of *wastewater sludge*.
- biosolids treatment** *Wastewater sludge treatment*.
- biosorption** The adsorption of a substance onto a *biofilm* or into an *activated sludge* etc.
- biosparging** A technique for treating contaminated land where air is forced into the ground, below the water table via wells placed into saturated soil. The objective is to encourage biodegradation of the contaminants in the soil and groundwater. *See air sparging*.
- biosphere** Living animals, fishes, birds, trees, plants, algae, bacteria and any other life on earth.
- biostimulants** Chemicals that stimulate biological activity, e.g. nutrients in water that stimulate algal growth.
- Biostyr** A type of backwash *biological aerated filter* that uses upward flow. The medium is floating polystyrene beads and can also be categorised as a *biological fluidised bed*.
- biosurvey** The survey of the range of aquatic plants and animals in a river, lake, etc. and thereby establish its quality. *See biotic index*.
- biosynthesis** The biological process of making complex organic molecules from simple ones.
- biota** The living parts of an *ecosystem*.
- biotic index, index of biological integrity** The study the flora (plant) and fauna (animals) in the river and thereby relate the types of flora and fauna to the river quality. For example, the variety and population size of differing macro-invertebrates species (e.g. flies, worms, leeches, snails, beetles) can be related to differing water qualities. Hence the quality of the river can be graded numerically by studying species of macro-invertebrates in and around the river. These numerical indices are known as numeric biocriteria. Examples include the *BMWP biotic index* and the *Trent biotic index*. *See diversity index, Water Framework Directive, 2000*.
- biotope** A relatively small area where the environment is uniform—e.g. under large stones in river water of the Scottish Highlands; nearly always cold, well aerated and soft water.
- biotower** *See high rate trickling filter (1)*.
- biotrickling filter** *See trickling filter*.
- bioventing** A technique for treating contaminated land where air is forced into wells placed into unsaturated soil. The air passes up through the soil either to remove the *VOCs* from the soil (*soil vapour extraction*) or to encourage *in situ bioremediation*.
- bisphenol A** An organic chemical that is used in the manufacture of epoxy resins and polycarbonate plastic products. It shows some *oestrogenicity*, i.e. it is an *endocrine disrupter*.
- black fly (Simuliidae)** A pest that lives in rapid, warm rivers—e.g. *Simulium*.
- black list substances** *List 1 substances*.
- black mud** Black mud, stinking of *hydrogen sulphide*, H<sub>2</sub>S, is an indication of *anaerobic* conditions, with H<sub>2</sub>S produced by *sulphate reducing bacteria*.



Even in a clean river, only the top 4 mm of mud can receive oxygen from the water over it.

**black oil** Usually this means crude oil, occasionally heavy oil fractions, as opposed to *light oils*. A few hours after an oil spill, the light fractions evaporate and the petroleum acids dissolve in the water, leaving the heavy oil residue.

**black smoke** *Smoke* usually containing unburnt carbon, a fault in combustion which can be prevented by skilled operation of the furnace. It corresponds to a value of 4 on the *Ringelmann chart*. In the UK, emissions of black smoke is limited to an aggregate of two minutes over any 30 minute period. *See dark smoke.*

**black water** *Septage.*

**bladder wrack**, *Fucus vesiculosus* A *brown alga*, or phaeophyte, a seaweed with blisters on its leaves. This alga flourishes about halfway between high and low water.

**blanket clarifier** A *sludge blanket clarifier.*

**bleaching powder** *Calcium hypochlorite.*

**blinding** Blocking of filter fabric or *slow sand filters* with fine material.

**block carbon** *Activated carbon block.*

**blood worms** Red aquatic *larvae* of the *chironomid* midge, which may indicate water pollution.

**bloom** An explosive growth of micro-organisms, such as *algae* or *cyanobacteria*, that results in a green mat floating on the water. The algae or cyanobacteria can produce an unpleasant taste or smell in the water. On dying, the micro-organisms decay and cause deoxygenation of the water. The cyanobacteria may produce *endotoxins* which can make the water dangerous to drink.

**blowby** In an internal combustion engine, the crankcase is vented by passing air through it. About 20 to 40% of the hydrocarbons admitted from a car can come from the crankcase blowby. The crankcase ventilation can be recycled back into the air intake for the engine.

**blowdown** (1) Removal of the dirtiest boiler water (from the bottom of the boiler), which often has a dissolved solids concentration of 10 000 mg/l, including corrosion inhibitors such as chromates and polyphosphates. This practice, common with low pressure and medium pressure boilers, is unnecessary with high pressure boilers, since they use no corrosion inhibitors and have to use *demineralised water*. (2) Hydrocarbons released from refinery units during shutdown or start-up.

**blowers** Centrifugal blowers can produce large flows of air at pressures up to 60 kN/m<sup>2</sup>. They are commonly used to produce the air for *diffused air systems* in *activated sludge* plants.

**blow outs** In a water pipe, localised severe pipe failure which can be associated with a sudden pressure surge in a poor quality pipe.

**blue baby syndrome** *See methaemoglobinaemia.*

**blue green algae** *Cyanobacteria.*

**BMPs** *Best management practices.*

**BMWP biotic index** A *biotic index* system developed in 1983 by the UK Biological Monitoring Working Party. The variety and population size

of differing macro-invertebrates species (e.g. flies, worms, leeches, snails, beetles) are investigated. The species are grouped into those that do and do not tolerate pollution and a score of between 1 to 10 is given for each group; 1 for groups that flourish in polluted water and 10 for groups that flourish in very clean water. The various scores are summated to give an overall score. A score greater than 100 represents good quality river water.

**BNR** Biological nutrient removal. See *biological phosphorus removal, denitrification, nitrification—denitrification*.

**BOD, biochemical oxygen demand** A measure of the amount of biodegradable organic substances in water. It is expressed as the number of milligrams of oxygen required by the micro-organisms to oxidise the organics in a litre of the water. In the standard test a sample of the water or a dilution of it is incubated at 20 °C for 5 days ( $BOD_5$ ). A blank sample shows how much the dissolved oxygen in the diluting water decreases with time. The dilution water is seeded with bacteria, typically by adding a few ml of wastewater effluent and some inorganic nutrients.

An idealised shape of BOD uptake with time is seen in *Figure B.8*. For the first 6 to 10 days mainly carbonaceous matter is oxidised (*carbonaceous BOD*) but thereafter an increasing *oxygen demand* is exerted by the oxidation of ammonia compounds to nitrite and nitrate (*nitrogenous BOD*). This *nitrification* can be suppressed by addition of ATU (allyl thiourea). Results are then quoted as  $BOD_5(ATU)$  which is often the standard method for reporting BOD data. Domestic wastewater in dry weather typically has a  $BOD_5$  of around 250 to 300 mg/l. A good quality wastewater effluent has a  $BOD_5$  of 20 to 25 mg/l and a clean river a  $BOD_5$  of 2 mg/l. Industrial effluents with high concentrations of organic material may have BODs of 1000's mg/l. Disadvantages of the BOD test include: 5 days' wait for the result; no measure of the non-biodegradable organic substances. BOD results can be seriously inhibited by substances that poison bacteria.

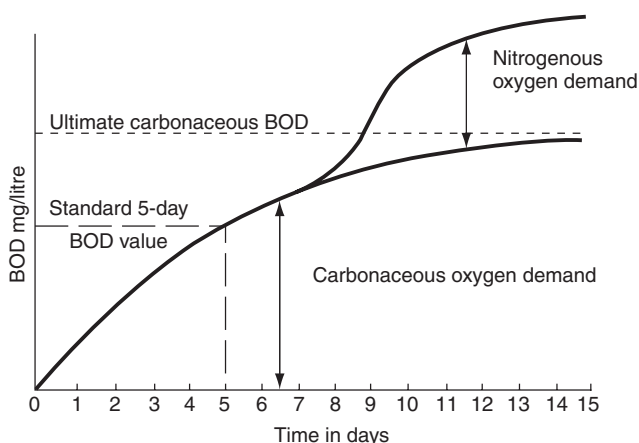

**Figure B.8** Biochemical oxygen demand, hypothetical curve.

**BOD: COD ratio** See *COD*.

**BOD load** The *BOD*<sub>5</sub> of water or wastewater multiplied by the flow to give a value of mass of BOD per unit time.

**body burden** The total load of a contaminant likely to be carried by people in a particular environment.

**Bohna filter** A *horizontal flow sand filter*.

**boiler feed water** *Feed water*.

**borehole** See below and *deep well, injection well, disposal well, tube well, wet well*.

**borehole casing** See *well casing*.

**borehole pollution** See *well pollution*.

**borehole yield** The firm yield of a borehole is its lowest output of raw water in a given dry period or the average output which could be continually withdrawn.

**borism** Illness caused by excess of *boron*, sometimes from water.

**boron** A micronutrient, yet toxic to a wide range of plants at higher concentrations. Before irrigation, 1 mg/l or less is the maximum desirable boron concentration in the water. See *Table D.2 Drinking water standards*.

**bottle bank** Special skips often about 6 m<sup>3</sup> into which the general public deposit used glass bottles via a hole in the lid. Different skips may be present for differing colours of glass.

**bottom ash** The ash from the bottom of the incinerator as opposed to *fly ash*. It can contain clinker and may be suitable for road building.

**bottom sediments** Bottom muds in lakes, rivers or the sea tend to concentrate metal salts from the tiny percentages dissolved in the water above them. The reason is that many such substances form insoluble hydroxides or are absorbed by suspended particles that eventually settle on the bottom. For instance, the mud at Minamata Bay, Japan had 30 to 40 mg/l of *mercury*, although the water over it had only from 1 to 10 µg/l. The mud thus had a mercury concentration up to 40 000 times as high as the water.

**bound water** Water that is held at or near the surface of a solid. The hydrophilic surfaces of proteins and polysaccharides have bound water on them.

**bourne** A stream along a hillside spring line, which extends up the valley as the underground water level rises.

**BPEO** *Best Practicable Environmental Option*.

**BPT** Best Practicable (control) Technology or Best Practical Treatment currently available applied to the treatment of wastes, whether gaseous, liquid or solid.

**Bq** *Becquerel*.

**brackish water** Water containing a few thousand mg/l of dissolved salts. The water tastes salty, but has substantially less salt concentration than seawater. See *brine*.

**brake pressure tank** A way of reducing the pressure in, and thus the cost of, a water main. The break pressure tank receives water from the main through a ball valve and delivers it to the downstream length of main. Breakages in pipelines at high pressure can be dangerous as well as expensive.

**branch main** A water supply pipe that serves a small area and finishes in a dead end. Branch mains are undesirable because of *stagnation* in the pipe

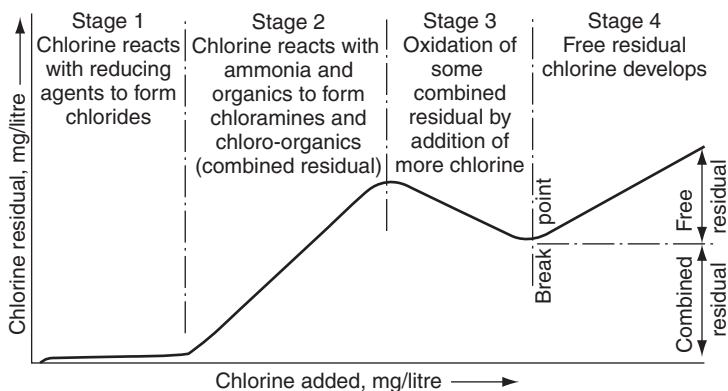

Figure B.9 Breakpoint chlorination.

end. *Ring mains* are preferable also because fewer customers suffer when there are repairs.

**brass corrosion** See *dezincification*.

**breakbone fever** *Dengue*.

**breakpoint chlorination** When *chlorine* is added to water or wastewater to disinfect them, readily oxidisable substances (e.g.  $\text{Fe}^{2+}$  or  $\text{Mn}^{2+}$ ) and organic matter react first with the chlorine. Thereafter the chlorine reacts with *ammonia* to form chloramines (monochloramine,  $\text{NH}_2\text{Cl}$ , and dichloramine,  $\text{NHCl}_2$ ), and possibly trichloramine,  $\text{NCl}_3$  (nitrogen trichloride). The breakpoint is reached when these reactions are complete so that continued addition of chlorine then produces *free residual chlorine*—that is, unreacted *hypochlorous acid* ( $\text{HOCl}$ ) or *hypochlorite* ion ( $\text{OCl}^-$ ). (see *Figure B.9*.) The chlorine in the chloramines is the *combined residual chlorine*. The ammonia–chlorine reaction needs 10 parts by weight of chlorine to neutralise one part of ammonia expressed as nitrogen. See *chlorination*.

**breakthrough** (1) In a packed bed column reactor, such as an ion exchange column or activated carbon, the pollutants are removed in the bed until the bed becomes saturated with a pollutant. At that stage the bed is exhausted and the concentration of pollutant in the outlet is the same as the inlet. The point at which this starts to happen is known as the breakthrough. See *Figure B.10*. (2) *Air breakthrough*.

**breaching, breaching** A term for a horizontal *flue*.

**brewery wastewater** Although the waste liquors from *fermentation* have a high *BOD* and suspended solids, much of the effluent from a brewery comes from the washing processes. The  $\text{BOD}_5$  of the mixed wastewater is about 400 mg/l for beer brewing and 1000 mg/l for cider brewing.

**brine** Often this means seawater or a solution of common salt,  $\text{NaCl}$ . Ordinarily, seawater has about 35 000 mg/l (3.5%) of dissolved salts. Some brines have 300 000 mg/l (30%) of dissolved salts. Brine is sometimes defined as water with more than 30 000 mg/l of dissolved matter. See *brackish water*.

**broad irrigation** An old term for *land treatment*.

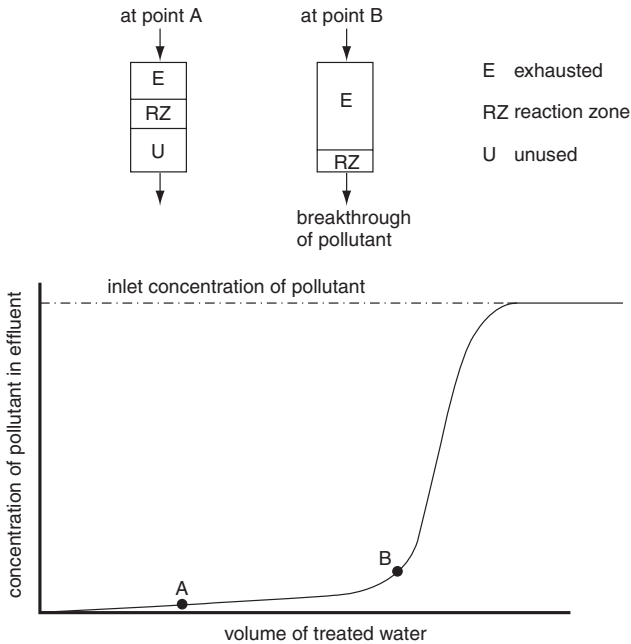

**Figure B.10** Breakthrough curve.

**bromate,  $\text{BrO}_3^-$**  Bromate can occur as a *disinfection by-product*. It is possibly carcinogenic. See *Table D.2 Drinking water standards*.

**brominated diphenylethers Polybrominated diphenylethers.**

**bromine, Br** A *halogen* that, like iodine and chlorine, is used for *disinfection*.

Bromamines are more effective disinfectants than the chloramines discussed under *breakpoint chlorination*, but bromine is expensive. It is therefore unlikely to be used for disinfecting municipal water supplies, although it has been used to disinfect swimming pools or whirlpool spas. Seawater contains only 50 to 60 mg/l of bromine.

**bromine chloride** A gas that can be used as a disinfectant. It reacts in water to produce hypobromous acid (HOBr) and hydrogen chloride. HOBr is the strongest germicide of all the bromine compounds. Potentially hazardous brominated organic compounds are formed as a result of using bromine chloride as a disinfectant.

**bromoacetic acid** See *haloacetic acids*.

**bromochloromethane,  $\text{CH}_2\text{BrCl}$**  A chemical used in fire fighting. It is an ozone depleting substance and was banned in the EU from 2000.

**bromodichloromethane,  $\text{CHCl}_2\text{Br}$**  See *trihalomethanes*.

**bromoform,  $\text{CHBr}_3$**  See *trihalomethanes*.

**brown algae, phaeophytes, Phaeophyta, phyophytes, Phyophyta** Multicellular seaweeds which form large beds in coastal water and include *bladder wrack* and *kelp*.

- brownfield site** A site that is used for new building development that has already been used for buildings or industrial plant, etc.
- Brownian motion** Slow movement with random direction, seen under the *microscope* in small objects the size of bacteria. Some bacteria, in addition to Brownian movement, have their own motion.
- brown smoke** *Smoke* usually containing tar from coal, which can, like *black smoke*, be prevented by skilled operation of the furnace. Both types of smoke indicate incomplete burning of the fuel. A particularly polluting but rare brown smoke is caused by the presence of *nitrogen dioxide* in the smoke.
- brucellosis, contagious abortion, Gibraltar fever, Malta f., etc** Disease in humans or cattle, caused by the bacterium *Brucella abortus*. It is conveyed to humans in unpasteurised milk from infected cows but may also be a *waterborne disease*.
- Brugia malayi** A parasitic *nematode* worm that causes *filariasis*.
- brugiasis** See *filariasis*.
- brush aerator** A *surface aerator* with a rotating horizontal shaft having metal blades attached to it. The original type was the *Kessener brush*, other types include the *Mammoth rotor* and the *TNO rotor*. Brush aerators are common in *oxidation ditches*.
- bryophyte, Bryophyta** A plant *phylum* that includes liverworts and mosses, normally found in slightly polluted water.
- BS** British Standard.
- BS7750** UK specification for *Environmental Management Systems*, now replaced by *ISO 14000* series.
- BSCP** British Standard Code of Practice.
- BSEN** British Standard European Norm. This signifies that the UK has adopted the European standard as the British Standard.
- BTMA** Best Technical Means Available, a term that can be applied to the treatment of wastes, whether gaseous, liquid or solid.
- bubble gun** A type of *air lift pump*, used for *destratification of lakes and reservoirs*.
- Buchner funnel test** A rough assessment of the rate of formation of *sludge cake*, made by pouring sludge on to a filter paper over an ordinary ceramic Buchner funnel which is evacuated through a filter flask.
- bucket latrine** A system used in low income communities, consisting of a bucket for excreta, which is frequently removed and emptied. If improperly maintained, it is smelly and may be dangerous to health. See *chemical toilet, vault latrine*.
- buffering** The property, possessed by some solutions, of resisting any change in *pH* value. Bicarbonate buffer systems protect natural waters from fluctuations in pH. Buffers are usually a solution of a salt of a weak acid with a strong *alkali* or of a salt of a weak alkali with a strong acid.
- builder** Active *synthetic detergents* compose only 15 to 35% of the commercial detergents. The remainder consists of builders that hold the dirt and may include foaming agents (alkanolamides); carboxymethyl cellulose to prevent dirt from re-depositing during laundering; and various phosphates, usually *sodium tripolyphosphate*, or sodium perborate and sodium silicate.

**building services engineering** Engineering of the environment within a building, i.e. heating, ventilation, light, acoustics, etc. Sometimes, rather confusingly, called environmental engineering.

**building sewer, house drain** A sewer between a building and the *collector sewer* in the street.

**bulk density** Weight per unit volume including voids—e.g. of the *medium* in a *trickling filter*, of the sand or anthracite in a *deep bed filter*, etc.

**bulking** Inability of an *activated sludge* to settle and thus to separate from the effluent. The term covers a wide range of possibilities—e.g. severe growths of *filamentous organisms* such as *Sphaerotilus natans* or *Leucothrix*. The stringy growths may be not the fundamental reason for the bulking. The activated sludge may lose its *flocculating* characteristics first and only then does the filamentous growth flourish. Bulking has been connected with low dissolved oxygen content, low nutrient content, high *F:M ratio*, but an exception can be found to most generalisations about it. *See flocculation, Nocardia foam.*

**bulky waste** Large items of waste that cannot readily be picked up by the normal collection system.

**bund** A wall built of earth or other material impervious to the fluid to be retained.

**bunding of oil tanks** Prevention of oil pollution by the building of a *bund* around an oil tank of such a height that the volume contained below the top of the bund is equal to the volume of the tank plus 10%. Then, if the tank bursts, all the oil will be held in. No drainage to domestic sewers should be provided from inside the banded area and any rainwater pumped out must go to a treatment plant for removal of the oil.

**buoyancy of stack gas** The buoyancy of flue gas, in the chimney or afterwards, increases directly with the temperature and with the live steam content, because steam is about half as dense as air at the same temperature. However, if the steam temperature falls below the *dewpoint* and becomes water vapour, the flue gas may become denser and less buoyant than air. *See stack gas reheating, wet scrubbing.*

**buoyant media filter** A type of *upflow filter* in which the media is slightly buoyant and retained in the filter by a mesh. The backwash is upflow. Some *biological aerated filter* systems uses floating polystyrene beads retained by a mesh to stop them flowing out with the effluent.

**burnout** In incineration, the complete destruction of all the combustible material. Most incinerators have a burnout zone or an afterburner.

**burnt lime** *Slaked lime.*

**burst detection** *See leakage detection.*

**burst frequency** The number of bursts per km of water supply pipe is an important measure of the overall integrity of the water supply system in a given area.

**1,3-butadiene, C<sub>4</sub>H<sub>6</sub>** A gaseous chemical that is used in the manufacture of synthetic rubber. It is also present in small quantities in petrol (gasoline). It is teratogenic and probably carcinogenic. It can also damage the kidney and liver. It is present in vehicle emissions and can be a health hazard in urban air that is badly polluted with exhaust fumes.

**butanol wheel** A device that can be used for measuring the intensity of odour in water against various concentrations of butanol.

**butterfly valve** A valve in a pipe that has a disc the size of the internal diameter of the pipe. When the disc is in the same direction as the flow the valve is fully open. The disc can be turned through 90° to shut off the flow.

**butter making** See *creamery wastewater*.

**butylated hydroxyanisole, BHA** and **butylated hydroxytoluene, BHT** These chemicals are food additives. They show slight *oestrogenicity*, i.e. they are *endocrine disrupters*.

**butyl benzyl phthalate, BBP.** See *phthalates*.

**by-wash channel** A channel to reduce the amount of silt coming into a reservoir from direct *overland flow*. It is a *leat* or stream following a contour, which starts at the head of the reservoir, passes along the full length of the lake and discharges to the *spillway*. A leat may be cut along each of the two hillsides flanking the lake.





---

**CAA Clean Air Act.**

**CAAA Clean Air Act Amendment.**

**cable burning** The burning of copper wire waste to melt its plastic sheathing leaves copper which is then sold for scrap. The practice should be prevented at *landfill* sites in order to reduce the risk of a landfill fire.

**caddis flies, Trichoptera** A fly that may be used in a *biotic index*. The larvae of differing species can be found in clean or slightly polluted water. See *Hydropsyche*.

**cadmium** A heavy metal that is highly toxic to humans causing kidney malfunction. If it is present in seawater, molluscs such as oysters can *bioaccumulate* cadmium. Cadmium may be released into the air from incinerators or cadmium plating industries etc. It is present in some rechargeable batteries. It is present in low concentration in wastewater from industrialised conurbations. The disposal of wastewater sludge to land can be restricted based on its cadmium concentration. Cadmium accumulates in the soil and into the plants and into animals or humans that feed on the vegetation. The EU lists it as a *priority hazardous substance* in relation to aquatic discharges. See *Table D.2 Drinking water standards*.

**caesium-137, <sup>137</sup>Cs** An important *decay product* in *radioactive wastes*.

**cage rotor** A *brush aerator*.

**cake filtration** *Mechanical dewatering of sludge* that produces a cake of dewatered sludge, e.g. *belt filter press, centrifuge, filter plate press, vacuum filter*.

**calcium bicarbonate, Ca(HCO<sub>3</sub>)<sub>2</sub>** See *calcium carbonate, carbonate hardness*.

**calcium carbonate, CaCO<sub>3</sub>** Though regarded as insoluble, calcium carbonate dissolves in water to the extent of about 15 to 25 mg/l, depending on the pH value. It forms the bulk of chalk and limestone and is the main cause of *hardness*. With carbon dioxide in water it dissolves as the bicarbonate:

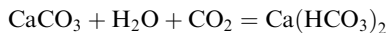

Calcium carbonate re-precipitates inside water pipes or vessels particularly if the water is heated.

**calcium hydroxide, Ca(OH)<sub>2</sub>** A chemical commonly used in the *coagulation* of water, in *water softening*, sludge *conditioning*, phosphorus removal and ammonia removal from wastewater effluent. It is usually added as a slurry, and raises the pH of the water. Commercial grades are known as *lime*—correctly as hydrated or slaked lime.

**calcium hypochlorite,  $\text{Ca}(\text{OCl})_2$ , bleaching powder** A solid which liberates the *hypochlorite* ion,  $\text{OCl}^-$ , when dissolved in water. It can be used for *disinfection*. See *pot chlorinator*.

**calcium sulphate,  $\text{CaSO}_4$**  Calcium sulphate is a common cause of *non-carbonate hardness*. It is often dissolved from clays. Commercial grades are known as gypsum. Sulphates in high concentrations in water are purgative.

**Calgon** See *sodium hexametaphosphate*.

**calorific value, heating v., CV** The amount of heat given off by a fuel when it burns completely. There are two values. The larger or gross CV is slightly too high because it includes heat from the steam, given up when the water formed in the burning is condensed. The lower or net CV gives a truer value of the heat that can be used. The calorific value of landfill gas is usually in the range 16 to 20 MJ/m<sup>3</sup>. The calorific value of domestic solid waste varies from about 4 MJ/kg for the food fraction to 16 MJ/kg for paper and over 30 MJ/kg for plastics. *Refuse derived fuel* has a calorific value of about 12 to 16 MJ/kg.

***Campylobacter*** These bacteria can cause gastroenteritis. It is a common cause of travellers' diarrhoea. The organism is present in a range of animals and humans can contract the disease via contaminated food or water. The species found in wastewater is usually *Campylobacter jejuni*, whereas the food borne species is commonly *Campylobacter enteritis*.

**Canicola fever** A form of *leptospirosis* caused by *Leptospira interrogans canicola*.

***Candida*** Various species of this yeast that may be found in wastewater treatment processes. Some species are pathogenic to humans.

***Candida utilis*** Food yeast, a *single cell protein*.

**candidiasis** The disease caused by pathogenic species of the fungus *Candida*.

**candle filter** See *filter candle*.

**cannery wastewater** The volume and quality of food cannery wastewaters vary with the product. Typical values of liquid canning wastewaters are: for peas BOD<sub>5</sub> 400 to 4000 mg/l, suspended solids 250 to 400 mg/l; for potatoes BOD<sub>5</sub> 200 to 3000 mg/l suspended solids 1000 to 1200 mg/l; for apples BOD<sub>5</sub> 1600 mg/l suspended solids 300 mg/l.

**cap, capping** On completion of a *landfill* site, the surface may be capped with a layer of low permeability soil in order to reduce the infiltration of the water into the landfill and therefore reduce the quantity of leachate. One metre depth of clay is sometimes used with topsoil covering the clay to allow vegetation to grow. The reduction of water infiltrating the landfill reduces the moisture in the fill material. This can be a major disadvantage because it reduces the biodegradation of the fill and thereby substantially lengthens the time period before the landfill is fully stabilised and the production of *landfill gas* ceases. Synthetic membranes can be used instead of clay. A cap of very low permeability is not desirable if a *sustainable landfill* operation is required.

**capillary fringe** The ground immediately above the *water table* which contains water held by capillary rise. The lower part of the fringe is fully saturated.

The fringe rises higher with increasing fineness of the soil. It is the lowest part of the *unsaturated zone*.

**capillary suction time, CST** The time in seconds, under standard conditions, for water from a sludge to travel a given distance along a filter paper. The test can be used to measure the *filterability* of the sludge. The CST and filterability can be related only for a given sludge. See *specific resistance*.

**Capitella capitata** A marine *polychaete* used in bioassays of tidal mud and estuaries. It is more resistant to oil spills than other polychaetes.

**Carbofloc process** A wastewater sludge treatment process in which thickened sludge with *lime* added to it reacts with carbon dioxide gas to form *calcium carbonate*, that acts as a *chemical conditioner*. *Flue gas* from *incineration* can provide the carbon dioxide.

**carbofuran** An insecticide that is toxic to humans affecting the nervous and reproductive systems. The *USEPA MCL* in drinking water is 40 µg/l and the WHO guideline maximum value is 7 µg/l. The EU Drinking Water Directive states a mandatory maximum of 0.1 µg/l.

**carbohydrate** Organic substances such as starch, *cellulose*, sugar that contain hydrogen, carbon and oxygen, with about twice as many atoms of hydrogen as of oxygen. Carbohydrates are widely distributed in plants and animals.

**carbon** A non-metal that forms the bulk of most fuels, about 90% of anthracite and 70% of bituminous coals, and, being the basis of organic compounds, is essential to life.

**carbonaceous BOD** The biochemical oxygen demand exerted in the *BOD* test, coming from the biochemical oxidation of organic carbon only. In domestic wastewater 60 to 70% of the total carbonaceous BOD is measured in the 5 days.

**carbonaceous oxidation** Oxidation of matter containing carbon, producing carbon dioxide.

**carbon adsorption bed, c.a. column, c. contactor, activated c. filter, GAC filter** A tank used in water (or possibly wastewater) treatment, containing 1 to 9 m depth of *granular activated carbon* (GAC) through which water flows, usually as a downward flow filter but possibility as an upflow or moving bed filter. The beds filter out suspended solids and so they may need *backwashing* preceded with *air scouring*. The bed or filter may be designed for *surface loading rates* of 100 to 600 m<sup>3</sup>m<sup>-2</sup>d<sup>-1</sup>. The spent activated carbon is removed from the bed or filter and regenerated by the same process as newly manufactured activated carbon. GAC filters can be used in air pollution control to remove toxic organics from gaseous effluents, such as incinerator waste gases. GAC filters are also widely used for odour control, with the odorous gas being passed through beds of GAC. GAC on which microbes are grown is known as *biological activated carbon*. The microbes enhance the treatment of the water or wastewater. See *break-through* (Figure B.10), *effective carbon dose*.

**carbonate hardness, temporary h. Hardness** caused by bicarbonates (HCO<sub>3</sub>) of calcium or magnesium or occasionally strontium or *iron in water*. On

boiling, the carbonates are precipitated, producing the characteristic *scale* (fur) in hot water systems, kettles, etc., thus:



**carbon block** *Activated carbon block.*

**carbon chloroform extract, CCE** A chemical procedure in which the organic compounds in water are adsorbed on *activated carbon* and then desorbed by the solvent chloroform. CCE is a measure of the trace (and possibly toxic) organic compounds.

**carbon contactor** *See carbon adsorption bed.*

**carbon dioxide, CO<sub>2</sub>** A gas with high solubility in water—well water may contain 29 000 mg/l of free CO<sub>2</sub>—responsible for the acidity of many natural waters. CO<sub>2</sub> in water is either free, as carbonic acid (H<sub>2</sub>CO<sub>3</sub>), or combined, e.g., calcium or magnesium as Ca(HCO<sub>3</sub>)<sub>2</sub> or Mg(HCO<sub>3</sub>)<sub>2</sub>. Free CO<sub>2</sub> can be removed by a cascade which also oxygenates the water. CO<sub>2</sub> is formed by the oxidation of organic matter. *Flocculation* of water containing *carbonate hardness*, with *alum* or *ferrous salts* or ferric salts, releases CO<sub>2</sub> and some of this may remain for stabilisation. The carbon dioxide content of the air (0.033% or 330 p.p.m.) has been rising. If the CO<sub>2</sub> content of the atmosphere continues to rise, a *greenhouse effect* will progressively warm the Earth's surface. The recent serious de-forestation of the Earth could raise the CO<sub>2</sub> content of the atmosphere and so could the increased consumption of fuels.

**carbon dioxide stripper, CO<sub>2</sub> stripper** A *cascade aerator* or a *packed tower aerator* that is used to remove unwanted CO<sub>2</sub> from water.

**carbon emissions trading** A system in which a company that emits pollutants at a lower level than its target is able to trade and sell this to companies that cannot economically reach their target emission level. This is part of the *Kyoto Protocol 1997*.

**carbon filter** *See carbon adsorption bed.*

**carbonic acid, H<sub>2</sub>CO<sub>3</sub>** The acidity formed by carbon dioxide dissolving in water.

**carbonising** (1) The heating of coal, wood, etc., in the absence of air to produce coke, charcoal, etc. (2) In wool cleaning, the use of hot concentrated acids to char the vegetable particles in the wool and thus to loosen them.

**carbon matter partition coefficient (Koc)** A measure of the partitioning of a chemical between water and soil in contact with the water.

**carbon monoxide, CO** A poisonous, invisible gas that has neither taste nor smell. It is formed when carbon burns with too little air. CO has a half life of 2 and 3 months and oxidises to carbon dioxide, CO<sub>2</sub>. CO is explosive in air and burns to CO<sub>2</sub>. It has a high affinity for haemoglobin in blood and displaces O<sub>2</sub> to form carboxyhaemoglobin (COHb). This can cause dizziness, headaches and eventually death. In indoor air pollution, the danger occurs when combustion products from gas fires etc. are not fully vented away from the indoor air. Tobacco smoke is a common source of carbon monoxide in indoor air. Internal combustion engines are responsible for

most of the CO in the outdoor air. For the ambient outside air, EU legislation has proposed a limit for CO to be less than  $10 \text{ mg/m}^3$  averaged over an eight hour period. In the USA, *NAAQS* has set a standard for CO of  $10 \text{ mg/m}^3$  (9 ppm) averaged over an 8 hour period and  $40 \text{ mg/m}^3$  (35 ppm) averaged over a 1 hour period.

**carbon:nitrogen:phosphorus ratio, CNP ratio** The average ratio of C:N:P in living matter is 106:10:1. For biological treatment the ratio is normally expressed as *BOD*<sub>5</sub>:N:P and the minimum N and P contents should give a ratio of 100:5:1. Any nitrogen deficiency can be corrected by adding an ammonium salt or nitrates and phosphorus deficiency can be corrected by adding phosphates.

**carbon tetrachloride, tetrachloromethane, CCl<sub>4</sub>** A chemical is used in industry, particularly as a cleaning agent and in the production of chlorofluorocarbons. It is an ozone depleting substance. It is probably carcinogenic to humans. The *USEPA MCL* in drinking water is  $5 \mu\text{g/l}$  and the WHO guideline maximum value is  $2 \mu\text{g/l}$ .

**carrioscope** An optical instrument for estimating *dark smoke*, slightly different from the *telesmoke*.

**carboxyhaemoglobin, COHb** A compound formed in the blood when its haemoglobin reacts with carbon monoxide in the air. COHb reduces the ability of the blood to carry oxygen.

**Carchesium** An stalked *ciliate protozoon* often present in *trickling filters* or *activated sludge*, especially where *nitrification* is well established and a clean effluent is produced. It is also found in *sewage fungus*.

**carcinogen, carcinogenic agent** A chemical that causes cancer.

**Carlson's trophic state index** *Trophic state index*.

**carriage water** The water in wastewater which carries it along the sewers to the treatment plant. It may consist of the wastewater from industry and dwellings plus stormwater and some *infiltration*.

**carrier** An individual who, although harbouring a pathogen, does not show symptoms of the disease but may be a source of transmission to others. A carrier is often someone who has had the disease but appears to have made a recovery.

**Carrousel system** An *extended aeration* activated sludge treatment for wastewater from which only coarse solids and grit have been removed. It resembles an *oxidation ditch* but is larger and deeper. The *mixed liquor* is aerated and circulated by *cone aerators* at the ends of the channel.

**carry-over** The passage of unwanted materials or chemicals in the treated air or water flow from a treatment process. This means that the materials or chemicals have not been removed in the treatment process.

**cartage** The removal of the contents (nightsoil) of *bucket latrines* and *vault latrines* by manual labour or by *vacuum vehicles* (see *Figure V.2*).

**Carver-Greenfield process, multi-effect dryer, multi-effect evaporator** A wastewater sludge dewatering process in which the sludge is mixed with oil and then passed to an evaporator which is operated at a temperature that allows the water to evaporate. The oil is separated from the remaining

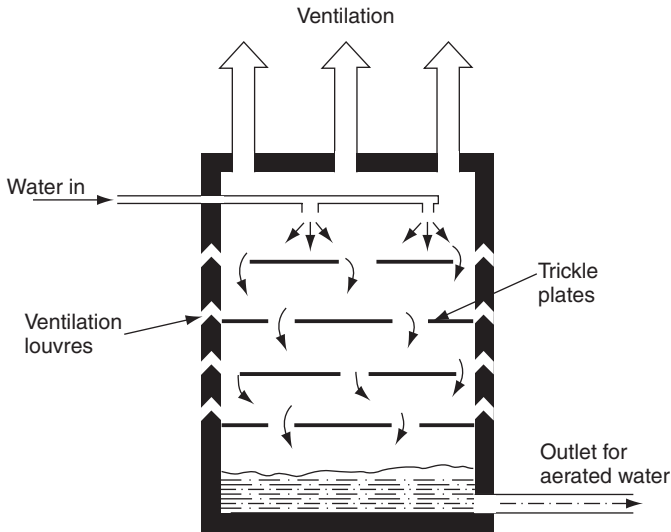

Figure C.1 Cascade aerator.

dried sludge by centrifugation. The collected oil can be returned to start of the process.

**cascade aerator, free fall a.** An aerator of which two varieties exist, packed bed types (see *packed bed aerator*) and free fall type which is a type of *plate tower reactor* with the water cascading over open aerated steps (see Figure C.1). It can be used to remove unwanted gases from water.

**cascade impactor** A gas sampling device in which the gas is directed through a series of right angle turns at each of which is a slide collector with a sticky surface. Immediately following each collector the air is drawn through a nozzle which increases the velocity and hence influences the size of particle deposited at the next change of direction (see Figure C.2). By suitably calculating the dimensions and number of stages, the equipment can be designed to capture particles of a wide range of sizes. These devices are commonly used in occupational hygiene surveys.

**casing, lining** See *well casing*.

**cast iron pipes** These old established pipes are now of spun iron when in straight lengths, but bends, flanged pipes, hydrants and other special fittings are cast in vertical sand moulds. Corrosion of old cast iron pipes can give water quality problems due to the *iron in water*. See *water pipe rehabilitation*.

**catabolic metabolism, catabolism** Breakdown of molecules, including their oxidation, to provide energy. They are biochemical reactions that, simultaneously with *anabolism*, make up *metabolism*.

**catalyst** A substance that speeds up a chemical reaction without itself being consumed. Platinum does this for the burning of fuel gas. *Enzymes* do it for biochemical reactions.

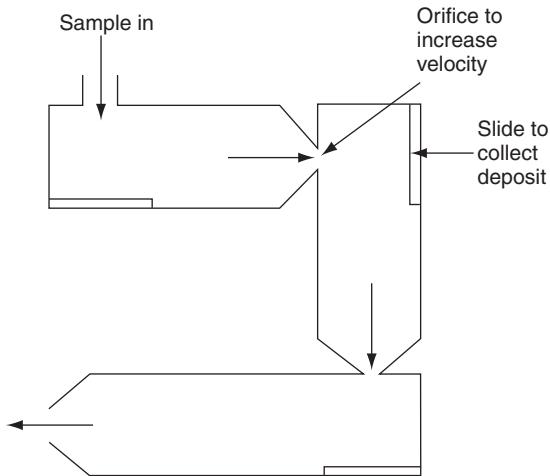

**Figure C.2** Cascade impactor. Orifices are sequentially reduced in diameter so that the flow is increased and particle size deposited is reduced.

**catalytic VOC incinerator** Low concentrations of volatile organic compounds (*VOCs*) can be removed from a waste air stream using an incinerator which contains a catalyst. Hot gases from fuel burning goes into the incinerator and the *VOCs* are burnt and oxidised. The burning temperature is lower than *thermal VOC incinerator* because of the presence of the catalyst. The catalyst may be platinum on an aluminium support.

**catch basin** A chamber or sump by the roadside where runoff collects and enters the sewer system.

**catchment, c. area, drainage area, gathering ground** (1) The area of land that collects the water flowing to a given length of stream or to a reservoir or lake or to a specific sewerage system. (2) A *watershed* or drainage basin.

**catchment yield** The *runoff* from a *catchment*. See also *yield of a water source*.

**catchwater** A tunnel, pipe or *leat* dug or laid to bring water into a *reservoir* from a neighbouring *catchment*. The natural catchment of the reservoir is thus enlarged by the neighbouring area, which is called an indirect catchment for the reservoir. See *Figure D.3*.

**cathode, kathode** (adjective *cathodic*) The negative *electrode* in *electrolysis*. It attracts *cations*. See *anode*.

**cathodic protection** Protection from corrosion of the outside of underground or submerged metal structures such as pipes, by making the metal cathodic to an *anode* outside it, which may be consumable or not. Consumable (*sacrificial*) *anodes* are of zinc, magnesium, aluminium or their alloys. Non-consumable anodes of graphite or platinum are used in the impressed current system with the pipe as *cathode* in a direct current circuit with a higher value than, and an opposite direction to, the estimated corrosion voltage. The anodes may need to be numerous so as to provide enough protection.

**cation** A positively charged *ion*. It moves to the *cathode* in *electrolysis*. Metals, ammonium and hydrogen all yield cations. *Compare anion*.

**cation exchange, base e.** Replacement of one *cation* by another—e.g. replacing calcium and magnesium by sodium or hydrogen ions in *water softening* by *ion exchange*.

**cation exchange capacity, CEC** The ability of soil to exchange cations. It is measured in milliequivalents per 100 g of soil and ranges from 2 to 3 meq/100 g for sand up to 200 or more meq/100 g for clay and organic matter. *See ion exchange*.

**cation exchange resins** *See ion exchange*.

**cationic detergent** *See synthetic detergents*.

**causal mechanism** The process by which an effect is produced by a cause.

**causal relationship** The relationship between cause and effect.

**caustic alkalinity** *Alkalinity* caused by a strongly alkaline chemical—e.g. sodium hydroxide (NaOH) or *calcium hydroxide* (Ca(OH)<sub>2</sub>). In water supply it is often defined as the alkalinity above pH 8.2, the so called phenolphthalein alkalinity, because phenolphthalein changes from colourless at lower pH values to red at pH above 8.2. In natural waters any alkalinity above 8.2 is usually caused by carbonates or hydroxides.

**caustic scrubbing** The use of caustic soda, sodium hydroxide, NaOH, as the wash solution in a *wet scrubber* to remove sulphur dioxide.

**cavitation** Formation and rapid collapse of vapour or gas bubbles in low pressure areas in a pumping system or near a ship's propeller, etc. It may occur where high velocity reduces the pressure, as at the tip of the *impeller* of a *centrifugal pump*. It often causes corrosion.

**CCE** *Carbon chloroform extract*.

**CCL** Contaminant Candidate List. *See Drinking Water Contaminant Candidate List*.

**CCTV** *Closed circuit television*.

**CDBFs** Chlorinated dibenzofurans. *See dibenzofurans*.

**CDDs** Chlorinated dibenzodioxins. *See dioxin*.

**CDFs** Chlorinated dibenzofurans. *See dibenzofurans*.

**CDI** *Chronic daily intake*.

**CEFIC** The European Chemical Industry Council. It represents the main chemical industrial companies in Europe and publishes reports on waste disposal from the chemical industrial sector.

**celerity** The overall speed of a wave.

**cell** (1) An area of a landfill site usually surrounded by bunds. The waste is tipped within the cell. Cells may be 2 to 3 m deep and typically give six months of tipping space. While one cell is being used for tipping, the previous cell can be completed with cover material placed on top of the cell. Also, the preparation for the next cell is started by building the bunds. If a further layer of waste is later placed on a completed cell, the cover material may be scraped off and reused. (2) A minute unit in the structure of living matter, consisting of *protoplasm* surrounded by a membrane or wall, e.g. a bacterial cell (*see Figure B.3*).

**cell age** *See mean cell residence time*.



- cellulose**,  $(C_6H_{10}O_5)_x$  A long chain polysaccharide made up of glucose groups. Paper, string, cotton, fibrous vegetable material, etc. all contain a high percentage of cellulose. Cellulose is only slowly biodegradable.
- cellulose acetate** A strong 'artificial silk'. It is used as a membrane for *reverse osmosis* and other *membrane processes*. It is less versatile than *polysulphone* base membranes but cellulose acetate is more chlorine resistant.
- cement based stabilisation** Waste materials mixed with cement (followed by the addition of water if necessary) to produce a cement block that locks the waste material into the solid phase. The method is often suitable for inorganic wastes, such as metal hydroxide sludges, but it may be less able to immobilise organic contaminants in the waste.
- cement mortar lining** A spinning spray head can apply a lining of cement to rehabilitate a precleaned water main or a sewer. Pipes up to 1.5 m diameter can be treated. It is a relatively low cost solution for rehabilitation but does not necessarily solve leakage problems in water mains. It may be unsuitable for water pipe rehabilitation in soft water areas as the water may be aggressive to the cement. See *ferro-cement lining*, *gunite lining*.
- cenosphere** A hollow sphere e.g. some of the ash in *fly ash*.
- centrate** Liquid removed by a *centrifuge* e.g. the water from a sludge. The centrate may have a high concentration of suspended solid. *Conditioning* of the sludge with *polyelectrolyte* or other chemicals improves the centrate quality. The centrate from dewatering wastewater sludge may have a BOD<sub>5</sub> in excess of 2000 mg/l.
- centre pivot irrigation** An *irrigation* machine that can irrigate circular areas, spraying water from a long perforated pipe, both pivoting and fed at the centre of the field and supported on wheeled carriages (towers) at suitable intervals. The largest units carry 800 m of pipe of 200 mm diameter on 20 towers. Towers are driven separately by an electric or hydraulic motor at speeds proportional to their distance from the centre, so as to keep the pipe straight and radial. Operation is continuous for about 2 months in spring and summer. The minimum time for a single rotation round a field is 12 h.
- centrifugal** Description of the effect that tends to force whirling objects away from their centre of rotation.
- centrifugal dust collector** A *centrifugal scrubber* or *cyclone* or *fan collector*, etc.
- centrifugal pump, radial flow pump** A rotodynamic pump in which a bladed *impeller* drives the water outwards so that it leaves the casing radially. The water enters the pump at the eye of the impeller. Pump casings may be either *volute* or *diffuser* types. Volute pumps are less efficient but can pump wastewaters or sludge. Diffuser pumps do not pass gross solids but are often used in multi-stage borehole or *turbine pumps*, in which the water from one stage flows into the eye of the next impeller, increasing the available head. Axial flow pumps are not centrifugal. Mixed flow pumps are partly centrifugal.
- centrifugal scrubber** A *wet scrubber* in which the gas swirls because it has been injected tangentially or has been directed around by stationary or moving swirl vanes. See *cyclonic spray scrubber*, *venturi scrubber*.
- centrifugal separator** A separator that uses centrifugal force to remove the particulates from the waste gas stream, e.g. a *cyclone* (2).

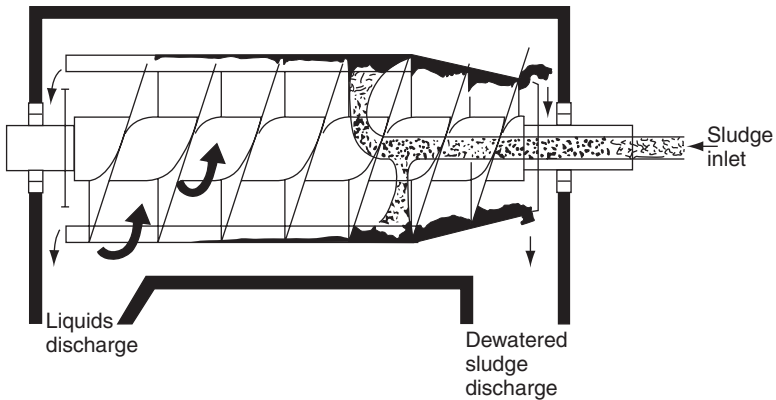

**Figure C.3** Centrifuge with solid bowl and scroll.

**centrifuge** A cylindrical vessel that by spinning separates a mixture of fluid and solid (or two fluids) within it, throwing the denser to the outside of the vessel. It is used both in the laboratory and for dewatering sludges. For **dewatering of sludge** solid bowl centrifuges are normal with either bowl conveyor or concurrent flow. In the first type (see *Figure C.3*) the bowl and the conveyor inside it are driven at different speeds. The helical conveyor pushes the sludges to one end. The **centrate** discharge is at the other end and the level of the centrate weir governs the volume of sludge in the centrifuge. With the other type, using concurrent flow, the sludge and the centrate move in the same direction, the flow of wet sludge being adjusted by a skimmer device. The sludge discharged should have less than 80% water but the centrate may be high in fine suspended solids. Centrifuges have been used to thicken sludge, particularly those that are difficult to thicken by gravity. The sludge must be conditioned (see **conditioning**) prior to dewatering or thickening. See **dense medium cyclone**, **disc centrifuge**, **imperforate basket centrifuge**.

**CEQ** The USA *Council on Environmental Quality*.

**cerceria** The final larval stage of *trematodes*.

**CERCLA, Comprehensive Environmental Response, Compensation, and Liability Act, 1980** USA legislation that gives the authority for removal of hazardous waste from **landfill** sites that have been improperly constructed or incorrectly operated. This legislation allows the authorities to remove hazardous material from abandoned or closed sites together with assistance for cleaning up emergency spills. The legislation includes authority to undertake monitoring of disposal sites including the near by groundwater. CERCLA is sometimes known as 'Superfund' due to the substantial money available in the hazardous substance response trust fund.

**CERCLIS Comprehensive Environmental Response, Compensation and Liability Information System** In the USA, an inventory of hazardous waste disposal sites that may require remedial action in the future.

**cesspit, cesspool** A tank for reception and storage of domestic wastewater. Cesspits are required to be watertight. No treatment occurs and no overflow is allowed. The cesspit must be regularly emptied by tankering away the contents.

**Cestoda** A sub-class of the *phylum* of Platyhelminthes, *flatworms*.

**CFCs** *Chlorofluorocarbons*.

**CFR** In the USA, a Code of Federal Regulation.

**CFSTR** Continuous flow stirred tank reactor. *See completely mixed reactor*.

**cfu** *Colony forming unit*.

**Chaga's disease, American trypanosomiasis** An infection with *trypanosoma cruzi*. The typical symptom is myocarditis. Humans are infected by the bite of an infected insect. The disease is confined to Mexico, Central and South America. *See trypanosomiasis*.

**chain and flight scraper** A *flight scraper*.

**chain scraper** A chain, rather than blades, that scrapes the sludge along the bottom of a *sedimentation tank*.

**chalk test, marble t.** A crude measure of the undersaturation of *calcium carbonate* in water. The sample of water is mixed with chips of chalk or marble and the loss in weight of the chips is measured, indicating the amount dissolved. From this the pH may be calculated. *See Langelier saturation index*.

**chalybeate** A description of water, especially a mineral water, in which there is so much iron dissolved that it can be tasted. *See iron in water*.

**chamber press** A *filter plate press*.

**channel flow** *Open channel flow*.

**channel storage** The volume of water in a watercourse.

**char** The black, usually crumbly, solid that remains of a substance after *pyrolysis*. The pyrolysis of wood yields charcoal.

**characteristic wastes** In the USA, a hazardous waste that is not to a *listed waste* but has properties of ignitable, corrosivity or reactivity.

**charge box** That part of a static compactor that contains the refuse during compression. *See static compaction*.

**Chartered Institute of Building Services Engineers, CIBSE** The major UK Institute associated with the engineering of the environment within a building, i.e. heating, ventilation, light, acoustics, etc.

**Chartered Institute of Water and Environmental Management, CIWEM** The major UK Institute associated with water quality, water and wastewater treatment, water pollution, pipeline management, etc. It also covers solid waste management (*see also Institute of Wastes Management*). CIWEM was formed in 1987 by the amalgamation of 3 UK professional bodies namely *IWPC*, *IPHE* and *IWES*. CIWEM publishes manuals of practice in water and wastewater treatment and introductory texts on various aspects of water pollution.

**check valve** A *non-return valve*.

**cheese manufacturing wastewater** These are mainly wash water and whey, which is acidic, with a high concentration of milk sugars. Whey has a BOD<sub>5</sub> of about 30 000 to 40 000 mg/l but this is diluted by the wash water to give a much lower overall BOD<sub>5</sub>.

**chelating** *Complexing* of a compound with a central atom (typically a metal ion) at two or more points, forming a ring structure—e.g. haemoglobin or *EDTA*.

**chemical clarification** The use of chemicals in water treatment for *coagulation* and *sedimentation* of suspended material.

**chemical conditioner** A substance used in *chemical conditioning*.

**chemical conditioning** Mixing of a chemical with sludge to increase its *de-waterability* before *mechanical dewatering of sludge*. Different sludges or mechanical dewatering techniques require different combinations of chemical.

**chemical fixation** Converting a substance chemically into one that is insoluble and no longer mobile. See *encapsulation, solidification of hazardous waste*.

**chemical indices of water pollution** See *river classification, water quality indices*.

**chemically enhanced primary sedimentation** The addition of *alum* or *lime* or ferrous sulphate to a wastewater can enhance the removal of solids to give up to 80% removal from domestic wastewater during *primary sedimentation*. The *surface loading rate* of the primary sedimentation tanks can be increased to  $50 \text{ m}^3 \text{ m}^{-2} \text{ d}^{-1}$  at maximum flow.

**chemically precipitated sludge** Sludge that is produced in a water or wastewater treatment works when *coagulation* has been used to help sedimentation or clarification of suspended matter. See *alum sludge*.

**chemical oxidation** In waste treatment, the addition of a chemical in order to oxidise an unwanted component in the air, liquid or solid waste stream. Chemical oxidation of wastes is well established and can include the destruction of a range of toxic organic molecules or inorganic compounds such as *cyanide*. See *electrolytic oxidation, ozone treatment of hazardous waste, UV/H<sub>2</sub>O<sub>2</sub>*.

**chemical oxygen demand** See *COD*.

**chemical phosphorus removal** See *phosphorus removal*.

**chemical sludge** *Chemically precipitated sludge*.

**chemical stabilisation of a pipe** A pipeline renovation method in which one or more chemicals are introduced into a length of pipe in order to seal cracks, provide a lining on the inside wall or stabilise the ground conditions around the pipe.

**chemical stabilisation of sludge** The addition of chemicals to wastewater sludge (e.g. *lime stabilisation*) in order to render the sludge relatively odour free and safe to dispose onto agricultural land (see *land application of sludge*) or to *landfill*, depending on the quality of the stabilised sludge.

**chemical toilet** The simplest chemical toilet is a bucket containing a solution of *bactericide*. More elaborate systems may include flushing to a tank and recycling of the chemicals after settling.

**chemical tracer** See *tracer*.

**chemical treatment** Various water and wastewater treatments involve the addition of chemicals—e.g. for the *coagulation* of water, occasionally of wastewater; *pH* adjustment; *precipitation of heavy metals*, often as hydroxides; precipitation of phosphates; *disinfection* by *chlorine* or *ozone*; *conditioning* of sludge; *water softening* etc.

- chemical treatment of contaminated land** The use of chemicals to treatment and clean up contaminated land. These include *stabilisation, encapsulation, phosphate remediation, soil flushing* and *treatment walls*.
- chemical treatment of hazardous waste** Hazardous waste may be treated by neutralisation, *chemical oxidation* (e.g. *ozone treatment of hazardous waste*) precipitation or chemical reduction. *See encapsulation, stabilisation, physical chemical treatment of hazardous waste*.
- chemisorption** *Adsorption* by chemical bonding onto the surface of the adsorbent.
- chemoautotroph** A *chemotroph* that uses carbon dioxide as its carbon source—e.g. *nitrifying bacteria*.
- chemoheterotroph** A *chemotroph* that uses organic material as its carbon source—e.g. *Sphaerotilus natans*. Chemoheterotrophs include all animals and fungi.
- chemolithotrophs** Micro-organisms that use an oxidation reaction as the energy source and inorganic carbon as the source of carbon.
- chemoorganotroph** Micro-organisms that use an oxidation reaction as the energy source and organic compounds as the food source.
- chemosynthesis** (adjective **chemosynthetic**) A method by which micro-organisms, including *chemotrophs*, obtain energy. They use the chemical energy of inorganic or organic materials (but not *photosynthesis*) to build up their organic matter.
- chemotaxis** *See taxis*.
- chemotroph** An organism that uses *chemosynthesis*, not *photosynthesis*, to build itself up, using the energy from chemical processes. Chemotrophs may be either *chemoautotrophs*, using carbon dioxide as a source of carbon, or *chemoheterotrophs*, using organic carbon.
- Chilodonella** A *ciliate protozoon* commonly found in *trickling filters* and in *activated sludge* plants that have a satisfactory sludge.
- chimney** (1) A pipe, usually vertical, of masonry, metal, fibre glass, etc., that discharges flue gases, smoke or other air pollutants at a level high enough for them not to offend people in surrounding buildings or on the ground below. (2) A term for a *back drop*.
- chimney effect** Hot air rises up a chimney because it is warmer and therefore lighter (more buoyant) than the air outside. This *natural draught* can occur away from chimneys—e.g. in lift shafts or stair wells, which in large buildings are subject to special fire regulations. *See effective chimney height*.
- chimney height** *See effective chimney height, plume dispersion*.
- chipper** A *shredding* machine used to reduce tree stumps to chips about 5 cm long and 1 cm diameter. The chips can be used as a mulch in gardens or for covering paths or for making paper or fibreboard.
- chironomid, Chironomidae** Non-biting midges whose *larvae* are *blood worms*. The larvae of *Chironomus riparius* live in wastewater polluted mud and can be used in a *biotic index*.
- Chlamydomonas** A flagellate green alga usually found in *eutrophic* water, including *waste stabilisation ponds*, tinting it green. *See flagellum*.
- chloracne** A skin disorder that can be caused by exposure to toxic chlorinated organic compounds. The skin appears to be suffering from acne.

**chloramination** The use of *chloramines*, particularly monochloramine (NH<sub>2</sub>Cl) for water *disinfection*. Chloramine is a weaker disinfectant than chlorine, but more stable. The main benefit of chloramination is that the chloramine is less reactive with organic material and the production of *disinfection by-products* is substantially reduced. Also, the lack of reaction with organics may produce fewer taste and odour problems in the water. Another benefit is the long time that the chloramine exists in the water, thereby giving protection for many hours in the distribution system. See *Table D.2 Drinking water standards*.

**chloramines** These chemicals are monochloramine (NH<sub>2</sub>Cl), dichloramine (NHCl<sub>2</sub>) and trichloramine (NCl<sub>3</sub>). They can be formed in *chlorination* of water by the reaction between the chlorine and ammonia. The mono- and di-chloramines are the most common. In swimming pools, the chloramines are one of the main reasons for eye irritation. See *chloramination, combined residual chlorine, Table D.2 Drinking water standards*.

**chlordane** A *cyclodiene* insecticide that is probably carcinogenic to humans. It can undergo biomagnification in food chains. The *USEPA* states a *MCL* in drinking water of 2 µg/l and the WHO guideline maximum value is 0.2 µg/l. The EU Drinking Water Directive states a mandatory maximum of 0.1 µg/l.

**Chlorella** A unicellular *green alga* which is often the dominant alga in *waste stabilisation ponds*, since it tolerates temperature variations and can exist for limited periods in *anaerobic* conditions. *Chlorella* can grow well in the dark using *chemosynthesis*.

**chlorfenvinphos** An insecticide that was widely used to control household pests such as flies and mice. It is toxic to humans with the main effect on the nervous system. The EU lists it as a *priority substance* in relation to aquatic discharges.

**chloride, Cl<sup>-</sup>** Chlorides are not removed during water or wastewater treatment unless it includes *desalination*. Since chloride in the form of NaCl is eaten by humans and excreted in the urine to the extent of about 6 g per adult daily, the chloride content of water increases with each reuse, by about 50 mg/l. Chloride can be tasted at 500 mg/l, sometimes at half this level by those with a sensitive palate. Some rivers have 20 to 80 mg/l but others may have only 1 to 5 mg/l. In natural waters, chlorides can occur from the leaching of chloride-containing rocks. High chloride content may indicate also that fresh water is being polluted by *saline intrusion*. See *brine, Table D.2 Drinking water standards*.

**chlorinated acetic acids** A range of chemicals that have between one to three chlorine atoms substituted into acetic acid CH<sub>3</sub>COOH. See *haloacetic acids*.

**chlorinated alkanes** *Chloroalkanes*.

**chlorinated alkenes** *Chloroalkenes*.

**chlorinated aromatic compounds** A range of organic compounds that may be highly toxic. They include *dioxins, polychlorinated biphenyls* and *dibenzofurans*.

**chlorinated benzenes** A range of chemicals that have between one to six chlorine atoms substituted into one benzene ring. They are used in industry for a range of purposes and they have been used as pesticides. They are toxic to humans giving different health problems such as carcinogenicity and adverse effects on the nervous system, liver and kidneys. The *USEPA MCL* in drinking water varies depending on the chemical, with the lowest being 1 µg/l for hexachlorobenzene.

**chlorinated copperas** A mixture of *ferric chloride* and ferric sulphate, written as FeClSO<sub>4</sub>, used as a *coagulant* for raw water and for *conditioning* sludge. It is usually made on site by oxidising ferrous sulphate (*copperas*) solution with the feed from a *chlorinator*. A disadvantage of its use in drinking water is the possibility of residual *iron in water*.

**chlorinated dibenzodioxin** See *dioxin*.

**chlorinated dibenzofurans** See *dibenzofurans*.

**chlorinated ethylenes, c. ethenes** *Chloroethenes*.

**chlorinated hydrocarbons** Organic compounds consisting only of *chlorine*, hydrogen and carbon—e.g. *DDT*, *polychlorinated biphenyls*. See *chlorinated benzenes*, *chloroethanes*, *chloroethenes*.

**chlorinated solvents** Organic solvents that contain chlorine atom(s), such as trichloroethene (trichloroethylene) and trichloroethane.

**chlorination** Addition of chlorine to water, usually for disinfection. Chlorine is a yellow green corrosive gas but it can be liquefied under relatively low pressure. It is soluble in water undergoing the reaction:

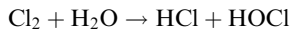

Hydrochloric acid (HCl) is not a disinfectant. The disinfecting agent is hypochlorous acid which readily dissociates thus:



The relative amount of the acid or the ion is dependent on the pH, being 95% HOCl at pH 6 and 95% OCl<sup>-</sup> at pH 9. Hypochlorous ion (OCl<sup>-</sup>) is much less effective as a disinfectant and therefore it is desirable for chlorination to keep the pH of the water below 7, although other considerations, such as corrosion control, may make it more desirable to supply a water with a high pH. In practical chlorination of large scale water supplies, a minimum of 30 minutes contact time should be allowed before the water enters distribution. The dose may be from 1 mg/l of chlorine to more than 5 mg/l. Taste problems can occur at high chlorine doses. Chlorination kills almost all the bacteria but is less effective for virus and protozoa. A major problem with chlorination is the formation of *disinfection by-products*. The *USEPA* states a *MRDL* for chlorine in drinking water of 4 mg/l. The WHO maximum guideline value for chlorine in drinking water is 5 mg/l. Chlorination has been used for wastewater effluent disinfection where dosage rates may be 10 to 20 mg/l. However, this can give a problem with *chlorine residuals* in the effluent

- going into the river or sea. See *breakpoint chlorination, chloramines, combined residual chlorine, dechlorination, hypochlorination, superchlorination.*
- chlorinator** Equipment used at waterworks for dissolving *chlorine* in water and adding it in the right proportion to the water supply.
- chlorine, Cl<sub>2</sub>** The commonest *halogen*, a poisonous gas used in *chlorination* because it is cheap and easily available.
- chlorine demand** The amount of *chlorine* consumed by a certain volume of water in a certain time.
- chlorine dioxide, ClO<sub>2</sub>** An unstable gas which is a strong oxidising agent and has been used as a water or wastewater disinfectant. It has a major advantage over chlorine in that it does not react with organics to produce *trihalomethanes* nor react with ammonia to form *chloramines*. Chlorine dioxide can be used to assist in the removal of taste and odour. It leaves a relatively persistent residual. Chlorine dioxide is usually generated on-site by reacting chlorine with sodium chlorite. It is highly reactive and explosive requiring care in handling.
- chlorine residual, available chlorine** Chlorine that exists in water either as *hypochlorite* (free residual chlorine) or in combination with other substances—in particular, ammonia—as *combined residual chlorine*. See *breakpoint chlorination, chlorination, residual disinfectant.*
- chlorite ClO<sub>2</sub><sup>-</sup>** This chemical can be formed as a *disinfection by-product* particularly when chlorine dioxide is used as the disinfectant. It can cause anaemia and affect the nervous system. See *Table D.2 Drinking water standards.*
- chloroacetic acid** See *haloacetic acids.*
- chloroalkanes** Chemicals of the group ethane, propane, butane, etc. which have one or more chlorine atoms substituted into the molecule, e.g. *chloroethanes*. The EU list chloroalkanes with 10 to 13 carbon atoms (C10–13) as *priority hazardous substances* in relation to aquatic discharges.
- chloroalkenes** Chemicals of the group ethene (ethylene), propene (propylene) etc. which have one or more chlorine atoms substituted into the molecule, e.g. *chloroethenes*.
- chlorobenzene** See *chlorinated benzenes, monochlorobenzene.*
- Chlorobiaceae** (also **Chlorobacteriaceae**) *Photosynthetic*, green *sulphur oxidising bacteria* that use carbon dioxide as their carbon source. They may oxidise sulphur or sulphides in *anaerobic* conditions in sunlight but they do not release oxygen. They proliferate in stagnant pools and waters containing *hydrogen sulphide*. Water containing them looks green.
- chloroethanes** A range of chemicals that have between one or more chlorine atoms substituted into the ethane molecule (CH<sub>3</sub> – CH<sub>3</sub>). They are used in industry for a range of purposes including industrial solvents. Some are carcinogenic to humans and others adversely affect the nervous system. Trichloroethane is an ozone depleting substance and is banned in the EU. See *1,2-dichloroethane, trichloroethane.*
- chloroethenes, chloroethylenes, chlorinated ethenes** A range of chemicals that have between one to four chlorine atoms substituted into the ethene (ethylene) molecule (CH<sub>2</sub> = CH<sub>2</sub>). They are used in industry for a range of purposes including industrial solvents. Tetrachloroethene, C<sub>2</sub>Cl<sub>4</sub>, (per-



chloroethylene) is commonly used in dry cleaning. Chloroethenes can be toxic to humans giving different health problems such as carcinogenicity and adverse effects on the nervous system, liver and kidneys. For drinking water standards see *dichloroethenes, trichloroethene, tetrachloroethene* and *vinyl chloride* (monochloroethene – the monomer of PVC).

**chlorofluorocarbons, CFCs** Man made compounds that contain chlorine, fluorine and carbon, e.g. CFC-11 (trichlorofluoromethane, CCl<sub>3</sub>F) and CFC-12 (dichlorodifluoromethane, CCl<sub>2</sub>F<sub>2</sub>). They have been extensively used as refrigerants and aerosols. UV light causes chemical decomposition (photolysis), releasing the chlorine which rises upwards in the atmosphere to damage the ozone layer. See *hydrochlorofluorocarbons, hydrofluorocarbons*.

**chloroform, CHCl<sub>3</sub>** *Trichloromethane*.

**chloromethanes** See *halomethanes*.

**chloroorganic compounds** *Organochlorine compounds*.

**chlorophenols, chlorphenols, chlorinated phenols** Organic compounds with one to five chlorine atoms added to phenol. They have a wide range of industrial uses and have been used as antiseptics. They have a medicinal taste, even at low concentrations in water. They have a range of toxic effects on humans including acne and effects on the liver.

**Chlorophenothane** Another name for *DDT*.

**chlorophenoxyacetic acids** Two chemicals in this group have been extensively used as herbicides; *2,4,5-T* (2,4,5 trichlorophenoxyacetic acid) and *2,4-D*, (2,4 dichlorophenoxyacetic acid). They are toxic to humans affecting the human nervous system, liver and kidneys. 2,4-D was used with 2,4,5-T, as a defoliant in *agent orange* in the Vietnam War. MCPA is dimethyltetrachlorophenoxyacetic acid which has been used as a herbicide.

**chlorophenoxy herbicides** A group of persistent herbicides that include *chlorophenoxyacetic acids, 2,4-DB, dichlorprop, MCPB, mercoprop, 2,4,5-TP* (Silvex).

**chlorophyll** The green pigment found in plants, algae, etc. that is involved in photosynthesis. The concentration of chlorophyll in the water can be used as a measure of the number of algae in the water.

**Chlorophyta** The *green algae*.

**chloroplast** The part of the plant cells that contain chlorophyll and where photosynthesis occurs.

**chlorosis** The bleaching of the plant surface. This can occur due to prolonged exposure to *sulphur dioxide*.

**chlorpyrifos** An insecticide that may be used to control fleas, cockroaches, etc. It is toxic to humans with the main effect on the nervous system. The EU lists it as a *priority substance* (under review for possible re-grading as a priority hazardous substance) in relation to aquatic discharges.

**chocolate mousse** (1) Water in oil *emulsion* naturally emulsified at sea from viscous oil. It has up to 70 or 80% water and is very stable, less *biodegradable* than oil, not easily removed by *emulsifiers* and difficult to burn, even with a flame thrower. On the beach it forms tarry lumps as solids are picked up and water slowly evaporates. (2) See *foaming* (2).

**cholera** A serious intestinal disease caused by the bacterium *Vibrio cholera*.

If untreated, the mortality rate is in excess of 50%. Effective treatment reduces this to below 1%. Death may occur within a few hours of the appearance of symptoms. Although at one time occurring worldwide, it is now mainly confined to tropical areas except for isolated cases in travellers. It is transmitted by faecal contamination of water or possibly food. The disease is probably limited more by provision of clean water and proper sanitation than by medical measures. Carriers of the disease may persist in passing the bacteria for many months.

**CHP** *Combined heat and power.*

**Chromatiaceae, Thiobodaceae** *Photosynthetic*, purple, *sulphur oxidising bacteria* that obtain their carbon from carbon dioxide, although they do not release oxygen. They may oxidise sulphur or sulphides in *anaerobic* conditions in sunlight. They occur in similar conditions to *Chlorobiaceae* and may give a strong red colour to water.

**chromatogram** The graphical output from a chromatographical device as in *gas chromatography* or *HPLC*. The output shows peaks related to the retention time of the compound in the instrument. These peaks can be related to standard chromatograms that have been obtained for that instrument and thereby identify the compounds in the sample. The peak height or area on the chromatogram is a quantitative measure.

**chromatography** *See gas liquid chromatography, HPLC.*

**chrome tanning** *See tannery wastewater.*

**chromium** *See Table D.2 Drinking water standards, hexavalent chromium.*

**chronic** Long-lasting.

**chronic daily intake, CDI** The intake of a particular substance usually expressed in mg of toxic substance per kg of body weight per day.

**chronic toxicity** A toxic effect where the symptoms may be initially indistinct and the full effects of the exposure to the toxic substance may occur after a substantial time delay. *Compare acute toxicity.*

**chrysene** *See polycyclic aromatic hydrocarbons.*

**Chrysophyta** A *phylum* of yellow-green algae of many diverse forms that includes *diatoms*.

**chute fed incinerator** An *incinerator* provided with both a *flue* and a separate chute, so called to distinguish it from the *flue fed incinerator*.

**Ci** *Curie.*

**CIBSE** *See Chartered Institute of Building Services Engineers.*

**cilia** (singular **cilium**) Minute hairs on micro-organisms that enable them to move gently.

**ciliate protozoa, Ciliophora** *Protozoa* with hairs (**cilia**) that help them to move. They are common in *trickling filters* or 'healthy' *activated sludges*. Unsatisfactorily activated sludges contain few ciliates. They may swim freely in the liquid or they may be stalked (*peritricha*), with a stalk attached to solid matter in the liquid. *Peritricha* often form colonies.

**CIPP** Cured in place pipe. *See soft lining.*

**circle of influence** *Cone of depression.*

**circular sedimentation tank, c. clarifier** A *radial flow sedimentation tank* or, possibly, an *upward flow sedimentation tank*.

**cistern** (1) A water tank may be installed in the roof space or attic on a building. It should be covered to stop pollution of the water. Many countries do not have cold water storage tanks in domestic houses and all the hot and cold appliances are fed from mains. In the UK cold water storage is common. A house in the UK has typically 230 l of covered cold water storage, which is enough to cover several hours interruption to supply. The overflow pipe must be visible to the householder so that any problems with the ball valve in the cistern is apparent. The advantages of a hot and cold water system that is supplied from the cistern include lower pressure in system, less wear on appliances and the hot water system can be vented to the cold water tank. However, a main disadvantage is the possible contamination in the water supplied from the storage tank. It is cheaper not to have cold water storage. (2) A *flushing cistern*.

**civic amenity site** A waste collection site where public can leave bulky items of waste, often free of charge.

**CIWEM** *Chartered Institute of Water and Environmental Management*.

**clack valve** A *non return valve*.

**Cladiphora, blanket weed** Stringy green algae that mat into a green blanket, commonly found in nutrient rich waters.

**clarification** The settling out of suspended solids or colour from a water or wastewater usually preceded by *coagulation and flocculation*. *Sedimentation* is clarification of a water or wastewater that has greater quantities of suspended solids. The terms clarification and sedimentation are sometimes used synonymously. *See* below.

**clarifier** In water treatment, a clarifier is a tank used to separate out the solid material from the water, normally after *coagulation* and *flocculation* and before a *rapid deep bed filter* or other type of filtration such as a *slow sand filter*. Various types exist, normally based on *solids contact clarifier* (e.g. *sludge blanket clarifier, Figure S.7* and *solids recirculation clarifier, Figure S.12*). Smaller or older treatment works may have one pass *flocculator clarifiers*. The performance of the clarifiers may be upgraded by the use of *inclined plate and tube settlers*. In wastewater treatment, a clarifier is synonymous with *sedimentation tank*.

**clarify** Of water or wastewater, to remove the turbidity or suspended matter or colour and to make it clear.

**Clarke** *See degree Clarke*.

**class** A division in *taxonomy* between phylum and order.

**classification** (1) Of living creatures, *taxonomy*, (2) Of a bulk material, its division into different particle size grades with a *screen, trommel* or other *classifier*.

**classifier** Any device used in *mineral dressing*, or the cleaning of gravel, grit, sand, etc., that separates the material into grains of two or more sizes. The simplest is a dry *screen* (sieve), but many are wet—e.g. *screw classifiers, wet cyclones*. In wastewater treatment a classifier may be a device that

separates organic solids from grit e.g. a *reciprocating arm grit washer*. In the mechanical sorting of refuse, *trommels* may be used for primary classification, with holes of about 20 cm. See also *air classification*.

**Claus process** Extraction of the element sulphur from the gas *hydrogen sulphide* ( $H_2S$ ) by passing it mixed with air at about  $150^\circ C$  over an iron or bauxite *catalyst*. The exhaust gas (tail gas) may contain  $SO_2$ ,  $H_2S$ , S, COS (carbonyl sulphide) and  $CS_2$  (carbon disulphide).

**clay liner** Clay can be used as a *landfill liner* or as an impermeable cap to the landfill site. One metre of well compacted clay has a permeability of less than  $10^{-9}$  m/s. See *geosynthetic clay*.

**CLBs** *Cyanobacteria*-like bodies.

**CLEA** *Contaminated Land Exposure Assessment*.

**Clean Air Act, CAA** In the USA, major pieces of legislation passed in 1963 and 1970 that allowed direct federal intervention to control interstate air pollution. The legislation required the *USEPA* to investigate the effects of any air pollutant.

**Clean Air Act 1991 and 1993** Major pieces of UK legislation that draw together many pieces of the previous legislation on air pollution and extends the scope of air pollution legislation. They control the visible pollutants (dark smoke, grit and dust) from combustion processes. Other aspects of air pollution control in the UK are covered in the *Environmental Protection Act 1990* and the *Environment Act 1995*.

**Clean Air Act Amendments, CAAA** In the USA, a number of amendments to the original Clean Air Act have been introduced. The 1970 amendments produced the *National Ambient Air Quality Standards* (NAAQS). The 1977 amendments produced the *National Emission Standards for Hazardous Air Pollutants* (NESHAP).

**Clean Water Act, CWA** Major USA legislation passed in 1972 that set national water pollution goals. Each point discharge has to comply with specific effluent limits. A number of amendments and enhancements have been passed, including the *Water Quality Act 1987*.

**clear water storage, clear well** Storage of treated water prior to supply e.g. in a *service reservoir*.

**cleated conveyor** A rubber belt conveyor to which upstanding cross-strips (cleats) of metal or rubber are riveted or welded, enabling it to carry material up steep slopes. An ordinary smooth rubber belt cannot carry material up a slope steeper than  $18^\circ$  to the horizontal. A cleated belt can occasionally raise material up a slope as steep as  $60^\circ$  to the horizontal.

**cleated wheel tractor** A *steel wheeled compactor*.

**climax community** The final shape of a community after it has gone through many stages. See *ecology*.

**clingage** Oil that clings to the sides, top and bottom of the bunkers and oil tanks of ships, and is washed out with *oil tanker washings*.

**clinical waste** Waste that derives from hospitals and similar Institutions that contain tissue, body fluids, drugs, needles, etc. It may be chemically hazardous and infectious. It should be incinerated although small volumes are being treated by a variety of thermal non-burn treatments, e.g. microwaves.

**clinker** Stony, sharp, furnace bottom ash that has partly melted, unlike *slag*. 'Clinkering' may mean either the formation of clinker in the furnace or its removal. After cooling and sizing, clinker can be sold as builder's fill or for roadmaking or as *cover* at a *landfill* site.

**clinoptilolite** A natural *zeolite* that has been used for *ion exchange* of ammonia. The zeolite adsorbs ammonia and can be regenerated by passing a saturated solution of *lime* plus sodium chloride over it. If clinoptilolite is used as the main method of ammonia removal, the ammonia can be extracted from the *regeneration* liquor in a small stripping tower. Traces of ammonia in the effluent from the clinoptilolite may have to be removed by *breakpoint chlorination*.

**closed circuit television, CCTV** This technique can be used to view water pipes or sewers *in situ*. The CCTV camera is positioned on a remotely operated vehicle and can inspect up to 16 km of pipe per day. When used in water pipes, the pipes must be taken out of service and drained. After inspection the pipes are disinfected before recommissioning. The CCTV rig can be difficult to manoeuvre along sewers that have substantial quantities of debris and detritus.

**closed composting system** A variation of the *aerated static pile* in which the composting waste is enclosed and air is passed over the top of the compost and blown up through the compost.

**closed recirculation system** An industrial cooling system like that of the car engine, which should need no water once the system has been filled and consequently wastes less water than either the *open recirculating system* or *once through cooling*. It also cannot cause *thermal pollution* of receiving water.

**closed water circuit** A chemical plant, coal washery, etc., with *zero discharge layout, closed recirculation system, etc.*

**close fit lining, modified sliplining** A method of water pipe rehabilitation in which tight fitting liners are inserted into the existing pipe. For non-structural use, the liner is commonly a thin wall *polyethylene* pipe. After insertion, the liner is pressurised to provide a close fit. The host pipe must be clean and in good condition. This technique has been used for lining mains up to 1.6 m diameter. The technique can assist in eliminating leakage. Long pulls can be achieved and so excavation is minimised. For structural use, the liner can be made from high tensile woven polyester. In this case the inserted pipe is pressurised after placement with steam in order to form a close fit. *See sliplining.*

***Clostridium*** A genus of anaerobic bacteria some of which can cause such diseases as botulism and tetanus. *See below.*

***Clostridium perfringens, C. welchii*** An anaerobic bacterium of faecal origin that has *endospores* that may survive boiling and outlast *Escherichia coli* in water. In the dry state the *spores* may last indefinitely. Their presence in water almost certainly indicates faecal pollution at some time or place. *See coliform group.*

**cloth binding** The clogging by fine material of a *screen* or *filter* cloth.

**cloth filter** A *fabric filter*.

**CMR** *Completely mixed reactor.*

**CNP ratio, C:N:P ratio** *The carbon:nitrogen:phosphorus ratio.*

**coagulant** A chemical added to water (or wastewater) in order to achieve *coagulation.*

**coagulant aid** Many substances, such as activated silica, stone dust, *polyelectrolytes*, clays, are added as suspensions or solutions in water to help *coagulation.*

**coagulation** The addition of a chemical to water or wastewater to form a precipitate (usually a metal hydroxide) that entraps or adsorbs unwanted material such as suspended particles, colloids, colour etc. Many of these unwanted substances have slight negative charges and so the coagulant is often a metal salt solution, such as a solution of *alum*. The alum reacts with the alkalinity in the water and forms a range of complex aluminium hydroxide precipitates which have positive charges. Any coagulant must form *flocs* that can be readily settled or floated from the water. *Ferrous salts* and ferric salts are less common for coagulating raw water, because of the hazard of leaving residual *iron in water*. *Polyelectrolytes* also may be added in small quantities as a *coagulant aid.*

**coal carbonisation (or carbonization)** wastewater *Coke plant wastewater.*

**coal industry wastewater** Two main sources of water pollution are *acid mine drainage* and coal washery wastes. *Deep cone thickeners* and other devices can reduce the bulk of the washery wastes and enable washery water to be re-circulated. In washeries the dirty water is clarified and recirculated in the plant, except for the small proportion that leaves in the form of moisture on the coal or on the reject to the tip. Black water drained from colliery tips has been greatly reduced by grassing the tips and by maintaining gentle surface slopes not steeper than 1 in 6 or so to the horizontal.

**coarse bubble aeration** *Aeration* through pipes with large holes or an open end, producing large bubbles, generally above 2 mm diameter. The pipe is near the surface of the water and a low pressure blower can be used. Even in de-oxygenated water, only about 5% of the oxygen supplied is dissolved. This means that a supply of 100 m<sup>3</sup> of air at 760 mmHg dissolves only about 1.5 kg of oxygen in deoxygenated water and even less in *mixed liquor*—about 0.8 kg. *See oxygenation efficiency.*

**coarse filter** A *roughing filter.*

**coarse screen** In water and wastewater treatment, a *screen* that uses parallel bars to remove large solids from a water or wastewater. The gap between the bars is between 30 to 50 mm. The bars are about 20 mm diameter.

**coarse to fine filtration** Filtration of a water through a *rapid deep bed filter* in which the water approaches the coarse media first. Larger solids are thus filtered out by the coarse media, while further into the filter the finer solids are filtered out by the finer media. This enables more of the bed to be used effectively. Examples include *dual media filter* and *multi-media filter*. The **B2A** process is a type of backwash *biological aerated filter* that uses upward flow through three different sizes and layers of media so that coarse to fine filtration is achieved.

**coastal waters** The EU defines coastal waters as 1 nautical mile on the seaward side from the nearest land. It has set the acceptable standard for a range of physical, chemical and microbiological quality parameters for coastal waters in the EU. They are included in the *Bathing Water Directive 1976*, *Nitrate Directive 1991*, *Shellfish Directive 1979*.

**coccus** A spherical *bacterium*.

**CoCoDAFF, counter current dissolved air flotation and filtration** A water treatment process where the *dissolved air flotation* (DAF) unit is situated above the *rapid deep bed filter*. The counter current is because the water is flowing down through the DAF section of the process while the air bubbles move up.

**co-composting** The composting of wastewater sludge with solid waste, typically in the ratio of 1:2.

**COD, chemical oxygen demand, dichromate value** The COD of a natural or waste water is measured by a test involving a strong oxidising agent. A boiling mixture of concentrated sulphuric acid and potassium dichromate ( $K_2Cr_2O_7$ ) is the standard reagent, together with a catalyst, silver sulphate. Mercuric sulphate may also be added to combine with chlorides which otherwise would precipitate the silver catalyst as silver chloride. The test can be completed in 2 h—much more convenient than the 5 days of the BOD test. The COD value is normally higher than the BOD value because more organics can be oxidised by these chemicals than are biodegradable in the BOD test. A high COD: BOD<sub>5</sub> ratio for an industrial waste may indicate the presence either of organics that are hard to biodegrade or of toxic material inhibiting the BOD results. A typical domestic wastewater may have a COD of about 500 mg/l. The EU effluent standard is 125 mg/l for domestic wastewater treatment. Because the COD test contains silver salts and usually mercury salts, the spent liquid at the end of the test is categorised as hazardous waste. *See hard COD, permanganate value.*

**co-disposal** The disposal of solid and liquid waste (or sludges) at the same *landfill* site. The term may also be used to describe the joint disposal of hazardous and non-hazardous waste at the same site, or, the joint disposal of domestic and industrial waste. The EU *Landfill Directive, 1999* bans most co-disposal, although some exceptions are allowed, e.g. the co-disposal of non-hazardous waste and solidified, non-reactive, hazardous waste is allowed.

**coefficient of haze, COH, smoke shade** A US way of measuring the smokiness of air. It is estimated from the darkness of a 1 cm spot on a filter paper through which 304.8 m<sup>3</sup> (1000 ft) of air have been drawn.

**coefficient of uniformity** *See uniformity coefficient.*

**coenzyme** Any one of many organic and inorganic substances essential to the activity of an *enzyme*.

**co-flow scrubber** A *wet scrubber* in which the liquid enters at 90° to gas flow, e.g. a *venturi scrubber*.

**COHb** *Carboxyhaemoglobin.*

**coil filter** *See vacuum filter.*

**co-incineration** The *incineration* of a blend of waste material such as dried wastewater sludge with solid waste.

**coke bed furnace** See *sludge melting*.

**coke plant wastewater** The distillate from the making of coke separates into two layers: a dense tarry layer from which many useful materials are made; and a lighter layer, the *ammoniacal liquor*, which is highly polluting. The tar is separated and cooled. The cooling water contains *phenols*. The quenching of red hot coke after it has been pushed from the oven produces a water with coke particles that are recovered by *sedimentation*. See *spent liquor*.

**cold digestion** *Anaerobic sludge digestion* in a tank that is not heated and will operate at a temperature of 5 to 20 °C. It is suitable only for small wastewater treatment works, because of the unavoidably long retention time. The gas is not collected and the tanks may be open.

**cold end corrosion, low temperature corrosion** Corrosion of boiler metal at temperatures below about 230 °C, caused by acid *condensation* in the passages. See *incinerator corrosion*.

**cold water storage** See *cistern*.

**Colebrook-White formula** A complex equation to determine flows in pipes, sewers and channels. It can be used for open channel flow and pipe flow. Solutions are published in the Wallingford tables.

**Coleoptera** The beetles and weevils.

**coliform count** An estimation of the bacterial purity of a water by the number of bacteria from the *coliform group* per ml. The three current methods of laboratory testing are: the *most probable number*; *plate counts*; and *membrane filtration*. The *USEPA* states that no sample should contain any coliforms for 95% of drinking water samples. The corresponding WHO guideline maximum value is zero coliforms per 100 ml sample for 95% of the samples. The EU Drinking Water Directive states a non-enforceable indicator parameter of zero coliforms per 100 ml sample (or per 250 ml sample if the water is bottled).

**coliform group, coliforms, coli-aerogenes group** Bacteria that exist in soil and in the intestines of animals and birds. Each person excretes many billions of coliform organisms daily, most of them harmless. Coliforms are used as an indicator because their presence is taken to show the presence of faecal contamination of the water. See *Escherichia coli*.

**coliphage** Any *virus* that reduces *Escherichia coli* (q.v.).

**collection vehicle, refuse v., sanitation v.** A vehicle that collects refuse. It should be closed and may have automatic loading for wheeled bins. See *compactor truck*.

**collector sewer, collecting s., lateral s.** A branch sewer located in the street that collects the wastewater discharged through building sewers (house drains). The collector sewer probably feeds into the large *interceptor sewer* or *trunk sewers*.

**Collembola** *Springtail*.

**colliery spoil, minestone** Stone or washery waste from coal mines. See *spoil heap*.

**collision scrubber** A *wet scrubber* in which water or an appropriate aqueous solution is sprayed into the effluent gas which subsequently flows onto a



- solid surface. The water droplets collide with the surface and fall out of the gas stream.
- colloids** (adjective **colloidal**) Particles smaller than 0.002 mm but larger than 0.000 001 mm (1 nanon). Colloids may be removed from water by *coagulation*. Colloidal systems include some *emulsions*. See *surface charge*.
- colony count** See *plate count*.
- colony forming unit** A cluster of cells which grow on culture *medium* and produce a single colony. See *plate count*.
- color** The USA spelling of colour.
- colour in water** Natural brown colour that can occur in water derives from the dissolution of long chain organic molecules (humic and fulvic acids) from soil, particularly peaty soils. The brown colour in water is measured by the *platinum cobalt scale*, formerly known as Hazen units.
- Colpidium** A free swimming *ciliate protozoon* found in *trickling filters* and *activated sludge* plants, especially those with a poor quality effluent.
- combined aerobic process** A biological treatment of a wastewater that uses a combination of a *suspended growth process* and an *attached growth process*. See *activated biofilter*, *biofilter-activated sludge process*, *biological aerated filter*, *trickling filter-activated sludge process*.
- combined heat and power system** *Waste to energy plants* that use the recovered heat for both electricity generation and district heating systems.
- combined residual chlorine, c. available chlorine.** The weak disinfectants,  $\text{NH}_2\text{Cl}$  (monochloramine),  $\text{NHCl}_2$  (dichloramine) and  $\text{NCl}_3$  (trichloramine or nitrogen trichloride), that are formed in water by *chlorination* when chlorine reacts with ammonia. Whether one of these is formed rather than another depends on *pH*, with  $\text{NCl}_3$ , for example, existing significantly only at pH below 4.0. At high pH only monochloramine is formed and at pH 7.0 monochloramine and dichloramine are found in about equal proportions. Compare *chloramination*, *free residual chlorine*.
- combined sewer, c. sewer system** In the combined system of *sewerage* one sewer pipe carries both the storm water and the wastewater, domestic or industrial, unlike the *separate system*, with its two sewers. The storm flows may reach many times the *dry weather flows* and exceed the capacity of the sewer (or the treatment works). Consequently, combined sewers are provided with *combined sewer overflows* that send diluted domestic wastewater into a *stormwater sewer* and thence into the nearest river. With the separate system the stormwater discharged directly into the river is less polluted. The combined system is, however, cheaper to build.
- combined sewer overflow, CSO, stormwater overflow** In a *combined sewer* system or *partially separate* sewer system, an overflow structure, such as a *side weir overflow* (see *Figure S.6*), that diverts excess wastewater flow away from the sewer. This occurs in periods of heavy rain. The diverted wastewater flows down a *stormwater sewer* and is discharged elsewhere, probably direct to the receiving water. In this situation, the diluted untreated wastewater may cause pollution. As little of the solid material as possible should be allowed to flow over the CSO so that the solids continue in the wastewater flow to the treatment facility. A common

reason for the need of CSOs is the wastewater flow exceeding the capacity of the sewer during periods of heavy rain. *Sustainable urban drainage* (SUDS) is a method used to try and minimise stormwater flows. See also *baffled side weir, leaping weir overflow, stilling basin 2, tank sewer*.

**combined sewer overflow screens** *Combined sewer overflows* have *screens* through which the overflow wastewater passes. *Bar screens* may be used but they may not be as successful in removing solids as *mesh screens* typically using a 6 mm opening.

**combined water** Water chemically held in a compound—e.g. the water in alum crystals. See *bound water*.

**combustion by-products** See *products of incomplete combustion*.

**combustion plants** See *incinerators*.

**commensalism** The steady co-existence of various species together in particular locations in which one receives benefit but the other is not harmed. Compare *symbiosis*.

**commercial waste** Waste from premises that are used for trade and business, such as offices and shops.

**comminution** Size reduction, usually by a *mill*.

**comminutor** In wastewater *preliminary treatment*, a cylindrical screen with a *shredder* inside that cuts up the solids caught on the screen (see *Figure C.4*).

The grit in the wastewater can quickly blunt the shredder and they have been found to require high maintenance and are therefore not often used.

**common water flea** *Daphnia magna*.

**COMMPS procedure** Combined monitoring based and modelling based priority setting. The method adopted in the EU *Water Framework Directive, 2000* for establishing *priority substances*.

**communication pipe** The water pipe that connects the water main to the edge of the property of the household or building. In the UK the pipe is owned

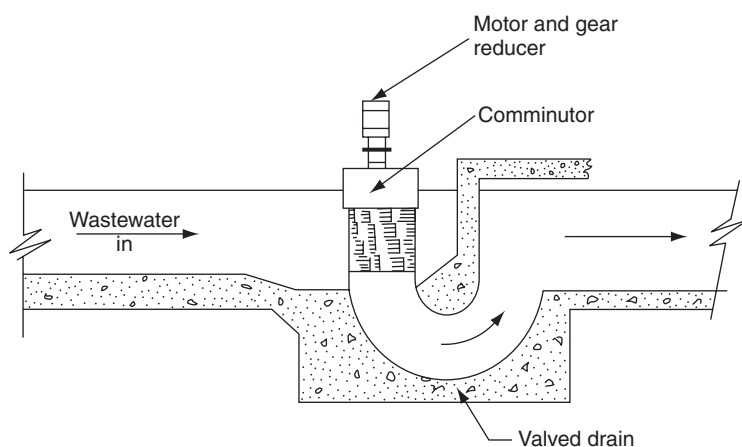

Figure C.4 Comminutor.

by the water supply authority or company. The pipe that is owned by the property owner and within the boundary of the property is known as the supply pipe.

**community medicine** A modern name for *public health*.

**community water supply** The *USEPA* defines this as a public drinking water system that delivers to at least 15 service connections the year round or to 25 permanent residents. Sampling conditions are stricter than for non-community supplies.

**compacted clay** See *clay liner*.

**compaction containers** (1) Containers that can be attached to a *static compaction* mechanism. These containers are used with waste materials which can be compacted. (2) Containers with a compaction device as an integral part of the unit.

**compaction of landfill** See *steel wheeled compactor, settlement of landfill*.

**compaction ratio** Of municipal solid waste, its original volume divided by its final volume after compaction.

**compactor** (1) A *steel wheeled compactor*. (2) See *static compaction*.

**compactor vehicle, compression v.** A vehicle for collecting solid waste that is fitted with a compactor mechanism that can compress the waste in order to maximise the quantity of waste that can be collected by the vehicle. It may have a capacity between 10 and 30 m<sup>3</sup>.

**compensation water** In the UK, this is the amount of water that has to be discharged below a reservoir to maintain the river flow at an equitable level for downstream usage of the river, e.g. landowners with *riparian rights*. It is often realistic to assume that the compensation water need not be greater than the flow which is ordinarily exceeded for 90% of the time. The minimum river flow is called the *prescribed flow*. The amount and type of compensation water have to be agreed and may take the form of continuous flow, of intermittent *freshets*, or of some combination of them.

**completely mixed reactor, CMR, completely mixed flow reactor, CMFR, complete-mix reactor, complete mixing system** A tank in which the liquid contents are completely mixed. The influent is also completely mixed with the contents of the reactor. Compare *plug flow reactor*. See *continuous stirred tank reactor*.

**complexing, sequestering** Formation of a complex *ion* by the union of one ion with another atom or molecule—e.g. copper with ammonium, forming  $\text{Cu}(\text{NH}_3)_4^{2+}$ . See *chelating*.

**composite liner** A lining system at the base and sides of a *landfill* site in which different materials are used together in order to achieve specific design requirements, for example, *geomembrane* and compacted clay may be used together. Drainage layers are installed above the composite liner to collect the leachate and below the liner. This system may be appropriate for landfill sites containing hazardous waste material. See *landfill liner* and *Figure L.4*.

**composite sample, composite** A combination of two or more *samples*, made so as to obtain a representative sample of water or air over the period in question. The composite may be flow weighted, which means that the

ratio between the volumes of each sample in the composite is equal to the ratio between their flows at the time of sampling.

**compost** Rotted leaves, plant stalks, bark, twigs, etc., a material of low bulk density that improves poor soils, whether clays or sands. It can hold 30 to 35% water by weight, and its organic content encourages earthworms that further improve the soil. Where there is a market for it, it can be made from municipal refuse, mainly the *green waste*. If compost contains high contents of *heavy metals*, they may harm the plants.

**compost filter** See *biological odour control*.

**composting** Generally, an aerobic decomposition process of organic waste, such as solid waste or wastewater sludge by bacteria, fungi and actinomycetes. The materials to be composted must be either agitated (turned) as in *windrowing* or aerated as in an *aerated static pile* (Figure A.4) in order to maintain aerobic biodegradation. (See also *in-vessel composting* and Figure I.4). In developing countries, where labour is plentiful and less expensive, the tendency may be towards low technological approach using manual labour to agitate the waste and encourage composting. The temperature during composting may rise to between 55 and 70 °C, but 40 °C is typical. A moisture content of about 40% is desirable and if it falls below 20% the decomposition process stops. If it exceeds 50% moisture, the process may become anaerobic and cause the temperature to drop and obnoxious odours are produced. The carbon: nitrogen ratio is important for the growth of the bacteria and the ratio should be between 30:1 and 35:1. If it is below 30:1, the nitrogen content of the final compost is depleted. In domestic refuse, the higher the ratio of paper to vegetable and putrescible matter, the higher is the carbon:nitrogen ratio. For municipal waste, the metals and some other components are separated from the waste prior to composting. The waste is probably pulverised to assist the composting process (see Figure C.5). If wastewater sludge is composted for at least 5 days at 40 °C (including 4 hours during this period at a minimum of 55 °C) followed by a minimum *curing* (maturation) period of 2 months, the sludge can be considered as safe from microbiological hazards for land application. The compost from wastewater sludge may contain a *potentially toxic elements*, which may restrict the use of the compost on agricultural or other land. See *drum digester*, *vermicomposting*, *vertical cell digester*.

**compost toilet** A well vented receptacle for excreta in which aerobic digestion takes place. Water is not used for flushing. Food waste may also be disposed into the compost toilet.

**Comprehensive Environmental Response, Compensation and Liability Act, 1980** See *CERCLA*.

**compression vehicle** A *compactor vehicle*.

**compressive settling** See *settling regimes*.

**CONCAWE foundation** Conservation of Clean Air and Water, Western Europe, the oil companies' international study group, based in Brussels, Belgium.

**concentration polarisation** In *reverse osmosis* other *membrane processes*, water diffuses through the membrane and concentration of salts on the salty side may locally exceed the salt solubility and result in salt deposition on the

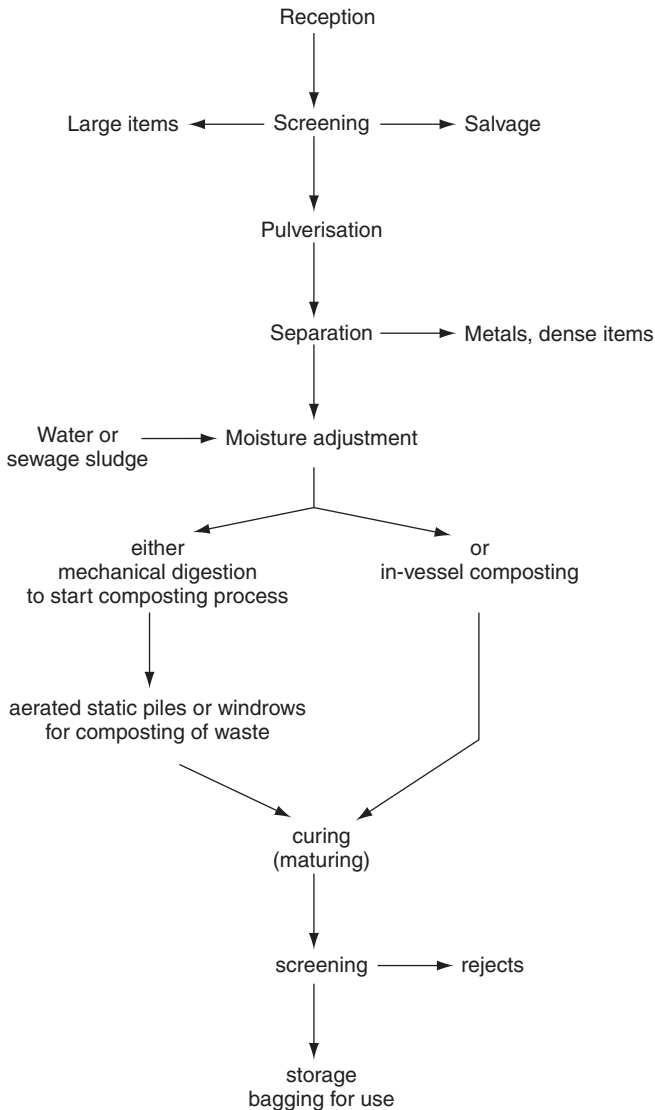

**Figure C.5** Composting plant for mixed domestic refuse, flow diagram.

membrane (*see membrane fouling*). These effects can be minimised by maximising the turbulence near the membrane surface.

**concurrent flow** Two flows in the same direction.

**condensate** Liquid formed as a dew by release (condensation) from a gas or air during cooling. It is common in chimneys or elsewhere at temperatures below the *dewpoint*.

**condensate polishing** In high pressure steam power stations, cooled steam (condensate) forms 98% of the feed water and make-up water only 2%. Consequently, the quality of the condensate is important and must be maintained. The condensate must be polished to bring its *conductivity* below the acceptable maximum. This usually means passing it through *mixed bed ion exchange resins* and the removal of the suspended solids by filtering through *filter candles*. The suspended solids are mainly oxides of metals from the turbines or tubes.

**condensation** This is an increasing problem within houses as ventilation is minimised in order to achieve energy conservation. Surface condensation can cause mould growth usually when the relative humidity is greater than 70%. The condensation can migrate within materials, affecting structural properties and potentially leading to decay and rot of timber. If the relative humidity is greater than 85%, the moisture in timbers may be 20% which is enough for dry rot. Condensation can be minimised by maximising ventilation and minimising moisture production. *See condensate, humidity, indoor air pollution.*

**conditioning** (1) For water or wastewater, the addition of a chemical to assist in the treatment, e.g. *coagulation*. (2) Of sludge, any treatment that makes dewatering easier—e.g. adding minerals or using *mechanical flocculation* or *elutriation* or *chemical conditioning*. (3) In *mineral dressing*, adding *flotation* agents to a mineral *pulp* to ensure that the valuable mineral floats well and that the unwanted *gangue* sinks.

**conditioning tower** An *evaporative tower*.

**conductive induction** The operating principle of an *electrostatic separator*. An earthed rotor feeds mixed refuse over its outer surface into an electric field near a charged *electrode*. The conducting materials are attracted to the electrode and are thus separated from the non-conductors, which move towards the rotor.

**conductivity** *See electrical conductivity.*

**conduit** Any channel or pipe that carries a liquid flow. It may be an open conduit or a closed pipe. Pipes may be of circular or other cross-section. If a pipe flows full, it is under pressure; if partially full, it is under *open channel flow*.

**cone aerator** A vertical shaft *surface aerator* which agitates the *mixed liquor* and throws it outwards in a low trajectory above the surface. A powerful upflow forces liquid up from the bottom of the tank (*see Figure C.6*). A *draft tube* may be fitted below the cone in the liquor to help circulate it upwards. The *aeration* motor may have from 1 to 75 kW output. Aerators dissolve about 2.5 kg of oxygen in de-aerated water per kWh. A 75 kW motor will circulate the liquid in an aeration 'pocket' 5 m deep and 15 m square.

**cone of depression, radius of influence** The theoretically conical depression of the *water table* around a well or borehole from which water is being pumped or baled (*Figure C.7*).

**confined groundwater** *Groundwater* that is not overlain by unsaturated ground, like *unconfined groundwater*, but by impermeable soil or rock (*see Figure A.11*). Consequently, it can be under a pressure higher than

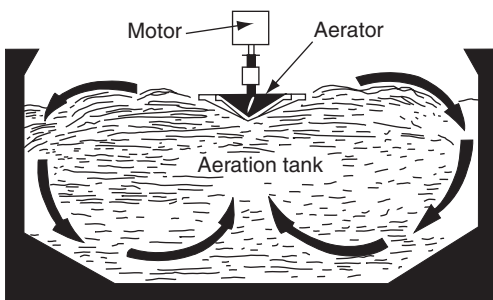

Figure C.6 Cone aerator.

atmospheric and is able to rise in a pipe above the bottom of the impermeable bed that confines it. At any free edge it may be unconfined. See *piezometric surface*.

**coning** Behaviour of a plume of smoke that is expanding uniformly as it leaves the chimney. (see *Figure P.7*). It occurs at *adiabatic lapse rates* and is often associated with strong winds. It results in good dispersion of pollution.

**conjunctive use of water resources** The integrated use of water, for example the combined use of water from upland catchments and from boreholes to provide a water supply.

**connate water** Water in deep sedimentary strata that has been there since they were deposited.

**conservative pollutants** Pollutants that do not decay, that are *nonbiodegradable*—e.g. *heavy metals* and some *pesticides*.

**consignment note** In the UK, the movement of a *special waste* is regulated by a consignment note which ensures that the production, movement and disposal of the special waste is tracked at every stage.

**consolidation tank** A tank used for *gravity thickening* of sludge.

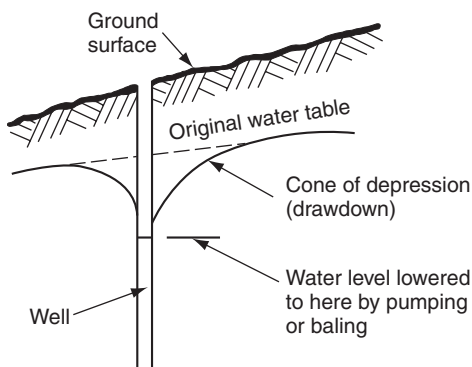

Figure C.7 Cone of depression about a well.

**constant velocity grit channel** A unit for removing grit from wastewater, usually with a *standing wave flume* (a Venturi section) downstream, and a cross-section that ensures a velocity in the channel of 0.3 m/s, whatever the depth of flow. The organic solids are carried in suspension at this velocity and the grit is deposited and then (usually) removed mechanically. (see *Figure C.8.*) Constant velocity is assured because the channel cross-section is parabolic and so the velocity of flow is constant irrespective of the depth of water in it.

**constructed wetland** A *natural treatment system* for treating wastewater in which an area of land is developed into a wetland. Two types of construction and operation are used, either with or without a water surface open to the air. For a free water surface system, the wetland has a water depth up to 0.6 m. The settled wastewater is applied to the wetland. Vegetation and micro-organisms grow in the wetland and remove the BOD and some nutrients. The wastewater flows across and through the wetland and the effluent is collected. This is sometimes known as an overland flow wetland. A free water surface system with vertical flow is also used, where the flow is mainly downwards and the effluent is collected in a drainage system located under the wetland. For either system, the area required is between 2 and 6 ha per 1000 m<sup>3</sup>/d of flow for biological treatment of a settled domestic wastewater or septic tank effluent. The alternative, and often more common approach, is to have the wetland without a free water surface and the applied settled wastewater flows below the surface through the soil (subsurface flow constructed wetland). This is normal in *reed bed treatment* (see *Figure R.3*). Subsurface flow constructed wetland is also known as root zone flow system or rock-reed system or vegetated submerged bed system. Constructed wetlands are sometimes used for storing and treating stormwater or road run-off. (See *vegetated storm-water treatment facility*) see also *floating aquatic plant treatment system*.

**consumptive use of water** The loss of water by evaporation or transpiration or by absorption into vegetation. It may also mean the water consumed by animals and humans.

**contact bed, c. filter** A forerunner of the *trickling filter*. It was a watertight tank packed with coarse stone, coke, brick or clinker of about 80 mm size,

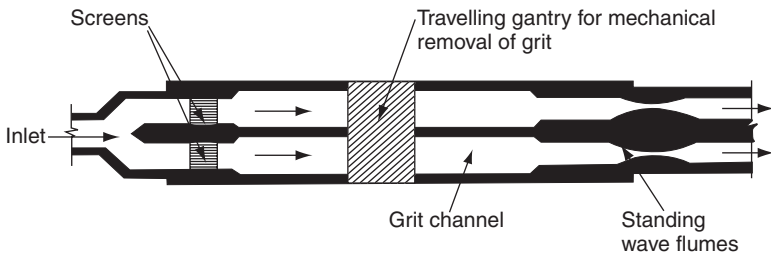

**Figure C.8** Constant velocity grit channel (plan view).



alternately filled with wastewater and allowed to remain quiescent for 2 h, then emptied and left empty for 2 h.

**contactor** A reactor or tank or vessel that is used for a treatment process in which the waste flow comes into contact with solid particles or media, e.g. *activated carbon*.

**contact stabilisation** An *activated sludge* treatment in which wastewater is aerated for only 30 minutes in a contact tank with *return activated sludge*. This is followed by *sedimentation*, after which the top water flows away to the river. The return sludge is aerated in a re-aeration tank for 3 to 6 h before it returns to the contact tank. The organic pollutants in the wastewater are adsorbed (see *adsorption*) on to the activated sludge in the contact tank and then metabolised by the bacteria during the re-action (stabilisation) stage. (see *Figure C.9*.) The *F:M* ratio is similar to conventional activated sludge but the *aeration tank* (contact tank) is much smaller. Problems may arise in the settleability of the sludge after the contact tank, because activated sludge usually settles better after stabilisation. Stabilisation is incomplete because of the short detention period in the contact tank. The method may be used in *package wastewater treatment plants*, from which the excess sludge may go to a separate tank for *aerobic digestion*.

**contagious abortion** *Brucellosis*.

**containment site, c. landfill s.** A *landfill* site in which the sides and base have a permeability less than  $10^{-9}$  m/s (see *Figure L.2*). The *leachate* and *landfill gas* that are generated in the site are therefore contained within the area of the site. The leachate is extracted from the base of the site and normally flows to a wastewater treatment facility. The landfill gas is vented to atmosphere or extracted via *landfill gas wells*. A site with an impermeable *cap* reduces the water input which substantially reduces the biodegradation of the waste with low gas and leachate production. A fully contained site with an impermeable cap is effectively a storage of the waste and the biodegradation may take 1000s of years. See *entombment landfill, flushing bioreactor landfill, landfill liner*.

**Contaminant Candidate List** See *Drinking Water Contaminant Candidate List*.

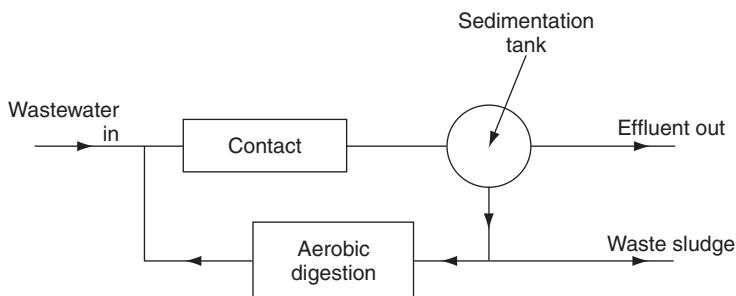

**Figure C.9** Contact stabilisation, flow diagram.

**Contaminated Land Exposure Assessment CLEA** New UK guidelines for contaminated land that replace the ICRL *trigger concentrations*.

**contaminated land treatment technologies** An increasing variety of treatments are becoming available to clean up contaminated land. These include *bioremediation, biosparging, dechlorination (2), electroremediation, encapsulation, phosphate remediation, phytoremediation, soil flushing, soil vapour extraction, soil washing, solvent extraction, stabilisation, steam stripping (2), thermal treatment, treatment walls*.

**Contaminated Related Objectives, CRO** A UK term applied to contaminated land for the acceptable residual concentration of a contaminant after remediation techniques have been applied. *See contaminated land treatment technologies*.

**continuous backwashing upflow sand filter** A type of *moving bed sand filter* in which water flows from the bottom of the tank up through the sand to the top. The sand moves downwards and is removed from the bottom of the filter to a sand washer. The cleaned sand is replaced on top of the filter. The sand bed is about 2 m deep.

**continuous belt filter press** *See belt filter press*.

**continuous filter (1) trickling filter (2) continuous backwashing upflow sand filter**.

**continuous flow stirred tank reactor, CFSTR** A *continuous stirred tank reactor* which has a continuous flow going into and out of the reactor.

**continuous grate incinerator** A *moving grate incinerator*.

**continuous ion exchange** Equipment which uses three *ion exchange* columns. One tank contains resin that is treating the water, another resin undergoing *regeneration* and the third contains resin being rinsed or stored before return to the treatment tank.

**continuous phase** *See emulsion*.

**continuous stirred tank reactor, CSTR** A tank with mechanical agitation such as *surface aerators* or *turbine aerators* to mix an *activated sludge* aeration tank or *aerated lagoon* etc. It produces a *completely mixed reactor*.

**contraries** Substances in municipal refuse that hinder a later process and should be removed for either disposal or other treatment.

**Controlled Waste Regulations 1992** UK legislation that defines *controlled waste*. The Regulations have been amended by the Controlled Waste (Amendment) Regulations 1993, Waste Management Licensing Regulations 1994 (and its subsequent amendments) and the Special Waste Regulations 1996.

**control by drainage** The water level in the *landfill* can be controlled by the installation of drainage ditches. The *leachate* can be pumped or flow away from these ditches. Alternatively, drainage in the landfill can be achieved by incorporating land drains or trench drains with filter fabric on both side of the drain. This fabric stops the drain clogging with fines. The materials used must withstand any corrosive effects of the leachate. Control by drainage does not prevent downward movement of the leachate unless the base of the landfill has been lined with a low permeability material such as clay.

**controlled air incinerator** *See starved air incinerator*.

**controlled flushing bioreactor landfill** *See flushing bioreactor landfill*.

**controlled tip** A *landfill*.

**controlled tipping** See *landfill*.

**controlled waste** In the UK, waste that is regulated by the *Environmental Protection Act, 1990* and subsequent legislation. It includes household, industrial clinical, commercial waste and wastewater sludge, if it is to be incinerated.

**Control of Pollution Act 1974, COPA 1974** A UK law that gave wide powers to local authorities concerned with waste disposal, street cleaning, water pollution, consents and their publication, noise on streets or construction sites and from machinery, as well as *air pollutants*—e.g. from motor vehicles and the burning of insulation off electrical cables. It has been replaced by the *Environmental Protection Act 1990*.

**Control of Substances Hazardous to Health Regulations (COSHH) 1999** Regulations in the UK that apply to the use of hazardous substances in the work place.

**control structure** In a river or channel, a structure, such as a weir, that is used to control the flow or water level in the channel.

**convection** Transfer of heat in a fluid by movement of the fluid. Usually the warmed fluid rises and the cold part descends. When the sun heats the ground, this warms the air above it, which rises by convection, mixes with other air and reduces pollution.

**convection dryer** A *dryer* that works by the *convection* of hot gas, usually air.

**conveyance loss** Losses during the transport of water, e.g. *leakage*.

**cooling tower** A tower at a power station or other industry with large boilers or generating capacity, used for the air cooling of hot water by evaporation (*Figure C.10*). See *dry cooling tower*.

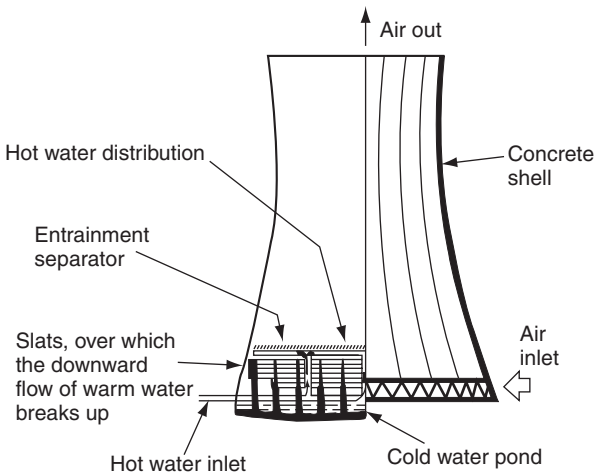

**Figure C.10** Cooling tower.

**cooling water** Some 70% of industrial water is used for cooling and very large quantities are needed for electrical generation and other industry. See *thermal pollution*.

**COPA Control of Pollution Act 1974.**

**copper, Cu** Compounds of copper are rare in natural waters but can enter drinking water from copper pipes and tanks. The normal cold water corrosion product is cuprous oxide,  $\text{Cu}_2\text{O}$ , but at  $40^\circ\text{C}$  this changes to cupric oxide (see also *rosette corrosion*). Copper is a strong algicide and can be highly toxic to some fish. The EU Drinking Water Directive states a mandatory maximum of 2 mg/l. The WHO guideline maximum value is 2 mg/l in drinking water for health reasons but 1 mg/l for consumer complaints regarding staining of laundry. The *USEPA* states a TT (treatment technology) standard, whereby the corrosiveness of the water must be altered if the copper concentration in the drinking water exceeds 1.3 mg/l. See *Table D.2 Drinking water standards*.

**copperas** A commercial grade of *ferrous sulphate*,  $\text{FeSO}_4 \cdot 7\text{H}_2\text{O}$ . Used as a *coagulant* in conjunction with *lime*, it forms a precipitate of ferric hydroxide. See also *chlorinated copperas*.

**copper sulphate,  $\text{CuSO}_4$**  A chemical sometimes added to water in small quantities to eliminate nuisance *blooms* of algae. Care must be exercised.

**core area sewers** These sewers comprise *critical sewers* and sewers in which hydraulic performance problems would be a major problem. The structural condition and hydraulic performance should be periodically investigated in order to maintain effective operation of the sewer system.

**corona discharge** A luminous electrical discharge, seen as a bluish glow from high-voltage conductors. In an *electrostatic precipitator*, a dim glow may be seen around the wire. This is due to high speed electrons colliding with gas molecules thus ionising the gas molecules. See *flashover*.

**corralling an oil slick** Encircling an oil *slick* with a floating boom.

**corrosiveness of water** Water that is slightly alkaline and deposits a thin protective scale of *calcium carbonate* is considered non-corrosive. Lack of corrosiveness is measured by the *Langelier saturation index*—an index of the likelihood that a water will deposit a scale. Apart from acidity, chlorides in water also may be corrosive. Aluminium, copper and many steels, including some stainless steels are affected, because the inert oxide layer on the surface of the metal is attacked by the chloride ion. For steam boilers the requirements are quite different, although some *alkalinity* may be desirable. There must be no dissolved oxygen, which is highly corrosive. High pressure boilers need exceptionally pure *feed water*. See *aggressive index, cuprosolvency, dezincification, plumbosolvency, polyphosphate*.

**corrosive wastes** In the USA, this term refers to wastes with a pH below 2 or above 12.5.

**corrugation irrigation** *Furrow irrigation*.

**COSHH Control of Substances Hazardous to Health Regulations 1999.**

**cotton textile wastewater** Wet processing of cotton includes de-sizing (removal of starches used in processing raw cotton), scouring or kiering (caustic washing), bleaching, dyeing and printing. The mixed waste waters

- are alkaline, having 300 to 600 mg/l BOD<sub>5</sub>, mainly soluble, plus detergents, *hypochlorite* ions, and waste dyes.
- Coulter counter** An instrument that measures the size distribution of particles between 0.6 and 300 µm in size. A dilute suspension of the particles in an electrically conducting liquid is forced through an opening with *electrodes* each side. When a particle passes through an opening, it initiates a voltage pulse proportional to the size of the particle.
- Council on Environmental Quality, CEQ** A committee of three scientists in the US President's Office, established in 1970 under the *National Environmental Policy Act* to advise him on the quality of the environment and action to be taken.
- countercurrent flow, countercurrent, counter flow** Two flows in opposite directions. For example, in a gravitational *spray chamber*, the gases flow upwards through downward directed sprays.
- counter ion** An *ion* of opposite charge to that of the ion under discussion. Thus, a *cation* is counter to an *anion*.
- coupon test** Insertion of a piece of weighed metal in a water main, with reweighings at intervals. This aims at being a test of the *corrosiveness of water*. It measures the effects of all the factors involved in *corrosion*, including water speed and turbulence.
- cover** In a *landfill*, soil or inert material that is placed onto deposited waste. The use of cover is important for the effective environmental management of the landfill. *See daily cover, final cover, intermediate cover.*
- coverload pressure** *Overburden pressure.*
- cowshed wastewater** The manure from cow byres may be spread on land or treated in *anaerobic lagoons* at a loading of 0.1 kg BOD<sub>5</sub> per m<sup>3</sup> of lagoon per day. The BOD from one cow is about equal to that of 20 people.
- coxsackie virus** Waterborne viruses of many types, some of which cause heart disease.
- cracking of an emulsion** *See emulsion.*
- cradle to grave** A management system that tracks a waste stream from its point of generation to its point of ultimate disposal. *See Uniform Hazardous Waste Manifest.*
- crankcase blowby** *See blowby.*
- creamery wastewater** In making butter or margarine, water is used both for cooling and for washing. The waste water may have a BOD<sub>5</sub> in excess of 1000 mg/l, a nearly neutral pH and about 200 mg/l of fats and oils. A *grease trap* is essential before discharge to the sewer. The waste readily submits to biological treatment. *See dairy and milk bottling wastewater.*
- Crenothrix polyspora** An *iron bacterium* that oxidises ferrous iron and produces gelatinous ferric iron deposits.
- cresols** Aromatic compounds with one hydroxy group (—OH) and one methyl group (—CH<sub>3</sub>) attached to a benzene ring.
- critical depth** The depth of liquid flowing at the *critical velocity* in an open channel.
- critical sewers** Sewers for which consequences of structural failure are substantial and very expensive. These sewers are the main large sewers through the

conurbation. For some of these sewers preventive rehabilitation must be undertaken whereas for others preventive rehabilitation is desirable. Between 5 to 15% of the sewer system are classified as critical sewers.

**critical velocity** In an open channel, that velocity at which the *Froude number* is 1. In a pressure pipe the critical velocity is at the change point from *laminar flow* to *turbulent flow* or vice versa. In practice this is at a *Reynolds number* of about 2000. *See subcritical flow, supercritical flow.*

**CRO Contaminated Related Objectives.**

**crocidolite** The most hazardous (to human health) type of *asbestos*, blue asbestos.

**cross connections** (1) Connections between the pipes of a drinking water supply and a water supply that is doubtful or not drinkable must be avoided. Water from a *cistern* is not allowed to flow back into the main, and this is prevented usually by *air gap protection* or a *non return valve* or both. (2) Connections between *pressure zones* of a water supply, such that water can flow either way and one zone may augment the supply in the neighbouring zone.

**crown corrosion of sewers** *See sulphide corrosion.*

**crown of a sewer** The top of a sewer.

**crude sewage** Untreated domestic wastewater.

**crumb rubber** *Rubber crumb.*

**crustaceans** Mainly water animals that use oxygen, consume organic substances, and have a hard body or crust. They are an important food for fish, are not normally found in biological treatment processes and are an indicator of clean water. They include barnacles, crabs, lobsters, shrimps and prawns, and are important *predators* on micro-organisms. *See Cyclops, freshwater shrimps.*

**cryofragging, cryofragmentising cryogenic fragmentation** A process designed to help the *detinning* of *cans*. Bales of cans are dipped in liquid nitrogen at  $-195^{\circ}\text{C}$  which cools them below  $-120^{\circ}\text{C}$ . They are then shredded in a *hammer mill*. While still cold, the metal is separated magnetically from the dirt to achieve a dirt content of only 0.7%. Aluminium also is recovered, by differential magnetic separation. *See below.*

**cryogenic processing** One of the many cryogenic processes is used for breaking scrap tyres so as to obtain their rubber and steel. Using liquid nitrogen, the tyres are cooled to  $-190^{\circ}\text{C}$  and shredded in a hammer mill to form 'rubber crumb' of any desired size. The rubber is not contaminated by steel, but the steel contains some rubber and fibre. The cost of the nitrogen is 70% of the process cost.

**cryogenics** The science of the behaviour of matter at very low temperatures.

**cryology** The study of snow, ice, hail, sleet—in fact, of any water at low temperature.

**cryophilic** Micro-organisms that like temperatures less than  $20^{\circ}\text{C}$ .

**cryptic growth** Growth of bacteria based on the death and break-up of other microbes. This occurs during *endogenous respiration*.

**cryptosporidiosis** A common cause of severe diarrhoea, between 250 to 500 million humans in the world have the disease. The pathogenic organism is

the protozoon *Cryptosporidium parvum*. The hosts of the organism can be animals or man. The protozoa grow in profuse numbers in the intestines of the infected animal or human. The organisms form **oocysts** which are 4 µm in size. They are excreted from infected humans or animals at up to 10<sup>7</sup> cysts per day. The transmission route is **faecal-oral** and it is commonly waterborne. The infective dose is extremely low, possibly only 10 oocysts. The disease cannot be treated by drugs, but a fit human overcomes the disease within 14 days. However, immuno-compromised individuals may not be able to fight the disease and the disease may then be fatal. The oocysts are not killed during normal water disinfection, although some removal occurs in sand filtration. If the oocysts are present in the raw water then it is definitely possible that the oocysts are present in the treated, disinfected water. Processes such as **microfiltration**, **nanofiltration** and **ultrafiltration** remove oocysts from water. The **USEPA** states that treatment techniques to produce drinking water from surface waters (or groundwater under the direct influence of surface water) must remove/inactivate 99% of *Cryptosporidium sp.* oocysts. In the UK, where there is a risk of *Cryptosporidium*, water companies must use a process for treating the water to ensure that the average number of oocysts is less than 1 per 10 litres of water.

**CSO** *Combined sewer overflow.*

**CSTR** *A continuous stirred tank reactor.*

**Culex fatigans** *A mosquito, the main vector of filariasis.* It thrives in polluted water in the tropics, breeding in pit latrines, **septic tanks**, pools, polluted rivers, etc. Tropical areas affected by this mosquito are increasing because of the growth of towns.

**Culicidae** *The mosquitoes.*

**cullet** *Broken waste glass. See glass recycling.*

**cultural eutrophication** *Eutrophication* that is caused by human activity.

**culture** *A culture of bacteria consists of micro-organisms and their nutrient medium, in a suitable container such as a test tube, cultivated under specific conditions of temperature, light and food—incubation.*

**culture medium** *See medium.*

**culvert** *A covered channel or large pipe to take a sewer or stream under a road, railway or landfill.*

**culverting** *Building a culvert.*

**cumec** *A unit of flow, 1 cubic metre per second.*

**cupola** *A furnace in which iron is melted to make iron castings. Cupolas emit grit, ash and sometimes oil vapour. The carbon monoxide that flowed from their stacks is reduced by an afterburner in the stack. Following the afterburner and any quenching device used, the flue gases pass to dust arrestors.*

**cuprosolvency** *Drinking water that will dissolve copper is cuprosolvent.*

**cup screen** *A rotating, drum shaped screen made of fine stainless steel wire mesh through which the wastewater passes outwards, leaving solids inside. Buckets (cups) scrape them from the inside, lift them out and throw them into a solids hopper. The direction of flow is thus opposite from that of a drum screen.*

**curb** The USA spelling of kerb.

**cured in place pipe, CIPP** See *soft lining*.

**curie, Ci** A unit of radioactivity. It is equal to  $3.7 \times 10^{10}$  disintegrations per second. Picocuries or microcuries are often more appropriate units for radioactivity. The SI equivalent is the *becquerel* (Bq). One curie equals  $3.7 \times 10^{10}$  Bq.

**curing, maturing** Storage of *compost* after it has passed through the main stages of *composting*. During the 10 to 60 days of curing, *aerobic digestion* continues, the colour darkens and the temperature may remain high. There is no unpleasant smell, because the pile remains aerobic. The product looks better and is more marketable, but the main reason for curing is to ensure that the compost is completely stabilised.

**cusec** A unit of flow, 1 cubic foot per second.

**cut** A particle size or a specific gravity that describes the performance of a *classifier* or *separator*.

**cutaneous** Related to the skin.

**cutaneous hazard** A chemical that may cause harm to the skin on contact.

**cutback irrigation** Irrigation practice where the quantity of water used is reduced over the irrigation period.

**cut diameter** The diameter of a particle at which 50% removal is achieved, for example, in removal of particulates in an air pollution control device.

**cut-off wall** The installation of a vertical barrier to reduce or stop horizontal groundwater flow, for example into a *landfill* site. The vertical barrier may be formed from an excavated trench (a *slurry wall*). See *grout curtain*.

**cutwater** The upstream end of a bridge pier or of any other wall that divides a flow channel. It is sharp pointed to provide the least resistance to flow and to catch as few solids as possible.

**CWA Clean Water Act.**

**cyanate** A compound that contains CNO, e.g. the oxidation of sodium cyanide (NaCN) by ozone, hydrogen peroxide or chlorine forms sodium cyanate, NaCNO.

**cyanide compounds** Cyanides (CN<sup>-</sup>), although *biodegradable* by certain bacteria, are poisonous and should be chemically removed before they are discharged into rivers. Fish are killed by them, electroplating effluents being their normal origin. See *Table D.2 Drinking water standards*.

**cyanide wastes** *Cyanide compounds* in *metal plating wastewater, ammoniacal liquor*, etc., can be removed by *chlorination* at pH 11, which oxidises the cyanide to cyanate and then on to N<sub>2</sub> and CO<sub>2</sub>. At lower pH values, extremely toxic cyanogen chloride is formed.

**cyanobacteria, Cyanophyta, blue green algae** A unicellular micro-organism that can form large green dense mats on the water surface. They are a group of bacteria, but they are capable of photosynthesis and used to be considered as blue green algae. They can use atmospheric nitrogen as a nutrient. Other nutrients, particularly phosphorus, must be available in the water if a *bloom* is to appear. These micro-organisms can give the



water an unpleasant taste and smell and clog filters at the waterworks. They can release poisonous *endotoxins* into the water. They may be found in *waste stabilisation ponds*.

**cyanophage** A virus that attacks *cyanobacteria*.

**Cyanophyta** *Cyanobacteria*.

**cyanosis** A bluish discoloration of the skin due to lack of oxygen in the blood.

See *methaemoglobinemia*.

**cyclic activated sludge system, CASS** An adaptation of the *activated sludge* process and a variant of a *sequencing batch reactor* (SBR). The wastewater treatment consists of three mixed zones. The first zone is anaerobic and the second zone is *anoxic*. These two zones are for *biological phosphorus removal* and *denitrification*. The third zone is operated in a sequence of cycles which are aerobic biological treatment (to achieve BOD removal and nitrification) followed by a quiescent period to allow settlement of the sludge and then discharge of the effluent. This cycle is repeated in the third zone with new inflow from the second zone. Sludge is recycled from the third zone to the first zone.

**cycle of stabilisation** The cycle of *self purification*.

**cyclodienes** A group of insecticides that include aldrin, chlordane, dieldrin, endrin, heptachlor, heptachlor epoxide. These chemicals can have adverse effects on the human nervous system.

**cyclone** (1) Or depression (weather). A region of low atmospheric pressure, with its minimum at the centre. North of the equator the winds blow counter-clockwise round the centre; south of the equator, clockwise. Cyclones usually accompany rain and storms, unlike *anticyclones*. (2) *cyclone separator* The use of centrifugal force to separate particles from a gas stream, such as flue gases. The particles are thrown to the outside by the induced motion of the gases and impinge on the surface of the cyclone. They then settle to the base from where they are removed. There are two spirals within a cyclone, a downwardly directed spiral in the outer part and a more rapid inner spiral which is directed upwards to the outlet for the gases (see *Figure C.11*). Cyclones may be tangential in which the gases are admitted at a tangent, or axial in which the gases are admitted at the top and a swirling motion imparted by vanes (see *Figure A.12*). They may also be used in banks. If used in parallel, high volume passage is allowed, if in series the efficiency of separation is increased although volume passage is not. Efficiency falls off rapidly with particles below about 50  $\mu\text{m}$  and generally 10  $\mu\text{m}$  is the minimum particle diameter collected, although in high efficiency cyclones this may be reduced to about 5  $\mu\text{m}$ . Cyclones are less efficient than *electrostatic precipitators* or *fabric filters*, but they are inexpensive, versatile and, being without moving parts, generally trouble free. See *cyclonic spray scrubber dense medium cyclone, multicyclone, wet cyclone*.

**cyclone degritter** A *vortex grit separator* that is used to separate grit from sludge.

**cyclonic spray scrubber, c. scrubber** A *cyclone* (2) that incorporates water sprays within (or at the inlet) to the cyclone, sometimes known as a *wet*

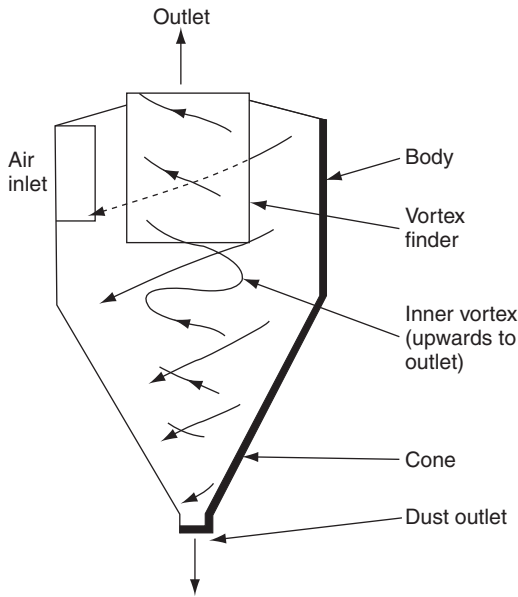

**Figure C.11** Cyclone for gas cleaning.

**cyclone.** The addition of water can improve the efficiency of dust removal in the cyclone. The water use is about 0.2 to 1 litres per  $\text{m}^3$  of gas. These scrubbers are more efficient than dry cyclones but less efficient than *spray chambers*. See also *Venturi scrubber*.

**Cyclops** A *crustacean* about 1 mm long that is common in *zooplankton* and may be used in *bioassays*. It is the *vector* of *Guinea worm*, that causes *dracunculiasis*.

**cyst** A protective capsule or sac that can be formed by some *protozoa* and a few species of bacteria around a 'seed', ensuring its survival. It does not germinate until the environmental conditions are correct. Some protozoan cysts and all bacterial cysts are formed as a 'resting' cell in a different environment. Other protozoa form a cyst as an integral part of their life cycle and these reproductive cysts have thinner walls than the protective cysts. See also *Entamoeba histolytica*, *endospore*, *Giardia intestinalis*, *oocysts*.

**cystercercosis** The disease caused by the pork tape worm, *Taenia solium*. See *Taenia*.

**cytology** Study of the structure of living *cells*, visible only through a *microscope*.

**cytoplasm** All the metabolically active part of a *cell* except the nucleus.

**cytotoxic substance** A substance that can damage the cell structure or interfere with cell division.



---

**2,4-D** 2,4 dichlorophenoxyacetic acid. A herbicide that can cause liver and kidney damage in humans. The *USEPA* states a *MCL* in drinking water of 70 µg/l and the corresponding WHO guideline maximum value is 30 µg/l. The EU Drinking Water Directive states a mandatory maximum of 0.1 µg/l. See *chlorophenoxyacetic acids*.

**DAF** *Dissolved air flotation*.

**daily cover, primary c.** The soil, subsoil, demolition waste or other material that is placed onto deposited waste at the end of each days *landfill* operation. It should be at least 0.15 m deep. The use of daily cover is important to reduce windblown refuse, flies, vermin, bird nuisance and generally improves the aesthetics of the landfill.

**dairy and milk bottling wastewater** The *wash water* from dairies contains some whole milk, separated milk and buttermilk. The waters are slightly alkaline but may become acid because of the *fermentation* of milk sugars. The BOD<sub>5</sub> of milk bottling wastes is about 500 mg/l. See also *cheese manufacturing wastewater, creamery wastewater*.

***Daphnia magna, common water flea*** A swimming *crustacean* up to 5 mm long. Like other *Daphnia*, water fleas are useful in testing for the toxicity of substances in water, because they are small, visible, easy to cultivate, have a life span of 2 months at 25 °C and have offspring in their first week of life.

**Darcy's law** For the velocity of percolation of water in a saturated soil:  
velocity = coefficient of permeability × hydraulic gradient

**Darcy-Weisbach formula** A formula used in evaluating *pipe flow* in water distribution systems. The Darcy-Weisbach friction factor can be determined from a Moody diagram.

**dark smoke** *Smoke* as dark as grade 2 of the *Ringelmann chart*. In the UK continuous dark smoke for more than 4 min is an offence unless it is caused by soot blowing. Emissions of dark smoke over any eight hour period are also limited. See *black smoke*.

**daughter product** A *decay product*.

**2,4-DB** 2,4-dichlorophenoxybutynic acid, one of the *chlorophenoxy herbicides*. The WHO guideline maximum value is 90 µg/l in drinking water. The EU Drinking Water Directive states a mandatory maximum of 0.1 µg/l.

**DBCP** *Dibromochloropropane*.

**DBP** (1) Dibutyl phthalate. See *phthalates*. (2) *Disinfectant by-product*.

**DCB** Dichlorobenzenes. See *chlorinated benzenes*.

**1,2-DCP** *1,2-dichloropropane*.

**DCPA** Either tetrachloroterephthalic acid (in the USA) or dichloropropionanilide (in Japan). Both are herbicides.

**DDE, dichlorodiphenyldichloroethene** A chemical produced by the microbial decomposition of DDT. It is more persistent in the environment than DDT.

**DDT, dichlorodiphenyltrichloroethane, dicophane, clorophenothane etc.** An *insecticide*, now forbidden in most of the world because it is non-biodegradable and therefore may continue undesirably as a poison. It had been in use for 30 years before this fact was discovered, but, according to WHO in 1972, there was then no evidence that DDT harmed humans. It is toxic to fish at very low concentrations (less than 0.03 mg/l) and may also affect many other forms of life. It temporarily eliminated some diseases (*malaria*) in hot countries. See *biomagnification, organochlorine compounds, vector control*.

**dead storage** In a reservoir, the volume of bottom water that cannot be withdrawn, either because it is below the outlet or is dirty, or for other reasons. Compare *live capacity*.

**deaeration** Feed water for steam boilers should have all its dissolved oxygen (DO) removed to stop corrosion. The water is passed through a vacuum chamber or heated under pressure to above 100°C. The DO can be reduced below 7 µg/l. Chemical deaeration also is possible, by adding sodium sulphite (Na<sub>2</sub>SO<sub>3</sub>) or *hydrazine* (N<sub>2</sub>H<sub>4</sub>), both of which react rapidly with dissolved oxygen.

**dealkalization** The reduction of alkalinity in a water or wastewater.

**deanionised water** Water treated by *ion exchange* so that the anions (e.g. NO<sub>3</sub><sup>-</sup>) have been removed.

**death phase of growth** The *endogenous phase of growth*.

**decanting valve** A valve that can be opened to withdraw sludge or the cleaner top water from a *sedimentation tank* or thickening tank. For selective withdrawal, a floating outlet pipe may be used. See *telescopic valve*.

**decationised water** Water treated by *ion exchange* so that the cations (e.g. Ca<sup>2+</sup>) have been removed.

**decay product, daughter p.** A substance that is formed by *radioactivity*.

**decay rate** The rate at which the concentration of a pollutant or the activity of a *radioactive isotope* falls, expressed by stating its *half life*.

**dechlorination** (1) Removal of excess chlorine after *chlorination*, usually by adding sulphur dioxide

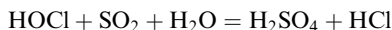

Where sulphur dioxide is not available *sodium thiosulphate* can be used. (2) The addition of a chemical to soil from contaminated land in order to remove or destroy organochlorine compounds. It has been used to treat soils contaminated with *PCBs*.

**declining growth** A *growth phase of microbes* that follows the rapid, *logarithmic growth* phase and precedes the *endogenous phase of growth*. The quantity of food becomes more limited, so the micro-organisms cannot reproduce at the maximum rate.

**decontamination filter** A filter of steel wool, clay and *activated carbon* or resins, which can remove 99.99% of radioactive materials from water.

**dedicated land disposal** Land that has been set aside solely for the use of the disposal of a particular waste, e.g. wastewater sludge.

**deduster, dedusting plant** *Dust arrestors*.

**deep bed filter** *Rapid deep bed filter*.

**deep coarse filter bed** A filter bed used for *tertiary treatment* of wastewater. It is usually 2 to 3 m deep with uniformly sized sand or anthracite from 2 to 4 mm diameter. The bed is usually *backwashed* using air and water. These beds can be used to nitrify wastewater effluents or act as *anoxic filters* for *denitrification*.

**deep cone thickener** A thickening tank that replaces lagoons for settling *tailings* from a coal washery. It thickens a 95% water *slurry* quickly to 40 or 50% water with the help of a *polyelectrolyte*.

**deep shaft process, d. s. reactor** An *activated sludge* system for treating wastewater in which air is blown into a shaft or borehole of 0.4 to 10 m diameter, sunk 60 to 300 m into the ground, *see Figure D.1*. The depth and consequent high pressure are an advantage, because for every 10 m depth the pressure rises by 1 atm, which correspondingly increases the solubility of oxygen. Air is injected into the upflow tube to start the circulation and in the downflow tube for the whole time. Once circulation has started, it becomes automatic, because gas comes out of solution in the upflow annulus with falling pressure as the liquid rises, as in an *air lift pump*. The *mixed liquor* flows from the shaft to a *flotation tank*. Alternatively, the mixed liquor flows to a

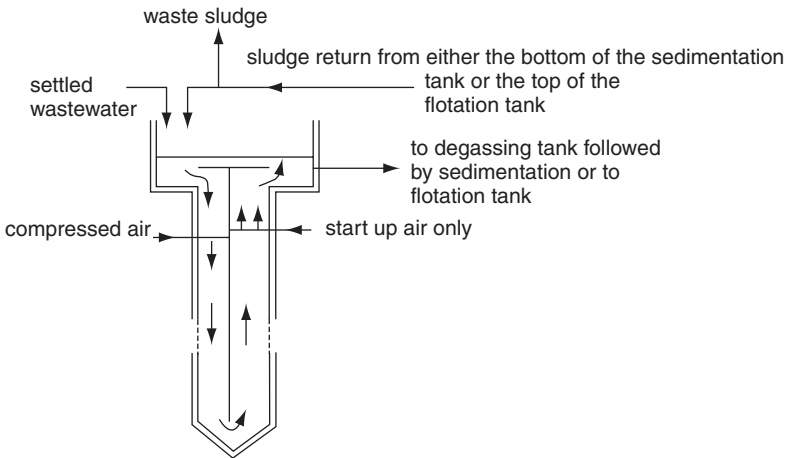

**Figure D.1** Deep shaft process.

- de-gassing tank, followed by a sedimentation tank. The sludge is returned from the flotation or sedimentation tank.
- deep well** A well that requires a pump to be immersed in the well. The depth is normally deeper than 10 m. The pump must be readily withdrawn for maintenance. In developing countries the well is often hand pumped. Wells can be hand bored down to 40 m.
- deep well injection** A deep well in which wastewater or dangerous liquids are injected and disposed. The well is into porous rock well below any potable *aquifer* and preferably separated by an *aquiclude*. The well must have solid sides in the upper parts in order to stop the wastewater being disposed leaking into the upper rock strata.
- degasifiers** Gases, such as carbon dioxide, can readily be stripped from water by passing the water down a tower (typically a *cascade aerator* or a *packed tower aerator*) with air being forced up through the tower.
- degree Clarke** An old British measure of the *hardness* of water. One degree Clarke was 1 grain of *calcium carbonate* per gallon (14.5 mg/litre CaCO<sub>3</sub>).
- degree of hardness** (1) *See degree Clarke*. (2) One French degree of *hardness* is equivalent to 10 mg/l as CaCO<sub>3</sub>. (3) One German degree of hardness is equivalent to 10 mg/l as CaO, which is equivalent to 18 mg/l as CaCO<sub>3</sub>.
- dehalogenation** Removal of *halogen* atoms from a halogenated compound. This is sometimes the first stage in biodegradation of a halogenated organic compound.
- deinking** Removal of dirt, staples, printing ink, etc., from scrap paper so as to enable it to be re-used. A flotation agent resembling soap solution is added to the *pulp* of old paper. Air blown into the bottom of the liquid carries off the ink in a froth. About half the cost of a de-inking plant is spent on its wastewater treatment plant.
- deionised water, demineralised w.** The removal of cations and anions from water by passing through *ion exchange* beds.
- delisted wastes** In the USA, hazardous wastes that have been removed from the *USEPA* hazardous waste designation system.
- demand initiated regeneration** A method of automatically backwashing filters or regenerating ion exchange beds etc. after a preset volume of water has been passed through.
- demand management** In water supply, a management programme to ensure effective use of water resources. Agriculture is the biggest consumer of fresh water in the world and irrigation can be very inefficient in its use of water. Reduction in the wastage in water supply systems (*see leakage*) is integral in demand management. Leakage reduction may involve *water pipe rehabilitation* or *pressure management*. Reducing the water demand is possible by putting up the price of water for the consumer, although there are political and social consequences of this approach. Water metering, rather than a fixed annual price, can reduce the demand as consumers only pay for the water they use. Toilets with a low volume flush, or showers with a low volume shower head are used to reduce water demand. *Wastewater re-use, wastewater recycling* and *rainwater harvesting* can reduce the demand for fresh treated water. Besides these techniques,

education can be important so that consumers understand that fresh water is not an unlimited resource.

**demand sensing pressure reducing valves** *flow modulated pressure reducing valves*.

**demand units** A method described by the Chartered Institute of Building Services Engineers (CIBSE) that can be used in the calculation of the size of water pipes in buildings. A number, known as a demand unit, is allocated to each appliance (toilet, bath, sink, etc.) depending on the water usage of that appliance and its frequency of use. The number of demand units is aggregated to give a total for any particular part of the building. The demand unit is then related to a flow using a chart and thereby the correct pipe size can be chosen.

**demersal** Concerned with the sea bed, as opposed to *pelagic*.

**demineralised water** The removal of all minerals (inorganic compounds) from water. This can be achieved by *distillation* or by *ion exchange* (which produces *deionised water*).

**demister** *See mist eliminators*.

**demography** The study of the statistics of human population.

**demountable containers** Containers used for the storage of solid waste that are located in position by a specialist vehicle which can also uplift the container and transport it to a suitable disposal site. The most common example is the 'skip'. Large demountable containers can be over 30 m<sup>3</sup>.

***Dendrocoelum lacteum*** A free living *flatworm* (*planarian*) which is more tolerant than others of organic pollution and is found in mildly polluted water. It may be used in a *biotic index*.

**dengue, breakbone fever** An acute, influenza like disease of many tropical regions, caused by a virus, which may lead to fatal bleeding. It is spread by *mosquitoes*, especially *Aedes aegypti*.

**Denite filter** A type of *anoxic filter* used for *denitrification*.

**denitrification** The removal of oxygen from nitrates in *anoxic* or *anaerobic* conditions, resulting eventually in gaseous nitrogen, which bubbles off and is thus removed. Many *heterotrophic* bacteria found in *aerobic* biological processes can adapt to using the oxygen that is combined in nitrates if the dissolved oxygen is very low or zero (*respiration* under anoxic conditions). The sludge in the bottom of a *secondary sedimentation* tank has little oxygen and with a *nitrified effluent* it may rise to the surface because of denitrification, as the nitrogen bubbles lift the sludge. In activated sludge treatment, denitrification can be achieved as with the *AAO* process or the *Bardenpho process*. Denitrification of an effluent can also be achieved by locating an *anoxic* treatment process after secondary sedimentation. Methanol or other carbon sources may be added to the secondary effluent to act as organic carbon sources for the denitrifying bacteria. The denitrification of a *nitrified effluent* can be an activated sludge process or an *anoxic filter* or *biological aerated filters* or *biological fluidised beds*. *Biological fluidised beds* can be used to remove nitrate from drinking water. The denitrification process can occur in rivers when a nitrified effluent meets a polluted river water. *See nitrification—denitrification*.

- denitrifying filter** Biological *denitrification* occurs under *anoxic* conditions when bacteria use the oxygen in the nitrate molecule and release nitrogen gas. The bacteria can be heterotrophic or autotrophic. The process can be obtained in a *packed bed filter* using sand or plastic media (see *anoxic filter*). See *nitrification—denitrification*
- dense medium** Carbon dioxide is a dense medium compared with air, and water is dense compared with oil, but in commercial *mineral dressing* a dense medium is any fluid denser than water—e.g. a suspension of magnetite in water. See below.
- dense medium cyclone, heavy m. c.** A *wet cyclone* through which there is a circulation of *dense medium*, used in *mineral dressing* to separate coal or metallic mineral from stone.
- dense medium treatment** *Float and sink* treatment, the use of *dense medium cyclones*, etc.
- dense mineral** *Garnet, ilmenite*, magnetite are used in *dense media* as well as in *multi-media filters*.
- dense non-aqueous phase liquids** See *non-aqueous phase liquids*.
- densifier** A *pelletiser* (briquetting unit) for *refuse derived fuel*.
- density current, gravity c., suspension c., turbidity c.,** (also *internal flow, layered f., subsurface f., stratified f.*) With two similar bodies of water in contact, if one is warmer than the other, the warmer water rises and flows horizontally over the colder. Similarly, clean, fresh water entering a body of salty or dirty water at the same temperature travels over the *brine* or dirty water, because it is lighter. Likewise, silt-laden water or brine entering fresh water at the same temperature travels along the bed, because it is denser. In *sedimentation tanks* such density currents can be caused by a temperature difference of only 0.2 °C. They create large stagnant areas in the tank and may reduce the actual retention time in the tank by up to 25%. See *destratification of lakes and reservoirs, thermal stratification*.
- density separation** *Gravity separation, skimming*, the use of a *centrifuge* and, occasionally, *flotation*.
- dental fluorosis** See *fluorosis*.
- deoxygenation** Depletion of dissolved oxygen, desirable in the *feed water* of a high pressure boiler but undesirable in aerobic biological treatment of wastewater or rivers, where it is caused by the activity of *aerobes* that use the dissolved oxygen to oxidise organic materials to carbon dioxide, water and nitrate. See *deaeration*.
- dependable yield** *Firm yield*.
- deposit gauge** A method of measuring the grit and dust in air. A simple gauge uses a slide with a sticky horizontal surface on which particles adhere. The slide is exposed to the air for a given period of time and the slide is then analysed. A more sophisticated approach is the *cascade impactor* or *directional deposit gauge*.
- depression storage** Stormwater that collects in small depressions in the surface preventing the water from running off.
- depth filter** In air or water pollution control, filters that remove particles throughout the filter body. The term is often restricted to mean filters that



contain rows of parallel fibres across the gas or water flow. They are used for cleaning air for industrial clean rooms (*high efficiency air filters*, HEAF). They are also used for collection of fine liquid drops from a gaseous effluent. In water treatment *microfiltration* is an example of a depth filter. *Compare surface filter. See rapid deep bed filter.*

**dermal contact** Skin contact.

**desalination, desalting, desalimization** Removal of dissolved salts from water.

The term is usually confined to any of the processes for making drinking water out of sea water (3.5% salts or 35 000 mg/l) or from *brackish waters*. Drinking water should have less than 500 mg/l of total dissolved solids. If the wastewater from desalination becomes saturated with a salt, it may precipitate out and block pipes or create other problems, particularly in *membrane processes*.

**desalination factor** The concentration of dissolved substances in the influent water of a *desalination process*, divided by their concentration in the desalted water.

**desalination processes** *Distillation, multi-stage flash distillation*, and the *membrane processes of electrodialysis and reverse osmosis*.

**desilting** Removal of *silt*—a preliminary treatment for raw water, with *sedimentation* for only 0.5 to 1 h, used for very turbid waters (more than 10 000 mg/l of suspended solids) if no other storage is available for the water before *clarification*.

**design storm** The rainfall frequency and duration which is used for the design of flood prevention or *urban pollution management* schemes.

**desliming** Removal of particles smaller than about 0.5 mm from a mineral pulp so as to make it more easily treated in a *wet cyclone* or other *mineral dressing* unit. Fine material is the most difficult and expensive both to extract and to dry afterwards.

**desludging** Removal of *sludge* from a *sedimentation tank, septic tank*, etc. *See telescopic valve.*

**desorb, desorption** Removal of adsorbate after *adsorption*.

**destabilisation of particles** The removal of electrical charge from particles of *colloidal* size or smaller, as in *coagulation*, enabling the particles to coalesce so that they can then be removed.

**destratification of lakes** The summer *thermal stratification* of lakes or reservoirs into an *epilimnion* layer above, separated by a *thermocline* from the cold *hypolimnion* below, prevents mixing of the waters and reduces the quantity of the water. Consequently, some lakes are destratified by pumping the hypolimnion up to the epilimnion. *Bubble guns* may be used. Another method is to inject some incoming river water through jets near the bottom of the reservoir. The dissolved oxygen content of the hypolimnion is improved by the mixing, which also reduces the temperature gradient in the water. Sulphide concentrations up to 10 mg/l that occur in midsummer in the bottom are eliminated by the mixing. The ammonia, iron and manganese contents also are reduced. Algal growth is usually reduced which can reduce problems in water treatment. *See blooms.*

**destruction and removal efficiency, DRE** A term often applied to the destruction and removal of hazardous waste, for example in incinerators.

- A common usage is to state four 9s or five 9s DRE. This means a destruction and removal efficiency of 99.99% or 99.999% respectively.
- Desulphovibrio desulphuricans*** A *sulphate reducing bacterium* that exists in *anaerobic* conditions and forms sulphides. It is often present in *septic sewage*. It is *heterotrophic*, consuming organic carbon which is oxidised as the sulphates are reduced to sulphides.
- desulphurisation, desulphurization, desulfurisation, desulfurization** See *flue gas desulphurisation*.
- detention basin or pond or tank** A pond, lake or tank or other water storage area used for the temporary storage of stormwater in order to reduce the extent of flooding or to reduce the quantity of stormwater runoff. Some sedimentation of particulates occurs in the pond. Plants may be used in the area to produce *bioretention*. See *extended detention basin, retention pond*.
- detention time, d. period** *Retention time*.
- detergents** *Synthetic detergents, dispersants, emulsifiers*.
- detinning** Removal of the tin coating from the tinplate from cans. Scrap steel for steelworks is regarded as of good quality and is relatively highly priced if it contains less than 0.03% tin.
- detritivores** Organisms that feed on particulate detritus.
- Detritor** A square horizontal flow *grit chamber*. The inlet is arranged so that the flow is evenly distributed across the tank, with a velocity of 0.3 m/s at maximum flow. The grit is removed and sent to a *classifier*. *Surface loading rates* are typically  $200 \text{ m}^3 \text{ m}^{-2} \text{ day}^{-1}$  at maximum flow. If operated correctly, Detritors can produce a very clean grit.
- detritus** (1) Abrasive material, such as sand or cinders, removed in a *grit chamber*. (2) Accumulated, dead or dying vegetation or animals.
- detritus chamber** A *grit chamber*.
- developing countries** See *O and M, rural sanitation in developing countries, water supply in developing countries*.
- dewaterability** The ability of a *sludge* to lose water; effectively the same as *filterability* of a sludge.
- dewatering of sludge** Removal of water from sludge. Various processes may be used, including *mechanical dewatering of sludge* or *sludge drying beds*. The typical 65 to 80% water content of dewatered sludge varies with the method of dewatering and the nature of the sludge. See also *conditioning, sludge thickening*.
- dewpoint** The highest temperature of a particular gas or air sample at which it deposits moisture—a measure of its moisture content or *relative humidity*. The higher the dewpoint the higher the moisture content. See *acid dewpoint*.
- dezincification** Corrosion of brasses and other copper—zinc alloys by the removal of zinc. It is aggravated by chlorides in the water. It can occur with a hot or cold water of pH above 8.2, and at pH less than 8.2 in hot water only, when the chloride content is not low enough in relation to the accompanying *carbonate hardness*. Meringue dezincification is a name for the fluffy white corrosion product of zinc carbonate. Some 0.2% arsenic in brass prevents dezincification provided that there is less than 35% zinc in the brass. See *cuprosolvency*.

**diagonal flow pump** A *mixed flow pump*.

**dialysis**, (verb *dialyse*) Separating a *colloid* from a solution by a *semi-permeable membrane* through which the solution diffuses. Dialysis in *hydro extraction* helps in *concentrating viruses*, and in *electrodialysis* purifies water.

**diaphragm press** A *membrane press*.

**diaphragm pump** A pump in which a flexible membrane is pushed and pulled in an enclosed cavity. The flow is directed through the cavity by appropriate inlet and outlet valves. Diaphragm pumps can only pump low volumes at the low heads.

**diarrhea** The USA spelling of diarrhoea.

**diatomite, diatomaceous earth, kieselguhr, moler earth, tripolite** A soil composed of the tiny siliceous skeletons of *diatoms*, therefore mainly insoluble, and used in *precoated filters*.

**diatomite filter** A *precoated filter* with a slurry of *diatomite* as the precoat, laid on *filter candles* to collect the *suspended solids*. Diatomite filters do not need *coagulants*, but the filter candles need recoating with new diatomite after *backwashing*.

**diatoms, Bacillariophyta** Unicellular algae with a silicified cell wall that divides the cell in two. They often occur in large masses and are common in sea water or fresh water.

**diazinon** A common organophosphorus insecticide used to control insects on fruit and vegetable field crops.

**dibenzofuran, polychlorinated dibenzofuran, PCDF, chlorinated dibenzofuran, CDF** A group of compounds that are extremely toxic. The structure includes chlorine atoms substituted onto two benzene rings (see *Figure D.2*). They can be formed during the incineration of waste that contains chlorinated plastics. No dibenzofurans should be formed if the incinerator temperature is maintained above 850 to 900 °C for at least two seconds, or 1000 °C for one second. The analysis for dibenzofurans is lengthy and normally only one or two compounds in the group are monitored, for example, 2,3,7,8 tetrachlorodibenzofuran (TCDF), or pentachlorodibenzofuran (PeCDF). HxCDF is hexachlorodibenzofuran. HpCDF is heptachlorodibenzofuran.

**dibromoacetic acid** See *haloacetic acids*.

**dibromochloromethane, CHBr<sub>2</sub>Cl** See *trihalomethanes*.

**1,2-dibromo-3-chloropropane, DBCP C<sub>3</sub>H<sub>5</sub>Br<sub>2</sub>Cl** A fungicide that is carcinogenic to humans and affects the reproductive system. The *USEPA MCL* in drinking water is 0.2 µg/l. The WHO guideline maximum value for drinking water is 1 µg/l. The EU Drinking Water Directive states a mandatory maximum of 0.1 µg/l.

**dibromoethane** *Ethylene dibromide*.

**dibutyl phthalate, DBP.** See *phthalates*.

**dichloramine, NHCl<sub>2</sub>** See *chloramines*.

**dichloroacetic acid** See *haloacetic acids*.

**dichlorobenzenes** 1,4-dichlorobenzene (p-dichlorobenzene or para-DCB or p-DCB) is a *chlorinated benzene* used to control moths, moulds and mildew, and as a deodoriser. It is a hazardous waste. At high exposure in humans

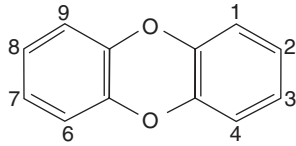

Numbering system for dioxin

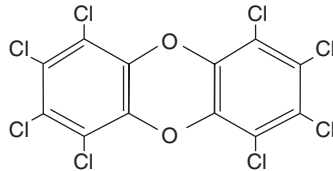

Octochlorodibenzo-*p*-dioxin (OCDD)

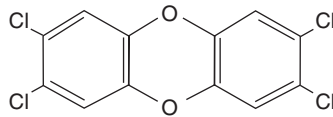

2,3,7,8-Tetrachlorodibenzo-*p*-dioxin (2,3,7,8-TCDD)

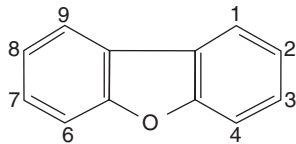

Numbering system for dibenzofuran

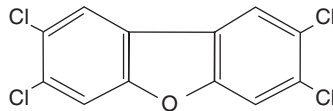

2,3,7,8-Tetrachlorodibenzofuran (2,3,7,8-TCDF)

**Figure D.2** Numbering system and examples of dioxins and dibenzofurans.

it can affect the liver and kidneys and cause anaemia. It may be carcinogenic. 1,2-dichlorobenzene (o-dichlorobenzene or ortho-DCB or o-DCB) is used in the production of some herbicides and solvents. It has similar health effects on humans. The *USEPA* sets a *MCL* for 1,4-dichlorobenzene of 75 µg/l in drinking water and 0.6 mg/l for 1,2-dichlorobenzene. The corresponding *WHO* guideline maximum values are 0.3 mg/l for 1,4-dichlorobenzene and 1 mg/l for 1,2-dichlorobenzene.

**1,2 dichloroethane, ethylene dichloride,  $C_2H_4Cl_2$**  An organic chemical that may be used in the production of vinyl chloride and solvents. It can damage the central nervous system, heart, liver and kidneys. At high exposures it may be carcinogenic. The *USEPA MCL* in drinking water is 5 µg/l. The WHO guideline maximum value is 30 µg/l. The EU Drinking Water Directive gives a mandatory maximum of 3 µg/l. The EU lists it as a *priority substance* in relation to aquatic discharges. See *chloroethanes*.

**dichloroethenes, dichloroethylenes,  $C_2H_2Cl_2$**  Organic chemicals that may be used in the production of solvents and some plastics. The health effects include possible damage to the liver and the nervous system. 1,1-dichloroethene is a possible carcinogen but 1,2-dichloroethene is not. The *USEPA MCL* in drinking water is 7 µg/l for 1,1-dichloroethene and 70 µg/l for 1,2-dichloroethene. The corresponding WHO guideline maximum values are 30 µg/l and 50 µg/l respectively. See *chloroethenes*.

**dichloromethane, methylene dichloride, methylene dichloride,  $CH_2Cl_2$**  A chemical used as an industrial solvent. It may cause an increased risk of developing cancer and may adversely affect the central nervous system and liver. It is a weak *greenhouse gas*. The *USEPA MCL* in drinking water is 5 µg/l. The WHO guideline maximum value is 20 µg/l for drinking water. The EU lists it as a *priority substance* in relation to aquatic discharges.

**2,4 dichlorophenoxyacetic acid** See *2,4-D*.

**2,4-dichlorophenoxybutynic acid** See *2,4-DB*.

**1,2-dichloropropane, 1,2-DCP,  $C_3H_6Cl_2$**  An insecticide that is toxic to humans. At high exposures it is carcinogenic and adversely affects liver, kidneys and lungs. The *USEPA MCL* in drinking water is 5 µg/l. The WHO guideline maximum value for drinking water is 40 µg/l. The EU Drinking Water Directive states a mandatory maximum of 0.1 µg/l.

**dichlorprop** Dichlorophenoxypropionic acid, one of the *chlorophenoxy herbicides*. The WHO guideline maximum value is 0.1 mg/l in drinking water. The EU Drinking Water Directive states a mandatory maximum of 0.1 µg/l.

**dichromate value, dichromate oxygen demand** See *COD*.

**dicophane** Another name for *DDT*.

**die drawing** In *water pipe rehabilitation*, techniques in which the new plastic pipe has a slightly larger diameter than the host pipe. The two common techniques are *rolldown* and *swagelining*.

**dieldrin** A *cyclodiene* insecticide that is toxic to humans affecting the human nervous system and kidneys. It can undergo *biomagnification* in food chains. The WHO guideline maximum value in drinking water is 0.03 µg/l. The EU Drinking Water Directive mandatory maximum is the same as the WHO standard. Dieldrin is an isomer of *endrin*.

**di (2-ethylhexyl) adipate DEHA** An organic chemical that is used as a plasticiser in plastics, particularly PVC. The *USEPA MCL* in drinking water is 0.4 mg/l. The WHO guideline maximum value for drinking water is 0.08 mg/l. The *USEPA* has recently removed this chemical from its list of toxic chemicals.

**di (2-ethylhexyl) phthalate DEHP** An organic chemical that is widely used as a plasticiser in plastics, particularly PVC. It is also used in inks, pesticides and cosmetics. High levels of exposure can affect the liver and kidney in humans and the reproductive system. The *USEPA MCL* in drinking water is 6 µg/l. The WHO guideline maximum value for drinking water is 8 µg/l. The EU lists it as a *priority substance* (under review for possible re-grading as a priority hazardous substance) in relation to aquatic discharges.

**differential medium** A *selective medium*.

**diffused air system, diffused aeration** (1) An *activated sludge* treatment with air bubbled into the aeration tank through *diffusers* (1) normally as *fine bubble aeration* or possibly as *coarse bubble aeration*. (2) See *air stripping*.

**diffuse pollution sources** See *non-point sources*.

**diffuser** (1) Or air diffuser. In the *activated sludge* process, a device for dissolving air in the *mixed liquor*. Swinging pipe diffusers have the advantage that they can be swung out of the tank. For diffusers fixed to the bottom of the tank, access is possible only by emptying the tank. Fine pore diffusers are plates, domes or tubes made of ceramic materials or of fused silica or alumina. Non porous diffusers are often perforated metal tubes. Fine pore diffusers must use filtered air or they clog. See *oxygenation efficiency*. (2) On a wastewater *outfall*, the perforated end of the pipe, which spreads the effluent effectively, merely by the shape and layout of the holes. (3) In a *centrifugal* pump, the guide passages around the *impeller*, which enable it to lift clean water through high heads.

**digested sludge** Wastewater sludge which has undergone *anaerobic sludge digestion* or passed through an *aerobic digester* should have a fibrous structure and a peaty smell which is not unpleasant, unlike *raw sludge*, but it still may contain some pathogenic organisms.

**digester** A tank or other reactor that is used for *digestion*.

**digester gas** The gases released from microbial digestion of organics, although it commonly means the methane and CO<sub>2</sub> released from *anaerobic digestion* such as from a *landfill* site or from *anaerobic treatment* of a wastewater. See *landfill gas, sludge gas*.

**digesting, digestion** The breaking down of complex molecules into simpler molecules. Soil samples may be digested in boiling acid in order to solubilise the metal ions prior to analysis. In the *COD* test, organics are digested by boiling chromic acid. Micro-organisms can digest organics aerobically (*aerobic digestion*) such as *composting* or anaerobically (*anaerobic digestion*) such as *anaerobic sludge digestion*.

**dilute and disperse** The disposal of a wastewater or waste gas, possibly without treatment, such that it disperses and dilutes in the receiving environment. For example, a *landfill* site in which the *leachate* is allowed to permeate from the site into surrounding ground. The leachate dilutes and disperses as it flows from the site. The chemicals in the leachate may undergo *attenuation* as they pass through the ground.

**dilution** The usual ultimate method of disposal of wastewater effluent into a river or the sea or a lake, or of many pollutants into the air, although many of them are washed out of the air by rain.

**dilution factor** The *available dilution*.

**dilution number for taste and odour, DN, dilution to threshold, D/T, odour dilution unit, ODU, threshold odour number, TON** A quantitative value for the measurement of taste and odour in water or the odour in air. A panel of testers finds the volume of dilutant (using clean water or air) that is required so that no taste or odour is discernible from the sample for half the panel. This volume divided by the volume of the original sample is the dilution number. The EU Drinking Water Directive 1980 specified a maximum DN of 3 at 25°C and a DN of 2 at 12°C in drinking water. The 1998 EU Drinking Water Directive states that the taste and odour must be acceptable to the consumer. See *butanol wheel, olfactometer, scentometer*.

**dimictic** A term that describes two turnovers of a lake in one year. See *thermal stratification*.

**di-n-octylphthalate, DnOP** *Di (2-ethylhexyl) phthalate*.

**di-octyl phthalate** *Di (2-ethylhexyl) phthalate*.

**dinoflagellates** Unicellular flagellate algae that can produce 'red tides' in the sea. *Pfiesteria piscicide* is a dinoflagellate that lives in estuarine waters. It releases *endotoxins* that can cause skin rashes, vomiting and other health effects in humans, such as fishermen, who come into contact with the water.

**dioxin, polychlorinated dibenzodioxin, PCDD, chlorinated dibenzodioxin, CDD** A group of compounds that are extremely toxic. They consist of chlorine atoms substituted onto two benzene rings (see *Figure D.2*). They can be present as a contaminant in defoliants (see *agent orange*) or other chlorinated organics as with the Seveso incident of the release into the atmosphere of trichlorophenol contaminated with dioxin. Dioxins can be formed during the incineration of waste that contains chlorinated plastics. No dioxins should be formed if the incinerator temperature is maintained above 850 to 900°C for at least two seconds, or 1000°C for one second. Some dioxin re-formation may take place in the downstream gases when the temperature is around 300°C. The analysis for dioxins is lengthy and normally only one or two compounds in the group are monitored, for example 2,3,7,8 tetrachlorodibenzo-p-dioxin (TCDD); octochlorodibenzo-p-dioxin (OCDD) are two of the most toxic and are often chosen when monitoring for dioxins. PeCDD is pentachlorodibenzo-p-dioxin, HxCDD is hexachlorodibenzo-p-dioxin, HpCDD is heptachlorodibenzo-p-dioxin. The *USEPA* for TCDD state an *MCL* for drinking water of 0.00003 µg/l.

***Diphyllobothrium latum*** A broad *tapeworm* transmitted by eating infected freshwater fish and some *crustaceans* that have received the infection from the faeces of infected humans, dogs, etc. The disease can be reduced or eliminated by proper cooking. The worm grows to enormous lengths in the intestine and causes anaemia.

**diplo** A twin. All rod shaped bacteria are diplos just before they divide.

**dip pipe** An outflow pipe for effluent from, e.g. a *septic tank*, which dips below the water surface to avoid removing scum or by the scum.

**Diptera** The main *insect* inhabitants of *trickling filters*, usually flies with one pair of wings, but the group includes midges, *mosquitoes*, gnats and some *filter flies*.

**diquat** A common herbicide, particularly used as a weed killer. It can be used on surface water to control aquatic weeds. The *USEPA MCL* in drinking water is 20 µg/l. The WHO guideline maximum value is 10 µg/l in drinking water. The EU Drinking Water Directive states a mandatory maximum of 0.1 µg/l.

**direct dryer** See *rotary dryer*.

**direct filtration** The use in water treatment of small quantities of *coagulant* (e.g. less than 10 mg/l of alum) followed directly by *rapid gravity filters* without clarification or dissolved air flotation.

**direct flame incineration** Burning of an air pollutant such as CO or hydrocarbons to produce an inert end product, e.g. the use of an afterburner.

**directional deposit gauge, d. dust g.** Deposit gauges in which the assembly allows for the collection of dust and grit to be related to the direction of the wind.

**direct re-use of wastewater** The re-use of treated wastewater effluent for agriculture, irrigation, use in toilet flushing, etc. The wastewater requires extensive and costly treatment prior to direct re-use as consumable water supply.

**direct supply reservoir** An *impounding reservoir* which supplies *upland catchment water* to a city through an *aqueduct* (Figure D.3). To maintain the quality of the water, the reservoir may not be open for public recreation. A *river regulating reservoir* has multiple uses.

**disc centrifuge, nozzle bowl c.** A common industrial *centrifuge* which produces a thick slurry rather than a *sludge cake*. The liquid moves up through a stack of conical discs, the solids moving to the outside of the centrifuge.

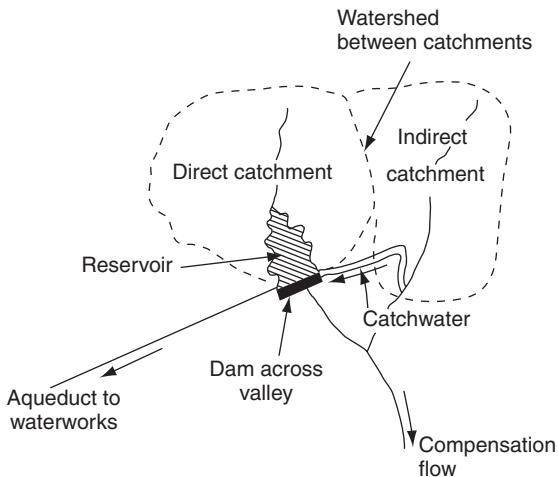

Figure D.3 Direct supply reservoir.



They have been used to thicken waste *activated sludge*, but they cannot dewater sludge to a cake as this blocks the gaps between the discs.

**disc filter** A type of *vacuum filter*.

**discharge** A volume per unit time; a flow e.g. cumec ( $\text{m}^3/\text{s}$ ).

**discharge prevention** An *acid mine drainage* pollution control method aimed at holding all contaminated water within the mine workings. The sulphides are submerged and their rate of oxidation and production of acid are thereby reduced. This involves the expense of building watertight dams underground and injecting the rock around them with cement mortar. Such dams have been built in coal mines as well as at sulphide mines.

**discharge units for wastewater pipes** A method for aggregating the number of water using facilities (toilet, bath, sink, etc.) in a building so that the appropriate *stack* (1) size can be adopted. The frequency of use of the facilities is included in the method.

**disc mill** A *mill* with horizontal grinding discs. The lower, stationary disc has holes in it through which the material passes when it has become small enough. The upper disc has knobs that strike the refuse. The lower disc also may rotate (multiple disc mill) but in the opposite direction to the upper one. The exit for the crushed refuse then is at the rim, not through holes in the lower disc.

**disconnecting trap** An *intercepting trap*.

**discrete settling** See *settling regimes*.

**disc screen** A circular *screen* used in water or wastewater treatment, which rotates in its own plane, perpendicular to the line of flow.

**disinfection** Destruction of pathogens that cause disease. It is not sterilisation, which is the destruction of all microscopic life. In water treatment, the disinfecting agent must be effective against human pathogens but safe after dosing for use of the water by humans. The chemical must be easily handled, dispensed and monitored and be of reasonable cost. Chlorine is commonly used as a water disinfectant (see *chlorination*). Alternatives include *ozone*, *chlorine dioxide*, *chloramines*, *bromine*, *iodine* or silver. Non chemical disinfecting agents include *UV radiation*. Various water quality factors influence the effectiveness of disinfection, such as pH, temperature, turbidity or other chemical components in the water. See *peroxyacetic acid*, *wastewater disinfection*.

**disinfection by-products** Disinfectants, such as chlorine, react with a number of chemicals present in the water or wastewater. Some of these by-products are dangerous to health, while others are disinfectants. See *chloramines*, *haloacetic acids*, *trihalomethanes*.

**disintegration product** A *decay product*.

**disintegrator** (1) In dust collection many types of disintegrator exist but all have a rapidly turning wheel with water flowing on to it. The movement of the wheel breaks up the water into minute drops projected into the dusty gas, which help to catch the dust. (2) In wastewater *preliminary treatment*, a device that cuts up and shreds the large solids either in the wastewater flow or after the screenings have been removed (a screenings disintegrator). Devices in the flow can be a centrifugal pump with cutting edges on

the impellers (a macerator pump) or a *comminutor* (see *Figure C.4*) or devices that contain rotating steel cutters.

**disintegrator scrubber** A *wet scrubber*.

**dispersal** Spreading out—*dilution*.

**dispersant** A *synthetic detergent* or *emulsifier* used for washing oil from polluted beaches, sometimes also for emulsifying the oil before it has beached. These substances can be poisonous to *shellfish* at trace concentrations. Their purpose is to produce oil in water *emulsions* that spread the oil and thus enable microorganisms to reach the oil and destroy it. See *chocolate mousse*, *scavenging*.

**dispersed air flotation** A *froth flotation* method in which 1 mm diameter bubbles are blown into wastewater by *diffusers* or *spargers* so as to remove grease and oils before *sedimentation*.

**disperse phase** Part of an *emulsion* or *dispersion*.

**dispersion** A gas, liquid or solid in which one substance, the disperse phase, is distributed throughout the other, the continuous phase. *Emulsions* and solutions are dispersions in this sense, but many others exist. (Not the same as *dispersal*.)

**dispersion of air pollutants** See *plume dispersion*.

**dispersoids** Liquids dispersed as droplets in air or other space as clouds, *mist*, *fog*, *smog*, spray, etc.

**disposal bed or pit** See *absorption pit*.

**disposal field** A *soakaway*.

**disposal well, injection well** Wells used for disposal of wastewater or hazardous liquids into pervious ground. This practice can seriously affect the quality of the groundwater. See *deep well injection*, *well pollution*.

**dissolved air flotation, DAF** A treatment process in which water or wastewater or sludge is saturated with air and then flows to a tank where the air comes out of solution in tiny bubbles less than 100  $\mu\text{m}$  that floats the sludge and enables it to be skimmed off. *Coagulants* may be added to help form *flocs*.

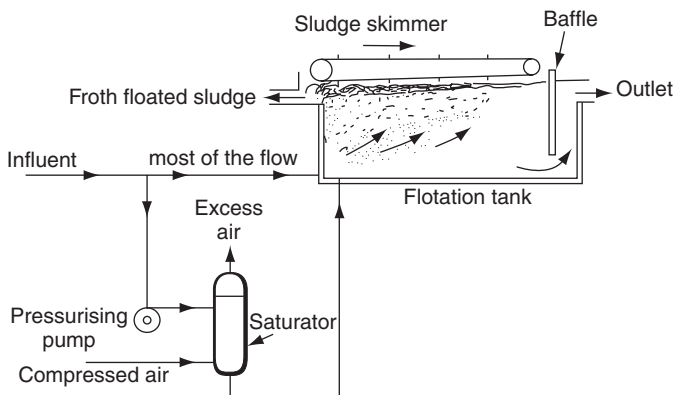

**Figure D.4** Dissolved air flotation.

Two methods of DAF have been used. The less common is vacuum flotation, in which a short period of aeration at atmospheric pressure is followed by application of vacuum in a separate tank. The common technique takes a small part of the flow to an air saturator in which water, wastewater or sludge is aerated for a few minutes at 3 to 4 atmospheric pressures. When the aerated and pressurised flow rejoins the main flow, the dissolved air coming out of solution attaches itself to the flocculated particles or sludge and floats them (see *Figure D.4*). In water treatment, the DAF tank usually follows the *flocculator* tank to form a flocculator—DAF unit. The tanks are 2 to 3 m deep. The water with coagulant flows through the flocculator zone with a retention time of about 15 minutes. The water then passes to the DAF zone which is designed on *surface loading rates* of about  $8 \text{ to } 12 \text{ m}^3 \cdot \text{m}^{-2} \cdot \text{hr}^{-1}$ . The sludge scraped off the tank is about 3% solids. Some water supply companies routinely choose DAF instead of clarifiers in water treatment works. In the thickening of mixed wastewater sludges, a typical design is 100 kg of dry solids per  $\text{m}^2$  of tank per day to produce sludge with 5 to 7% solids. For waste activated sludge alone, this loading should be halved and the thickened sludge may be less than 4% solids.

**dissolved organic carbon, DOC** The *total organic carbon* which remains in solution after filtration of the water or wastewater.

**dissolved oxygen, DO** Oxygen dissolved in water is needed for the existence of *aerobic* water life, but the solubility of oxygen in water is low. The maximum at  $0^\circ\text{C}$  is only 14.6 mg/l at sea level, falling to 10 mg/l at  $16^\circ\text{C}$ . At chlorides concentrations of 5000 mg/l (0.5%) the solubility falls to 9.5 mg/l at  $16^\circ\text{C}$ ; with 10 000 mg/l of chlorides, to 9 mg/l. All this applies at atmospheric pressure. But when the external gas pressure increases manyfold, as occurs in the *deep shaft system*, the solubility of oxygen rises and much more oxygen dissolves. In steam boilers dissolved oxygen causes corrosion and must be removed from *feed water* before it enters the feed pump. The damage done by oxygen can be especially serious in boilers operating at pressures above about 17 atm. DO is measured by *dissolved oxygen electrodes* or by the *Winkler test*.

**dissolved oxygen electrodes** For measuring *dissolved oxygen* in water, a constant voltage is applied across *electrodes* covered by a *membrane*. The oxygen diffusing through the membrane causes a current to flow that is directly proportional to the oxygen concentration.

**dissolved oxygen sag curve** The *oxygen sag curve*.

**dissolved solids** See *total dissolved solids*.

**distillation** Boiling followed by *condensation* of the vapour, a common method of *desalination* of sea water, used at sea for many years. See *multistage flash distillation*.

**distillation of hazardous waste** Hazardous volatile material can be boiled off from the liquid phase. The vapour is then condensed and collected for re-use or disposal.

**distillery wastewater** The liquid wastes after producing whisky, etc., from grain are high in dissolved or suspended organic substances, but much of the solid matter is recovered for sale as animal feed. The remaining

- liquid has a pH of 4.5, a BOD<sub>5</sub> of about 500 mg/l and suspended solids up to 1000 mg/l. The wastewater is readily biodegradable.
- distribution mains** Water pipes that form a network in a given locality, thereby serving the users together with the fire hydrants.
- distribution modelling** See *water distribution network modelling*.
- distribution reservoir** A *service reservoir*.
- district heating** See *waste to energy plants*.
- disulfoton** A pesticide that is used on fruit and vegetable field crops.
- diurnal demand** The variation in demand over a 24 hour period.
- diuron** A widely used persistent herbicide. The EU lists it as a *priority substance* in relation to aquatic discharges.
- diversity index** Polluted water has a less diverse population of flora and fauna than an unpolluted water. This diversity can be measured and used as an index for pollution. Various indices exist but all measures have the number of species over the total population, so indices reduce with increasing pollution. Examples include the *Margalef's index* and the *Menhinick's index*. See *biotic index*.
- divide** A *watershed*.
- DNAPLs** Dense non-aqueous phase liquids. See *non-aqueous phase liquids*.
- DO** *Dissolved oxygen*.
- DOC** *Dissolved organic carbon*.
- dome diffuser** See *diffuser*.
- domestic waste, d. refuse, household waste** Waste from households may have around 20 to 30% from waste food. Plastics make up about 10%, paper and cardboard a further 30 to 40%. The remaining is dust, glass metals, etc. In countries where garbage grinders are popular, the quantity of waste food going into the solid waste stream substantially reduces. In developing countries the percentage of metals, plastics or other recyclable material is very low because someone in the poorer economic community recycles anything that has any local value. See *garden waste, organics in solid waste*.
- Donaldson sludge density index** The *sludge density index*.
- Dorrclone classifier** A *wet cyclone* used in wastewater treatment to wash grit by centrifugal force after it has been removed from the *grit chamber*.
- Dortmund tank, Kniebuhler t.** A type of *upward flow sedimentation tank* with an elaborate inlet distributor and a grid of surface *weirs*. Many so-called Dortmund tanks have, however, mixed radial and upward flow.
- dosing siphon** A *siphon* that empties a *dosing tank* when it is full (*Figure D.5*).
- dosing tank** A tank in a wastewater treatment works in which wastewater collects until there is enough in it to operate the next treatment process. Where *trickling filter* influent is spread by *distributors* turned by the reaction of the water flowing out of them, dosing tanks ensure that the flow is fast enough to rotate the distributors. When the dosing tank is full, it empties quickly through the *dosing siphon*. There is thus no flow except when there is enough influent to rotate the distributor. See *tippling trough*.
- DOT** The USA Department of Transport. See *hazard codes*.
- double bed filter** A *dual media filter*.

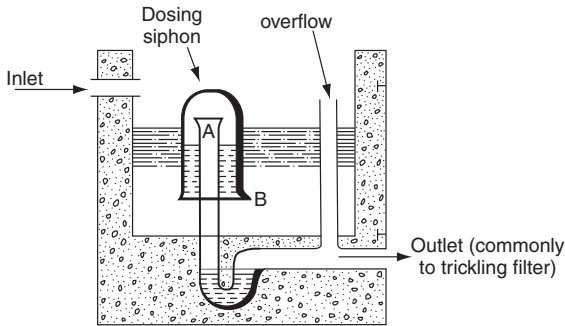

**Figure D.5** Dosing siphon. As soon as the level rises to the top of the pipe A, under the dosing siphon bell, it flows out through A until the level drops to B, admitting air to the bell and the siphon is stopped.

**double liner** A lining system at the base and sides of a *landfill* site in which two liners are installed with a drainage layer between them. Drainage layers are also installed above the first layer to collect the leachate and below the second layer. The layers may be *geomembranes* or compacted clay. This system may be appropriate for landfill sites containing hazardous waste material. See *landfill liner*.

**double shredding, d. pulverising** *Two stage shredding*.

**double side weir overflow** See *side weir overflow*.

**double vaulted pit latrine, twin pit latrine** A *pit latrine* (Figure P.6) which has two adjoining pits. One pit is covered when full in order to allow the material to digest. Meanwhile the other pit is used and it has the squatting plate and superstructure above it. After 12 to 24 months of use, the pit is full. The pit with the digested material is dug out and used with the squatting plate and superstructure. The recently filled pit is covered and left to digest.

**doubling time** *Generation time*.

**downdraught, downwash** On the lee side of a building downward eddying wind may occasionally bring smoke near the ground. Chimney heights should ordinarily be at least 2.5 times as high as the nearest tall building, usually the boiler house. See *plume dispersion* and Figure P.8.

**dispersion plume** See *plume dispersion*.

**DnOP** Di-n-octylphthalate, i.e. *di (2-ethylhexyl) phthalate*.

**DOP** Di-octyl phthalate, i.e. *di (2-ethylhexyl) phthalate*.

**downflow contactor** A downward flow *carbon adsorption bed*.

**down time, outage** Time during which equipment is out of action, especially for such reasons as maintenance and repair.

**DPD, N,N-diethyl-paraphenylene diamine** A substance used to test for the available *chlorine* in drinking water. It produces a red colour with *free residual chlorine*.

**Dracone** A synthetic rubber tube, a 'sausage' built to contain fluid and to be carried or towed—e.g. containing drinking water for a small island. Dracones have been adapted for use as floating booms.

**dracontiasis, dracunculosis, dracunculiasis, Guinea worm disease** A chronic infection caused by the nematode parasite *Dracunculus medinensis*. It is found in many parts of India, Africa, the Middle East, South America and the West Indies. Young adults appear to be the main victims. The adult worm burrows in the subcutaneous and deeper tissues and may cause itching and possibly fever, nausea and diarrhoea. The female worm, which may be up to 1 m in length, causes a skin blister which ruptures, discharging larvae, when immersed in water. The larvae infect the freshwater crustaceans, *Cyclops*, and transmission to humans is by ingestion of the infected crustaceans. Treatment is available for the worms, but the main method of control is by treatment of infected waters to destroy the larvae and crustaceans.

**draft** USA term for flow rate.

**draft tube** (1) A tube, connected to the outlet from a water turbine, which has a gradually varying diameter to vary correspondingly the speed and the pressure head of the water. (2) A vertical tube resting on legs on the floor of an *aeration tank*, directly below a *turbine aerator*. *Cone aerators* often have no draft tube, since the aerator itself can produce the required flow.

**dragon fly, Odonata** A large flying insect. The larvae can be found in clean river water and may be used in a *biotic index*.

**drag out** Unwanted dip paint, electroplating solution, etc., the liquid that drips off an object after it has been removed from a dip tank. Similarly, with *magnetic separators*, drag out may be paper, rags and dirt that are dragged out with the metal.

**drag scraping** A technique used to clean the inside of a water main prior to rehabilitation. It is a dry method in which a metal 'Christmas tree' is dragged through the main. The deposits are dislodged and removed.

**drainage area** The area draining to a *gully*, sewer, river, etc. It may be different from the natural *catchment area*.

**drainage area plan** See *sewer assessment*.

**drainage basin** A *catchment area*.

**drainage field, drainfield** A field or area used for *soakaways* in the treatment of wastewater effluent or stormwater.

**drain rods** Flexible rods about 1 m long, usually in sets of ten, made of cane or of tightly coiled steel springs with threaded ferrules at each end, which screw together and can be pushed to and fro in a drain to unblock it (rodding). The rods are inserted by a person in a *manhole* or at an *access eye*.

**draught stabiliser, barometric damper** A vertical metal plate pivoted horizontally and located in the wall of a *flue* to ensure that the *natural draught* to the furnace is not excessive. When the draught is too high, the plate is sucked inwards by the draught, admitting cool air to the flue and reducing the draught through the furnace. It automatically closes again when the draught diminishes, ensuring correct draught at all times.

**drawdown, dropdown** Lowering of a water or *groundwater* level—e.g. by withdrawal of water from a reservoir. See *cone of depression (Figure C.7)*, *specific capacity of a well*.

**DRE** Destruction and removal efficiency.

**Dreissena** A freshwater mussel.

**drift loss** Water lost from *cooling towers* as drops and water vapour carried out by the rising air stream.

**drift velocity** See *effective migration velocity*.

**Drinking Water Contaminant Candidate List, CCL A** list of microbial and chemical contaminants that the *USEPA* is considering for possible new drinking water standards. *Table D.1* lists these contaminants and the next stage in the evaluation. See also *National Primary Drinking Water Regulations*.

**Drinking Water Directives** The EU Directive, initially passed in 1980, defined the maximum admissible concentration (MAC) and guideline values for a range of chemical and microbiological parameters in drinking water for countries in the EU. The Directive was revised in 1998 revisions, which includes reducing the allowable lead concentration to 0.01 mg/l by 2014. The drinking water standards for various inorganics are listed in *Table D.2*. Various standards for organics, radioactivity and micro-organisms are listed under the specific compound or microbe.

**Drinking Water Inspectorate, DWI** The UK government body, established in 1990 and responsible for assessing the quality of drinking water in England and Wales, taking enforcement action if standards are not being met, and appropriate action when water is unfit for human consumption.

**drinking water standards** The World Health Organisation sets guidelines for drinking water quality throughout the world. They cover physical, chemical, microbiological and radiological quality parameters. The EU *Drinking Water Directive* defines mandatory maximum and non mandatory indicator values for a range of chemicals and microbiological parameters. In the USA, the *Safe Drinking Water Act (SDWA)* was passed in 1974 and set the maximum contaminant level (MCL) for drinking water quality in all USA states. Guideline standards (maximum contaminant level guide, MCLG) are also given. Numerous revisions and enhancements have been made to the SDWA. The MCLs for various inorganics are listed in *Table D.2 Drinking water standard*. Organics are listed under the specific compound. See *Surface Waters Directive*.

**drins** A name given to the group of insecticides that include *aldrin*, *dieltrin* and *endrin*.

**drip irrigation** *Surface irrigation* through pipes made of plastics, which deliver the water drop by drop to the plant through tiny holes in the pipes. This method reduces waste of water compared with other methods of spray or surface *irrigation*, and has been used with great success for irrigating orchards, strawberry beds, sugar cane plantations, etc., but it is unsuitable for closely planted crops such as wheat. The system brings the soil to *field capacity* near the plants and not away from them, so weeds are discouraged, but a major problem is clogging of the holes.

**drop** A liquid particle in air, larger than 0.2 mm (200  $\mu\text{m}$ ).

**drop box** An open topped, but screened, steel skip or similar container up to about 35 m<sup>3</sup> capacity, in which people can place their refuse.

**drop connection, d. manhole** A *back drop*.

**droplet** A liquid particle in air, smaller than 0.2 mm (200  $\mu\text{m}$ ).

**Table D.1** Drinking water contaminant candidate list: Some movement of contaminants between categories can be expected as more information is evaluated and analysed.

<i>Regulatory Determination Priorities</i>	<i>Health Research Priorities</i>	<i>Treatment Research Priorities</i>	<i>Analytical Methods Research Priorities</i>	<i>Occurrence Data Priorities</i>
<i>Acanthamoeba</i> (guidance)	<i>Aeromonas hydrophila</i>	Adenoviruses	Adenoviruses	Adenoviruses*
1,1,2,2-tetrachloroethane	Cyanobacteria	<i>Aeromonas hydrophila</i>	Cyanobacteria (blue-green algae),	<i>Aeromonas hydrophila</i>
1,1-dichloroethane	(Blue-green algae),	Cyanobacteria (blue-green algae), other	other freshwater algae,	Cyanobacteria (blue-green algae), other freshwater
1,2,4-trimethylbenzene	other freshwater algae,	freshwater algae, and	and their toxins	algae, and their toxins*
1,3-dichloropropene	and their toxins	freshwater algae, and		
2,2-dichloropropane	Caliciviruses	their toxins	Caliciviruses	Caliciviruses*
Aldrin	<i>Helicobacter pylori</i>	Caliciviruses	<i>Helicobacter pylori</i>	Coxsackieviruses
Boron	Microsporidia	Coxsackieviruses	Microsporidia	Echoviruses
Bromobenzene	<i>Mycobacterium avium</i>	Echoviruses	1,2-diphenylhydrazine	<i>Helicobacter pylori</i> *
Dieldrin	<i>intercellulare</i>	<i>Helicobacter pylori</i>	2,4,6-trichlorophenol	Microsporidia*
Hexachlorobutadiene	1,1-dichloropropene	Microsporidia	2,4-dichlorophenol	1,2-diphenylhydrazine*
p-Isopropyltoluene	1,3-dichloropropane	<i>Mycobacterium avium</i>	2,4-dinitrophenol	2,4,6-trichlorophenol*
Manganese	Aluminium	<i>intercellulare</i>	2-methyl-Phenol	2,4-dichlorophenol*
Metolachlor	DCPA mono-acid and di-acid	Aluminium	Acetochlor	2,4-dinitrophenol*
Metribuzin	degradates	MTBE	Alachlor ESA	2,4-dinitrotoluene



Naphthalene	Methyl bromide	Perchlorate	Fonofos	2,6-dinitrotoluene
Organotins	MTBE		Perchlorate	2-methyl-phenol*
Triazines and degradation	Perchlorate		RDX	Alachlor ESA* and
Products (incl., but not	Sodium (guidance)			Achetochlor*
limited to Cyanazine and				DCPA mono-acid and di-acid
atrazinedesethyl)				degradates
Sulfate				DDE
Vanadium				Diazinon
				Disulfoton
				Diuron
				EPTC
				Fonofos*
				Linuron
				Molinate
				MTBE
				Nitrobenzene
				Perchlorate*
				Prometon
				RDX*
				Terbacil
				Terbufos

---

\* Suitable analytical methods must be developed prior to obtaining occurrence data.

**Table D.2** Drinking water standards for inorganic chemicals. (Standards for organic chemicals and micro-organisms are given in the specific entry for the chemical or microbe.)

	<i>EU Drinking Water Directive 1998</i>		<i>USEPA</i>		<i>WHO guideline</i>
	<i>mandatory maximum<sup>1</sup></i>	<i>secondary non-mandatory indicator parameters</i>	<i>maximum contaminant level<sup>1</sup> (MCL)</i>	<i>secondary standards (non-enforceable)</i>	
aluminium		0.2 mg/l		0.05 to 0.2 mg/l	0.2 mg/l
ammonium		0.5 mg/l			1.5 mg/l
antimony	5 µg/l		6 µg/l		5 µg/l
arsenic	10 µg/l		50 µg/l		10 µg/l
barium			2 mg/l		0.7 mg/l
beryllium			4 µg/l		
boron	1 mg/l				0.5 mg/l
bromate	10 µg/l		10 µg/l		25 µg/l
cadmium	5 µg/l		5 µg/l		3 µg/l
chloramines			4 mg/l as Cl <sub>2</sub> (MRDL <sup>2</sup> )		3 mg/l
chloride		250 mg/l			250 mg/l
chlorine			4 mg/l as Cl <sub>2</sub> (MRDL <sup>2</sup> )		5 mg/l
chlorine dioxide			0.8 mg/l as Cl <sub>2</sub> (MRDL <sup>2</sup> )		
chlorite			0.1 mg/l		0.2 mg/l
chromium	50 µg/l		100 µg/l		50 µg/l
copper	2 mg/l		TT <sup>3</sup> action level 1.3 mg/l		2 mg/l
cyanide	50 µg/l		200 µg/l		
fluoride	1.5 mg/l		4 mg/l	2 mg/l	1.5 mg/l
hydrogen sulphide					50 µg/l
iron		0.2 mg/l		0.3 mg/l	0.3 mg/l
lead	25 µg/l until 2015 10 µg/l from 2015		TT <sup>3</sup> action level 15 µg/l		10 µg/l

manganese		50 µg/l		50 µg/l	50 µg/l
mercury	1 µg/l		2 µg/l		1 µg/l
molybdenum					70 µg/l
nickel	20 µg/l				20 µg/l
nitrate	50 mg/l as NO <sub>3</sub> <sup>-</sup>		10 mg/l as N		50 mg/l as NO <sub>3</sub> <sup>-</sup>
nitrite	0.5 mg/l as NO <sub>2</sub> <sup>-</sup> (0.1 mg/l as NO <sub>2</sub> <sup>-</sup> ex water treatment works)		1 mg/l as N		3 mg/l as NO <sub>2</sub> <sup>-</sup> acute 0.2 mg/l as NO <sub>2</sub> <sup>-</sup> chronic
odour <sup>(4)</sup>					
selenium	10 µg/l		50 µg/l		10 µg/l
silver				0.1 mg/l	
sodium		200 mg/l			200 mg/l
sulphate		250 mg/l		250 mg/l	250 mg/l
taste <sup>(4)</sup>					
thallium			2 µg/l		
total dissolved solids				500 mg/l	1000 mg/l
TTHM <sup>(4)</sup>					
turbidity <sup>(4)</sup>					
uranium			30 µg/l from 2003		2 µg/l
zinc				5 mg/l	3 mg/l

<sup>1</sup> Health effects of the contaminants are discussed under the chemical entry.

<sup>2</sup> MRDL Maximum Residual Disinfectant Level.

<sup>3</sup> TT Treatment Technique—required process to reduce contaminant level in water.

<sup>4</sup> See the appropriate entry under odour, taste, trihalomethane, turbidity.

**drop off centre** A facility where people can take and leave certain items of solid waste, e.g. bottles or paper, that can then be taken away for recycling.

**drum composter d. digester, rotary drum composter, r. d. digester** A method for *in-vessel composting* of organic waste by placing it in a rotating drum at the appropriate moisture content. Air is blown into the drum in order to maintain aerobic conditions. Composting of agricultural or food waste may be completed in 6 days. For domestic refuse it is used to partially complete the composting process. After segregation of the metals, plastics, etc. from the refuse, water or sludge is added to give 40 to 55% moisture. The refuse is then fed into the rotating drum for a few days and thereafter maturation of the compost is required possibly for many weeks.

**drum dryer** A *rotary dryer*.

**drum filter** A treatment process used for the *tertiary treatment* of wastewater effluent. It is similar to a drum screen but the horizontal drum is covered by a polypropylene cloth through which the effluent flows from the outside to the inside. This removes suspended solids. The drum rotates at 2 to 4 r.p.m. The cloth is periodically cleaned by washing it with the treated effluent. *Compare microstrainer.*

**drum pulveriser, d. pulverizer** *Wet pulveriser.*

**drum screen, rotary.** A cylindrical drum of fine stainless steel wire mesh, rotating in the raw influent wastewater separating the coarse solids from it (see *Figure D.6*). The wastewater passes into the drum radially and out axially, unlike the *cup screen*. The *screenings* wash off the drum as it rotates and they settle into a sump for removal by a pump or bucket elevator.

**drum thickener** See *rotary drum thickener.*

**dry adiabatic lapse rate** The *adiabatic lapse rate* in dry air which is 1 °C drop in temperature per 100 m rise in elevation.

**dry air pollution control, dry APC** An air pollution control system that does not use water, e.g. *dry scrubber, fabric filter, electrostatic precipitator.*

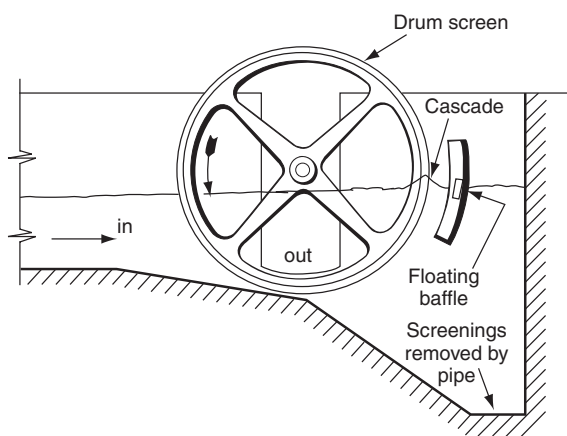

**Figure D.6** Drum screen (outlet axial), cross section.

- dry cooling tower** A type of *cooling tower* used in regions that are short of water. Its water circulates through cooling tubes without evaporating. It can be more expensive than a wet cooling tower. In cold weather, when they are not working, they can be damaged by frost unless they are drained, but this has not prevented them being used in countries with cold climates.
- dry cyclone** A *cyclone* (2) with no water spray as compared to a *cyclonic spray scrubber*.
- dry digestion** See *anaerobic digestion of municipal waste*.
- dry dry air pollution control, dry dry APC** An air pollution control system that contains processes none of which use water. For example, the gas stream from an incinerator can be treated by passing it through lime particles for SO<sub>2</sub> removal, followed by a fabric filter for removal of particles. Compare *wet dry air pollution control*.
- dryers** See *sand dryer, flash drying, rotary dryer, spray dryer*.
- drying bed** A *sludge drying bed*.
- dry landfill** See *entombment landfill*.
- dry plant design** A method of dealing with metal finishing effluents that involves piping each effluent separately to its own disposal or *neutralisation* point, enabling valuable chemicals to be reclaimed more easily.
- dry pulveriser, d. pulverizer** See *pulveriser*.
- dry reactor** In air pollution control, a reactor that does not use water. For example, a lime bed can be used to remove SO<sub>2</sub>.
- dry riser** An empty vertical pipe in a high building, with hydrant outlets at each floor. Fire engines connected to the street *fire hydrants* can pump water into the dry riser so that fires can be fought at any level from inside the building.
- dry scrubber** A method for cleaning gases in which no liquid is used. Odours in air can be scrubbed out by passing through *carbon adsorption beds* (GAC filters) or filters of activated. An alternative is to spray dry powder into the gases. The powder collects the unwanted gaseous pollutant and the powder is removed in a *fabric filter* or other device for particulate removal. For example, calcium hydroxide may be sprayed into the gases when cooled below 160°C to collect SO<sub>2</sub> and HCl from the gas as calcium sulphate and calcium chloride. See *flue gas desulphurisation*.
- dry solids content** The percentage of dry solids contained in sludge.
- dry weather flow, DWF, dwf** The average daily flow rate of wastewater on days when not more than 2.5 mm of rain has fallen in the previous 24 h. The DWF is often equal to the water consumption minus the *evaporation* plus the *infiltration* or minus the exfiltration. Although evaporation in temperate climates may be considered zero, in hot dry climates it may reach 40% of the water consumption. Infiltration may contribute from 0 to 30% of the DWF.
- dry well** The part of a pumphouse containing the pumps. It is separated by a wall or floor from the *wet well* containing the liquid to be pumped. The suction pipes to the pumps pass through this dividing wall. The dry well

allows work to be done on the pumps without draining the wet well and the pumps are self-priming.

**D/T Dilution to threshold** See *dilution number for taste and odour*.

**dual catalyst** A catalyst used to treat engine exhausts. The catalyst has two components, a catalyst to reduce *NO* and a catalyst to oxidise hydrocarbons and carbon monoxide.

**dual flushing system** A toilet system with the choice of releasing either 4.5 or 9 litres of water. Dual flushing systems can save water.

**dual media filter, doubled bed f., two layer f.** A type of *rapid deep bed filter* used for water treatment, in which the upper 0.2 to 0.4 m is anthracite of 1 to 2 mm size, lying above 0.4 to 0.6 m depth of 0.5 mm sand. This gives *coarse to fine filtration*. The coarser anthracite particles are less dense than the sand so the two layers remain in position after *backwashing*. Compared to a *rapid gravity sand filter*, the filter runs between backwashings can be longer or the design *surface loading rate* higher (12 to 20 m<sup>3</sup> m<sup>-2</sup> h<sup>-1</sup>) for the dual media filter. Water works may adapt their *rapid gravity sand filters* to become dual media filters in order to increase the throughput of water. See *multi-media filter*.

**dual supply system** Two water supplies, one for flushing WCs and another for drinking and cooking, often used in countries where drinking water is scarce.

**duckweed** A small freshwater plant that can be grown in ponds of wastewater effluent in order to remove nutrients, particularly phosphates. They have fast reproduction rates.

**ductile iron** Centrifugally iron spun pipe has a thinner and smoother finish than cast iron water pipe

**dumb well** An *absorption pit*.

**dust** Dust is particles in the air that are between 1 to 75 µm in diameter. *Respirable dust* is particles less than 5 µm, which can be deposited in the lung and can be a health hazard. See also *fly ash, fume, grit, particulates, Figure P.1*.

**dust arrester, d. collector** A device that removes dust. In *air pollution control* it includes *air filters, cyclones, electrostatic precipitators, gravity settling chamber, fabric filters, fan collectors, wet scrubbers* etc. See *Figure P.2*.

**dust bin** Formerly of galvanised steel, dust bins are now more often of polypropylene, which is much lighter and more resistant to corrosion but no stronger. In the 1960s dust bins began to be replaced by disposable sacks or by the wheeled dust bins of *dustless loading*.

**dust burden** The mass of dust in *flue gas*, air, etc., usually now expressed in g/m<sup>3</sup> of gas, or in g/m<sup>2</sup> of deposit per day. See *dust fall*.

**dust collector** A *dust arrester*.

**dust deposit** See *dust fall*.

**dust extraction hod, suction h., exhaust h., fume h.** A canopy leading into ducting that is connected to an exhaust fan that sucks the air away from the dusty area but may also deliver it to *dust arrestors* and must do so if the air is recirculated into the work area. The advantage of recirculating

air into the work area is that it saves a considerable amount of money in heating the building in cold weather.

**dust fall, d. deposit, fallout** The amount of *dust* and *grit* that falls on an area, expressed in g or kg m<sup>-2</sup> day<sup>-1</sup> or in tonne m<sup>-2</sup> month<sup>-1</sup>. In towns a typical figure may be 0.1 g m<sup>-2</sup> day<sup>-1</sup>. Particles larger than 5 µm form the bulk of the deposit. Dust fall can be measured in a *deposit gauge*.

**dustless loading** A system of refuse collection involving the use of *dust bins* with hinged lids. The collection vehicle has a device that hoists the dust bin, inverts it over a special close fitting opening and empties it. The use of disposable sacks of paper or plastics may be equally dust free.

**dust mite** See *house dust mite*.

**dust nuisance** *Dust* and *grit* from 50 to 100 µm in size often give rise to most complaints of *nuisance*. It is deposited mainly within 1 km from a chimney of medium height.

**dust removal** See *dust arrestors*.

**dust sampling** See *deposit gauge*.

**Dutch rasp** A *rasp mill*.

**dwarf tapeworm** *Hymenolepis nana*.

**DWF, dwf** *Dry weather flow*.

**DWI** *Drinking Water Inspectorate*.

**dyeing wastewater** When wool, cotton or synthetic fibres are dyed, the spent dye liquors may contribute 15 to 30% of the BOD load from the various textile processes.

**dye tracers** See *tracers*.

**dynamic in-vessel composting** See *in-vessel composting*.

**dynamic precipitator** A *fan collector*.

**dynamic viscosity** See *viscosity*.

**Dynasand filter** A *continuous backwashing upflow sand filter*.

**dysentery** A disease with diarrhoea aggravated by blood flowing with the stools (faeces), as in *amoebiasis* and *shigellosis*.

**dysotrophic** A natural water with the a low content of nutrients. It may have a high content of dissolved organic material, such as water from a peaty area.



---

**EA** *Environment Agency.*

**earth piercing** *Impact moling.*

**earth pressure balance (EPB) machine** A *microtunneling* machine in which mechanical pressure is used to balance pressures in the surrounding soil during the tunnelling operation and so prevent heave or subsidence.

**Earth Summit at Rio** *Rio Earth Summit.*

**easement** A legal right to move past or over land—e.g. the *riparian right* of an upstream landowner to discharge water downstream where neither bank of the watercourse belongs to him.

**EBCT** *Empty bed contact time.*

**E beam disinfection** The use of a stream of high energy electrons for disinfection.

**EBPR** Enhanced biological phosphorus removal. *See biological phosphorus removal.*

**EC** *Electrical conductivity.*

**EC** (1) The *European Commission* (2) The European Community, now replaced by the *European Union* (EU).

**EC Directive** *See European Union Directive.*

**ECJ** *European Court of Justice.*

**Echo virus** Many types of Enteric Cytopathogenic Human Orphan virus can cause *gastroenteritis*. Some may be waterborne.

***E. coli*, *Escherichia coli*** A bacterium of faecal origin which forms 90% of the *coliform group* in the human intestine. It is normally distinguishable from other coliforms by its ability to grow at 44°C in *MacConkey's broth*. A few strains are pathogenic (*see below*). For drinking water, no sample should contain any *E. coli*.

***E. coli* 0157** A serotype of *E. coli* that is a dangerous pathogen causing serious diseases including liver or kidney failure, particularly in children or old people. *E. coli* 0157 is usually food borne.

**ecological pyramid** *See food chain.*

**ecology** (adjective **ecological**) The study of the relationships between living organisms and their surroundings, including the materials, nutrients and details of the plants, animals and micro-organisms, their variations, scarcity, abundance, etc.

**Eco Management and Audit Scheme, EMAS** A voluntary scheme set up by the EU in 1993, in which an industrialist agrees to follow a specific scheme for environmental management. The scheme must include setting



an environmental policy, undertaking environmental management programmes and environmental audits. Revisions to the scheme have incorporated the ISO 14000 *environmental management system*.

**ecosystem** An *ecological* system, one in which there is a cycle of interchange of materials between living organisms and their environs. In a tropical rain forest, for example, the dead leaves and branches, built up by *photosynthesis* drop to the ground, where they rot and provide the nutrients needed by the roots. The forest flourishes even though the soil is poor.

**ecotoxicology** The study of the effect of toxins on the ecosystem rather than merely individual species.

**ED** *Electrodialysis*.

**ED50** (1) **effective dose** The environmental dose of a chemical at which 50% of the organisms or animal population are affected when exposed to that dose of the substance. (2) **effective dilution** The number of times malodorous air must be diluted so that 50% of people cannot detect the odour. *See threshold number*.

**EDB** *Ethylene dibromide*.

**EDC** Ethylene dichloride. i.e. *dichloroethane*.

**EDCs** *Endocrine disrupting chemicals*.

**eddy current separator, linear induction s.** A device that can electrically extract non-magnetic materials such as non-ferrous metals from refuse. Magnetic fields are induced in aluminium pieces by a coil of copper wire through which an alternating current passes.

**eddy flow** *Turbulent flow*.

**EDTA, ethylenediamine tetraacetic acid** A *chelating* agent which forms complex compounds with many *cations*. It is used to determine the concentration of calcium or magnesium ions, and thus the *hardness* of the water.

**eductor** Something that draws out or extracts, e.g. a device fitted to a hose near its mouth, enabling a chemical to be sucked in, in the correct proportions.

**EEC** Enteropathogenic *Escherichia coli* Strains of *E. coli* that can cause gastroenteritis, such as *E. coli 0157*.

**EEM** *Ether extractable material*.

**effective carbon dose** In a *carbon adsorption bed*, the weight of GAC in the bed divided by the volume of water treated in a run before the carbon requires removal for regeneration.

**effective chimney height, e. stack h.** The true height of the chimney plus the distance above it of the vapour plume. It depends on the *efflux velocity* and the buoyancy of the hot gases.

**effective dilution** *See ED50 (2)*.

**effective dose** *See ED50 (1)*.

**effective migration velocity, EMV drift velocity** The rate, usually between 4 and 15 cm/s at which the dust in the flue gas approaches the collecting plates of an *electrostatic precipitator* (ESP), measured perpendicular to the plates. The migration of the charged particles from the charged electrodes towards the earthed plates causes a slight current to flow. An ESP is therefore not truly electrostatic and has sometimes been called an electro-filter or electroprecipitator.

**effective particle size**, The grain size that is larger than a stated % of the particles, e.g. the  $D_{10}$  effective size has 10% (by weight) of the particles greater than that size—the same as the size that is smaller than 90% of the particles. Effective size is useful for describing media used in filters as well as in estimating *permeability* and for calculating the *uniformity coefficient*.

Permeability in cm/s is roughly equal to 100 times  $(D_{10})^2$  when  $D_{10}$  is in cm.

**effective porosity** *Specific yield*.

**effective stack height** *See effective chimney height*.

**effluent** Description of fluid or air that flows out. In wastewater treatment it usually means the treated wastewater that flows out of the works to the river, but in 'stack effluent' it means gases from a chimney. *Compare influent*.

**effluent drains** This may mean either *small bore sewers* or *soakaways*.

**effluent stream** A stream that receives *groundwater* from its banks or bed, unlike an *influent stream*, which loses water to the ground.

**effluvium** (plural *effluvia*) *Effluent*, what flows out, usually applied only to offensive smells.

**efflux velocity** The speed at which flue gas leaves a chimney. Where dry *dust arrestors* are used, the efflux velocity should, be at least 15 m/s at full load so as to maintain a negative pressure in the chimney. If a *wet scrubber* is used, the efflux velocity should not exceed 9 m/s, so as to avoid the removal of large drops of liquid from the walls of the chimney. To achieve velocities above 15 m/s, *forced draught fans* and usually also *induced draught fans* are needed.

**Ef W** Energy from waste, *see waste to energy plants*.

**egg shaped digester** An *anaerobic digestion* tank built egg shaped which aims to reduce the need for cleaning. The digester forms a steep cone at the bottom which facilitates the removal of grit. Better mixing of the digester is also claimed for this style of tank.

**egg shaped sewer** A sewer shaped like an egg with the point down. It has the advantage of slightly higher speed at low flow, which discourages the deposition of solids in the sewer. It is, however, more expensive to build than a circular sewer, and this often outweighs its advantages.

**EIA** *Environmental impact assessment*.

*Eichhornia crassipes* *Water hyacinth*.

**EIS** *Environmental impact statement*.

*Eisenia foetida* *See vermicomposting*.

**ejector pump** A pump where the water or sludge gravitates into a chamber until nearly full and then a valve is activated that shuts off the inlet and lets in compressed air so the liquid is pumped out of the chamber and into the outlet pipe. The chamber then refills with water and the cycle continues.

**ejector venturi scrubber, jet ejector.** A *Venturi scrubber* in which the motive power for the high energy scrubbing is provided by water pumps rather than air fans (*Figure E.1*). The water consumption is high, equivalent to about 5% of the flow of gas, but most of it is re-circulated. The amount of make up water needed increases with the amount of solids removed from the flue gases. The power input is as high as that to a *Venturi scrubber*.

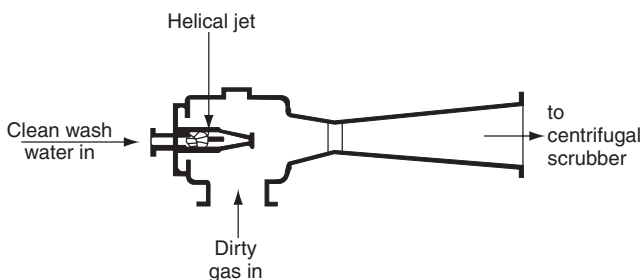

**Figure E.1** Ejector Venturi scrubber.

**electrical conductance** The reciprocal of electrical resistance ( $1/\text{ohm}$ ), the unit being the siemens (S) or mho, commonly millisiemens (mS) or microsiemens ( $\mu\text{S}$ ).

**electrical conductivity** The ability of a conductor to pass electric current. It is the *electrical conductance* of a conductor 1 cm long and  $1\text{ cm}^2$  in cross-sectional area, stated commonly in micromho/cm (microsiemens/cm,  $\mu\text{S}/\text{cm}$ ). For water the value in  $\mu\text{S}/\text{cm}$  is roughly proportional to the concentration of dissolved solids. Thus  $150\ \mu\text{S}/\text{cm}$  corresponds to about  $100\text{ mg}/\text{l}$  of *total dissolved solids*. Electrical conductivity is also used to monitor changes in the quality of groundwater, for example close to a landfill site to check if leachate is seeping from the site.

**electrical precipitator** An *electrostatic precipitator*.

**electrochemical series** The *galvanic series*.

**electrochemical treatment of wastewater** *Electrolytic treatment of wastewater*.

**electrode** A terminal of one of the two electrical conductors leading current to an *electrolyte*, electric furnace, *electrodialysis stack*, etc. One is called the *cathode*, the other the *anode*.

**electrodialysis, ED** A method for *desalination* of sea water (*Figure E.2*) that uses ion *exchange membranes*. When salt water is electrolysed, the *cations* travel to the cathode and the *anions* to the anode, leaving desalted water between cathode and anode. This does not in fact happen, but in ED it is encouraged by dividing the electrolytic cell alternately with cation selective and anion selective membranes that are permeable, only to cations and anions, respectively. When a direct current voltage is applied to the *electrodes*, the various ions move towards their electrodes. But no cation can pass an anion permeable membrane and no anion can pass a cation permeable membrane. The water in neighbouring compartments is alternately more and less salty than the raw water. ED does not remove bacteria, viruses or organic impurities, and the raw water must be carefully filtered beforehand so as to avoid clogging the pores of the *ion selective membranes* through which it must flow. The lower limit of *salinity* for the purified water is about  $500\text{ mg}/\text{l}$ , because below this value the electrical resistance and the power demand increase disproportionately. Electrodialysis has been used in wastewater treatment, e.g. for the recovery of nickel from nickel plating rinse water. See *dialysis*, *membrane fouling* and below.

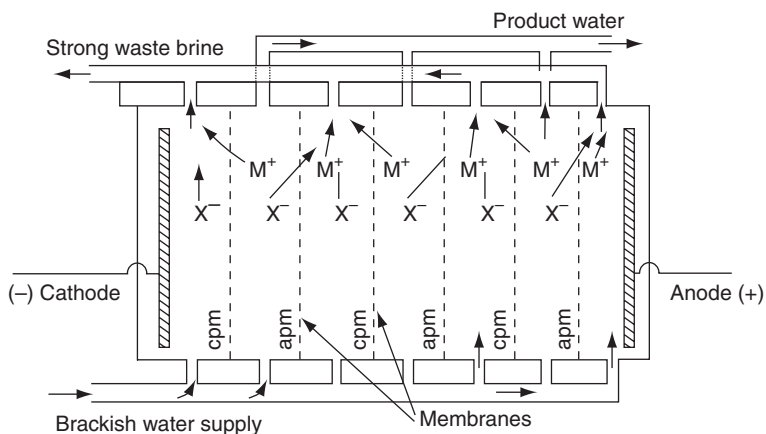

**Figure E.2** Electrodesalination, some cells of an electrodesalination stack. apm = anion permeable membrane; cpm = cation permeable membrane.

**electrodialysis stack** An *electrolytic* vat containing water to be desalted by *electrodialysis*, with several hundred parallel, alternating cation and anion selective *membranes* forming separate cells. The membranes are about 0.2 to 0.3 mm thick overall, and are only about 1 mm apart, separated by spacers of about the same thickness. *See desalination.*

**electrodynamics** Concerned with flowing currents of electricity and the magnetic fields they cause.

**electrodynamics separator** A device to separate paper from *plastics*, an electrically earthed rotating drum on to which refuse is loaded. Near the drum is an *electrode* at high voltage. Paper is attracted to the electrode and plastics to the drum. Moisture content is important. At 15% moisture the separated paper is devoid of plastics but the plastics contained some paper. At 55% moisture, separation in one pass is satisfactory. Similar equipment has been used for separating electrical conductors from non-conductors.

**electroflotation** A *flotation* method by which *electrodes*, inserted into wastewater, release gases when current passes through them. The gases form small bubbles 0.1 to 0.01 mm across and do not break up the crust of *scum*. The method has been used for treating industrial wastewaters or for thickening *activated sludge*. Typically a waste activated sludge of 0.5% solids (5000 mg/l) requires a current of 40 A per m<sup>2</sup> of tank to thicken it to 5% solids, at a maximum *surface loading rate* of 15 m<sup>3</sup>/day per m<sup>2</sup> of tank.

**electrofus** The joining together of parts (e.g. pipes) using electrical energy.

**electrokinetic extraction** *Electro-osmosis*.

**electrolysis** (adjective *electrolytic*) The conduction of electricity through an *electrolyte*, involving decomposition of the dissolved or molten substance, with *cations* migrating to the cathode and *anions* to the anode. Metal may be deposited at the cathode (*see Figure E.3*).

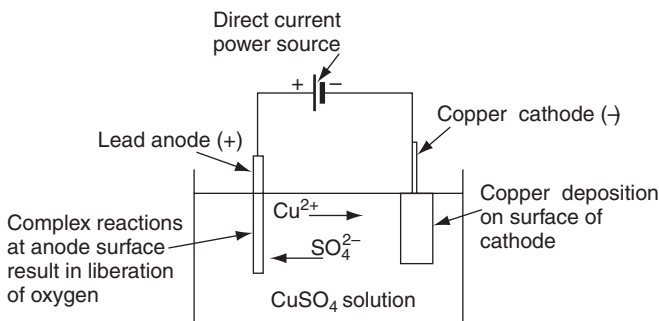

**Figure E.3** Electrolysis.

**electrolyte** A substance which dissociates into *ions* when molten or dissolved in water and will then conduct electricity by *electrolysis*. A conducting solution is also an electrolyte.

**electrolytic corrosion** *Galvanic corrosion*.

**electrolytic oxidation** Electrolysis can be used to oxidise certain pollutants, for example cyanide can be oxidised to carbon dioxide and nitrogen.

**electrolytic treatment of wastewater, electrochemical t. of w., Foyn's process**

*Electrolysis* has been used for the final purification of biologically treated wastewater effluent after mixing with sea water. The *anode* is below in the denser sea water and *chlorine* is liberated there. Above, at the *cathode*, in the lighter effluent, a *flocculent* precipitate of magnesium hydroxide and magnesium ammonium phosphate ( $MgNH_4PO_4$ ) floats off with the hydrogen bubbles that are also released. Some 90% of the phosphate can be removed in this way and the water is disinfected by the chlorine.

**electromagnet** A powerful magnet for lifting iron and steel or for extracting them from other material. Inside a coil of copper wire through which direct current passes is an iron core that is strongly magnetised by the current. If the current is switched off, the magnet drops its load. At its working temperature it is warm, can take less current than when cold and has less lifting power. Electromagnets should therefore be tested only when warm.

**electron microscope** A microscope that examines small objects by electrons in a vacuum instead of by light, as in the *optical microscope*. It has a much higher magnification because electrons have a shorter wavelength than visible light. Vision is possible on a fluorescent screen and good photomicrographs can be taken. The cell structure of bacteria can be studied, since the *limit of resolution* is about 0.5 nm, appreciably better than the optical microscope, with its limit of about 200 nm.

**electro-osmosis** See *electroremediation*.

**electrophoresis** Migration of suspended *colloidal* particles in an *electrolyte*, caused by an electrical potential across immersed *electrodes*. Capillary electrophoresis is used to analyse toxins from *cyanobacteria* (blue green algae).

**electrophoretic mobility** The rate of movement of a particle to an *electrode* under a given electrical potential. It may be used to compare the *surface charge* characteristics. Surface charge tends to change with pH. The pH at zero charge is the *isoelectric point*.

**electroplating wastewater** See *hexavalent chromium, metal plating wastewater*.

**electroremediation, electrokinetic extraction** Anodes and cathodes are inserted in an area of contaminated soil. Water is applied to the area and collected and pumped out at a well which acts as the cathode. This collected water contains cations such as metal contaminants. This process is also known as electro-osmosis.

**electrostatic** Concerned with electrical charges, not with the flow of current.

**electrostatic filter** A type of *air filter* that attracts dust particles to its charged *filter* medium.

**electrostatic precipitator, ESP** A dry *dust arrestor* that can remove particles down to  $0.01\ \mu\text{m}$  at any temperature below  $450^\circ\text{C}$ . The *cut diameter* is normally about  $0.5\ \mu\text{m}$ . ESPs are often used with municipal incinerators. The gases pass between rows of *electrodes*. Connected to a d.c. voltage supply of some  $-30\ 000$  to  $-50\ 000\ \text{V}$ , the charged electrodes (corona electrodes) usually consist of a strong wire carrying a weight at the foot, hung midway between the other (earthed) electrodes, which are steel plates about 30 cm apart (see *Figure E.4*). The dust collects on the earthed plates, which are periodically rapped to remove the dust. If the voltage exceeds  $-50\ 000\ \text{V}$ , *flashover* between electrodes may prevent dust being collected. The gas should contain water vapour in order to reduce the resistivity. ESPs work best at about  $200^\circ\text{C}$  and are popular because they do not cause a high pressure drop (3 to 20 mm water gauge), nor do they have

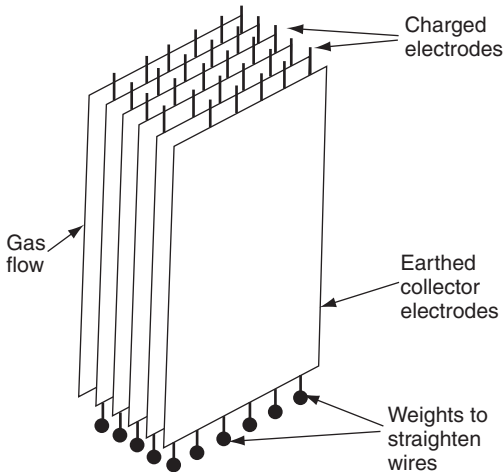

**Figure E.4** Electrostatic precipitator, plate type.

a high power demand, about 0.7 to 1.4 kW per 100 m<sup>3</sup>/min of gas treated. But they are expensive to install and they require a rectifier and a voltage regulator. Typical dimensions of ESP are: flue gas speed in precipitator 0.5 to 2.0 m/s (in flue 10 to 20 m/s); plate height 3.5 to 10 m; plate length from 30 cm to 1.5 times the height; retention time 2 to 10 s. To avoid corrosion and bridging of particles over the exit into the dust hopper (caused by **condensation**), hoppers are always insulated and sometimes heated in cold weather to keep their temperature above the **dewpoint** of the flue gases. Small quantities of **ozone** are produced in ESPs when the corona electrodes are negatively charged. This can be overcome by operating at a positive d.c. voltage. But the maximum positive voltage without arcing is substantially less than with negative voltage; hence, the efficiency of the ESP is then smaller. *See effective migration velocity, sneakage, tube precipitator.*

**electrostatic separator** Several devices exist that can electrostatically separate electrical conductors from non-conductors—e.g. aluminium from glass or paper (*Figure E.5*). There are many ways of applying the electrical charge—e.g. by **conductive induction**. Repeated contact between grains of material shaken together also can create a charge unintentionally. If the materials are not dry, the charge is lost and separation is impossible.

**elemental sulphur** The uncombined element **sulphur**.

**elephantiasis** Great swellings of the legs as a result of many worms in the blood from **filariasis**.

**elute** To rinse. In the sense of the regeneration of an **ion exchange** resin, the regenerating **brine** is the eluant; after it leaves the ion exchange tank, it becomes the eluate.

**elutriation** (1) Separation of mixed particles of different sizes or densities by a rising current of air or water—in an **air column separator** with air or in a **rising current separator** with water. Many uses of the principle exist. (2) Washing of sludge, usually with final effluent to enable it to be dewatered more easily. The sludge is mixed with 5 to 10 times its own volume of effluent and settled. Soluble substances are removed

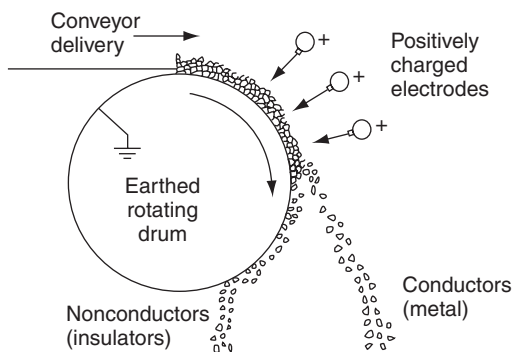

**Figure E.5** Electrostatic separator.

(phosphates and bicarbonates) and non-settleable fine solids. The chemical sludge conditioners work more effectively and the dry solids content of the sludge improves to 6%. The amount of **chemical conditioning** should be smaller and the **filterability** of the sludge better. The main problem is the quantity of solids that are re-circulated to the treatment system in the elutriation water. Losses from **digested sludge** can be 2.5 to 10% of the solids. *See dewatering of sludge.*

**ELV** *Emission limits values.*

**EMAS** *Eco Management and Audit Scheme.*

**emergency bypass** A pipe or channel that avoids a treatment tank that is not in use.

**emission** What is sent out—emitted: not only pollutants, but also the scent from a rose, or radio waves in broadcasting.

**emission factor, e. rate** The amount of pollutant given off.

**emission limit values** The limit or maximum value allowed for the emission of a given pollutant.

**emission spectrophotometry** Analytical techniques used for measuring low concentrations of some elements by thermally exciting atoms so that they emit distinctive radiation as in **flame photometry** or the much more powerful technique of **ICP-OES**.

**emission standard** A permissible level of pollutant sent out in water or air.

**emitter** A source.

**empty bed contact time, EBCT** The volume of a **carbon adsorption bed**, **rapid deep bed filter**, etc. divided by the flow rate through the bed or filter.

**EMS** *Environmental management system.*

**emulsification** The process of becoming an **emulsion**.

**emulsifier** An additive that helps to stabilise an **emulsion** by reducing the **surface tension** in the continuous phase and preventing coalescence between the particles in the disperse phase.

**emulsion** A permanent mixture of two or more liquids that do not dissolve in each other, one of them usually being in tiny bubbles. In an oil in water emulsion the oil is the disperse phase (in bubbles) and the water is the continuous phase. When the oil has to be recovered from the emulsion, the emulsion has to be ‘cracked’ or ‘broken’.

**emulsion breaking, e. cracking** Separation of the two parts of an **emulsion** by adding chemicals that encourage the droplets of the disperse phase to join up to form larger drops.

**EMV** *Effective migration velocity.*

**encapsulation** Stabilisation of hazardous waste or contaminated land by the addition of cement or pozzolanic material in order to form solid blocks that immobilise the toxic components of the hazardous waste. Encapsulation is sometimes known as solidification or chemical fixation. The cement slurry may be injected into a suitable geological formation where the cement sets. Some radioactive wastes have been encapsulated into glass. For contaminated land, encapsulation can mean **capping**. *See cement based stabilisation.*



**enclosed aerated filter** A *trickling filter* that may be unusually deep but is completely enclosed, and equipped with a fan blowing air continuously through it. *Organic loadings*, measured per m<sup>3</sup> of medium, have been claimed to be double those of conventional trickling filters.

**encroachment** See *saline intrusion*.

**Endamoeba histolytica** See *Entamoeba histolytica*.

**endemic disease** Disease that constantly recurs in a particular locality.

**endobiotic** Description of something living within another cell or plant.

**endocrine** Hormonal.

**endocrine disrupter, endocrine disrupting chemicals, EDCs** A chemical that can disrupt the hormone system in animals. See *oestrogenicity*.

**endogenous phase of growth, death p. of g.** A growth phase of a population of micro-organisms in which there is no new input of food from outside. Individual microbes use the nutrients from dead cells and the number of living cells decreases. See *autolysis, growth phases of microbes*.

**endogenous respiration** *Respiration of cells* in the *endogenous phase of growth*.

**endospores** A distinctive type of dormant cell that is formed among some types of bacteria. Endospores can have no detectable life for many decades but still be able to germinate in a suitable environment. They may resist heat, ultraviolet light, desiccation and many toxic chemicals. Some species of *Bacillus* and *Clostridium* form endospores. See *cyst*.

**endosulfan** A *cyclodiene* insecticide and acaricide that is highly toxic to humans and fish. The USEPA recommends the concentration in lakes, rivers, and streams are not more than 74 µg/l. The EU lists it as a *priority substance* (under review for possible re-grading as a priority hazardous substance) in relation to aquatic discharges.

**endotoxins** Toxic chemicals that are released into the environment by organisms that are living in that environment. *Cyanobacteria* (blue green algae) growing in nutrient rich water may release endotoxins into the water thereby poisoning animals or humans that drink the water. Some marine and estuarine *dinoflagellates* release endotoxins.

**endrin** A *cyclodiene* insecticide that is toxic to humans affecting the human nervous system and kidneys. It can undergo *biomagnification* in food chains. The *USEPA MCL* in drinking water is 0.2 µg/l and the WHO guideline maximum value is 0.03 µg/l. Endrin is an isomer of *dieldrin*.

**energy accounting** Estimation of the cost of things in terms of the energy needed to make them rather than in money.

**energy analysis** The questioning process on which *energy accounting* is based.

**energy line, e. grade line, e. gradient** A line representing the total *head* (total energy) of *water* or other fluid flowing in an open channel or pipe. It is the sum of the potential energy (head or altitude), pressure energy and velocity head (kinetic energy). It is therefore the *hydraulic gradient* plus  $V^2/2g$ , where  $V$  is the velocity and  $g$  is the acceleration due to gravity. See *Figure O.1* and *P.5*.

**energy recovery** This can mean many things e.g. *waste to energy plants* or the production of *refuse derived fuel* or the gases and oils obtained from *pyrolysis*. See *heat recovery*.

**enhanced biological phosphorus removal, EBPR** See *biological phosphorus removal*.

**enrichment culture** The use of a *selective medium* to produce a microbial *culture* that is enriched with one group or species of micro-organism. For example, 5000 mg/l of sodium sulphate in an *anaerobic* culture will enrich it in *sulphate reducing* bacteria.

**enrichment of lakes** See *eutrophication*.

***Entamoeba histolytica*** A parasitic *amoeba* that causes amoebiasis. Its *cysts* can be killed by heavy *chlorination*, such as 60 min exposure to 8 mg/l of chlorine at 10 °C. The cysts pass the disease to people, and may be carried by flies or on the fingers or food or occasionally by water. The cysts may persist in the environment for more than 6 months.

**enteric bacilli** Bacteria that can live in the intestine.

**enteric disease** Any disease caused by microbes living in the intestine. The microbes pass out in the faeces of the infected person.

**enteric fevers** *Paratyphoid, typhoid fever*, as opposed to the more general *enteric diseases*.

***Enterobacter*** A bacterium that live in the intestines.

**enterobiasis** Infection by *pinworm* that can cause anal itching.

***Enterobius vermicularis*** *Pinworm*.

***Enterococci*** Cocci bacteria that live in the intestines. For drinking water, no sample should contain any *Enterococci*.

***Enterococcus faecalis*** This bacterium was previously named *Streptococcus faecalis*. It is common in animal and human faeces but less common and important than *E. coli*. It ferments *MacConkey's broth* without evolution of gas.

***Enteromorpha*** A green algae which is a common sign of *eutrophic* water in the marine environment.

**enteropathogenic** Pathogenic micro-organisms that live and produce disease in the intestines.

**enteroviruses** A group of viruses that includes poliovirus, coxsackie virus and echovirus that exist in the intestine.

**entombment landfill, dry landfill, fully contained landfill** A *landfill* site in which the sides, base and top are impermeable. The water input from precipitation on the site may be negligible. This type of site is effectively storage of the waste and the biodegradation may take 1000s of years. See *flushing bioreactor landfill*.

**entrainment** Removal of gas bubbles or of solid or liquid particles by a fast moving fluid in contact with them. Sea spray and sandstorms are examples of entrainment by wind.

**entrainment separator** A unit that follows a *wet scrubber* or other wet treatment of gas, removing droplets of wash water in a 10 to 15 cm thick bed of knitted fine stainless steel or plastics thread See *mist eliminator*.

**enumeration of bacteria** See *bacteriological examination*.

**environment** Surroundings.

**Environment Act 1995** A development from the UK *Environmental Protection Act 1990*. The 1995 Act included provisions on contaminated land,

national air quality strategy, etc. It established the Environment Agency and the Scottish Environment Protection Agency.

**Environment Agency, EA** The Environment Agency for England and Wales was established by the Environment Act, 1995. On 1 April 1996 the Agency assumed all the responsibilities of the *National Rivers Authority* which was abolished. The Agency also has responsibility for *Integrated Pollution Control, Integrated Pollution Prevention and Control* and *solid waste* regulation. See *European Environment Agency, Operator and Pollution Risk Appraisal*.

**environmental assessment** *Environmental impact assessment*.

**environmental audit** (1) An audit of an *environmental impact assessment*. (2) An *environmental management system audit*.

**environmental engineering.** In general any engineering techniques concerned with the human environment. In the UK it used to have the restricted meaning of heating and ventilation of buildings. However, the term normally means the design, construction, operation and management of equipment for water treatment and supply, sewerage networks, waste water treatment, effluent quality control, solid waste management, atmospheric pollution control and indoor air quality. It covers many branches of engineering together with environmental science, environmental assessment and public health.

**environmental estrogens** See *oestrogenicity*.

**environmental health** The interests and duties of *environmental health officers* include housing, food, health and safety at work, leisure, health education, pest control. They are interested in the health implications of *environmental engineering*, including water supply, sewerage, wastewater disposal, solid waste and its treatment and disposal, *nuisances*, infectious diseases, pollution control and noise.

**environmental impact assessment, EIA** This is the study and analysis of environmental impacts resulting of significant public and private developments. EIA started in the USA and the initial legislation was the 1969 National Environmental Policy Act (NEPA). The European Union enacted Directives on EIA in 1985, 1997, and 2001. These Directives require Member States to ensure that before consent is given to projects likely to have significant environmental effects, they are subject to an assessment of those effects. It is a requirement that environmental information in the form of an environmental impact statement (EIS) be prepared and provided by the proponent of a scheme (developer) and such a statement forms part of the process of EIA (see *Strategic Environmental Assessment Directive 2001*). The World Health Organisation (WHO) sanctioned environmental health impact assessment by Resolution WHO/35.17, approved by the World Health Assembly in May 1982. This resolution recommended that environmental health and health impact assessment studies should be carried out and developed prior to the implementation of all major economic development projects, with special reference at a global level, to water resources development projects.

**environmental impact statement, EIS; environmental statement, ES** An ES is a document that details the environmental impacts of the proposed development or action or activities. A good standard of ES should assist

the planning authority and other public bodies with environmental responsibilities to make better decisions.

**environmental lapse rate** The measured change (usually drop) in air temperature with height. *See adiabatic lapse rate, inversion.*

**environmental management system, EMS** This is a management tool for industries, local government, etc. which can be integrated with other management requirements, to assist organisations to achieve environmental and financial goals. The EMS system should enable the organisation to establish an environmental policy relevant to the organisation and identify the environmental impacts arising from the organisation's activities. The EMS identifies priorities and sets appropriate environmental objectives and targets. Thereby a policy is implemented for planning, control and monitoring of the environmental management. The EMS should describe how the organisation's targets are to be achieved, including time-scales and responsibilities of personnel to implement the organisation's environmental policy. The programme should include an environmental review for new activities. Corrective action, auditing and review activities must be undertaken to ensure that the targets are achieved. The *ISO 14000 series* are a group of publications giving international standards on various aspects of environment management.

**environmental management system audit** The organisation should establish and maintain a programme and procedures for periodic environmental management system audits to be carried out in order to determine whether or not the *environmental management system* has been properly implemented and maintained. The EMS should be reviewed in the light of the audit results. In the *ISO 14000 series*, ISO 14011 relates to procedures for auditing environmental management systems. ISO 14012 relates to the qualification of environmental auditors. *See environmental performance indicators.*

**environmental oestrogens** *See oestrogenicity.*

**environmental performance indicators, EPIs** In the control of pollution from an industry, EPIs are measurements of the proficiency of the *environmental management system* of a company. ISO 14031 details the methodology for environmental performance evaluation.

**environmental policy** Senior management in industries, local government, etc. should define the organisation's environmental policy. The policy should include a commitment to continual environmental improvement and provide the framework for setting and reviewing environmental objectives and targets. The policy should be documented, implemented, and communicated to all employees.

**Environmental Protection Act 1990, EPA 1990** A major piece of UK legislation that draws together many pieces of the previous legislation on environmental protection in the UK.

**Environmental Protection Agency** *See USEPA.*

**environmental quality objectives, EQO** The environmental quality standard that it is intended to achieve in the near or medium term (e.g. 5 or 10 years).

**environmental quality standards, EQS** The standard required for the concentration or amount of a given pollutant released into a given environmental situation.

**environmental statement** See *environmental impact statement*.

**enzymatic hydrolysis** All biodegradation, whether *aerobic or anaerobic* involves some *hydrolysis* of complex organic compounds into simpler molecules by the action of *enzymes* of microbes. In the context of the treatment of solid wastes the term can mean conversion of waste paper to glucose and ethanol by enzymes, using reaction times of around 20 h. See *biodegradable*.

**enzyme** Bacteria and other living *cells* produce enzymes—*catalysts* with a *protein* based structure. Enzymes accelerate biochemical reactions without alteration in themselves, although they may pass through an intermediate stage in combination with a substance, converting it to an end product that finally releases the enzyme. Enzyme names usually end in *-ase*—e.g. *diastase*, *oxidase*, *reductase*, *urease*. They exist in enormous variety throughout life and each one has its specific biochemical function, either outside a cell (extracellular enzymes) or inside one (intracellular enzymes). Their action is strongly influenced by temperature, pH or toxic substances.

**enzymology** The study of *enzymes*.

**EP** European Parliament.

**EP toxicity** *Extraction procedure toxicity*.

**EPA** See *USEPA*.

**EPA 1990** *Environmental Protection Act 1990*.

**EPCT** Ethyl dipropylthiocarbamate, a herbicide.

**Ephemeroptera** *Mayflies*.

**EPIs** *Environmental performance indicators*.

**epibenthic organisms** Life on the sea bed, including fixed oysters, slow moving hermit crabs, gasteropods and some fish that enjoy shallow water.

**epibiotic** Living on the surface of another organism.

**epichlorohydrin** An organic chemical that is carcinogenic to humans and can arise from epoxy resins. The WHO guideline maximum value for drinking water is 0.4 µg/l. The EU Drinking Water Directive gives a mandatory maximum of 0.1 µg/l. The *USEPA* does not state a concentration for the *MCL* for drinking water, but states a specified treatment technique to ensure it is not present in the drinking water. This includes certification of the level of the chemical that can arise in the water from use of epoxy resins.

**epidemic** A disease that spreads quickly.

**epidemiology** The medical study of *epidemics*.

**epilimnetic** Concerned with the *epilimnion*.

**epilimnion** The warmer upper layer of water in a lake, sea or reservoir which occurs in temperate climates in summer months. It is usually well mixed by wind action and the resulting turbulence. It consequently is uniform in temperature and well aerated. If the nutrients are available, *blooms* may occur. In a deep alpine lake of about 140 m total depth the epilimnion in September is often 10 m deep. See *thermal stratification*.

**Epistylis** A stalked *ciliate protozoon* common in polluted streams or *activated sludge* or *trickling filters*.

**epoxy lining** A method of rehabilitating a water pipe. The pipe is cleaned by boring or scraping and then 1 mm of epoxy coating is sprayed on to the

inside of the pipe. The application is monitored and allowed to cure for 16 hours. Pipe diameters up to 1 m can be rehabilitated using this technique. The technique does not solve leakage problems. Epoxy linings are also used to line the insides of precleaned concrete sewers that may be prone to corrosion due to the nature of the wastewater.

**EP toxicity test** *Extraction procedure (EP) toxicity test.*

**EQO** *Environmental Quality Objectives.*

**EQS** *Environmental Quality Standards.*

**equalisation (or equalization) basin, e. tank** *A balancing tank.*

**equivalent per million, e.p.m.** The concentration of a substance in mg/l, divided by its *equivalent weight*. This is the same as its *milli-equivalent per litre* if the solution has a *specific gravity* of 1.

**equivalent pipe length** In a building, the measured length of water pipes plus an extra allowance for head losses in the pipe system. This extra allowance is sometimes taken as 30% of the measured pipe length.

**equivalent weight, equivalent** Of an element or compound, the weight that will combine or react with or replace one atomic weight of hydrogen. For an acid the equivalent weight is the molecular weight divided by the number of hydrogen atoms in the acid that react with an alkali.

***Eristalis tenax*** A species of *Diptera* whose *larva* (the rat tailed maggot) can exist in deoxygenated water and muds, breathing through tubes that communicate with the air above. It indicates gross organic pollution.

**erosion, scour** Removal of topsoil by heavy rain, or removal of material from stream and river beds or banks by fast currents. Earth moving work can severely pollute water by encouraging scour of topsoil into it.

**ES** Environmental statement. *See environmental impact statement.*

***Escherichia coli*** *E. coli.*

**ESP** *Electrostatic precipitator.*

**estrogenicity** The USA spelling of *oestrogenicity*.

**ETBPP** Environmental Technology Best Practice Programme. A UK Government programme that tries to ensure that industry can obtain information on the best environmental practice.

**ethane peroxoic acid** *Peroxyacetic acid.*

**ethenes, ethylenes** Organic compounds based on the ethene molecule,  $\text{CH}_2 = \text{CH}_2$ . Ethene is also known as ethylene. *See chloroethenes.*

**ether extractable material, EEM** Oil, grease and tar, which are determined in wastewater or sludge by extraction with petroleum ether.

**ethylbenzene** An aromatic compound with one ethyl group ( $-\text{CH}_2\text{CH}_3$ ) attached to a benzene ring. It is present in petrol (gasoline). At high exposures it is toxic to humans giving adverse effects on the nervous system, liver and kidneys. The *USEPA MCL* in drinking water is 0.7 mg/l.

**ethylenediamine tetra-acetic acid** *EDTA.*

**ethylene dibromide, EDB, dibromoethane** An organic chemical that has two bromine atoms substituted into the ethene (ethylene) molecule to form  $\text{BrCH} = \text{CHBr}$ . It was used for a range of purposes in industry. It is toxic to humans and carcinogenic. The *USEPA MCL* in drinking water is low at 0.05  $\mu\text{g/l}$ .

**ethylene dichloride** *Dichloroethane*.

**etiological agents** Organisms which cause disease.

**eucaryotes** Organisms that have one or more cells with true nuclei. They may be unicellular like some algae and fungi.

**EU Directive** See *European Union Directive*.

**Euglenophyta, phytoflagellate protozoa** A group of unicellular algae with *flagella*, mostly inhabiting fresh water—e.g. *Euglena*, which can be abundant in stagnant, nutrient rich waters such as *waste stabilisation ponds*.

**euphotic zone** The water in a pond, lake or sea, down to the effective depth of penetration of light for *photosynthesis*.

**Eurocode** Design codes of practice, for example in structural design, that are being adopted in Europe which will eventually replace national design standards.

**European Commission, EC** This body has the responsibility for proposing legislation in the EU.

**European Community, EC** The *European Union* replaced the European Community in 1993.

**European Court of Justice, ECJ** The body that determines points of law for EU legislation e.g. the legal correctness of EU Directives.

**European Environment Agency** An organisation established in 1990 that aims to support sustainable development and to help achieve significant and measurable improvement in Europe's environment through the provision of information to policy making agents and the public. It provides the European Information and Observation Network. Its headquarters are in Copenhagen, Denmark.

**European Union, EU** The European Community was founded in 1957 by Belgium, France, Germany, Italy, Luxembourg, the Netherlands, Denmark, Ireland and the UK joined in 1973, Greece in 1981, Portugal and Spain in 1986 and Austria, Finland and Sweden in 1995. The European Union replaced the title of European Community in 1993. See below.

**European Union Directive, EU Directive** European Union legislation that has to be enacted by the member states within the stated time period (e.g. 5 years). The Directive states the results to be achieved (e.g. quality of effluent from a wastewater treatment plant) but leaves the method of implementation to the Member States. Examples of EU Directives include *Ambient Air Quality Assessment and Management Directive 1996, Air Quality Framework and Daughter Directive 1999, Bathing Water Directive 1976, Drinking Water Directives, Freshwater Fish Directive 1978, Ground Water Directive 1980, Hazardous Waste Directive 1991, Incineration of Municipal Waste Directives 1989, Incineration of Hazardous Waste Directive 1994, Incineration of Waste Directive, 2000, Landfill Directive, 1999, Integrated Pollution Prevention and Control Directive 1996, Nitrate Directive 1991, Packaging and Packaging Waste Directive 1994, Shellfish Directive 1979, Shipment of Radioactive Waste Directive 1992, Strategic Environmental Assessment Directive 2001, Surface Water Directive 1975, Urban Wastewater Treatment Directive 1991, Water Framework Directive 2000*.

**European Union Regulation** European Union legislation that becomes law in all the Member States.

**European Water Association, EWA** A non governmental association that covers technical, scientific and policy aspects of water and wastewater. It has 29 European national associations that includes EU countries and a number of non EU European countries. Its headquarters are in Hennef, Germany.

**eurythermic** Organisms that can tolerate a wide range of temperatures.

**eurytopic** Organisms that can tolerate a wide range of habitats.

**eutrophic** (from Greek, corpulent) Description of a water that is rich in nutrients. Eutrophic waters have plenty of life, resulting in turbidity and possible *blooms* in summer. The colder, lower layer of a eutrophic lake becomes depleted of oxygen in late summer because of the descent of decaying organic matter from the warmer upper layer. See *oligotrophic*.

**eutrophication** The process of becoming *eutrophic*, which may take many thousands of years in natural conditions. An originally *oligotrophic* lake becomes enriched with nutrients brought from weathered rocks dissolved in the runoff from the surrounding *catchment*, which stimulate the life in the lake. This process can be greatly accelerated by humans with their inputs of wastewater, fertiliser washed off farmland, etc., resulting in complete eutrophication in 50 to 100 years. The key nutrient that can limit eutrophication is usually *phosphorus*. Nitrogen can be fixed from the air by some algae and carbon enters the system by *photosynthesis*. Hence, man induced eutrophication can best be limited by phosphorus removal in the wastewater treatment works or reduction of phosphate in runoff from agricultural land.

**evaporation** In the *hydrological cycle*, loss of water to the air as vapour.

**evaporative tower, quenching t., spray t.**, Equipment that cools the gases from an *incinerator* before they enter a gas cleaning plant without heat recovery. (In an incinerator with heat recovery the *flue gases* are cooled by a boiler that recovers their heat.) Water is sprayed into a chamber through which the gases pass. There are two main types—wet bottom and dry bottom systems. The wet bottom system costs less but with coarse sprays uses more water and results in a highly acid wastewater that needs treatment. In dry bottom systems the sprays are finer and consequently the pressure loss is higher, but all the water is evaporated. The spray volume must be adjusted accurately to ensure this, and the water must be filtered or the jets will block. With either system the water uptake increases the mass of flue gases but reduces their volume by about 40%. For a typical refuse burned with 100% excess air, the amount of water is 2 to 2.5 kg per kg of refuse. Failure of the spray system can result in burnout of the *electrostatic precipitator*.

**evapotranspiration** The combined loss of water vapour to the air that results from *evaporation* and *transpiration* in the *hydrological cycle*.

**EWA** *European Water Association*.

**excess air** Air that is theoretically not needed for burning, yet passes through a furnace. In efficient furnaces (e.g. boilers) it should be kept as low as



possible to maintain the efficiency and to reduce the number and mass of dust and grit particles carried off. If too much excess air is used, the flue gases are cooled. For efficient burning of coal there should be not more than 50% excess air. *Incinerators* may have chemically reducing conditions near the *grates*, which may lead to high temperature *incinerator corrosion*. Therefore, to provide the oxygen to eliminate the reducing conditions, 80% more excess air may be the target of operation for an incinerator.

**excess lime softening** Unlike *calcium carbonate*, magnesium carbonate is soluble and magnesium is therefore removed in *water softening* by precipitating magnesium hydroxide. This is formed only at pH above 11.0, so lime in excess of that needed for normal *lime softening* must be added to obtain the required *alkalinity*.

**excess sludge** *Surplus sludge*.

**exfiltration** Leakage outwards, the opposite of *infiltration*.

**exhaust ventilation, e. system** Ventilation by a fan which sucks the foul air towards itself, as with a *dust extraction hood*.

**exotoxin** A toxin that is released from an organism in the body and is transported by the blood to adversely affect one of the organs in the body.

**expanded bed** A process in which water or wastewater is pumped up through a bed of solid media, such as sand, at a rate sufficient to slightly lift and expand the bed. The expansion of the bed is an important part of *back-washing* a *rapid deep bed filter*.

**expanded bed anaerobic process** An *anaerobic filter process* in which the wastewater flows upward through a bed of sand or anthracite. Some of the effluent is recycled to the bottom of the bed in order to maintain an upflow that is appropriate for the expansion of the bed. Because of the expanded bed, a higher biomass concentration can be maintained in the process compared to the normal *anaerobic filter*. The retention time of the wastewater in the process can therefore be reduced.

**expanded porosity** The porosity in a filter bed when it is expanded by *back-washing* or back flushing.

**expansion chamber** A chamber of much larger cross section than the pipe or flue to which it is connected. The flow of the gas is slowed which allows particles to settle as in a *gravity settling chamber* (*Figure G.1*).

**exponential growth** The *logarithmic growth*.

**ex situ** Moved from its original location.

**extended aeration** An *activated sludge* process that uses a long aeration period of 24 h or more, as with the *oxidation ditch*. The main advantage is a low *sludge production* (less than 0.5 kg dry sludge per kg BOD<sub>5</sub> applied); therefore it can operate in small rural communities where sludge is removed every few months. Extended aeration plants do not need *primary sedimentation*. They may be designed to a *volumetric loading* of 0.25 kg/d of BOD<sub>5</sub> per m<sup>3</sup> of aeration tank capacity or a *F:M ratio* of 0.05 to 0.015 day<sup>-1</sup>. The effluent is well nitrified.

**extended detention basin** A *detention basin* that has a retention time of 12 to 40 hours and is used to capture and slowly release stormwater in order to

spread the quantity of stormwater runoff over a longer period. Some sedimentation of particulates occurs in the pond.

**extended filtration** The use of a *high rate trickling filter* in such a way that some of the effluent containing some biomass returns to mix with the incoming wastewater. This increases the rate of organic adsorption by the microbes as well as good stabilisation of the sludge. The sludge production is about the same as *extended aeration*.

**extraction procedure (EP) toxicity test** In the USA, the procedure whereby a waste sample is crushed and mixed with acetic acid for 24 hours in order to extract toxic substances. The sample is filtered and analysed. If the concentration of specific chemicals in the extract exceeds stated limits listed in the appropriate legislation, the waste sample is deemed to be hazardous. The test has been replaced by the *Toxicity Characteristic Leaching Procedure*.

**fabric filter, bag f.** An efficient *dust arrestor* used in many industries and in many sizes, having long, vertical, cylindrical textile or felt tubes (bags) through which the dust laden gas is blown, usually outwards (see *Figure F.1*). Bag filters remove at least 99% of the dust if no bags are broken and function in the same way as a household vacuum cleaner. They can, however, cause up to 170 mm water gauge loss of gas pressure and are easily blocked, especially if the gas is cooled below its *dewpoint*. Bags have the following maximum working temperatures: paper 50 °C; wool or felt 90 °C; nylon 200 °C; glass fibre 265 °C if siliconised and graphited. Woven stainless steel bags are said to tolerate temperatures above 400 °C. Bags have been impregnated with sodium bicarbonate so as to react with sulphur dioxide and extract it from the flue gases but this is unusual.

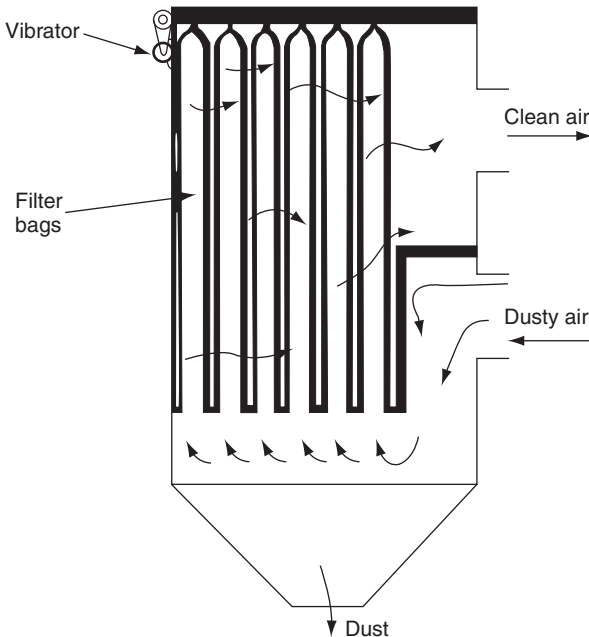

**Figure F.1** Fabric filter.

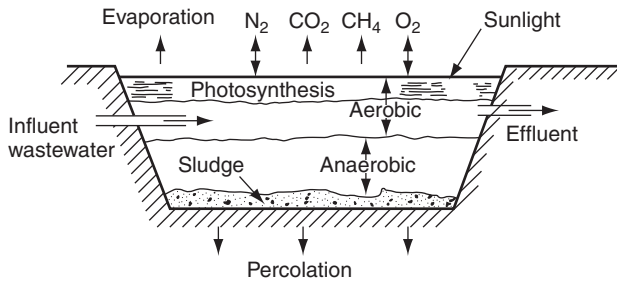

**Figure F.2** Facultative waste stabilisation pond.

Maintenance is slow, dirty and expensive. Both working costs and energy demand are generally lower than for good scrubbers but more than for precipitators. See *bag cleaning, baghouse*.

**facultative anaerobic bacterium, f. anaerobes** A bacterium that can grow in the presence or absence of dissolved oxygen. Consequently, it is either *anaerobic* or *aerobic* according to the conditions around it, unlike *obligate anaerobes* or *obligate aerobes*. Facultative bacteria usually function better as aerobes.

**facultative waste stabilisation pond, f. lagoon, f. pond, aerobic anaerobic l., hetero-aerobic l.** A *waste stabilisation pond* which is *anaerobic* in the bottom layers and *aerobic* in the top water (see *Figure F.2*). It has been successful in warm countries where the land is available. In the delicate relationship between the two layers *photosynthesis* occurs by day in the top layer, with the algae evolving oxygen and consuming the carbon dioxide given off by the bacteria that exist deeper in the pond. The algae are limited to the top 30 to 50 cm. *Chlorella* is often the dominant alga but *Chlamydomonas* and *Euglena* also occur. Aerobic bacteria with the help of this oxygen oxidise the waste in the upper layers. Below 10°C the anaerobic activity in the lower layers is negligible, but above 23°C it is so intense that *methane* may lift the sludge off the bottom. The middle layers of the pond are partly aerobic and partly anaerobic. The water is 1.5 to 2 m deep. If it is shallower, plants grow from the bottom, making the lagoon into a swamp; if deeper, the pond is predominantly anaerobic. There are daily variations in dissolved oxygen and pH. The dissolved oxygen in the upper layer may reach 15 to 30 mg/l by the afternoon and fall nearly to zero before dawn. The pH rises with photosynthesis, as the algae use up the carbon dioxide. Typical BOD loadings are 50 to 200 kg of BOD<sub>5</sub> per hectare of pond per day. A lagoon may work more efficiently if the dissolved oxygen from the upper layer is sometimes mixed with lower layers by wind or a re-circulating pump, encouraging the bacteria below. Facultative ponds are desludged every 10 to 20 years. To obtain a good effluent, a facultative pond should be followed by two or more *maturation ponds*.

**faecal coliform bacteria** Bacteria that inhabit the intestines of humans and animals, including *Escherichia coli*. The ratio of faecal coliforms to *faecal*

- streptococci* is typically less than 1 for domestic animals but more than 4 for human beings. *See coliform count.*
- faecal-oral** Pathogens passed in the faeces from the infected person or animal is passed to another by ingestion of the organisms by direct contact or by consuming food or water contaminated by the pathogen.
- faecal streptococcus** Streptococcus bacteria that are found in faeces. They are less likely to be used as indicator organisms compared to *E. coli*. *See faecal coliforms.*
- faeces, feces** (adjective **faecal, fecal**) Waste material excreted by humans, animals, birds, etc.
- fall** The drop in head along a pipe or sewer.
- fallout, dust fall, particle fall** *Dust* that falls from the sky, often in rain or snow. Whether coarse or fine, it may originate from chimneys, volcanoes, sandstorms, forest fires or nuclear explosions.
- fall turnover** *See thermal stratification.*
- family** A division in *taxonomy* between order and genus.
- fan collector, impeller c., turbocollector, dynamic separator** A *dust arrestor* consisting of a *centrifugal* fan that throws the dusty part of the flue gas to a slot in the outside of the fan casing. The slot leads either to a dust hopper or to *cyclones* that further clean the gas. The flow passing through the cyclones may be 10 to 15% of the total, but the arrangement allows them to be smaller, more efficient and less expensive than if they were to treat the whole flow. Fan collectors have temperature limitations because of their gas seals and bearings, which must not be overheated.
- fanning** Fanning describes a specific shape of a plume from a chimney (*see Figure P.7*) It occurs during an inversion with very stable air. The plume of the gases quickly reaches the highest level and then travels horizontally with little dilution. It is one of the worst situations for air pollution dispersion.
- farm wastes** *See agricultural wastewater.*
- fasciolopsiasis** A disease caused by the *trematode* parasite *Fasciolopsis buski*. It is mainly confined to the Far East, particularly China. Symptoms include alternating diarrhoea and constipation, vomiting and anorexia. Pigs and dogs may act as reservoirs of the parasite. They are passed in the faeces and develop in water into miracidia which enter various water snails. *Cercariae* develop in the snail and are liberated and encyst on water vegetation. Adequate treatment of water growing vegetation before eating is an important method of control.
- fats** *See grease and fats.*
- fatty acids** Organic acids that have one carboxylic group ( $\text{—COOH}$ ) attached to a straight or branched carbon chain. Organic fatty acids that are volatile at ambient temperatures are known as *volatile fatty acids*.
- fauna** The animals of a region or period.
- FBA** *Furnace bottom ash.*
- FBR** *Fluidised bed reactor.*
- fecal, feces** The USA spelling of faecal, faeces.
- Federal Register, FR** In the USA, the Federal Register publishes new Regulations and proposals for new Regulations.

**feed lot** A large field near a city, where many thousands of animals are fattened for some months before slaughter. The feed lot drainage should be led to a *lagoon* with a volume at least equal to the rainfall *runoff* of the worst 24 h storm that occurs in 20 years.

**feed water** Water that is pumped into a steam boiler under pressure. Most of the feed water is condensed steam; the rest is make up water. For electrical generating station boilers in which the steam pressures are around 140 atm, the total ionised solids should be below 0.05 mg/l and silica should be below 0.02 mg/l, as otherwise turbine blades could be damaged or *scale* in the boiler could reduce heat transmission. With these severe requirements, it is essential to filter and demineralise the returned *condensate*. Low pressure boilers do not need such pure water, but it must not be corrosive. Chemicals may be added to it to improve the water quality and the sludge can be removed in *blowdown*. See *deaeration, corrosiveness of water*.

**fellmongering** The preparation of hides, usually sheepskins, before tanning. See *tannery wastewater, beamhouse wastewater*.

**fermentation** *Anaerobic* biodegradation that transforms large molecules to smaller ones with the extraction of energy. Thus sugar is converted into alcohol and carbon dioxide by yeasts; *methane* and carbon dioxide are produced from sludge in *anaerobic sludge digesters*.

**ferric chloride, FeCl<sub>3</sub>** A *coagulant* or *chemical conditioner* that can be expensive compared with the alternatives. See *ferrous salts*.

***Ferrobacillus ferro-oxidans*** An early name for *Thiobacillus ferro-oxidans*. See *Thiobacillus*.

**ferrocement lining** A method for the rehabilitation of sewers. The pre-cleaned sewer is initially lined with a mixture of woven wire sandwiched in 20 mm weld mesh fabric. This reinforcement is nailed to the sewer prior to the injection of cement. Large sewers can be rehabilitated using this method. The technique gives substantial structural support to the existing sewer and stops leaks.

**ferrous metals** Iron and steel.

**ferrous salts** Ferrous iron has a valency of two, compared with the ferric valency of three. See *copperas, iron in water*.

**ferruginous discharges, red water** Wastewaters, such as *acid mine drainage*, that contain ferrous ions (Fe<sup>2+</sup>). In a river, the ferrous compounds can produce 'ochre' deposits which are formed by chemical or biochemical oxidation of ferrous compounds to ferric compounds. Chemical oxidation occurs due to the reaction of Fe<sup>2+</sup> with the dissolved oxygen in the water. Biochemical oxidation occurs due to *iron bacteria* which produce slimy reddish brown deposits containing bacteria and ferric hydroxide. Besides the problem of ochre deposits, the turbidity caused by this oxidation can, by cutting off light, reduce the flora and fauna of the river bed. For the treatment of a ferruginous wastewater, *lime* addition followed by sedimentation or lagooning can be adopted to remove the iron as iron hydroxide precipitate.

**ferrule** A screwed connection—e.g. into the wall of a water main for joining a branch pipe on to it.

- fetus, fetotoxic** The USA spelling of foetus, foetotoxicity.
- feuillée** A latrine consisting of a shallow hole in the ground, where the *faeces* are lightly covered with earth after each use.
- FGD Flue gas desulphurisation.**
- fiber** The USA spelling of fibre.
- fibreglass reinforced plastic** *Glassfibre reinforced plastic.*
- fibre recovery** Obtaining fibres from old paper or textiles, to use them for making paper, board, etc.
- Fibrescope** A method for viewing a water pipe using flexible optical fibres. It can be used up to about 1.5 m either side of access to the water main.
- field capacity, f. moisture c., moisture holding c.** The amount of water in the topsoil that can be held in it against the force of gravity. It is the ratio between the weight of water held by the soil after free drainage and the weight of the dry soil. It varies from 5% for sands to about 24% for clay loams. Soil at field capacity is in the ideal state for crops to flourish. Compare *wilting coefficient.*
- field drain** A *land drain.*
- filamentous micro-organisms** Wiry or stringy organisms: some *fungi*, *bacteria* or *algae*, which may occur in *bulking* sludge, *sewage fungus*, etc.
- filariasis** A disease caused by the tropical parasite *Wuchereria bancrofti* (Bancroft's disease or wucheriasis) or *W. malayi* (Malayan filariasis or brugiasis). *W. bancrofti* is endemic in most warm regions of the world whilst *B. malayi* is endemic in Southeast Asia, India, China and Korea. Symptoms include fever and, after prolonged attacks, obstruction of the lymph glands causing swelling of the limbs (*elephantiasis*). The vectors of the disease are various mosquitoes such as *Aedes*, *Anopheles*, *Culex* and *Mansonia*. They spread the disease by biting an infected person and passing on the larvae by biting another person. It is estimated that over 200 million people suffer from filariasis. The term filariasis can also be used to cover the diseases *onchocerciasis* and *loiasis*.
- fill and draw tank** A *sedimentation tank* that was alternately filled and emptied, now superseded for most purposes by continuous flow tanks.
- filter** A true filter separates solids from a gaseous or liquid flow that is passing through it. The solid media or woven fabric in the filter allows air or water to pass through but retain the solids. Filters may remove particle sizes smaller than the pore size due to adsorption to the surface of the filter medium. In air pollution control, particles may be removed by *fabric filters* or *depth filters*. In water pollution control, *rapid deep bed filters* and *slow sand filters* remove particles throughout the filter body. *Microfiltration* is an example of a depth filter used in water treatment. *Surface filters* in water and wastewater treatment include *microstrainers*, *drum filters*. *Ultrafiltration* and *nanofiltration* can filter out large molecules from water. Filters used for sludge dewatering include the *belt press filter*, *filter plate press* and *vacuum filter*. The *trickling filter* and *biological aerated filter* are not true filters, because the treatment of the wastewater is by adsorption, absorption and biodegradation in the *biofilm*.

**filterability** (1) A property of sludge, the ease with which water can be extracted from it either mechanically or by *sludge drying beds*, etc. It is related to the type of solids, their adhesion and size, etc., and can be modified by sludge *conditioning*. See also *Buchner funnel test*, *capillary suction time*, *filter aid*, *filter leaf test*, *specific resistance*. (2) The ability of suspended matter to be removed from water in a true *filter*.

**filter aid** (1) An inert insoluble substance added to a sludge to enhance its *filterability*. (2) A chemical added to water to improve the working of a *filter* at a waterworks. It may act as a *coagulant* or *flocculant*, or both.

**filter belt press** A *belt filter press*.

**filter blinding** See *cloth blinding*.

**filter cake** (1) Dewatered sludge from a belt filter press, filter plate press, vacuum filter, etc. It has a friable consistency. (2) In air pollution control, the dust collected on a fabric filter.

**filter candle** Hollow, candle-shaped ceramic strainers, periodically pre-coated with 3 mm of *diatomite* to make a *diatomite filter* which collects suspended solids. They are coated by surrounding them with a water-diatomite suspension and sucking the water through the candle. When, during operation, the filters block, they are backwashed (see *backwashing*), which removes the diatomite and the dirt from the water. The candles then must be recoated. Some types of filter candle are impregnated with a small quantity of metallic silver outside, to kill bacteria, and so do not have to be boiled periodically to sterilise them. The pore size is claimed to be 2  $\mu\text{m}$ . Filter candles are widely used in breweries.

**filter fly** Many types of small fly breed in *trickling filters*, especially standard rate filters, and are called *grazing fauna*. In high rate filters the water flows so fast that it washes most of the *larvae* out into the *humus tank*. Typical species are *Hydrobaenus*, *Psychoda*, *Sylvicola fenestralis*. They may create a fly nuisance, but can be reduced by flooding the filter for 24 h or by careful use of *disinfection* or an *insecticide*.

**filter leaf test** A simple way of estimating the *filterability* of a *sludge*, used in the study of *vacuum filters* or to show whether a sludge dewaterers easily. The desired vacuum is applied to a perforated disc covered by the filter medium which is moved through the sludge. The *sludge cake* formed in a given time is measured.

**filter loading** (1) For biological treatment processes, such as *trickling filters* or *biological aerated filters*, it normally means the *organic loading* in kg of BOD per  $\text{m}^3$  of filter per day. It may mean the *surface loading rate* in  $\text{m}^3/\text{d}$  per  $\text{m}^2$  of surface area. (2) For *rapid deep bed filters*, *slow sand filters* etc., the loading is the *surface loading rate* expressed as maximum flow of water per unit surface area of filter, in  $\text{m}^3 \text{m}^{-2} \text{day}^{-1}$  or  $\text{m}^3 \text{m}^{-2} \text{h}^{-1}$ , or simply  $\text{m}/\text{d}$  or  $\text{m}/\text{h}$ .

**filter plate press, filter press, plate press, pressure filter** A collection of 50 to 100 parallel, ridged, rectangular, recessed, cast iron plates which can be separated or bolted together (see *Figure F.3*). The internal surfaces of the plates are covered with a textile sheet, the filter cloth. Plate presses are used in many industries, including dewatering wastewater sludge and water



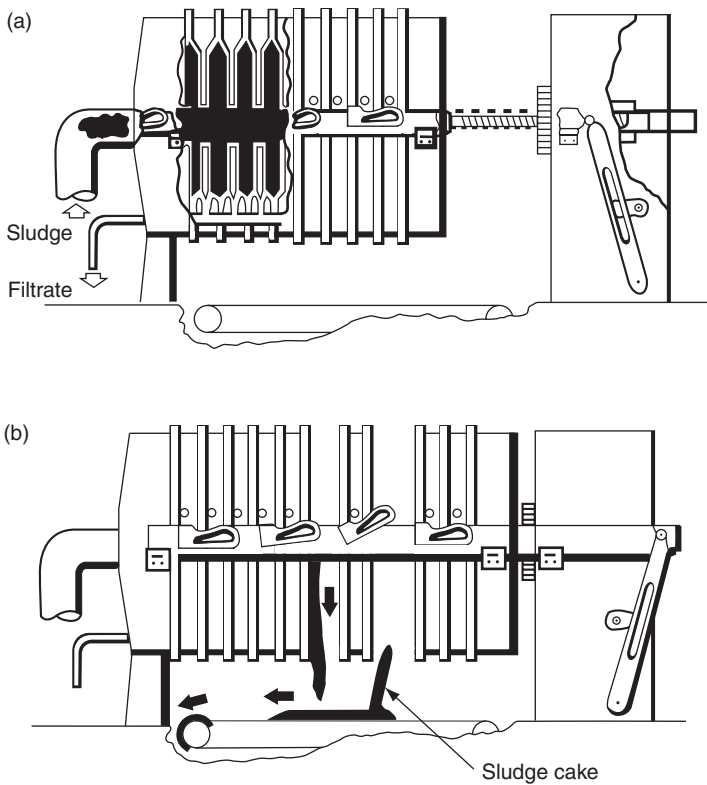

**Figure F.3** Filter plate press (a) Injection of sludge between plates during dewatering; (b) sludge cake discharge.

treatment sludge. The sludge is invariably conditioned (*see conditioning*) before pressing. After the plates have been joined together, the sludge is pumped into the press at a pressure of 5 to 7 bar which is maintained for 6 to 18 hours. The liquor passes through the cloth as pressure is applied and drained away through holes in the plates. When the filtration cycle is complete the plates are separated to release the sludge cake which is 25 to 35% solids. The press effluent is highly polluting. This type of dewatering device has the disadvantage that it is a batch process, unlike the *belt filter press*. The *membrane press* is a development of the filter plate press.

**filter run, service cycle** The length of time between one backwash (*see backwashing*) and the next in a *filter* or between *regenerations* in a *carbon adsorption bed*, etc.

**filter strips** Gently sloped grassy banks over which runoff is directed to maximise infiltration and minimise runoff into the sewerage system. It is a method for *sustainable urban drainage*. *See urban pollution management*.

**filter tube, f. bag** A bag in a *fabric filter*.

**filtrability** *Filterability.*

**filtrate** Liquid that has passed through a *filter* and so has lost some of its suspended solids.

**filtration** Cleaning of water or air by *filters, air filters*, etc. *Adsorption* on the medium is important in both types.

**filtration gallery** A *ghanat*.

**final clarifier** A *secondary sedimentation tank*.

**final cover** The soil that is placed onto a completed *landfill* site. For example it may be comprised of up to 0.3 m of topsoil on top of 0.3 m to 1 m of subsoil. A *cap* may be placed underneath the subsoil and topsoil. The surface is sloped to shed rainwater, but the slopes must not be too steep otherwise erosion of the final cover can occur. The use of final cover is important to improve the aesthetics of the landfill and develop the correct environment for the desired *afteruse*.

**final reinstatement** *See afteruse.*

**final sedimentation tank** The tanks for the last stage of *sedimentation* in a treatment scheme. It is normally the *secondary sedimentation tanks*.

**fine bubble aeration** Aeration of *activated sludge* with porous ceramic *diffusers* at or near the bottom of the *aeration tank*. The pore size of the diffusers is about 50  $\mu\text{m}$ , which results in bubbles between 0.2 and 0.3 mm. The air must be filtered to prevent the diffusers clogging. *See oxygenation efficiency.*

**fine particulates** This term usually means *PM10*.

**finer** Fine solids—e.g. smaller than 0.5 mm.

**fine screen** In water and wastewater treatment, a *screen* with openings less than 15 mm.

**FINGAL, fixation in glass of active liquors** An early method of *chemical fixation* of long-life and hazardous fission products by casting them into insoluble glass blocks with borax and silica.

**finger tipping** A method of operating a *landfill* site in which two bunds about 2.5 m high and 12 m apart are constructed. The waste is tipped and compacted between the bunds. Further bunds are similarly constructed and waste tipped into the ‘fingers’ between the bunds.

**fire hydrant** A branch pipe, usually in a street, connected to the water main, which enables a fire hose to be connected to the main. In low fire risk areas, hydrants may be placed every 100 to 150 m; in high risk areas, sometimes as close as 30 m. The minimum flow from one hydrant should be 1.4 m<sup>3</sup>/min but 25 m<sup>3</sup>/min may be needed in a highly populated area; this flow is obtained by grouping several hydrants.

**fire point** The lowest temperature of a combustible liquid at which enough vapour is formed to burn continuously. It is higher than the *flash point*.

**fire side** The surface of a boiler tube which is in contact with the flames or flue gases, not the *water side*.

**firm yield, dependable yield** In a water resource, the sustainable quantity of water that can be taken from the resource over a long period of time (e.g. many decades).

**first draw sample** A sample of water from the consumer’s tap after the water has been standing in the water pipes for a number of hours, e.g. overnight.

**first foul flush** In the early stages of a storm, the stormwater flow in the sewer will wash off pollutants accumulated on the surface or flush out solids that have settled in the sewer etc. Consequently, the first part of the storm flow may be heavily polluted.

**fixation of nitrogen** Getting nitrogen out of the air and into plants, such as beans and peas, or aerobic and anaerobic nitrogen fixing bacteria. *See eutrophication, nitrogen cycle.*

**fixed bed adsorption** The use of a column or tower containing a fixed medium such as *activated carbon* so that the activated carbon adsorbs the unwanted pollutant from the effluent gaseous or aqueous stream.

**fixed bed reactor** A process in which the medium is fixed such as a *rapid deep bed filter*, a *trickling filter*, a *packed tower aerator*, etc.

**fixed bridge scraper** A rotating *scraper* in a circular *sedimentation tank*, which moves the sludge to the *sludge hoppers*. A fixed bridge spans half or all of the tank. The scraper is driven from and attached to a central driving shaft carried by the fixed bridge. *Compare rotating bridge scraper.*

**fixed film process, f. f. bioreactor, f. f. reactor** An *attached growth process* or reactor.

**fixed volume filter press** A *filter plate press*. *Compare membrane press.*

**fixing of hazardous waste** *Encapsulation.*

**flagellate protozoon, Mastigophora, Flagellata Protozoa** equipped with *flagella*, unlike the *ciliate protozoa* or the amoeba group of *rhizopods*. They are common in aerobic biological treatment and may indicate an *activated sludge* that is in poor condition. *Photosynthetic* flagellates (phytoflagellates) may be considered as either protozoa or algae. Non-photosynthetic ones are known as zooflagellates.

**flagellum** (plural **flagella**) Latin for a whip, this means a tail in a micro-organism that may help it to move (*see flagellate protozoon*). Various algae and bacteria also have flagella.

**flame photometry, flame emission spectrophotometry** An analytical technique used for measuring low concentrations of some metals e.g. lithium, potassium, sodium, calcium, magnesium or strontium. A spray of the liquid sample is injected into a flame and the colour intensity produced is measured photoelectrically.

**flap valve** A *non-return valve* with a hinged flap that opens in one direction only.

**flash cooling** Cooling of *flue gases* in a dry bottom *evaporative tower*.

**flash distillation** *See multi-stage flash distillation.*

**flash drying** A method of drying sludge. After the sludge has been mechanically dewatered it is pulverised and mixed with a small quantity of previously dried sludge and fed into a stream of gas at 500 to 650 °C. In a few seconds the moisture content falls to 10% and the sludge laden gas is led to a *cyclone* which extracts the solid.

**flash mixer** A device to create *turbulent flow* in water and thus to mix chemicals such as *coagulants* quickly and intimately with it. It may be a *weir* with turbulence downstream or a narrow jet through which the water or the admixture passes.

**flashover** In an *electrostatic precipitator*, sparking between the *electrodes*, a fault that reduces the collection efficiency.

**flash point** The lowest temperature at which a substance will burn momentarily when a flame is put to it—often part of the specification of a fuel oil. Compare *fire point*.

**flashy stream** A stream that drains a *catchment* of high *runoff*, where the flow rises rapidly after rain and falls again equally fast—e.g. in mountain districts or the large paved areas of cities.

**flatworms, Platyhelminthes** A phylum that includes *flukes* and *tapeworms*.

**Flavobacterium Facultative** bacteria that flourish in *trickling filters*, *activated sludge* and possibly in *anaerobic sludge digestion tanks*.

**flax retting wastewater** The manufacture of linen from flax may be *anaerobic*, resulting in a coloured, smelly acidic wastewater with a high BOD. With the *aerobic* process, however, the effluent is partly re-used and generally much less polluting.

**flexible membrane liner** A liner, e.g. at a landfill site, that uses *geomembranes*. See *landfill liner*.

**flies** See *caddis flies*, *Diptera*, *dragon fly*, *filter fly*, *mosquitoes*, *stone fly*.

**flight scraper** A *scraper* in a *horizontal flow sedimentation tank*, with horizontal blades (flights) that move the sludge along the bottom of the tank towards the wastewater inlet. They are pulled along by a chain at each side. Under the inlet to the tank is a deeper part called the *sludge hopper*, into which the scraper sweeps the sludge. Along the surface in the opposite direction the flights return, sweeping the *scum* to the outlet. Each endless chain driving the scraper runs on four sprockets at the surface and bottom of the inlet and outlet ends of the tank. (See *Figure F.4*.)

**floatables** In wastewater, material that floats on the surface, e.g. oil and grease.

**floating aquatic plant treatment system, raft lagoon** A *natural treatment system* in which aquatic plants with leaves that float on the water surface, such as duckweed and water hyacinths, are grown in ponds of wastewater effluent in order to remove nutrients, particularly phosphates. These plants have fast reproduction rates. The plants may be contained in ‘rafts’ floating on the pond. Ponds may be up to 1.6 m deep. If settled wastewater is being

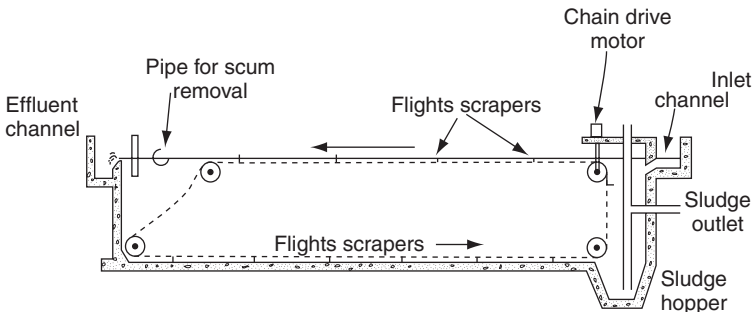

**Figure F.4** Flight scraper in rectangular sedimentation tank.

treated, supplementary air may have to be pumped into the pond in order to keep it aerobic. *See constructed wetland.*

**floating bed scrubber** A *moving bed scrubber*.

**floating roof tank** A tank to contain oil or for *anaerobic sludge digestion*, with a hollow steel roof like a pontoon to enable it to float on the liquid or to be raised by the gas pressure. Seals at the rim reduce vapour losses.

**floating velocity** The least upward flow rate that will hold up a particle in a vertical pipe. It is determined for spherical particles by *Stokes's law*. For removing *plastics* in an *air column separator*, a velocity of 1.7 to 2 m/s is needed, and for removing paper at least 2.3 to 2.5 m/s. *See also air classification, rising current separator, terminal velocity.*

**float and sink treatment** In *mineral dressing* or laboratory examinations, the separation of a mixture of substances of different densities by suspension in a *dense medium* with a density intermediate between those of the two components of the mixture. This separates the mixture into two fractions—a dense 'sinks' fraction below and a light 'floats' fraction above. Sometimes there is an intermediate product, 'middlings'.

**floc** (Latin *floccus*, a lock of wool) A grouping of solid particles that appears woolly. Unlike granular solids, which settle easily and are dense, a floc breaks up if its shear velocity is exceeded.

**floc blanket clarifier** A *sludge blanket clarifier*.

**flocculant** A chemical or physical reagent such as a *polyelectrolyte*, which promotes *flocculation*. It acts as a bridge to bind the suspended particles together. A flocculant may act also as a *coagulant*. *Compare flocculent.*

**flocculation** The grouping of solids in water, resulting in *flocs*, often wrongly thought to be the same as *coagulation*. It can be promoted by gentle stirring (*mechanical flocculation*) or by adding chemicals (*flocculants*).

**flocculator** A stirrer used in *mechanical flocculation*.

**flocculator clarifier** A tank used in the treatment of water which consists of both a *flocculation* zone and a separation (*clarification*) zone to remove the flocs from the water. Various types exist, normally based on *solids contact clarifier* (e.g. *sludge blanket clarifier*, *Figure S.7* and *solids recirculation clarifier*, *Figure S.12*). Smaller or older treatment works may have tanks with a completely separate flocculation zone and settling zone, sometimes known as one pass (or single pass) flocculator clarifiers. These may be rectangular or circular and up to 50 m diameter. In circular clarifiers a central flocculation zone is surrounded by the settling zone. The *surface loading rate* is from 24 to 60 m<sup>3</sup> per day per m<sup>2</sup> of surface area, depending on raw water quality.

**flocculator DAF unit** *See dissolved air flotation.*

**flocculent** Description of particles in water or wastewater or sludge that form *flocs*.

**flocculent settling** *See settling regimes.*

**flood frequency** A 100 year flood is a flood that occurs, statistically, once in a hundred years, whereas a 500 year flood is even less frequent but is much worse in the area and depth of the flood.

- flood irrigation** Irrigation of crops by flooding the land. In dry climates there may be an excessive loss of water by *evaporation* and therefore *drip irrigation* or *furrow irrigation* may be preferable.
- flood plain** The area alongside a water course that may be flooded.
- flood routing, streamflow r.** Calculations about the passage of floods and their possible storage in reservoirs or on flooded low lying land, so as to reduce peak flows. The greater the area of *catchment* that is flooded, the more will be the reduction of the peak flow downstream of the flooded area.
- flood stage** The depth of water that has to be reached in a water course before flooding starts in the surrounding area.
- flora** The plants of a region or period.
- flotation** In water and wastewater treatment several flotation processes are used. *Dissolved air flotation*, which uses bubbles of air to lift solids or oil or grease, is one of the common processes. *See also API separator, dispersed air flotation, electroflotation, foam fractionation, froth flotation.*
- flotation tank, f. cell** A tank from which floating matter can be skimmed off.
- flow balancing tank** A *balancing tank* used to even out the variations in flow.
- flow duration curve** A plot of flow against the percentage of time that the flow is exceeded.
- flow equalisation (or equalization) tank** *See balancing tank.*
- flow modulated pressure reducing valves, demand sensing PRVs** *Pressure reducing valves* that allow increased pressure at peak demands. The downstream flow and pressure are measured and fed back to the variable pressure control mechanism.
- flue** A usually horizontal or vertical duct that should be gastight and leads furnace gases to a chimney or to *dust arrestors*, etc. *See breeching.*
- flue fed incinerator** A type of *incinerator* in which the refuse chute acts also as a chimney. Consequently, smoke can pollute areas near the points where the refuse enters the chute.
- flue gas** The hot gas from a furnace or incinerator etc, passing along a *flue*. More than 99% of it is nitrogen, carbon dioxide, oxygen and water. A *gas cleaning plant* may be needed to remove *dust, grit* and *sulphur dioxide* etc. Faulty furnace operation may result in the presence of several per cent of *carbon monoxide* as well as a fraction of *nitrogen oxides* and other polluting gases. *See incineration, products of incomplete combustion.*
- flue gas cleaning** The removal of particulates from effluent gases can be by *cyclones, electrostatic precipitators, fabric filters, gravity settling chamber, wet scrubbers*. Gaseous air pollutants can be removed from effluent gases by use of adsorption processes such as *flue gas desulphurisation* (SO<sub>2</sub> removal) or *wet scrubbers*.
- flue gas desulphurisation (or desulphurization, desulfurisation, desulfurization), FGD** Removal of *sulphur dioxide* from *flue gases*. The processes can be classified into non-recovery processes; recovery processes and dry processes. Non-recovery or 'throw away' processes are at present the most economic and therefore the most commonly used. Non-recovery simply means that the original reagents are not recovered after desulphurisation of the flue gases and must be disposed of by landfill or possibly reclaimed

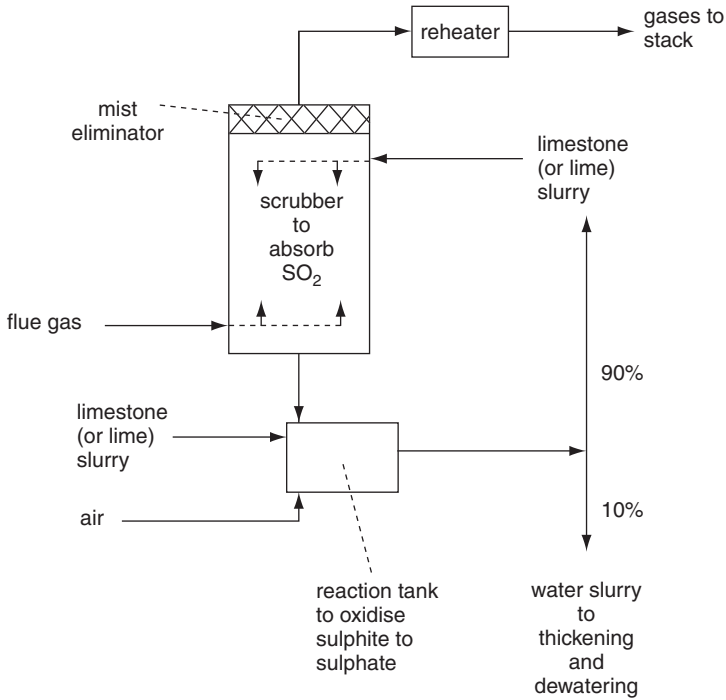
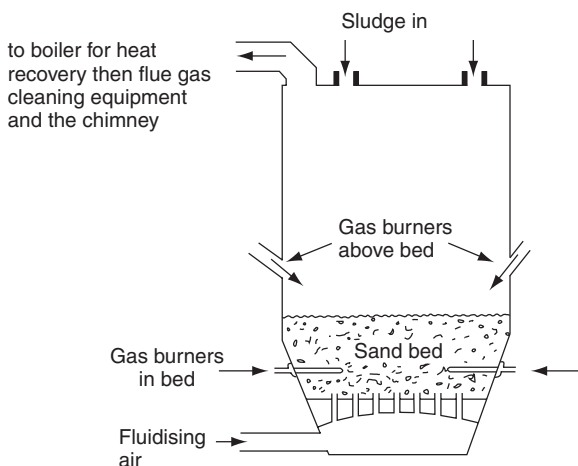

**Figure F.5** Flue gas desulphurisation using a limestone wet scrubber.

to serve other industrial processes. The most common process is *wet scrubbing* (see Figure F.5). This commonly uses lime or limestone mixed with water to form a slurry which is sprayed into the flue gases in the absorber, where the  $\text{SO}_2$  is absorbed. The gases are then passed through a demister to remove any droplets. The purpose of the heat exchanger is to reheat the flue gases to give buoyancy when they are emitted to the atmosphere. The heat exchange is carried out between the gases before and after the absorber so that the loss of efficiency is kept to a minimum. The slurry containing the  $\text{SO}_2$  is removed to a tank or pond which allows the calcium sulphite and calcium sulphate to precipitate. Calcium sulphate is gypsum and may have commercial value. After precipitate of the sulphite/sulphate mixture, the liquor can be recycled to the absorber after the addition of fresh lime or limestone. Other non-recovery systems include the use of  $\text{NaOH}$  to react with the  $\text{SO}_2$ . In a *dry scrubber*, the gas stream is treated by passing through lime particles for  $\text{SO}_2$  removal. See also *semi-dry scrubber*, *Wellman-Lord process*.

**flue gas quench** The direct injection of water (normally) or air in order to cool the *flue gas* before discharge to the atmosphere.

**fluid classification** The use of *air classification*, *dense medium cyclones*, *float and sink treatment*.



**Figure F.6** Fluidised bed incinerator for burning sludge.

**fluidised bed dryer** A sludge drying process in which hot gas or air flows vertically through the drying sludge particles so that the particles are suspended but not blown out of the dryer with the gas. The hot gas from the dryer has to pass through a dust collection device in order to collect particles that have been carried out.

**fluidised bed incineration** A bed of mixed inert particles and fuel through which air or oxygen is blown up to hold them in suspension and thus increase the burning rate (see Figure F.6). It is a form of *suspension firing* and has the advantage of low *excess air*. One essential is maintaining a temperature below the melting point of the ash otherwise the bed clogs and ceases to work. Wastewater sludge or domestic waste can be burnt by feeding it onto a fluidised sand bed. Incinerators are 3 to 7 m in diameter. The sand bed when quiescent may be about 0.8 m deep. The temperature in operation is about 800 °C. Some ash is carried off in the furnace gases, but can be removed by an *electrostatic precipitator* or other particulate removal device.

**fluidised bed reactor** A treatment process in which the solid media is kept in suspension by the upflow of water or air. See *biological fluidised bed*.

**fluke** *Trematode*.

**flume** (1) An open channel that carries water or wastewater. See *leat*. (2) A structure that narrows an open channel, often as a measuring flume, such as a *standing wave flume* or a *Venturi flume*.

**fluoranthene, fluoroanthene** A *polycyclic aromatic hydrocarbon* (PAH) that is not considered significant to health and is no longer within the restriction for PAHs in drinking water within EU countries. It may be used as an indicator of other more dangerous PAHs.

**fluorene** One of the *polycyclic aromatic hydrocarbons*.



**Fluorescein** A red solid. Its sodium salt (uranine yellow) dissolves in water to produce a green liquid which fluoresces (emits light) especially in ultra-violet. It is used as a dye tracer and can be detected at very low concentrations.

**fluoridation** Fluoride in the diet is absorbed into the body to form calcium hydroxyfluoroapatite in the teeth and bones. At levels of fluoride in drinking water greater than 5 mg/l, the consumer may suffer from **fluorosis**, which is excessive hardening of the bones and mottling of the teeth. At levels of 1 mg/l in water, the teeth are hardened to protect against decay but fluorosis does not occur. After the teeth have formed there is less advantage in drinking water containing fluoride. See *Table D.2 Drinking water standards*.

**fluorinated hydrocarbons** *Hydrofluorocarbons*.

**fluorocarbons** See *perfluorocarbons*.

**fluorosis** The effect of too much fluoride in the diet. Slightly excessive fluoride in the diet can cause dental fluorosis which is the permanent discolouring and mottling of the teeth. More severe is skeletal fluorosis, where the fluoride has been taken into the bone structure to give brittle bones. The disease can be common in areas where the drinking water has 10 mg/l of F. See *fluoridation*.

**flush cistern** *Cisterns* that flush water closets should operate by a *siphon*, delivering 9 litres of water in 5 to 6 s, and be controlled by a float valve. For urinals, automatic flushing should release 4.5 litres per urinal every 25 min.

**flushing bioreactor landfill** The recycling of *leachate* back through the *landfill*. This accelerates the biodegradation of the fill material by recycling the micro-organisms and nutrients in the leachate. The leachate is collected from the bottom of the landfill and recycled over the landfill at a rate of 3 to 10 m per year. The landfill should be stabilised within 30 to 50 years. This is one method of achieving a *sustainable landfill*.

**flushing tank** See *sewer flushing*.

**fluvial** From or associated with streams and rivers.

**flux** Mass flow per unit cross sectional area, as in the *solids loading rate*.

**fly ash** The light ash from an *incinerator*, coal burning electricity generating plant etc., that is carried off in the *flue gas*. It can be removed from the flue gas by *fabric filters* or *electrostatic precipitators*.

**fly tipping** The unauthorised dumping of waste, either at an unsuitable place (e.g. waste land) or at the *landfill* site, often during the period when the site is locked up and no one is in attendance.

**F : M ratio, food : micro-organism ratio, organic loading, sludge loading rate, SLR** The number of kg of *BOD<sub>5</sub>* per day applied to an *activated sludge* plant per kg of (dry) activated sludge. F : M calculation can be based on *MLSS* (mixed liquor suspended solids) or *MLVSS* (mixed liquor volatile suspended solids).

For the UK, it is:

$$F : M = \frac{\text{BOD}_5 \text{ of wastewater (mg/l)} \times \text{flow of wastewater (m}^3\text{/d)}}{\text{MLSS (mg/l)} \times \text{aeration tank volume (m}^3\text{)}}$$

For the USA, it is:

$$F : M = \frac{\text{BOD}_5 \text{ of wastewater (mg/l)} \times \text{flow of wastewater (m}^3\text{/d)}}{\text{MLVSS (mg/l)} \times \text{aeration tank volume (m}^3\text{)}}$$

The units of  $F : M$  are  $\text{days}^{-1}$ . As about 70% of the sludge is volatile, the MLVSS is about  $0.7 \times \text{MLSS}$ . Therefore, the  $F : M$  based on MLSS is approximately  $0.7 \times$  the  $F : M$  based on MLVSS for the same BOD, flow and aeration tank volume. It is the common design criteria for calculating the size of an activated sludge aeration tank. Typical design criteria are given below.

	$F : M$ ( $\text{days}^{-1}$ ) based on MLSS	$F : M$ ( $\text{days}^{-1}$ ) based on MLVSS
temperate climates	0.2	0.3
hot climates	0.35	0.5
extended aeration	<0.1	<0.15
nitrification (temperate climates)	0.07	0.1
nitrification (hot climates)	0.15	0.2

The micro-organisms in the activated sludge process metabolise faster in warmer climates and so the  $F : M$  is higher. **Nitrification** is a slow microbial process and so the  $F : M$  s are reduced. **Compare mean cell residence time. See sludge production.**

**foamed glass** Foamed glass can be made from **cullet**. It is added to concrete to improve its insulation and has been used for making bricks.

**foam fractionation** (1) Removal of water-soluble organic compounds such as **synthetic detergents** or dyes from wastewater or water by bubbling air through it and collecting the foam in the exit air stream or skimming it. Solids also may be removed in the foam. (2) **Froth flotation.**

**foaming** (1) Foam, caused by **synthetic detergents** (syndets) or **polyglycols** in rivers or **digesters** or **activated sludge** plants, can be blown into the air and cause complaints. Syndet foam also reduces the rate of transfer of oxygen from air to the wastewater. Adding or spraying with anti-foam chemicals is sometimes practised. (2) or **Nocardia foam, chocolate mousse** A thick brown foam that that can form in an **activated sludge** aeration tank. It is often associated with the growth of a filamentous micro-organisms such as the **actinomycete** species of *Nocardia* or *Gordona* or *Mycobacterium* or *Microthrix* or *Rhodococcus*. Reducing the  **$F : M$  ratio** in the activated sludge plant can assist in reducing the production of the foam.

**foetotoxic** A property of a toxic substance that adversely affects a developing foetus.

**FOG** Fats oils and greases in a wastewater. **See greases and fats, oil separator.**

**fog** Tiny drops of water vapour in the air, usually in calm weather, caused by air cooling below its **dewpoint** and greatly reducing visibility. Fog occurs usually during an **anticyclone** and often under an **inversion**, collecting polluted air.

- fold and form lining** A method of pipeline rehabilitation in which a plastic pipe is folded to reduce its size before being pulled into the old pipe and then expanded to its original shape by pressure and/or heat. *See close fit liners.*
- food chain, trophic c.** A sequence of living organisms that feed on one another. Because the simpler organisms at the bottom of the chain are much more numerous than the higher organisms, it is often known as an ecological (or food) pyramid, with each level of the pyramid feeding off the level below it.
- food poisoning** Diarrhoea and other complaints, often caused by *Campylobacter* or *Salmonella* (other than *S. typhi* and *S. paratyphi*). Food poisoning is the mildest of the *enteric fevers* and is rarely fatal. It is spread via faeces and can contaminate food or water.
- food processing wastewater** *See cannery wastewater, dairy and milk bottling wastewater, meat processing wastewater.*
- food pyramid** *See food chain.*
- food to micro-organism ratio *F: M* ratio.**
- food web** A network of *food chains*.
- forced air composting** An *aerated static pile*.
- forced draught degasifiers** *See degasifiers.*
- forced draught fan** A fan that blows air into a furnace. It therefore handles only cool air and is subject to much less severe working conditions than an *induced draught fan*, but both are needed in some installations.
- force main** A *rising main*.
- force main sewer** A *pressure sewer*.
- formaldehyde** HCHO This volatile substance can be a significant indoor and outdoor air pollutant. It can be released from insulation, furniture, paint, textiles and carpets and can cause irritation of eyes, nose and throat. In outdoor air pollution, formaldehyde can be formed as part of the reactions in *photochemical smog*. *See VOC.*
- formalin** Commercial grade of *formaldehyde*.
- formazin turbidity unit, FTU** *Nephelometric turbidity unit.*
- formite** An inanimate object which may convey a pathogen between patients.
- fossil fuels** Coal, oil, natural gas, peat or any other fuel found in the earth except nuclear fuels.
- foul sewer, sanitary s.** A *sewer* carrying domestic or industrial wastewater. In a *combined system* it also carries *stormwater*.
- Foyn's process** *Electrolytic treatment of wastewater.*
- FR** *Federal Register.*
- framework for Community action in the field of water policy** *See Water Framework Directive, 2000.*
- franchise collection** Refuse collection by a private contractor.
- Francisella tularensis*** One of the bacteria that causes *tularaemia*.
- freeboard** The height between the highest water level and the top of a tank—the height that prevents overflowing.
- free available chlorine** *Free residual chlorine.*
- free fall velocity, falling speed** *See Stokes's law.*

**free residual chlorine, f. available c.** The unreacted *hypochlorite* ion ( $\text{OCl}^-$ ) or hypochlorous acid ( $\text{HOCl}$ ) after *breakpoint chlorination*.

**free swimming ciliates** See *ciliate protozoa*.

**free water surface constructed wetland** See *constructed wetland*.

**freeze toilet** A bucket latrine with the bucket in a deep freeze at  $-15^\circ\text{C}$ . The excreta are frozen, which eliminates the health hazard of the usual bucket latrine, but the capital and operating costs are high.

**freezing** (1) A possible method for desalination but it is not economic. When water is partially frozen, the salts remain in the liquid fraction and can be washed away from the ice, leaving it purer than the water it came from. (2) Freezing of sludge can break it down and reduce its volume. Freeze-thawing of a difficult, 2% alum sludge concentrates it to 20% solids, but it is expensive.

**French degree of hardness** See *degree of hardness*.

**French drain** A sloping trench back-filled with coarse stones, which drains away surface and subsurface water, usually with the help of a *land drain*.

**freons** See *chlorofluorocarbons*.

**freshet** A clear mountain stream; hence, a 'plug' discharge of *compensation water* from a reservoir to help fish to move along a river.

**fresh sewage** Wastewater with some dissolved oxygen. It does not smell unpleasant. Compare *septic sewage*.

**Freshwater Fish Directive 1978** The EU Directive that set 14 physical, chemical and microbiological water quality parameters for areas in certain EU river waters in order to support and increase fish life such as salmon and trout.

**freshwater mussels** Water mains have been known to suffer from *molluscs* such as *Dreissena polymorpha* in temperate climates or *Limnoperna fortunei* in warm climates. They have been flushed out by heavy *chlorination* (50 mg/l), during which the main cannot be used. In natural waters, large freshwater mussels can be used in a *biotic index* as an indicator of reasonable unpolluted water, requiring a fairly high dissolved oxygen level.

**freshwater shrimps, Amphipoda** An indicator of clean water, requiring a fairly high dissolved oxygen level, e.g. *Gammarus pulex*. It can be used in a *biotic index*.

**froth flotation** *Flotation* of finely divided, even *colloidal*, solids helped by adding a suitable soap, oil or other *surfactant*. When air is blown in, the froth contains some of the solids.

**Froude number** A dimensionless number that describes *open channel flow*. It is given by  $V/(dg)^{0.5}$  in which  $V$  = velocity,  $d$  = depth of liquid and  $g$  = acceleration due to gravity.

**FTU** Formazin turbidity unit See *nephelometric turbidity unit*.

**Fucus vesiculosus** *Bladder wrack*.

**fuel efficiency** The proportion of the *calorific value* of a fuel that is converted into useful energy. It is only about 35% in the most modern purely electrical generating stations, but combined with heat production, as in district heating plants, the efficiency can exceed 70% at the boiler.

**fuel NO** Nitric oxide (NO) produced from the nitrogen compounds in fuel.

**fugitive emissions** Emissions from *non-point sources of pollution*.

**fully contained landfill** See *entombment landfill*.

**fulvic acids** A group of natural organic acids that can be found in water that runs off land with peat or humus. They contribute to the trihalomethanes production after chlorination.

**fume** Fume is airborne material smaller than 1  $\mu\text{m}$  and may be as small as 0.001  $\mu\text{m}$ . The distinction between *dust* and fume is that fume disperses as a gas.

**fume hood** A *dust extraction hood*, used for extracting chemical fumes.

**fume incineration** Burning of toxic or polluting fumes so as to make them safe. Burnable fumes can be lean or rich. Lean fumes contain enough oxygen for them to burn if a flame is applied to them. Rich fumes come from activities such as paint drying, solvent recovery or the rubber industry and need added air so as to have enough oxygen to burn.

**fumigation** (1) Fumigation describes a specific shape of a plume from a chimney (see *Figure P.7*) It occurs at transient conditions such as the ground warming up after a cold night. This produces a relatively normal *lapse rate* at low levels but an *inversion* at higher elevations. The pollutants disperse in a downward direction causing substantial air pollution at ground level but cannot escape upwards because of the inversion. (2) Exposure of pathogens or pests to poisonous gas or smoke, so as to kill them.

**fungi** (plural *fungus*) Tiny *aerobic, heterotrophic, protists* containing no chlorophyll. They can tolerate drier and more acid conditions than most bacteria and also are often multicelled. They live in the earth, fresh water and sea water. Often they grow so large that they can be seen with the naked eye (e.g. mushrooms). Many grow as filaments and may be seen in polluted rivers or *trickling filters* or *activated sludge*. The optimum *pH* for most types is between 5 and 6 but they can exist within at *pH* values between 2 and 9. Because fungi are wholly aerobic, they can, in animals, exist only on the skin or in the bloodstream or lungs. Consequently, there are relatively few fungi that cause disease in humans, although many cause disease in plants—e.g. potato blight, Dutch elm disease. Fungi include yeasts, which are unicellular. See *moulds*.

**fungicide** A *pesticide* that kills *fungi*.

**furrow irrigation** A type of *irrigation*, widely used for row crops, with small flooded furrows between the rows of crops. This method has only one fifth to one half the top surface of *flood irrigation* and therefore loses less water by evaporation.

**furans** See *dibenzofurans*.

**furnace bottom ash FBA** The ash that is derived from the bottom of an incinerator or coal fired electricity generation plant.

***Fusarium aquaeductum*** A true fungus that can grow on *trickling filters* and in rivers. It may give an orange-pink colour to the surface of the filter.

**FWPCA** The former US Federal Water Pollution Control Administration, taken over by the *USEPA*.

**FWS constructed wetland** Free water surface *constructed wetland*.



**gabion** A free draining wall constructed from large steel mesh baskets filled with rocks.

**GAC** *Granular activated carbon.*

**GAC filter** *See carbon adsorption bed.*

**gage height** The water level (i.e. *stage*) in a river, lake, reservoir etc. A gage station measures the gage height.

***Gallionella ferruginea*** An *iron bacteria* that oxidises ferrous iron and produces gelatinous ferric iron deposits.

**galvanic corrosion, electrolytic c.** Corrosion of metal in which *anodic* and *cathodic* areas are distinguishable—e.g. two dissimilar metals in contact or one metal in two different environments. The cathode does not lose metal; the *anode* may. The jointing of dissimilar metals can cause electrical current to flow with the result of corrosion of one of the metals. For a connection of lead and copper pipe, the lead tends to corrode.

**galvanic series, electrochemical series.** A list of metals that are increasingly *anodic* in a particular medium—e.g. for sea water:

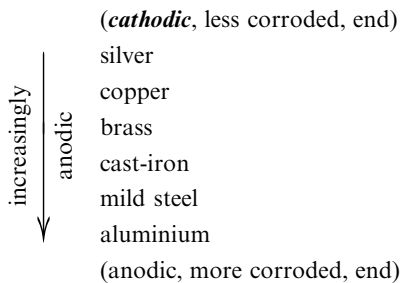

**galvanised steel, g. iron** Steel or iron coated with a thin layer of zinc to protect it from corrosion. The zinc may be attacked by acid or strongly alkaline water or by dissolved chloride. Galvanised metal has low scrap value, unlike pure zinc or pure iron or steel.

**game fish** Fish that are exciting to catch and they are good eating. The families of salmon and trout need a dissolved oxygen level of at least 4 to 5 mg/l unlike coarse fish, which can exist with less.

**gamma radiation** Electromagnetic radiation with a wavelength shorter than X rays. That from cobalt-60 has been used for disinfecting both water and wastewater. Because of its high penetrating power, it can be a hazard to health even when delivered some distance from the body.

**Gammarus pulex** A type of *freshwater shrimp* which needs high levels of dissolved oxygen and may be used in a biotic index.

**Gammexane Benzene hexachloride.**

**ganat** A *ghanat*.

**gangue** In an ore, the rock that contains so little metal as to be worthless.

Most of it is extracted in *mineral dressing*.

**garbage** Kitchen waste. Although it can mean other refuse.

**garbage farm** A disposal method for garbage in which the refuse is ploughed into the topsoil of a working farm.

**garbage grinder, kitchen g., home g., disposal unit, waste disposal unit, pulping unit** A machine with an electrical input of about 250 W which shreds food wastes so that they can be washed down the sink. It increases the *water demand* by about 5 to 10 litres per person per day. The BOD<sub>5</sub> of domestic wastewater may increase by 25% due to the extra food waste being added to the wastewater. See *population equivalent*.

**garden waste** See *green waste*.

**garnet** A group of silicate minerals with a specific gravity around 4.2, much denser than quartz (s.g. 2.65). It may be used in *rapid deep bed filters* in the 1 mm size as a layer 70 to 80 mm thick between the fine sand and the gravel around the *underdrains*, to prevent them mixing. Garnet is too dense to fluidise during *backwashing* and therefore ensures that the gravel below it is not fluidised.

**gas chromatography, GC** A common analytical technique that can be used to measure the concentration of a wide range of pollutants in the environment. In a gas chromatograph (GC), the volatilised or gaseous sample is carried through a column by an inert carrier gas. The column may require to be heated to maintain the sample in the gaseous phase. The column is commonly a capillary, 5 to 100 m long and 0.1 to 0.8 mm diameter. The inside wall of the capillary column is coated with an inert liquid (gas liquid chromatography, GLC). The column and stationary liquid coating is chosen so that the components of the sample being investigated move through the column at different speeds. The components of the sample are detected and recorded at the outlet at different times. The retention time of the compound in the column for a given set of GC or GLC operating conditions is related to standard chromatograms that have been obtained for that instrument and thereby identify the compounds in the sample. The peak height or area on the *chromatogram* is a quantitative measure. The compounds to be analysed in a GC or GLC must be able to be volatilised without decomposition. If this is not possible then *HPLC* is a more suitable analytical technique. A GC or GLC can be coupled with a mass spectrometer (known as *GC-MS*). The chromatographic equipment separates the constituent compounds of the sample which are then analysed for their mass spectra by *mass spectrometry*.

**gas chromatography mass spectrometry** See *GC-MS*.

**gas cleaning plant** See *flue gas cleaning*.

**gas/cloth ratio** See *air/cloth ratio*.

**gas collection** See *landfill gas vents, landfill gas wells*.

**gasification** The heating of organic material in order to degrade some of the material to burnable gases which can be subsequently used for energy. It can be used for dried wastewater sludge, waste tyres, etc. which are heated to 850 °C when much of the organic content decomposes to gases.

*Pyrolysis* is partly gasification, but liquid products may also be formed in pyrolysis.

**gas lift pump** An air lift pump used for circulating the sludge in a digestion tank. Instead of air, it uses sludge gas from the digester to avoid forming an explosive mixture in the tank.

**gas lift reactor** An *airlift reactor*.

**gas liquid chromatography, GLC** See *gas chromatography*.

**gas migration** See *landfill gas migration*.

**gas monitoring** See *landfill gas monitoring*.

**gasoline, gasolene** An alternative term for petrol which may be abbreviated to gas.

**gas production** See *anaerobic sludge digestion, methane fermentation, landfill gas production*.

**gastroenteritis** Inflammation of the stomach and intestine, sometimes caused by *enteric fever* or *food poisoning*.

**gas vents** See *landfill gas vents*.

**gas wells** See *landfill gas wells*.

**gas yields** See *landfill gas production*.

**gate valve, sluice v.** A valve with a plate or wedge perpendicular to the line of the pipe or channel which can be moved up or down to open or restrict the flow.

**gathering ground** A *catchment area*.

**gauge well** A *stilling well*.

**GC** A gas chromatograph See *gas chromatography*.

**GC-MS, gas chromatograph mass spectrometer** The coupling of a gas chromatograph and a mass spectrometer. The chromatographic equipment separates the constituent compounds of the sample which are then analysed for their mass spectra. See *gas chromatography, mass spectrometry*.

**generation time, doubling t.** The time taken for one cell to become two, or for two to become four, etc. For bacteria, generation times vary from a few days to 20 min, according to the conditions—especially pH, adequacy of nutrients, temperature and type of bacteria.

**Geneva Convention** A 1983 convention that relates to the trans-boundary air pollution. It includes developing policies to limit air pollution. The USA and UK are among the countries that are signatories to this convention.

**genotoxic** A property of a toxic substance that adversely affects genetic material.

**genus** (plural **genera**) A division in *taxonomy*, which groups closely related species. Names of *species* include two (occasionally more) words, of which the first is always the genus. Thus, in *Escherichia coli*, the genus is *Escherichia*.

**geocomposite liner** A *composite liner* that includes *geomembranes* or *geotextiles*.



**Geographical Information System, GIS** The linking of the geographical data to digitised maps and drawings to produce a wide range of information and display for a specific location.

**geomembrane** Plastic fabrics that have a very low permeability, made from materials such as *high density polyethylene* (HDPE) or polyvinyl chloride (*PVC*) and are used as impermeable liners at *landfill* sites. Geomembranes can easily be damaged during installation. HDPE liners are the most common choice for use at landfill sites. The HDPE liner should be 2 mm thick and supported by 0.6 m of compacted soil or sand. The seams between the HDPE sheets are joined on site. HDPE offers good resistance to a range of chemicals. *See landfill liner.*

**geomorphology** The study of the processes involved in creating landforms.

**geonet** A plastic netting that can be used as a coarse filter for suspended solids and thereby protect a drainage layer in a *landfill* site.

**geosmin** An organic chemical that can produce unpleasant odours in the water at very low concentrations. It can occur due to algal growths in the water.

**geostrophic** Wind speed normally increases with elevation in the lower atmosphere because near the ground the wind is slowed down by the effect of friction on the ground surface. At about 500 m above the ground the wind reaches its frictionless velocity. This is known as the geostrophic velocity.

**geosynthetic clay** A thin layer of clay attached to a *geotextile* to produce a sheet of low permeability material. Alternatively, the clay layer may be sandwiched between two geotextile layers. It can be used as a *landfill liner*.

**geotextile** A woven plastic material that is permeable to water although it may be designed to remove suspended solids. It can be used as a drainage layer in a *landfill* site for the collection of *leachate*.

***Geotrichum candidum*** A fungus that may be found in *trickling filters*, *sewage fungus*, etc.

**ghanat, ganat, kanat, filtration gallery** A long, ancient tunnel or network of tunnels dug to collect water in arid countries, usually in alluvial ground, probably first used 2500 years ago in Persia. The tunnels are dug like an *adit* at a slight upward slope into hillsides to obtain *groundwater*.

***Giardia intestinalis*, *G. lamblia*** The pathogenic protozoon that causes *giardiasis*.

**giardiasis** A common cause of severe diarrhoea. The pathogenic organism is the protozoon *Giardia intestinalis* (previously known as *G. lamblia*). The hosts of the organism can be animals or man. The protozoa grow in profuse numbers in the intestines. The organisms form cysts which are 10 µm in size. They are excreted from infected humans or animals at up to 10<sup>7</sup> cysts per day. The transmission route is *faecal-oral* and it is commonly waterborne. The infective dose is extremely low, possibly only 10 cysts. Giardiasis can be treated by drugs although, in a few parts of the world, the organism is showing resistance to the drug treatment. The cysts are not killed during normal water *disinfection* although some removal occurs in sand filtration. If the cysts are present in the raw water then it is

a possibility that the cysts are present in the treated, disinfected water. Processes such as *microfiltration*, *nanofiltration* and *ultrafiltration* remove cysts from water. The *USEPA* states that treatment techniques to produce drinking water from surface waters (or groundwater under the direct influence of surface water) must remove/inactivate 99% *Giardia intestinalis* cysts.

**Gibraltar fever** *Brucellosis*.

**GIS** *Geographical information system*.

**gladioli** *Gladiolus* leaves indicate the presence of airborne fluorides at a very low percentage. At  $0.4 \mu\text{g}/\text{m}^3$  in the air the leaves turn yellowish brown.

**glasphalte, glassphalt** Asphalt road surfacing in which the sand, or part of it, has been replaced by crushed glass.

**glassfibre (USA: glassfiber) reinforced cement lining, g.r. plastic lining, reinforced plastic mortar (RPM) lining, reinforced thermosetting resin (RTR) lining** A method for the rehabilitation of sewers with the use of glassfibre reinforced cement or *glassfibre reinforced plastic*. The method uses pre-manufactured units in 2 or 3 pieces that can be bolted into place in the precleaned sewer. Large sewers can be rehabilitated using this method. The technique gives structural support to the existing sewer and stops leaks.

**glassfibre reinforced plastic, GRP** A material that is occasionally used for larger diameter water pipes and sewers. It consists of a mixture of glass-fibres and a thermosetting resin. It can be used for pipe rehabilitation linings. *See below*.

**glass recycling** Broken waste glass is known as cullet. It can be collected separately from the householder by a *separation at source scheme* or collected in *bottle banks* or at a *drop off centre* or be reclaimed in a *material recovery centre*. Before recycling into new glass, the glass cullet is sorted by colour. Glass cullet is melted with new raw material to make new glass bottles.

**GLC** Gas liquid chromatography *See gas chromatography*.

**globe valve** A *ball valve* (1).

**go-devil, pig, sewer pill** *See pig*.

**Gordona** *See foaming* (2).

**GPS** *Ground positioning system*.

**grab sample** For fluid, a single, rather than a *composite* sample. Solids also may be grab-sampled.

**gradient, grade** A slope. *See also hydraulic gradient*.

**grain size** *See particle size distribution*.

**grains per cubic foot** A unit sometimes used for measuring the amount of solids suspended in *smoke* or air: 7000 grains = 1 lb, or 15 432 grains = 1 kg, or 15.43 grains = 1 g, and  $1 \text{ m}^3 = 35.31 \text{ ft}^3$ . Consequently,

$$1 \text{ g}/\text{m}^3 = \frac{15.43}{35.31} = 0.437 \text{ grain}/\text{ft}^3$$

or

$$1 \text{ grain}/\text{ft}^3 = 2.28 \text{ g}/\text{m}^3$$

**Gram stain** An immensely practical staining technique that distinguishes groups of bacteria. A heat fixed smear of bacteria is stained with the dye crystal violet, and then with dilute iodine solution. Finally it is washed with alcohol or acetone. Bacteria that keep a deep blue stain are Gram positive. Those that finally lose colour are Gram negative (Christian Gram, 1884).

**granular activated carbon** *Activated carbon* coarser than 0.1 mm diameter (powdered carbon is finer). It has been used in *carbon adsorption beds* and has the very high surface area of 500 to 1400 m<sup>2</sup>/g. Some commercial active carbon grains are made as large as 1.6 mm.

**granular bed filter** *Granular media filter.*

**granular carbon filter** A *carbon adsorption bed.*

**granular gas filter** A fixed or moving mass of closely packed granules of chemical that can absorb a noxious gas. For *incinerators* the absorbent for sulphur dioxide may be alkalisied alumina. A preliminary *dust arrestor* should prevent blockage by fly ash. Compared with *wet scrubbers*, granular filters have the advantage that they do not pollute water.

**granular media filter, g. bed f.** Any filter that uses a granular material, e.g. filtering of a water or effluent through a bed of granular solid media as in a *rapid deep bed filter* and *slow sand filter.*

**graphitisation, graphitization** The corrosion of cast iron by a decay that leaves only a weak network of graphite flakes.

**grass plots** See *overland flow land treatment.*

**grate** (1) In an *incinerator* a grate supports the refuse and allows ash to fall through to the ashpit. See *moving grate incinerator.* (2) Or *grille* or *screen.* The parallel bars in the lower part of the casing of most *hammer mills*, through which the crushed refuse passes when it has been made small enough. The grate may be adjustable to increase or reduce the bar spacing, thus increasing or reducing the mill's throughput. For *primary shredding* the grate bar spacing is usually 6 to 12 cm, sometimes 20 cm.

**grate type incinerators** Waste is placed on metal grates in the *incinerator* that allow air circulation around and through the waste. See *moving grate incinerator.*

**gravel mounding** If gravel is used to support sand in a *rapid deep bed filter*, excessive backwash rates can lead to the support gravel rising up into the sand.

**gravel pack** Gravel placed around a water well in order to reduce particulate matter from entering the well.

**gravel vents** Gas vents that are constructed using coarse gravel. See *landfill gas vents.*

**gravimetric dust sampling** See *deposit gauge.*

**gravitational settling chamber** *Gravity settling chamber.*

**gravitational spray chamber** See *spray chamber.*

**gravitational water** (1) Soil water that moves downwards in the *saturated zone.* (2) *Irrigation* water in canals or rivers, which is not pumped.

**gravity belt thickening** A development of the *belt filter press* in which sludge conditioned with polymer is fed on to a moving belt that moves over

rollers. The sludge is furrowed by a series of plough blades placed along the travel of the belt. It then passes through a series of rollers where the sludge is further thickened up to 6 to 10% solids, depending on the type of sludge. After discharge of the thickened sludge, the belt passes through a washing zone.

**gravity current** A *density current*.

**gravity filter** A *filter* that is subject only to the *head of water* over it, and is always a downflow filter. Compare *pressure filter* (2).

**gravity main** A *main* through which the water flows because of difference in level, without the need for pumping.

**gravity sand filter** A downflow filter, either a *rapid gravity sand filter* or a *slow sand filter*.

**gravity separation** In the treatment of gaseous or liquid or solid wastes, gravity is the basis of settling. For air pollution control, gravity based processes include *air classification*, *gravity settling chambers*, etc. In water and wastewater treatment, gravity based processes include *clarification*, *sedimentation*, *gravity thickening*, etc.

**gravity settling chamber, gravity settler** A long *expansion chamber* that allows particles to settle from a gaseous effluent. It is mainly used for particles greater than 100  $\mu\text{m}$  and is very inefficient for particles less than 10  $\mu\text{m}$ . The efficiency can be increased by incorporation of a spray within the chamber (known as a gravity spray chamber) or by adding baffles that vary the direction of flow (see *Figure G.1*). See *baffle type scrubber*, *spray chamber*.

**gravity spray chamber** The incorporation of sprays within a *gravity settling chamber*, either to improve the removal of particulates or to remove a gaseous pollutant. See *spray chamber*.

**gravity thickening** The thickening of sludges by allowing the sludge to settle is common in the treatment of water and wastewater sludges. The thickening tank often has a stirrer which slowly rotates, helping the sludge to settle

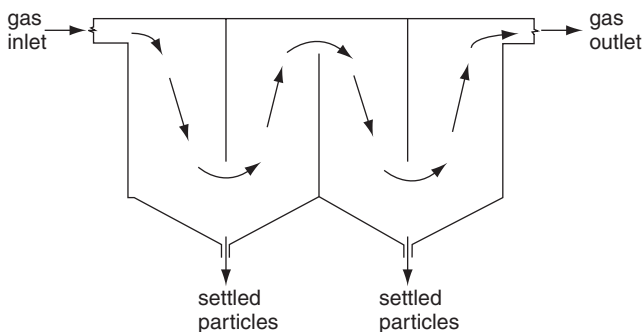

**Figure G.1** Gravity settling chamber. Combination of reduced velocity with changes of direction allows particles to settle out of the flue gas.

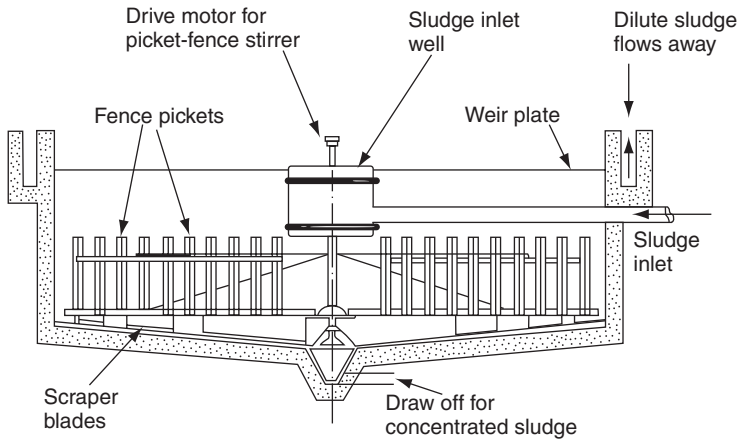

**Figure G.2** Gravity sludge thickening tank with picket fence stirrer.

and thicken (see Figure G.2). The supernatant from sludge thickening of wastewater sludge can be high in BOD and suspended solids. The design is based on **solids loading rate** and varies from 10 to 100 kg of dry solids/d per m<sup>2</sup> of tank, depending on the type of sludge. The thickened wastewater sludge may be 6 to 8% solids, although waste activated sludges are difficult to gravity thicken and may only be 3% solids after thickening. For waterworks sludges, the sludge is often conditioned with **polyelectrolytes** prior to thickening. The sludges can be thickened up to 3% solids at a solids loading rate of 10 kg m<sup>-2</sup>d<sup>-1</sup>. Gravity thickening tanks for water or wastewater sludges are typically 3 to 5 m deep and give a retention time of about 2 days. Therefore the tanks can also act as storage tanks. In warm climates, wastewater sludges may produce so much gas, due to anaerobic biodegradation, that thickening by gravity is prevented.

**Gray, Gy** The SI unit for the amount of energy radiation absorbed by a material, i.e. the absorbed dose. One Gray is the 1 joule of radiation energy absorbed by 1 kg of matter.

**grazing fauna, g. organisms** Insects and their larvae, **nematodes** and oligochaetes, and **rotifera** which graze on the **biofilm** in a **trickling filter**. They restrict excessive growth of the film and reduce **ponding**. See **sloughing off**.

**greases and fats** Domestic wastewater contains between 50 to 150 mg/l of grease, although the grease and fat content of wastewater from commercial kitchens can be much higher. A variety of industrial effluents may have a high grease and fat content, such as meat processing wastes. High levels of grease and fat can adversely affect biological wastewater treatment and be a nuisance throughout a sewerage system and wastewater treatment works. See **hexane extractable material**.

**grease trap** A small **skimming** tank with a retention time of 10 to 30 min, large enough to hold and cool the grease delivered in one day from any **sullage**

- source, and installed near it. It should be regularly emptied. The inlet is below the surface and the outlet is at the bottom, separated from the inlet by a baffle that holds back the grease.
- green algae, Chlorophyta** A large *phylum* of algae that includes *Chlorella*, *Chlamydomonas* and *Urva*. They may have *flagella*, and can be unicellular, multicellular or *filamentous organisms*.
- greenfield site** A site that is used for new development that has not previously been built on.
- greenhouse effect** The fact that the heat from the sun enters a greenhouse more easily than it can leave it. On the atmosphere as a whole, water vapour acts similarly, because clouds can blanket the earth at night, preventing frost. Carbon dioxide, CO<sub>2</sub>, has a greenhouse effect and as the CO<sub>2</sub> level in the air rises the earth will warm by the greenhouse effect. Other gases that have a greenhouse effect include methane, *chlorofluorocarbons* (CFCs) and ozone.
- greenhouse gases** Gases that exert a greenhouse effect. *See above*.
- green list waste** Waste that is considered to be safe under the EU *Waste Shipment Regulations 1994* and therefore does not require notification and consent for transfrontier shipment for recovery.
- greensand, glauconite** A natural *ion exchange* material that can be used for iron and manganese removal.
- green waste** *Garden waste* from domestic households together with clippings, prunings, etc. from local authority parks and gardens and commercial landscaped gardens. In developed countries, garden waste accounts for about 3 to 20% of the domestic waste. The variability of this percentage reflects the extent to which property with gardens are part of the housing stock and also the extent of re-use of the garden waste in household garden composts.
- grey list substances** *List 2 substances*.
- grey water** *Sullage*.
- grit** In air pollution, particles larger than 75 µm. In wastewater, grit includes sand, gravel, ashes, metal, glass, earth from vegetable washing, etc. It settles more easily than the *organic* solids in wastewater and usually increases in amount after rain. In desert areas the grit content in wastewater may be high, because of wind-blown sand. In cold climates gritting of roads in icy weather increases the grit content of *stormwater*. The volume of grit removed from domestic wastewater is normally 15 to 30 cm<sup>3</sup> per person per day.
- grit chamber** The general name for any grit removal device. *See grit removal*.
- grit channel** A long narrow tank that extracts grit from wastewater, as in the *constant velocity grit channel* or *aerated grit channel*.
- grit removal** In wastewater treatment, grit removal tanks are designed to maintain a horizontal velocity of 0.3 m/s so that the grit settles out of the wastewater but the organics continue in the wastewater flow. A variety of different design are used, such as *aerated grit channel* (Figure A.3), *constant velocity grit channel* (Figure C.8), *Detritor*, *horizontal flow grit chamber*, *vortex grit separator* (Figure V.5).
- grit washer** *See classifier*.

**grizzly** A bar *screen* used in *mineral dressing* and usually made from rails, with at least 10 cm gap between them. The bars are sloped to enable the material to slide down them.

**gross heating value** *See calorific value.*

**ground level pollution** The weight of a pollutant (usually in  $\mu\text{g}$ ) per unit volume ( $\text{m}^3$ ) in the air between the ground and 1.5 or 2 m above it.

**ground positioning system, GPS** The use of satellites to fix the exact position. The system can be accurate to less than 1 m in the horizontal directions but it may be less accurate in the vertical direction.

**groundwater** Water contained in the soil or rocks below the *water table*—i.e. in the *zone of saturation*. It is the immediate source of well water. If too much is drawn off the water table (*piezometric surface*) is lowered.

**Ground Water Directive 1980** The EU Directive that sets the management of groundwaters to protect them from the discharge of substances listed under the EU Dangerous Substances Directive 1976.

**Groundwater Regulations 1998** The UK legislation that completes the implementation of the *Ground Water Directive 1980*.

**groundwood pulp, mechanical p.** Wood pulp for making newsprint, obtained by the crushing of wood.

**grout curtain** The injection of material into a rock formation in order to generate a vertical barrier of low permeability and thereby reduce or stop horizontal groundwater flow, for example into a landfill site. The injected material for the ground curtain may be a cement or a pozzalanic material. *See also cut off wall.*

**growth phases of microbes** The main growth phases in the population dynamics of microbes are: *lag phase*, *logarithmic growth phase*, *declining growth phase*, *stationary growth phase* and *endogenous phase of growth*, all of which are seen in a *microbial growth curve* (*see Figure M.1*).

**GRP** *Glassfibre reinforced plastic.*

**guided auger boring** *See auger boring.*

**guided thrustboring, g. moling** *See thrustboring.*

**Guinea worm, *Dracunculus medinensis*** A nematode worm that lies beneath the skin and causes *dracontiasis*.

**gully, street inlet, gutter inlet** A grated opening at the edge of a street, for *road drainage*.

**gully tanker** A *vacuum vehicle*.

**gunite** Sprayed concrete with an aggregate size less than 10 mm.

**gunite lining** A method for the rehabilitation of sewers using *gunite*. The gunite can be sprayed directly onto the precleaned sewer or pipe. The wet method uses a mixture of cement, aggregate and water which is then pumped to the spray nozzle where air is injected to propel the mixture onto the required surface. The dry method uses a dry mixture of cement and aggregate which is then pumped in an air stream to the spray nozzle where water is injected to the mix and the gunite is propelled onto the surface. An alternative method is to use pre-cast units that can be formed by spraying gunite onto moulds supporting mesh reinforcement. The units

are then grouted into place in the precleaned sewer. A wide range of sewers sizes are rehabilitated using this method. *See ferrocement lining.*

**gutter** The pipe system for removing stormwater that runs off the side of roofs. The gutters should be able to take the flow from a storm with a rainfall intensity of 75 mm/h.

**gutter inlet** A *gully* inlet.

**Gy** *Gray*.

**gypsum** Calcium sulphate. It is used in plasterboard.

**Gyractor** A *pellet reactor*.





---

**HAA** *Haloacetic acids.*

**HAAs** Hormonally Active Agents. These are chemicals that affect the hormone system in humans. They are part of the group of chemicals that are *endocrine disrupters*.

**habitat** The natural environment or location of a plant or animal.

**haem-, haemat-, haemo-** Associated with or in blood.

**half life** In a *radio-isotope*, the time taken for half of its atoms to disintegrate to form another *isotope*. A pollutant, though not radioactive, also may have a half life.

**haloacetic acids** A range of chemicals that have between one to three halogen atoms, e.g. chlorine or bromine, substituted into the methyl group ( $-\text{CH}_3$ ) of acetic acid ( $\text{CH}_3\text{COOH}$ ). They are used in industry for a range of purposes. They may also be *disinfection by-products*, produced during *chlorination* of water. They are probably carcinogenic to humans. The *USEPA MCL* in drinking water from 2002 for the total of five haloacetic acids is 0.06 mg/l. The five are mono-, di- and trichloroacetic acid and mono and di bromoacetic acid. The WHO provisional guideline maximum value for drinking water is 50  $\mu\text{g/l}$  for dichloroacetic acid and 100  $\mu\text{g/l}$  for trichloroacetic acid.

**halocarbons** Chemicals that contain halogen and carbon atoms, such as *chlorofluorocarbons* (CFCs), *hydrochlorofluorocarbons* (HCFCs), *hydrofluorocarbons* (HFCs), *perfluorocarbons* and *trihalomethanes* (THMs).

**halocline** The dividing line between fresh and underlying salt water.

**halomethanes, haloforms** Compounds in which the halogen replaces one or more of the hydrogen atoms in methane,  $\text{CH}_4$ , e.g. chloroform (trichloromethane)  $\text{CHCl}_3$ ; bromoform (tribromomethane)  $\text{CHBr}_3$ ; *carbon tetrachloride*  $\text{CCl}_4$ . Freons (*see chlorofluorocarbons*) are also halomethanes. *See trihalomethanes.*

**halogens** *Chlorine, bromine, fluorine and iodine.*

**halophile** Micro-organisms that can live in water with very high salt concentrations.

**hammer mill** A common type of *pulveriser* for the dry pulverising of refuse or other waste. Many types exist, with or without a *grate*, with single or double rotors, with a horizontal or vertical shaft, having swing hammers or rigid ones, apart from distinctions of size or output (*Figure H.1*). The hammers can weigh over 50 kg and need regular attention so that the inevitable wear can be taken up. The rotors turn at 900 to 3000 rev/min

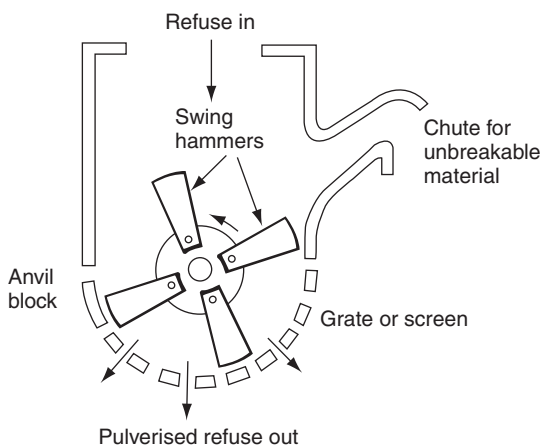

**Figure H.1** Hammer mill, diagrammatic section.

and the tip speed is 30 to 70 m/s. The power installed should be not less than 8 kW per tonne of hourly throughput, preferably 16 kW, to enable the motor to cope with the surges of power demand caused by massive objects entering the mill. See *ballistic separator, shredding*.

**hand pumps** A hand pump placed at the surface can be used for shallow wells down to 8 m. For *deep wells*, the pump has to be immersed in the well. The installation must ensure that the pump in a deep well can be removed for maintenance. See *shaduf, tube well, well pollution*.

**HAP Hazardous air pollutants.**

**hard COD** The *COD* remaining after effective biological treatment. It is a measure of the organic material that is non-biodegradable or only very slowly biodegradable.

**hard detergent** A *synthetic detergent* that does not easily biodegrade and so may cause *foaming* in rivers at concentrations as low as 0.3 mg/l. Modern soft detergents are *biodegradable* in biological treatment, and so have greatly reduced foaming problems in rivers.

**hardness** The hardness of water is the extent to which it prevents soap lathering. It is caused usually by *calcium* or *magnesium* salts, occasionally also by those of iron or aluminium, which react with soap to form the typical scum seen around baths or washbasins. *Carbonate hardness* also causes the *scale* that is precipitated when water is boiled and the bicarbonates of calcium and magnesium are converted to insoluble carbonates. Hardness is therefore a nuisance both to homes and to industries. It may be expressed in mg/l or in *milligram equivalents* of *calcium carbonate*,  $\text{CaCO}_3$ , per litre of water, even though salts of metals other than calcium may be causing the hardness. In the UK 'soft' water has less than 50 mg/l of  $\text{CaCO}_3$ ; 'hard' water has more than 150 mg/l. In soft water *heavy metals* may be dissolved from pipes, e.g. plumbo-solvency. In several countries it

has been found that soft water may be associated with heart disease. See also *alkalinity, degree of hardness, non-carbonate hardness, water softening*.

**Hardy Cross method** A method of successive approximations developed by Professor Hardy Cross (1936), which can be applied to many complex networks, including pipe flows, bending moments in building frames, etc.

**harvesting of algae** See *algal harvesting*.

**haul speed** The average speed for a vehicle, e.g. solid waste collection vehicles, between the point of departure and point of arrival. The haul speed is the haul distance (length of haul) divided by the time taken for the journey.

**HAV Hepatitis A** virus.

**hazard codes** The USA *DOT* (Department of Transport) and the UN have developed similar hazard codes that are used in the transportation of hazardous chemicals or wastes. The USA DOT also classify poisons as Class A (highly toxic) or Class B (less toxic but still a serious human health hazard) during transportation of the poisonous chemical. For the EU, see *Hazardous Waste Directive, 1991*. The EU has a system of *risk and safety phrases* for denoting the hazard of chemicals or wastes. See *Table H.1*.

**hazardous air pollutants, HAPs** Air pollutants that are toxic (also known as air toxics). Examples of HAPs include asbestos and benzene. HAPs may cause a variety of diseases depending on the substance. The USEPA publishes a list of nearly 200 chemicals that it regards as air toxics.

**Hazardous and Solid Waste Amendments, HSWA 1984** The Hazardous and Solid Waste Amendments were passed by US Congress to increase the

**Table H.1** Hazard Codes for the USA DOT, the UN and the EU

	<i>US DOT</i>	<i>UN</i>	<i>EU</i>
explosive	1	1	H1
flammable gas	2.1	2	H3-A
non flammable gas	2.2	2	–
poisonous/toxic gas	2.3	2	H6
flammable liquid flash point < 18 °C	3	3.1	H3-A
flammable liquid flash point 18 to 21 °C	3	3.2	H3-A
flammable liquid flash point 21 to 23 °C	3	3.2	H3-B
flammable liquid flash point 23 to 55 °C	3	3.3	H3-B
flammable liquid flash point 55 to 61 °C	3	3.3	–
flammable solid	4.1	4.1	H3-A
spontaneously combustible	4.2	–	H3-A
dangerous when wet	4.3	–	H12
oxidiser	5.1	5.1	H2
organic peroxide	5.2	5.2	–
poison/toxic	6.1	6.1	H6
infectious material	6.2	–	H9
radioactive	7	7	–
corrosive	8	8	H8
miscellaneous	9	9	–
non-regulated	–	NR	–

The EU also has H4: irritant; H5: harmful; H7: carcinogenic; H10: teratogenic; H11: mutagenic; H13: substances that yield a hazardous component after disposal; H14: ecotoxic.

scope of *RCRA*. Waste minimisation became the preferred method for managing hazardous waste. Untreated hazardous waste was banned from land disposal and new higher standards for *landfill liners* were established.

**Hazard Ranking System, HRS** A method used in the *USA* to estimate risk to human health and the environment from an abandoned waste disposal facility. HRS is used to formulate the National Priorities List that is a part of *SARA*.

**hazardous waste** Waste that is a dangerous because it is toxic or inflammable or explosive etc. See *characteristic wastes, controlled waste, listed wastes, special waste*.

**Hazardous Waste Directive 1991** This Directive defines the management of hazardous waste in the EU. It requires Member States to quantify and record their production, collection, transportation, recovery and disposal. The Directive has a long list of definitions of the term hazardous waste, according to their constituents (e.g. C16 is mercury and its compounds; C40 is halogenated solvents) and hazardous properties (see *Table H.1*).

**hazardous waste incinerator** Hazardous waste can be successfully incinerated using a *liquid injection incinerator* or a *rotary kiln incinerator*. An alternative is a *plasma arc incinerator*. See *destruction and removal efficiency*.

**hazardous waste treatment** See *above, encapsulation, stabilisation, physical chemical treatment of hazardous waste*.

**haze** A faint mist, slightly reducing the clarity of the air, caused by *airborne* dust or liquid particles about 0.2 to 1µm in size.

**Hazen unit** A number that defines the brown colour in water, now known as the *platinum cobalt scale*.

**Hazen-Williams formula** A formula used in evaluating *pipe flow* in water distribution systems:

$$V = 0.849 C R^{0.63} S^{0.54}$$

where *V* = velocity (m/s), *R* = *hydraulic mean radius* (m), *S* = *hydraulic gradient* and *C* is Hazen-Williams roughness coefficient.

**HCFCs** *Hydrochlorofluorocarbons*.

**HCH** *Hexachlorocyclohexane*.

**HDPE** *High density polyethylene*.

**head loss, pressure loss** Reduction in *head of water* in a flowing pipe or channel, usually because of the friction of flow or change in a direction of flow. The higher the speed of flow, the higher is the head loss.

**head of water, pressure of w.** The energy in water that enables it to do mechanical work. The total head is the sum of three components: (1) elevation head—for example, the height above sea level; (2) pressure head, measured by a *piezometer tube*, is the height of the static column of water that can be carried by the pressure at that point; (3) velocity head, the energy in water due to its movement (its kinetic energy) is equal to  $V^2/2g$ , where *V* is the mean velocity of the water and *g* is the acceleration due to gravity. This kinetic energy is measured by a *Pitot tube* with the opening facing upstream.

**headwaters** The upper parts of a river system or the waters upstream of a reservoir or lake.

**HEAF** *High efficiency air filters.*

**Health and Safety Executive, HSE** The organisation that regulates occupational health and safety in the UK.

**hearth type incinerators** A range of *incinerators* having a solid hearth (as opposed to a grate) on which the material is burnt. Examples include *multiple hearth incinerator, rotary kiln incinerator.* See also *waste to energy plants.*

**heat drying of sludge** Heat can be used to dry wastewater sludge from 25 to 30% solids or even less. Drying is important prior to incineration of wastewater sludge, otherwise an external fuel source has to be added into the incinerator. A range of designs have been used including *band dryer, Carver-Greenfield process, flash drying, fluidised bed dryer, multiple hearth dryer, rotary dryer, spray dryer.*

**heat islands** Areas of land that absorb heat during the day and become warmer than the surrounding area. Winds may be generated by the rising air over the heat island.

**heat recovery** Heat can be recovered from waste incinerators typically by the use of boilers to generate steam. The steam may then be used for electric power generation or for district heating systems. The equipment required for effective heat recovery can be expensive. See below and *waste to energy plants.*

**heat recovery wheel, thermal w.** A large wheel that slowly turns through hot outgoing air while its other half is turning through cool incoming air. In this way much of the heat from the outgoing air is transferred to the incoming air, as in the *rotary regenerative air heater.*

**heat treatment of sludge** The heating of wastewater sludge in order to improve its dewaterability as in *wet air oxidation.* See also *thermal treatment of sludge.*

**heavy medium cyclone** A *dense medium cyclone.*

**heavy medium separation** *Dense medium treatment.*

**heavy metals** A group of metals that includes *cadmium, chromium, copper, lead, mercury, nickel, selenium* and *zinc.* They are used in industry and are generally toxic. The name is misleading as the truly dense metals with a relative density around 20 include gold and platinum.

**heavy water** Deuterium oxide, D<sub>2</sub>O; but see also *tritium oxide.*

***Helicobacter pylori*** A bacterium that lives in the stomach and is a common cause of peptic ulcers.

**helminthic diseases** Diseases caused by *tapeworms, trematodes* (flukes) or *nematode* worms. Flukes cause *schistosomiasis* and *schistosome dermatitis.* Nematodes cause *ascariasis, dracontiasis, hookworm disease, onchocerciasis, pinworm* and *trichuriasis* diseases. Probably half the world's population are affected by a helminthic *parasite.*

**helminths** The tapeworms, trematodes (flukes) or nematodes.

**Helsinki Declaration** A declaration agreed in 1989 which requires the phasing out of production and consumption of ozone depleting *chlorofluorocarbons* (CFCs) by 2000. Other chemicals that deplete the ozone layer must also be phased out. 80 countries have agreed the Helsinki Declaration. See *ozone depletion potential.*

**Helsinki Protocol** An agreement passed in 1983 that commits the signatories to the reduction of sulphur dioxide emissions to the atmosphere. The UK is not a signatory to this protocol.

**hem-, hemat-, hemo-** Associated with or in blood.

**hematopoietic agent** A chemical that interferes with the oxygen carrying capacity of the blood, such a *carbon monoxide*.

**hemi-celluloses** Soluble *carbohydrates*, often found with *cellulose*, e.g. in wood. Being soluble, they dissolve in the water used to make paper from wood pulp and often reach half the organic content of the effluent from a pulp mill. Hemi-celluloses can be partially fermented to alcohol.

**Hemiptera** *Water bugs*.

**HEMs** *Hexane extractable material*.

**Henry's Law** When a gas or vapour comes into contact with water, the concentration of a specific chemical in water, that dissolves from the gas into the water, is directly proportional to the concentration of that chemical in the gas.

**HEPA** *High efficiency particle arresting*. See *high efficiency air filters*.

**hepatitis A, infectious hepatitis** A viral disease producing a sudden onset of fever, malaise, nausea and abdominal pain followed a few days later by jaundice. Transmission is through food and water contaminated from infected faeces, urine or blood. The most effective prevention is good food hygiene and adequate water disinfection.

**hepatotoxin** A toxic substance that causes liver damage.

**heptachlor, heptachlor epoxide** Two *cyclodiene* insecticides with very similar chemical formulae. They are carcinogenic to humans. They can undergo *biomagnification* in food chains. The allowable concentration in drinking water is extremely low, with the *USEPA MCL* at 0.4 µg/l for heptachlor and 0.2 µg/l for heptachlor epoxide. The WHO guideline maximum value is 0.03 µg/l for drinking water for each chemical. The EU Drinking Water Directive has the same standard as the WHO.

**herbicide** A chemical, especially any selective weedkiller, that kills vegetation.

**herbivore** A plant eater.

**hetero-aerobic lagoon** A *faculative waste stabilisation pond*.

**heterotroph, heterotrophic organism** Any organism, including bacteria and *fungi*, that needs organic matter as an energy source, unlike *autotrophs*, which do not. Heterotrophic bacteria in wastewater treatment biodegrade the organic pollutants and thus help the process.

**heterotrophic plate count, HPC** A *plate count* of *heterotrophic* aerobes and *faculative* anaerobic bacteria. The *USEPA* states that treatment techniques for surface waters (or groundwater under the direct influence of surface water) must produce drinking water with a maximum of HPC of 500 colonies per 500 ml.

**heuristic** Rule of thumb or trial and error.

**hexachlorobenzene** A *chlorinated benzene* that was used as a pesticide. In humans it can affect the liver and kidneys. The *USEPA* sets a *MCL* of 1 µg/l in drinking water which is also the corresponding WHO guideline maximum value. The EU Drinking Water Directive states a mandatory

maximum of 0.1 µg/l. The EU lists it as a *priority hazardous substance* in relation to aquatic discharges.

**hexachlorobutadiene, perchlorobutadiene** A chemical used mainly to make rubber compounds. It is also used as a solvent. It is a possible human carcinogen. The EU lists it as a *priority hazardous substance* in relation to aquatic discharges.

**hexachlorocyclohexane, Lindane, benzene hexachloride,  $\gamma$ HCH** An insecticide that is toxic to humans affecting the human nervous system, liver and kidneys. It can undergo *biomagnification* in food chains. The *USEPA MCL* in drinking water is 0.2 µg/l and the WHO guideline maximum value is 2 µg/l. The EU Drinking Water Directive states a mandatory maximum of 0.1 µg/l. The EU lists it as a *priority hazardous substance* in relation to aquatic discharges.

**hexametaphosphate** *See sodium hexametaphosphate.*

**hexavalent chromium, hexachrome Chromium** in the form of chromate,  $-\text{CrO}_4$ , and dichromate,  $-\text{Cr}_2\text{O}_7$ , is more toxic to plant and animal life than trivalent chromium (chromium as the cation). *Metal plating wastewater* containing it should be treated by chemical reduction to trivalent chromium in acid conditions. The pH is then raised to precipitate out chromium hydroxide. Alternatively, hexavalent chromium can be removed by *ion exchange*. *See Table D.2 Drinking water standards.*

**hexane extractable material, HEMs** The analysis of oil, grease and fat content in water, wastewater, sludge, soils, etc. involves extracting the oil, grease and fat in the solvent hexane. The sample is acidified and extracted three times with hexane. The hexane is then evaporated to leave the residue, which can be weighed.

**high chimney policy Tall stack policy.**

**high density baling, high pressure b.** *See baling.*

**high density polyethylene, h. d. polythene, HDPE** A *thermoplastic* plastic used extensively since the 1970s. It has a density of 0.955 g/cc, which is greater than medium or low density polyethylene. It is light and flexible and it can suffer some surface damage without rupturing and affecting performance. It is resistant to corrosion and easy to weld together into long lengths. It is used for water pipes or *landfill liners*. It is also present in municipal waste because HDPE is used for bottles for household chemicals. It is also used as sewers or in the rehabilitation of sewers.

**high efficiency air filters, HEAF** Highly efficient *depth filters* used for cleaning air for industrial clean rooms.

**high efficiency cyclone Cyclone** types of *dust arrestor* that can reliably remove particles as small as 4 µm, though with a high pressure drop, up to 10 cm water gauge.

**high efficiency particle arresting.** *See high efficiency air filters.*

**high level radioactive waste** Radioactive waste with activities greater than 0.2 curies per litre (one curie equals  $3.7 \times 10^{10}$  becquerel). The waste is derived from reprocessing the spent fuel. It is highly dangerous and is put in a repository where it is stored for more than 1000 years.

**high line jumpers** Pipes or hoses, connected to fire hydrants, used to provide emergency water service for a portion of a water distribution system.

**high performance compact reactor** A *tower reactor* (1).

**high performance liquid chromatography** *HPLC*.

**high purity oxygen activated sludge** See *oxygen activated sludge*.

**high rate activated sludge process** The operation of *activated sludge* plants at *organic loads* above 1 kg of BOD<sub>5</sub> per kg of *mixed liquor* solids per day. High loadings in activated sludge plants may result in *bulking*.

**high rate aerobic pond or lagoon** A shallow (0.3 to 0.5 m) *waste stabilisation pond*, in which the light can reach the bottom, enabling algae to grow fast. It is used to treat wastewater from *anaerobic ponds*, and retention times of only 2 to 6 days are needed. The main problem is separating the algae from the effluent flowing out of the lagoon. It usually has no *surface aerators*.

**high rate anaerobic sludge digestion** See *anaerobic sludge digestion*.

**high rate irrigation** See *rapid infiltration land treatment*.

**high rate stabilisation pond** Either an *anaerobic waste stabilisation pond* or a *high rate aerobic stabilisation pond*.

**high rate trickling filter, roughing filter** (1) A *trickling filter* with both a high *hydraulic loading* (1 to 4 m<sup>3</sup>/day per m<sup>3</sup> of filter) and a high *organic loading* (1 to 5 kg BOD<sub>5</sub> per day per m<sup>3</sup> of filter); often built as a tower containing *plastic media filter*, with the wastewater distributed at the top of the tower. The tower is sometimes known as a biotower. A minimum *wetting rate* of 30 m<sup>3</sup>/day per m<sup>2</sup> of filter plan area is normally needed, and effluent must be re-circulated if necessary to maintain this flow. The tower is followed by a *humus tank*. *Ponding* of the filter is avoided because of the large spaces in the plastics media. Typical BOD removals are 45% at an organic loading of 4 kg BOD<sub>5</sub> per day per m<sup>3</sup> of filter, varying up to 85% at 1 kg BOD<sub>5</sub> per day per m<sup>3</sup> of filter. It is used as a roughing treatment for industrial effluents of high BOD before discharge to the *sewer* or before further biological treatment. See *activated biofilter*, *extended filtration*. (2) A conventional, shallow (1 to 2 m deep) trickling filter packed with stone, in which effluent is re-cycled from the *humus tanks*. A high wetting rate of 10 to 30 m<sup>3</sup> per m<sup>2</sup> of trickling filter per day helps to slough off the slime and stop ponding. BOD loadings up to 2 kg of BOD<sub>5</sub> per m<sup>3</sup> of filter per day may be achieved without ponding.

**high volume air sampler** A sampler in which particulate matter is collected on a pre-weighed glassfibre filter paper. The sampler is designed to exclude particles larger than 10 µm.

**hindered settling** See *settling regimes*.

**HMIP** Her Majesty's Inspectorate of Pollution, now part of the *Environment Agency of England and Wales*.

**Hoechst Bio-Hoch tower** A type of *tower reactor* (1).

**hog, hogger** A *mill* or *shredding* machine.

**hog louse** *Asellus aquaticus*.

**holophyte** An organism that makes carbohydrates in *photosynthesis*.

**holoplankton** Organisms that spend their whole lives as *plankton*, unlike *meroplankton*.



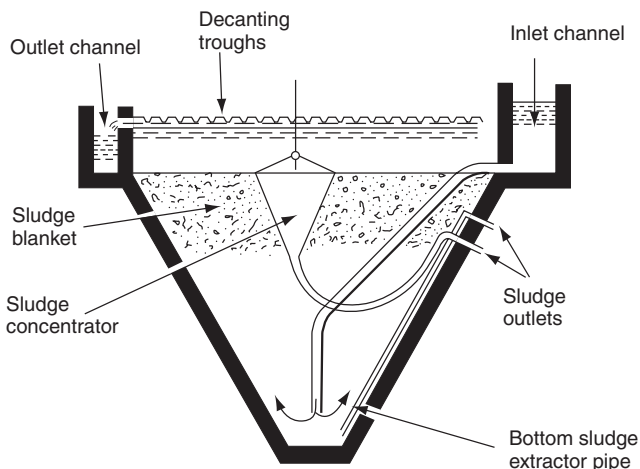

Figure H.2 Hopper bottom clarifier.

**holozoic organisms** Organisms that prey on others, whether plant or animal, and thereby affect their population. *Compare saprobe.*

**home grinder** A *garbage grinder*.

**homeiostasis, homeostasis** The maintenance of an *ecosystem* against external stress.

**homoiotherm, homeotherm, idiotherm** Warm blooded birds and animals.

*Compare poikilotherm.*

**hookworm** A *nematode* with hooks in its mouth, which is a *parasite* in man.

**hookworm disease, miner's anaemia, ancylostomiasis, ankylostomiasis, necatoriasis** A *waterborne disease* caused by parasitic *nematode* worms such as *Ancylostoma duodenale* or *A. ceylanicum* or *Necator americanus*. The infection is known either as ankylostomiasis or necatoriasis, depending on the worm present in the human. The worms enter the body through the skin of bare feet and attach themselves with the hooks in the mouth to the sufferer's duodenum. The worms are passed in the faeces of the sufferer. The disease is widespread in tropical and subtropical regions. It can be reduced by good sanitation.

**hopper bottom clarifier, hopper type c.** A simple *sludge blanket clarifier* with the inlet near the bottom of the sludge hopper. The coagulated water flows up through the sludge blanket (Figure H.2). The *surface loading rate* is 40 to 100 m<sup>3</sup>/d per m<sup>2</sup> of tank surface area, depending on the quality of the inlet water.

**horizontal flow grit chamber** Tanks that are designed to maintain a horizontal velocity of 0.3 m/s so that the grit settles out of the wastewater but the organics continue in the wastewater flow. Tanks may be rectangular or square as in the *Detritor*.

**horizontal flow sand filter** A sand filter in which the flow is radial (Simater filter) or from one side to the other (Bohna filter).

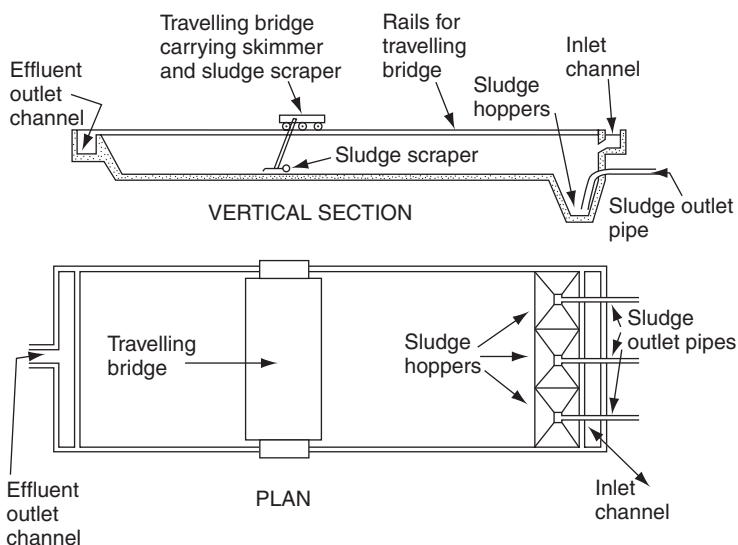

**Figure H.3** Horizontal flow sedimentation tank.

**horizontal flow sedimentation tank, rectangular s.t. *Sedimentation tanks*** (Figure H.3) in which the wastewater flows in at one end and out at the other. The sludge is usually scraped to *sludge hoppers* at the inlet end of the tank and is removed once or twice daily. The length/breadth ratio is normally about 4/1 and the greatest length is not usually above 100 m. The depth is from 2.5 to 3.0 m and the floor slopes down towards the inlet end at about 1:100, for large tanks, down to 1:10 for small tanks. The tanks are used for *primary sedimentation* of wastewater or for *de-silting* raw water. In the UK *travelling bridge scrapers* are common but in the USA *flight scrapers* are more common.

**horizontal shaft aerator** A *brush aerator*.

**horizontal shaft hammer mill** The oldest type of *hammer mill*, in existence at least since 1875. It has a screen of perforated steel plate or parallel steel bars below it, known as the *grate*. The shaft carries swing hammers whose maximum swing diameter is called the tip circle. The difference between the tip circle and the internal diameter of the casing partly decides the maximum size of the output from the mill, but the spacing of the grate bars also is important.

**hormone disrupter** See *endocrine disrupter*.

**hospital waste** See *clinical waste*.

**host** An organism that is lived on by a *parasite* e.g. humans can be hosts to parasitic worms (see *helminthic diseases*).

**hot side precipitator** An *electrostatic precipitator* that is used to remove particulates from a gas stream with temperatures of about 400 °C.

**house dust mite** The house dust mite is more prolific in houses with high relative humidity. It feeds on human skin. The mites and particularly their faeces are allergens and can be a common cause of allergic asthma.

**household waste** *Domestic waste.*

**HPC** *Heterotrophic plate count.*

**HpCDD** Heptachlorodibenzo-*p*-dioxin. *See dioxin.*

**HpCDF** Heptachlorodibenzofuran. *See dibenzofuran.*

**HPLC high performance liquid chromatography** A common analytical technique that can be used to measure the concentration of a wide range of pollutants in the environment. A small quantity of sample is injected into an inert mobile phase which is being pumped at high pressure (e.g. 8 atmospheres) into and through a packed column (10 to 50 cm long and 4 to 6 mm wide). The column contains particles of less than 10 µm tightly packed into the narrow tube of steel or glass or plastic. The packing material is chosen so that the components of the sample being investigated move through the column at different speeds which are detected and recorded at the outlet at different times. The retention time of the compound in the column for a given set of HPLC operating conditions is related to standard chromatograms that have been obtained for that instrument and thereby identifies the compounds in the sample. The peak height or area on the *chromatogram* is a quantitative measure. HPLC can be coupled with a mass spectrometer (known as LC-MS). The chromatographic equipment separates the constituent compounds of the sample which are then analysed for their mass spectra. *See mass spectrometry.*

**HRS** *See Hazard Ranking System.*

**HRT** *Hydraulic retention time.*

**HR** Wallingford tables *See Wallingford tables.*

**HSE** The UK *Health and Safety Executive.*

**HSWA** *Hazardous and Solid Waste Amendments.*

**humic substances** The organic part of soil formed from the biodegradation of animals, plants and other vegetable matter. They can cause water to have a yellowish-brown colour. Peat is mainly composed of humic substances.

**humidity** Excess humidity is a common problem in modern buildings due to the lack of ventilation. Modern buildings have airtight windows, fewer open fires and more flueless heating systems or boilers not drawing the air from the interior. Dishwashers and dryers not ventilated to outside also add to the humidity. *See condensation, indoor air pollution, relative humidity.*

**humus sludge** *Biofilm* that has sloughed off a *trickling filter* and settled out in the *humus tank*. *See above.*

**humus tank** A *sedimentation tank* that follows after *trickling filters*. The tank is used to settle out the *biomass* that has sloughed off the trickling filter from the treated effluent. The settled biomass is known as *humus sludge*.

**HxCDD** Hexachlorodibenzo-*p*-dioxin. *See dioxin.*

**HxCDF** Hexachlorodibenzofuran. *See dibenzofuran.*

**hydrated lime** Calcium hydroxide, Ca(OH)<sub>2</sub>.

**hydraulic conductivity, permeability coefficient, K** A measure of the ability to transfer water through a soil or aquifer or other material such as a *geomembrane* under a given hydraulic gradient. It is the water flow (m<sup>3</sup>/s) per unit cross-section (m<sup>2</sup>) of the soil. Permeable soils have a hydraulic

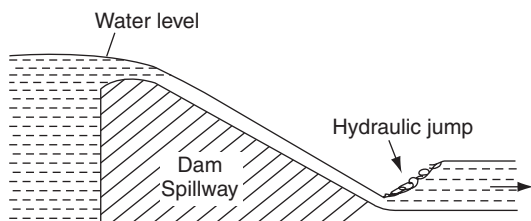

Figure H.4 Hydraulic Jump.

conductivity of  $10^{-4}$  to  $10^{-5}$  m/s compared to a clay at  $10^{-8}$  to  $10^{-10}$  m/s. See *Darcy's law, Landfill liners*.

**hydraulic gradient h, grade line** For fluid flow through a *pressure pipe*, a line drawn to show the levels to which the fluid would rise in open tubes connected to the pipeline—i.e. the *piezometric surface*. In *open channel flow* the hydraulic gradient coincides with the water surface. See *Figure P.5*.

**hydraulic jump, standing wave** In *open channel flow*, the change from *supercritical flow* to *subcritical flow*—i.e. a sudden increase in depth from less than to greater than the *critical depth*. See *Figure H.4, standing wave flume*.

**hydraulic loading** (1) The flow rate per day through a treatment tank or filter, per  $\text{m}^3$  of capacity of the unit. (2) *Wetting rate*. (3) *Surface loading rate*.

**hydraulic mean depth, h, radius** The cross section of the water in a channel, stream, etc., divided by its *wetted perimeter*. For a pipe flowing full the hydraulic mean depth is one quarter of the diameter.

**hydraulic retention time, h, residence t., h, detention t.** See *retention time*.

**hydraulics** The study for practical purposes of fluid flows and pressures, including the forces exerted by and on water in motion.

**hydraulic yield** The *yield of a water source*.

**hydrazine**  $\text{N}_2\text{H}_4$  A chemical added to boiler *feed water* to deaerate it and thus to reduce the hazard of boiler corrosion. It decomposes in the boiler to form nitrogen and water.

**hydro-, hydr-** A prefix indicating a connection with water.

**Hydrobaenus** A genus of *Diptera* midges that are common *grazing fauna* in *trickling filters*. See *filter fly*.

**hydrocarbons** Molecules that contain hydrogen and carbon, such as the main component of petrol (gasoline), octane. Some hydrocarbons are toxic, such as benzene or some of the *polycyclic aromatic hydrocarbons*.

**hydrochlorofluorocarbons, HCFCs** Chemicals that contain hydrogen, chlorine, fluorine and carbon atoms. They have a wide range of industrial uses and have been used as replacements for *chlorofluorocarbons* (CFCs). Examples include the refrigerant HCFC-22, which is  $\text{CHClF}_2$  and the solvent HCFC-225 which is  $\text{CF}_3\text{CF}_2\text{CHCl}_2$ . They have a lower *ozone depletion potential* (ODP) than CFCs because they are more susceptible to photodecomposition and therefore less likely to migrate to the stratosphere to react with ozone. However, HCFC-22 is due for elimination from use by 2020 and other HCFCs by 2030. See *hydrofluorocarbons*.

**hydrocleaning** *Water jetting.*

**hydrocyclone** (1) A *wet cyclone*. (2) A *cyclone* used to separate solids from liquids.

**hydrodynamics** The theory of fluid motion.

**hydrodynamic separator** The use of hydrodynamics for *grit removal* from wastewater or to remove other large suspended solids from wastewater.

**hydrofluorocarbons, HFCs fluorinated hydrocarbons.** Chemicals that contain hydrogen, fluorine and carbon atoms. As they do not contain any chlorine atoms they do not destroy ozone and their *ozone depletion potential* is zero, although they are *greenhouse gases*. They have an increasing range of industrial uses and are being used as replacements for *chlorofluorocarbons* (CFCs) or *hydrochlorofluorocarbons* (HCFCs). Common examples include the refrigerant HFC-134a which is  $\text{CF}_3\text{CHF}$  and HFC-152a which is  $\text{CHF}_2\text{CH}_3$ .

**hydrogasification** High temperature conversion of *garbage* or manure with added hydrogen to produce *methane* or oil fuel.

**hydrogen ion concentration** *See pH.*

**hydrogen peroxide  $\text{H}_2\text{O}_2$**  A strong oxidising agent that is unstable and degrades to water and oxygen. It is available as a solution in water. It is a disinfectant, but too expensive for routine use. It is used in *wet scrubbers* for *odour control*. It is used in *leachate* treatment in order to remove sulphides with the precipitate of elemental sulphur. It is used as an oxidant in the treatment of hazardous waste such as the oxidation of cyanide or in the *UV/ $\text{H}_2\text{O}_2$  process*.

**hydrogen sulphide, sulphuretted hydrogen,  $\text{H}_2\text{S}$**  A poisonous gas produced under anaerobic conditions such as *anaerobic sludge digestion*, and septic wastewater. Its smell of rotten eggs can easily be detected at one part per million in air but not at high concentrations. It is toxic to man and at 1000 p.p.m. kills immediately. The gas progressively ionises in water as the pH rises:

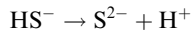

Only the undissociated  $\text{H}_2\text{S}$  comes out of solution to produce the smell; hence, a low pH favours removal and flushing out by *aeration*. However, if water containing  $\text{H}_2\text{S}$  is aerated, some of it may be oxidised to *elemental sulphur*, giving a milky look to the water.  $\text{H}_2\text{S}$  production in sewers is particularly important in *sulphide corrosion*. *See above, Table D.2 Drinking water standards.*

**hydrogeology** The study of water and its movement in soil and rock formations.

**hydrogeomorphology** The study of the influence of water on the processes involved in creating landforms.

**hydrograph** A graph that shows the flow rate (discharge) of a river or stream plotted against time. The area under the graph, the product of flow rate and time, is the volume of water delivered in that time. Long period

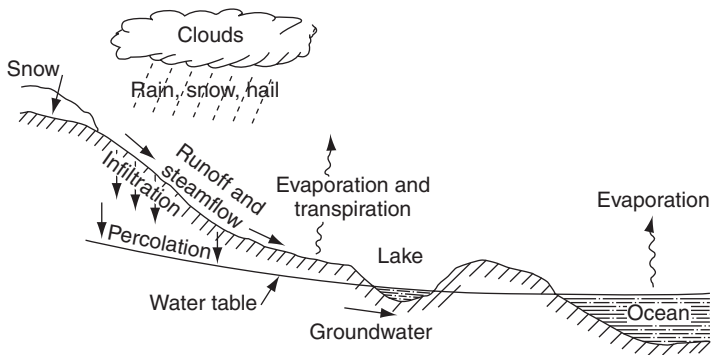

**Figure H.5** Hydrological cycle.

hydrographs are essential for planning either a hydro-electric or a water supply scheme. Short period hydrographs (e.g. *unit hydrographs*) show the pattern of *runoff* from a given intensity (number of mm or inches) of rainfall and are useful in the design of flood prevention schemes.

**hydroinformatics** The use of computers and information technology in the planning and management of the water environment.

**hydrological cycle, water c.** (*Figure H.5*) Water evaporates from land, water or vegetation and the resulting vapour rises to form a body of damp air. Further heating of this damp air causes it to rise through the colder air above it, high into the atmosphere, until it is cooled by the increasing height. The water vapour then condenses to form clouds in which the water droplets enlarge. When they become too heavy to remain airborne, they fall from the cloud as rain, snow or hail. This is the water cycle. Water also evaporates by *transpiration* from vegetation and as a result of human activity—for example, in exhaust steam. When water falls over land, some is held by vegetation and never reaches the ground surface. Some reaches the ground on roads, roofs, etc., and flows straight into drains, streams and rivers for a quick return to the sea or a lake. Other water will flow into the ground rather than over it and will percolate down to the *water table*. This *groundwater* may reappear on the surface at springs or wells or move horizontally to a river or sea. Such movement may be very slow, and water held deep in the ground may have been there for many thousands of years. Rain, snow or hail can also fall over permafrost and remain for a very long time as ice or snow. Glaciers and polar ice contain 35% of the world's fresh water, compared with 0.03% in the atmosphere and 0.003% in the rivers.

**hydrology** The study of the *hydrological cycle* and of water.

**hydrolysis** (verb *hydrolyse*) The formation of compounds by combination with water. For example, *urea* ( $(\text{NH}_2)_2\text{CO}$ ) is readily hydrolysed to ammonium carbonate. *Polysaccharides* may be hydrolysed to their component sugars. Metal ions form complex *ions* with water. Bacteria can often

- hydrolyse insoluble or long chain organic compounds to simpler soluble ones.
- hydrotic tank** A two-storey *septic tank* used in the UK in 1903 by Travis, from which the *Imhoff tank* was developed.
- hydrometer** A thin stemmed instrument that floats vertically in fluid to indicate its *specific gravity*.
- hydrometry** The measurement of water, particularly its flow rate.
- hydromorphological** The hydrology and morphology of natural water systems, e.g. the flow and shape of rivers.
- hydrophilic** Description of something that has an affinity for water.
- hydrophobic** Description of something that has little or no affinity for water.
- hydrophobic chalk, Nautex chalk H** An oil attracting powder which can be used for sinking oil slicks on the sea. Such sinking methods have the danger that the sunken oil will foul fishing nets and taint any fish caught.
- hydrophobic colloid** A colloidal suspension that has a low affinity for water—i.e. it settles readily.
- Hydropsyche** A genus of *caddis fly* that is more tolerant of organic pollution than other caddis flies.
- Hydro-Sonic gas cleaning** A *wet scrubber* in which water plus steam or compressed air is sprayed into the effluent gas. The water droplets aggregate with fine particles in the gas stream, which can then be removed.
- hydrosphere** The water of the Earth's crust, including *groundwater*, surface water, the oceans, etc.
- hydrostatic head, hydrostatic pressure** The pressure in water caused by its difference in level between one point and another. A *head of water* is expressed as its height in metres. Pressure is force per unit area.
- hydrostatic valve** See *telescopic valve*.
- hydroxyapatite** A complex phosphate and hydroxyl precipitate. Calcium hydroxyapatite,  $\text{Ca}_{10}(\text{PO})_6(\text{OH})_2$  is the form of calcium found in human bones. When lime is added to wastewater containing phosphate, some of the precipitate is calcium hydroxyapatite.
- hyetograph** A graphical plot of rainfall depth or intensity (depth per unit time) against time.
- hygrometer** An instrument that measures the air's water vapour content or its *relative humidity* or both.
- Hymenolepsis nana**, dwarf tapeworm A *parasite* on man which is passed in the faeces and transmitted without an intermediate *host* via soiled clothes, food, contaminated water, etc.
- hymenolepiasis** The disease caused by *Hymenolepsis nana*.
- hypereutrophic** A body of water that is severely *eutrophic*.
- hyperfiltration** *Ultra-filtration*.
- hypo** *Sodium thiosulphate*.
- hypochlorination** The use of calcium or sodium *hypochlorite* instead of chlorine gas for *chlorination*.
- hypochlorite**,  $\text{OCl}^-$  Any salt of hypochlorous acid, such as sodium hypochlorite,  $\text{NaOCl}$ , or calcium hypochlorite,  $\text{Ca}(\text{OCl})_2$ . See *chlorination*.

**hypochlorous acid, HOCl** One of the most powerful *chlorine* disinfectants for water, which dissociates to  $\text{OCl}^-$  and  $\text{H}^+$  at *alkaline* pH. At pH 7.5, 50% is dissociated; and at pH 5, none. Undissociated HOCl is said to be 70 times as bactericidal as  $\text{OCl}^-$ ; therefore, during *disinfection* with chlorine, low pH is desirable. At pH 7, 99% kill of *Escherichia coli* is achieved in 20 min contact time at 0.04 mg/l of *free residual chlorine* or in 5 min at 0.12 mg/l of free residual chlorine.

***Hypogastrura viatica*** A species of *springtail*, an insect that can help *trickling filter* operation by feeding on the algae, bacteria or fungi that clog it during *ponding*.

**hypolimnetic** Concerned with the *hypolimnion*.

**hypolimnion** The coldest, lowest layer of water in a stratified lake or reservoir or sea, bounded above by the *thermocline*. Its water is relatively stagnant and has little or no dissolved oxygen, but a high carbon dioxide content and a fairly uniform temperature of 4 to 6 °C. See *thermal stratification*.

**hypoxic** Very low (but not zero) oxygen concentration.





---

**I and M** Inspection and maintenance.

**IAWQ** International Association of Water Quality, which is now included in the *International Water Association* (IWA).

**IBI** Index of biological integrity. *See biotic index.*

**ICAP ICP.**

**ICE** Institution of Civil Engineers, Great George Street, London.

**ICOLD** The International Commission On Large Dams, and body that is interested in dam engineering and dam safety. *See USCOLD.*

**ICP, ICAP inductively coupled argon plasma emission spectrometry** An analytical technique in which a *plasma* is generated by an induction coil operating at frequencies of 4 to 50 MHz. The oscillating magnetic field induces an electron and ion current which generates a temperature of 6000°C or more in the argon gas that is flowing through the induction coil. A sample is introduced into the plasma. At the high temperatures, the compounds in the sample are broken down into excited atoms, many of which emit light. The wavelength of the emitted light can be analysed allowing simultaneous analysis of a wide range of elements, particularly the metallic elements. This is known as ICP-OES (optical emission spectroscopy).

**ICP-MS** The use of *ICP* to generate ions that are then analysed by *mass spectrometry*.

**ICR** In the USA, ignitable, corrosivity, and reactivity of a hazardous waste.

**ICRCL** *Interdepartmental Committee on the Redevelopment of Contaminated Land.*

**ICRP** International Commission for Radiation Protection.

**ID50, infective dose 50%** The concentration of the pathogen at which 50% of the organisms or animals, humans, etc., become infected.

**IDF curves** *Intensity duration frequency curves.*

**ignitable or wastes** In the US, this term refers to wastes with a flashpoint below 60°C or solids capable of causing fire.

**I/I** An abbreviation used for *inflow* and *infiltration*, particularly in relation to stormwater entering sewers.

**ilmeneite** A *dense mineral* of relative density 4.8, like *garnet*, used in *rapid deep bed filters* to prevent disruption of the gravel surrounding the *underdrains*.

**imago** The adult stage of an *insect*, following after either the *pupa* or the *nymph*, depending on the species.

**Imhoff cone** A conically tapered, open topped glass vessel of 1 litre capacity, with the point of the cone down, graduated up to about 50 ml from the

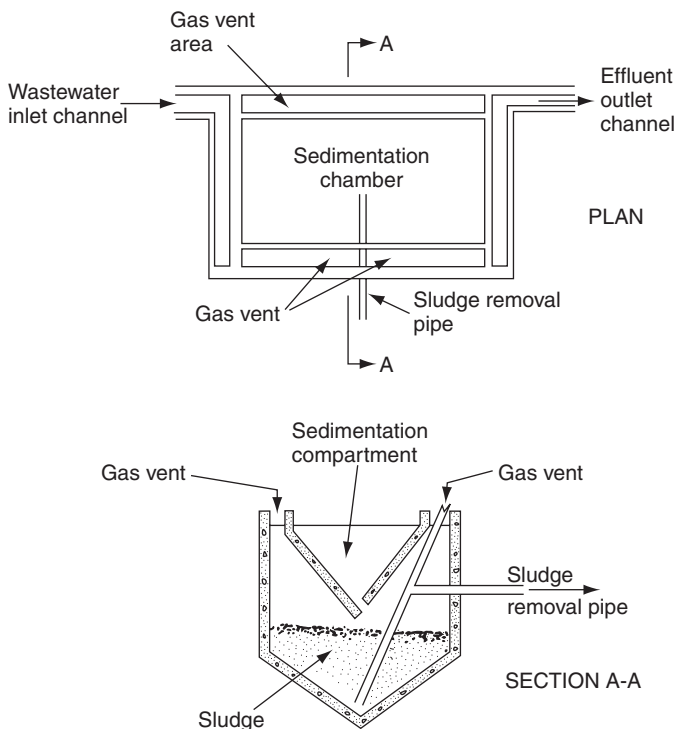

Figure I.1 Imhoff tank.

bottom. It measures the *settleable solids* in wastewater quickly and cheaply. Domestic wastewater may produce 3 to 12 ml of solids per litre after 45 min of settlement in an Imhoff cone.

**Imhoff tank** A type of *septic tank*. It is a two-storey *sedimentation tank* with a sludge compartment directly below the sedimentation compartment, connected with it by a slot through which the solids continuously slide in (see Figure I.1). Gases from the sludge compartment are directed away from the falling solids so as not to hinder their descent, and the sludge can be removed by a pipe from the sludge compartment. In warm weather it therefore functions better than the *septic tank*, in which the digesting sludge, yielding gas, may hinder settling or lift the sludge to the surface.

**I/M** Inspection and maintenance.

**Immedium filter** An *upward flow sand filter* with about 1.5 m depth of sand. The sand is restrained by a grid near the top of the bed.

**immobilisation (or immobilization) of waste** See *solidification of waste*.

**immuno-compromised, immuno-suppression** Suppression of the immune system of humans can occur for a variety of reasons, for example individuals who have AIDs or undergoing chemotherapy or taking drugs to lower the immune system after transplant surgery. *Cryptosporidiosis* can be a serious

waterborne disease for immuno-compromised individuals because there is no effective drug treatment for this disease.

**impact block** Replaceable steel or iron wear plates inside a *mill*.

**impact breaker, crusher, impactor** A machine sometimes used with municipal refuse for breaking bulky wastes such as sofas or crates. The feed opening should be at least 1.3 by 2 m.

**impact deceleration** A *signature method* of distinguishing steel, aluminium, glass and wood by the impact of the material on a tool carrying an accelerometer. The individuality of each of these materials is seen in its 'impact signature'—the shape of the graph of deceleration after impact against time. The accelerometer's computer recognises each impact signature and indicates the appropriate chute into which the material should be directed.

**impaction separator, impingement separator, impactor** A separator that uses impaction of the waste gas stream onto a solid surface in order to remove the particulates or mist from the gas. For *mist elimination*, the solid surface may be wire or plastic mesh which allows the water droplets to coalesce and be drained. A *cascade impactor* uses impaction for sampling of particles from gases. *See cyclone, gravity settling chamber.*

**impact moling** A boring device that uses a pneumatic or hydraulic hammer in order to bore a small tunnel in the soil. The soil is displaced, not removed. A pipe is drawn or pushed into the tunnel. The device may have some limited steering ability. *See thrust boring.*

**impact ramming** *See pipe ramming.*

**impact statement** *See environmental impact statement.*

**impeller, rotor** The rotating wheel carrying blades that move the water or air in a *centrifugal pump* or *axial flow pump* or fan.

**impeller collector** A *fan collector*.

**imperforate basket centrifuge, basket bowl c.** Although a solid bowl *centrifuge* is the normal type for sludge dewatering, sludge thickening or small scale sludge dewatering may use an imperforate basket centrifuge. This consists of a vertically mounted spinning bowl. The solids accumulate on the wall and the centrate is decanted. The centrifuge must be stopped periodically to remove the solids from the wall.

**impermeability coefficient, i. factor** *See runoff coefficient.*

**impermeable cover** *See cap.*

**impermeable liner** *See landfill liner.*

**impingement scrubber** A *plate tower scrubber*.

**impingement separator** An *impaction separator*.

**impinger** Any device for collecting a pollutant by projecting the gas containing it against a surface that catches it.

**impounding reservoir, i. lake** A *reservoir* in which raw water may be stored for periods ranging from a few days to several months or even longer, as opposed to the *service reservoir*. Reservoirs filled by pumping from a nearby river allows *abstraction* to be stopped when the river is contaminated by floods or other dirt. Reservoirs may provide a significant improvement in water quality, because they allow suspended matter to

settle and bacteria to die. However, if the water contains nitrate and phosphate, *blooms* can occur in summer, giving the water an unpleasant taste and smell. *River regulating reservoirs* and *direct supply reservoirs* are also impounding reservoirs. *See raw water storage.*

**inactivation of viruses** Inactivation is the word used for the destruction of *viruses*, since they are not living *microbes* and so cannot be killed. Viruses can be more resistant to chlorination than bacteria. Ozone is a more effective virucidal disinfectant than chlorination. Viruses are inactivated quickly at temperatures above 50 °C and UV light can inactivate some viruses.

**incinerating toilets** A toilet without a flush system where the excreta goes to a tank where it is burnt, e.g. by a gas fired burner.

**incineration** Burning of waste solid, liquid or gases. Incineration is widely used for domestic waste, wastewater sludge and hazardous waste. The burning temperature has to be at least 750 °C and may be up to 1050 °C. Very high temperatures may damage the refractory lining of the incinerator. At temperatures of 1200 °C the ash melts into a slag which hinders the operation of the incinerator (but *see sludge melting*). A range of incinerator types are used but some of the most common are *moving grate incinerators* for domestic waste (*see Figure I.2*) and *fluidised bed incineration* (*Figure F.6*) for wastewater sludge (*see also Figure W.1*). Other methods include *multiple hearth incinerator* (*Figure M.5*), *rotary kiln incinerator* (*Figure R.8*), *liquid injection incinerators*. Wastewater sludge is often thermally dried before incineration. For the incineration of domestic waste, the waste may be sorted prior to incineration in order to remove glass and metals. *Mass burn incineration* is common. The quantity of air supplied is important so that complete combustion is achieved (*see excess*

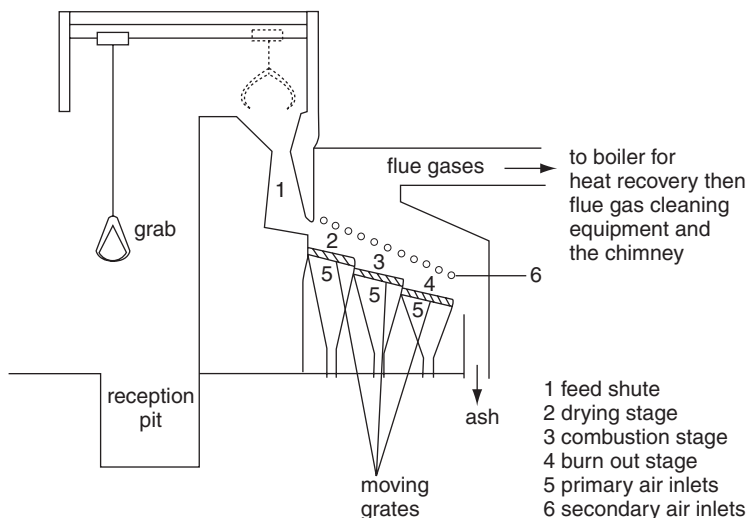

**Figure I.2** Moving grate incinerator for domestic refuse.

*air, primary air, secondary air*) and the *products of incomplete combustion* are minimised. The volume is reduced to about 15%. Of the remainder, most goes into the bottom ash but some goes into *fly ash*. Air pollution control is important for the effluent gases from the incinerator. The equipment may include a *cyclone* or *electrostatic precipitator* or *wet scrubber* or a *fabric filter* or a combination of air pollution control equipment. The EU passed two Directives in 1989 to regulate emissions from existing municipal incinerators. These two Directives have been replaced by the more stringent *Incineration of Waste Directive, 2000*. See *direct flame incineration, hazardous waste incinerator, plasma arc incineration, starved air incineration, VOC incinerator, two stage incinerator, waste to energy plants*.

**Incineration of Hazardous Waste Directive, 1994** An EU Directive that aims to provide procedures for the reduction of the environmental impact and pollution from the incineration of hazardous waste. It set up systems for verification of the nature of the hazardous waste prior to incineration. It covers a range of technical aspects including the emission limits to the air, wastewater discharges, final disposal of residues and monitoring procedures. See *Hazardous Waste Directive 1991*.

**Incineration of Municipal Waste Directives, 1989** Two EU Directives that set air quality standards for the flue gases from these incinerators.

**Incineration of Waste Directive, 2000** An EU Directive that replaces the *Incineration of Hazardous Waste Directive, 1994* and the two Incineration of Municipal Waste Directives, 1989. The new Directive covers all uses of incineration for waste disposal and includes more stringent air quality standards for the flue gases.

**incinerators with energy recovery** *Waste to energy plants*.

**inclined conveyor separator, cinder s.** An endless belt conveyor, sloping at about 45° to the horizontal, has been used for separating the *garbage*, carried to the top, from cinders, which roll down to the bottom. It is a type of *inertial separator*.

**inclined plate and tube settler, settling module, tube clarifier, tube settler** Water or wastewater to be treated flows through the settling plates or tubes about 100 mm wide. This reduces the distance that solids travel before they reach the base of the plate or tube compared to conventional *sedimentation tanks*. The plates or tubes may be at 60° to the horizontal so that solids that settle on them slide down. Alternatively they may be set at a more gentle slope and require backwashing to clear the solids. Overloaded sedimentation tanks or clarifiers in water or wastewater treatment works can be up graded by placing inclined plates or tubes near the outlet weir (see *Figure 1.3*). If solids accumulate around the tube tops, air diffusers or water jets may be installed to periodically remove this accumulation. Inclined plates and tubes have been used as oil separators with the water flowing down them and leaving the oil floating upwards on the surface of the plate or tube.

**incombustibles** Materials that do not burn. In refuse these are sometimes also called the inorganics—metals, stone, glass, etc. It is important to extract them from refuse that is being made into *refuse derived fuel*, because they

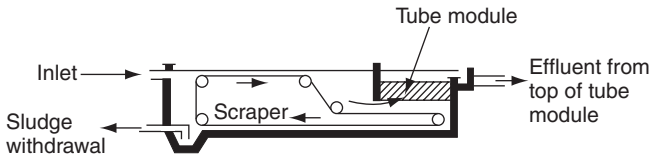

**Figure 1.3** Inclined tube settling module in horizontal flow sedimentation tank.

add weight and ash without adding heating value, thus lowering its usefulness. They can reach 40% by weight of refuse.

**incremental loading** *Step aeration* of an *aeration tank*.

**incubation** Holding a sample, microbial *culture*, etc., for a suitable time at a temperature, appropriate to the investigation, at which microbes are likely to multiply. Typical temperatures are 55 °C for *thermophils*, 44 °C for *E. coli*, 37 °C (human body temperature) for the *coliform group* of bacteria and 20 °C for incubating samples in the *BOD* test.

**indeno(1,2,3-cd)pyrene**, **indeno(1,2,3-cd)pyrene** See *polycyclic aromatic hydrocarbons*.

**index of biological integrity** A *biotic index*.

**indicator organism** An organism, whose abundance can indicate the quality of a water. *Macroinvertebrates* can be used to indicate river water quality as in a *biotic index*. Bacteria such as *coliforms*, are used to indicate the presence of bacterial pollution of bathing water or drinking water.

**indirect catchment** See *catchwater*.

**indirect dryer** See *rotary dryer*.

**indirect effects** In environmental matters, the effect that is produced on the environment due to a series of causes and effects, rather than from the initial cause.

**indirect recycling** The reuse of a material for making something different from the original object (see *waste recycling*). For municipal refuse, the phrase has been used to mean *waste to energy plant*.

**indirect reuse of wastewater** The *abstraction* of water from a river downstream of a wastewater effluent *outfall*. This is usually called ‘uncontrolled’ indirect reuse. ‘Controlled’ indirect reuse is, e.g., the *artificial recharge* of *aquifers* using treated wastewater. Rivers in populated areas may pass through many water treatment and wastewater treatment works before reaching the sea.

**indoor air pollution** In modern buildings ventilation is often reduced due to tight fitting windows, reduced use of open fires etc. This results in a build up of air pollutants and moisture vapour in the indoor air. Possible solutions to indoor air pollution include the removal of the source of air pollution, adequate general ventilation (see *air changes*), local air extraction or purification of the internal air. See *carbon monoxide*, *condensation*, *humidity*, *radon*, *tobacco smoke*.

**Indore process** *Composting* in hot climates (originally Indore, India) using layers of *night soil* and vegetable waste alternately. It is kept *aerobic* by regularly turning for two or three months and then is left to mature.

**induced draught fan** A fan that sucks *flue gases* out of a furnace and pushes them up the chimney. It is therefore placed between the boiler and the chimney. Since hot flue gases pass through it, it is liable to be corroded and its service conditions generally are more severe than those of a *forced draught fan*. Fans made of stainless steel can work at temperatures up to 600 °C, provided that the bearings are water cooled.

**induced recharge** *Artificial recharge*.

**industrial effluent, i. wastewater, trade e.** A range of industries generate wastewaters. It is normally unacceptable to discharge untreated industrial wastewaters direct to rivers, land or disposal down mineshafts, wells, etc. *See industrial wastewater management.*

**industrial effluent charges** The charge by a water authority or company is normally based on flow and chemical constituents. An example of a charging formula related to the operation and maintenance (*O and M*) of the sewerage system and treatment works is:

$$C = R + V + B \times (O_t/O_S) + S \times (S_t/S_S)$$

where  $C = \text{cost/m}^3$  of trade effluent;  $R = \text{cost of O and M of sewers/m}^3$  of mixed wastewater;  $V = \text{cost of O and M of primary treatment/m}^3$  of mixed wastewater;  $B = \text{cost of O and M of secondary treatment/m}^3$  of mixed wastewater;  $S = \text{cost of O and M of sludge treatment/m}^3$  of mixed wastewater;

The cost of biological treatment is weighted by the ratio of the oxygen demands of the settled wastewaters, where  $O_t = \text{COD (or BOD}_5\text{) of trade effluent after settlement}$  and  $O_S = \text{COD (or BOD}_5\text{) of mixed wastewater after settlement}$ . The cost of sludge treatment is weighted by the ratio of the suspended solids of the wastewaters, where  $S_t = \text{suspended solids of trade effluent}$  and  $S_S = \text{suspended solids of mixed wastewater}$ . This type of formula is sometimes referred to as the modified *Mogden formula*. Further charges may be added for specific problematic constituents of the industrial effluent.

**industrial effluent survey** The survey must consider the flow and composition of the wastewater from various industrial processes together with the performance of any existing effluent treatment plant. An understanding of the industrial processes on site and the wastewater production is essential. A survey of the sewer network to ensure knowledge of which wastewater goes where may be required. A water balance showing water usage and effluent production should be prepared. This can include assessment of future changes that can produce changes in the wastewater.

**industrial wastewater management** The objectives should be to minimise wastewater production and to recover and reuse wastewater here economically viable. This enables the cost of wastewater treatment to be minimised. The options for the industrialist is to (1) treat or partially treat at source within the site; (2) treat at a centralised works effluent plant within the industrial complex (*see in house treatment*) or (3) discharge the wastewater to a sewer and pay for off site treatment (*see industrial effluent*

- charges*). For off site treatment, the chemical constituents in the industrial effluent must be checked so that problems do not occur with sewer corrosion or toxicity to the existing biological treatment. The extra BOD load from the industrialist can affect the biological treatment and may generate more sludge (many toxic compounds accumulate in the sludge). The discharge of industrial effluents to a sewer must also consider the hydraulic capacity of the sewers (and wastewater treatment works).
- inertial collection** Collection of particles from a waste gas stream using the inertia of the particles to strike a solid surface e.g. a *cyclone*.
- inertial separator** (1) A separator, used in *mechanical sorting plants*, whose operating principle is based on the differences in relative densities of materials being separated. *Ballistic separators, cyclones, inclined conveyor separators* and *secator conveyor separators* are four common types. (2) A *dust arrestor*, such as a *cyclone, fan collector* or *gravity settling chamber*, that uses the inertia of a particle to extract it from fast flowing flue gas, air, etc.
- inert waste** Waste that is not biologically active nor hazardous nor dangerous, e.g. builders rubble, uncontaminated soil, uncontaminated demolition or excavation waste.
- infectious hepatitis** *Hepatitis A*.
- infiltration** (1) The passage of water through the soil surface—i.e. the entry of rain, snow, etc., into the soil by drainage, as opposed to *runoff* and *evapotranspiration*. (2) Water that enters sewers from the ground because of leaks resulting from their poor condition, loose joints, etc.
- infiltration basin** *A swale*.
- infiltration capacity** The maximum rate at which soil can absorb rainfall in a given condition. *Infiltration* decreases as the rain continues, because some of the soil particles swell and block the pores; also, some of the pores fill with capillary water. Infiltration tends to increase with porosity.
- infiltration drainfield** *A drainage field*.
- infiltration gallery** A tunnel or well dug near a river to withdraw water from it. The water is partly filtered as it flows through the soil between the river and the gallery.
- infiltration trench** *A soakaway* for wastewater effluent or stormwater that consists of a series of trenches. The trenches may be 1 m wide and over 1 m deep, filled with stones of about 50 mm diameter. (See *Figure S.10*.)
- inflow** Water that flows into a pipe, e.g. stormwater entering sewers.
- influent** Description of fluid that flows in; usually water, wastewater, etc., entering a treatment system. See below.
- influent stream** A stream type, common in an arid climate, that loses water into the ground, thus recharging the *groundwater*, unlike the *effluent streams* that are usual in wetter countries.
- infrared spectroscopy, IR spectroscopy** An IR spectrum can be produced by absorption of infrared light (wave number 4000 to 400 cm<sup>-1</sup>). This is an important method for identifying the functional groups within an organic molecule. The lower end of the spectrum is also known as the ‘fingerprint region’ because most organic compounds produce a unique pattern in this



part of the IR spectra. An organic compound can be identified by comparison to a known spectrum. IR can also be used for analysis of gases such as carbon dioxide and methane. IR analysis can be useful in a range of environmental situations.

**infusorial earth** *Diatomite*.

**inhibitory toxicity** A level of toxicity that reduces the rate of reproduction of the organism.

**in house treatment** The treatment of industrial wastewater on site rather than discharging to a sewer for treatment at the local municipal wastewater treatment works. The in house treatment may treat the wastewater so that it can be discharged to a watercourse or it may be partial treatment (sometimes known as pre-treatment) with discharge to a sewer for further treatment with the domestic wastewater. *See industrial wastewater management*.

**injection well** A well that is used to put liquids or gases into the ground. *See biosparging, bioventing, deep well injection, disposal well*.

**Inka process** A method of operating *aeration tanks* in the *activated sludge process* using *coarse bubble aeration*. The shallow immersion of the aerators requires only low pressure air. But the oxygen transfer efficiency is low because of the coarse bubbles and, hence, more air has to be blown in compared to *fine bubble aeration*.

**inlet time** Of *stormwater*, the time required for *runoff* to enter a *sewerage* system. *See time of concentration*.

**in line expansion** The use of *pipe bursting*.

**inoculation** *See seeding*.

**inorganic matter** Matter that does not contain carbon, except as carbonates, bicarbonates, carbon dioxide or carbon monoxide.

**Insecta, insects** The largest class of *arthropods*. Mainly land creatures, they breathe through an external tube, have antennae and six legs, and are often also winged. They are important *grazing fauna* in *trickling filters*. They include beetles, *springtails*, *caddis flies*, *Diptera*, *dragon flies*, *mayflies*, *stone flies*, *water bugs*. Some are *vectors of disease*. They can be used in a *biotic index* to indicate water pollution.

**insecticide** A *pesticide* that kills insects.

**in situ** In its original location.

**insoluble** Description of a substance of low *solubility*.

**inspection chamber** *See manhole*.

**instability** Of a wastewater, its tendency to putrefaction (*anaerobic* decomposition), measurable by the *methylene blue stability test*.

**Institute of Wastes Management, IWM** Formerly the Institute of Public Cleansing, the UK professional association of specialists in public cleansing, waste collection, treatment and disposal.

**Institute of Water and Environmental Management, IWEM** *See Chartered Institute of Water and Environmental Management*.

**Institute of Water Pollution Control, IWPC** A UK professional body that is now part of *Chartered Institute of Water and Environmental Management (CIWEM)*.

**Institution of Public Health Engineers, IPHE** A UK professional body that is now part of *Chartered Institute of Water and Environmental Management* (CIWEM).

**Institution of Water Engineers and Scientists, IWES** A UK professional body that is now part of *Chartered Institute of Water and Environmental Management* (CIWEM).

**Integrated Pollution Control, IPC** Pollution control that embraces the whole environment, i.e. air, land and water. Industrial processes subject to IPC have regulations and limits for their emissions to air, aqueous discharges and hazardous wastes. In the UK, an industrial process that is subject to IPC is known as a prescribed process. IPC requires the use of BATNEEC (Best Available Techniques Not Entailing Excessive Cost) as its guiding principle. In the EU, IPC is being replaced by *Integrated Pollution Prevention and Control*.

**Integrated Pollution Prevention and Control, IPPC** The EU Directive on *Integrated Pollution Prevention and Control (96/61/EC)* states that the objective of an integrated approach to pollution control is to prevent emissions into air, water or soil wherever this is practicable, taking into account waste management, and, where it is not, to minimise them in order to achieve a high level of protection for the environment as a whole. Competent authorities are required to ensure that installations are operated in such a way all the appropriate preventive measures are taken against pollution, in particular through application of the best available techniques. IPPC requires the use of *BAT (Best Available Techniques)* as its guiding principle for the prevention, minimisation, treatment and disposal of gaseous, liquid or solid wastes from industry. IPPC covers a wider range than of industries compared to IPC and a wider range of environmental issues such as noise, raw material consumption, and accident prevention. The Directive replaces Integrated Pollution Control (IPC).

**Integrated Risk Information Systems, IRIS** A USA database that contains qualitative and quantitative information on toxicity data.

**intensity duration frequency curves, IDF curves** A family of curves that relates the intensity, duration and frequency of precipitation at a given point. It is an important part of the *rational method* for storm water calculations.

**interaction of toxicants** Two or more compounds in water may increase or reduce each other's toxic effect. For instance, calcium *ions* may counteract the toxicity of the zinc. Toxic effects are generally increased, for fish, by low dissolved oxygen, because more water has to be taken in through the gills; consequently, more toxins also are brought in. *See antagonism, synergism.*

**interceptor sewer, intercepting s.** Sewers that intercept and collect the wastewater discharged from *collector sewers* and feed the wastewater to larger *trunk sewers* or possibly direct to the treatment works (or the river or sea if the wastewater is untreated).

**intercepting trap, interceptor, disconnecting trap** (1) A water seal sometimes installed between a house drain and a sewer it flows into, to separate the air between the two. It is usually placed at a *manhole*, where it can easily be inspected. (2) A *grease trap*.

**interception** Short term retention of rainfall by leaves, branches, grassland, etc., which may later add to *runoff*, *percolation* or *evapotranspiration*.

**Interdepartmental Committee on the Redevelopment of Contaminated Land, ICRCL** A UK committee established in 1976 that has published a series of guidance notes on the problems of the redevelopment of a range of different contaminated land. The ICRCL set trigger values which are guidelines for the maximum concentration of contaminants in the soil that are relevant to particular potential uses of the land. They are being replaced by new guidelines known as Contaminated Land Exposure Assessment (CLEA).

**interface turbidity monitoring** Use of a *turbidimeter* to monitor water samples taken from the interface in a filter between, e.g. coarse anthracite and fine sand. This shows the operator whether the anthracite removes as much solids as it should, and the *coagulant* dose can be altered accordingly.

**interflow** Water in the ground which, after meeting a relatively impermeable layer, flows more or less horizontally to an outlet at a spring, stream, etc.

**intermediate cover.** The soil that is placed onto a part of a *landfill* site that is used again for tipping, but not for some months. It may be comprised of up to 0.3 m of subsoil or inert material. The use of intermediate cover gives good protection against flies, vermin, bird nuisance and generally improves the aesthetics of the landfill.

**intermediate level radioactive waste** Radioactive waste with activities in the range  $10^{-6}$  to 0.2 curies per litre (one curie equals  $3.7 \times 10^{10}$  becquerel).

**intermittent filtration, intermittent sand filtration, intermittent downward filtration** A type of *land treatment* of wastewater that consists of shallow beds of sand (600 to 750 mm deep). The wastewater or effluent is periodically applied to and flows down through the sand bed. The treated effluent is collected in underdrains. The process can be used to treat settled wastewater or further treat wastewater effluent or a septic tank effluent. Besides filtering out solids, bacteria colonise the sand which assists in BOD removal and nitrification. *Compare recirculation granular medium filter. See soakaway.*

**International Commission on Large Dams** *See ICOLD.*

**International Convention for the Prevention of Pollution from Ships** *See MARPOL.*

**International System of Units** SI units.

**International Water Association, IWA** An organisation formed in 1999 by the merger of the International Association of Water Quality (IAWQ) and the International Water Supply Association (IWSA). It is a leading international organisation that covers all aspects of water supply and treatment, wastewater collection, treatment and disposal, water quality management and environmental and public health issues related to water. It organises international conferences, publications and specialist groups. Its headquarters are in London, UK.

**interstices** The pores inside a soil or rock or filter media etc.

**interstitial velocity** The velocity of flow inside the pores of a filter.

**intertidal zone** The area of sea beaches between high and low tides. This area can be highly polluted by oil spills.

**inversion, temperature i., i. of the lapse rate** Up to about 12 km above sea level, the air usually becomes cooler at higher levels, but occasionally it warms up with increase in height. This is an inversion of the *lapse rate* producing a very stable air mass. Warm air above cool ground is an inversion. Inversions often occur in temperate climates between ground level and 100 m above it on calm clear nights (nocturnal inversion), because the ground cools more quickly than the air above it. During an *anticyclone* an inversion may rise higher than usual and persist for several days, causing dense *fog* or *smog* in winter. In any case polluted air concentrates under an inversion. *See also subsidence inversion.*

**invert** The bottom of a pipe, open channel, sewer, etc.

**invertebrates** Animals with no backbone, e.g. flies, worms, leeches, snails, beetles. They are *grazing organisms* in *trickling filters*. They can be used to define the quality of a river as in a *biotic index*.

**inverted siphon** A U-shaped pipe that flows full and passes water, wastewater, etc. under a railway, road, river or other obstacle. *See siphon.*

**invert weir** A *scum board*.

**in-vessel composting, mechanical composting accelerated c.** The use of tank or container (e.g. a drum or tunnel) in which the organic waste is composted under controlled conditions in order to reduce the time required to compost the waste. Air is introduced either at the bottom of the system or via lances or augers in the compost. The air ensures aerobic conditions. The composting system may be mixed mechanically (*see Figure I.4*). This can be known as dynamic or mixed or agitated bed (or bay) in-vessel composting. **Composting** of agricultural or food waste can be completed in 6 days. In-vessel composting may be used to give a good start to conventional composting methods. A common example is *tunnel composting* and other examples include *drum composter* and *vertical cell composter*.

**in vitro studies** 'In glass' studies; a term used to describe laboratory studies that do not use living organisms.

**in vivo studies** Studies in or using living organisms.

**involute cyclone** A *cyclone* with the usual tangential inlet.

**iodine, I** A *halogen* with the advantage over *chlorine* in *disinfection* that it does not react with ammonia, *phenols* and many other organic compounds. Iodine is more expensive compared with chlorine, so is not usually used in

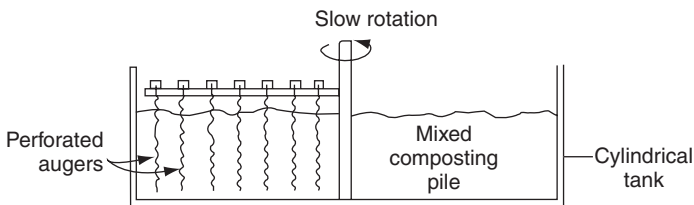

**Figure I.4** In-vessel composting. Air is blown into the composting pile via the perforated augers.

municipal water supply. A lack of iodine in the diet can produce goitre. Iodine can be used as an emergency disinfectant.

**iodine number** The number of mg of *iodine* adsorbed by a known mass of *activated carbon* from a known solution of iodine. The amount adsorbed is proportional to the internal surface area of the carbon and includes pores as small as 1 *nanon* across. If the iodine number is reduced by 50%, it is time to change the carbon. *See also adsorption, phenol adsorption test.*

**ion** An atom or group possessing an electrical charge, important in *electrolysis*. Salts when they dissolve in water, dissociate to yield a *cation* with a positive charge and an acid radical *anion* with a negative charge. Ions exist also in gases—e.g. within *electrostatic precipitators*.

**ion exchange** A process in which water (or wastewater) passes over a solid material and one species of ion on the surface of the material is exchanged for a similarly charged ion in the water. Soils have the ability for ion exchange, but in water (or wastewater) treatment, the ion exchange material is normally a synthetic ion exchange resins. Resins with  $\text{SO}_3^-$  or  $\text{COO}^-$  permanently attached accept and exchange cations such as  $\text{Na}^+$ ,  $\text{H}^+$ ,  $\text{Ca}^{2+}$ . These are cation exchange resins. Anion exchange resins have amine groups ( $\text{NH}_3^+$ ) permanently attached and accept and exchange anions such as  $\text{Cl}^-$ ,  $\text{SO}_4^{2-}$ ,  $\text{OH}^-$ . These are anion exchange resins. Resins are regenerated by use of a concentrated solution of the original ion through them. The wastewater from regeneration contains the ion that was removed from the water. Different resins have been developed for different uses, even for uranium extraction from low grade ore. In water treatment, beds of ion exchange resin may be used for water softening or demineralisation or nitrate removal from water. They are typically 0.6 to 3 m deep. They are contained in a pressure vessel up to 4 m diameter. The flow through the bed is up to  $25 \text{ m}^3/\text{hr}$  per  $\text{m}^3$  of bed volume. The run time between regenerations is typically between 6 to 12 hours. The wastewater from regeneration of an ion exchange bed used for nitrate removal is high in nitrate which can give a problem for the disposal of this wastewater. For demineralisation of water, cations are exchanged for  $\text{H}^+$  and anions are exchanged for  $\text{OH}^-$ . Separate beds of cation exchange resins followed by anion exchange resins may be used but *mixed bed ion exchange* beds are common. *See breakthrough (Figure B.10).*

**ion exchange membrane** *Ion exchange resins* formed into sheets; first achieved about 1950. Ion exchange membranes made *electrodialysis* possible.

**ion exchange resins** Synthetic resin beads made for *ion exchange*.

**ionising wet scrubber** A *wet scrubber* in which water is sprayed into the effluent gas and then an electrostatic charge is imparted to the water droplets. The droplets are attracted to the collection plate and washed off the plates by water.

**ion selective electrodes** *Electrodes* that may be used to measure the concentration of *ions* in water, such as ammonium, nitrate, sulphide, chloride, *potassium*, etc. The presence of other elements may interfere with their accuracy and this may limit their use.

**ion selective membrane** An *ion exchange membrane* that holds either *cations* or *anions* but not both, used in *electrodialysis*.

**IPC Integrated Pollution Control.**

**IPC processes** In the UK, an industrial process that is subject to *Integrated Pollution Control* (IPC). It is known as a prescribed process.

**IPHE** Institution of Public Health Engineers now part of *Chartered Institute of Water and Environmental Management* (CIWEM).

**IPPC Integrated Pollution Prevention and Control.**

**IRIS Integrated Risk Information Systems.**

**iron bacteria** A diffuse group of bacteria that form natural colonies heavily encrusted with ferric oxides. They are all *chemosynthetic*, although some are *heterotrophs*, such as *Leptothrix* and *Sphaerotilus*, and these may grow in the absence of iron. Others are probably *autotrophs*, requiring *ferrous salts* which they oxidise to ferric oxide. *Thiobacillus ferro-oxidans* is both a sulphur oxidising and an iron oxidising bacterium. Iron bacteria may create rusty slime that smells, stains and blocks *sand filters*.

**iron in water** If oxygen is present, soluble ferrous ( $\text{Fe}^{2+}$ ) salts readily oxidise to the less soluble ferric ( $\text{Fe}^{3+}$ ) compounds that produce a rusty brown precipitate. However, in anaerobic conditions soluble ferrous compounds predominate. Groundwaters may have 10 mg/l or more of iron. Iron may also be present in the water due to corrosion of cast iron pipes. Dissolved iron is not toxic but concentrations of 0.2 mg/l can stain clothes in washing machines or spin dryers. Higher levels of iron can lead to problems of brown precipitates at ambient temperatures and also give water a bitter taste. If iron is present in the water during distribution, the growth of *iron bacteria* in the pipes may be stimulated. The removal of iron in water treatment is by oxidation of the ferrous to ferric and removal of the ferric precipitate by sedimentation or filtration. The oxidation involves adjustment of the pH to 8 and possibly addition of oxidising agents such as chlorine. Iron removal can be achieved by the growth of oxidising iron bacteria in a *packed bed filter* (see *biological iron removal*). See *Table D.2 Drinking water standards*.

**iron in wastewater** See *ferruginous discharge*.

**iron pyrite** Ferrous sulphide ( $\text{FeS}_2$ ). See *acid mine drainage*.

**irrigated filter** A filter for air or other gas, with liquid, usually water, flowing over its collecting surface to improve its collecting efficiency; not a *trickling filter*.

**irrigation** Artificial watering of agricultural land by pipe or channel. Salinity and the *sodium adsorption ratio* (SAR) are important quality parameters for irrigation water as excessive salinity or sodium ions affect plant growth. Salinity can be measured by total dissolved solids (TDS) or electrical conductivity (EC) in the water. In general, the EC should be less than 1 mS/cm and the SAR less than 15, but it depends on the crop type and chemistry of the soil. Other important quality parameters include *boron*, faecal bacteria and toxic chemicals. Wastewater effluent has been used for irrigation, but the quality of the effluent must be appropriate. A range of toxic chemicals may either affect the plant directly (phytotoxic) or affect animals or humans that eat the plants that have become contaminated by the toxic chemicals. The use of irrigation for the treatment of wastewater is

- known as *land treatment*. See *centre pivot irrigation, drip irrigation, flood irrigation, furrow irrigation, spray irrigation, subsurface irrigation*.
- irrigation efficiency** The volume of water used beneficially by the plants (including evapotranspiration) divided by the volume of water applied.
- IR spectroscopy** *Infrared spectroscopy*.
- iso-** This prefix often indicates 'equal' or 'same'. Thus, an isotherm or isothermal line is a line joining points at equal temperature.
- ISO** International Standards Organisation.
- ISO 14000 series** A series of international standards on the environment. ISO 14001 gives general guidance on the use of *Environmental Management Systems* (EMS) and ISO 14004 deals with principles, systems and techniques for EMS. ISO 14010 gives general guidance on auditing environmental management systems. ISO 14011 relates to procedures for auditing environmental management systems. ISO 14012 relates to the qualification of environmental auditors. ISO 14031 details the methodology for environmental performance evaluation.
- isobar** A line that connects points of equal pressure.
- isochlor** A line of equal concentration of *chloride* in a *groundwater* or an *aquifer*, used for mapping contamination by chlorides (*saline intrusion*).
- isocyanate** A compound that contains the group—NCO. Substances based on isocyanates are widely used in a variety of manufacturing industries such as spray painting of vehicles, production of polyurethane foam, printing and laminating products, manufacture of footwear. The main health risks to workers exposed to isocyanates include asthma and rhinitis. Isocyanates are also irritants.
- isoelectric point, isoelectric pH** The *pH* value required to produce a zero charge on a *colloidal* particle, bacteria, algae, etc. See *electrophoretic mobility*.
- isohyetal line, isohyet** Lines on a map that designate equal rainfall.
- isokinetic flow** See *sampling train*.
- isokinetic sampling** Gas Sampling where the gas velocity going into the sampling probe is the same as the gas velocity in the stack from which the sample is being taken. This is required in order to obtain an accurate sample of particulates in a gas stream. If the velocity of flow into the sampler is less than the velocity of flow in the stack, the sample contains fewer particulates than the waste gas stream. If the velocity of flow into the sampler is greater than the velocity of flow in the stack, the sample contains more particulates than the waste gas stream. See *Figure 1.5*.
- isolating valve** A stop valve, to isolate an area of a pipe system, a tank, etc.
- isoproturon** A common herbicide, particularly for killing grasses and broad leaf plants. The WHO guideline maximum value is 9 µg/l in drinking water. The EU Drinking Water Directive states a mandatory maximum of 0.1 µg/l. The EU lists it as a *priority substance* in relation to aquatic discharges.
- isothermal** At constant temperature.
- isothermal lapse rate** A *lapse rate* with no change in temperature with height. See *adiabatic lapse rate*.
- isotope** Elements can have several varieties of isotopes, all with the same chemical properties except for their different atomic masses; for example,

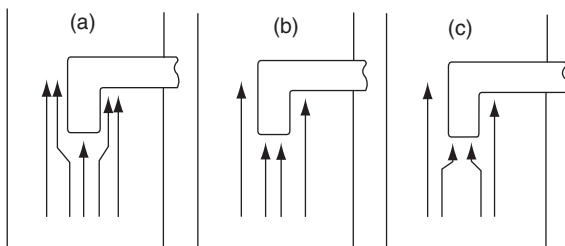

**Figure I.5** Iso kinetic sampling (a) flow into sampler is too low, particles will flow past the probe; (b) correct flow into sampler; (c) flow into sampler is too fast, too many particles sucked into the probe.

hydrogen has mass 1, deuterium has mass 2, tritium has mass 3, but all are isotopes of hydrogen. Tin has ten isotopes. *See radioactive isotopes.*

**isotropic** A substance that has the same properties in all directions.

**IWA** *International Water Association.*

**IWEM** Institute of Water and Environmental Management, now called the *Chartered Institute of Water and Environmental Management (CIWEM).*

**IWES** Institution of Water Engineers and Scientists now part of *Chartered Institute of Water and Environmental Management (CIWEM).*

**IWM** *Institute of Wastes Management*

**IWPC** Institute of Water Pollution Control now part of *Chartered Institute of Water and Environmental Management (CIWEM).*

**IWSA** International Water Supply Association, which is now included in the *International Water Association (IWA).*





---

**jacking** *See pipe ramming.*

**Jackson turbidity unit, JTU, Jackson candle unit, JCU** A measure of *turbidity* in water. It can be defined in two ways: (1) The turbidity resulting from 1 mg/l of fuller's earth suspended in water. (2) The depth of the column of water that just obscures the image of a burning standard candle viewed vertically through the sample.

**jar test** A simple test to determine the correct chemical dose for a water or waste water, most commonly used for estimating the pH and *coagulant* requirement for a raw water. Various amounts and combinations of chemicals are added to several samples of water of the same volume, placed in jars and stirred slowly, typically for 30 minutes. The sample is allowed to settle and the quality of a supernatant is measured.

**jet aeration** A method of *coarse bubble aeration* in an *activated sludge* aeration tank. The air is introduced at about a quarter of the depth of the aeration tank through perforated pipes. Each hole in the pipe has a nozzle or jet attached.

**jet cutting, jetting** The use of high pressure water to wash away soil, as in tunnelling or open cast mining.

**jet ejector scrubber** An *ejector Venturi scrubber*.

**Jeta grit trap** A type of *vortex grit separator*.

**jetted tube well** A method for digging a water well in soft ground. A pipe is sunk into the ground while water is pumped down through the pipe and out of the well in order to remove the soil material and allow the pipe to be further sunk into the ground. *See palm and sludger tube well.*

**jigs** *Mineral dressing* baths that pulsate to separate coal or other mineral from stone and could be used in a *mechanical sorting plant* where the wetness does not matter. The light materials flow over the top. The heavies (sinks) flow out below the water surface.

**Johannesburg process** The *AAO process (Figure A.1)* but with the addition of another anoxic zone in the return activated sludge from the sedimentation tank.

**JTU** A *Jackson turbidity unit*.

**juvenile water** Water that comes from magmatic sources. It has never been *meteoric water*.

**kanat** A *ghanat*.

**katabatic wind** A wind that blows downhill along a slope cooled by radiation, frequently at night. It may be the cause of an *inversion*.

**katabolic metabolism** *Catabolic metabolism*.

**kathode, kation** See *cathode, cation*.

**kelp**, *Laminaria digitata* A *brown alga*, a seaweed. This alga, sometimes used in a *biotic index*, grows near the low water mark.

**keratosis** A growth on the skin, such as a wart.

**kerb side collection** Waste from households and businesses left on the side of the road premises from where it is collected. Successful waste recycling schemes are often based on different collections for different parts of the waste stream. In particular, waste paper recycling requires separate collection of the paper.

**kerb stop valve, kerb stopcock** The valve that is used to shut off water between the water main and the building.

**Kessener brush** A method of *surface aeration* in the *activated sludge* process, devised by Dr H. H. Kessener of Holland in 1925, with rapidly rotating stainless steel brushes on a horizontal shaft. The brushes are partly submerged in the *mixed liquor*, swirl it around and thus aerate it. See also *Mammoth rotor, TNO rotor*.

**kier liquor** The waste liquid from boiling cotton, flax, straw, or other material with a high *cellulose* content, in a strong alkaline liquid. Kiering removes dirt, grease, colour, etc., thereby allowing the cellulose to be used for papermaking. Cotton yarn also is kiered before dyeing. Kiering in papermaking produces a waste liquor with BOD<sub>5</sub> of 30 000 to 40 000 mg/l and pH of 12, and in cotton yarn kiering a BOD<sub>5</sub> of 4000 to 8000 mg/l.

**kieselguhr** *Diatomite*.

**kinematic viscosity** See *viscosity*.

**kingdom** A major division of *taxonomy*.

**kitchen waste disposal unit** A *garbage grinder*.

**Kjeldahl technique** A method for measuring the unoxidised *organic nitrogen* in water. It involves digestion in sulphuric acid with a *catalyst* to produce ammonium sulphate from the organic nitrogen. The concentration of ammonia can then be measured by distilling it off at pH 10 followed by *nesslerisation*. Total Kjeldahl nitrogen is the *ammoniacal nitrogen* plus the unoxidised organic nitrogen.

**Klebsiella** A bacterium that is part of the *coliform* group.

**Kniebühler tank** A *Dortmund tank*.

**knife discharge** A long blade parallel to the face of a *vacuum filter* drum which scrapes the *filter cake* from its face. In some applications the cake may have to be detached by blowback (internal air pressure).

**Kolkwitz-Marsson saprobic system** The *saprobic classification* of rivers devised by Kolkwitz and Marsson in 1911.

**Koc Carbon matter partition coefficient.**

**konimeter** A dust sampling instrument formerly used in mines, which caught the dust particles on a greased glass slide. They were later put under a *microscope*, counted and measured.

**Kow Octanol water partition coefficient.**

**kraft or alkaline sulphite process** A papermaking process that produces the strongest (*kraft* = German for strength) brown paper. Wood chips are cooked in caustic soda, sodium sulphite and other chemicals for several hours under pressure at 176°C and then released. The spent liquor is dewatered down to about 65% dry solids and then incinerated to reduce pollution of water. *See paper and pulp manufacturing wastewater.*

**Kraus process** An *activated sludge* process designed for treating wastewater that is deficient in nitrogen, an essential ingredient for bacterial growth. Some of the supernatant from *anaerobic sludge digesters* is aerated and then mixed with the return activated sludge and sent to the aeration tank for conventional activated sludge treatment.

**Kubel test** A test for small amounts of organics in water, which involves boiling the water with *potassium permanganate* for 10 min. The value is about three times as high as that obtained in 4 h at 27°C in the *permanganate value* test.

**Kyoto Protocol 1997** A development of the *Rio Earth summit, 1992*. The protocol commits developed countries to legally binding targets for reducing their emissions of six *greenhouse gases* (carbon dioxide, methane, nitrous oxide, hydrofluorocarbons, perfluorocarbons and sulphur hexafluoride) by 5.2%. The Protocol allows for *carbon emissions trading*.



---

**lactose broth** A reagent used in *most probable number* testing for the *coliform group* of bacteria, which consists of lactose sugar in a nutrient broth.

**lacustrine** Concerned with lakes.

**lade** A *leat*.

**lagoon** (1) An *aerated lagoon*. (2) A *waste stabilisation pond*. (3) A *settling pond*. (4) A *sludge lagoon*.

**lag phase** An early *growth phase of microbes* during which the microbes acclimatise to their new environment. The rate of growth is very low.

**lamblia** *Giardiasis*.

**lamella separator, tilted plate s.** A settling device with parallel, steeply inclined plates, about 50 mm apart. *See inclined plate and tube settler*.

**laminar flow, streamline f., viscous fl.** Motion of fluid at low speeds, in parallel paths and without eddies, unlike *turbulent flow*. In pipes laminar flow normally occurs at *Reynolds numbers* below about 2000.

**Laminaria digitata** *Kelp*.

**lamp hole** A narrow shaft built of pipes over a hole through the centre of the crown of a sewer. It enables a lamp to be lowered on a cord into the centre of the sewer, which then can be inspected by a man looking along from the next manhole.

**land application of sludge, land disposal of sludge** The use of agricultural land after wastewater sludge has been applied is restricted e.g. no grazing of grass within 3 weeks of application. It is undesirable to apply raw sludge to land because of the odours and microbiological hazard. But if raw sludge is being applied it must be injected below the surface or immediately ploughed into the soil. Digested sludge or sludge treated by other methods (e.g. *lime stabilisation*) can remain on the surface after application. High rainfall and steep slopes can result in sludge loss due to surface runoff. The annual sludge application rate on agricultural land may be determined by nutrient requirement or the loading of *potentially toxic elements* (PTE). For nutrient requirements, the land area required is based on the maximum desirable annual rate of addition of nitrogen to agricultural land. Digested domestic wastewater sludge is estimated to have an average nitrogen content of 3% total nitrogen and 1% ammonia ( $\text{NH}_4^+$ ) nitrogen based on dry weight. The organic N slowly mineralises or is biologically converted into ammonia and/or nitrate and hence becomes available to the plants. If the land is used for sludge disposal over a period

of years the design maximum annual application rate can be taken as  $50 \text{ kg NH}_4^+/\text{ha}\cdot\text{yr}$ .

**land disposal of wastes** See above, *landfill, toxic waste disposal*.

**land drain, field d., agricultural d.** A buried pipe with loose joints, dug into wet farmland to keep it dry enough for cultivation. The drain slopes down either to a ditch or to a bigger drain pipe. It is buried about 1 to 1.5 m deep in peaty soils and about 0.9 m deep in silts. See *French drain, mole drain*.

**landfarming** (1) A *bioremediation* technique where contaminated soil is excavated and left on an impermeable base. It is normally mixed with clean soil and placed out on a bed of sand (*compare soil heaping*). Water, nutrients, micro-organisms, compost, etc are added in order to achieve the required biodegradation of the contaminants. The soil is tilled regularly in order to keep it aerobic. It has been used to remove PAHs from soil. (2) *Land treatment of waste*.

**landfill, sanitary landfill, controlled tipping** The depositing of waste on land, often into a natural or man made hole or depression. The deposition should be carefully organised and the site engineered to the appropriate level to ensure minimum environmental intrusion. The waste may be loose tipped and compacted by use of a *steel wheeled compactor* (see *Figures L.1 and S.15*). Alternatively the waste may be compressed into bales at the refuse transfer station and the bales stacked at the landfill site (*balefill*). The waste is usually tipped into a *cell* (1) (see *Figure L.2*). The organic material in the landfill biodegrades anaerobically once the oxygen in the air in the landfill has been utilised. The temperature in the landfill may rise to  $60^\circ\text{C}$  due to this anaerobic microbial activity and *landfill gas* is formed. This gas production should be managed. *Leachate* is formed as water passes through the fill. This can be highly polluting and a modern landfill is operated as a *containment site* rather than a *dilute and disperse site*. Other environmental problems can include *windblown litter* and *landfill fires*. See *below* and *cover, entombment landfill, settlement of landfill, sustainable landfill*.

**Landfill Directive 1999** This Directive classifies landfills into three categories, landfills for either hazardous waste or non-hazardous (e.g. municipal waste) or inert waste. Various waste are no longer acceptable for landfill, including liquid wastes and clinical wastes. Disposal of tyres by landfill

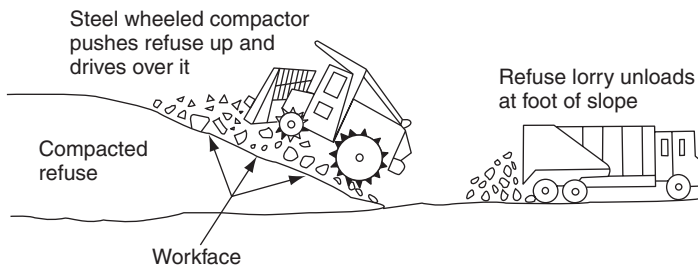

**Figure L.1** Landfill operation using a steel-wheeled compactor. (Refuse may be tipped at the top of the slope and the compactor operates up and down the slope from the top.)

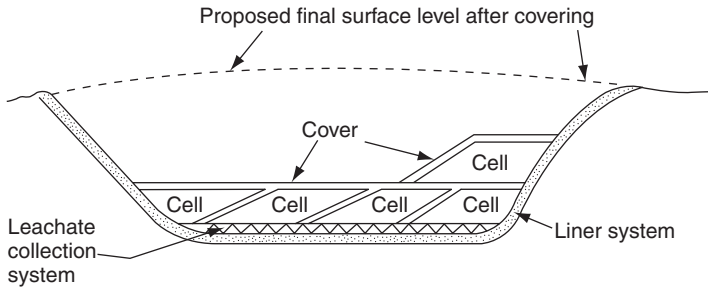

**Figure L.2** Containment landfill (cross section) with impermeable sides and base. Leachate wells and gas vents or wells are not shown.

must stop within 5 years of the implementation of the Directive. The Directive includes the requirement that the quantity of biodegradable municipal waste disposed by landfilling must be reduced. Based on 1995 waste figures, disposal by landfill in EU countries must reduce to 75% within 5 years of enforcing this Directive, 50% within 8 years and 35% within 15 years. The UK will not be required to meet these target reductions until 2010, 2013 and 2020 respectively, because of the heavy reliance on landfilling as a waste disposal route.

**landfill fires** Fires can be caused by the disposal of hot ashes onto the *landfill* or disposal of waste that is readily ignited. Landfill fires are also caused by people starting a fire on site in order to burn off plastic from copper wire, so that the copper can be sold. Landfill fires that become deep rooted are particularly dangerous and can be extremely difficult to extinguish.

**landfill gas** Once the air has been replaced in the *landfill*, the gas that is produced is about 50 to 60% CH<sub>4</sub> and 45 to 40% CO<sub>2</sub> plus minor constituents. The gas is malodorous. Gas production may continue from a landfill site for 20 to 50 years or more after tipping has ceased. Gas management continues during operation of the site and after infilling has been completed. *See below.*

**landfill gas migration** *Landfill gas* may migrate through the surrounding rock strata and produce gas hazards some distance away from the site. The geology must be studied around the site. Underground services can be an important conduit for gas migration.

**landfill gas monitoring** *Landfill gas* concentrations should be monitored on site on a weekly to 6 monthly basis, depending on site location, size and age. Gas monitoring boreholes should be installed, desirably every 50 m.

**landfill gas production** Domestic refuse in a *landfill* site generates about 30 to 180 m<sup>3</sup> of CH<sub>4</sub> per tonne dry refuse over the life of a site, with a peak of about 2 to 8 m<sup>3</sup> of CH<sub>4</sub> per tonne dry refuse per year a few years after placement. The theoretical gas yields can be much higher, but the environmental conditions often restrict the gas yield. Gas yields depend on moisture content, pH, density of refuse and chemicals may be present that inhibit gas production.

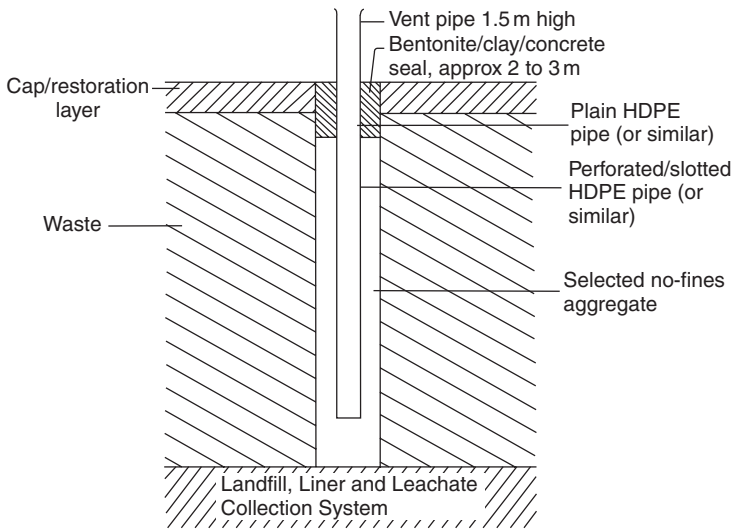

**Figure L.3** Landfill gas wells for passive venting. The pipe may include slip joints to allow for settlement of the waste.

**landfill gas vents** *Landfill gas* builds up in the site as the site is developed.

Vertical gas vents placed 20 m apart enables the gas to escape to atmosphere. The vertical vents can be connected to horizontal gas drains 5 m apart vertically, 15 m apart horizontally.

**landfill gas wells** *Landfill gas* can be extracted via gas wells. These may be drilled after completion of a particular area of the site. The well diameter may be 25 to 50 cm. The system may allow for passive venting of the gas (see Figure L.3) or a pumped system (see *air breakthrough*). The gas may be flared or collected and used. The landfill site settles as it biodegrades and this can be a problem for maintenance of the gas wells. If the gas is collected, the 100 to 200 mm pipework connecting the wells must be corrosion resistant. Deep large sites are more likely to generate sufficient gas for economic usage.

**landfill leachate** See *leachate*.

**landfill liner** An impermeable liner material, such as clay, bentonite, plastic, asphalt, etc., can be placed at the bottom and sides of the *landfill* to prevent movement of *leachate* or *landfill gas* into the soil around the site. Leachate collection pipes can then be installed at the base of the site, over the liner, to remove the leachate to a collecting sump from which it can be pumped or otherwise extracted, often to an on site wastewater treatment facility. Care must be exercised in the installation of the liner, as the presence of holes, cracks or fractures renders the liner less effective. The liner must resist piercing and penetration by sharp objects. The corrosive activity of leachate must also be considered. The lining of a landfill site should have a permeability of less than  $10^{-9}$  m/s, although landfills that

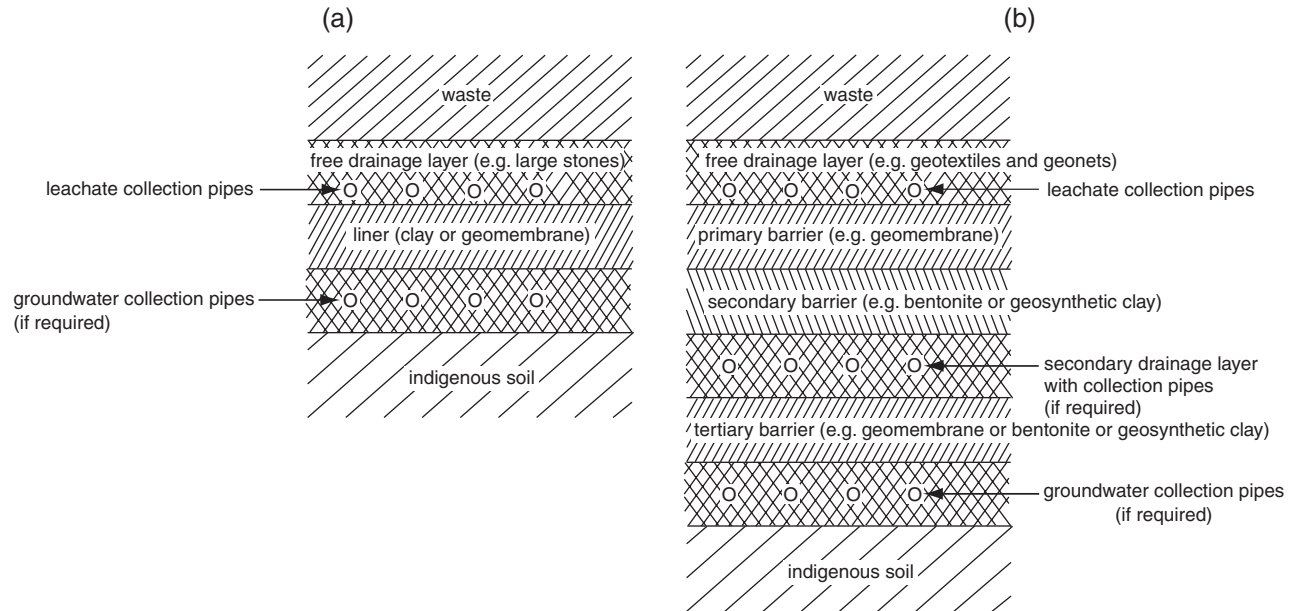

**Figure L.4** Landfill liners (a) single liner system for waste with no hazard risk; (b) multi-liner system for waste with a high hazard risk (bedding material required under the geomembranes is not shown).



take inert waste only require liners to have a permeability of less than  $10^{-7}$  m/s. The EU **Landfill Directive 1999** requires the mineral (e.g. clay) liner thickness to be 5 m for a landfill for hazardous waste, 1 m thick for non-hazardous or inert waste landfill sites. If a synthetic liner is installed, its thickness must be 0.5 m thick. Two or more liners may be installed at a site, particularly if the site is being used for the disposal of hazardous wastes. Examples of **multi-liner** and **single liner** systems are given in *Figure L.4*. See **clay liner, composite liner, containment site, double liner, geomembranes, geonet, geosynthetic clay, geotextile, synthetic liner**.

**landfill settlement** See *settlement of landfill*.

**landfill site licensing** In the UK, a licence must be obtained prior to commencement of landfilling. The licence includes the type and quantity of waste that is allowed onto the site, the site investigation work, the site preparation work, the operational procedures (i.e. the working plan) for the site, the procedures for controlling gas, leachate and other environmental impacts and the final reinstatement of the site after completion of the landfill.

**landfill sustainability** See *sustainable landfill*.

**landfill tax** In the UK, a tax is applied per tonne for waste that is disposed to a **landfill**. Inert waste is charged at a lower rate compared to biodegradable waste, such as domestic refuse.

**land filtration** *Land treatment*.

**land raise** The disposal of waste on low lying ground so that the ground level is raised. See *landfill*.

**land spreading** See *land application of sludge*.

**land treatment** *Natural treatment systems* for the treatment of wastewater or, more probably, wastewater effluent by the passage of the wastewater through soil on land. Examples are shown in *Figure L.5* and include *intermittent filtration, overland flow land treatment, rapid infiltration land treatment* and *slow rate land treatment*. *Soakaways* (see *Figure S.10*) and *soil aquifer treatment* (see *Figure S.11*) are other examples. Treatment processes such as *reed bed treatment* (see *Figure R.3*) and *constructed wetlands* are based on the aquatic environment and may be known as *land treatment* or *aquatic based natural treatment systems*.

**land treatment of waste** Applying a waste to land at a controlled rate, such as the *land application of sludge*. The waste is mixed with the soil so that the waste biodegrades. It has been used for the disposal of wastewater sludges or oily sludges. Some constituents in the waste may be immobilised in the soil. Contamination of the soil may be a problem. Also some of the constituents may leach out of the waste and percolate into nearby natural waters or groundwaters. It is sometimes known as *landfarming*.

**Langelier saturation index (symbol *I*)** An indication of the *non-corrosiveness* of a water, measured by the oversaturation or undersaturation of *calcium carbonate* in it. It is defined as the difference between the pH of the water under consideration and its pH when in equilibrium with calcium carbonate ( $\text{CaCO}_3$ ) (the saturated pH or  $\text{pH}_s$ ). Thus  $I = \text{pH} - \text{pH}_s$ . A negative value of *I* implies undersaturated water that will dissolve  $\text{CaCO}_3$  and will not deposit a protective film of  $\text{CaCO}_3$  on

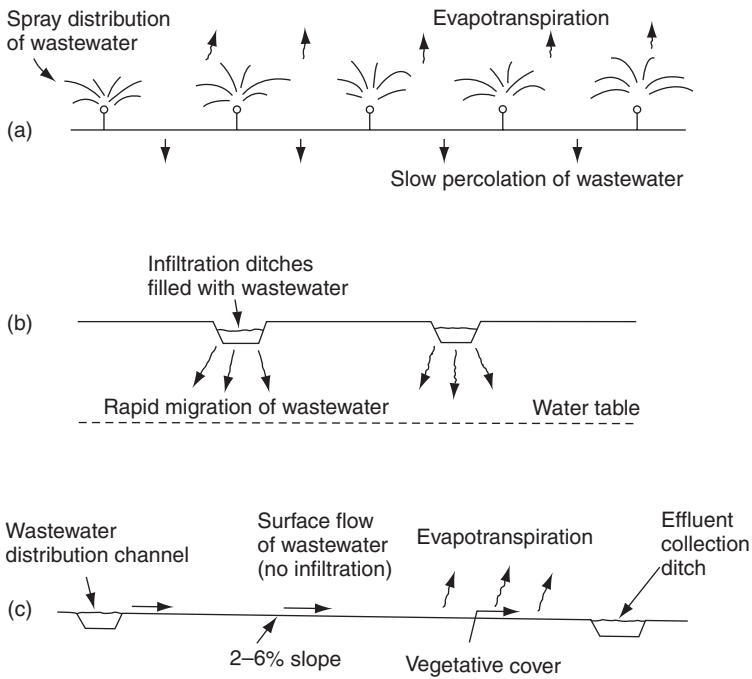

**Figure L.5** Examples of land treatment processes (a) slow rate using spray irrigation; (b) rapid infiltration; (c) overland flow using distribution channels.

the pipe to stop corrosion. A positive value of  $I$  implies that  $\text{CaCO}_3$  will be deposited on the pipe. The  $\text{pH}_s$  value can be calculated by measuring the **alkalinity**, calcium ion concentration, **total dissolved solids** and temperature of the water. The **chalk test** is not essential. The calculations are described in *Standard Methods for the Examination of Water and Waste Water*.

**lapse** In meteorology, the change of temperature, usually cooling, of air as its height increases.

**lapse rate** The rate at which air temperature changes with increasing height.

See *adiabatic lapse rate, environmental lapse rate, inversion, superadiabatic lapse rate*.

**LAQM** Local air quality management. See *air quality management areas*.

**larva** (plural **larvae**) An immature stage of an invertebrate insect or animal, developed from an egg, often shaped like a maggot.

**larvicide** A *pesticide* that kills *larvae*.

**LAS** *Linear alkyl sulphonate*.

**lateral sewer** A *collector sewer*.

**latrine** A basic toilet, probably with a squatting area rather than a toilet with a seat. See *aqua privy (Figure A.10), bucket latrine, pit latrine (Figure P.6), pour flush latrine, vault latrine (Figure V.2)*.

**launch pit** The pit or hole in the ground that is used to place and start the machinery for *impact moling* or *thrustboring*.

**launder** An open channel or trough that conveys water, such as the outlet channel from a sedimentation tank.

**laundry wastewater** The waste water from a large laundry has a high *turbidity*, a pH of 8 to 10 and a BOD<sub>5</sub> of 400 to 1000 mg/l. Water consumption may be about 35 litres per kg of clothes.

**LC50, LD50** The lethal concentration (LC) or lethal dose (LD) at which 50% of the organisms die when exposed to that concentration or dose of the substance. The exposure time is short at 48 hours or sometimes 96 hours. It is also known as the TLM (median tolerance limit) or MLD (median lethal dose). See *ED50, MLC, NOEC, TD50, toxic units*.

**LCA** *Life cycle analysis*.

**LC-MS liquid chromatograph mass spectrometer** The coupling of a high performance liquid chromatograph and a mass spectrometer. The chromatographic equipment separates the constituent compounds of the sample which are then analysed for their mass spectra. See *HPLC, mass spectrometry*.

**LD50** 50% lethal dose. See *LC50*.

**LDPE** *Low density polyethylene*.

**leachate, percolate** When water passes through a *landfill* it becomes contaminated with various organic and inorganic pollutants. This wastewater is known as leachate. Leachate generation occurs once the absorbent characteristics of the waste are exceeded. The leachate contains material dissolved from the landfill including Na<sup>+</sup>, Cl<sup>-</sup> and sulphate. Organic material in the landfill biodegrades to simpler organics which may be washed out in the leachate giving a BOD of several thousand mg/l. Some of the organic nitrogen in the fill decomposes to ammonia and the ammonia content of the leachate can be several 100 mg/l. Ferric compounds in the fill are reduced to more soluble ferrous ions and leachate may contain 100 to 1500 mg/l of Fe. The leachate also contains suspended solids and it has a brownish colour. As the organic material in the fill becomes more stabilised, the contaminants in the landfill decrease and the BOD reduces to less than 100 mg/l. The ammonia and iron content of the leachate also reduce substantially as the fill ages. See below.

**leachate control** *Leachate* control strategies include reducing the quantity of leachate and collecting and, probably, treating the leachate. Reducing leachate quantity is achieved by minimising the amount of water infiltration, possibly by including a *cap* of low permeability material (see *entombment landfill*). Waste consolidation increases the density of the fill and reduces the infiltration of water. The use of vegetation is important for leachate control. Vegetation holds back some precipitation and allows more time for percolation or evaporation or transpiration. The roughness of surface increases with vegetation and thus reduces velocities of surface runoff and reduces erosion. Vegetation increases the permeability of the top soil layers due to root development. This may lead to an increase in percolation rates. Appropriate

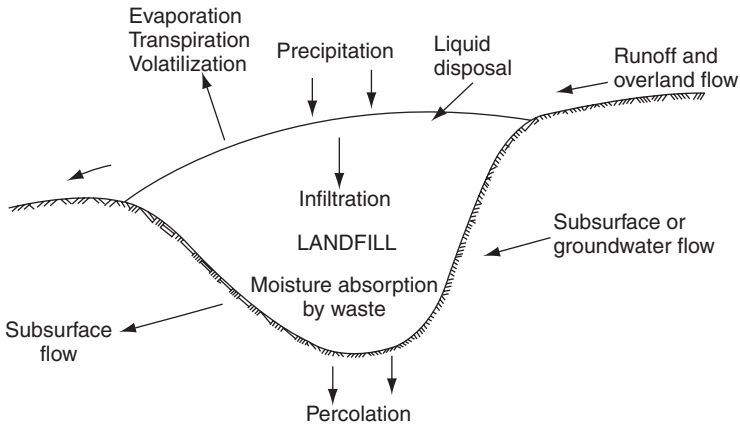

**Figure L.6** Leachate production—water balance of a landfill site.

use of vegetation may yield 50 to 70% reductions in leachate volumes. See *control by drainage*.

**leachate production** After the absorbent characteristics of the waste are exceeded, the quantity of *leachate* from a *landfill* is the water infiltration into fill from surface and subsurface sources plus the liquids discharged into fill. The infiltration equals the precipitation onto the landfill minus the runoff and evapotranspiration. As much as 90% of the precipitation may be lost in runoff and evapotranspiration from a completed landfill site. A summary of the water balance of a landfill site is given in *Figure L.6*.

**leachate recirculation** See *flushing bioreactor landfill*.

**leachate treatment** Polluting *leachate* may only exist for 10 to 30 years after the waste has been deposited. Also, the leachate characteristics change with the age of the fill. A common choice is *aerobic lagoons* with a retention time of about 20 days. Other choices include *overland flow land treatment*, although the efficiency can be difficult to predict without field trials and the soil must not be overloaded with toxic pollutants. See *flushing bioreactor landfill*.

**leach bed digestion** See *anaerobic digestion of municipal waste*.

**leachfield, leaching field** A field or area used for *soakaways* in the treatment of wastewater effluent or stormwater.

**lead, Pb** Lead is a toxic chemical whose compounds accumulate in the body. Lead is rarely found in natural waters except in the discharges from lead mines. The EU lists it and its compounds as a *priority substance* (under review for possible re-grading as a priority hazardous substance) in relation to aquatic discharges. See *Table D.2 Drinking water standards, lead in air, plumbosolvency*.

**lead dioxide, I. peroxide, PbO<sub>2</sub>** Lead dioxide has been used to compare the absorption of sulphur compounds in air between one month and another

- at a particular site. An area smeared with lead dioxide was left exposed in a louvered box for a month and the amount of sulphate found by analysis.
- lead in air** *Lead in petrol* (gasoline) was the major cause of lead in air. With the introduction of unleaded fuel, the ambient lead levels in air have reduced dramatically. The EU limit value for lead in air was  $2\mu\text{g}/\text{m}^3$  averaged over a year, but this is being reduced to  $0.5\mu\text{g}/\text{m}^3$ . In the USA, *NAAQS* has set a standard of  $1.5\mu\text{g}/\text{m}^3$  averaged over a 3 month period.
- lead in petrol (gasoline)** Tetraethyl lead used since 1923 and tetramethyl lead used since 1959 to raise the quality of petrol at low cost. The main source of lead in city air. Lead hinders the working of the *catalyst* in modern car exhaust systems which restricts *hydrocarbon* and *carbon monoxide* emissions.
- lead in water** See *plumbosolvency*.
- leaf test** The *filter leaf test*.
- leakage** The loss of water in the supply pipes can be 40% or higher. It is realistic to reduce this leakage rate to 20% loss during daytime, but difficult to reduce the leakage down to less than 10%. The benefits of leakage control are that less water requires to be treated and supplied together with an improved public profile of the water supply company. The estimate of leakage in a specific water supply zone can be made from measuring the minimum *night flows* entering a supply zone. The theoretical night flows are calculated and the difference is the excessive leakage.
- leakage control** The two main methods are either *water pipe rehabilitation* or *pressure management*.
- leakage detection** Leakage in pipes may be detected visually or possibly by apparatus that looks for the noise of the water leaking out of the pipe. *In situ* detection techniques include the use of a *Fibrescope* or *closed circuit television*. For *in situ* detection, the water main must be taken out of service and drained. It must be disinfected before recommissioning.
- lean burn engine** A petrol (gasoline) engine that is designed to operate on a higher than normal *air to fuel ratio*. This reduces the hydrocarbons and carbon monoxide in the exhaust gases.
- lean waste gases** A gaseous effluent from an industrial process that has significant but low concentrations of pollutants. For example, the  $\text{SO}_2$  content in the gas stream from a coal burning power plant is about 0.1%, too low for economic recovery as  $\text{H}_2\text{SO}_4$ . Compare *rich waste gas*.
- leaping weir overflow** A *combined sewer overflow* in which the flow that can go onto the wastewater treatment works falls down a hole in the *invert* and the excess flow leaps across the opening for discharge elsewhere. This type of overflow has a number of disadvantages, particularly possible clogging of the hole and too much water leaping over the hole at very high flows. Consequently it is not usually installed.
- leat, lade** An open channel or *catchwater* cut along a contour of a hillside, but with a slight fall, to bring water to drive a water wheel, into a reservoir etc.
- leather industry wastewater** See *tannery wastewater*.
- leech** A class of *annelids* which are quite tolerant of mild organic pollution.
- Legionella pneumophila** This bacteria can cause Legionnaires disease which produces a severe fever and pneumonia after incubation of 3–6 days in the

lung leading to some fatalities. Smokers are more prone to the disease. The bacteria grow and accumulate in slime layers in air conditioning cooling towers, hot and cold water taps, shower heads air conditioning systems, water storage tanks, etc. particularly at 25 to 45 °C. Water below 20 °C or above 55 °C prevents growth. Transmission is by inhalation of airborne bacteria or contaminated water droplets. If *Legionella* is present then the system must be cleaned, including removal of slime layers, and then the water system is disinfected. A temperature of greater than 70 °C kills the bacteria.

**Legionnaires disease** See *Legionella pneumophila*.

**lentic** Concerned with still waters.

**Leopold filter bottom** Rectangular perforated burnt clay blocks used as *under-drains* for *filters*.

**Leptomitus lacteus** A member of *sewage fungus* in rivers, a true aquatic fungus.

**Leptospira icterohaemorrhagiae** Bacteria belonging to the *spirochaetes*, carried to man by rats, which excrete them in their urine, causing *leptospirosis*.

**leptospirosis, spirochaetosis, spirochaetal jaundice, Canicola fever, Weil's disease** An acute bacterial infection caused by *Leptospira interrogans*, of which there are many serotypes but *L. interrogans icterohaemorrhagiae* and *L. interrogans canicola* are the main organisms causing human disease, being responsible for Weil's disease and Canicola fever respectively. Symptoms include fever, vomiting, muscular pains, jaundice and eventually kidney dysfunction. Transmission is by contact with water contaminated by urine of infected animals, particularly rodents, normally by ingestion of the water or possibly by penetrating an existing wound on the skin. Control is by the use of protective clothing amongst high risk groups, such as those working in sewers. Treatment of patients may be only partially effective.

**Leptothrix** A filamentous *iron bacterium* found in organically polluted water, which may grow in the absence of iron.

**lethal concentration, lethal dose** See *LC50*.

**Leucothrix** Filamentous *heterotrophic* bacteria associated with *bulking* sludge.

**Leuctra** A species of *stone fly* found in well aerated water with no organic pollution, although it may tolerate pollution by *heavy metals*.

**levee** An earth bank.

**licensing of landfill sites** See *landfill site licensing*.

**lichen** A dual organism of green algae and fungus which are in *symbiosis*, living attached to rocks or trees. It is an early coloniser of bare rocks.

**life cycle analysis, l. c. assessment, LCA** An *environmental management system* in which the environmental effects of a product are assessed and monitored from the raw materials acquisition, through production, use, refurbishment and disposal.

**lift** In a landfill, the height of the completed layer of waste plus the daily or intermediate cover. It is the height of the completed *cell (1)*. Typically the height of one lift is 2 to 3 m.

**lift station** A pumping station.

**light non-aqueous phase liquids** See *non-aqueous phase liquids*.

**light obscuration instrument** A *smoke density meter*.

- light oils, light refined petroleum products, white products** Motor spirit and similar liquids, which are the most toxic of all petroleum cargoes. They are dangerous to marine life when spilt in the sea. However, they evaporate quickly.
- lignin** A strong, rigid, complex, not easily *biodegradable* substance which, with *cellulose*, makes up most of wood and some wood products such as paper and cardboard.
- lime** Strictly calcium oxide (CaO; quicklime), but often meaning *calcium hydroxide* (Ca(OH)<sub>2</sub>; slaked lime). *See below.*
- lime soda softening of water** During *lime softening* or *excess lime softening*, soda ash (Na<sub>2</sub>CO<sub>3</sub>) may be added to remove *non-carbonate hardness* by forming precipitates of *calcium carbonate* and magnesium hydroxide. The magnesium hydroxide is precipitated only in conjunction with excess lime softening.
- lime softening** A common method of *water softening*. *Lime* is added to the water before *clarification*. It reacts with the *calcium bicarbonate* dissolved in the water to form a precipitate of *calcium carbonate*. After clarification the water contains 20 to 40 mg/l of dissolved calcium carbonate, some of which may slowly deposit on the walls of the pipes in the distribution system. *See excess lime softening.*
- lime stabilisation, lime treatment of sludge** The addition of lime to raise pH of wastewater sludge to greater than 12.0. The pH must be not less than 12 for a minimum period of 18 to 28 days in order to kill 99% of the bacteria and almost all the viruses. The sludge is then reasonably safe from microbiological hazards and appropriate for land application. *See N-viro process.*
- limestone wet scrubber** The use of limestone to remove SO<sub>2</sub> from gases. The limestone reacts with the SO<sub>2</sub> to produce CaSO<sub>4</sub>. *See flue gas desulphurisation and Figure F.5.*
- limit of resolution, resolving power** The size of the smallest object that can be seen through a microscope, telescope, etc. In the *optical microscope* it is about 0.25 µm or 250 nm; in the *electron microscope* about 0.1 nm. Some microbes are more difficult to see than others.
- limit values** *See emission limit values.*
- limnobiote** Description of freshwater life.
- limnology** The study of freshwater rivers, lakes or ponds; compare *potamology*.
- Limnoperna fortunei*** A *freshwater mussel* that infects water *mains* in warm climates, breeding for 10 months of the year, unlike *Dreissena polymorpha* in colder countries, which breeds only for 2 to 3 months.
- limnoplankton** Freshwater *plankton*.
- Lindane** *Hexachlorocyclohexane*.
- linear alkyl sulphonate, LAS** A biodegradable (soft) *synthetic detergent* used since 1965. It has replaced *alkyl benzene sulphonates* which were poorly biodegradable. LAS is the basis of most household detergents.
- linear induction separator** An *eddy current separator*.
- liner** *See landfill liner.*
- lining** For lining of water pipes and sewers, *see cement mortar lining, close fit lining, epoxy lining, rolldown, sliplining, soft lining, swagelining*. For lining of landfills, *see landfill liner.*

**Linpor process** See *suspended immobilised biomass reactors*.

**linuron** A widely used herbicide.

**lipids** A collective name for fats, oils and waxes.

**liquid chlorine** Chlorine liquefies at  $-34.6^{\circ}\text{C}$  at atmospheric pressure. At ambient temperatures it is sold as a liquid under pressure in cylinders. It is used widely as a water *disinfectant* in *chlorination*. It is a hazardous chemical. The term liquid chlorine has been applied to sodium hypochlorite solutions.

**liquid chromatograph** See *HPLC, LC-MS*.

**liquids cyclone** A *wet cyclone*.

**liquid extraction** See *solvent extraction*.

**liquid injection incinerators, LI incinerators** Many hazardous waste incinerators use liquid injection. The liquid hazardous waste is pumped or injected into the combustion chamber. Auxiliary fuel may also be required. The temperature in the incinerator may be from 1000 to 1700°C.

**liquid wastes** The EU *Landfill Directive, 1999* states that it is a waste in liquid form but excluding sludges. The Directive does not allow liquid wastes to be accepted at a landfill. See *co-disposal*.

**list 1 substances, black list substances** A European Union list of hazardous and highly toxic substances with the aim of eliminating them from effluent discharges. The EU sets emission standards and *environmental quality objectives* for these substances. This list has been superseded by the *priority hazardous substances* list. (see *Table P.1*). Compare below, *red list*.

**list 2 substances, grey list substances** A European Union list of hazardous and highly toxic substances with the aim of reducing them from effluent discharges. Member States of the EU set emission standards and pollution reduction programmes for these substances. This list has been superseded by the *priority substances* list. (see *Table P.1*).

**listed wastes** In the USA, hazardous wastes that appear on the *USEPA* hazardous waste designation system.

**lithium salts** Lithium is rare in water or waste water and its salts are readily soluble. Therefore it is a useful chemical tracer. Lithium chloride or sulphate is often used. Lithium can be measured by *flame photometry*.

**lithostatic pressure** *Overburden pressure*.

**lithotroph** Literally 'stone eating'; bacteria such as *Thiobacillus* are lithotrophs, because they eat inorganic materials like mineral sulphides, including even *hydrogen sulphide* gas.

**Litonotus** This predator, a free swimming *ciliate protozoon*, is found in *activated sludge* and among *plankton*.

**litter control** At a landfill site, litter should not spread from the workface, but this may occur due to poor site operation or windy conditions. See below, *windblown refuse*.

**litter fence** A movable, wire mesh fence set up on the lee side of a *landfill* so as to catch windborne paper, plastics film, etc. There may be several, one behind another. The litter caught on the fences must be periodically removed or a strong wind will blow the fence down.



**littoral zone** (1) The *inter-tidal zone* of a beach. (2) The shallow part of a lake, where rooted vegetation still grows.

**live capacity** The volume of a reservoir that can be used for storing raw water, and from which water can be withdrawn. It is the total volume of the reservoir minus the *dead storage*.

**livestock wastewater** See *agricultural wastewater*.

**Lloyd-Davies method** See *rational method*.

**LLDPE** Linear low density polyethylene; a material that is used in plastic films.

**LNAPLs** Light non-aqueous phase liquids. See *non-aqueous phase liquids*.

**loading units** A method described in BS 6700 that can be used in the calculation of the size of water pipes in buildings. A number, known as a loading unit, is allocated to each appliance (toilet, bath, sink, etc.) depending on the expected usage of that appliance. The number of loading units is then aggregated to give a total for any particular part of the building. The loading unit is then related to a flow using a chart and thereby the correct pipe size can be chosen.

**load on top system** See *oil tanker washings*.

**LOAEL** Lowest Observed Adverse Effect Level. See *LOEC*.

**Local Agenda 21** See *Agenda 21*.

**LOEC, LOEL, Lowest Observed Effect Concentration, Lowest Observed Effect Level** The lowest concentration or dose of a toxic chemical that causes an effect (LOEC, LOEL) or an adverse effect (LOAEL) in a specific living organism. See *NOEC*.

**lofting** Lofting describes a specific shape of a plume from a chimney (see *Figure P.7*). It occurs during transient conditions such as the ground cooling down after a warm day. This can cause an *inversion* at lower levels but a more normal *lapse rate* with mixing at higher elevations. Air pollutants disperse in an upward direction.

**logarithmic growth, exponential g.** A *growth phase of microbes* that involves very rapid increase in the numbers of a population. For bacteria it means that there is no limitation of food. If a bacterium reproduces itself every 30 minutes and its successors also do so, the growth will be logarithmic and after a day there will be  $2.8 \times 10^{14}$  or 280 million million which have grown from one bacterium.

**log Kow** Logarithm of the *octanol water partition coefficient*.

**loiasis** A type of *filariasis* caused by the nematode *Loa loa* and mainly found in tropical African regions. The worms may enter the eye tissue where they may be seen. The disease is spread by the bite of *Chrysops* flies which tend to breed in shaded stagnant water.

**London smog** Coal smoke contained in thick yellowish *fog*, causing coughing, smarting of the eyes and blackening inside the nose. In the smog from 5 to 9 December 1952 there was, as usual with fog, an *anticyclone*, and the air temperature was from 0° to minus 6°C. Nearly 4000 people in London died from respiratory illnesses. Domestic burning of coal was the main cause of the pollution. As a result eventually the *Clean Air Act 1956* banned the burning of smoky coal in smokeless zones and smog is no longer expected in London.

- long term exposure limits, LTEL** An *occupational exposure limit* over a working day or working week. Short term exposure usually relates to occupational exposure over a period of minutes.
- looping** Looping describes a specific shape of a plume from a chimney (see *Figure P.7*). It occurs during *super adiabatic lapse rate* with very unstable air. It causes erratic dispersion of pollution which may lead to localised severe air pollution at ground level.
- loose fit liner** See *sliplining*.
- lotic** Concerned with flowing water.
- low density polyethylene, l. d. polythene, LDPE** A *thermoplastic* which is used to make light dustbins, bin liners, squeeze bottles, etc. It is the largest component of plastic material in municipal waste. It has a density less than 0.94 g/cc, which is lower than medium or high density polyethylene.
- low-dig techniques** Pipeline placement or renewal techniques that minimise the digging requirement, such as *mole ploughing* or *narrow trenching*. See *trenchless technology*.
- low energy scrubber, low pressure drop s.** A *wet scrubber*, such as a *plate tower scrubber* or *spray chamber*, that collects the dust from 5 µm in size. The effect on pressure drop across the equipment is low.
- Lowest Observed Effect Level, LOEL, Lowest Observed Adverse Effect Level, LOAEL** See *LOEC*
- low level radioactive waste** Radioactive waste with activities less than about  $0.2 \times 10^{-6}$  curies per litre (one curie equals  $3.7 \times 10^{10}$  becquerel). This waste may be stored in engineered containment structures until the radioactivity has declined.
- low rate filter** A standard rate *trickling filter*.
- Loxophyllum** A *ciliate protozoon* found in *activated sludge* where *nitrification* is well established.
- LSI** The *Langelier saturation index*.
- LTEL** *Long term exposure limit*.
- lugworm, Arenicola** A beach worm that has been used for measuring the toxicity of crude oil and of beach *dispersants*. It is convenient because one wormcast on the sand corresponds to one buried worm.
- lumbricid, Lumbricidae** Large worms that include the common earthworm. Some members graze in *trickling filters*.
- Lumbriculidae** Small thin worms which may be numerous in *trickling filters* as *grazing fauna*.
- luxury uptake of phosphorus** See *biological phosphorus removal*.
- LV** *Limit Values* See *emission limits values*.
- lysimeter** An enclosed volume of soil and plants arranged in a tank so that they can be weighed periodically or continuously. The lysimeter is in the open so that the rainfall, *runoff* and *groundwater* flow can be measured and the *evapotranspiration* determined.
- lysis** (verb *lyse*) Disintegration; the word describes the death and break up of a cell, making its *protoplasm* available as food for its neighbours. See *autolysis, cryptic growth, endogenous respiration*.

**M** Symbol for mega-, one million times or  $10^6$ .

**m** Symbol for milli-, one-thousandth or  $10^{-3}$ .

**MAC** *Maximum admissible concentration.*

**MacConkey's broth** A bacterial *medium* that is *selective* for *coliforms*, used in *bacteriological examination* of water and waste water. It consists of salts, peptone, lactose, sodium chloride and a pH indicator. Coliform bacteria ferment this broth at 37 °C to produce a gas and an acid which is shown by the solution changing from purple to yellow, with a bubble of gas collected in a small Durham tube. At 44 °C *E. coli* is the dominant coliform that produces acid plus gas in MacConkey's broth.

**macerator** (1) A *screenings disintegrator*. (2) A *garbage grinder*.

**macroalgae** Seaweeds.

**macrobiota** The larger organisms in soil, including plant roots, larger insects and earthworms. *Compare microbiota, mesobiota.*

**macroencapsulation** In *encapsulation* of hazardous waste, the waste is contained within the macro-structure of the encapsulating material, e.g. the waste is held within the pores of a cement mortar structure. *Compare microencapsulation.*

**macroinvertebrates** Small animals without a backbone that can be seen by the unaided eye, e.g. species of flies, worms, leeches, snails, beetles, etc. These animals can be useful in describing the level of pollution in a river. *See biotic index.*

**macrophytes** Aquatic plants, growing in or near water. They are beneficial because they provide cover for fish, substrate for aquatic invertebrates and they also produce oxygen. *See Water Framework Directive, 2000.*

**macroscopic** Description of what can be seen with the naked eye.

**MACT** *Maximum Achievable Control Technology.*

**magnesium, Mg** Although usual in hard waters, magnesium is almost always present in water in a much smaller concentration than *calcium*. WHO states that its maximum should be reduced if sulphate is present, since magnesium sulphate,  $MgSO_4$ , is the purgative, Epsom salt. At 250 mg/l of  $SO_4$  the desirable maximum of Mg is 30 mg/l. *See water softening.*

**magnesium ammonium phosphate** *See struvite.*

**magnetic pulley** A *magnetic separator* in the form of a return pulley at the end of the belt conveyor that carries municipal refuse from the *trommel*. Less expensive than the *overband separator*, it is also less efficient and removes more rags and paper. It can also damage the belt by dragging nails or other sharp metal pieces between it and the belt.

**magnetic separators** Devices to extract iron and steel from material carried past them on a conveyor belt. They are usually operated electromagnetically but sometimes by permanent magnets. There are four main types: the *overband separator*, the *magnetic pulley*, the *rotary screen magnet* and the *multipole overband separator*. The last helps to reduce the amount of rags and paper extracted with the iron and steel. Magnetic separation is often preceded by *air classification* and *shredding*.

**magnification in a food chain** *Biomagnification*.

**main** An important pipe, often one carrying water. If buried, it should have at least 0.9 m of earth cover as frost protection. See *ring main*, *secondary main*, *service main*, *trunk main*.

**mains rehabilitation** See *water pipe rehabilitation*.

**make up water** The proportion of the *feed water* that is needed to make up the losses of water in a boiler system.

**malaria** A tropical disease caused by the *parasitic, spore forming protozoa Plasmodium* and transmitted by the *anopheline mosquito*. To transmit the parasite to humans the mosquito must bite a person at a particular stage in the life cycle of the protozoon. The protozoa develop in the mosquito, entering the human from its salivary glands.

**Malayan filariasis** See *filariasis*.

**M alkalinity** Methyl orange alkalinity, i.e. *total alkalinity*.

**Malta fever** *Brucellosis*.

**Mammoth rotor** A *brush aerator* 1 m in diameter with a horizontal drive shaft, similar to the *TNO rotor*. It has been used in *oxidation ditches* serving populations from 10 000 to 250 000. Mammoth rotors can be used in aeration channels 2 to 4 m deep. A single rotor may be from 4.5 to 9 m long. At maximum immersion the gross power required is about 5 kW per m length of rotor.

**manganese, Mn** If oxygen is present manganous ( $Mn^{2+}$ ) salts readily oxidise to the less soluble manganese dioxide which is a dark brown precipitate. However, in anaerobic conditions soluble manganous compounds predominate. Waters from lakes or reservoirs may have several mg/l of manganese. Manganese is toxic at high concentrations, but not at the concentrations normally found in natural waters. Concentrations of 0.05 mg/l can stain clothes in washing machines or spin dryers. If manganese is present in the water during distribution, the growth of manganese oxidising bacteria in the pipes may be stimulated. The removal of manganese in water treatment is by oxidation to manganic compounds and removal of the manganic precipitate by sedimentation or filtration. The oxidation involves adjustment of the pH to make the water alkaline, aeration and possibly addition of oxidising agents such as chlorine. Manganese removal can be achieved by the growth of manganese oxidising bacteria in a *packed bed filter* (see *biological manganese removal*). See *Table D.2 Drinking water standards*.

**manganese greensand** *Greensand* that has manganese dioxide coated on its surface. It is an oxidising agent and can be used in the oxidation and precipitation of iron and manganese. It is regenerated by passing a solution of potassium permanganate through the greensand.

**manhole** (1) An access opening into any tank, boiler, etc., large enough for a person to pass through. (2) Or inspection chamber. A vertical shaft giving access to a sewer or to an underground duct, so arranged that a man can enter from the surface. In small sewers, less than 1 m diameter, manholes should be provided at every change of direction but not further apart than 90 m on straight lengths, because 45 m is about the greatest length that can be rodded. On large sewers, through which a man can walk, the maximum spacing can be 120 m, so that a sewerman need never be further than 60 m from a manhole. *See backdrop, rodding.*

**manifest hazardous waste** *See Uniform Hazardous Waste Manifest.*

**Manning formula** A formula used in evaluating *open channel flow*, for example in sewers:

$$V = \frac{1}{n} R^{2/3} S^{1/2}$$

where  $V$  = velocity (m/s),  $R$  = *hydraulic mean radius* (m),  $S$  = *hydraulic gradient* and  $n$  is Manning's roughness coefficient.

**manometer** A pressure measuring instrument consisting of a U-tube containing a liquid or system of liquids. When one leg of the U is under higher gas pressure on its surface than the other, the liquid in it is correspondingly lower. The difference in liquid level corresponds to the pressure difference between the liquid surfaces.

**MAP** Magnesium ammonium phosphate. *See struvite.*

**marble test** The *chalk test*.

**Margalef's index** A *diversity index*. If  $S$  is the number of species and  $N$  is the total population. The index equals  $(S - 1)/\log_e N$ .

**marine pollution** *See MARPOL, North Sea conferences, oil pollution, Oslo convention.*

**MARPOL** The International Convention for the Prevention of Pollution from Ships. MARPOL covers a range of pollutants that may emanate from ships. These include oil, noxious liquids, packaged foods, wastewater and garbage. Although agreed in 1973, it was not ratified until 1978 and enacted in 1983.

**mass balance** Matter is always conserved. In waste treatment, all the material going into a treatment process must come out somewhere. In an *incinerator*, the matter going in as waste comes out as gases or particulates in the ash or washed out in the *wet scrubbers* etc. In a sedimentation tank, the mass of solids going into the tank either come out in the sludge or are washed out with effluent.

**mass burn incineration** Large solid waste *incinerators* that have throughputs typically in excess of 10 tonnes per hour. The combustion occurs in a single chamber. *See Figure I.2.*

**mass curve** In *hydrology*, a graph of the cumulative volumes of *runoff* or other flows, plotted as ordinates against time. The curve may be used to estimate the storage capacity needed by a reservoir to supply a given flow.

**mass spectrometry, MS** An analytical technique in which the analyte is converted into the gaseous phase and then ionised. The ions are separated and measured

by their mass to charge (m/e) ratio. The ionisation of the gas can be from impact by high speed electrons. The apparatus is operated at low pressures ( $10^{-7}$  bar). The electrons fragmentise the compound being analysed. An alternative ionisation route is by chemical ionisation in which a reagent gas, such as methane, is ionised and then brought into contact at low pressure with the analyte which it ionises. *ICP* has also been used to generate the ions (ICP-MS). The mass analyser of the ionised gas incorporates varying magnetic fields or electric fields or other techniques to give variable bends to the path of the positive gas ion fragments of the analyte. The ions that leave the mass analyser are measured electronically at the collecting plate, which can scan the spectra over a wide range of masses as the magnetic or electrical field is varied in the mass analyser. It is a powerful analytical technique, as the mass spectra are unique for a particular compound under specific operation conditions of the MS. Detection limits are low, but the compound to be analysed must be able to be vaporised into the gaseous phase otherwise analysis is not possible. A mass spectrometer may be coupled with a *gas chromatograph* (GC-MS) or *HPLC* (LC-MS). The chromatographic equipment separates the constituent compounds of the sample which are then analysed for their mass spectra.

**Mastigophora** The *flagellate protozoa*.

**materials balance** *Mass balance*.

**materials recycling** *See waste recycling*.

**materials recycling facility, materials recovery facility** A facility for recovering reusable waste material, such as metal, plastics, etc. If the domestic waste is mixed the cost of separating out the reusable material is expensive. A typical facility for sorting mixed domestic waste and may include *mechanical sorting plant* with *screens, trommel* (Figure T.4), *magnetic separator* (e.g. Figure O.2), *eddy current separator, air classifier* (Figure A.5). It may include *pulverising* or *shredding* and also some manual sorting or 'picking'. The remaining waste after segregation is mainly organic which can be used to produce *refuse derived fuel*. A more appropriate approach is to have the householder separate the waste at source (*see separation at source*) and then the waste can be more easily processed and recovered at the recycling facility to give more economic *waste recycling*.

**maturation pond** An aerobic *waste stabilisation pond*, usually following a *facultative pond*, typically 1 to 3 m deep. Two maturation ponds in series, each with a retention time of 7 days may be needed after facultative ponds to reduce the final effluent BOD<sub>5</sub> to 25 mg/l. Algae are fewer in maturation ponds than in facultative ponds and even fish may be present in the last maturation pond. The *organic loading* of the maturation pond is usually less than 15 kg of BOD<sub>5</sub> per hectare of pond area per day when the pond is part of a waste stabilisation pond treatment system. Maturation ponds are used for *tertiary treatment* of a wastewater. In this case the retention time is about 2 days and the organic loading is about 100 kg of BOD<sub>5</sub> per hectare of pond area per day.

**maturing** (1) Or ripening. Of a *trickling filter*, the process of acquiring a balanced population of bacteria, etc., to purify the wastewater passing through it. A new trickling filter may take 6 months to mature in a cold

- winter but only a few weeks in warm weather. The term is also used of an *activated sludge* process that is starting, but mature sludge can be introduced from another *aeration tank* to assist the process. (2) Of compost, *curing*.
- Maximum Achievable Control Technology, MACT** In the USA, a term given to the technology that can achieve the minimum hazardous air pollution concentration from an industrial process. MACT can include alterations to the industrial process, different use of materials in the process or air pollution control equipment.
- maximum admissible concentration, MAC** The EU *Drinking Water Directive* of 1980 defined the maximum admissible concentration and guideline values for a range of chemicals and microbiological parameters in drinking water in the EU. This system has been replaced by the 1998 Drinking Water Directive.
- maximum contaminant level, MCL** The enforceable standards set by the *USEPA* for drinking water quality in the USA. Most of the standards are in concentrations but some are quoted as TT, which means that a specific treatment technology is prescribed to remove this contaminant from the water if it is present. Guideline standards (maximum contaminant level goals, MCLG) are also given. The goal for all carcinogens is zero. The MCLs for various inorganics are listed in *Table D.2 Drinking water standards*. Various MCLs for organic chemicals are listed under the specific compound.
- maximum extent practicable** A USA term in *urban pollution management*, to ensure the maximum possible reduction of pollutants in urban runoff.
- maximum tolerated dose, MTD** The dose of toxic material that induces slight signs of toxicity in the animal, but does not increase mortality.
- mayflies, Ephemeroptera** Water insects that are on the wing in May and are eaten by trout. Their presence, except for *Baetis rhodani*, normally shows that the water is unpolluted. They may be used in a *biotic index*.
- MBAS, MBS** *Methylene blue active substances*.
- MBF** A *moving bed sand filter*.
- MBR** A *membrane bioreactor*, but possibly means a *moving bed reactor*.
- MCB** *Monochlorobenzene*.
- McGowan strength** A measure, no longer used, of the strength of wastewater estimated from the expression  $4.5N + 6.5P$ , in which N is the *ammoniacal nitrogen* plus *organic nitrogen* and P is the *permanganate value* using N/8 *potassium permanganate*. The factor 6.5 varies in accordance with the industrial waste content in the wastewater.
- MCL** *Maximum contaminant level*.
- MCLG** Maximum contaminant level goal. See *maximum contaminant level*.
- MCPA** See *chlorophenoxyacetic acids*.
- MDPE** *Medium density polyethylene*.
- MDR** *Multiple drug resistance*.
- MDTOC** *Minimum detectable threshold odour concentration*.
- mean cell residence time, MCRT, solids retention time, sludge age, cell age,  $\theta_c$**   
The total sludge in a biological treatment process divided by the daily waste (excess) sludge. Thus for an *activated sludge* plant:

$$\theta_c = \frac{\text{aeration tank volume (m}^3\text{)} \times \text{MLSS (mg/l)}}{(\text{Q}_W \times \text{SS}_W) + (\text{Q}_E \times \text{SS}_E)}$$

Where,  $Q_W$  is the flow of waste sludge ( $\text{m}^3/\text{d}$ );  $\text{SS}_W$  is the suspended solids in the waste sludge ( $\text{mg/l}$ );  $Q_E$  is the flow of effluent ( $\text{m}^3/\text{d}$ );  $\text{SS}_E$  is the suspended solids in the effluent ( $\text{mg/l}$ ). The units are days. The formula is often simplified by ignoring the value  $Q_E \times \text{SS}_E$ , because this is small compared to the value  $Q_W \times \text{SS}_W$ . In the USA, the calculation uses volatile suspended solids (VSS) rather than suspended solids (SS). As about 70% of the activated sludge is volatile, VSS is about  $0.7 \times \text{SS}$ .  $\theta_c$  has been related to  $F : M$ , which for a conventional activated sludge plant is

$$F : M = \frac{3}{2\theta_c} + 0.1$$

Typical  $\theta_c$  values for the activated sludge process are 5 to 10 days for 95% removal of BOD. *Extended aeration* plants may operate at a  $\theta_c$  of 20 days. For *anaerobic sludge digestion*, with no sludge recycle,  $\theta_c$  is equal to the *hydraulic retention time*.

**meat processing wastewater** Liquid wastes derived from slaughtering, cooking meat or rendering bones and offal into lard or grease. Although blood is often recovered as a rich source of *protein*, slaughtering wastes remain reddish brown. The  $\text{BOD}_5$  varies around 2000 to 5000  $\text{mg/l}$ . To reduce the amount of solids, the waste should be screened before entry to the sewer. Meat cooking wastes are usually less polluting but still have a high grease content. *See grease trap.*

**mechanical aeration** The use of *surface aerators* or *turbine aerators* in *activated sludge* treatment, *aerated lagoons*, etc.

**mechanical collector** This vague term for *inertial separation* of any type is usually reserved for *cyclones*.

**mechanical composting** *See in-vessel composting.*

**mechanical dewatering of sludge** Dewatering of sludge that uses a mechanical device such as *belt filter press* (Figure B.5), *centrifuge* (Figure C.3), *filter plate press* (Figure F.3), tube press, vacuum filter (Figure V.1), etc. For wastewater sludges, belt filter presses and centrifuges are common. The filtrate from the dewatering of wastewater sludge can have a high BOD. Dewatering of raw wastewater sludge is very malodorous. Waterworks sludges are difficult to dewater and filter plate presses are often chosen.

**mechanical filtration** This may mean one of several things: *mechanical dewatering of sludge*, *microstraining*, use of a *pressure filter* (2) or *screening*.

**mechanical flocculation** A common method of *flocculation*, capable of improving the clarity of raw water or wastewater by the gentle movement of a *picket fence stirrer* or of paddles at speeds of the order of 70  $\text{mm/s}$  for 15 minutes. It is usually used after *coagulation* and then followed by *clarification* or *dissolved air flotation*.

**mechanical sludge dewatering** *Mechanical dewatering of sludge.*

**mechanical sorting plant, mechanical separation p., automatic separation p., mechanised reclamation p.** Equipment which separates iron, steel, glass,



plastics, etc in a *materials recycling facility* for mixed municipal waste. The mechanical sorting may include *screens*, *trommel* (Figure T.4), *magnetic separator* (e.g. Figure O.2), *eddy current separator*, *electrostatic separator* (Figure E.5), *air classifier* (Figure A.5). See also *inertial separator*, *refuse derived fuel* (Figure R.4), *rising current separator*.

**mechanically stirred grit trap** *Vortex grit separator*.

**media** Plural of *medium*.

**median lethal concentration, m. l. dose** See *LC50*.

**median tolerance limit** See *LC<sub>50</sub>*.

**medical waste** See *clinical waste*.

**Medina worm** *Guinea worm*.

**medium** (plural **media**) (1) Or culture medium. In the laboratory, bacteria or other microbes grow in a favourable environment—a medium—which may be liquid, using water (aqueous), or solid, using *agar agar*. Solid media allow the microbes no movement but local growth clusters or colonies can exist. Media contain all the necessary foods and are held at the right temperature, pH, salinity and dissolved oxygen content, and are autoclaved or tyndallised beforehand. *Non-selective media* allow the growth of all types of bacteria. *Selective media* encourage one group either by the lack of an ingredient needed by the others or by the presence of one that harms all the others. Thus, if organic compounds are left out, the medium is selective for *autotrophs*. If bile salts are put in, the medium is selective for intestinal bacteria. See *autoclave*, *culture*, *slope tyndallisation*.

(2) Or packing. The clinker or stones or *plastic media* that fill the space in a *trickling filter*, *anaerobic filter*, etc. and provides surfaces on which the *microbes* can live and form a *biofilm* (3) Or porous septum. In a true *filter*, the strainer that collects solids from the fluid being filtered. It may be sand or other mineral grains in a *rapid deep bed filter*, or a *membrane*, or a filter cloth.

**medium density polyethylene, m. d. polythene, MDPE** A *thermoplastic* plastic which has a density of between 0.945 to 0.955 g/cc, which is lower than *high density polyethylene* (HDPE), but greater than low density polyethylene. It is light and flexible. It may be used for landfill liners but HDPE is more common. MDPE can be used for irrigation pipes, but water pipes and sewers normally use HDPE. MDPE is sometimes used for *sliplining* as a *water pipe rehabilitation* technique.

**medium screen** In water and wastewater treatment, a *screen* with openings of 15 to 40 mm.

**megalitre** One million litres, 1000 m<sup>3</sup>, 1000 t of water.

**melanosis** A skin condition caused by excessive deposits of melanin and resulting in discoloration of the skin.

**membrane** A skin. A membrane filter is consequently one of skin thickness, but the term usually means a *polymer* membrane as used in a *membrane process*. Compare *membrane filtration*; see *semi-permeable membrane*.

**membrane bioreactor, MBR** A biological treatment process for wastewater where a *membrane process* is used for separation of the biomass and the treated effluent. The effluent should contain no suspended solids or bacteria.

**membrane electret** A *membrane* filter with a permanent internal electrical charge.

**membrane filtration** (1) A method of direct counting of coliform or other bacteria in water. A measured diluted volume is filtered through a *membrane* of pore size small enough (0.45  $\mu\text{m}$ ) to hold back bacteria. The membrane is then incubated face upwards in a *selective medium* at a suitable temperature and after 18 h the colonies that have developed are counted. As in the *most probable number* method, these counts are only an estimate. Counting is done under a hand lens and suspect colonies can be transferred to liquid or solid *medium* for confirmation of their properties. Membrane filters are also used for sampling algae or for concentrating bacteria from a water in which they are known to be scarce—e.g. a drinking water, where the expected count is less than about 30 bacteria per ml. (2) The use of a *membrane process* to treat water or wastewater.

**membrane fouling** Membranes used in *reverse osmosis* (RO) or *nanofiltration* should last 5 years. However, the membrane may become fouled by suspended matter or bacteria growing on its surface. The inlet water may require treatment (e.g. coagulation, filtration and disinfection) prior to RO or nanofiltration. *Polyamide* membranes used in RO can be attacked by chlorine and so excess chlorine must be removed i.e. *dechlorination*. Salts may precipitate on the salty side of the membrane due to *concentration polarization*. This also causes membrane fouling.

**membrane hyperfiltration** *Reverse osmosis*.

**membrane liners** See *geomembranes*, *landfill liner*, *synthetic liner*.

**membrane press, m. plate press, diaphragm press, variable volume filter press**  
An adaptation of the *filter plate press* in which one side of the filtration chamber is lined with a flexible rubber membrane behind the filter media. At the end of the pressing cycle, air is pumped into the membrane which expands adding extra pressure to further dewater the sludge. The time of the pressing cycle is reduced and the membrane expansion completes the dewatering. The sludge throughput can be increased compared to a traditional filter plate press but the maintenance can be higher.

**membrane processes** Various processes use *semi-permeable membranes* to hold back salts or fine solids or pathogens in order to remove these components from water or wastewater. *Reverse osmosis* is a popular method for *desalination*. *Microfiltration*, *nanofiltration* and *ultrafiltration* can be used in water and wastewater treatment for the removal of colloids or colour or pathogens. *Electrodialysis* uses membranes plus a voltage and can be used for desalination. See *above*, *concentration polarisation*, *ion exchange membranes*, *membrane fouling*, *pervaporation*.

**membrane softening** The use of *membrane processes* such as *nanofiltration* in order to remove the ions causing *hardness* in water.

**Menhinick's index** A *diversity index* which equals the number of species divided by the square root of the total population.

**meq/litre** *Milligram equivalent per litre*.

**mercaptans** Organic compounds containing a sulphur hydrogen group—i.e. a sulphur and a hydrogen atom attached to the carbon chain. They often have an unpleasant smell.

- mercury** A heavy metal that is highly toxic to humans causing kidney malfunction and affecting the central nervous system. It bioaccumulates and has been responsible for death in birds. Mercury poisoning of humans has occurred, for example humans eating fish from water in which the mercury has undergone *biomagnification* up the food chain. Mercury may be present in certain industrial wastewaters. It may be released into the air from incinerators. The EU lists it and its compounds as a *priority hazardous substance* in relation to aquatic discharges. See *Table D.2 Drinking water standards*.
- meringue dezincification** *Dezincification* that shows a voluminous white crust.
- meromictic** A term that describes a lake that remains unmixed for much or all of one year.
- meroplankton** Sea bed organisms that spend the egg and larval stages of their lives as *plankton*, unlike *holoplankton*.
- mesh sizes** The mesh numbers used in the past to describe sieve openings indicated the number of holes (or wires) per lineal inch; thus, a higher number had smaller openings. The diameter of the wires affects the hole size. Sieves therefore are now defined by the size of opening and the wire diameter in mm.
- mesh type screen** A type of *drum screen* with the drum consisting of stainless steel mesh with spacings of about 6 mm for screening of *combined sewer overflows*. For fine screening of water the spacing may be less than 3 mm.
- mesobiota** Medium sized soil organisms including *nematodes*, *oligochaetes*, small insect *larvae* and small *arthropods*. Compare *macrobiota*, *microbiota*.
- mesophile** Any bacterium that thrives at temperatures between 25 and 45 °C, unlike *thermophiles* and *psychrophiles*.
- mesophilic digestion** *Anaerobic digestion* at about 35 °C. Compare *thermophilic digestion*.
- mesosaprobic river** A river with medium organic pollution, intermediate between *polysaprobic* and *oligosaprobic* rivers. The sub-division ‘ $\alpha$ -mesosaprobic’ contains less oxygen than 50% saturation but the surface of the bottom mud is not *anaerobic*, although *macrobiota* are limited.  $\beta$ -mesosaprobic waters always have dissolved oxygen above 50% and a greater diversity of plants and animals. *Caddis flies*, *may flies* and *freshwater shrimps* are rare in  $\alpha$ -mesosaprobic rivers, but reasonable numbers exist in  $\beta$ -mesosaprobic ones. *Asellus aquaticus* is common in  $\alpha$ -mesosaprobic rivers.
- mesoscale air circulation** Air circulation such as sea breezes, mountain valley winds that cover a distance in the order of 1–100 km.
- mesotrophic** Having a moderate content of *nutrients*—i.e. between *eutrophic* and *oligotrophic*.
- metabolism** The cycle of simultaneous biochemical changes that keeps any living system active, including *anabolism* and *catabolism*. See *enzyme*.
- metabolite** A substance taking part in *metabolism*, an intermediate product.
- metalimnion** The *thermocline*.
- metal plating wastewater** Liquid wastes from metal plating are not voluminous but may contain toxic salts of *copper*, *chromium*, *lead*, *nickel*, tin, *cyanide compounds* and also degreasing agents. Cyanides strip the oxide

- layer from the metal before electro-plating. Baths of salts of *hexavalent chromium* are used for chrome plating and the metals remain in the wash water from the rinse tanks. The pollution load can be reduced substantially if the plated metal is allowed to drip above the plating tank before it is rinsed. This reduces the drag-out of plating solution into the rinse tank.
- metals** See *arsenic, barium, boron, caesium-137, cadmium, calcium, cast iron, chromium, copper, heavy metals, hexavalent chromium, iron bacteria, lead, lithium, magnesium, manganese, mercury, micro-nutrient, nickel, potassium, selenium, silver, sodium restricted diet, stainless steel, steel, strontium, zinc.*
- meteoric water** Water from the atmosphere, which has been rain, dew, hail, sleet, snow, etc.
- meteorology** The study of the weather. Weather greatly affects pollutant concentrations in *inversions* and their dispersal by winds or rain. High air pollution is usually impossible in high wind.
- metering of water supplies** See *water metering.*
- methaemoglobinaemia** A disorder in babies up to about 3 months old that can occur due to excessive intake of nitrate ions. The nitrate reduces in the digestive system and methaemoglobin (MetHb) can be formed, which is the combination of haemoglobin and nitrite. It forms in young babies and then haemoglobin is less available for transportation of oxygen. The baby appears slightly blue and in severe cases the baby may die unless the source of nitrate is removed from the diet. Bottle fed babies with water high in nitrate is a concern. The EU limit for nitrate in drinking water is 50 mg/l of nitrate as  $\text{NO}_3^-$ . The limit in the USA is 10 mg/l of nitrate as N, which is the equivalent of 44 mg/l of nitrate as  $\text{NO}_3^-$ .
- methane,  $\text{CH}_4$**  A gas with about half the density of air, explosive at concentrations between 5 and 15% in air. It is formed by the *anaerobic* degradation of organic materials.
- methane fermentation** The action of *methanogenic* bacteria in releasing *methane* and carbon dioxide during *anaerobic* decomposition of organic material. See *landfill gas, sludge gas.*
- methane formers** *Methanogenic bacteria.*
- methane recovery from landfill** See *landfill gas production.*
- methane vents, m. wells** See *landfill gas vents, landfill gas wells.*
- methanogenic bacteria, methane formers, methanogens** Strict *anaerobes* that, in *anaerobic digestion*, generate *methane* mainly from simple organic acids or alcohols made by the *acid formers*. Carbon dioxide also is formed by some methane formers but others may consume it. They cannot function at a pH below 6.2 and prefer a pH from 7.0 to 7.5. Their slow growth rate usually necessitates longer retention times compared with *aerobic* treatments.
- methemoglobinaemia** The USA spelling of *methaemoglobinaemia.*
- methanolysis** *Pyrolysis* that has a fast heating rate up to 1000 °C. Methane is added to the reactor and the end products are a range of aromatic hydrocarbons and alkenes.
- MetHb** Methaemoglobin. See *methaemoglobinaemia.*

**methoxychlor** An organic chemical that is used as an insecticide. At high exposures it adversely affects the fertility in animals and possibly humans. The *USEPA* states a *MCL* in drinking water of 40 µg/l and the WHO guideline maximum value is 20 µg/l. The EU Drinking Water Directive states a mandatory maximum of 0.1 µg/l.

**methyl bromide, CH<sub>3</sub>Br** A toxic chemical used as a soil fungicide and pesticide. In humans it can cause neurological damage. The *USEPA* classifies it as an acute toxin. It is also an *ozone depleting substance*. It will be banned in the EU from 2005.

**methylene blue active substances, MBAS, MBS** Anionic *synthetic detergents* that react with methylene blue to produce an intense blue colour. Other organics or inorganics may interfere with this reaction; therefore the test should be used only to examine drinking water.

**methylene blue stability test** An estimation of the *stability* of a wastewater effluent, based on the time taken to decolorise methylene blue solution. This is related to the time for the sample to become *anaerobic*. If the blue colour persists for more than 5 days, the sample is considered to be stable. This test is now rarely used.

**methylene dichloride, methylene chloride** *Dichloromethane*.

**methyl chloroform** *1,1,1-trichloroethane*.

**methyl isoborneol, MIB** An organic chemical that can produce unpleasant odours in the water at very low concentrations. It can occur due to algal growths in the water.

**methyl mercury, H<sub>3</sub>CH<sub>2</sub>CH<sub>3</sub> or (CH<sub>3</sub>)<sub>2</sub>Hg** A highly toxic *mercury* compound with a tendency to accumulate up the *food chain*. It poisoned many people at Minamata Bay, Japan.

**methyl orange alkalinity** The *total alkalinity*.

**methyl tertiary butyl ether** *MTBE*.

**metrics** The theory of measurement.

**mgd** Million gallons per day.

**mg/l, mg/litre** Milligrams per litre.

**mho** A siemens, a unit of *electrical conductance*, the reciprocal of the resistance in ohms.

**MIB** *Methyl isoborneol*.

**micro-** Prefix that indicates one-millionth, or 10<sup>-6</sup>, for short written with the Greek letter µ.

**microaerophile** An organism that prefers low levels of oxygen.

**microbe** *Micro-organism*.

**microbial film** A *biofilm*.

**microbial growth curve** A graph showing the rate of growth of a particular species of micro-organism for a specific food input (*see Figure M.1*). It is not necessarily accurate to use this growth curve to describe population growth in complex microbial systems such as *activated sludge*. *See growth phases of microbes*.

**microbiocide** A chemical that kills micro-organisms.

**microbiological tuberculation** *Tuberculation* that is caused or assisted by the growth of bacteria on the inside of a pipe, especially old cast iron pipes.

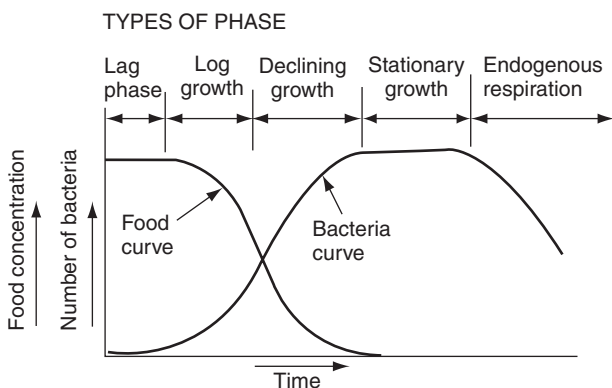

**Figure M.1** Microbial growth curve.

**microbiology** The sciences of microbes, including *bacteriology*, *cytology*, *enzymology*, *mycology*, *protozoology*, *virology*. The main living beings studied are, in order of complexity: animals, plants and *protists* (the least complex). Animals in this sense are tiny invertebrates, including *rotifers* and *crustaceans*. Plants include mosses and ferns as well as seed plants.

**microbiota** *Micro-organisms*.

**Micrococcus** An important genus of bacteria in *activated sludge*, also an *acid former*. They are *facultative anaerobes*.

**microcurie**,  $\mu\text{Ci}$  One-millionth of a curie,  $10^{-6}$  curie, one million picocuries, a unit of radioactivity.

**Microcystis aeruginosa** A strain of *cyanobacteria* (blue green algae) that can form blooms on nutrient rich water. It has been associated with the production of *endotoxins*.

**microencapsulation** In *encapsulation* of hazardous waste, the waste is contained within the microstructure of the encapsulating material. *Compare macroencapsulation*.

**microfauna** *Microscopic* animal life.

**microfiltration** Filtering water through a cartridge of pore size  $0.1\text{--}0.5\ \mu\text{m}$  that can remove particles down to the range of  $0.05$  to  $0.5\ \mu\text{m}$ . The operating pressure is  $2\text{--}7$  bar. The microfilter membrane requires periodic backwashing. Microfiltration can filter out micro-organisms and it is useful for the removal of *Giardia* and *Cryptosporidium* from water. It has also been used for the removal of micro-organisms from wastewater effluents.

**microfloc tube settler** *See inclined tube settling tank*.

**microflora** *Microscopic* plant life.

**microgram**,  $\mu\text{g}$  A millionth of a gram.  $10^{-6}$  g.

**microinvertebrates** Small animals without a backbone that cannot be seen by the unaided eye.

**micrometre** A *micron*.

**microhm**, *microsiemens* A millionth of a *siemens* or of a *mho*, a unit of *electrical conductance*.

- micron,  $\mu\text{m}$**  A millionth of a metre.  $10^{-6}$  m.
- micronutrient** A food required in minute quantities that may be toxic in excess.
- micro-organism, microbe** Microscopic organisms that include actinomycetes, algae, bacteria, cyanobacteria, protozoa and some fungi.
- micro-pollutants** Substances that pollute or poison even in minute concentrations.
- micro-Ringelmann chart** A photographic reduction of the *Ringelmann chart*, made to a size that enables it to be used by a single observer holding it at arm's length.
- microscale air circulation** Air circulation that cover a distance in the order of 1 cm–1 km. Microscale circulations can be important in dispersion of chemicals during crop spraying.
- microscope** Normally an *optical microscope*, but *see also electron microscope*.
- microscopic** Description of things too small to be seen except under the microscope.
- microscreen A microstrainer.**
- microsiemens** *See micromho.*
- microsporidia** Obligate parasites that can occur in a variety of animals. They can cause diarrhoea and fever in humans. Their spores may be transmitted by contaminated water.
- microstrainer, microscreen** A drum covered with very fine stainless steel wire mesh which rotates on a horizontal shaft and is partly submerged in the water being screened (*see Figure M.2*). A jet of filtered water from inside the drum washes off the solids caught outside. Drums are from 1 to 3 m diameter and 0.3 to 4.5 m long, with openings from 15 to 65  $\mu\text{m}$ . The drum rotates at about 5 r.p.m. They are used for removing solid material from water with a low solids content and also in the *tertiary treatment* of wastewater. Designs range from 250 to 2500 m<sup>3</sup>/d of water

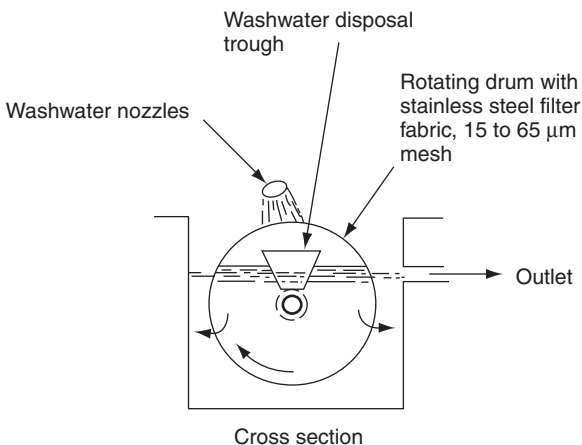

**Figure M.2** Microstrainer (water inlet to centre of drum).

flow per m<sup>2</sup> of microstrainer area, depending on the quantity of solid material in the water or wastewater and the fineness of the mesh. See *drum filter*.

**Microthrix** See *foaming* (2).

**microtunneling** A *trenchless technology* method for installing pipelines. A small tunnel is bored through the soil by a remote controlled micro-tunneling boring machine (MTBM). The pipe is installed as the spoil is removed.

**midges at trickling filters** See *filter flies*.

**migration velocity** See *effective migration velocity*.

**mill** In waste management, a *pulveriser* or *shredder*.

**milled refuse** See *shredding*.

**milligram, mg** One thousandth of a gram; 1 mg = 1000 micrograms = 10<sup>-3</sup> gram.

**milligram equivalent per litre, milliequivalent per litre, meq/litre** A way of expressing the concentrations of substances in water instead of using mg/l. The concentration in mg/l is divided by the *equivalent weight*. A solution with a strength of 1 meq/l has one-thousandth of the strength of a *normal solution*. See also *equivalent per million*.

**millimole per litre, mmol/litre** The concentration in mg/l divided by the gram molecular weight of the substance. A solution with a strength of 1 millimole/l has one thousandth of the strength of a *molar solution*.

**millisiemens, mS** A unit of *electrical conductance*, one thousandth of a *siemens*.

**mineral dressing, m. beneficiation, m. preparation, m. separation** The raising of the metal concentration in an ore and the reduction of its waste rock (gangue) content. Coal is not ore but is treated very similarly. Mines and their associated preparation plants produce more solid waste than any other industry and certainly much more than the tonnage of domestic refuse. See *dense medium, flotation, mechanical sorting plant*.

**mineralisation, mineralization** In wastewater treatment, mineralisation implies the reduction of the proportion of organic material by its conversion to inorganic material.

**mineralised sludge** Fully *digested sludge*. Before digestion, sludge is some 70% organic matter and 30% mineral excluding the water. Digestion can transform two-thirds of the organics into gases and water, so that in fully digested sludge the organic proportion is reduced to 45% and the mineral is increased to 55%.

**mineral water** Any water containing inorganic salts and a very low organic content. Strictly speaking, all *groundwater* is mineral water but the term is usually reserved for bottled drinking water or other waters thought to have health giving properties.

**miner's anaemia** *Hookworm disease*.

**minestone** *Colliery spoil*.

**mine water** Water drained from mines may contain the mineral being mined and a high total solids content, but usually little organic pollution. The most common pollution from mine water is caused by *acid mine drainage* or by *ferruginous discharges*. Alkaline mine water also exists.



- miniature smoke chart** A modified, small *Ringelmann chart* designed to be read at about 1.5 m from the eye. Like the *micro-Ringelmann chart*, it is easier to use than the Ringelmann chart.
- minimum acceptable flow** The *prescribed flow*.
- minimum detectable threshold odour concentration** The minimum concentration of a chemical in the air or water whose odour is still detectable by humans.
- minimum lethal dose, MLD, m. l. concentration, MLC** The minimum dose or concentration of a given chemical for 100% kill of a given population.
- minimum night flow** See *night flow*.
- mist** Drops of water smaller than fog ( $2\ \mu\text{m}$ ) hanging in the air and resulting in a visibility below 2 km but usually more than 1 km.
- mist eliminator, demister** Cooling of the flue gases may produce fine water droplets. Mist can also occur following the wet treatment of gases as in a *wet scrubber*. These droplets can be removed before the gas enters the stack by passing through a mist eliminator which is typically an *entrainment separator* or *impaction separator* or possibly a *centrifugal separator*. Mist eliminators are commonly fitted to cooling towers at power stations. Elimination of mist can improve the buoyancy of the flue gas. See *baffle type scrubber*.
- miticide, acaricide** A *pesticide* that kills mites on animals or humans.
- mixed bed ion exchange** A mixture of *anion* and *cation* exchange materials in a treatment bed. A *conductivity* of only  $0.5\ \mu\text{S}/\text{cm}$  can be achieved. Mixed beds are standard practice for demineralising feedwater for high pressure boilers. See *ion exchange*.
- mixed fission products** The waste from the reprocessing of nuclear fuel, one of the *radioactive wastes*.
- mixed flow pump, diagonal f. p.** A rotodynamic pump intermediate between a *radial flow pump* and an *axial flow pump*. *Volute* casings are suitable for dirty water but are less efficient than the alternative, the *diffuser* casing. They may be used for moderate heads, up to 30 m. See *turbine pump*.
- mixed liquor** In the *activated sludge* process, the mixed activated sludge and wastewater in the *aeration tank*. See *MLSS*, *MLVSS*.
- mixed media filter** A *multi-media filter*.
- mixed sludge** A mixture of *primary sludge* and *secondary sludge*. Mixed sludge from a *primary sedimentation tank* is usually about 3 to 4% solids.
- mixing of lake water** See *destratification of lakes and reservoirs*.
- mixolimnion** The upper part of a *meromictic* lake.
- ML, megalitre** One million litres,  $1000\ \text{m}^3$ , 1000 t of water.
- MLC** (1) Minimum lethal concentration. See *minimum lethal dose*. (2) Median lethal dose. See *LD50*.
- MLD** (1) *Minimum lethal dose*. (2) Median lethal dose. See *LD50*.
- mld** Megalitres per day, i.e.  $1000\ \text{m}^3/\text{d}$ .
- MLSS, mixed liquor suspended solids** The dry *suspended solids* in *mixed liquor* (mg/l). Conventional *activated sludge* plants operate at 2000 to 3500 mg/l but *oxygen activated sludge* plants may operate at 6000 to 8000 mg/l. See *also return activated sludge*.

**MLVSS, mixed liquor volatile suspended solids** The dry volatile *suspended solids* in mg/l of *mixed liquor*. MLVSS is often considered to be about 70% of the *MLSS* and may be used in preference to *MLSS*.

**modified aeration** A high rate *activated sludge* treatment with the same flow sheet as conventional aeration but with much shorter aeration times, below 3 h, consequently with lower quality effluent. The *MLSS* is about 500 mg/l. The sludge often does not settle well.

**modified cross section lining, swaging** A method of water pipe or sewer rehabilitation in which a replacement polyethylene pipe is inserted into the existing pipe. The new pipe has a slightly larger diameter than the host pipe. The new pipe is inserted by reducing its diameter by systems, such as *swagelining* or *rolldown*.

**modified sliplining** *Close fit lining*.

**modular units** The use of several adjoining tanks instead of one large one. Although modular units may be more expensive to build, the controller obtains operating versatility which otherwise he does not have. In particular, *activated sludge* plants built on a modular basis can be operated to simulate *plug flow*.

**Mogden formula** The calculation method for the charges for treating industrial effluent at Mogden wastewater treatment works near London is the sum of three costs for (1) the flow rate; (2) the biological treatment based on the *McGowan strength* of the waste; (3) the treatment of the sludge, based on the *suspended solids* content of the waste. This formula is now used in a modified form, which is discussed under *industrial effluent charges*.

**Mohlman index** The *sludge volume index*.

**moisture holding capacity** The *field capacity* of a soil.

**molar solution** A solution containing 1 g molecular weight (*mole*) of the *solute* per litre of solution. *Compare normal solution*.

**mold** The USA spelling of *mould*.

**mole** In chemistry, the molecular weight of a substance in grams, formerly the gram-molecule.

**mole drain** A *land drain* about 80 mm diameter through stiff clay, made without a drain pipe. The hole should be formed when the clay is moist and plastic. It stays open for many years and drains the clay effectively if it is driven at the right slope.

**mole ploughing (USA: plowing)** A *low-dig technique* that uses a plough to open up a void into which a new pipe or sewer is placed immediately behind the plough head.

**moler earth** *Diatomite*.

**moling** *See thrustboring*.

**mollusc, Mollusca** A *phylum* of invertebrate animals that includes snails, marine and *freshwater mussels*, limpets, clams, oysters and other *shellfish*.

**molluscicide** A *pesticide* that kills molluscs.

**monimolimnion** The lower part of a *meromictic* lake.

**monitoring well, observation well** A well sunk solely for the purpose of watching the quality of the water (not for *abstraction*) and to determine how far a particular contamination of a *groundwater* has reached. *See sentinel well*.

**monochloramine**  $\text{NH}_2\text{Cl}$  See *chloramines*.

**monochlorobenzene chlorobenzene MCB** A *chlorinated benzene* used in the production of a range of other organic chemicals. At high exposures in humans it can affect the liver and kidneys. The *USEPA* sets a *MCL* of 0.1 mg/l in drinking water, which is also the corresponding WHO guideline maximum value.

**Monod equation** An equation that relates to rate of growth of biomass to the concentration of food.

**mono-landfill** A *landfill* site into which only one classification of waste can be deposited, e.g. domestic waste.

**monomer** A simple molecule from which a *polymer* can be chemically built up.

**monomictic** A term that describes one turnover of a lake in one year. See *thermal stratification*.

**Montreal Protocol 1987** A protocol, ratified by 36 countries, to reduce the production and consumption of chemicals that deplete the *ozone* layer. The protocol was substantially strengthened by the *Helsinki Declaration* in 1989 which required the phasing out of production and consumption of ozone depleting *chlorofluorocarbons* (CFCs) by 2000. Other chemicals that deplete the ozone layer must also be phased out. Eighty countries have agreed the Helsinki Declaration.

**Moody diagram** A diagram that can be used to determine the Darcy-Weisbach friction factor for use in the Darcy-Weisbach formula for *pipe flow*.

**morbidity** Showing symptoms of a disease.

**mortality rate** The rate of deaths occurring due to a specific disease or at a specific location.

**mosquito** Of the many mosquitoes some are *vectors of disease*, but only the *anopheline mosquito* carries *malaria*. *Filariasis* is carried mainly by the culicine mosquito (*Culex fatigans*) and sometimes by the anopheline. *Yellow fever* and *dengue* are carried by *Aedes aegypti*. Mosquito *larvae* develop on water, and an increase of water area may increase the mosquito population. Malaria epidemics have occasionally been associated with man made lakes, *irrigation* schemes or *waste stabilisation ponds*.

**most probable number, MPN, multiple tube enumeration** A method of estimating a count of the number of microbes in a unit volume of water, based on statistics. The positive and negative results obtained when testing multiple tubes of geometrically increasing dilution are recorded. The MPN method can be used to give an estimate of the number of coliforms or *E. coli* in water or wastewater. Fivefold or tenfold dilutions of the sample are made successively, so that some of the results are negative. Samples from three successive dilutions are inoculated into *MacConkey's broth* and incubated for 48 h at 37°C for the total coliform count or (for *E. coli*) at 44°C. A positive test is shown by a change of colour from purple to yellow, with evolution of gas, collected in a small tube. The result is a *presumptive coliform count*. See also *membrane filtration*.

**mottling of teeth** See *fluoridation*.

**mould** Microscopic fungi that have long filaments (known as hyphae). See below.

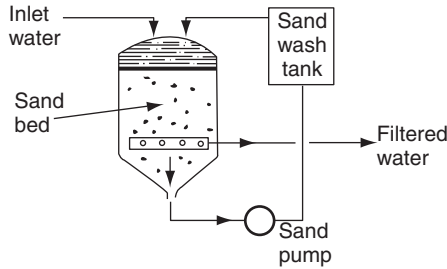

**Figure M.3** Moving bed sand filter.

**mould growth** Even intermittent condensation can result in mould growth. Many materials or surface contaminants can supply sufficient nutrients for mould growth. The moulds reproduce by producing spores 1 to 100 mm which can become airborne. 10 to 30% of the population can become sensitised to spores giving an allergic reaction. A few individuals may suffer lasting damage to lungs. Besides the clinical effects, mould growth can produce psychological stress and depression in the humans who inhabit mouldy houses.

**moving bed bio-reactor** *Suspended immobilised biomass reactors.*

**moving bed filter** A *rapid deep bed filter* in which the filtering media such as sand or activated carbon moves continuously down the filter. It is removed at the bottom for cleaning. *See below.*

**moving bed sand filter, sand recirculation f.** A *moving bed filter* where the filter media is sand (*see Figure M.3*). The sand that is removed from the bottom is washed and then re-fed into the top of the filter. They have been used for filtering water or wastewater effluent. Various designs exist, some with an upward flow of water countercurrent to the downward movement of the sand. *See continuous backwash upflow sand filter.*

**moving bed scrubber, floating b. s.** A *wet scrubber* containing spheres of plastics, glass, marble, etc., which are fluidised by dirty gas rising up through them (*see Figure M.4*). The wash liquor is sprayed down over the spheres. The pressure drop is directly proportional to the flow rate of the liquor. Particles of  $0.1 \mu\text{m}$  size can be collected, as well as viscous liquids. If the spheres are of hollow plastics, they may need to be held down by an upper constraining plate. There may be more than one bed. These scrubbers are efficient in the absorption of sulphur dioxide when using a caustic scrubbing liquor. *See turbulent contact absorber.*

**moving belt screen** A *belt screen*.

**moving grate incinerator, continuous g. i., travelling g. t.** A waste *incinerator* that has moving grates that transport the waste through the furnace until the waste is completely burnt (*see Figure I.2*). The waste moves through a drying stage, a combustion stage and finally is burnt out and moved to the ashpit.

**Primary air** passes up through the gaps in the grates. The moving grates may be of various designs. Reciprocation grates are a series of downward steps of

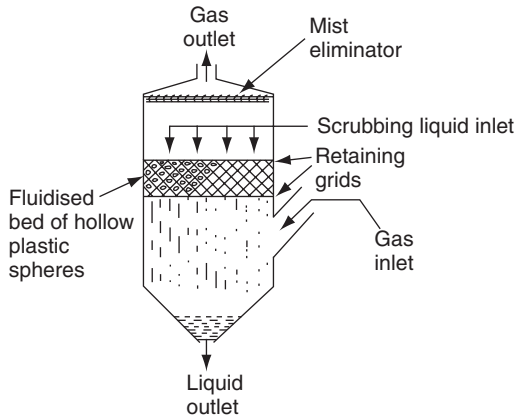

**Figure M.4** Moving bed scrubber.

0.5 to 1 m. The steps move up and down in sequence so the waste moves down the incinerator. Roller and rocker grates have a series of rollers or rockers on a slight slope so that the waste moves downwards.

**MPN** *Most probable number.*

**MRSA** Multiple resistant *Staphylococcus aureus*. See *Staphylococcus*.

**MS** *Mass spectrometer.*

**MS4** Municipal separate stormwater sewer system. A USA term for a publicly owned stormwater sewerage system which is not a *combined sewer*.

**MSW** *Municipal solid waste.*

**MTBE** Methyl tertiary butyl ether. A chemical that is used as an additive to fuel to increase the oxygen in the fuel and thereby lower carbon monoxide emissions. Contamination of drinking water by MTBE has occurred. It gives the water an unpleasant taste and odour and may be a health hazard.

**MTBM** Microtunnel boring machine. See *microtunneling*.

**MTD** *Maximum tolerated dose.*

**mudballs** An accumulation of dirt, grease, biological matter, etc. together with some of the filtration media (e.g. sand) into a ball that can be difficult to remove from a sand filter by *backwashing*. As mudballs grow in the filter they tend to sink to the bottom of the filter. Mudballs are often a consequence of poor operation and maintenance of the filter and should be avoided.

**multi-cyclone, multi-clone, multi-cellular collector** *Cyclones* that contain 1000+ small *cyclones* in parallel. Each cyclone may be 4 to 10 mm in diameter. The *cut diameter* is approximately 2.5  $\mu\text{m}$ .

**multi-disposal landfill** A landfill site into which a range of wastes can be deposited.

**multi-effect dryer, multi-effect evaporator** See *Carver-Greenfield process*.

**multi-liner** A lining system at the base and sides of a *landfill* site in which more than two liners are installed. This may be appropriate for landfill sites

containing very hazardous waste material. The liners may be three or more separate liners with drainage layers above each liner. Alternatively, the first two layers may be a **composite liner** and then a third liner is placed below with a drainage layer between the composite liner and the third liner. Drainage layers are also installed above the composite liner to collect the leachate and below the third layer. See **landfill liner** and **Figure L.4**.

**multi-media filter, multi-layer f., mixed media f.** A downflow **rapid gravity filter** that uses three or more media, often anthracite at the top (coarsest and least dense), sand in the middle and garnet (finest and most dense) at the bottom. Polystyrene may be added as an extra layer on top and magnetite as an even finer, denser layer at the bottom. Other materials have been used and they should be chosen to suit the water or effluent to be filtered. The grain size varies from 1 to 2 mm at the top to less than 0.5 mm at the bottom. The filters are backwashed, but because of the differing densities of the various media, the layers remain separated after **backwashing**. The design is often based on the **surface loading rate**, which is 12 to 20 m<sup>3</sup> m<sup>-2</sup> h<sup>-1</sup>. Water works may adapt their **rapid gravity sand filters** to become multi-media filters in order to increase the throughput of water.

**multiple drug resistance, MDR** Some pathogenic micro-organisms have become resistant to a range of antibiotics. These organisms are therefore very difficult to treat. See **Staphylococcus**.

**multiple flue stack** A chimney with several flues in it. The outer structure is called a windshield.

**multiple hearth dryer** The drying part of a **multiple hearth incinerator** in which the sludge is moved by rakes as the hot gases from the incinerator pass over the sludge.

**multiple hearth incinerator** A continuous **incinerator** some 8 m diameter and 10 m high, capable of burning wastewater sludge or solid waste, consisting of a hollow, central, vertical, air cooled shaft that rotates slowly, raking the sludge gradually from the coolest hearth at the top to the hottest at the bottom (**Figure M.5**). There may be as many as eight horizontal hearths directly above one another, and oil firing may be introduced near the lower or middle hearths. If used for burning solid refuse, this may first go through a **mill**. Solid waste and wastewater sludge have been burnt simultaneously, the solid waste providing the heat to burn the sludge. The sludge is generally 60 to 75% water, although some designs allow sludges with 90% water to be burnt.

**multiple resistant *Staphylococcus aureus*, MRSA** See **Staphylococcus**.

**multiple tray aerator** A **plate tower reactor** with the tower containing wood or plastic slats. Water is passed down through the tower while air is forced up through the tower, enabling the water to become aerated. See **cascade aerator, Figure C.1**.

**multiple tube enumeration of bacteria** See **most probable number**.

**multiple tube press** A **tube press**.

**multipole overband separator** An **overband separator** with a number of magnets which alternately release and pick up the magnetic material from

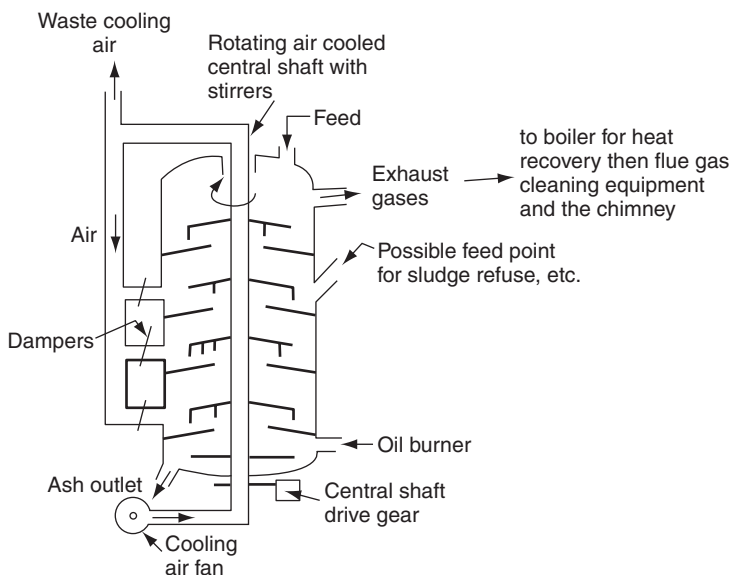
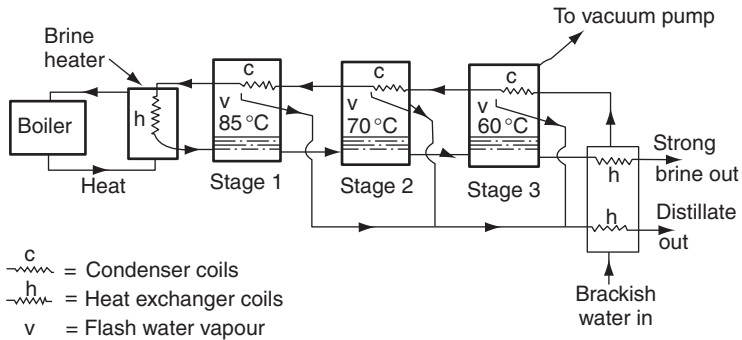

**Figure M.5** Multiple heat incinerator.

a belt, thus shaking out the non-magnetic material and producing cleaner iron and steel.

**multi-purpose use of water** The aim of water development is to satisfy as many as possible of the community's needs for water, whether for amenity, recreation, fishing, drinking, industry, *irrigation*, navigation, electrical generation or effluent disposal. Some of these needs oppose others and compromises must be made. *See river regulating reservoir.*

**multi-stage flash distillation, MSF distillation** A *desalination* process for distilling drinking water from seawater or brackish water. The vapour from each stage condenses on tubes cooled by the seawater flowing into earlier stages (*see Figure M.6*). Ten or more stages are used each with a lower pressure and thus a lower boiling point of water. As the hot seawater moves into the next stage at lower pressure, water 'flashes' off and condenses on the cooling coils. Up to 80% of the water input can be recovered as distillate. The heat recovery from the strong brine and distillate is extensive in order to optimise energy consumption. Chemicals are added to the inlet water to stop scale forming in the plant. Acid cleaning of the plant is required typically once per year. The inlet water is disinfected to stop biological growths in the plant. MSF plants may be associated with power generation plants and the excess heat from power generation is used to heat the seawater in the MSF plant. The largest single plant is 54000 m<sup>3</sup>/d in Abu Dhabi and the largest complex is the 10 × 45000 m<sup>3</sup>/d in Saudi Arabia. The total MSF plants in operation can supply the water for about 40 million people.



**Figure M.6** Multi-stage flash distillation, schematic diagram (10 or more stages are used in practice).

**multi-stage shredding or pulverising** Shredding or pulverising of refuse may take up to three stages, although *two stage shredding* is more often used. Primary shredding of refuse is to about 10 to 15 cm in size, secondary shredding of refuse to about 3 cm in size and tertiary shredding of refuse is to about 1 cm in size.

**municipal waste, municipal refuse** Waste from households and other waste that is similar. See *domestic waste*.

**municipal waste incinerator** See *incineration* and *Figure I.2*.

**mussels** See *freshwater mussels, Mollusca*.

**mutagenic** The property of a chemical to cause changes to the hereditary genetic material in a living cell.

**mutant** In biology, an individual with different characteristics from the rest of its species, which may be transmitted to its descendants. *Pesticides* kill all the pests except those mutants that can resist them, and often the pests develop a strain that is immune to the pesticide.

***Mycobacterium*** The members of this genus are mostly actinomycetes. *M. tuberculosis* causes tuberculosis which is only rarely waterborne. *M. leprae* causes leprosy, which is not waterborne. Some other *Mycobacteria* species are human pathogens and can be waterborne and may lead to ulcers or abscesses or other clinical syndromes. Excessive growths of *Mycobacteria* species in *activated sludge* aeration tanks can cause severe foaming.

**mycology** The science of *fungi*.

**mycotoxin** A toxin produced by a fungus.

**myocarditis** Inflammation of the myocardium (muscular substance of the heart).





---

**NAAQS** *National Ambient Air Quality Standards* set by the *USEPA*.

***Naeglaria fowleri*** A pathogenic protozoa that can be found in warm waters.

It can cause naegleriiasis, which is a form of *amoebic meningoencephalitis*.

It enters the human body via nasal inhalation.

***Nais*** A true segmented worm, an *annelid* belonging to the family Naidides, typical of water with mild to serious organic pollution.

**nanofiltration** Filtering water through a thin, slightly porous membrane that can remove molecules down to a molecular weight of 200. The pore size of the membrane is 0.01–0.001  $\mu\text{m}$ . The operating pressure is 10–40 bar which is less than *reverse osmosis* but higher than the *ultrafiltration*. Nanofiltration can filter out micro-organisms, organic and colour molecules and some larger salt molecules. See *membrane fouling*.

**nanogram, ng** A thousand millionth of a gram.  $10^{-9}$  g.

**nanon, nanometre** A unit of length,  $10^{-9}$  metre,  $10^{-3}$  micron. It is equal to 10 ångström.

**NAPLs** *Non-aqueous phase liquids*.

**naphthalene** A *polycyclic aromatic hydrocarbon* with two benzene rings attached to each other (see *Figure P.10*). The EU lists it as a *priority substance* (under review for possible re-grading as priority hazardous substance) in relation to aquatic discharges.

**narrative biocriteria** See *biocriteria*.

**narrow trenching** Excavation of a trench only 100 mm wider than the outside diameter of the pipe that is going to be installed.

**natant** Floating or swimming in water.

**National Air Quality Strategy** As part of the UK *Environment Act 1995*, standards and objectives for ambient air quality have been set together with measures to achieve these objectives. Local Authorities are required to review their ambient air quality against these objectives and implement appropriate action if they are not met.

**National Ambient Air Quality Standards, NAAQS** In the USA, the air quality standards set by the *USEPA*. It is the concentration of an air pollutant that should not be exceeded. Examples of the standards are listed under *carbon monoxide, lead, nitrogen oxides, ozone, particulates, sulphur dioxide, VOC*.

**National Contingency Plan, NCP** In the USA, the NCP is the framework for remedial investigation and clean up implementation for a *superfund site*.

**National Emission Standards for Hazardous Waste Pollutants, NESHAP** The standards in the USA for the allowable level of emission of hazardous air pollutants. These standards should not be exceeded in any emission.

**National Environmental Policy Act 1969, NEPA** A far reaching US federal law that established the *Council on Environmental Quality*, a national policy for the environment, also a requirement in all major federal projects for a detailed comprehensive *environmental impact statement* (EIS). Its omissions in detail about the EIS have been rectified by many court decisions of federal judges, who have interpreted the law in spirit rather than in letter.

**National Pollution Discharge Elimination System** In the USA, the mechanism for regulating the quantity and quality of aqueous discharges. It is administered by each State.

**National Primary Drinking Water Regulations** The *USEPA* sets the regulations for contaminants that have an adverse effect on public health. The maximum contaminant level (MCL) for various inorganics are listed in *Table D.2 Drinking water standards* and organics are listed under the specific compound. *See also Drinking Water Contaminant Candidate List.*

**National Priorities List, NPL** In the USA, a list of abandoned waste disposal sites that are eligible for clean up funding under *SARA*.

**National Rivers Authority, NRA** A statutory body established by the *Water Act, 1989* which took over the responsibilities of the water authorities in England and Wales in relation to water pollution, water resource management, flood defence, fisheries, and navigation. The duties of the NRA became the responsibility of the *Environment Agency* from 1 April 1996

**National Secondary Drinking Water Regulations** The *USEPA* sets the regulations for contaminants that have an aesthetic effect but not a health effect. The standards for various inorganics are listed in *Table D.2 Drinking water standards*.

**natural draught** The height of a chimney and the warmth of the air in it cause the air to be sucked up from the fire below. The higher the chimney and the warmer the air, the greater is the draught. *Forced draught fans* and *induced draught fans* are commonly used.

**natural purification** *See self purification.*

**natural treatment systems** Any treatment of wastewater or, more probably, wastewater effluent by use of a natural environment. These are often *land treatment* systems which are based on the passage of the wastewater through soil and include *intermittent filtration, overland flow land treatment, rapid infiltration land treatment, slow rate land treatment, soakaways* and *soil aquifer treatment*. Treatment processes such as *constructed wetlands, floating aquatic plant treatment system* and *reed bed treatment* and are based on the aquatic environment and may be known as *aquatic based natural treatment systems*.

**NCP National Contingency Plan.**

**Navicula** A freshwater *diatom* abundant in organically polluted water, which is tolerant of a wide range of pH and may occur in salt water. It absorbs and concentrates pollutants posing a threat to fish that live off it.

**Neanthes** A genus of *polychaetes*, some species of which may be used in *bioassays* of tidal mud and estuaries.

**Nector americanus** See *hookworm disease*.

**necrosis** Death of a part of a living organism. Spots on the surface of plant due to the loss of protoplasm can occur due to exposure to pollutants such as NO<sub>2</sub> or SO<sub>2</sub>.

**necton, nekton** Tiny organisms that swim strongly, unlike *plankton* and *neuston*.

**negative ions** Negative ions in the air can affect human physiology. Reduced concentration of negative ions is common in buildings and can result in aching joints, depression, asthma, etc. Air pollutants can attract ions so that the concentration of free ions in the air reduces. Metal work and electrical machinery can also attract the ions out of the air. Negative ionisers increase negative ions in air and it is claimed to induce calmness and alertness.

**nematocide** A *pesticide* that kills *nematodes*.

**nematode, Nematoda** A large class of small, unsegmented round worms, of which a few are parasitic and mentioned under *helminthic diseases*. Most are free living creatures of the water or mud, found also in *trickling filters*, and possibly *activated sludges*, and harmless except that, like other small beings, they can harbour *viruses* and protect them from *chlorination*.

**NEPA** The US *National Environmental Policy Act 1969*.

**nephelometer** An instrument that measures *turbidity* through the amount of scattering of the light that falls on turbid water.

**nephelometric turbidity unit, NTU, formazin turbidity unit (FTU)** The unit used for the quantification of turbidity in water. The water is compared to a standard formazin solution as measured in a *nephelometer*. One NTU is approximately the same as one *Jackson turbidity unit (JTU)*. See *turbidity unit*.

**nephrotoxin** A toxin that causes kidney damage.

**neritic zone** The sea bed between low water and the edge of the continental shelf.

**NESHAP** *National Emission Standards for Hazardous Waste Pollutants*.

**nesslerisation, nesslerization** A measurement of the *ammonia* content of water by the formation of a yellow colour when it is added to Nessler's reagent—a solution of potassium mercuric iodide with potassium hydroxide.

**network modelling** See *water distribution network modelling*.

**neurotoxin** A toxin that causes damage to the central nervous system.

**neuston** The water life at the air—water interface, either above it (e.g. the water skaters) or below it (e.g. the *mosquito* larvae). Compare *benthon*, *nekton*, *plankton*.

**neutralisation, neutralization** In *chemical treatment*, elimination of the *acidity* or *alkalinity* of a water, bringing its pH value near to 7.0.

**NFFO** *Non fossil fuel obligation*.

**nickel** A *heavy metal* that may be present in *metal plating wastewater* It is poisonous to many crops. It is toxic to humans damaging the liver. The EU lists it and its compounds as a *priority substance* in relation to aquatic discharges. See *Table D.2 Drinking water standards*.

**night soil** The contents of *bucket latrines*, *vault latrines*, etc. so-called because they are often removed at night.

**night flows** The minimum night flow is a total of the customers' night use plus the losses in the supply pipes, communication pipes, distribution mains and service reservoirs. It is an important measure in estimating *leakage* because the usage by the customers can be small at night and the pressure in the system is at its maximum. In many water supply systems, much of the night flow is leakage.

**NIMBY** Not In My Back Yard; a phrase that indicates that no-one wants wastewater works or landfill sites or incinerators built near them, although it is accepted that waste treatment facilities must be built somewhere. See *BANANA*.

**nines** Four 9s or five 9s etc. means 99.99% or 99.999% etc., removal. The term is often applied to the destruction and removal efficiency (DRE) of hazardous waste in incinerators.

**NIOSH** The US National Institute for Occupational Safety and Health.

**Nitrate Directive 1991** The EU Directive that sets the protection of fresh-water, estuarine water, coastal water and groundwaters from pollution by nitrates and thereby reduce the problem of *eutrophication*.

**nitrate poisoning** See *methaemoglobinaemia*.

**nitrate removal** See *nitrogen removal*.

**nitrates, —NO<sub>3</sub>** Nitrates in water supplies is an increasing problem often due to the use of nitrogen compounds in fertilisers in agriculture. Excessive nitrate in drinking water can cause *methaemoglobinaemia* in infants. Chemical precipitation or coagulation cannot be used for nitrate removal due to the high solubility of nitrates. Nitrates can be removed from water by *ion exchange* or *denitrification*. In domestic wastewater effluents, nitrates occur from the oxidation of ammonia and can be removed by denitrification. See *Table D.2 Drinking water standards, eutrophication*.

**nitric oxide, NO** See *nitrogen oxides*.

**nitrification** The conversion of ammoniacal nitrogen to nitrite and then nitrate. The process can be achieved by *aerobic biological oxidation* with 4 to 5 kg of oxygen required per kg of ammonia oxidised. The process is slow at temperatures below 10 °C. It can also be prevented or delayed by small amounts of toxic pollutants. See below, *F: M ratio*.

**nitrification—denitrification** *Nitrification* followed by *denitrification*, resulting in bubbling away of nitrogen gas. The process can be undertaken in a wastewater treatment works by having nitrification in the aerobic biological treatment process followed by a *denitrifying filter*. Alternatively the process can be incorporated into one system with adaptations of the *activated sludge* process, as in the 4 stage *Bardenpho process* or *AAO process*.

**nitrification inhibitor** A chemical that slows down or stops *nitrification* e.g. *allyl thiourea*.

**nitrified effluent** Effluent that has enjoyed full *nitrification* with nitrogen in the form of nitrate.

**nitrifying bacteria, ammonia oxidisers** Bacteria which achieve *nitrification* by *chemosynthesis*. In streams, lakes and estuaries *Nitrosomonas* and *Nitrobacter* are commonest, while in the sea *Nitrosocystis oceanus* often oxidise ammonia to nitrite. They are *autotrophs* and use carbon dioxide as their

- carbon source, while the oxidation of ammonia gives them their energy. Nitrifying bacteria have a slow initial rate of growth. See **nitrogenous BOD**.
- nitrifying filter** *Packed bed filters* may be used in the biological treatment of wastewaters for **nitrification** of a wastewater effluent after the BOD has been removed in a separate prior treatment process. This is known as **separate stage nitrification**. The filter may be a **trickling filter**. More commonly it is a **plastic media filter** with a depth of 3 to 4 m of media which can be loaded at 0.05 to 0.15 kgNH<sub>3</sub>/day per m<sup>3</sup> of filter. Due to low sludge production, another stage of sedimentation may not be required for the biomass that sloughs off the filter.
- nitrilotriacetic acid NTA** Nitrilotriacetic acid (NTA) is a chelating agent and it may be used as a replacement for phosphates in detergents. Both NTA and the trisodium salt of NTA are suspected to be carcinogenic.
- nitrites, —NO<sub>2</sub>** Compounds whose formula ends in —NO<sub>2</sub> are an interim stage of **nitrification** and readily oxidised to nitrates —NO<sub>3</sub>. In domestic wastewater concentrations rarely exceed 1 mg/l. In raw water underground or on the surface, nitrites rarely exceed 0.1 mg/l. Ammonia is converted to nitrites by bacteria of the genera *Nitrosococcus* and *Nitrosomonas*. See **Table D.2 Drinking water standards**.
- Nitrobacter** A nitrifying bacterium that converts nitrite to nitrate. It is a chemosynthetic **autotroph**.
- nitrogen, N** Nitrogen exists in wastewater in four main forms **organic nitrogen**; ammonia and its salts, such as (NH<sub>4</sub>)<sub>2</sub>CO<sub>3</sub>; nitrite nitrogen, usually only in small amounts; and the final product of **nitrification**, nitrate nitrogen. Wastewater effluent may contain 40 to 50 mg/l of nitrogen compounds. Some algae consume atmospheric nitrogen. See **eutrophication**.
- nitrogen cycle** The breakdown and formation of nitrogen compounds (see **Figure N.1**). The bulk of the nitrogen on earth is probably in the atmosphere, which is 80% nitrogen gas. Only a few groups of organisms can absorb it as a nutrient; one of these is cyanobacteria. Others must take it up in combined form. Making nitrates from nitrogen gas is called **fixation of nitrogen** and it may be industrial or natural. Like the **hydrological cycle**, it is a circulation from earth to atmosphere and back, but with many **biochemical** changes on the way.
- nitrogen dioxide, NO<sub>2</sub>, nitrogen peroxide** A reddish brown gas that is produced in small concentrations at high temperatures such as the internal combustion engine. Most NO<sub>2</sub> emanates from the oxidation of nitrous oxide (NO). See **nitrogen oxides**.
- nitrogenous BOD, NOD** The oxygen demand exerted in the **BOD** test by the oxidation of ammonia to nitrite or nitrate. The nitrifying bacteria are slow growing and the nitrogenous BOD may not affect the five-day BOD value. Nitrification in the BOD test can be suppressed by adding **allyl thiourea** (ATU).
- nitrogen oxides NO<sub>x</sub>** In air, nitrogen oxides can be present as nitric oxide (NO), nitrogen dioxide (NO<sub>2</sub>) or nitrous oxide (N<sub>2</sub>O). NO and NO<sub>2</sub> are formed when some nitrogen is oxidised in engine combustion or high temperature incineration. NO is unstable in air and slowly oxidises to

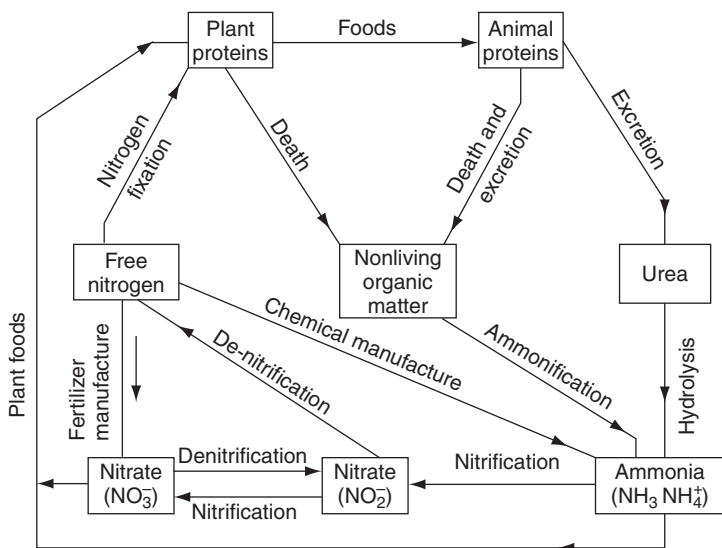

Figure N.1 Nitrogen cycle.

the reddish brown  $\text{NO}_2$ . UV light breaks down  $\text{NO}_2$  to  $\text{NO}$ . The presence of hydrocarbons in polluted air interacts with these reactions and the balance is stopped.  $\text{NO}_2$  then predominates giving a brownish haze to the polluted atmosphere.  $\text{NO}_x$  is important in the chemical reactions that form *photochemical oxidants* in polluted air. EU Directive states an air quality standard for  $\text{NO}_2$  as  $200 \mu\text{g}/\text{m}^3$  in air over a one hour period, which must not be exceeded more than 18 times a year. The annual mean limit value is set as  $40 \mu\text{g}/\text{m}^3$ . In the USA, *NAAQS* has set a  $\text{NO}_2$  air quality standard of  $100 \mu\text{g}/\text{m}^3$  (0.053 ppm) averaged over a one hour period. See *photochemical smog*.

**nitrogen removal** One of the main methods for removal of nitrate from water is *ion exchange*, although *denitrification* can also be used. For wastewaters, nitrate can be removed using denitrification processes or *algal harvesting* or some of the *land treatment* processes, Ammonia can be removed from water and wastewaters by *ammonia stripping*, *chlorination*, *ion exchange*, *nitrification-denitrification*, etc. See *anoxic filter*, *biological fluidised beds*, *biological aerated filters*.

**Nitrosococcus, Nitrosocystis oceanus, Nitrosomonas, nitrosifying bacteria** These are nitrifying bacteria that oxidise ammonia to nitrite. They are *chemosynthetic* and *autotrophic*.

**nitrous oxide,  $\text{N}_2\text{O}$**  See *nitrogen oxides*.

**Nitzschia** A genus of *diatoms* in fresh water and the sea, which may be abundant in ponds, ditches or occasionally in polluted water. It tolerates a wide range of pH, 4.2 to 9.0, as well as *copper*, *phenol* and *chromium* salts.

**NO** Nitric oxide. See *nitrogen oxides*.

**NO<sub>2</sub>** Nitrogen dioxide. See *nitrogen oxides*.

**NOAEL, No Observed Adverse Effect Level, No Observed Acute Effect Level**  
See *NOEC*.

**Nocardia foam** See *foaming* (2).

**NOD, nitrogenous oxygen demand** A term for *nitrogenous BOD*.

**no-dig techniques** See *trenchless technology*.

**Nodularia A cyanobacteria** (blue green algae) that releases *endotoxins* into water.

**NOEC, NOEL, No Observed Effect Concentration, No Observed Effect Level**  
The highest concentration or dose of a toxic chemical that does not cause an effect (NOEC or NOEL) or an adverse effect (NOAEL) in a specific living organism. See *LOEC, toxic units*.

**non-alkaline hardness** A *hardness* of water, usually called permanent or *non-carbonate hardness*.

**non-aqueous phase liquids, NAPLs** Liquids that are not water based. Light NAPLs are volatile and include petrol (gasoline) which can get into groundwater by leaching from storage vessels. Heavy or dense NAPLs include carbon tetrachloride or creosote.

**non-biodegradable** Description of something that is not broken down by microbes and has an *oxygen demand* only if it is a chemical reducing agent. It has no *biochemical oxygen demand*. See *biomagnification, organochlorine compounds*.

**non-carbonate hardness, permanent h. Hardness** that cannot be removed by boiling, unlike *carbonate hardness*. It results mainly from the sulphates or chlorides of calcium or magnesium. See *water softening*.

**non-community water supply** As defined by the *USEPA* a drinking water supply that, the year round, serves fewer than 15 service connections or 25 permanent residents. Sampling conditions are less strict than for community supplies.

**non-ferrous metals** Metals other than iron and steel.

**non-filterable residue** The solids that remain in water after filtration.

**non-fossil fuel obligation, NFFO** In the UK, a requirement for electricity companies to take a certain proportion of electricity generated from sources other than the burning of fossil fuels.

**non-ionic detergent** See *synthetic detergent*.

**non-point source pollution, NPS pollution, diffuse sources** Sources of pollution that cannot be located to an individual point. A typical example in water pollution is agricultural runoff.

**non-potable re-use** See *wastewater re-use*.

**non-return valve, clack v., check v., pipe interrupter** A pipe fitting that allows flow in one direction only. It can work by a flap that swings in one direction or by a spring-loaded ball valve, etc.

**non-selective medium** A culture *medium* that encourages the growth of many types of microbe.

**non-uniform flow** *Open channel flow* in which the water surface is not parallel to the *invert* in a channel of uniform cross section. It can occur at a *hydraulic jump* or with gradually varying flow. See *uniform flow*.

**non-volatile solids** The total solids in the sample minus the *volatile solids*.

**nonylphenol ethoxylates, NPEs** A group of chemicals that are used in a range of industries including agrochemicals and textiles. They are also used as non-ionic surfactants. They may be found in polluted water and some of them show weak *oestrogenicity*, i.e. they are *endocrine disrupters*. The EU list nonylphenols as *priority hazardous substances* in relation to aquatic discharges.

**No Observed Effect Level, NOEL, No Observed Adverse Effect Level, NOAEL** *See NOEC.*

**normal solution** A *solution* containing the *equivalent weight* in grams (the gram-equivalent) of *solute* per litre of solution. For monovalent *ions* it is the same as a *molar solution*.

**North Sea conferences** The countries of North West Europe have agreed to reduce the disposal of various hazardous substances, untreated wastewater and sludge into the North Sea and adjoining ocean. Conferences have taken place in 1984, 1987, 1990 and 1995. *See MARPOL.*

**Norwalk virus** A virus that can cause gastroenteritis. The common route of transmission is *faecal-oral* via food or water. Unlike most viruses, the contraction of the Norwalk virus gives life long immunity. It is not controlled by normal levels of chlorination of drinking water.

**nozzle bowl centrifuge** A *disc centrifuge*.

**No<sub>x</sub> Nitrogen oxides.**

**NPDES National Pollution Discharge Elimination System.**

**NPEs Nonylphenol ethoxylates.**

**NPL** *See National Priorities List.*

**NPS pollution Non-point source pollution.**

**NRA National Rivers Authority.**

**NSSC** Neutral sulphite semi-chemical pulp, a papermaking process.

**NTA Nitrilo-triacetic acid.**

**NTU Nephelometric turbidity unit.**

**nuclear reactor wastes** *See radioactive wastes.*

**nuggetiser** A *fragmentiser*.

**nuisance** *See statutory nuisance.*

**numeric biocriteria** *See biocriteria, biotic index.*

**nutrient** The foods for microbial and plant life, mainly compounds of *nitrogen* and *phosphorus* but also of *potassium, magnesium, iron, calcium, cobalt, copper, sulphur, zinc* and others. Although oxygen and water are essential to life, they are not commonly called nutrients. *See eutrophication, micro-nutrient, nutrient removal.*

**nutrient cycles** The *regeneration* and cycling of *nutrients*, particularly *carbon, nitrogen, phosphorus, sulphur*. *Primary production* releases inorganic nutrients from mineral sources, which are then available for other life forms. *See nitrogen cycle.*

**nutrient enrichment** *See eutrophication* and above.

**nutrient removal** The excessive input of nutrients can cause *eutrophication*. Consequently the reduction in nitrogen and phosphorus concentrations of wastewater discharges is increasingly important. Nutrients may be



removed by chemical or biological processes. *See nitrogen removal, phosphorus removal.*

**nutrients in sludge** *See land application of sludge.*

**N-viro process** *Lime stabilisation* of wastewater sludge where *quicklime* (CaO) is added to dewatered sludge. The reaction between the water and the quicklime raises the temperature in the sludge to 50 °C and *pasteurisation* is achieved together with stabilisation of the sludge. The sludge is kept at this temperature for at least 12 h and then followed by 8 days of storage in *windrows*. Further storage of the sludge may be required prior to use on land.

**nymph** An immature adult of some insects such as *stone flies* and *mayflies*, which develop into the *imago* (adult) without a pupal stage (*see pupa*).



---

**O and M, operation and maintenance** O and M is a major problem in some countries for water and waste treatment schemes. A lack of finance for spare parts and for labour may exist. The availability or funding to employ technical staff may be absent. Programme schedules for O and M may not exist or not be implemented. In water supply, poor installation and illegal connections can aggravate the difficulties in maintaining the scheme.

**obligate aerobic A *microbe*** that can live only in an environment containing *oxygen*, unlike a *facultative anaerobe*.

**obligate anaerobe A *microbe*** that can live only in the absence of free oxygen, unlike a *facultative anaerobe*.

**obligate parasite** A type of life that can be only a *parasite*—e.g. *viruses* and the *Plasmodium* that causes *malaria*.

**observation well A *monitoring well*.**

**occupational exposure limit, OEL** The allowable exposure of a worker to a particular contaminant over a stated time period. Long term exposure limits (LTEL) are over a working day or working week. Short term exposure limits (STEL) are over a short period such as 10 minutes. OELs are also known as threshold limit values or TLVs.

**Occupational Safety and Health Administration OSHA.**

**OCDD octochlorodibenzo-p-dioxin** See *dioxin*.

**ocean and sea dumping of waste** See *MARPOL, North Sea conferences, Oslo convention*.

**ocean temperatures** See *bathythermograph*.

**ochre deposits** See *ferruginous discharge*.

**OCPSF Organic chemical, plastics and synthetic fibres.** Wastes from the production of OCPSF can have a high concentration of *VOCs*.

**octane number** The percentage of isooctane in a blend of isooctane and *n*-heptane that gives the same anti-knock properties as the fuel being tested. Higher octane normally gave increased engine efficiency but modern petrol (gasoline) engines can be highly efficient with lower octane fuels.

**octanol water partition coefficient** A measure of the relative solubility of a chemical between water and organic material. The partition coefficient (*Kow*) is the ratio of the equilibrium concentrations of a dissolved substance in *n*-octanol and water. It is often quoted as  $\log_{10} Kow$ . High values of  $\log Kow$  imply a high organic solubility and hence a high potential for *bioaccumulation* of the substance in organisms.

**octochlorodibenzo-p-dioxin** See *dioxin*.

**octylphthalate** See *phthalates*.

**octylphenol ethoxylates, OPEs** A group of chemicals that are used as non-ionic surfactants. They may be found in polluted water and some of them show weak *oestrogenicity*, i.e. they are *endocrine disrupters*. The EU lists octylphenols as *priority substances* (under review for possible re-grading as a priority hazardous substance) in relation to aquatic discharges.

**Odonata** *Dragon flies*.

**o-DCB** Ortho-dichlorobenzene. See *dichlorobenzene*.

**odour (USA: odor) control** Odours in water are usually inter-related with taste problems which may occur due to algal growths. Wastewater which is aerobic is not smelly but it becomes malodorous when it becomes anaerobic (i.e. septic). Odours in air can result from a range of industrial processes. *Carbon adsorption beds* (GAC filters) are widely used for odour control, with the odorous gas or water being passed through beds of GAC. Filters of activated silica have also been used for odour control from air. An alternative dry process is to pass the gas through a medium impregnated with a chemical that can oxidise the unwanted odour. *Wet scrubbers* (e.g. a *packed bed scrubber*) can be used in which an acid or alkali or oxidising agent (e.g. chlorine, ozone, hydrogen peroxide) can be used to wash the odour from the gas. *Biological odour control* passes the odorous air through a filter in which microbes grow and remove the chemicals that are causing the odour. Examples include a *bioscrubber* and a *peat bed filter* (2).

**odour dilution unit, ODU** The *dilution number*.

**odour measurement** A range of instruments can be used to quantify odour, such as a *butanol wheel olfactometer*, or *scentometer*. The odour measurement may be reported as *dilution number*, *minimum detectable threshold odour concentration* or *threshold number*.

**ODP** *Ozone depletion potential*.

**ODU** The odour dilution unit. See *dilution number*.

**OECD** Organisation for Economic Co-operation and Development.

**OEL** *Occupational exposure limit*.

**oestrogenicity (USA: estrogenicity)** A property of a chemical to behave like the female hormone oestrogen with the consequent effect on male animals, reducing their fertility and even producing hermaphroditic animals. See *endocrine disruptors*.

**off gas** Gases given off e.g. from composting or digestion.

**Office of Drinking Water** The Department in the *USEPA* that sets the standards for drinking water quality in the USA. The *maximum contaminant levels* are the enforceable standard but guideline standards (maximum contaminant level guide) are also given. The maximum contaminant level (MCL) for various inorganics are listed in *Table D.2*. Various organics are listed under the specific compound. See also *Drinking Water Contaminant Candidate List*.

**Office of Water Services, OFWAT** The economic regulator for the water industry in England and Wales.

**off-line storage** In the storage of stormwater, the stormwater is diverted away from the sewer at a *combined sewer overflow* and flows to a storage tank

(or pond) or *detention basin*. When the storage is full the diverted flow goes directly to the river. After the storm, the tank contents can gravitate or be pumped back into the sewer.

**OFS process** *Oil from sludge process*.

**oil and grease analysis** See *hexane extractable material, total recoverable petroleum hydrocarbons*.

**oil coalescer** A device for separating tiny oil particles from water. The oil-water mixture passes through a special porous medium which holds back the oil drops. They coalesce as they pass through, become larger and so rise rapidly on the exit side.

**oil films** Films of crude oil hinder the passage of light into water and probably also hinder gas exchange.

**oil from sludge process**. The use of *pyrolysis* in order to maximise the production of oil from wastewater sludge. The sludge is heated to 450 °C for 30 minutes under pressure. Some char, water and gases are also produced.

**oil interceptor** A type of *oil separator*, an *intercepting trap* designed to collect oil, especially from garages, to prevent it entering and fouling the *sewer*.

**oil pollution** Oil pollution disperses and spreads over a period of days. Lighter oils (e.g. less than 13 carbon atoms) evaporate in a few days and oils of 13 to 20 carbon atoms may evaporate over a period of weeks. This leaves the viscous oils to make a thick and sticky scum. Biodegradation slowly breaks down this residue over a period of many months. The effects of oil pollution include the occlusion of light from the water, reduction in oxygen transfer from air to the water, toxicity of some of the oils to certain marine life, contamination of birds, fish and shellfish and an unsightly mess on the shore and splash zone. Oil pollution in waters can be contained by booms or barriers and cleaned up by a variety of skimmers, absorbents or sinking with an *oleophilic* sand/water mixture. Strong detergents have been used to disperse oil slicks, but caution is required because these strong detergents may be toxic to some marine or bird life.

**oil refinery effluent** Wastewater may arise from tanker ballast, water extracted from crude oil, process wastewater or rainfall runoff that has become contaminated. The mixed wastewater contains a range of organics, some of which may be toxic. Removal of the visible oil is usually by flotation using an *API separator* or *dissolved air flotation* or *inclined plate and tube separators*. Sand filters with a hot backwash have also been used. The dissolved organics can be treated by aerobic biodegradation using acclimatised bacteria in an *activated sludge* plant.

**oil separator** A tank which separates oil from water or wastewater, such as an *API separator, flotation tank, grease trap, inclined plate and tube settlers, oil coalescer*.

**oil tanker washings, slops** Every oil tanker on its return voyage empty has to wash out its tanks somewhere. Under the load-on-top system ships do not discharge any washings into the sea and the receiving refineries agreed to receive the slops. See *oil pollution*.

**oleophilic** Oil loving, i.e. a substance that attracts or attaches to oil.

**oleophobic** Oil hating, i.e. a substance that is not attracted to oil nor is immiscible with oil.

**olfactometer** A device that can be used for measuring the intensity of odour.

The dynamic force choice triangle olfactometer introduces different concentrations of samples continuously to 6 sniffing cups. Each cup contains three ports, two with purified air and one with a dilution of the sample.

Each cup can be sniffed and the port that contains the sample is selected.

**olfactory** Related to the sense of smell.

**oligochaete, Oligochaeta** Segmented worms having a few bristles (chaetae), often found in polluted rivers, *trickling filters* and occasionally in *activated sludge*—for example, *Lumbriculidae*, *Nais* and *Tubificidae*.

**oligosaprobic river** A river with little pollution, in the *saprobic classification*.

It has high dissolved oxygen, little or no organic pollution and a wide variety of plants and animals. There is an appreciable proportion of *freshwater shrimps, caddis flies, mayflies* and *stone flies*.

**oligosotrophic** Description of a water with little life because of the low content of *nutrients*. The water is clear and may contain *game fish*. It is aesthetically pleasing and there are no *blooms*. Compare *eutrophic*.

**once through cooling, single pass c., direct c.** A cooling system for industrial plant or for domestic air conditioners. It is wasteful because it uses the water only once before discharge, thus spending about 100 times as much water as an *open recirculation system*. It is common for seaside power stations.

***Onchocerca volvulus*** A *nematode* worm with a 15 year life, which is a *parasite* on humans, breeding under the skin and eventually causing *onchocerciasis*.

It is transmitted to people by another *host*, *Simulium damnosum*.

**onchocerciasis, river blindness** A type of *filariasis* that affects people in Africa, South America and Central America with a debilitating and incurable skin disease that may lead eventually to blindness. It is caused by the nematode parasite *Onchocerca volvulus*. The intermediate host is the blackfly, *Simulium damnosum*, which transmits the disease between humans by biting and drinking human blood. The fly larvae live on rocks in torrential water in warm climates. When a river is dammed the rapids may be drowned thus reducing the breeding grounds. Water management schemes that increase water rapids increase the breeding grounds and possibly further spread the disease of river blindness.

**oncogenesis** The formation of cancerous tumours.

**one pass flocculator clarifier** See *flocculator clarifier*.

**on-line storage** A storage tank (or pond) or *detention basin* for stormwater through which wastewater flows, even in dry conditions. When the storage is full, any excess flow is diverted to the river. Compare *off-line storage*.

**on site compaction** The use of *static compaction* at apartment blocks, office buildings, etc. The compacted volume may be as small as 20% of the original or as large as 60% of it. If on site compaction is used before *incineration*, the compacted refuse must be broken up again before it enters the incinerator. On site compaction of garbage makes the storage area neater and smaller. It discourages the flies, rats, cockroaches, etc.

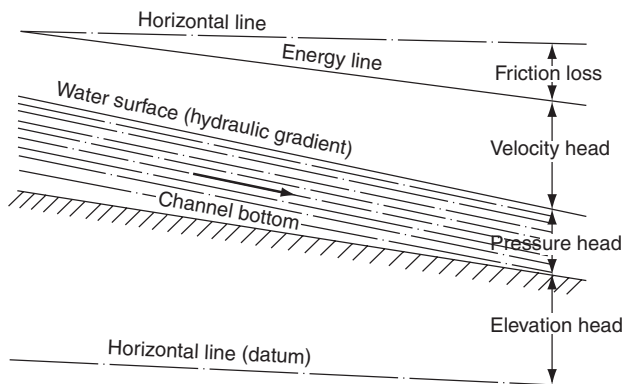

**Figure O.1** Open channel flow. This example indicates an increase in velocity as the flow moves downstream, so the velocity head increases and the pressure head decreases.

**on site incinerator** An *incinerator* installed at the industrial premises or hospital or block of flats etc.

**on site treatment** The treatment of a waste stream (gaseous, liquid or solid) at the site where it has been produced. *See in house treatment.*

**oozyst** The cyst like part of the life cycle of some protozoa such as in the protozoal diseases *cryptosporidiosis*. Oocysts have a tough shell and are very robust in many environments.

**opacity** Opaqueness. The amount by which vision is obscured, often based on *Ringelmann chart* numbers.

**opacity monitor** A *smoke density meter*.

**OPE** *Octylphenol ethoxylates*.

**open burning** Burning of refuse at a landfill site. It is inadvisable because it pollutes the air and can cause *landfill fires*.

**open channel flow** Flow in a pipe that is not running full is regarded as flow in an open channel because any free surface of water is normally at atmospheric pressure (*see Figure O.1*) *Compare pipe flow.*

**open recirculation system** An industrial cooling system, mainly for power generation, in which the water is cooled in towers and recirculated with only a small loss of water to atmosphere by evaporation. It consumes much less water than a *once through system* but more than a *closed recirculation system*.

**operation and maintenance** *See O and M.*

**Operator and Pollution Risk Appraisal, OPRA** In England and Wales, a system published by the *Environment Agency* for assessing the risks posed by an industrial process subject to *Integrated Pollution Control*. In 2000 the scheme was extended to cover waste disposal.

**Opercularia** Stalked *ciliate protozoa* that live in colonies and are common in *trickling filters* and healthy *activated sludges*. They may also be found in polluted streams.

**OPRA** *Operator and Pollution Risk Appraisal.*

**optical diameter** A description of particle size which implies that the particle has been seen and its diameter determined under a *microscope* by comparison with graduations on the reticule. See *Stokes diameter*.

**optical microscope, light m.** A viewing instrument that can magnify up to about 1000 times but no more. Much greater magnification can be had with the *electron microscope*. Fungi, algae and colonies of bacteria can be seen but it may be difficult to see single bacteria.

**optical separation** A glass industry separation method that involves a photoelectric cell detecting each piece of glass that is the wrong colour, followed by the activation of an air blast to push it out of the flow.

**order** In *taxonomy*, a division below class, not formally accepted.

**organic** Concerned with compounds containing carbon—carbon bonds. The term excludes carbonates,  $\text{CO}_3^{2-}$ ; bicarbonates,  $\text{HCO}_3^-$ ; carbon dioxide; and carbon monoxide. In domestic wastewater, the organics are mainly metabolic wastes from the faeces or urine plus grease, oil, detergents, etc., from the kitchen. About 50% of the organics in domestic wastewater are solid. Some of these settle in *primary sedimentation*, but the finely divided or colloidal organic solids are adsorbed, absorbed and metabolised in aerobic biological treatment. During *anaerobic* treatment (e.g. in *anaerobic sludge digesters*) some of the solids will be hydrolysed by bacteria to form simpler soluble organics. See *organics in solid waste, organochlorine compounds, trace organics*.

**organic iron.** Waters containing humic substances and fulvic acids can be high in iron that is bound in the organic molecules.

**organic load, o. loading** The rate of application of organic material to a treatment process or natural environment. It is the concentration of organics multiplied by the flow of the water or wastewater. For a discharge to a river, this may be calculated as the  $\text{BOD}_5$  multiplied by the flow to give a value of mass of  $\text{BOD}_5$  per unit time (e.g. kg of  $\text{BOD}_5$  per day). The organic loading on a treatment process is defined differently for differing processes. Thus, for *trickling filters* or *anaerobic sludge digestion* and sometimes for *activated sludge* it is expressed in kg  $\text{BOD}_5$  per day per  $\text{m}^3$  of tank (*volumetric loading*). However, the *F:M ratio* is often used for activated sludge. For *rotating biological contactors*, organic loading is expressed in kg  $\text{BOD}_5$  applied per day per  $\text{m}^2$  of disc area. For waste stabilisation ponds, the organic loading is based on kg of  $\text{BOD}_5$  per hectare of pond area per day.

**organic load in a stream** Dissolved and suspended organic compounds can be biodegraded by bacteria and thereby consume the oxygen dissolved in the stream. The organics thus create a demand for oxygen from the stream's oxygen supply. If the load is high and the flow is sluggish, its water is likely to be excessively deoxygenated and may become *anaerobic*. A stream with *turbulent flow* will be able to take up oxygen from the air many times more rapidly than a sluggish stream and will suffer less severely from organic pollution. See *oxygen balance, oxygen demand*.

**organic nitrogen** *Nitrogen* in domestic wastewater exists in combined form, the main organic compounds being *amino acids, proteins* or *urea*, which

- are determined by the *Kjeldahl technique*. Bacteria can hydrolyse most organic nitrogen to *ammonia*. Ammonia and its compounds, as well as *nitrates*, are not organic.
- organic residuals** (1) The biological solids wasted from a wastewater treatment process. See *wastewater sludge*. (2) The organics still remaining in wastewater after treatment, e.g. *hard COD*.
- organics in solid waste** Between 10 to 40% of domestic solid waste is from waste food. Paper, cardboard and *garden waste* are the other major organic components of domestic waste. The waste can be over 60% biodegradable. In countries where garbage grinders are popular, the quantity of waste food going into the domestic solid waste stream is substantially reduced.
- organochlorine compounds** Organic compounds that contain chlorine. They are a wide range of compounds that have had a major impact on environmental pollution in recent decades. They may be toxic giving rise to a range of human health concerns. They often have a low solubility in water but high solubility in fat. The compounds may undergo *biomagnification* in food chains. They may be non-biodegradable. The level of organochlorine compounds in drinking water should be strictly limited. These compounds include insecticides such as *aldrin*, *BHC*, *DDT*, *dieldrin*, *endrin*, *heptachlorlindane*; fungicides such as *pentachlorophenol*; herbicides such as *2,4-D* and *2,4,5-T*.
- organoleptic** Parameters and properties of a substance that can affect the human senses or the human organs.
- organophile** A material that has an attraction for organic compounds.
- organotin** See *tributyl tin*.
- organotroph** Micro-organisms that use organic compounds as the food source and the source of carbon.
- ORP** Oxidation reduction potential, *redox potential*.
- Orsat apparatus** A gas analysis apparatus that measures CO<sub>2</sub>, CO and O<sub>2</sub> by passing the gas mixture through various liquids that absorb them. Addition of an oxidative assembly enables it to measure methane or to analyse *sludge gas*.
- orthophosphate** A salt that ends with PO<sub>4</sub>, i.e. a simple salt of phosphoric acid, H<sub>3</sub>PO<sub>4</sub>, not a metaphosphate (e.g. NaPO<sub>3</sub>) or a pyrophosphate (e.g. Na<sub>4</sub>P<sub>2</sub>O<sub>7</sub>). Orthophosphates are sometimes added to plumbosolvent waters acid in order to form an adherent coat of lead phosphate on the inside of the lead pipe and thereby substantially reduce lead corrosion. See *plumbosolvency*, *polyphosphate*, *phosphorus*.
- Oscillatoria** Filamentous *cyanobacteria* (blue green algae) that release *endotoxins* into water. It is common in waters with high organic pollution.
- OSHA** The US Occupational Safety and Health Administration. Together with the *ACGIH*, they determine the allowable occupational exposure concentrations for some pollutants.
- Oslo convention, 1972** West European countries agreed to ban or reduce the dumping of a range of wastes in the North Sea and the ocean between Greenland and Europe. The disposal of waste at sea has been further reduced by the implementation of *MARPOL* and the *North Sea conferences*.



**osmosis** Diffusion of water through a *semi-permeable membrane* from a dilute to a more concentrated solution without any corresponding movement of *solute*. The tendency is for the two concentrations to equalise. In a tropical rain forest, the large forces responsible for raising the water from the roots of a tree to its leaves are generated by the osmotic pressure in the leaf cells. The water, evaporating from the leaves, concentrates the solutions in them. Capillarity is not involved. *See reverse osmosis*, and *See Figure R.6*.

**OSPAR Conventions** Conventions for the Protection of the Marine Environment of the North-East Atlantic. (OSPAR stands for Oslo and Paris)

**OSWMD** On Site Wastewater Management Districts Areas that have been organised in the USA in order to manage small private wastewater treatment facilities that otherwise may be designed or installed or operated incorrectly. The OSWMD may be organised and managed by the local water company.

**Otto HCR, Otto High performance Compact Reactor** A type of *tower reactor* (1).

**OUR** *Oxygen uptake rates*.

**outage** *Down time*.

**outfall** The opening at the end of a sewer from which effluent or wastewater is discharged into a river, lake, sea, etc. One or more *diffusers* near the outfall may help the sewage to disperse. At sea, wastewater is liable to rise to the surface because seawater is denser and often also cooler. *See sea outfall*.

**ovality** In a pipe that is not (or no longer) circular, two definitions are used. (1) The difference between the maximum and mean diameter divided by the mean diameter. (2) The difference of the mean and minimum diameter divided by the mean diameter.

**overband separator, suspended magnet s.** A *magnetic separator* in the form of a short cross conveyor belt with an electromagnet inside it just above the bottom strand of the cross belt (*Figure O.2*). The magnetic field

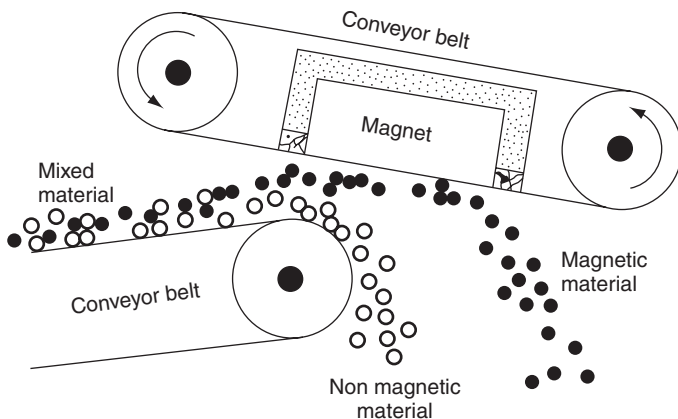

**Figure O.2** Overband separator.

- of the electromagnet lifts iron and steel pieces off the refuse belt below it and the cross belt pulls them off it sideways, dropping them into a chute beside the refuse belt. They automatically disconnect from the short belt of the separator as they approach its pulley.
- overburden pressure, lithostatic p., cover load p.** The rock pressure in a mine caused by the weight of the overlying rocks.
- overfire air, overgrate a.** See *secondary air*.
- overflow** See *combined sewer overflow*.
- overflow rate, o. velocity** This term is usually synonymous with *surface loading rate* but may mean *upflow velocity*.
- overhung latrine** A latrine from which the excreta fall directly on to a tidal flat, river or canal.
- overland flow, surface runoff** Water from rain, etc., which travels over the ground surface to a stream, channel, conduit, etc. See *runoff coefficient*.
- overland flow land treatment** *Land treatment* of wastewater or wastewater effluents involving vegetated slopes at 1:15 to 1:100. The effluent is collected and percolation of the wastewater into the soil should be minimised. Channel distribution may be better than sprays. The feed channels and collection channels must be kept clear and the soil may have to be rested for tillage. Typical results for removal of suspended solids are 60 to 90% with a BOD reduction of 50 to 95% and some reduction in bacteria, nitrogen and phosphorus. The amount of wastewater fed to the plots varies with soil and climate, but may be from 0.5 to 5 ha per 1000 m<sup>3</sup>/d of wastewater. See *Figure L.5*.
- overland flow wetland** See *constructed wetland*.
- overpumping of wells** Removal of too much water from a well may excessively lower the *water table*. This can alter the structure of the *aquifer* or cause *saline intrusion* if it is near the coast.
- oversize** The material that cannot pass through a *screen*. Nevertheless, depending on the screening effectiveness, it always contains some *undersize*.
- overturn of lakes** See *thermal stratification*.
- oxidant** In general, an *oxidising agent* but specifically in air pollution a *photochemical oxidant*.
- oxidation.** The addition of oxygen or the loss of electrons. The treatment of domestic wastewater often involves oxidation using bacteria or other microbes—i.e. biochemical oxidation. The opposite of oxidation is *reduction*.
- oxidation ditch, ring d., Pasveer d.** A type of *extended aeration*, a Dutch development due to A. Pasveer, in which *brush aerators* such as the *Kessener brush* aerate and circulate the *mixed liquor* through a channel dug to the shape of an oval in plan (see *Figure O.3*). The flow rate is about 0.3 m/s. Operation may be continuous or intermittent. For continuous operation an *activated sludge* settling tank is provided, with a pumped recycle of sludge to the ditch. For intermittent operation the rotors are periodically stopped to allow the sludge to settle in the ditch. A batch of effluent is then discharged, and a corresponding volume of untreated wastewater is brought in. Ditches for small communities are 1.5 to 2 m

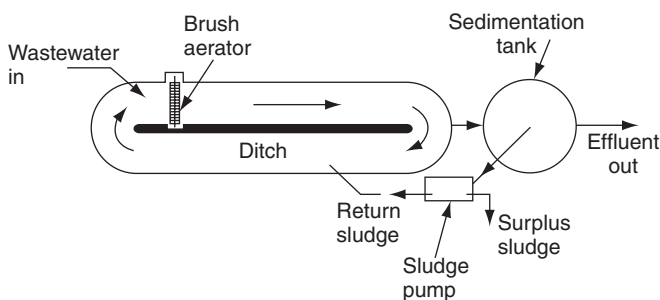

**Figure O.3** Oxidation ditch, continuous system.

deep but this may be increased to 4m for large plants. *MLSS* is maintained at about 3000 to 5000 mg/l. *Organic loadings, sludge production* and effluent quality have the values stated for *extended aeration* plants. Oxidation ditches have been used to treat the wastewater from a *population equivalent* above 100 000. *See also Carousel system.*

**oxidation pond** A term that can mean *aerated lagoon, high rate aerobic stabilisation pond* or *maturation pond*. It may mean *waste stabilisation pond*.

**oxidation prevention** An *acid mine drainage* pollution prevention measure, involving the injection of cement mortar into fractures in sulphide rich zones to prevent them oxidising further. Drainage is allowed around the grouted zones but the grout prevents water and air reaching the richest ore. Mining is not precluded as it may be when underground dams are built in *discharge prevention* methods. Oxidation prevention also helps the mining engineer by reducing the corrosion of his equipment.

**oxidation reduction potential, ORP** The *redox potential*.

**oxides of nitrogen** *Nitrogen oxides*.

**oxidising agent** A substance that loses oxygen or gains electrons in an *oxidation* reaction, thereby itself suffering *reduction*.

**oxygen, O<sub>2</sub>** The colourless, odourless gas that forms about one fifth of normal air and is essential to the life of vertebrates, including humans, and much other life. It is provided by *photosynthesis*, but is also the most abundant element in the earth's crust, forming 45% of it, in combination with other elements. *See above and below; see also ozone.*

**oxygen activated sludge** Injection of oxygen instead of air into the *aeration tanks* of an *activated sludge* process. Oxygen is only 21% of air; consequently, pure oxygen can maintain higher dissolved oxygen levels and cope with higher oxygen demands. With the same *aerators* and other conditions, theoretically four times as much oxygen can be dissolved as with air. The aeration tanks are covered to enable the oxygen atmosphere to be recycled into the *mixed liquor* and finally vented from the last compartment with about 50% CO<sub>2</sub>. The *MLSS* in the aeration tanks can be maintained at 6000 to 8000 mg/l, which reduces the aeration tank volume for a given *F : M ratio*. The oxygen, which is usually produced on

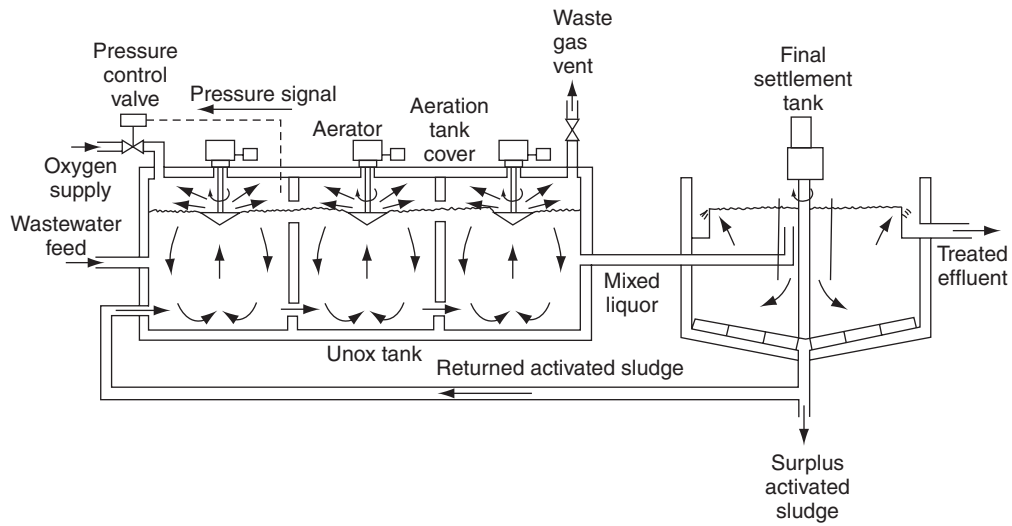

**Figure O.4** Oxygen activated sludge, Unox system.

site, can be expensive and outweigh the lower cost of the aeration tanks and savings in blower energy. Many claims are made for oxygen aeration in comparison with air: the activated sludge settles better in the *secondary sedimentation tanks*; high *F : M ratios* are possible and *bulking* is prevented.

**oxygenated solvents** Organic solvents that contain oxygen atom(s), such as ketones and ethers.

**oxygenation** In water treatment, but particularly wastewater treatment, this means getting oxygen to dissolve in water. *See also dissolved oxygen, game fish.*

**oxygenation capacity** The rate of absorption of oxygen in deoxygenated liquid expressed in kg per h at 760 mmHg, resulting from the use of an *aerator*.

**oxygenation efficiency, oxygen transfer efficiency** The percentage of oxygen dissolved in the de-oxygenated water or wastewater compared to the quantity supplied. It varies from 15% or less for *coarse bubble aeration* to 30% or more for *fine bubble aeration*, where the transfer of oxygen from the air to the water is more efficient due to the smaller bubbles. The standard measurement is taken at 20 °C and 760 mm of Hg.

**oxygenation rate, oxygen transfer rate** The quantity of oxygen dissolved (in kg) in the water or wastewater per kWh of power supplied to the aeration device (e.g. *surface aerators* or compressors for *diffused aeration*). It is typically in the range 1.5 to 4 kg of oxygen per kWh.

**oxygen balance of natural waters** Oxygen is available in solution in a river, lake or sea from three main sources: dissolved oxygen; *reaeration* when turbulence at the water surface dissolves more oxygen; and oxygen released into solution from algae or other water plants by their *photosynthesis*. Oxygen is removed from solution by bacteria, fish and many other forms of water life and the overall result of the uptakes and consumptions is called the oxygen balance. It can be affected by many factors. The speed of the chemical and *biochemical* reactions increases with temperature but the *air saturation value* decreases as temperature rises. At high river flows, bottom mud may be resuspended and exert an extra oxygen demand but the extra turbulence increases the *aeration*. At low flows, organic solids may settle out and reduce the oxygen demand of the river. Oil films may hinder reaeration at the water surface. Sunlight encourages photosynthesis. Toxic substances may reduce the biochemical activity of micro-organisms, etc.

**oxygen deficit** The amount by which the dissolved oxygen is less than the *air saturation value*. *See oxygen sag curve.*

**oxygen demand** *See biochemical oxygen demand, chemical oxygen demand, nitrogenous BOD, total oxygen demand, ultimate oxygen demand.*

**oxygen injection** *See air injection.*

**oxygen sag curve** A graph of *dissolved oxygen* (DO) against time, plotted for a watercourse from the point of addition of pollution (*see Figure O.5*). It shows the drop in DO, the sag in the curve picking up again after an interval, which indicates *self purification* in the river and the change in the *oxygen balance* in this distance downstream. When excessive pollution is

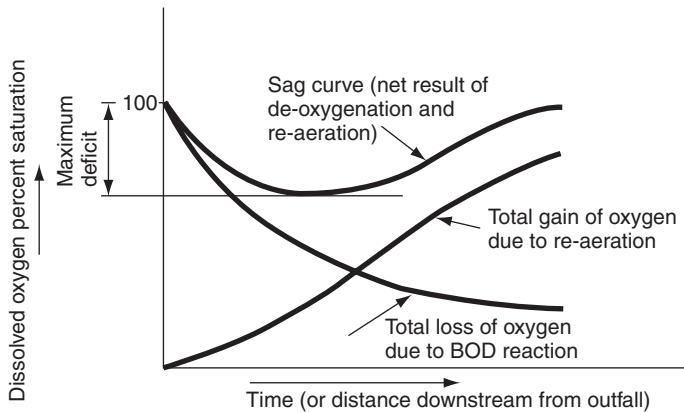

**Figure O.5** Oxygen sag curve. The variation of dissolved oxygen in a river saturated with oxygen that receives a discharge of untreated domestic wastewater.

added, the DO may drop to zero for a period. Many mathematical models have been made to simulate the effect of pollution on the *oxygen deficit* of a river.

**oxygen saturation value** (1) The concentration of oxygen in water in equilibrium with an oxygen atmosphere. (2) *Air saturation value*.

**oxygen transfer efficiency** See *oxygenation efficiency*.

**oxygen transfer rate** See *oxygenation rate*.

**oxygen uptake rate, OUR** For *activated sludge*, the rate of absorption of oxygen expressed in mg O<sub>2</sub> per litre per unit of time (minutes or hours) See *specific oxygen uptake rate*.

**ozonation** The injection of an *ozone* air mixture into clean filtered water, normally to disinfect the water but sometimes for other reasons, such as removal of colour or oxidation of manganese. Ozone quickly decomposes to oxygen. It is made on-site in an *ozoniser*. Ozone is a powerful disinfectant. For water disinfection, 5 to 10 minutes contact time is needed if there is 1% ozone in the ozone-air mixture injected into the water. It is a more efficient disinfectant than chlorine, but ozone decomposes in a few minutes whereas chlorine residuals last many hours. Ozone has a lower tendency to make undesirable *disinfection by-products* than chlorine. The main disadvantage is the cost of making the ozone and the lack of any *residual disinfectant*. For wastewater disinfection, the lack of any residual ozone can be an advantage, because, in *chlorination*, the chlorine residual can be a problem for the receiving water.

**ozone, O<sub>3</sub>** Ozone is a poisonous blue gas that decomposes rapidly to oxygen. It is a strong oxidising agent that has limited solubility in water. It is used as a water disinfectant (see *ozonation*). Ozone is also an air pollutant. It occurs due to photochemical reactions in air between hydrocarbons, *nitrogen oxides* (NO<sub>x</sub>) and ozone to produce more ozone and NO<sub>2</sub>. These reactions also produce *PAN* and the appearance of a *photochemical smog*.

Since 1995, the EU Directive has required O<sub>3</sub> to be monitored in EU Member States and the recommended ozone air quality standard is 110 µg/m<sup>3</sup> (0.055 ppm) averaged over eight hours. The public must be informed when the ozone concentration goes above 180 µg/m<sup>3</sup>. By 2010, EU Member States must not exceed 120 µg/m<sup>3</sup> on more than 20 days per year. In the USA, *NAAQS* has set an ozone air quality standard of 235 µg/m<sup>3</sup> (0.12 p.p.m.) over one hour and 157 µg/m<sup>3</sup> (0.08 p.p.m.) over 8 hours.

**ozone depletion** The ozone layer in the upper atmosphere is essential to prevent excessive radiation reaching the surface of the earth from the sun. The ozone is being depleted by the chemical decomposition of *chlorofluorocarbons* (CFCs) and other ozone depleting substances that release chlorine or other chemicals which rises upwards in the atmosphere to damage the ozone layer. Holes in the ozone layer now periodically appear in the polar regions. *See Montreal Declaration, Helsinki Declaration.*

**ozone depleting substance** A substance that can deplete the ozone layer. Examples include *chlorofluorocarbons* (CFCs), *hydrochlorofluorocarbons* (HCFCs), and methyl bromide.

**ozone depletion potential, ODP** The potential for a substance to deplete the ozone layer compared to *chlorofluorocarbons* (CFCs).

**ozone treatment of hazardous waste** A chemical oxidation technique in which ozone is contacted with the contaminated water or waste water. Ozone is capable of oxidising a range of organic molecules as well as cyanide. It may be used in conjunction with UV.

**ozone/UV process** The *UV/ozone process*.

**ozoniser** An electrical discharge unit operating at 5000 to 20 000 V and 50 to 500 Hz, which converts some of the oxygen in air to ozone. It produces air with about 1% ozone. Dust and moisture must be removed from the air before entering the ozoniser, otherwise flashover occurs. *See ozonation.*

**ozonising** *Ozonation.*

**ozonolysis** The oxidation of a material by ozone.



---

**p** The symbol for pico or  $10^{-12}$ .

**PAA** *Peroxyacetic acid.*

**PAC** *Powdered activated carbon.*

**package wastewater treatment plants** A complete small treatment plant made at a factory and placed on site. For wastewater treatment, the package plant may contain primary sedimentation, aerobic biological treatment (e.g. *activated sludge* or *rotating biological contactor*), secondary sedimentation and sludge storage. The small local nature of the population that is served by a package plant can result in large variations in flow giving hydraulic shock loads to the treatment processes. Periodic substantial discharges of disinfectants or detergents associated with regimented cleaning at a hotel, caravan park, etc, can give rise to problems with the biological treatment processes. Other problems include excessive discharge of grease (e.g. from onsite restaurants) and a lack of trained personnel leading to poor maintenance of the plant.

**Packaging and Packaging Waste Directive 1994** An EU Directive that sets minimum recycling targets for packaging waste. Each Member State should recycle 60% of its packaging waste by 2006. *See packaging recovery notes.*

**packaging derived fuel, PDF** *Refuse derived fuel* made exclusively from waste packaging material. It has a calorific value 80% of coal.

**packaging recovery notes, PRNs** As part of the Packaging and Packaging Waste Directive 1994, the quantity of packaging that an industrialist has recovered must be recorded. If the company has recovered more than its requirement, it can sell the excess notes to a company that has difficulty in meeting the requirements.

**packed bed filter** Any treatment process in which a solid medium is packed into a tank or tower. Examples in water and wastewater treatment include *anaerobic filter* (Figure A.9), *anoxic filter*, *denitrifying filter*, *nitrifying filter*, *rapid deep bed filter* (e.g. Figure R.3), or *trickling filter* (Figure T.3).

**packed bed reactor, p. b. filter** Any treatment process in which a solid medium is packed into a tank or tower. Examples in water and wastewater treatment are given in *packed bed filter*. In air pollution control, the common example is a *packed bed scrubber*.

**packed bed scrubber** (1) A type of *wet scrubber* consisting of a tower packed with media (typically *plastic media* (see Figure P.1) or metal mesh or wooden slats) down which the reagent (scrubbing or washwater) trickles. The air



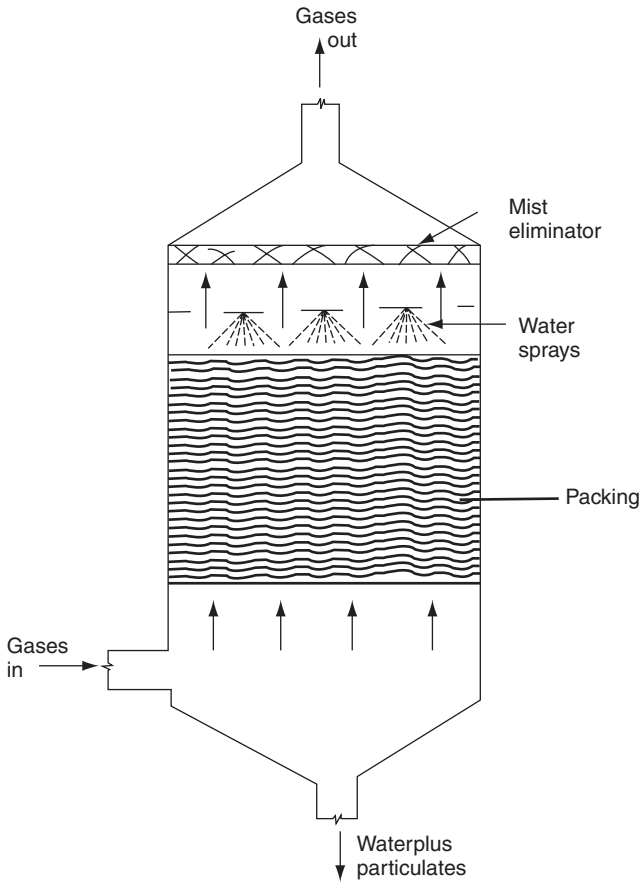

Figure P.1 Packed bed scrubber.

flow to be cleaned normally flows up through the tower (i.e. countercurrent to the scrubbing liquid). Gases with a high concentration of particulates may clog a packed tower. A packed bed scrubber can also be used as an *entrainment separator*. See *moving bed scrubber*. (2) A *bioscrubber*. (3) The term may be used to mean a *packed tower aerator*.

**packed tower A** *packed bed scrubber* (1) or a *packed tower aerator*.

**packed tower aerator, p. t. air stripper** A common method for aerating water which can also achieve the removal of unwanted gases (e.g.  $\text{CO}_2$  or ammonia) or *VOCs*, a process known as *air stripping* or *ammonia stripping*. The water flows down the tower over plastic media with air blown up through the tower. Towers may be 2.5 to 7 m high, depending on the application. Packed tower aerators are a type of *cascade aerator*. See *Figure C.1*.

**packing** See *medium* (2).

**PACT process, powdered activated carbon treatment process** A wastewater treatment process in which *powdered activated carbon* (PAC) is added to the aeration tank of the *activated sludge* plant. The PAC is recycled with the return activated sludge from the sedimentation tank. The main advantage of adding PAC is the removal of toxic chemicals or *hard COD* that are otherwise not removed or biodegraded in a conventional activated sludge plant.

**PAH** *Polycyclic aromatic hydrocarbons.*

**palaeolimnology** The study of past *limnology* from the records provided by sediment cores extracted from a lake bed.

**palatability of water** *See taste and palatability of water.*

**P alkalinity** Phenolphthalein orange alkalinity, i.e. *caustic alkalinity.*

**palm and sludger tube well** A type of *jettted tube well* for manually digging a water well in soft ground. A pipe is moved up and down in the ground by a lever. The hole is full of water to soften the soil. When the pipe is pushed down water comes out of the pipe and when the pipe moves up a person's hand covers the top of the pipe. The water that comes out of the out of the well via the pipe removes the soil material and allows the pipe to be further sunk into the ground.

**paludal, palustrine** Relating to marshes or wetlands.

**PAMs** *Polyacrylamides.*

**PANs, peroxyacetyl nitrates** A group of organic compounds with the general formula of  $R \cdot C \cdot OO \cdot NO_2$ . PAN sometimes refers specifically to the compound peroxyacetyl nitrate  $CH_3 \cdot C \cdot OO \cdot NO_2$ . Another important PAN is peroxybenzoyl nitrate (PBzN). PANs are oxidants that irritate the eyes. They occur in polluted air from reactions between hydrocarbons, *ozone*, *VOCs* and *nitric oxide*. The concentrations of PAN can reach 0.3 ppm that is typically 1 to 2% of the ozone concentration.

**P and I diagram** A piping and instrumentation diagram.

**paper and pulp manufacturing wastewater** Wood is prepared for papermaking either mechanically by grinding with water into a pulp or chemically by heating wood chips with calcium bisulphite (sulphite process), or with a mixture of sodium sulphide, sulphate, hydroxide and carbonate (*kraft* process). Chemical pulping produces a highly polluted waste water with a  $BOD_5$  that may exceed 500 000 mg/l. However, the pulping wastes are often diluted by the paper finishing processes to give a mixed effluent of about 200 to 2000 mg/l  $BOD_5$ .

**paper recycling** Waste paper can be collected separately from the householder by a *separation at source scheme* or collected at a *drop off centre*. Before recycling, waste paper is processed in different ways, depending on the nature of the waste paper steam and the required end use of the recycled paper. Waste newspaper must be de-inked before being recycled to make more newsprint. Poor quality waste paper is used to make packaging material.

**paper stock** Waste paper.

**Paramecium** A free swimming *ciliate protozoon* which may occur in *activated sludge* or organically polluted waters.

**parasite** (adjective **parasitic**) An organism that obtains food from another, normally larger one called the *host*, in or on which it lives, for the whole or part of its life. *See obligate parasite.*

**parasitic worms** *See helminthic diseases.*

**paratyphoid** A disease slightly less serious than *typhoid*, caused by bacterium, *Salmonella paratyphi*. It may be waterborne or come from infected food. It is passed in the faeces of the infected person.

**Parshall flume** A specific design of a *Venturi flume*. The bed of the flume rises slightly at the throat of the flume then drops slightly just after the throat. The flow of water is calculated from measuring the head of water at the throat and upstream of the flume.

**partially separate system** A *sewerage* system in which each street has two sets of *sewers*, one *foul sewer* and one for stormwater. Unlike the rigidly *separate system*, the rainwater from the back yard and house back roof drains into the foul sewer.

**particle size distribution, grain size d.** The proportions of grains of different sizes that make up a particular sand, gravel, refuse, etc., usually expressed in percentage by weight. *See Coulter counter, effective size, uniformity coefficient.*

**particulates, particles** In air pollution, smoke is particles less than 1  $\mu\text{m}$ , dust particles are between 1 to 75  $\mu\text{m}$  and grit particles are greater than 75  $\mu\text{m}$ . Particles of less than 10  $\mu\text{m}$  usually remain in the atmosphere until removed by precipitation. Particles less than 3.5  $\mu\text{m}$  to 5  $\mu\text{m}$  are deposited in the lung, 5–10  $\mu\text{m}$  particles are deposited in the bronchial tubes and particles greater than 10  $\mu\text{m}$  are deposited in the nasal passage. A particle of 1  $\mu\text{m}$  has a settling velocity of approximately 0.06 mm/sec. EU Directive requires particulates to be less than 80  $\mu\text{g}/\text{m}^3$  in air as an annual median. In the USA, *NAAQS* has set a standard of 150  $\mu\text{g}/\text{m}^3$  averaged over a 24 hour period (but *see also PM2.5, PM10*). *See total suspended particulates.*

**particulates removal** The removal of particles from air or gases. *See dust arrestor.*

**parts per billion, ppb.** Parts per thousand million.

**parts per million, ppm.** One part per million is 1 g/t or 1 mg/kg. 1 p.p.m. is often taken to be 1 mg/l but this is true only when the density equals 1.0 g/cc. Concentrations in liquids, therefore, should be expressed in mg/l in all instances where high accuracy is needed.

**passive smoking** *See tobacco smoke.*

**passive venting of landfills** The use of the natural pressure of the *landfill gas* in a landfill to remove the gas through *landfill gas vents* or *landfill gas wells*, i.e. the gas is not pumped.

**passivity** Non-reactive, often applied to a metal that is resistant to corrosion.

***Pasteurella tularensis*** One type of the bacteria that cause *tularaemia*.

**pasteurisation, pasteurization** The heating of a liquid or sludge in order to kill or inactivate any micro-organism. Wastewater sludge can be pasteurised by heating to 70 °C for 30 minutes.

**Pasveer ditch** An *oxidation ditch*.

**pathogen** (adjective **pathogenic**) A microbe that causes disease.

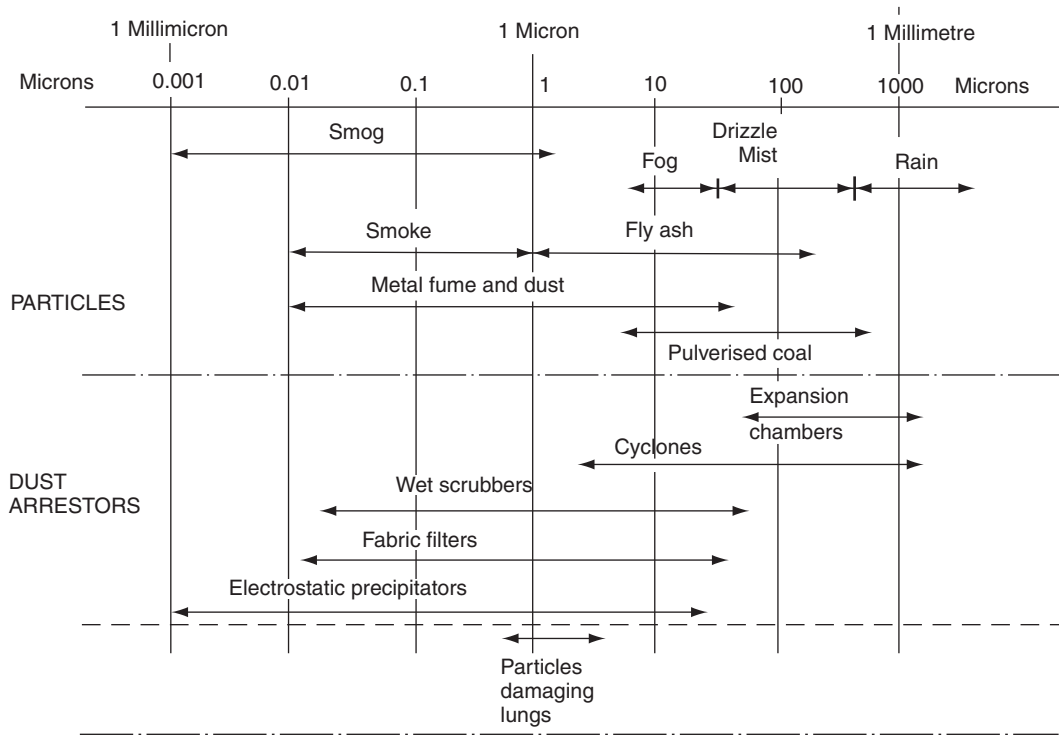

**Figure P.2** Particle sizes and dust catching equipment.

**paved area storage** Stormwater that is retained on paved areas preventing the water from running off.

**PBBs** *Polybrominated biphenyls*.

**PBDEs** *Polybrominated diphenylethers*.

**PBTs** Persistent, bioaccumulative, and toxic pollutants.

**PBzN** Peroxybenzoyl nitrate. *See PANs*.

**PCB** *Polychlorinated biphenyls*.

**PCDD** Polychlorinated dibenzodioxin. *See dioxin*.

**PCDF** Polychlorinated dibenzofuran. *See dibenzofuran*.

**PCE** Perchloroethylene, i.e. *tetrachloroethene*.

**pCi** Picocuries. *See curies*.

**PCT** *Physicochemical treatment*.

**p-DCB** Para-dichlorobenzene. *See dichlorobenzene*.

**PDF** *Packaging derived fuel*.

**peat bed filter** (1) Shallow beds of peat (e.g. 1 m deep) can be used to treat septic tank effluent by percolating the effluent through the peat. (2) In air pollution, peat beds can be used to remove or control odour by passing the malodorous air up through beds of peat contained in a tower. The peat must be kept moist using a sprinkler system.

**pebble bed clarifier, Banks filter** A rectangular, upward flow, *secondary sedimentation tank* with a layer of pea gravel hung near the outlet (*see Figure P.3*). The effluent is forced to flow up through the gravel before it passes over the outlet weir. The 150 mm deep gravel bed acts as a coarse filter after the *humus sludge* has settled. The top of the gravel is 150 mm below the top water level. Periodically the water level in the tank is lowered so that the gravel layer can be hosed down and cleaned. It is most suitable for *polishing* the effluent from a small wastewater treatment works. *See sand filter*.

**PeCDD** Pentachlorodibenzodioxin. *See dioxin*.

**PeCDF** Pentachlorodibenzofuran. *See dibenzofuran*.

**pegging** The jamming of a particle in a *screen* opening (like a peg in a hole). It can be reduced by using *wedge wire screens*.

**pelagic** Concerned with the open sea, not shallow water.

**pelletiser, densifier** A machine that is fed with pulverised *refuse derived fuel*, which it extrudes as a solid cylinder of 10 mm or so diameter, broken off in convenient lengths or pellets. *See also* below.

**pellet reactor, pelletiser for sludge, Gytractor, Spiractor** A cone with its apex down, resembling a *wet cyclone*, which precipitates *calcium carbonate* during the *lime softening* of water. The water with added lime enters the cone tangentially to give it a swirl, and grains of sand or marble (0.2 to 1 mm diameter) are dropped in at the top. The grains form nuclei which attract calcium carbonate precipitate, grow and settle out when they are large enough. Design *surface loading rate* may be 20 to 50 m<sup>3</sup>/h per m<sup>2</sup> surface area of tank. The process is restricted to waters of low *turbidity* and low magnesium content.

**pellicular water** Water held against the force of gravity in the *saturated zone*, between the *soil water zone* and the *capillary fringe*.

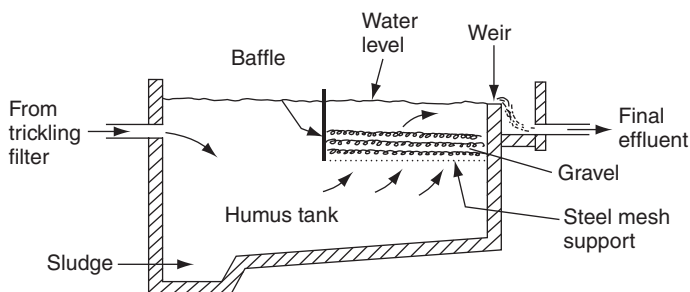

Figure P.3 Pebble bed clarifier.

**penstock (1) or sluice gate** A device to control the flow of fluid, containing a vertical gate perpendicular to the flow in an open channel. (2) In a hydroelectric scheme, a pipe, tunnel or channel leading water from a dam to turbines.

**pentabromodiphenyl ether, penta BDE** See *polybrominated diphenyl ethers*.

**pentachlorobenzene** A chemical used mainly in the production of the fungicide pentachloronitrobenzene. It is present as a contaminant of the fungicide. It can adversely affect the kidneys and liver and it may affect the reproductive system. The EU lists it as a *priority hazardous substance* in relation to aquatic discharges.

**pentachlorodibenzodioxin, PeCDD** See *dioxin*.

**pentachlorodibenzofuran, PeCDF** See *dibenzofuran*.

**pentachlorophenol** A wood preservative. It can affect the liver and kidneys in humans and it is possibly carcinogenic. The *USEPA* states a *MCL* in drinking water of 1 µg/l and the WHO guideline maximum value is 9 µg/l. The EU lists it as a *priority substance* (under review for possible re-grading as a priority hazardous substance) in relation to aquatic discharges.

**PE pipe** *Polyethylene pipe*.

**peptide link** See *proteins*.

**peracetic acid** *Peroxyacetic acid*.

**perc** *Perchloroethylene*.

**perched water table** *Groundwater* held temporarily or permanently above the main groundwater, by a relatively small layer of impervious strata in the *saturated zone*.

**perchlorate, ClO<sup>4-</sup>** An anion that is a soil pollutant and very mobile in water and groundwater. It can persist for decades and comes from ammonium, potassium or sodium perchlorate salts that can be used in a range of industrial situations. It is toxic to humans. At present perchlorates are on the *Drinking Water Contaminant Candidate List* established by the *USEPA*.

**perchlorobutadiene** *Hexachlorobutadiene*.

**perchloroethylene, perc, perclene** *Tetrachloroethene*.

**percolate** *Leachate*.

**percolating filter** A *trickling filter*.

**percolation** Movement of water through the soil, usually downwards.

**percolation area** *See soakaway.*

**percolation test, perc test, perk test** *See soil percolation test.*

**percolation value,  $V_p$**  *See soil percolation test.*

**perfluorocarbons** Chemicals that contain fluorine and carbon atoms. As they do not contain any chlorine atoms they do not destroy ozone. But they are *greenhouse gases*. They do not break down in the atmosphere and so their addition to the air is permanent. They have a range of industrial uses. Examples include the perfluoromethane which is  $CF_4$  and perfluoroethane which is  $CF_3CF_3$ .

**perforated plate screen** A type of *drum screen* with the drum consisting of perforated plate with gaps of about 6 mm or less.

**peripheral weir, launder** A *weir* around the outside edge of a circular or square *sedimentation tank*, over which the effluent flows.

**periphyton** Micro-organisms and small organisms that grow and attach to solid surfaces (e.g. stones) in rivers, lakes, etc, but above the bottom muds. They can be useful indicators of water quality.

**peristaltic pump** A pump with three rotating arms that alternately compress and release a flexible tube that is bent into a U-shape, forcing fluid along the tube. It is used to pump small, accurate volumes of water. Larger peristaltics move highly corrosive fluids because the fluid does not touch metal.

**permanent hardness** *Non-carbonate hardness.*

**permanganate value, PV** The oxygen absorbed from one-eightieth normal (N/80), occasionally N/8, potassium permanganate in dilute sulphuric acid at 27°C. Two test periods exist. The 3 minutes test measures readily oxidisable inorganic matter (nitrites, sulphides, sulphites, *ferrous salts*) and organic salts. The 4 h test measures more of the organic impurities but oxidation is less complete than in the *BOD* test. The test is quick and easy but because it oxidises only certain organics its use is limited. *See Kubel test, McGowan strength.*

**permeability** The ability of a substance to allow a fluid or a gas to pass through, as in air through a *diffuser*. For water passing through a soil it is known as *hydraulic conductivity*.

**permeability coefficient** *Hydraulic conductivity.*

**permeable active barrier, p. reactive b.** A barrier placed in the ground to prevent a contaminant from moving in a specific direction in the groundwater. The barrier is designed to react with the contaminant. Either the barrier immobilises the contaminant or it may be degraded. The barrier is typically a *slurry wall*. The reactive component is typically metallic iron.

**permeable pavement** *Porous pavement.*

**permeate** The *filtrate*.

**peroxone process** The *UV/ozone process*.

**peroxyacetic acid, peracetic acid, PAA** A chemical that has been used for disinfection of wastewater effluent or stormwater. It is made from reacting acetic acid and hydrogen peroxide and has the formula  $CH_3COOOH$ . It is unstable releasing oxygen as it dissociates back to acetic acid. It does not produce the problematic *disinfection by-products* compared to *chlorination*.

**peroxyacetyl nitrate** *PAN*.

**persistent pesticides** Pesticides that biodegrade very slowly or not at all.

**pervaporation** A membrane process that can be used for the removal of *VOCs* from water or wastewater. The membrane is a non-porous polymer to which VOCs have an attraction, e.g. silicone rubber. The VOCs diffuse through the membrane and are drawn off from the other side by a vacuum. A small quantity of water also passes through the membrane.

**pesticide** A chemical that kills pests. It includes *algicides, fungicides, herbicides, insecticides, larvicides, molluscicides, nematocides, piscicides* and *rodenticides*.

There should be at least one centre in each country or region, capable of investigating pesticide residues in drinking water (WHO). The EU Drinking Water Directive states a mandatory maximum of 0.1 µg/l for any specific pesticide (except aldrin, dieldrin, heptachlor and heptachlor epoxide, where the value is 0.03 µg/l) and a total of 0.5 µg/l for the sum of the pesticides. The *USEPA* states differing *MCLs* in drinking water for specific pesticides and likewise for the WHO guideline maximum values.

**PET Polyethylene terephthalate.**

**petrochemical industry wastewater** See *oil refinery effluent, plastics industry wastewater*.

**PFA, pulverised fuel ash** See *fly ash*.

***Pfiesteria piscicide*** A *dinoflagellate* algae that lives in estuarine waters. It releases *endotoxins* that have caused skin rashes, vomiting and other health effects in humans, such as fishermen, who have come into contact with the water.

**PFR Plug flow reactor.**

**pH** A measure of the *acidity* or *alkalinity* of water, based on its concentration of hydrogen *ions*,  $H^+$ . The pH value is a logarithmic scale. The pH equals  $-\log_{10} [H^+]$ , where  $H^+$  is the concentration of hydrogen ions. Thus, a pH of 6 is 10 times more acid than a pH of 7. A pH of 7 is neutral. A very strong acid can have a negative pH—e.g. a pH of  $-1$  means a  $H^+$  concentration of 10 mole/litre. A very strong alkali produces a high  $OH^-$  (hydroxy ion) concentration with a corresponding low  $H^+$  concentration and a pH of 14 or more. The range of pH values that allows life to continue is narrow and the *sulphur oxidising bacteria* that may thrive in acid water at pH below 3 are quite exceptional. Very few bacteria survive above pH 11. Meters can measure and record pH continuously.

**phaeophytes, Phaeophyta** The *brown algae* e.g. brown seaweed.

**phage** A *bacteriophage*.

**pharmaceutical industry wastewater** Wastes from pharmaceutical production vary with the product. Many have a high organic content and may contain toxic chemicals.

**pharmacokinetics** The rate of absorption, metabolism and storage of compounds (e.g. toxic compounds). See *toxicokinetics*.

**phase separation, PS** Concentrating micro-organisms by putting them in aqueous solution and into contact with two polymers such as dextran sulphate and polyethylene glycol. These form two phases and are chosen so that the microbes separate into the phase of the smaller volume and



concentrate to a fraction of the original volume. The method is useful for concentrating viruses or pathogenic protozoa in samples of water or wastewater and thereby assist their detection.

**phenol, carbolic acid,  $C_6H_5OH$**  The word 'phenol' applies also to a group of aromatic compounds with one or more hydroxyl (OH) groups attached to the benzene ring (cresols, naphthols). Ten micrograms of phenol per litre in drinking water can make it unpalatable, especially after *chlorination*, which forms *chlorophenols*. Phenols may be found in water that has run off tar sprayed roads or from a tar distillery or from *coke plant wastewater*. They may be biologically oxidised in wastewater treatment at concentrations up to 500 mg/l if the biological treatment has been acclimatised to them.

**phenol adsorption test** A test for *activated carbon*, in which a *phenol* solution at about 5000 p.p.m. is circulated through an *adsorption* bed. The percentage phenol adsorbed is measured. If the drop in adsorption from the value with fresh carbon exceeds about 40%, the carbon should be changed. This test has the advantage of using the carbon in its working state. See also *iodine number*.

**phenolphthalein alkalinity** *Caustic alkalinity*.

**pheromone** A chemical secreted by an animal, which transmits a communication to another one—e.g. a chemical attractant.

**Phoredox process** Two methods for obtaining *biological phosphorus removal*. The three stage Phoredox process is synonymous with the *AAO process*. The five stage Phoredox process is synonymous with the five stage *Bardenpho process*.

**Phormidium** A *blue green alga* which may form olive green sheets growing on the surface of *trickling filters*. They may release *endotoxins* into the water.

**Phosnix process** A process for removing phosphate from the liquors that emanate from wastewater sludge processing. Magnesium hydroxide is mixed with the liquor and *struvite* is formed and precipitated in a settling zone.

**phosphate** See *orthophosphate, phosphorus, polyphosphate*.

**phosphate remediation of contaminated land** The addition of phosphates to soil so that metal contaminants, such as cadmium, lead or zinc form an insoluble phosphate in the soil. This immobilises the metal pollutant. See *stabilisation*.

**phosphorus, P** Phosphorus is a major nutrient for bacteria and animals, and occurs naturally in water, usually as *orthophosphates*. Human activity adds these and other forms of phosphorus to wastewaters. Fertilisers containing phosphates are washed off farmland into rivers and lakes. Domestic wastewater usually contains 5 to 15 mg/l of phosphorus, of which up to 70% comes from the *polyphosphates* that are *builders* in *synthetic detergents*. The major effect of phosphorus in natural waters is *eutrophication*. Consequently, there is an increasing emphasis on the limitation of phosphorus concentrations in wastewater effluent or industrial discharges. See below, *plumbosolvency*.

**phosphorus removal** *Phosphorus* normally occurs in wastewater *phosphates*. In domestic wastewater about 20% is removed by conventional *sedimentation* and a further 20% assimilated by bacteria in *secondary treatment*. More complete removal can be obtained by forming relatively insoluble precipitates through the addition of calcium, aluminium or ferric compounds such as lime, alum or ferric chloride. If they are added before *primary sedimentation*, the lack of phosphorus may limit the efficiency of biological treatments. If the chemicals are added during biological treatment, the precipitate settles out in the *secondary sedimentation tank*. In *activated sludge* plants this may concentrate insoluble phosphate in the system because of the continuous return of sludge. Adding the chemicals to the effluent from the secondary tanks will not interfere with the processes but it may involve a further stage of sedimentation. More than 95% of the phosphorus can be removed by these methods. The activated sludge process can be adapted to give *biological phosphorus removal*. The *PhoStrip process* is another adaptation. Other P removal techniques include *algal harvesting* or the use of *activated alumina*.

**PhoStrip process** A technique for removing phosphates from wastewater in which a portion of the return activated sludge flows to an anaerobic tank so that some phosphate is released back into solution from the activated sludge (see Figure P.4). The sludge returns to the aeration tank and the phosphate rich supernatant flows to another tank where lime is added so that the calcium phosphate precipitate is produced and removed. This is known as side stream phosphorus removal.

**photic zone** The upper water layer that can receive sunlight.

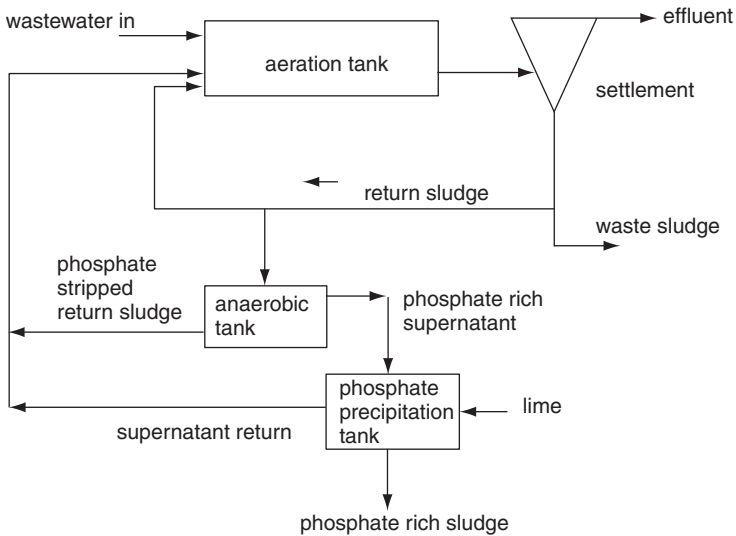

**Figure P.4** PhoStrip process, flow diagram.

**photoautotrophs** Micro-organisms that use sunlight and inorganic carbon (e.g. CO<sub>2</sub>) to produce the organic food.

**photochemical** The oxidation of a chemical due to the action of sunlight.

**photochemical oxidant** Any strong oxidising agent in *photochemical smog*, mainly *ozone*, *nitrogen dioxide* or *PAN*.

**photochemical smog** A smog that can occur in polluted air due to the action of sunlight producing photochemical reactions between hydrocarbons, *VOCs*, *nitrogen oxides* (NO<sub>x</sub>) and *ozone*. The reactions generate more ozone and NO<sub>2</sub> together with organic compounds such as formaldehyde and *PAN*.

This cocktail of chemicals gives rise to a strong haze or smog in the atmosphere. It can cause eye irritation, coughing and chest soreness. Vehicle emissions are the main cause of the air pollutants that then lead onto photochemical smog. Severe photochemical smogs can occur in *inversions*.

**photodegradable** A description of something that decomposes under the action of light. *Compare biodegradable*.

**photoheterotrophs** Micro-organisms that use sunlight and organic carbon to produce the organic food.

**photolysis** Chemical decomposition caused by the adsorption of light energy.

**photometer** A light meter e.g. for measuring colour or smoke density.

**photosynthesis** Synthesis of *carbohydrates* in sunlight in algae or the leaves of green plants containing chlorophyll. It involves the absorption of carbon dioxide and the release of oxygen. *Compare chemosynthesis*.

**photosynthetic** Description of an organism or process that uses *photosynthesis*.

**phototaxis** *See taxis*.

**phototoxicity** Substances that are harmful to plant growth.

**phototroph** An organism that uses *photosynthesis* to produce organic matter and oxygen. *Compare chemotroph*.

*Phragmites australis*, *P. communis* The Common Reed that is often used in *reed bed treatment*.

**phreatic surface** *Water table*.

**phreatic zone** The *saturated zone*.

**phreatophyte** A plant with deep roots that reach to the *water table*, as long as 10 m.

**phthalates** A group of organic chemicals that are used as plasticisers in the manufacture of plastics. Butyl benzyl phthalate (BBP) is used in vinyl floor tiles and adhesives. Dibutyl phthalate (DBP) is used in food packaging and PVC. *Di (2-ethylhexyl) phthalate* (dioctylphthalate) is used to keep plastics soft or more flexible. They may be released to water or air by leaking from plastics in landfills or from the burning of plastic. They may be found in water. Some phthalates may be carcinogenic and some show *oestrogenicity* as they are weak *endocrine disrupters*.

**phylum, sub-kingdom** The division in *taxonomy* that comes below *kingdom*.

**Phyophyta, phyophytes** The *brown algae* e.g. brown seaweed.

**physical chemical treatment, physicochemical treatment, PCT** Many water treatments involve physical and chemical processes. In the PCT of wastewater, chemicals may be used in *chemically enhanced primary sedimentation*. Other PCT processes for wastewaters include the use of

- activated carbon* or *ammonia stripping* or *ion exchange* or chemical *phosphorus removal* or *wastewater disinfection*.
- physical chemical treatment of hazardous waste** Treatments, such as *carbon adsorption*, *distillation*, *steam stripping*, *ion exchange*, can be used to concentrate the hazardous waste prior to a further treatment or recovery. See *chemical treatment of hazardous waste*.
- physical pollution** Pollution of water because of colour, *suspended solids*, temperature (*thermal pollution*), *radioactivity* or *foaming*.
- physical treatment of contaminated land** The use of physical treatments to clean up contaminated land. These include *electroremediation*, *phytoremediation*, *soil flushing*, *soil vapour extraction*, *soil washing*, *solvent extraction*, *steam stripping* (2), *thermal treatment*, *treatment walls*.
- phytobenthos** Aquatic photosynthetic organisms which live on, in, or near the bottom of rivers, lakes, etc. They may be algae or plants. See *Water Framework Directive, 2000*.
- phytoflagellates, phytoflagellate protozoa** Photosynthetic *flagellate protozoa* (Mastigophora) which have some characteristics in common with *algae*, for example, *Euglenophyta*.
- phytoplankton** *Plankton* which are *photosynthetic*, mainly *algae*. Compare *zooplankton*. See *Water Framework Directive, 2000*.
- phytoremediation** Growing plants for the purpose of taking up contaminants from a soil in order to remediate the soil. The plants are contaminated and must be disposed of in an appropriate manner.
- phytotoxic** Description of a substance that is toxic to plants or algae.
- picket fence thickener** Vertical bars hanging from a slowly rotating central vertical shaft, used for *sludge thickening*. The rim speed is 150 mm/s  $\pm$  50%.
- PICs** *Products of incomplete combustion*.
- piezometer tube** An open topped tube in which water rises because of the pressure in the *confined groundwater* or soil where its lower end is submerged. The water level in it indicates the pressure.
- piezometric surface** The surface of the *standing water level*, shown by the level in *piezometer tubes* whose lower ends pass below the surface of *confined groundwater* and indicate the level to which the water from an *artesian well* would rise. See *Figure A.11* (the *hydraulic gradient* refers to moving water.) Compare *water table*.
- pig, go-devil** A scraper or brush or foam-plastics swab that is pushed along a pipe by the fluid pressure behind it, used for cleaning a water *main*, *sewer*, or pipeline.
- piggery wastewater** The weight of BOD per day from one pig is about twice as much as from one human. Copper salts, sometimes present in significant quantities because of their use as feed additives, may restrict the disposal of the manure on land.
- pigging** The use of a *pig* to clean a pipe.
- pilot bore** The first pass of a boring process which requires enlarging by further boring or *backreaming*.
- pilot plant** A small scale treatment plant which simulates the full size plant before this is built, so as to optimise its design of engineering conditions.

**pinfloc** Small flocs that do not settle. Formation of substantial quantities of pinfloc in an *activated sludge* plant can give an effluent with high suspended solids.

**pin holes** Localised corrosion of a pipe that leads to the development of small holes.

**pinworm, *Enterobius vermicularis*** A nematode that causes enterobiasis or pinworm disease. The eggs pass in the faeces from infected humans and are transmitted by food or contaminated water etc. Anal itching is a common symptom.

**pipe bursting, p. cracking, p. displacement, p. drilling cracking, p. splitting** The introduction of a conical device into the pipe which has a slightly larger diameter than the pipe. As the cone is pulled or pushed through the pipe, the pipe bursts. The fragments of the pipe are compressed into the surrounding soil, allowing a new pipe to be pulled or pushed into place directly behind the pipe bursting device. The new pipe can be as large or larger than the existing pipe.

**pipe cleaning** See *water pipe cleaning*.

**pipe cracking, p. displacement, p. drilling cracking** *Pipe bursting*.

**pipe eating** The use of *microtunnelling* where the existing pipe is excavated together with the surrounding soil prior to installation of the new pipe.

**pipe failures** See *water pipeline failures*.

**pipe flow** Flow through a pipe that runs full. Several types of pipe flow exist. In a *siphon* the *hydraulic gradient* is below the pipe. In pressure flow the hydraulic gradient is above the pipe (see *Figure P.5*). See *Hazen-Williams formula, open channel flow*.

**pipe interrupter** A *non return valve*.

**pipe jacking** *Pipe ramming*.

**pipeline inspection techniques** See *closed circuit television*.

**pipeline rehabilitation** See *sewer rehabilitation, water pipe rehabilitation*.

**pipe pulling** The replacement of small diameter pipes where the new pipe is attached to the existing pipe which is then pulled out of the ground.

**pipe ramming, pipe jacking** A *trenchless technology* technique for the refurbishment or replacement of water mains or sewers. The technique pushes

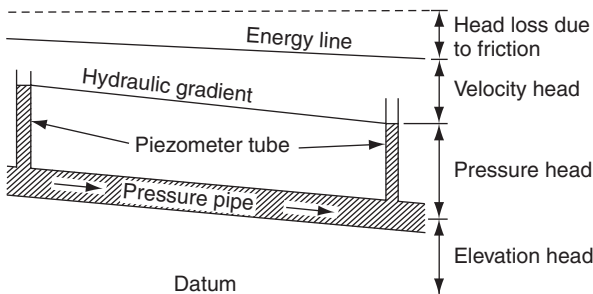

**Figure P.5** Pipe flow. This example indicates an increase in velocity as the flow moves down the pipe, so the velocity head increases.

the pipe directly through the soil using a hydraulic ram. The waste soil is removed within the pipe by augering, jetting, or compressed air. The system can only be used for straight line applications in granular soils. Intermediate jacking stations may be used with hydraulic jacks placed in the new pipe to assist long drives. A jacking or drive pit or shaft is required to get the machinery into the ground to start the jacking. The pipe diameter is usually less than 900 mm.

**pipe rehabilitation** *See sewer rehabilitation, water pipe rehabilitation.*

**pipe splitting** *Pipe bursting.*

**piscicide** A *pesticide* that kills fish.

**Pista grit trap** A type of *vortex grit separator*.

**piston flow** *Plug flow.*

**piston pump, ram p. reciprocating p.** A pump where the reciprocating movement of a piston sucks water or sludge into the pump and then pushes it out of the pump. High pressure can be produced.

**pit latrine, p. privy** A common low cost excreta disposal system in which a pit, typically 1 m × 1 m × 3 m deep, is dug into permeable soil. A superstructure is built over the pit which contains the squatting area. The hole in the squatting area should be covered when not in use to reduce fly nuisance from the pit. Fly control and general ventilation of the latrine is improved

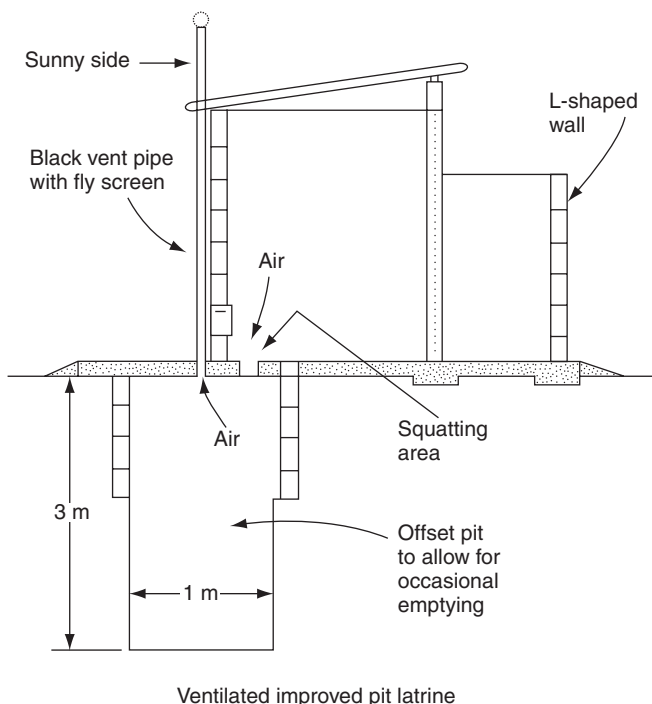

**Figure P.6** Ventilating improved pit (VIP) latrine.

by adding a vent pipe (ventilated improved pit latrine, VIP latrine, *see Figure P.6*). The vent pipe should face the midday sun and is often painted black. The pipe heats up during the day giving air movement from outside down through the squatting area and up and out of the vent pipe. This minimises unpleasant odours in the squatting area. Flies that breed in the pit tend to move to the bright light at the top of the vent pipe where a fly screen stops them escaping and so they die and fall back into the pit. A VIP latrine can reduce fly nuisance by 100 or 1000 fold compared to a basic pit latrine. *See double vaulted pit latrine.*

**Pitot tube** A tube that measures the static pressure as well as the kinetic energy of a flowing fluid. Ordinarily two tubes are used, connected at their far ends to a U tube. One opening faces upstream and measures the total head. The other faces at right angles to the flow and measures the static head only. The U tube thus shows the difference in pressure which is due to the velocity—the velocity head, from which the velocity can be calculated. Many variations exist.

**pit privy** *Pit latrine.*

**pitting corrosion** Localised corrosion in a metal pipe leading to perforations on the surface of the pipe. It can occur in copper, iron or lead pipes.

**plague** *See Yersinia.*

**planarians, Turbellaria** Free living flatworms. Some species may be found in water that is mildly polluted with wastewater—e.g. *Dendrocoelum lacteum*. *Flukes* and *tapeworms* are the main ones.

**planings** Asphalt taken off a tarmac road. It can be reused.

**plankton** Micro-organisms that float or swim freely in oceans or fresh water.

They neither attach themselves to the bed nor live near it, unlike the *benthon*, and include algae, tiny animals, rotifers, protozoa and crustaceans, which form part of holoplankton or meroplankton. Many types of water life exist, including *nekton*, *neuston*, *phytoplankton*, *seston* and *zooplankton*.

**plaque** An area of a bacterial *culture* that has been destroyed by *virus* infection. The number of viruses present is assumed to be related to the number of plaques that have formed.

**plasma arc incineration** An electric arc in a suitable gas flow can produce a plasma with temperatures in excess of 10 000 °C. This can be used for high temperature incineration to give complete destruction of a range of highly toxic chemicals.

**Plasmodium** A *parasitic, spore forming protozoon* that causes *malaria*, transmitted by *mosquito* bites.

**plastic media, plastic filter media** The packing in a *packed bed reactor* can be plastic, such as PVC or polystyrene. The media have large voids to achieve a high surface area per unit volume. The media may be rigid (e.g. in a *high rate trickling filter*) or small beads (e.g. some types of *biological aerated filter*). They are used in air pollution control, such as the *packed bed scrubber*.

**plastic pipes** A range of plastic materials are used in the water and wastewater industry. They are commonly *high density polyethylene* or *PVC-U*.

**plastics** Man made long chain organic polymers that have a wide range of uses. *See thermoplastics, thermosetts.*

**plastics industry wastewater** The liquid wastes are mainly from boilers or coolers that do not come into contact with the process. Process water, however, may be contaminated with toxic chemicals. Waste gases from the plastics and rubber industries can be obnoxious unless air pollution control equipment is installed.

**plastics recycling** The two main types of plastics in solid waste are *thermoplastics* and *thermosetts*. The former are the most common in waste and they can be re-heated and remoulded. Thermosetts cannot be remoulded. Plastics can be sorted out from the mixed municipal waste paper at a *materials recovery facility* or they be collected separately from the householder by a *separation at source scheme* or collected at a *drop off centre*. The thermoplastics can be processed to make new bottles, packaging material, etc. However, much of the recovery of plastics is by energy recovery after *incineration* (see *waste to energy plants*).

**plate and frame press** See *filter plate press*.

**plate and tube settler, p. and t. separator** See *inclined plate and tube settler*.

**plate count colony count** The number of colonies of bacteria or other microbes that have developed on a plate of nutrient *agar* inoculated in the laboratory with the diluted sample, and counted after a certain number of hours *incubation* (e.g. 48 to 72 h) at a certain temperature. Incubated at 20 °C the colony count will tend to indicate bacteria that grow in natural waters, and at 37 °C those from mammals. As organic pollution in a river increases, the ratio between the counts at 20° and 37° normally decreases below ten to one.

**plate count technique, pour plate technique** After making dilutions of the water or wastewater to be examined, at 0.1, 0.01, 0.001 and any others needed, samples of 1 ml of each dilution are pipetted into sterile Petri dishes about 90 mm diameter. The 1 ml samples are then covered with 15 ml of molten *agar* at 45 °C, well mixed with it by circular and sideways motions and allowed to set. The agar contains various salts or other chemicals so that certain types of bacteria develop. Yeast extract agar should be used for coliform bacteria. When the agar has set, the Petri dishes are inverted and placed in the incubator at the appropriate temperature. The colonies that develop in each dish after this incubation period are counted, and those with more than 300 or fewer than 30 are ignored. More than 300 cannot easily be counted; fewer than 30 are subject to large statistical error. Assuming a dilution of one-hundredth, they would be reported, respectively, as 'over 30 000 per ml' and 'under 3000 per ml'.

**plate diffuser** A *diffuser* (1).

**plate filter press** See *filter plate press*.

**plate precipitator** *electrostatic precipitator*.

**plate press** See *filter plate press*.

**plate tower reactor** A reactor that consists of a tower with horizontal perforated plates across it. It can be used to remove pollutants from air into a liquid (see below) or to aerate water (see *cascade aerator, Figure C.1*) or degasify water or remove pollutants in the wastewater into steam (see *steam stripping* (1)).



**plate tower scrubber, impingement scrubber** A *wet scrubber* consisting of a tower with horizontal perforated plates across it perpendicular to the upward gas flow. Liquid flows down the tower and wets the plates which the gas strikes, removing the particulates into the liquid. The gas velocity may be about 2.5 m/s. Particles of 10  $\mu\text{m}$  are readily removed. Gaseous pollutants can also be removed. *See flue gas desulphurisation.*

**plating wastewater** *See metal plating wastewater.*

**platinum cobalt scale, Pt/Co scale, Hazen unit** A standard method for measuring the brown colour in water. One unit of the Pt/Co scale (one Hazen unit) is the brown colour from mixing a solution of 1 mg/l of Pt as chloroplatanic acid with 2 mg/l of cobaltous chloride.

**Platyhelminthes** *Flatworms.*

**Plecoptera** *Stone flies.*

**plug flow, piston f., slug f.** Flow of fluid in an unmixed mass. Thus, if a slug of *tracer* is injected at the inlet to a tank, it will issue from the tank also as a slug after the retention time. *Compare arbitrary flow, completely mixed reactor.*

**plug flow reactor, PFR** A tank in which the liquid flow is by *plug flow*. *Compare completely mixed reactor.*

**plug valve** A valve with a bored plug that can be rotated to stop the flow through a pipe.

**plumbism** Lead poisoning. One of the causes of the decline of the Roman Empire may have been poisoning from the lead in the water carried by the new leaden conduits or from that in the wine drunk out of leaden vessels.

**plumbosolvency** The ability of water to dissolve lead. This can occur in drinking water if the water is slightly acid and the plumbing contains lead. Plumbosolvency can be reduced by raising the pH of the water to over 9.0, e.g. by the addition of lime at the water works. *Orthophosphates* are also added to plumbosolvent waters in order to form an adherent coat of lead phosphate on the inside of the lead pipe. *See Table D.2 Drinking water standards.*

**plume, vapour p.** The visible, occasionally invisible, smoke from a chimney.

**plume dispersion** The plume from a chimney and hence the dispersal of the air pollutants is dependent on the atmospheric conditions, particularly the *lapse rate* (*see Figure P.7*). As air flow goes over a building, a high pressure zone is created on the windward side and a low pressure zone on the leeward side. This can produce turbulence and eddy currents and can bring a chimney plume down towards ground level (*see Figure P.8*).

**plume rise** *See efflux velocity.*

**PM<sub>2.5</sub>** Particulate matter of less than or equal to 2.5  $\mu\text{m}$ . In the USA, *NAAQS* has set a standard of 65  $\mu\text{g}/\text{m}^3$  for any 24 hour average.

**PM<sub>10</sub>** Particulate matter of less than or equal to 10  $\mu\text{m}$ . In the USA, *NAAQS* has set a standard of 50  $\mu\text{g}/\text{m}^3$  averaged over a year, and 150  $\mu\text{g}/\text{m}^3$  averaged over a 24 hour period. The EU standard is 50  $\mu\text{g}/\text{m}^3$  averaged over a day, which must not be exceeded more than 35 times a year. The annual mean limit value is set as 40  $\mu\text{g}/\text{m}^3$  but it is proposed to reduce this to 20  $\mu\text{g}/\text{m}^3$ .

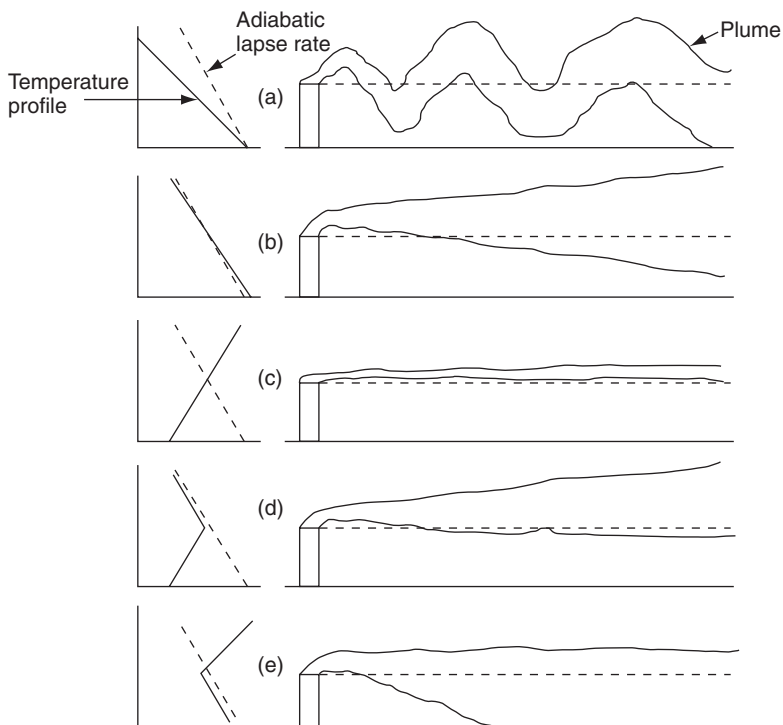

**Figure P.7** Plume dispersion from chimney stacks with different temperature profiles of the atmosphere in relation to the adiabatic lapse rate. (a) Looping (b) coning (c) fanning (d) lofting (e) fumigation.

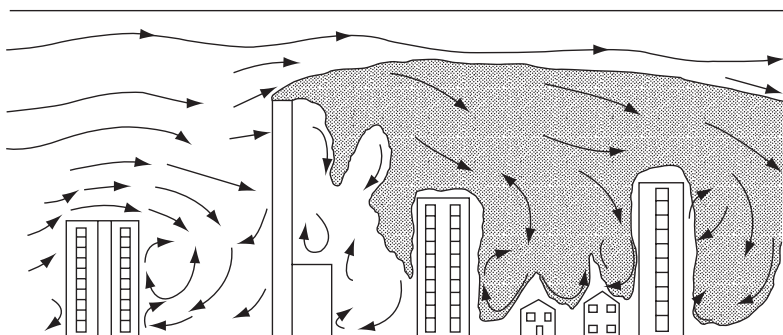

**Figure P.8** Downward dispersion of a plume caused by the disturbance of air flow and turbulence in areas around buildings.

**PNEC** *Predicted no effect concentration.*

**pneumatic ejector** An *ejector pump*.

**pneumatic transport of solid waste** A pipe system through which solid waste travels, drawn along by air pressure, in capsules or bags or loose. In vacuum transport the air is pumped out at the destination. In pressurised pneumatic transport the air is blown in at the point of origin of the waste.

**POCs** Products of complete combustion, e.g. carbon dioxide, water vapour. *See products of incomplete combustion.*

**POHC** *Principal organic hazardous constituents.*

**poikilotherm** Description of fishes and most water animals whose body temperature follows that of the environment, being slightly warmer than the water. *See homoiotherm.*

**point source of pollution, p. s. discharge** Sources of pollution that can be located to an individual point, e.g. an effluent outfall or incinerator stack.

**poisoning** In connection with *catalysts, ion exchange resins* or *membranes*, poisoning is the destruction of their properties—e.g. arsenic is a chemical poison for a platinum catalyst. Organic material, even at 5 mg/l, may be a poison for membranes in *electrodialysis*.

**polarography** An electrochemical technique that can be used to measure small concentrations of *lead, cadmium, chromium* and other *heavy metals*. The voltage across two electrodes is increased until the solution polarises and passes current. This minimum voltage is specific for each metal and the value of the current can be related to the concentration of the metal in the water.

**poliomyelitis, infantile paralysis** A disease caused by a virus that attacks the nerves controlling human muscle. The virus is present in the excreta from an infected person and is transmitted through food or water.

**polishing** A final purification of water or wastewater. For wastewater effluent it is called *tertiary treatment*.

**polishing filter** A filter used for *polishing* water or wastewater.

**polishing pond** A *maturation pond*.

**pollutant load** The concentration of the pollutant multiplied by the flow of the water or wastewater or air to give a value of mass of pollutant per unit time (e.g. kg/d).

**polluter pays** The principle in pollution control that the cost of cleaning up pollution is met by the polluter.

**pollution control technologies** Equipment designed to reduce pollution and the resulting adverse environmental and health effects from waste combustion or disposal, or private or industrial emissions.

**Pollution Prevention and Control Regulations 2000** The Regulations in the UK that implement the EU Directive on *Integrated Pollution Prevention and Control*.

**pollutograph** The plot of the change in pollutant concentration against time.

**polonium** Radon decays to produce polonium which can attach to dust and be inhaled. Polonium decays and emits  $\alpha$  particles.

**polyacrylamides, PAMs** Organic polymers that are widely used as coagulant aid to assist the *flocculation* of water or as *conditioner* of sludge prior to

thickening and dewatering. The monomer, *acrylamide*, is toxic to humans. The monomer may be present at trace levels in the polymer.

**polyamide** A polymer that can be used as a membrane in *reverse osmosis*. It can be used up to pressures of greater than 80 bar. It is intolerant to chlorine and any chlorine must be removed i.e. *dechlorination*. See *membrane fouling*.

**polyamines** An organic polymer that may be used in the flocculation of water, particularly for colour removal.

**polyaromatic hydrocarbons** *Polycyclic aromatic hydrocarbons*.

**polybrominated diphenyl ethers, PBDEs** A group of chemicals used as flame retardants in a range of household and other goods. They are toxic, some may be carcinogenic and some may be teratogenic. In relation to aquatic discharges, the EU lists penta BDE (i.e. 5 bromine atoms in the molecule) as a *priority substance* (under review for possible re-grading as a priority hazardous substance).

**polybrominated biphenyls, PBBs** Chemicals used as flame retardants They are persistent in the environment and causing increasing environmental concerns.

**polybutylene A thermoplastic** polymer of butylene, such as butyl rubber.

**polychaete, Polychaeta** A class of *annelid*—small worms that abound in seas and estuaries. They can amount to 70% of the macro invertebrates in tidal mud and are often chosen for *bioassays* of coastal regions—e.g. *Capitella capitata* and *Neanthes*.

**polychlorinated biphenyls, PCBs** A group of organochlorine compounds with an example of the structure given in *Figure P.9*. A common trade name is Aroclor. The term PCBs is used to cover other chemicals such as PCTs (*polychlorinated terphenyls*). They have been used as fire retardants, in insulating materials, paints and high temperature lubricants. They precipitate in sludge and are adsorbed by clays. They are soluble in oil and *lipids* but not in water. They are carcinogenic. They persist in the environment and undergo *biomagnification* in the food chain. They can be found throughout the environment including Arctic seals. They were banned in 1979. During incineration, PCBs can be transformed into *dioxins* or *dibenzofurans*, if the incineration temperature is inadequate. The *USEPA* states a *MCL* in drinking water of 0.5 µg/l.

**polychlorinated dibenzodioxin, PCDD** See *dioxin*.

**polychlorinated dibenzofuran, PCDF** See *dibenzofuran*.

**polychlorinated terphenyls, PCTs** A chemical similar to *PCB*, but it has 3 linked phenyl groups. An example of the structure given in *Figure P.9*. PCTs may be encompassed by the term PCBs.

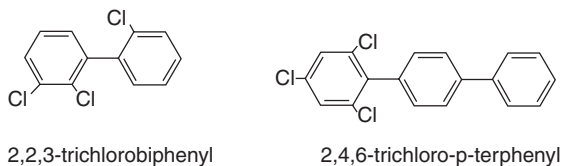

**Figure P.9** Examples of a polychlorinated biphenyl (PCB) and a polychlorinated terphenyl (PCT).

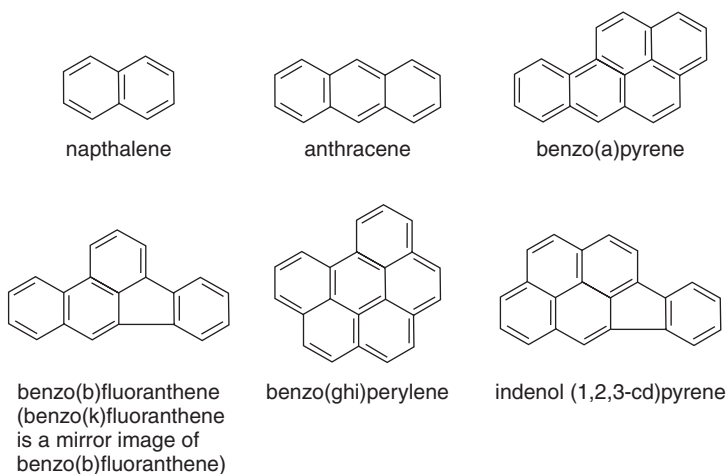

**Figure P.10** Examples of polycyclic aromatic hydrocarbons (PAHs).

**polycyclic aromatic hydrocarbons, polynuclear a. h., polyaromatic hydrocarbons, PAHs** Hydrocarbons that have two or more benzene rings joined together. Typical examples are given in *Figure P.10*. Many are carcinogenic and can occur in tar, vehicle exhausts, soot, incinerator gases if combustion is incomplete, contaminated land, waste sludges, etc. They have a low solubility in water but attach to organic material and may be associated with the suspended matter in the water. The EU mandatory maximum for the 4 reference PAHs [benzo(b)fluoranthene, benzo(k)fluoranthene, benzo(ghi)perylene and indeno(1,2,3-cd)pyrene] in drinking water is  $0.1 \mu\text{g}/\text{l}$ . **Fluoranthene** is not considered significant to health and is no longer within the EU restriction for PAHs in drinking water. Filtering the water through **activated carbon** can remove a high percentage of PAHs from water. The **USEPA** states a **MCL** in drinking water of  $2 \mu\text{g}/\text{l}$  for benzo(a)pyrene. **Slurry phase treatment** has been used to remove PAHs from contaminated land. PAHs can be found in polluted air. The USEPA uses the term 7-PAH, which is the concentration of benzo(a)-anthracene, benzo(b)fluoranthene, benzo(k)fluoranthene, benzo(a)pyrene, chrysene, dibenzo(a,h)anthracene and indeno(1,2,3-cd)pyrene. Various alternative spellings are used: 'fluoranthene' can be spelt 'fluoroanthene'; 'benzo' can be spelt 'benz'; 'indeno' can be spelt 'indeno'. See also **priority substances** and **Table P.1**.

**polyelectrolyte** A **polymer** that carries ionisable groups. When dissolved in water, they acquire many positive or negative charges (cationic or anionic polyelectrolytes). As a **coagulant aid**, a polyelectrolyte is added to water in small quantities to help in the **flocculation** of fine suspended solids or colour molecules by reducing their surface charges and also by enmeshing fine solids or colour molecules in the long chain molecules of the polyelectrolyte. They are used in the **conditioning** of sludges from water or wastewater

- treatment. Most of them are *polyacrylamides* or compounds of polyacrylic acid. A few are polyamides or quaternary ammonium compounds. Non-ionic polyelectrolytes are a misnomer. They are either *ampholytic* or do not ionise at all, and should not be called polyelectrolytes.
- polyethylene** A plastic which is a polymer of ethene (ethylene). See below and *high density polyethylene, low density polyethylene, medium density polyethylene*.
- polyethylene terephthalate, PET** A *thermoplastic* material that is commonly used for plastic drink bottles and food packaging.
- polyfloc** A polyelectrolyte *floculant*.
- polyglycol** A substance used in industry as a lubricant for cutting metals, etc. It can cause foaming of a river or of *activated sludge* or of a *digester*.
- polymer** A substance composed of long chain molecules, sometimes with more than 1000 atoms, and built up from simple molecules (monomers) linked together. Many are synthetic, but some, such as *cellulose*, are of natural origin. Different polymers may be formed from different unions of one monomer, so that they have the same formula but different linkages.
- polynuclear aromatic hydrocarbons** See *polycyclic aromatic hydrocarbons*.
- polypeptides** *Polymers* of amino acids, of simpler structure than *proteins*.
- polyphosphate** A chemical based on the *orthophosphate* molecule ( $\text{PO}_4^{3+}$ ) with other phosphorus atoms attached. They hydrolyse slowly to orthophosphate. They are corrosion inhibitors, but are not necessarily effective in water pipe corrosion. They are occasionally added to drinking water because they can complex with manganese and iron in water and thereby stop troublesome precipitates. See *sodium hexametaphosphate, sodium tripolyphosphate*.
- polypropylene, PP** A *thermoplastic* material that is commonly used for food packaging.
- polysaccharides** *Polymers* of monosaccharides or simple sugars (glucose, xylose, etc.) or sugar based structures. Starch and *cellulose* are polymers of glucose but with different links between the glucose molecules. *Agar agar* also is a polysaccharide, and much bacterial *slime, humus* or *activated sludge* is based on polysaccharides.
- polysaprobic river** In the *saprobic classification*, a river with heavy organic pollution. It is *anaerobic*, with only simple forms of life. Red worms, *Tubificidae* and the rat tailed maggot *Eristalis tenax* are common in such rivers.
- polysulphone** A polymer that can be used as a membrane in *reverse osmosis*. It can operate over a wider range of pH values and at higher pressures than *cellulose acetate* membranes, but it is less resistant to chlorine.
- polystyrene, PS** A *thermoplastic* material that is commonly used for food packaging. *Styrene*, which is the monomer of polystyrene, is toxic to humans.
- polyvinyl chloride, PVC,  $(\text{CH}_2\text{CHCl})_n$**  A common *thermoplastic* material that is commonly used for bottles, toys, cable insulation, etc. When it burns it gives off hydrochloric acid (HCl). See *PVC-U, vinyl chloride*.
- POM** Polycyclic organic matter, e.g. *polycyclic aromatic hydrocarbons*.
- ponding** The blocking of a *trickling filter* with the formation of pools on its surface, common in winter when it is too cold for the *grazing fauna* to feed

on the surface *biofilm* and thus to break it up. The blocking is caused by excessive growths of bacteria fungi or algae. With the return of warm weather the grazing organisms revert to the surface of the film and break it up, with the result that large quantities of *humus* are sloughed off the filter.

*Alternating double filtration* helps, as does *chlorination* of the influent, and possibly inoculation of the filter with an insect such as the water *springtail* which feeds on fungi that may be clogging the filter. Recirculation of the effluent or resting the filter for several days or slowing the speed of the dosing arm may help by reducing the microbial population adhering to the media. *See sloughing off.*

**ponds** *See detention basin, retention pond, settling pond, stilling basin, waste stabilisation ponds.*

**pondweed** *Potamogeton.*

**POPs** Persistent organic pollutants. Organics pollutants that do not readily degrade in the environment. A number of *organochlorine compounds* are POPs.

**population dynamics** The study of the variations in numbers of various species in an *ecosystem*. It shows up the interrelationships between species, and their changes.

**population equivalent, PE** The organic strength of a wastewater may be expressed in terms of the equivalent population based on the mass of BOD<sub>5</sub> that one person excretes per day.

$$PE = \frac{\text{wastewater flow (m}^3/\text{d)} \times \text{BOD}_5 \text{ of the wastewater (mg/l)}}{\text{grams of BOD}_5 \text{ that one person excretes per day}}$$

(1 mg/l = 1 g/m<sup>3</sup>)

For EU countries, the mass of BOD<sub>5</sub> that one person excretes per day is taken as 65 g/d. In the USA this value is taken as 80 g/d, but rises to 100 g/d in areas which have properties that extensively use *garbage grinders*.

**pore space** In soils or *deep bed filters* etc., the cavities that are filled with fluid—i.e. gas, water, air, occasionally oil, or any mixture of them.

**Porifera** The sponges.

**porosity** The ratio of the volume of the voids in a soil or *medium* to the total volume. *Compare void ratio.*

**porous air diffuser** A *diffuser* (1).

**porous bed** A *sludge drying bed*.

**porous pavement** A pavement made of porous asphalt or porous concrete placed on a highly permeable base so that some stormwater can pass through the pavement and infiltrate into the subsoil. This reduces the stormwater runoff.

**positive displacement pump** A pump where the fluid is taken into the pump and then pushed out of the pump as opposed to rotor dynamic pumps. Examples of positive displacement pumps include the *diaphragm pump, ejector pump, peristaltic pump, piston pump, progressive cavity pump, rotary lobe pump* and *screw pump*.

**post aeration** The aeration of effluents prior to discharge to the water course so that the effluent is high in dissolved oxygen. This can be

beneficial for the maintenance of dissolved oxygen in the receiving water near the point of effluent discharge. Post aeration can be achieved by flowing the effluent down a cascade or by mechanical aeration or diffused air aeration.

**post chlorination** *Chlorination* after other water treatment processes.

**post flame treatment** A method for control of *nitrogen oxides* ( $\text{NO}_x$ ) by passing gases through a platinum-rhodium catalyst. This reduces NO to  $\text{N}_2$ .

**potable water** Drinking water.

**potable water sludge** See *water works sludge*.

**Potamogeton, pond weed** A water plant that can be used in a *biotic index*. It is unable to grow in water with 2.5 mg/l of detergent. It is less sensitive to mild organic pollution.

**potamic** Relating to rivers.

**potamology** The study of streams and rivers. Compare *limnology*.

**potamon zone** A section of a river or stream reach with a slow velocity of flow. It has a flood plain and is an area of deposition. The river sediments are typically sand and silt. The river may have reduced dissolved oxygen levels. Compare *rhithron zone*.

**potassium, K** Domestic wastewater effluents contain about 10 to 20 mg/l of K and it can be an indication of their presence. Potassium-39 is not radioactive but contains about one part in 10 000 of the radioactive isotope  $^{40}\text{K}$  (potassium-40).

**potassium permanganate,  $\text{KMnO}_4$**  An oxidising agent used for precipitating iron or manganese or for measuring oxygen demand by the *permanganate value* test or for oxidising industrial wastewaters containing cyanide compounds. It has also been used as a disinfectant for drinking water. For removing the taste of algae, from 0.25 to 0.5 mg/l has been added with success. As a 1 to 2% (by weight) solution in water at pH 7 to 9, it is helpful in *wet scrubbers* for reducing smells in air, removing hydrogen sulphide, sulphur dioxide and carbon disulphide. It also removes the smells of some organic compounds (*aldehydes*). See *Kubel test*.

**pot chlorinator** A porous pot that contains *calcium hypochlorite*. The pot is placed in a well or water storage tank and the calcium hypochlorite slowly dissolves to release hypochlorous acid and thereby disinfect the water. The chemical must be renewed before all the calcium hypochlorite has reacted in the water.

**potentially toxic elements, PTE** The addition of PTEs (e.g. arsenic, cadmium, chromium, copper, fluorine, lead, mercury, molybdenum, nickel, selenium, zinc) to land must be restricted. For *land application of sludge* in the EU, limits are set by a Directive passed in 1986. It includes limits for the PTE content of sludge being applied to land as well as maximum application rates in kg of PTE per hectare per year averaged over 10 years. The limit for some elements such as cadmium or mercury is very strict and the concentration of these in wastewater sludge or compost can be the limiting factor in calculating the quantities of that material that can be applied to the land.

**poultry house wastewater** The liquid waste from washing down a poultry house is high in nitrogen, phosphate and potassium, compared with other



livestock wastes. About eight hens produce the same BOD per day as one human. Chicken manure may be spread on land or treated in an *anaerobic lagoon*.

**pour flush latrine, p. f. toilet** A low cost toilet system which uses low volumes of water to help flush the excreta away from the squatting plate or toilet. The important aspect of this system is the *water seal* that stops odours going up into the squatting or toilet area from downstream of the latrine. As little as 1 litre per flush of the privy is used. The flushing is manual, in that the user of the privy pours the water down the toilet. The excreta may flow to a *pit latrine* or *septic tank* or into a sewer.

**pour plate technique** The *plate count technique*.

**powdered activated carbon, PAC** *Activated carbon* with a particle size less than 50 µm. It can be added to water just prior to filtration to remove trace organics or chemicals that give taste and odour problems. The unwanted chemicals adsorb onto the PAC which is then removed in the filter.

**powdered activated carbon treatment process** *PACT process*.

**power boring** *Rack feed boring*.

**pozzolanic** A property of a dust such that it can react with lime in the presence of water to produce a cement like material. Pozzolans can be used in the *stabilisation of hazardous waste* or in *grout curtains*. Pozzolanic materials can be fly ash or cement kiln dust.

**PPCPs** Pharmaceuticals and Personal Care Products. Chemicals from this group are found increasingly in wastewaters and effluents. Their effect on the environment is causing increasing concern and some of them are *endocrine disrupters*.

**PPC Regulations** *Pollution Prevention and Control Regulations 2000*.

**ppb** Parts per billion.

**ppmv** Parts per million by volume.

**pre-aeration** A treatment of wastewater before the *sedimentation tanks* by blowing air through it. It may improve sedimentation, certainly helps to keep it fresh and to remove greases and fats by flotation, and may form part of grit removal in the *aerated grit chamber*. Effluents can be aerated after sedimentation and before biological treatment.

**precautionary principle** A principle in pollution control that prudent action should be taken to avoid or reduce environmental risk and taken before any serious environmental problem is encountered. The precautionary principle is incorporated into the Treaty on European Union.

**pre-chlorination** A preliminary *chlorination* before other water treatment processes.

**precipitation** (1) Rain, dew, snow, hail, sleet or any other form of water from the sky, measured as millimetres of rain. It can also mean a *fallout* of polluting dust or *electrostatic precipitation*. (2) Release from solution of a substance by its appearance in the solvent as a fine powder or crystals. For removal from water, the precipitate must either flocculate for settlement or be filtered. *See also coagulation*.

**precoated filter** For dewatering a difficult sludge, the expense of pre-coating filter cloth in a *vacuum filter* or *filter plate press* may be justified by the

increase in efficiency of the filter. The pre-coating, of *diatomite*, *fly ash*, etc., is applied 50 to 100 mm thick by a slurry which is allowed to flow through the filter under vacuum. After the whole area has been coated, the sludge cycle is started. *Filter cake* is discharged with a thin slice of the pre-coat. *See filter candle.*

**pre-comminutor** *Shredding.*

**pre-composting** The work done on municipal refuse before it goes to the composting process—removal of some or all of the glass and metals. It may include single or *double shredding.*

**precursor** Forerunner. In water treatment, organic substances in the raw water may be precursors to the formation of *trihalomethanes* after *chlorination.*

**predator** A being that attacks and kills another for food.

**predicted no effect concentration, PNEC** The highest concentration of a toxic chemical that does not cause an adverse effect in a specific living organism.

**pre-engineered treatment plant** *See package wastewater treatment plants.*

**pre-filt** A term for a sludge, slurry or other feed, before it enters a filter.

**pre-filtration, primary filtration, rough filtration** The use of *rapid gravity filters* or *microstrainers* for raw water without chemical additions, ahead of the *slow sand filters* to increase the length of their *filter run.*

**preliminary treatment** Any treatment of wastewater that precedes *primary sedimentation.* It is partly aimed at protecting equipment in later treatment. Mainly it is the removal of large solids, rags and grit by *screens, comminutors, grit channels,* etc. Oil, fat, grease, etc., may be removed in *pre-aeration.* For wastewater treatment works fed by *combined sewers,* preliminary treatment includes the proportioning of storm sewage—i.e. *stormwater overflows.*

**prescribed flow, minimum acceptable f.** The absolute minimum river flow which must not be diminished by abstraction and is maintained by *compensation water.* It is the minimum quality and quantity of water that will safeguard public health, including the dilution of effluent, and meeting the needs of other abstractors.

**prescribed concentration values** The term used in the UK for the maximum admissible concentration for a range of chemicals in drinking water as defined by the EU *Drinking Water Directive.*

**prescribed process and substances** In the UK, an industrial process and substances that are subject to *Integrated Pollution Control.* They include incineration and combustion processes. Prescribed substances include a list of air and water pollutants and pollutants released onto land.

**pre-sedimentation tanks** In water treatment, a term used for (1) *grit chambers* or (2) sedimentation processes used to remove large quantities or suspended material prior to the normal water treatment processes.

**pressure bursts** A burst in a water main that is caused primarily by excess pressure.

**pressure filter** (1) A *filter plate press.* (2) A rapid *sand filter* that is not open to the weather but is contained in a steel shell (*see Figure P.11*). It can

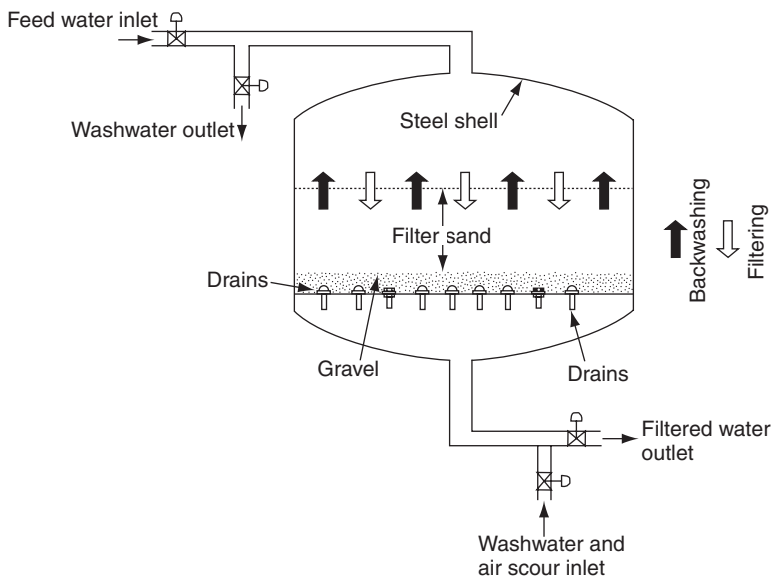

**Figure P.11** Pressure filter.

therefore work at a pressure higher than the gravity head and may be an *in-line* treatment. The sand is 0.45 to 1 m deep, with an *effective size* between 0.5 and 1 mm and a maximum *uniformity coefficient* of 1.7. *Surface loading rates* are from 4 to 10 m<sup>3</sup>/h per m<sup>2</sup> of filter area, although up to 20 m<sup>3</sup>/h per m<sup>2</sup> has been used. *Compare rapid gravity filter.*

**pressure flotation** See *dissolved air flotation*.

**pressure flow** See *pipe flow*.

**pressure management, pressure reduction** Managing the water pressure has the potential for reducing leakage, reducing pressure related consumption, reducing frequency of bursts and reducing night time pressure. However, the reduced water pressure must continue to allow water to reach the topmost storey which it would have normally reached. Also adequate flow at hydrants must be maintained. The pressure may be managed to maintain a relatively low pressure of 15 to 25 m of head in the mains at peak daily demand. The flow to a single property is maintained at 20 l/min at peak daily demand with a minimum of 9 l/min.

**pressure reducing valves, PRVs** Valves that can maintain a constant outlet pressure over a range of flows. PRVs can have a major effect on reducing *night flows* and also reduce daytime leakage.

**pressure scraping** A technique used to clean the inside of a water main prior to rehabilitation. A metal scraper or pig is pushed along the pipe by water pressure. The debris on the inside of the pipe is dislodged and flushed away with water. It is less effective than *drag scraping* or *rack feed boring*.

**pressure sewer, force main s.** A sewer that is being pumped, i.e. it is under pressure. The discharge from the pressure sewer may be to a gravity sewer.

**pressure surge in pipe flow, water hammer** A pressure wave caused by an adjustment to a valve, a change in pumping rate, etc. Such waves may be partly reflected at pipe fittings or changes in cross-section. The pressure generated during the surge greatly exceeds that in steady flow, and resonance may result in pressures being multiplied even more. No major pumping scheme or hydroelectric scheme should be designed without an analysis of pressure surges. Water hammer is so called because of the noise caused in the pipes. *See surge prevention.*

**pressure sustaining valves, PSVs** Valves that can maintain a constant inlet pressure over a range of flows and outlet pressures. PSVs are used to ensure upstream users of the water have adequate pressure at peak flow periods.

**pressure zones** In water supply, a distinct zone in which the quality of water is monitored. The normal maximum head in a zone is 70 m and the minimum head 30 m. Too small a pressure difference is expensive in *service reservoirs* and too large a difference produces excessive pressures in low lying buildings. Tall buildings may need their own booster pumps. Each zone may have its own service reservoir. Zones should be interconnect to give versatility to the water supply system. *See ring main.*

**pre-straining** The use of *pre-coated filters*.

**prestressed concrete** A material that has been used for water and wastewater pipes since the 1950s. It is mainly used for the large diameter pipes or sewers.

**presumptive coliform count** A *coliform count* made statistically, as in the *most probable number* and *membrane filtration* methods, not by a direct *plate count*.

**pretreatment** (1) *In house treatment*. (2) In wastewater treatment, *preliminary treatment*. (3) For sludge treatment, *conditioning* to improve its *dewaterability*.

**Prevention of Significant Deterioration, PSD** In the USA, an area that meets the National Ambient Standards for an air pollutant is declared a PSD area for the pollutant. The amount of allowable air quality deterioration is defined and must be reflected in the allowable emissions from all new stationary sources of air pollution in that area.

**primary air** (1) or *underfire air* The air supplied to a combustion chamber of an incinerator that is fed under the grates and material that is being burnt, unlike the *secondary air*. The primary air is the main source of oxygen for combustion of the waste. (2) The air supplied to the *primary combustion chamber* in a two stage incinerator. *See starved air incineration.*

**primary barrier** In a landfill site, the first liner in a *landfill liner* system.

**primary biosolids** *Primary sludge*.

**primary clarifier** *Primary sedimentation*.

**primary combustion chamber** The section of a two stage incinerator where the organic part of the waste is volatilised. Some combustion may occur. The temperature is typically 700 to 800 °C. *See secondary combustion chamber.*

**primary digestion** See *anaerobic sludge digestion tank, high rate anaerobic sludge digestion*.

**primary effluent** Effluent after *primary treatment* of a wastewater.

**primary emission** A description of *air pollutants* from an identifiable source (the emitter), often a chimney. Compare *secondary emission*.

**primary filtration** *Pre-filtration*.

**primary material** A raw material obtained from natural resources such as plants, trees, animals or minerals, unlike a *secondary material*.

**primary particulates** Particles found in the atmosphere in the form they were emitted. The control of primary particulates is a common part of air pollution control from industrial emissions. Compare *secondary particulates*.

**primary pollutant** A pollutant that is present in the source of the pollution, unlike a *secondary pollutant*.

**primary production** Term used in *ecology* to describe organic substances such as material produced in *photosynthesis* by algae, plants, etc.

**primary sedimentation** The *sedimentation* in wastewater treatment that immediately follows grit removal, releases settled wastewater for biological treatment and removes organic solids as sludge. *Radial flow sedimentation tanks* or *horizontal flow sedimentation tanks* may be used. The design is often based on the *surface loading rate*, which should be about 30 to 45 m<sup>3</sup> m<sup>-2</sup>d<sup>-1</sup> at maximum flow to ensure 50 to 70% removal of suspended solids and about 30% removal of BOD from domestic wastewater. Alternatively, the design retention time of 1.5 to 2 h at maximum flow, usually 3 times dwf. *Weir loadings* should be less than 250 m<sup>3</sup> m<sup>-1</sup> day<sup>-1</sup>, although this is less critical than the overflow rate. See *primary sludge, sludge hopper*.

**primary shredding or pulverising** The first stage of *shredding* or pulverising refuse to about 15 cm in size. It is often followed by *secondary shredding*.

**primary sludge** The sludge from the settlement of wastewater *primary sedimentation*. It contains from 6 to 8% solids, unless it is a *mixed sludge*, which will be 3 to 4% solids. See *sludge production*.

**primary treatment** For wastewater treatment, the first major treatment process, which is usually *primary sedimentation*.

**principal organic hazardous constituents, POHC** A term used in the USA to define the most important hazardous organics in a particular waste stream.

**priority hazardous substances** See *priority substances*.

**priority pollutants** A list of 129 pollutants considered by the *USEPA* to be the most important toxic pollutants that are to be controlled in wastewater discharges. The list includes organic and inorganic substances and a range of pesticides, herbicides and insecticides. Over half of the compounds are volatile organic compounds (*VOCs*).

**priority substances** The *Water Framework Directive, 2000* states that priority substances must be progressively reduced from discharges within the EU. The list of these substances is given in *Table P.1*. Priority substances include the sub-group of priority hazardous substances which are defined as substances that are toxic, persistent and liable to bioaccumulate. The priority hazardous substances must be progressively reduced and phased

**Table P.1** EU Priority Substances, with regard to discharges to European surface and coastal waters.

<i>priority hazardous substances</i>	<i>priority substances under review*</i>	<i>priority substances</i>
cadmium & its compounds	anthracene	alachlor
chloroalkanes C10–13	atrazine	benzene
hexachlorobenzene	chlorpyrifos	chlorfenvinphos
hexachlorobutadiene	di (ethylhexyl) phthalate (DEHP)	1,2-dichloroethane
hexachlorocyclohexane	endosulfan	dichloromethane
mercury & its compounds	lead & its compounds	diuron
nonylphenols	naphthalene	isoproturon
pentachlorobenzene	octylphenols	nickel & its compounds
polycyclic aromatic hydrocarbons (PAHs) <sup>†</sup>	pentabromodiphenylether	simazine
tributyltin compounds	pentachlorophenol	trichloromethane (chloroform)
	trichlorobenzenes	
	trifluralin	

\* substances that are being reviewed for possible re-grading as priority hazardous substances.

<sup>†</sup>Six reference PAHs are analysed: benzo(a)pyrene, benzo(b)fluoranthene, benzo(k)fluoranthene, benzo(ghi)perylene, fluoroanthene, indeno(1,2,3-cd)pyrene. (Note: various alternative spellings are used for PAHs: 'fluoranthene' can be spelt 'fluoroanthene'; 'benzo' can be spelt 'benz'; 'indeno' can be spelt 'indeno'.)

out from discharges within a defined time period. Priority hazardous substances under review are substances that are being considered for re-grading as priority hazardous substances

**privy vault** A *vault latrine* or possibly a *bucket latrine*.

**PRNs** *Packaging recovery notes*.

**procaryote** **prokaryote** Organisms such as bacteria that have one cell and contain no nuclear membrane.

**production** In an *ecological* sense, breeding and the bodily growth that accompanies it. See *primary production*.

**products of incomplete combustion, PICs** If a waste is not fully oxidised in an incinerator the products may include a range of organics including hydrocarbons and *polycyclic aromatic hydrocarbons*. *Dioxins* and *dibenzofurans* can be formed during the incineration of waste that contains chlorinated plastics. None should be formed if the incinerator temperature is maintained above 850 to 900 °C for at least two seconds, or 1000 °C for one second. In incomplete combustion, *PCBs* may decompose to other toxic compounds. In an incinerator, excess air is required in order to minimise PICs and maximise products of complete combustion (POCs). Effective collection of fly ash is important as some of the toxic products may adhere to the particles. Bottom ash or fly ash from the incinerator may be contaminated with PICs.

**profundal zone** The zone in a lake or sea that is below the *euphotic zone*.

**progressing cavity pump** A pump that has the outer stationary part (the stator) shaped inside as a helix. A single helix rotor revolves eccentrically inside the stator. A continuous cavity is formed and progresses towards

the discharge end of the pump as the rotor rotates. These pumps are good for pumping slurries and sludges or when a large suction lift (e.g. greater than 100 m) is required.

**prokaryote** *procaryote*.

**prompt NO** In combustion, carbon bearing radicals react with  $N_2$  to yield nitrogen radicals which react with  $O_2$  to produce nitric oxide, NO.

**propeller pump** An *axial flow pump*.

**proportioning of stormwater** The separation of wastewater flows into what can and what cannot be treated at the wastewater treatment works based on the hydraulic capacity of the works. *See combined sewer overflow*.

**protection of wells** *See well pollution*.

**proteins** Substances, essential to the living cell and to human food, which are *polymers of amino acids*. The link between the amino acid groups is called a peptide link. During wastewater treatment proteins may be hydrolysed to polypeptides and then to amino acids, which may be further degraded to *ammonia* and simple organic compounds. Proteins are the basis of *enzymes*. *See hydrolysis, single cell protein*.

**proteolytic enzymes** An *enzyme* that helps to break down *proteins* into simpler compounds.

*Proteus vulgaris, P. mirabilis* Bacteria that can cause *gastro-enteritis*.

**Protista** A vast group of micro-organisms that include bacteria, actinomycetes, algae and protozoa.

**protoplasm** The body fluid of all *cells* of bacteria, plants or animals. An approximation to the protoplasm in *protozoa* is  $C_7H_{14}O_{13}N$ , but this mixture of water, *proteins*, mineral salts, carbohydrates, etc., is in a constant state of chemical change.

**protozoology** The study of *protozoa*.

**protozoa** Mobile, single celled *protists* from 2 to several hundred microns long. Most of them are *aerobic* and *heterotrophic*. They move by *cilia*, *flagella* or *pseudopods*, and are classified into *ciliate protozoa*, *flagellate protozoa*, *rhizopods* and *spore forming protozoa*. Protozoa may indicate (by their type) the condition of *activated sludge*, and they are useful also in *trickling filters*. They graze on bacteria, and algae. Most protozoa are harmless but a few cause illness in humans (see below). Because protozoa can be seen under the *optical microscope*, they may be indicators of river conditions. In streams with organic pollution *Paramecium* and *Colpidium* are often found in the *zooplankton*, while *Vorticella* and *Opercularia* are found in the bottom mud. Often the population densities of protozoa are more important than the species present.

**protozoal diseases** Some protozoa are pathogenic to man causing diseases such as *malaria* and *trypanosomiasis*. A number of protozoal diseases are waterborne. These diseases cannot be effectively controlled by normal disinfection and the cysts or *oocysts* are difficult to remove during water treatment (*see membrane processes*). *Cryptosporidiosis* and *giardiasis* are two of the major causes of waterborne disease in developed countries. *See also amoebiasis, balantidiasis*.

**protozoon** Singular of *protozoa*.

**proximity principle** In waste disposal, the concept that wastes should be managed, treated and preferably disposed in the proximity that they are generated.

**PRV** *Pressure reducing valves.*

**PSD** *Prevention of Significant Deterioration.*

***Pseudomonas*** A widespread *facultative bacterium* with many species which thrives in both *aerobic* and anaerobic biological treatment. In humans some can cause obstinate infections of the ear, urinary tract, etc. Others are important denitrifiers, or affect the health of fish, or grow on *membranes* of *desalination* plants or *sand filters* or *carbon adsorption beds*. Others can consume crude oil at the oil water interface.

***Pseudomonas aeruginosa*** This *Pseudomonas*, often present in human excreta, resists *chlorination* more than the coliforms. It may be used for evaluating the bacterial quality of water for swimming pools or drinking. Although often found on healthy skin, it can be an opportunistic pathogen infecting cuts etc.

**pseudopod** A temporary protrusion from a cell (e.g. of an *amoeba*) which engulfs food or moves its parent *protozoon*.

***Psychoda*** *Diptera* flies that are common on *trickling filters*, particularly *P. alternata* and *P. severini*. Often the commonest *filter fly*, they are *grazing fauna*.

**psychometric chart** A chart that relates temperature and humidity. It indicates the saturation humidity.

**psychophile** A micro-organism that thrives at low temperatures, even at 0°C provided that the water is not frozen, unlike *thermophiles* and *mesophiles*.

**psychophilic digestion** *See cold digestion.*

**Pt/Co scale** *Platinum Cobalt scale* for colour measurement in water.

**PTBs** Chemicals that are persistent, toxic and liable to *bioaccumulate*.

**PTE** *Potentially toxic elements.*

**public health, community medicine** The mental and physical health of people, both as individuals and as part of the community. It therefore includes the quality of food, air, water, work, home, leisure, etc.

**public health engineering** A term that was used in the UK for *environmental engineering*.

**public health inspector** A term that was used in the UK for *environmental health officers* before 1975.

**public scoping** The process of *scoping* in an *environmental impact assessment* where the public are invited to participate.

**puddled clay** Clay mixed with a small amount of water and then placed and worked to form an impermeable clay layer. *See below.*

**puddling** Crushing a soil (e.g. clay) mixed with a small amount of water and then placing it and compacting with a roller to make it homogeneous and reduce its permeability. The technique is used to make a watertight base of a *landfill* site in order to prevent *leachate* percolating from the bottom or sides of the site.

**pulmonary irritants** *Chlorine*, nitrogen oxides or sulphur oxides and other substances that affect the lungs.

**pulp** (1) A mixture of finely ground mineral and water which is subjected to wet *mineral dressing*. It may have only 1% solids but is usually more concentrated. (2) In paper manufacture, a mixture of *cellulose* and water.



**pulp and paper manufacturing wastewater** See *paper and pulp manufacturing wastewater*.

**Pulsator** A type of *sludge blanket clarifier* into which water with coagulants is fed in pulses, not continuously. The pulses occur every 30 s, with 10 s to empty the water from the storage bell into the *clarifier*. The coagulated water enters beneath the *sludge blanket* and the clarified water flows from the top.

**pulsed bed sand filter** A downward flow filter in which air is occasionally pulsed up through the sand in order to redistribute the solids accumulating on the surface of the filter. This enables longer filter runs before *backwashing*. The sand bed is shallow at 0.3 m deep. It has been used for *tertiary treatment* of wastewater.

**pulse jet baghouse, pulsed air cleaned baghouse** A *baghouse* that is cleaned by stopping the general flow through the bags and then using pulses of compressed air in the opposite direction in order to remove the dust accumulation. The dust drops off and falls into the dust bunker.

**pulverised fuel ash, PFA** The small particles of ash that are generated from the burning of pulverised coal in electricity generating plant. PFA has *pozzolanic* properties.

**pulveriser, pulverizer** Machines used to reduce the size of refuse, waste or other material, by pulverising. Dry pulverisers are typically *hammer mills* (Figure H.1) or possibly *disc mills*. The term pulveriser is sometimes synonymous with *shredder*. See also *wet pulveriser*.

**pulverising, pulverizing** In waste management, the reduction in size of refuse or other waste by crushing, beating, grinding, shearing, etc. See *shredding*.

**pumped lining** A method for the rehabilitation of sewers. Steel flanged forms are manufactured to 75 mm less than the profile of the sewer. These forms are placed inside the precleaned sewer, carefully aligned by pins and bolts. Concrete is then pumped into the gap. Reinforcement can be included if necessary. Large sewers can be rehabilitated using this method. The technique gives substantial structural support to the existing sewer and stops leaks.

**pumped storage** (1) The pumping of water some hundreds of metres above a base reservoir for the storage of energy to drive water turbines that turn electrical generators at the foot of the pipes. Usually the pump is also used as the turbine, since pumping and generation take place at different times. Large pumped storage schemes exist throughout the world. (2) The pumping of water into a reservoir for water supply (Figure P.12). The expense of pumping is compensated by the freedom with which the reservoir can be located. See *raw water storage*.

**pump well** A *wet well* or a *dry well*.

**pupa** The 'sleeping' stage of an *insect's* life after the end of the *larval* stage. It develops into the adult (imago) usually in summer or spring.

**pure oxygen activated sludge** *Oxygen activated sludge*.

**purgeable organics** Volatile organics that can be stripped out of water by simple aeration.

**purification** In water treatment purification is usually the removal of solids, taste, colour, pathogens, etc. For conventional wastewater treatment it is often the removal of more than 90% of the solids and organic

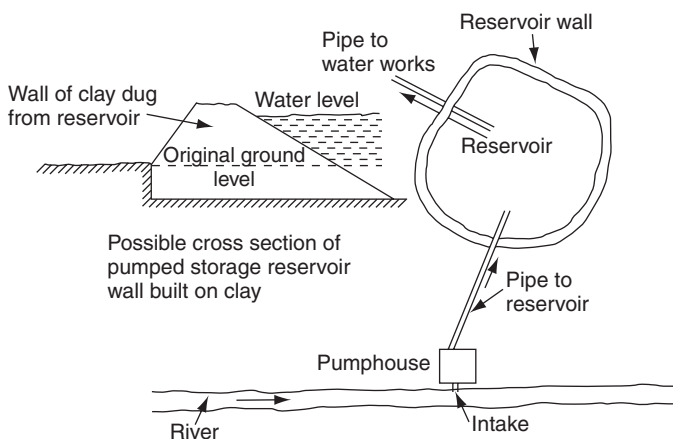

Figure P.12 Pumped storage reservoir for water supply.

compounds, although the effluent may be further purified by tertiary or *advanced wastewater treatment*.

**putrescible** A description of organic matter that rots and decays and releases unpleasant smells. The microbial process is known as putrefaction.

**PV Permanganate value.**

**PVC-U, unplasticised PVC, uPVC** Pipes of *polyvinyl chloride* (PVC) have been used since the 1960s, sometimes as a water pipe material but extensively for small sewers and stormwater pipes. PVC-U has some resistance to UV light, although all PVC eventually becomes brittle when exposed to sunlight.

**pyramidal sedimentation tank** A tank shaped like an inverted pyramid, sometimes used as a *primary sedimentation* or *secondary sedimentation tank* in small wastewater treatment works. The steep sides enables the sludge to slide down without the need for scraping. The inlet is usually central and the outlet weirs peripheral. The maximum practical surface width is 9 m and the *surface loading rate* should not exceed  $12 \text{ m}^3 \text{ m}^{-2} \text{ d}^{-1}$  at maximum flow. The inlet is near the bottom of the tank but above the settled sludge layer.

**pyrolysis** (verb *pyrolyse*), **destructive distillation** Heating at about 400 to 800 °C absence of air or with a restricted air or oxygen supply. The distinction between pyrolysis and *incineration* is that in a pyrolysis unit the organic material or carbon is not fully oxidised and the residue still has a heating value. The pyrolysis products differ with the temperature of treatment and may be char, oils or combustible gases. High temperatures produce more gas and low temperatures produce more liquids or char. The pyrolysis product can be used as a fuel. Pyrolysis can be used to treat solid waste after the removal of metals, glass, etc. Pyrolysis can be used to produce oil from scrap tyres. The cost of pyrolysis may be less than incineration but the volume reduction is smaller.

**pyrolytic incinerator** See *starved air incineration*.



---

**quaternary ammonium compound** A compound in which the four hydrogen atoms next to the nitrogen in  $\text{NH}_4^+$  are replaced by four organic radicals. They may be used as dispersants, cationic *synthetic detergents* or the active part of anionic *ion exchange* resins. The synthetic detergents can be made microbiocidal.

**quenching tower** An *evaporative tower*.

**quicklime** Lime  $\text{CaO}$ . When reacted with water, calcium hydroxide is formed.

**quiescent sedimentation** *Sedimentation* by a *fill and draw tank*.

**rack** A *bar screen*, often a *coarse screen*.

**rack feed boring, power boring** A technique used to clean the inside of a water main prior to rehabilitation. It involves cleaning the pipe with a metal flay on the end of rods which are rotated by the driving rig that pushes the boring flay through the pipe. The *turburculations* are scraped from the pipe and flushed away with water.

**rad** The unit of absorbed dose of radiation. One hundred rad equals one *Gray*.

**radial flow pump** A pump with the water moving away from the axis of rotation, as in the *centrifugal pump*.

**radial flow sedimentation tank** (Figure R.1) A circular *sedimentation tank* with the water or wastewater entering at the centre through an upward flow pipe into a vertical walled drum. The drum distributes the water or wastewater through its bottom and sides. Effluent flows out over a perimeter weir. The flow velocity is greatest at the centre and there is also an upward flow effect. Rotating sludge scrapers (either *fixed bridge scrapers* or *rotating bridge scrapers*) sweep the sludge into a central *sludge hopper*. Scraper speeds should not exceed 25 mm/s, to avoid breaking up the sludge. Radial flow tanks may be used for *primary sedimentation* or *secondary sedimentation*. Tanks can be large, up to 60 m diameter for primary and 35 m diameter for secondary tanks. Average depths are usually 2.5 to 4 m with a floor slope of 7.5 to 10° to the horizontal. Some tanks may be flat bottomed, with *vee-blade scrapers*.

**radioactive waste** This waste may be generated from a range of industries including hospitals and nuclear power generation. Cooling water and fuel

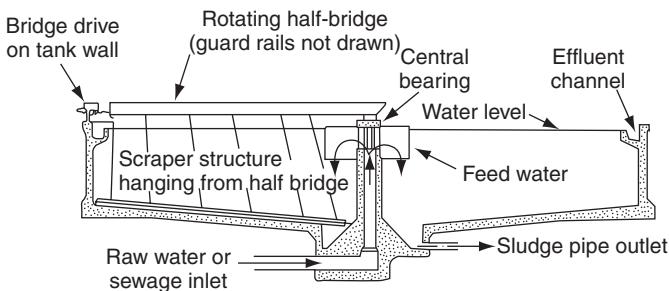

**Figure R.1** Radial flow sedimentation tank with half bridge scraper.

reprocessing water are the two main liquid wastes from nuclear reactors. Cooling water is usually a minor problem and generally flows through *closed recirculation systems*. The fuel reprocessing waste is more difficult to dispose. Decay products of uranium or plutonium are removed from the reactor fuel. These mixed fission products also contain metals from the fuel elements. The solid waste products contain strontium-90 and caesium-137, which are long lasting, high energy radio-isotopes and generate considerable heat over decades. Radioactive waste is divided into *high level radioactive waste, intermediate radioactive waste* and *low level radioactive waste*. See *encapsulation, transuranic radioactive waste*.

**radioactivity, radioactive decay** The disintegration of some atoms, called *radioisotopes*, with the resulting emission of *alpha particles* or *beta particles* or *gamma radiation*, leading to the formation of other *isotopes* (decay products). The EU Drinking Water Directive for radioactivity states a maximum dose of 0.1 mSv/year. The WHO guideline maximum values for drinking water are 0.1 Bq/l for alpha activity and 1 Bq/l for beta activity. The *USEPA MCL* in drinking water is 15 pCi/l for alpha particles and 4 millirem/year for beta particles and photons.

**radioisotope, radioactive isotope** An *isotope* that disintegrates, with emission of radiation. Some radioisotopes are used as *tracers*.

**radionuclides** Radioactive particles, including *alpha particles, beta particles, radium, radon* and *uranium*.

**radiotracer** A radioactive *tracer*.

**radium** Radium and its compounds are radioactive and carcinogenic to humans. The *USEPA* states a *MCL* in drinking water of 5 pCi/l.

**radius of influence of well** (1) *Cone of depression*, see *Figure C.7*. (2) The distance from an *injection well* where the effect of the liquid or gaseous injection can still be ascertained.

**radon** A radioactive gas that has a half life of 3.8 days. It is emitted from rocks such as granite. Radon decays to produce polonium which can attach to dust and be inhaled. Polonium decays and emits  $\alpha$  particles which increases the incidence of lung cancer. Radon can build up in houses with limited ventilation. The control of radon in buildings is by ventilating the space below a suspended floor or installing a gas impermeable membrane to reduce gas penetration into the building.

**raffinate** The liquid that remains after certain components have been removed from the liquid, e.g. by *solvent extraction* or *distillation*.

**raft lagoon** See *floating aquatic plant treatment system*.

**rainfall hyetograph** A *hyetograph*.

**rainfall return period** Statistically, the number of years between the reoccurrence of a particular rainfall intensity and duration; the more severe the storm, the longer the return period.

**rain gun** A nozzle that sprays water, liquid manure or wastewater effluent into the air and out on to the land. The jet also makes the nozzle rotate. One rain gun can throw its water jet up to 60 m away, consuming a maximum 2 m<sup>3</sup>/min. The gun may be stationary or move automatically along the field.

**rainout** Removal of particles or gases from the atmosphere during the formation of raindrops on nuclei. Rainout takes place in the cloud or near it; *washout* takes place further down, nearer the earth.

**rainwater** One of the purest of waters, apart from its gas content, which can be considerable. It is soft and contains carbon dioxide; therefore, it can dissolve lead. If rainwater is caught from any roof for drinking, the first flush should be rejected down the drain and the gutters and roof should be kept clean.

**rainwater harvesting** The collection and use of rainwater by a household for direct use in toilet flushing, cleaning purposes, garden watering, etc., but not normally drinking water.

**ramming** See *pipe ramming*.

**ram pump** A *piston pump*.

**rapid deep bed filter, r. granular f.** The filtering of a water or effluent through a bed of granular solid media 1 to 2 m deep. The head of water above the filter is at least 1 m (*compare slow sand filter*). The media may be sand, anthracite, etc., which form pores between one another that allow the water through but hold the suspended solids. Particles smaller than the pore size may also be removed because of their adsorption to the surface of the media. The flow of water through the filter may be by gravity (*rapid gravity filter* or *slow sand filter*) or under pressure in a *pressure filter* (2). The flow may be upwards as in an *upflow filter*.

**rapid gravity filter** A *rapid deep bed filter* where the flow of water through the filter is downward and by gravity. The media may be sand (*see below* and *sand filter*) or a mixture of media in a *dual media filter* or *multi-media filter*. It is not a *slow sand filter* or a *pressure filter*.

**rapid gravity sand filter, r. and f., r. downflow sand f.** An open tank with 1 to 1.5 m of sand covered with 2 m or more of water (*see Figure R.2*). Rapid gravity sand filters are widely used in water treatment and sometimes for the *tertiary treatment* of wastewater. They use sand with a  $D_{10}$  *effective size* between 0.35 and 0.55 mm and a *uniformity coefficient* between 1.5 and 2.0. The underdrains or pipe manifold beneath the sand, set in pea gravel or shingle, are used both for removing the filtrate and for *backwashing* the filter with air or wash water. The filtrate is used as wash water. Because of the rapid flow rate the sand clogs quickly and backwashing is normally required daily. Backwashing may be preceded by *air scouring*. The *surface loading rate* of a rapid sand filter should be 4 to  $6 \text{ m}^3 \text{ m}^{-2} \text{ hour}^{-1}$ , although plants have worked well at  $10 \text{ m}^3 \text{ m}^{-2} \text{ hour}^{-1}$ . Higher rates can be achieved if the filter is converted to a *multi-media filter* or *dual media filter*. (The term 'rapid gravity sand filter' may also mean a *pressure filter* (2).)

**rapid infiltration land treatment** A *land treatment system* where the settled wastewater is applied to the land and percolates down through the soil. This soil must be highly permeable, such as a sandy loam. The wastewater is treated biologically and filtered as it moves rapidly down through the soil. No surface runoff should occur, unlike *overland flow land treatment*. The area required is between 0.2 and 6 ha per  $1000 \text{ m}^3/\text{d}$

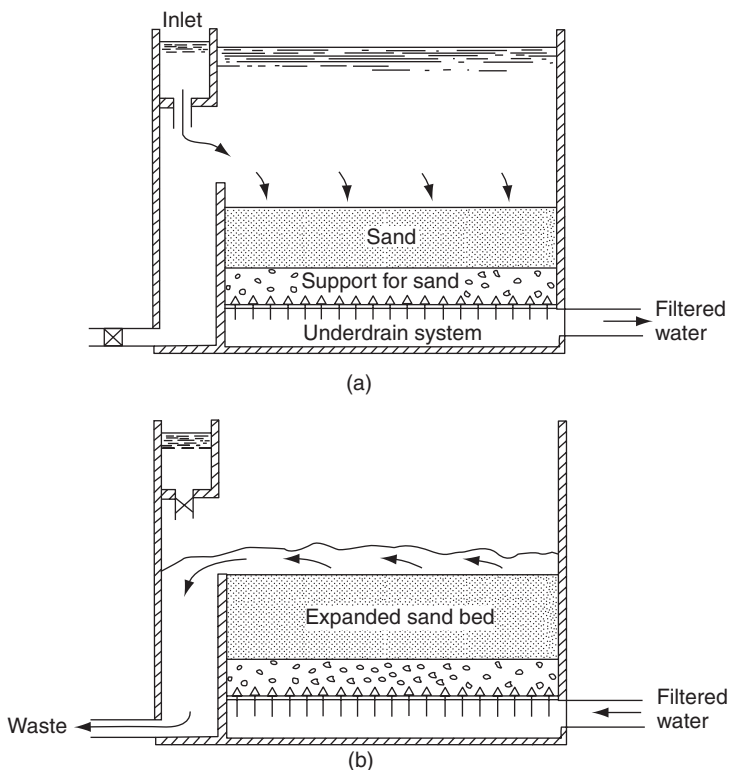

Figure R.2 Rapid gravity sand filter (a) normal operation; (b) backwashing.

of effluent flow. See *Figure L.5, slow rate land treatment, soil aquifer treatment*.

**rapping** *Electrostatic precipitators* need to have the dust rapped off them periodically.

**rasp mill, Dutch rasp** It resembles a large, vertical shaft *hammer mill* but rotates much more slowly, at about 5 to 6 rev/min, and the diameter is larger, some 6 to 8 m. Rapping pins on the base plate of the mill break up the refuse as it is pushed round. The crushed refuse falls through 50 mm diameter holes in the base plate. Uncrushable objects are pushed to the rim of the mill to exit holes designed for the purpose.

**rating** In *hydrology*, the relationship between the water level and the discharge (flow rate) of a stream, well or *aquifer*, or the work of taking the observations and making the calculations that establish the relationship.

**rating curve** A *stage discharge curve*.

**rating table** A tabulated version of a *stage discharge curve*.

**rationale method, Lloyd-Davis method** A method for calculating the peak flow in a river or sewer due to runoff from the surrounding catchment. The

peak flow ( $m^3/s$ ) = 0.278 CIA where C is the *runoff coefficient*, I is the rainfall intensity in mm/hr and A is the catchment area in  $km^2$ .

**rat tailed maggot** The *larva* of *Eristalis tenax*.

**rave** The beam along the back edge of a rear loading refuse collecting vehicle, on which a dust bin can be rested as it is emptied.

**raw sewage** Untreated domestic wastewater.

**raw sludge** *Primary sludge* or *secondary sludge* from wastewater treatment before it has undergone *wastewater sludge treatment*. After *mechanical dewatering of sludge* it is called raw *sludge cake*. Raw sludge contains many enteric bacteria. Septic raw sludge often stinks.

**raw water** Water intended for drinking or industry which has not been treated and so is stored in an *impounding reservoir* but not in a *service reservoir*. The quality of raw water varies with its source. See below.

**raw water storage** Surface water used for a supply needs to be stored before water treatment. For *direct supply reservoirs* this should be enough to maintain the supply to consumers during periods of low rainfall. *River regulating reservoirs* balance out peak flows in the river and maintain a given minimum flow. Water withdrawn from a river needs *bankside storage*, usually for 7 days. This enables the river intake to be closed if the water quality becomes unsuitable for a short time. Storage of raw water influences its quality in several ways. Some harmful bacteria die, partly because of *disinfection* by ultraviolet light. In warm weather algae will grow, particularly if the water is rich in nutrients, as in lowland industrial rivers. The algae will increase the turbidity of the water, and may influence its taste and smell and affect the working of the treatment processes. Growths of *cyanobacteria* may produce *endotoxins* in the water. Suspended matter, other than algae, should, however, settle during storage and reduce turbidity. If the bottom deposits become deoxygenated, they may produce tastes and smells and reduce ferric and manganic ions to ferrous and manganous ions, which are more soluble in water. The organic content of the water may decrease because of bacterial oxidation or sedimentation, but algal growth or *anaerobic* decay of the bottom deposits will increase the organic content. In general, if algal growth can be restricted and the organic deposits are not great, raw water improves with storage. See *upland catchment water*.

**RBC** A *rotating biological contactor*.

**RCRA** *Resource Conservation and Recovery Act 1976*.

**RDF** *Refuse derived fuel*.

**RDX** *Royal Demolition explosive*, 1,3,5-trinitro-1,3,5-triazine It is also known as cyclonite or hexogen.

**reactive wastes** In the USA, this term refers to wastes which are normally unstable, explosive or react violently with air or water.

**reactor** A tank or container or tower in which physical, chemical or biological treatment can take place.

**reaeration** (1) In *activated sludge* treatment, the addition of air to *return activated sludge* in a second *aeration tank* between the *secondary sedimentation tank* and the main aeration tank. (2) In rivers, lakes, etc., the acquisition



- of dissolved oxygen by turbulence or *photosynthesis*. It is important for maintaining the oxygen balance.
- recalcitrant** Description of a chemical that biodegrades slowly or not at all.
- recarbonation** Lowering the pH of a water by bubbling carbon dioxide, CO<sub>2</sub>, through it. In water treatment it is needed after *lime soda softening* for *stabilisation*. In wastewater treatment recarbonation is needed after ammonia stripping. The CO<sub>2</sub> is supplied either in bulk from brewers or distillers or in the flue gas from heating calcium carbonate in a lime kiln, etc.
- receiving water** The stream, river, lake or sea that receives the discharge of wastewater or treated effluent.
- recessed plate filter press, recessed plate press** A *filter plate press*.
- recharge** Refilling of *aquifers* either by *artificial recharge* or naturally by rain percolating through the soil and becoming *groundwater*.
- recharge basin or pit** See *spreading area*.
- reciprocating arm grit washer** Equipment for separating organic matter from grit in a *Detritor*. The reciprocating arm moves the grit up a ramp at the side of the unit, while wash water flows down the ramp back into it.
- reciprocating grate** See *moving grate incinerator*.
- reciprocating pump** A *piston pump*.
- recirculation** Circulation of fluid. In wastewater treatment usually either the return of activated sludge from *secondary sedimentation* to the *aeration tank* or the return of effluent for further biological treatment. In a *trickling filter*, whether high rate or standard rate, a minimum flow is needed to keep the *biofilm* moist. It is, therefore, sometimes necessary to pump *humus tank* effluent back to the filter as influent. Recirculation of leachate over a *landfill* may be used to achieve a *flushing bioreactor landfill*.
- recirculation clarifier** A *solids recirculation clarifier*.
- recirculation granular medium filter, recirculation sand filter** A type of *land treatment* of wastewater that consists of shallow beds of coarse sand or fine gravel (600 to 750 mm deep) with underdrains. Some of the effluent from the filter is recirculated back over the filter to enhance the treatment. It can be used to treat settled wastewater or further treat wastewater effluent or a septic tank effluent. Besides filtering out solids, bacteria colonise the sand and assist in BOD removal and *nitrification*. Compare *intermittent filtration*.
- recirculation type clarifier** A *solids recirculation clarifier*.
- reclaim** Raw material obtained by *reclamation*.
- reclamation of waste** See *waste recycling*.
- reclamation of wastewater** *Wastewater reclamation*.
- reconditioning tank** A *reaeration* tank for *returned activated sludge*.
- recovery zone of a river** Rivers are capable of *self purification*. Consequently, a length downstream of an effluent outfall is the recovery zone for that outfall. See *oxygen sag curve, saprobic classification*.
- rectangular sedimentation tank, r. clarifier** A *horizontal flow sedimentation tank*.
- rectification** Separation by distillation of mixed liquids that have different boiling points, the last process in the manufacture of ethanol, for example.

**recuperative or regenerative heat exchange** Cooling of one fluid by the heating of another fluid (occasionally a powder), usually in a tubular heat exchanger (but *see heat recovery wheel*). One type, gas to gas heat exchange, is sometimes used for heating flue gas after *wet scrubbing* and before discharge to the chimney in *stack gas reheating*.

**recuperative incineration** *See waste to energy plant.*

**recurrence period of rainfall** *See rainfall return period.*

**recycling of solid waste** *Waste recycling.*

**recycling plant, r. facility** *A materials recycling facility.*

**red list substances** A UK list of hazardous and highly toxic substances that must be strictly controlled in aqueous discharges. The red list contains all the substances in the European Union *List 1 substances* (black list).

**red list waste** Waste that is considered to be hazardous under the EU *Waste Shipment Regulations 1994* and its movement is strictly controlled or possibly banned by the Regulation.

**redox potential, oxidation reduction potential, ORP, rH, Eh** The electromotive force in millivolts set up in a solution between standard electrodes, due to the concentrations of oxidising or reducing substances present. *Aerobic* (oxidising) systems need positive redox potentials of +200 to +600 mV for the best results. *Anaerobic* processes have negative potentials of -100 to -200 mV. Several types of redox meter exist. Continuous redox meters are used in chemical treatment to control automatically the amount of reagent added. Redox potentials also are important for controlling corrosion.

**red tide** Large accumulations (a *bloom*) of red *dinoflagellates* that can be seen over an area of the sea. They may be associated with organic enrichment or coastal seas. The red tide can be toxic and destroy fisheries. Shellfish that are growing in areas of the red tide cannot be used for consumption.

**reduced sulphur** *Hydrogen sulphide.*

**reduction** In chemistry, loss of oxygen or gaining of electrons by a compound, the opposite of *oxidation*.

**reduction of refuse** *See refuse reduction.*

**red water** *See ferruginous discharges.*

**reed bed treatment, root zone flow wetland** Reeds, often *Phragmites australis*, can be grown in a subsurface flow *constructed wetland* area with an impermeable base. In horizontal flow reed beds, the wastewater flows below the surface across the soil or gravel bed, through the root zone and is collected in channels (*see Figure R.3*). In vertical flow reed beds, the wastewater is applied on top of the reed bed, flows down through a gravel bed, about 150 mm deep, and is collected in an underdrainage system of large stones. The area around the *rhizomes* (the rhizosphere) supports a large population of bacteria for BOD removal and possibly *nitrification*. The underground stems open up the soil allowing in air. The required land area for reed bed treatment of settled wastewater or septic tank effluent is 5 m<sup>2</sup> per person (about 1 m<sup>3</sup>/d per m<sup>2</sup> of land area). For *tertiary treatment* of a secondary effluent 1 m<sup>2</sup> of land is required per person (about 0.2 m<sup>3</sup>/d per m<sup>2</sup> of land area). Reed beds have been used for treating industrial

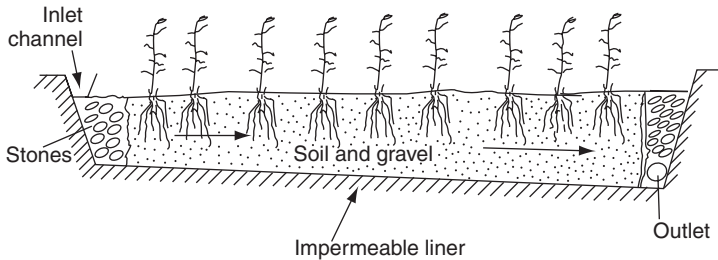

**Figure R.3** Reed bed treatment using horizontal flow.

wastewater. Reed beds with wastewater flowing over the surface may occasionally be used.

**reference dose, RfD** The daily intake of a particular substance that does not cause any adverse health effect. It is derived by dividing the NOAEL (no observed adverse effect level) by a safety factor such as 10. The NOAEL is chosen for the most sensitive species for which appropriate data is available. The data should be route specific, e.g. exposure to the chemical by inhalation or by ingestion etc. The measure is used by the *USEPA* as an alternative to the *acceptable daily intake*.

**refinery wastewater** See *oil refinery effluent*.

**reflectometer** An instrument that measures the proportion of the light that is reflected from a surface—an indication of its dirtiness or otherwise.

**reflux valve** A *non-return valve*.

**refractory** Obstinate; not damaged by heat. A refractory is a stony, often artificial material that withstands heat and flue gases, typically of firebrick or of concrete made with aluminous cement, and used for lining the inside of *incinerators* and other furnaces, where there is no *water wall*. Refractory organics are organic compounds that resist biological treatment. They biodegrade slowly or not at all.

**refuse** See below; see also *solid waste*.

**refuse chute** A vertical or nearly vertical pipe, 45 to 90 cm diameter, through which refuse can be dropped. Chutes should be isolated from the dwelling structure so as to prevent disturbance of neighbours by the noise of refuse falling down a chute. Chutes can be a fire hazard if they are not built with traps to prevent them acting as chimneys. They need periodic disinfection.

**refuse compression** See *baling*.

**refuse derived fuel RDF** **refuse derived fuel, RDF, waste d. f., WDF** After segregation to remove metals and glass (see *materials recycling facility*) the remaining domestic and commercial waste is mainly organic and it can be shredded, partially dried and compressed into pellets to be used as a fuel (see *Figure R.4*). The putrescible fraction may be removed from the waste in order to improve the calorific value of the RDF, which is about 12 to 16 MJ/kg. The hydrogen chloride emissions from burning RDF can be higher than other fuels because of the presence of chlorinated plastics, such as PVC, in the waste.

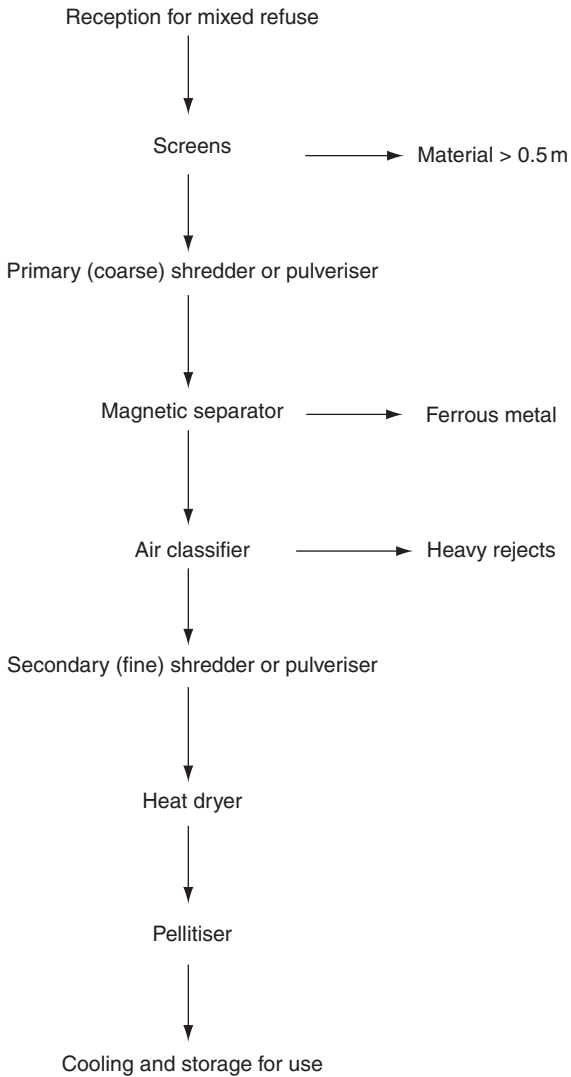

**Figure R.4** Production of refuse derived fuel from mixed domestic refuse, flow diagram.

**refuse disposal** See *solid waste treatment*.

**refuse reduction** (1) Size reduction in a *mill*. (2) Reduction of the mass of refuse to be tipped. This can be achieved by *incineration* or *composting* or by *waste recycling* (3) The reduction of the volume of refuse by the use of *compactors*.

**refuse transfer station** Refuse collection vehicles deposit their waste at the transfer station. The refuse is loaded onto other transport which is more appropriate for the haulage to the waste disposal site. This transport may be barges, or railway trucks or multi-axle road vehicles. The refuse may be loose tipped into the transport but compaction of the refuse into containers at the transfer station is neater and offers easier handling at the receiving end of the journey.

**refuse vehicle, r truck** *See collection vehicle.*

**regeneration** The recovery and treatment of a chemical so that it can be reused, as in *carbon adsorption beds* or *ion exchange* columns.

**regulating reservoir** A *river regulating reservoir.*

**rehabilitation of sewers** *Sewer rehabilitation.*

**reheating of flue gas** *See stack gas reheating.*

**reinforced plastic mortar (RPM) lining, reinforced thermosetting resin (RTR) lining** *Glassfibre reinforced cement lining.*

**Reinluft process** A technique for removing nitrogen oxides and sulphur oxides from a flue stream. The gas is mixed with oxygen and passed through an *activated carbon*. The oxides are adsorbed onto the activated carbon. The activated carbon is regenerated *in situ*, by passing through high temperature nitrogen or carbon dioxide, which desorbs the oxides.

**relative humidity RH** The ratio between the amount of water vapour in the air and the maximum which it could hold at the temperature concerned. The RH is a fraction, never more than 1. At 100% RH rain or dew is already falling or can soon be expected. For comfort in a building, the relative humidity should be in the range 30 to 70%. Low relative humidity can cause dry throats and woodwork to dry out which can shrink and crack. *See condensation, humidity.*

**rem, roentgen equivalent man (or mammal)** A measure of ionising radiation, that which has the biological effect of a roentgen of X rays. One hundred rem equals one *Sievert*.

**reovirus** A virus that can cause infantile gastroenteritis. The common route of transmission is *faecal-oral*.

**reoxygenation** Addition of oxygen to water from any source, including *photosynthesis, reaeration* or the entry of dilution water.

**rerounding** Inserting a device into a pipe in order to return it to a circular cross section. It may be used prior to the insertion of a liner inside the pipe.

**reservoir** (1) A large tank or lake to contain either raw water or treated water. *See direct supply reservoir, impounding reservoir, pumped storage, river regulating reservoir, service reservoir.* (2) An animal or human in which a pathogen lives and thereby acts as a potential source for spreading the pathogen and disease to others.

**reservoir by wash channel** A *by wash channel.*

**reservoir storage** *See raw water storage.*

**reservoir yield** *See yield of a water source.*

**residual chlorine** *See chlorine residual.*

**residual disinfectant** After *disinfection*, some of the disinfectant may remain in the water for hours. This is the residual disinfectant. It can be desirable in

water supply schemes in order to give some protection from microbial contamination of the water. In **wastewater disinfection**, it can be a disadvantage because it may be undesirable to discharge disinfecting chemicals into the natural receiving water. See **chlorine residual, disinfection by-products**.

**residuals management** In the treatment of water or gaseous or liquid effluents or solid waste, waste material can be generated by the treatment process. This may be known as residuals. For example, an incinerator produces two residuals, a gaseous effluent that must be cleaned and ash which requires disposal. Residuals management involves the planning, design and operation of the facilities for treatment and disposal of the residuals. See **organic residuals**.

**resistivity** The resistance to current flow measured in units of ohm-cm.

**resolving power** The *limit of resolution*.

**Resource Conservation and Recovery Act 1976, RCRA** USA legislation that covers the handling of hazardous waste at disposal facilities that are operating and those being planned.

**resource recovery** Obtaining what is useful. Often it means getting out of refuse what can be got. It can therefore imply a **mechanical sorting plant** to extract metals, glass, **cellulose, compost** or merely the heat from burning. Some of these aims exclude one another. All the heat cannot be recovered if the bulk of the paper is salvaged as fibre or converted to compost. See **waste recycling**.

**resource recovery facility** A **materials recycling facility**.

**respirable dust, r. particulates** Particles less than 3.5  $\mu\text{m}$  to 5  $\mu\text{m}$  are deposited in the lung and can be a health hazard. Larger dust is caught in the nose and throat and never reaches the lungs, so does no harm. Some 40% of the 2  $\mu\text{m}$  size is caught in the lungs. Some particles caught in the lungs may be as small as 0.02  $\mu\text{m}$ , but most of the very small dust floats out again with the outgoing air.

**respiration** The consumption of oxygen and release of carbon dioxide that occurs when organic material is broken down. It is defined as a **catabolic** process by which substances containing energy (carbohydrates, etc.) are oxidised by **enzymes** into simpler substances with less energy. Respiration is usually **aerobic**, involving molecular oxygen, although under **anoxic** conditions inorganic compounds can act as the source of oxygen (e.g. **denitrification**). This is still considered to be respiration, as opposed to fermentation.

**respiration rate** *Specific oxygen uptake rate*.

**respiratory quotient** The ratio of the volume of carbon dioxide produced by **respiration** to the volume of oxygen consumed.

**respirometer** The Warburg respirometer (*Figure R.5*) is an airtight flask used for measuring the oxygen demand of a water sample in it. A manometer connected to the flask shows the drop in volume caused by oxygen consumption. Any carbon dioxide produced is absorbed by potassium hydroxide held on a cup in the centre of the flask. The respirometer is always read at constant pressure, the liquid in the two arms being brought to the same level by the fluid level adjustment. This gives a direct reading of the

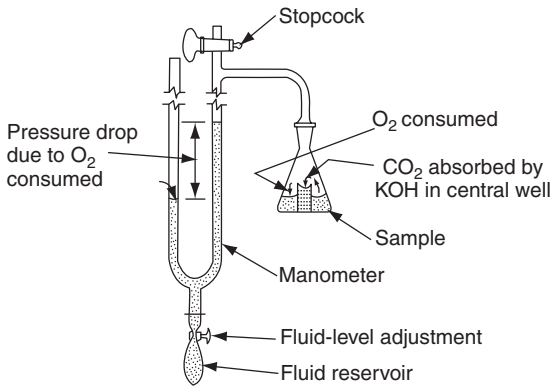

**Figure R.5** Respirometer, Warburg type.

change in volume due to the absorption of oxygen. Many other types exist, including electrolytic respirometers.

**retarding reservoir** A reservoir used for the temporary storage of flood water in order to reduce the extent of flooding.

**retentate** The material retained, e.g. by a filter.

**retention pond, wet p.** An artificial pond or lake used to collect and store stormwater runoff. Some sedimentation of particulates and biochemical oxidation of organic matter occurs in the pond. The depth of the pond is about 1 m at the edge and over 2 m in the middle. Sediment removal is required occasionally, possibly every 7 to 10 years. The retention time is about 14 days during the wettest month of the year.

**retention time, r. period, detention period** The time during which material (gas or liquid or solid) is kept in a tank or container or reservoir or treatment process etc. The theoretical retention time is the available free volume of the tank etc. divided by the flow through it. The actual retention time may be significantly less due to poor distribution of flow or *density currents*. See *mean cell residence time*.

**retort pyrolysis** *Pyrolysis* in a retort heated from outside; nothing burns inside the retort.

**return activated sludge, returned s.** *Activated sludge* that is returned to the *aeration tank* to mix with the influent wastewater unlike the *surplus sludge*.

The suspended solids in the return sludge is about twice that in the *MLSS*.

The flow rate of return sludge is usually 50% of the wastewater flow, or it may be kept constant and equal to the *dry weather flow*.

**return period of rainfall** See *rainfall return period*.

**re-use of wastewater** *Wastewater re-use*.

**reverse current filter** A *biflow filter* with a layer of gravel below the lowest sand. The raw water is partly filtered by upward passage through the gravel. Some of the flow is then diverted on to the top of the sand and the rest flows up through the sand to the outlet in the centre of the sand bed.

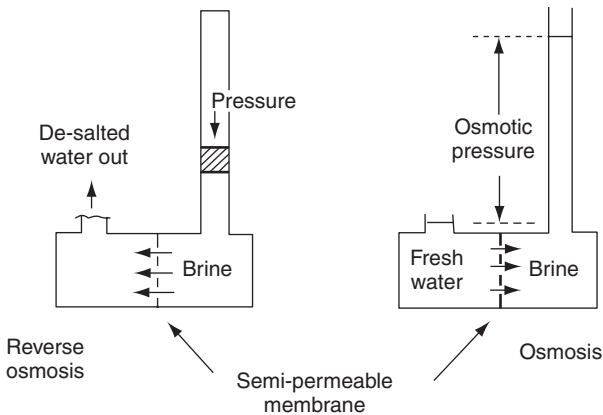

**Figure R.6** Reverse osmosis and osmosis.

**reverse deionisation (or deionization)** The use of anion exchange before cation exchange resin in the *deionisation* of water. The usual order is the reverse.

**reverse flow cyclone** A conventional, tangential inlet *cyclone*, usually for gas cleaning.

**reverse osmosis, RO** A *desalination* method for seawater, brackish water or effluents. In *osmosis* pure water passes from a weak solution through a *semi-permeable membrane* into a stronger solution. In RO the direction of flow is reversed by the application of a pressure, to the surface of the stronger solution, which is larger than the osmotic pressure. Relatively pure water is thus 'squeezed' out of the stronger solution. (see *Figure R.6*). For seawater the osmotic pressure is 25 bar. In RO, the pressure on the salty side is 40 to 80 bar or possibly more. The water flow is dependent on pressure and surface area of membrane. Membranes may be *cellulose acetate* or *polyamide* or *polysulphone*. The water entering the RO plant must be free of suspended matter and bacteria and so the inlet water may pass through a conventional water treatment work prior to RO. Salts may precipitate on salty side of the membrane (see *concentration polarization*) and reduce the efficiency of the process. An inlet water of 37 000 mg/l total dissolved solids (TDS) can be reduced to less than 500 mg/l TDS in one pass with 35% recovery of the water. Desalination from 42 000 mg/l TDS to < 500 mg/l TDS requires two stages of RO. RO plants can have a large capacity such as 50 000 m<sup>3</sup>/d.

**revolving screen** A *trommel*.

**Reynolds number, *Re*** A dimensionless number that describes *pipe flow*.

$$Re = \frac{V \times d}{\nu} = \frac{\rho \times V \times d}{\eta}$$

where V = mean velocity; d = diameter of pipe;  $\nu$  = kinematic viscosity;  $\eta$  = dynamic viscosity;  $\rho$  = density of the liquid.



**RfD** *Reference dose.*

**rH** The *redox potential*, measured in millivolts.

**Rhenipal process** *Lime stabilisation* of wastewater sludge where a mixture of pulverised fuel ash, *lime* and other additives are mixed with dewatered sludge. The reaction between the water and the chemicals raises the temperature in the sludge to 50 °C and *pasteurisation* is achieved together with stabilisation of the sludge.

**rheotaxis** The movement of an organism in response to a current of water or air.

**rhinitis** Runny or congested nose.

**rhithron zone** A section of a river or stream reach with a high velocity of flow.

It is an area of erosion. The river bottom is typically stony. The river has a high dissolved oxygen level. *Compare potamon zone.*

**rhizomes** The root system of plants such as reeds, the zone is known as the rhizosphere. *See reed bed treatment.*

**rhizopod, Rhizopoda** A class of *protozoa* including *amoebas*, which move and take in food by their *pseudopods*.

**rhodamine B** A pink dye which has been used as a chemical *tracer* although it causes cancer. It tends to adsorb on to solid particles.

**Rhodococcus** *See foaming (2).*

**rich waste gases** A gaseous effluent from an industrial process that has a concentration of pollutants that can be used economically. For example, the SO<sub>2</sub> content in the gas stream from the smelting of metal sulphide ores can be about 2 to 10%, which is high enough for economic recovery as H<sub>2</sub>SO<sub>4</sub>. *Compare lean waste gas.*

**rickettsiae** Small bacteria that resemble viruses because they are *obligate parasites*. They cause typhus and other fevers, for which the *vectors* are often lice. They are not transmitted by drinking water.

**RID** Regulement International concernment le transport des marchandise Dangereuse par chemin de fer. *See ADR/RID.*

**ridge and furrow aeration** An old method of forming an *aeration tank*, with *diffusers* in the bottom of the furrows to eliminate points where sludge might settle and putrefy.

**ridge and furrow irrigation** *Furrow irrigation.*

**RI/FS** Remedial Investigation and Feasibility Study. A term used in the USA for investigating waste disposal sites.

**rigidly separate system** *See separate system.*

**ring ditch** An *oxidation ditch*.

**Ringelmann chart** A chart showing 5 grades of the intensity of smoke in the air, developed by Maximillian Ringelmann of France in the late 1800s. It is sometimes, incorrectly, spelt Ringlemann. Ringelmann 0 is white and 5 is black. Ringelmann 1 is 20% opacity, 2 is 40% opacity, 3 is 60% opacity and 4 is 80% opacity. Ringlemann 2 is known as *brown smoke* and Ringelmann 4 is *black smoke*. The chart has the disadvantage that two people are needed to make an observation, one of them holding it at 15 m distance from the other, who observes it and the smoke. This disadvantage is overcome by the *micro-Ringelmann chart*, *telesmoke*, *carboscope* and other devices.

**ring-lace** See *suspended immobilised biomass reactors*.

**Ringlemann chart** See *Ringelmann chart*.

**ring main** A *main* connected to the water supply at two points—i.e. with a ring layout so that any consumer is served by at least two routes. This minimises inconvenience to consumers in the event of a burst pipe. A ring main also has the advantage that it eliminates dead ends in the pipe and the resulting deterioration in water quality that can occur with *stagnation*. The pipes in a ring main tend to be smaller and the pressures lower than with a *branch main*.

**Rio Earth Summit, 1992** A UN conference on environment and development that promoted strategies to halt and reverse environmental degradation and promote sustainable development. The UN Framework Convention on Climate Change (UNFCCC) was agreed. See *Kyoto Protocol 1997*.

**riparian rights** The water rights of those who own land on the banks of rivers, lakes or streams.

**ripening** See *maturing*.

**rise rate of a clarifier** *Overflow rate*.

**rising current separator** A device used in *mineral dressing* or a *mechanical sorting plant*, in which a rising current of water removes the lighter material from a mixture of light and dense materials. See *elutriation*.

**rising main, force m.** A *main* up which water or wastewater is pumped. Lack of oxygen can occur in rising sewers, causing *sulphide corrosion* at the outlet from the rising main.

**rising sludge** Sludge that has risen from the bottom of a *sedimentation tank* to float on the surface, lifted either by methane or nitrogen. Nitrogen is formed if a nitrified effluent denitrifies in the settling tank, releasing nitrogen gas. The major remedy is to increase the rates of sludge collection. In *primary sedimentation* tanks, sludge rises because it decomposes anaerobically, releasing methane. In warm weather desludging of the tanks may be needed more often because the oxygen is used up more quickly. See *denitrification*.

**risk and safety phrases, R phrases, S phrases** The system used in the EU to display the risk and safety of a chemical to indicate the hazardous nature of a substance. The phrase is denoted by R (for risk) or S (for safety) followed by a double digit figure. For example, R41 is 'risk of serious damage to eyes' and S25 is 'avoid contact with eyes'. Where more than one phrase is applicable a combination phrase is displayed. See *hazard codes*.

**river basin commission** In the USA a body formed by the federal government with one or more states, to co-ordinate the development of a river and related resources. The commission aim at broader planning of water resources than is possible for the individual state agencies.

**river basin management plan** See *Water Framework Directive, 2000*.

**river blindness** *Onchocerciasis*.

**river classification** Various classifications of river water quality exist, such as the *saprobic classification* and *biotic index*. In the UK the Surface Waters (River Ecosystem) (Classification) Regulations 1994 set statutory water

quality objectives in rivers in England and Wales. These objectives have to be achieved by 90% of the samples. Future objectives also have to be set. The classes of rivers are as follows:

<i>class of river</i>	<i>BOD<sub>5</sub> (ATU) mg/l</i>	<i>DO % saturation</i>	<i>ammonia mg/l</i>
1	2.5	80	0.25
2	4.0	70	0.6
3	6.0	60	1.3
4	8.0	50	2.5
5	15	20	9

Other parameters included in this classification system are pH, hardness, copper and zinc. This system is relatively simple and allows good pictorial maps to be drawn of a given river system with each river class in a different colour. *SEPA* uses a similar classification for rivers in Scotland, but the classes are A1, A2, B, C and D, which relate to class 1 to class 5. Some aesthetic parameters and fish species are included in the *SEPA* classification. Other approaches can be used to include greater detail of the chemical quality of a river such as the *Water Quality Index*. See also *Water Framework Directive, 2000*.

**riverine** Relating to or pertaining to or formed by a river.

**river quality modelling** Complex computer programmes for the analysis and simulation of river systems are readily available. The modelling packages may be used for flood prediction or the analysis of quality aspects in the river (e.g. dissolved oxygen and BOD distribution). The input to these models includes hydrological and hydraulic data together with a range of quality parameters. The models may be dynamic with variable inputs and co-efficients, giving a time variable output from the model.

**river regulating reservoir, regulating reservoir** (*Figure R.7*) An upstream *impounding reservoir* for *raw water storage* that can either reduce floods during high rainfall or release water when the river level downstream is too low for water to be withdrawn from it. It eliminates the cost of a long *aqueduct* and allows for multipurpose use, including amenity, recreation,

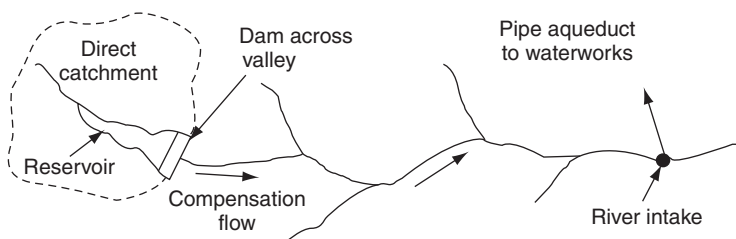

**Figure R.7** River regulating reservoir.

sailing and economy of water, quite unlike the single purpose *direct supply reservoir*.

**river water** Rivers furnish two thirds of drinking water supplies in England and Wales, largely from lower reaches. In Scotland most of the water is from upland catchments. The treatment of river water for use as a water supply is defined in the EU by the *Surface Water Directive 1975*. For the USA the *Surface Water Treatment Rule* defines the level of treatment required so that the water can be supplied for human consumption. See *oxygen balance*.

**RO** *Reverse osmosis*.

**road drainage** *Runoff* from streets enters the sewers through *gulleys*. For an 8 m wide street, a gully every 35 m should be sufficient. The runoff may contain much grit and salt in winter. A range of other contaminants may also be present from material that has been deposited on the road by passage of the vehicles.

**road sweepings** The material swept from roads can have a wide variety of chemicals present, including *polycyclic aromatic hydrocarbons*. In some cases, the toxic chemicals present in the sweepings may define the waste as hazardous.

**rocking grate** See *moving grate incinerator*.

**rodding** Cleaning out blockages in drains or sewers with *drain rods*.

**rodenticide** A *pesticide* to kill rodents—e.g. rats, mice, squirrels.

**roller grate** See *moving grate incinerator*.

**rolldown** A method of water pipe or sewer rehabilitation in which a replacement polyethylene or PVC pipe is inserted into the existing pipe. In this technique the pipe has a slightly larger diameter than the host pipe. The new pipes are butt fused together and then pulled through rollers in order to reduce the diameter prior to insertion in the precleaned host pipe. The technique can be used for pipes between 0.1 and 0.5 m diameter with insertion lengths up to 1 km. See *swagelining*.

**rooftop storage** Stormwater that is retained on flat roofs preventing the water from running off.

**root zone flow constructed wetland** *Reed bed treatment*.

**rosette corrosion** In hot water tanks, copper corrosion that has large platelets of coloured corrosion deposits with large trenches between the deposits.

**rotary drum composter, r. d. digester** A *drum composter*.

**rotary drum pulveriser** See *wet pulveriser*.

**rotary drum screen** A *trommel*.

**rotary drum thickening** Conditioned sludge is passed along rotating cylindrical screens. Thickened sludge discharges from the end of the drum while the separated water drips through the screens. It has been used for thickening waste *activated sludge* up to 3 or 4% solids.

**rotary drum vacuum filter** A *vacuum filter*.

**rotary dryer, r. kiln d.** Wastewater sludge can be dried in a long rotating cylinder using the hot gas which may be generated from a fuel source or from the exit gases from an incinerator. The dryer may be direct operating

at 450 °C or indirect. In a direct dryer, the hot gases used for drying come into contact with the sludge cake, whereas in the indirect method heat is transferred via hot plates or discs. In the latter method the hot gases and the sludge do not come into contact. See *fluidised bed dryer*.

**rotary kiln incinerator** An incinerator that consists of a nearly horizontal steel cylinder lined inside with firebrick (see *Figure R.8*). The material to be burnt slowly moves down the incinerator as the kiln rotates. The kiln is 1.5 to 4 m diameter and 3 to 10 m long, although longer kilns have been used. The temperature of operation can vary from 800 to 1600 °C depending on the requirements for destroying the waste. It is used for incineration of hazardous wastes because it can burn solids, liquids or containerised wastes.

**rotary lobe pump** Two rotors with intermeshing lobes so that the fluid is taken into the pump and then pushed out of the pump. They are able to pump a range of liquids, including sludges, at large capacities at medium head.

**rotary regenerative air heater** A *heat recovery wheel* where the flue gases traverse one half of the wheel, which cools them, passing the heat to the incoming air as it rotates through it. For a 500 MW boiler, two wheels about 10 m diameter and 2 m deep are needed. One difficulty can be the fouling of the gas passages with *fly ash* because the *electrostatic precipitators* that remove it come later. This difficulty can be overcome by the design of the gas passages.

**rotary screen** (1) A *disc screen* or a *drum screen*. (2) A *trommel*.

**rotary screen magnet** A short *trommel* with an electromagnet outside the riding edge. This edge therefore lifts iron and steel pieces and drops them at the point where the electromagnet ceases to be effective—at the top of the trommel. The metal falls from there into a chute inside the trommel that takes it outside. The trommel also functions as a *screen* in the ordinary way, thus yielding three products—an oversize, an undersize and magnetic material. See *magnetic separator*.

**rotary tunnel composter** A *drum composter*.

**rotating arm distributor** A *distributor* rotating over a circular *trickling filter*. The arms (pipes) are pushed round either by the reaction of the water flowing out

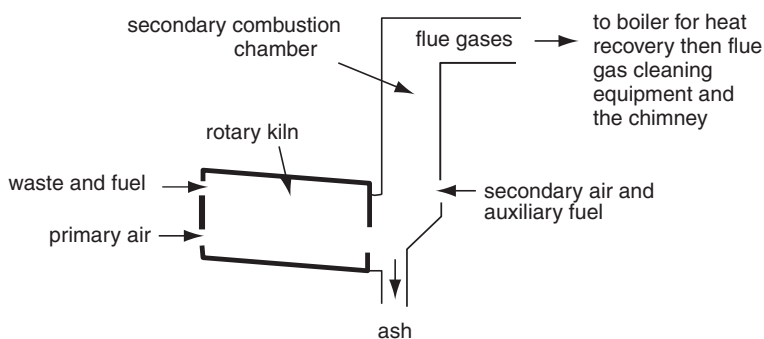

**Figure R.8** Rotary kiln incinerator.

of them or, preferably, by an electric motor. Two or four arms are carried on the central column. Holes in different arms are staggered so as to distribute the wastewater uniformly. The arms and holes must be cleaned regularly.

**rotating biological contactor, RBC, rotating biological disc, rotating disc** An aerobic wastewater treatment in which a horizontal shaft just above the surface of the wastewater carries closely spaced discs up to 3 m diameter or random plastics media in circular wire cages, that revolve with the shaft (see Figure R.9). Some 25 to 45% of the discs or other media are submerged. The slow rotation develops a *biofilm* which oxidises the wastewater. When the slime layer becomes too thick, it sloughs off and is settled in a separate tank or compartment. In some plants, especially those for small communities, the discs are contained in the same tank as the zones for *primary* and *secondary sedimentation* and sludge storage. Some *anaerobic sludge digestion* will occur and the plant is desludged two to four times yearly. Little maintenance is needed. Alternatively, primary and *humus* settlement and sludge treatment may all be in separate tanks. Such plants may treat the wastewater from populations of 500 to 10 000 or so. The surface of the discs are usually corrugated to give a surface area of up to 60 m<sup>2</sup> on one 3 m diameter disc. RBC plants have the advantage of low power consumption and have only one tenth of the land demand of a *trickling filter*. Design is based on g BOD per m<sup>2</sup> of disc area per day. To obtain 90% reduction of BOD in plants with settlement and storage of sludge in one tank, 7 g BOD<sub>5</sub> should be allowed per m<sup>2</sup> per day for populations smaller than 50 and up to 10 g m<sup>-2</sup> day<sup>-1</sup> for populations of 300 or more. Sludge production is about 0.6 kg of dry sludge per kg of BOD<sub>5</sub> applied in the raw wastewater. Activated sludge plants have been upgraded by adding rotating discs to the aeration tank. Higher organic loads per unit volume of tank are possible because bacteria can grow in the mixed liquor as well as on the surfaces of the discs. See *submerged biological contactor*.

**rotating bridge scraper** A mechanical scraper for sludge, used in *radial flow sedimentation tanks*, consisting of a bridge pivoted at the centre of the tank and carried along round the rim wall on a trolley. In the USA *fixed bridge scrapers* are commoner. For *primary sedimentation* a bridge covering half the diameter of the tank is usual (half bridge scraper see Figure R.1). For *secondary sedimentation* one or two full diameter bridges may be used or three half bridges. The greater the number of bridges in a tank, the faster

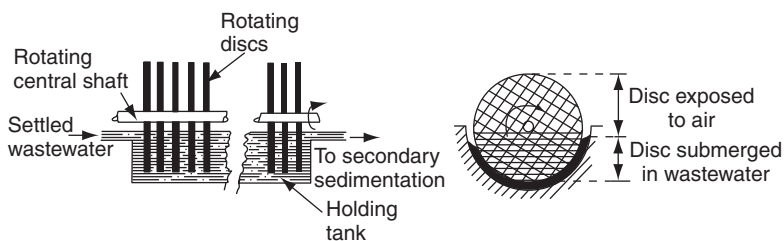

Figure R.9 Rotating biological contactor.

the sludge will be collected. This may be important to stop sludge rising because of *denitrification*. A chain scraper may be used instead of the usual scraper blades.

**rotating drum air separator** A rotating horizontal drum through which air is blown to separate heavy from light refuse—a principle that has been further developed with the use of a conical drum.

**rotating drum incinerator or furnace** A *rotary kiln incinerator*.

**rotavirus** A virus that can cause infantile gastroenteritis. The common route of transmission is *faecal-oral*.

**rotifer, Rotifera, wheel animal** Tiny *aerobic* creatures 50 to 250  $\mu\text{m}$  long, the simplest of the multi-cell invertebrate animals. They have *cilia* around the mouth and can engulf bacteria or other organic matter. Their presence in an effluent indicates highly efficient aerobic biological treatment.

**Rotodisintegrator** A type of *comminutor*.

**rotodynamic** Description of a rotating mechanism that imparts movement—e.g. in pumps to water.

**rotodynamic pump** A pump where a rotor with blades spins at speed to pump the liquid, as opposed to a *positive displacement* pump. Examples include the *axial flow pump*, *centrifugal pump* and *mixed flow pump*.

**Roto-plug sludge concentrator** Dewatering equipment for sludge which is fed into a series of drums lined with nylon filter cloths, turning at about 2.8 rev/min. The sludge dewateres slowly and then passes through a *filter plate press*, concentrating finally to 20 to 30% solids.

**rotor brush aerator** A *brush aerator*.

**rotor dynamic pump** A *rotodynamic pump*.

**rough fish** Fish of poor eating quality or poor game.

**roughing filter** For example, *high rate trickling filters* may be used to remove some of the BOD from a wastewater prior to further biological treatment or discharge to the sewer. *See also pre-filtration*.

**roughing filter** (1) In wastewater treatment, the use of filters to partially treat a wastewater. The common example is a *high rate trickling filter* with BOD loadings on the filter much higher than conventional design. Only partial BOD removal is achieved in a roughing filter. (2) A filter, such as a *slow sand filter*, used to treat an effluent before discharge into a receiving water or onto land. (3) *Pre-filtration*.

**roughing filter—activated sludge process.**

**roughness coefficient** The possible maximum flow in a pipe or sewer is related to the roughness of its surface. As the surface becomes more rough the maximum flow can decrease substantially. Various roughness coefficients are used. *See Hazen-Williams formula, Manning's formula*.

**routing** *See flood routing*.

**Royal Commission effluent** The UK Royal Commission on Sewage Disposal was set up in 1898 and was not disbanded until 1915. A Royal Commission effluent has a BOD<sub>5</sub> below 20 mg/l and suspended solids below 30 mg/l, provided that the receiving water can dilute it at least 8 times. This standard of wastewater effluent was intended to ensure that a clean river with BOD<sub>5</sub> of 2 mg/l would not exceed 4 mg/l when mixed with the

effluent. However, a Royal Commission standard tended to become synonymous with a 20:30 effluent, regardless of the available dilution.

*See Urban Wastewater Treatment Directive.*

**RPM (reinforced plastic mortar) lining** *Glassfibre reinforced cement lining.*

**RTR (reinforced thermosetting resin) lining** *Glassfibre reinforced cement lining.*

**rubber crumb** The product of shredding and grinding of old tyres to produce a fine grained material that can be used for playgrounds or incorporated into manufacturing processes such as carpet backing.

**rubber tyres (USA: tires)** Two million tonnes of scrap tyres are produced in the EU and over two million tonnes of scrap tyres are produced in the USA. Disposal into *landfill* is still common but will be banned in the EU by the *Landfill Directive*. Some tyres are retreaded and some are used to produce *rubber crumb*. Some rubber is reclaimed and used for low grade applications. Tyres have a high calorific value and whole tyres, cut up tyres or rubber crumb can be used as TDI (tyre or tire derived fuel) in an *incinerator*. This method is used in a number of countries for tyre disposal, possibly in a *waste to energy plant*. Open dumping of tyres should be avoided as this can be unsightly and possibly lead to fires. Burning of tyres in the open produces highly polluting and toxic fumes.

**rugosity** Wrinkliness. For a well, the roughness of the inside of the well after it has been drilled.

**runnel** A small water channel, a rivulet.

**runoff** Rainwater, molten snow or other *meteoric water* that runs off the surface. It has several components, including *overland flow* and channel precipitation (falling directly on the stream).

**runoff coefficient, impermeability c.** A fraction that indicates how much of the rain that falls on a surface runs off it. It is the quantity of runoff divided by the rainfall. It can vary from over 0.9 for asphalt surfaces to less than 0.2 for level grass surfaces.

**runoff quality management** *See urban pollution management.*

**rural sanitation in developing countries** Schemes for rural sanitation in developing countries must educate and persuade the community to build, use and maintain sanitation facilities for adults and children. The choice of technology should require little or no maintenance, be low cost and may require little or no use of water. The sources of funding in these communities are limited and sanitation has to compete with other needs for investment. *See aqua privy, bucket latrine, pit latrine, pour flush latrine, vault latrine.*



**SABF** Submerged aerated biological filter. *See biological aerated filter.*

**sacrificial anode** In *cathodic protection*, an *anode* that is eaten away before the metal that it protects. It is electrically connected to this metal, which is lower in the *galvanic series*. The protected metal thus becomes cathodic, and the sacrificed metal anodic.

**SAF, SAFe** Submerged aerated filter. *See biological aerated filter.*

**Safe Drinking Water Act** USA legislation initially passed in 1974 that set the standards for drinking water quality. Numerous revisions and enhancements have been made. *See National Primary Drinking Water Regulations.*

**safety phrases** *See risk and safety phrases.*

**safe yield of a water resource** *See yield of a water resource.*

**sag curve** The *oxygen sag curve*.

**sag pipe** A sewer being placed lower in the ground in order to go underneath an obstruction, e.g. an existing structure or river.

**salimeter** *Salimeter.*

**salination** *Salinisation.*

**saline** Nitrates, chlorides, sulphate and phosphates are the most common salts in domestic wastewater. *See salinity.*

**saline intrusion, s. encroachment, sea water intrusion** Movement of salt water underground from the sea coast inland. Since salt water is denser than fresh, it passes below the fresh water, forming a 'saline wedge'. Excessive pumping of wells in coastal regions may extend the wedge inland to produce saline well water.

**salinisation, salinization, salination** The process of becoming more salty, such as a soil being irrigated with brackish water.

**salinity** The amount of *salts* (not only common salt but all salts) dissolved in a water. The salinity of the Atlantic Ocean varies from 3.3 to 3.7% and of the Dead Sea from 19 to 26%. *See desalination.*

**salinometer, salimeter, salometer** A hydrometer which measures the percentage of salt (as NaCl) in a salty solution.

**Salmonella** Enteric bacteria closely related to *E. coli* and *Shigella*. *Salmonella* may cause enteric fever, *gastroenteritis* or salmonella septicaemia. The diseases are spread by food or drink that has been contaminated by the faeces of an infected person. Flies (which travel from faeces to food) may transmit the bacteria. Many animals, particularly pigs or poultry, may be naturally infected with *Salmonella* and their meat should therefore be well cooked before it is eaten. *See typhoid fever.*

**salmonellosis** Acute *gastroenteritis* with severe diarrhoea, occasionally a *waterborne disease* but usually foodborne, caused by *Salmonella*.

**salometer** *Salimeter*.

**salt** Salts are formed when an acid (*see acidity*) reacts with an alkali. They form *ions* in water. Organic salts are called esters. Table salt is sodium chloride, NaCl. *See saline*.

**saltation** Jumping. In river *hydraulics*, intermittent movement downstream of particles along the bed.

**sample** A small part of a large quantity, one that truly represents the whole.

**sampler** A device that collects a sample for analysis. For accurate, consistent analyses, much depends on satisfactory sampling. Important variables include the position from which the sample is taken and the frequency of sampling. Samples can be single, random, single at specified intervals, flow proportional (for fluid), *composite* or continuous. Considerable errors can be made in sampling. For example, obtaining a sample of water, to determine the concentration of oil in it, is difficult because the oil lies on the surface of the water. Any intermittent sampling is totally unsuitable for a water polluted by batch industrial discharges. *See automatic sampler, cascade impactor, high volume sampler, isokinetic sampler*.

**sampling train, s. assembly** A sequence of equipment for the sampling of flue gases which includes an intake nozzle on a probe, a filter, collectors for polluting gases, a condenser, a gas flow meter, and a pump or aspirator to suck the gas through the train. The flow rate and other gas conditions are designed to be the same as in the flue, and if this is achieved, the two flows are described as isokinetic.

**sand filter** A layer of sand through which water or wastewater is passed and filtered. Typically the sand is contained in open concrete tanks. *Rapid gravity sand filters* have a downward flow through the sand and are common in water treatment. *See also biflow filter, continuous backwash up flow sand filter, moving bed sand filter, pulsed bed sand filter, slow sand filter, upward flow sand filter*.

**sand recirculation filter** A *moving bed sand filter*.

**sand river** A dry river bed beneath which there is water, common in Australian creeks and Arabian wadis, which enjoy running water only occasionally, after heavy rain. Underground dams have occasionally been built in the bed of a sand river to store water.

**sand wash filter** A *moving bed sand filter*.

**sanitary engineering** A term for water and *wastewater engineering*.

**Sanitary Inspectors' Association** The name of the UK *Environmental Health Officers' Association* before 1957.

**sanitary landfill** (*see landfill*).

**sanitary sewer** A *foul sewer*.

**sanitation truck** A refuse collecting vehicle.

**saprobe** An organism that feeds on dead or decaying *organic* matter.

**saprobic classification** A pollution classification for rivers, dividing the *recovery zone* into *oligosaprobic*, *mesosaprobic* and *polysaprobic*, with subdivisions. *See also river classification*.

**saprobicity** The effects of organic matter on life in rivers.

**saprophyte** A *saprobe* that feeds on soluble organic matter. Many bacteria and fungi are saprophytes.

**saprozoic** Descriptive of *saprobies*, which feed on solid organic matter, like most animals.

**SAR** *Sodium absorption ratio*.

**SARA** *Superfund Amendments and Re-authorization Act, 1986*.

**Sarcodina** *Rhizopods*.

**satellite treatment** The arrangement of small wastewater treatment plants around a city to treat mainly domestic wastewater, possibly with the transport of the sludge to a central treatment plant.

**saturated solution** A solution in which the *solvent* has dissolved as much as is possible of the *solute* at the temperature in question. When a saturated solution is cooled, some solute may come out of solution and be deposited, either immediately or later. If the deposition is delayed, the solution is 'super-saturated'.

**saturation flotation** See *dissolved air flotation*.

**saturation index** See *Langelier saturation index*.

**saturator** A pressure chamber in which air can be injected into water at (say) 4 atm pressure—e.g. as a part of *dissolved air flotation*. A saturator can be either unpacked (empty) or packed with stones or plastics medium. Packing helps to break up the bubbles and flow pattern. The retention time is normally from 30 to 60 s.

**SBR** *Sequencing batch reactor* or *suspended biomass reactor*.

**scale, fur** The whitish crust formed inside kettles or hot water systems when the *carbonate hardness* of water is deposited by boiling. It is mainly *calcium carbonate*,  $\text{CaCO}_3$ .

**scales** A term for a *weighbridge*.

**scalping** (1) Removal of large lumps at an early stage of *mineral dressing*. Sometimes in a *mechanical sorting plant* it may mean the early removal by *magnetic separators* of iron and steel pieces larger than about 20 cm. (2) Removing the larger particles of dust in an *expansion chamber* or other inexpensive device before passing the dust laden gas to the units that remove fine dust—*electrostatic precipitators, fabric filters*, high energy scrubbers, etc.

**scavenging** The use of voluminous absorbents such as sawdust, hay, straw or tannery waste (leather shavings) to soak up floating oil spills. The solids then have to be collected for burning on the beach. In the usual sense of the word, scavenging over *landfills* should be prevented where possible, because it is dangerous to the people who do it. See *totting*.

**scentometer** A device that can be used for measuring the intensity of odour. Air that is purified by passing through activated carbon is mixed with air that has not been purified. It measures the ratio of the size of the malodorous air inlet to the purified air inlet at which the odour can still be identified.

**SCF extraction** *Supercritical fluids extraction*.

**schistosome, Schistosoma** The trematodes that cause *schistosomiasis*—namely *Schistosoma mansoni*, *S. japonicum* and *S. haematobium*.

**schistosome dermatitis, swimmer's itch** A skin trouble acquired by humans from the larvae of *schistosomes* that affect rats, birds and mice.

**schistosomiasis, bilharzia** This is one of the most prevalent parasitic infections. It is caused by a *trematode* parasite (blood fluke) of several species, the most common of which are *Schistosoma mansoni*, *S. japonicum* and *S. haematobium*. *S. japonicum* is more common in tropical parts of the Far East, whilst *S. mansoni* and *S. haematobium* are most common in the rest of the tropical regions, including Africa, India and parts of South America. Symptoms are variable and depend on the number and location of the flukes in the body. The chronic effects can be severe. The worm eggs are excreted in the urine or faeces. The eggs hatch into an intermediate stage, the miracidia. This enters the water snail, which produces a further intermediate stage, sporocysts, which in turn produce cercariae. These leave the snail and can penetrate human skin to produce a new cycle. Eggs may be discharged from the human for up to 25 years. The snails require warm slow moving water and the construction of water schemes to meet water supply, power and agricultural requirements has increased the incidence of the disease. Proper sanitation, improved irrigation and the use of molluscicides assists in breaking the cycle of infection. Specific treatment is effective where diagnosis is confirmed. It is estimated that over 200 million people suffer from this disease.

**Schizothrix calcicola** A strain of *cyanobacteria* (blue green algae) that can form *blooms* on nutrient rich water. It has been associated with the production of *endotoxins*.

**schmutzdecke** (German for 'dirt cover') Over a *slow sand filter*, the reddish-brown sticky coating formed on top of the sand, consisting of micro-organisms, partly decomposed organic matter and salts of iron, manganese, aluminium and silica. Below the schmutzdecke for a few millimetres is an autotrophic zone where nitrogen and carbon dioxide are consumed and the oxygen emitted is taken up usefully by the water. For a depth of about 0.3 m, however, there is a further *heterotrophic* zone where the organic matter is broken down by bacteria. It is a type of *biofilm*.

**scoping** An early stage in *environmental impact assessment* (EIA) during which the scope of the EIA is decided. If the scope is too wide then the EIA may be unnecessarily extensive. If the scope is too narrow, important aspects of the EIA may be missed.

**Scottish Environment Protection Agency, SEPA** The body in Scotland that regulates emissions to air, aqueous discharges, solid waste disposal sites and hazardous waste treatment and disposal.

**scouring organisms** *Grazing fauna*.

**scouring sluice, scour pipe** A pipe and valve through the lower part of a dam, by which accumulated sediment can occasionally be expelled to prevent the reservoir being filled by it.

**scour velocity** The horizontal velocity along the base of a clarifier or a sedimentation tank that scours the settled particles back into the water or wastewater. To prevent scour, horizontal velocities should be less than 0.3 m/sec. *See also* below.

**scouring velocity of sewers** The *self cleansing velocity*.

**SCP** *Single cell protein*.

**scrap** Metals or other waste materials.

**scrapers** Equipment provided to scrape the sludge along the bottom of *horizontal flow sedimentation tanks* or *radial flow sedimentation tanks* to the sludge outlet. Hopper bottom tanks of pyramidal or conical shape should not need scrapers, since the sludge gravitates to the central outlet. See *chain scraper*, *fixed bridge scraper*, *flight scraper*, *rotating bridge scraper*, *scum weir*, *travelling bridge scraper*, *vee blade scraper*.

**scrap rubber** See *rubber crumb*, *rubber tyres*.

**screen** (1) A sieve made of a flat sheet of wire mesh or punched steel plate for separating granular material into sizes (*classification*). It can also be made of parallel, wedge shaped wires or bars or round wire either flat or formed into a cylinder, as in the *trommel*. In a *mechanical sorting plant* trommels are an inexpensive first step and may also be used intermediately. (2) In the treatment of water or wastewater, a device that removes larger solids out of the flow. At reservoir intakes, screens are usually racks of massive bars. The bars may be vertical, horizontal or at a slope. They may be cleaned mechanically or by hand. At wastewater treatment works, and sometimes water treatment works, screens are part of *preliminary treatment*. *Coarse screens*, *medium screens* or *fine screens* may be used. They are usually designed for a velocity through the bars or mesh of 1.2 to 1.5 m/s at maximum flow. The most common are *bar screens*. An example is given in *Figure S.1* but other types include *belt screen*, *cup screen*, *disc screen*, *drum screen*, *mesh screen*, *vibrating screen*. (3) An embankment or a wire mesh fence, up to 3 m high, built around a *landfill* especially on its lee side to catch wind blown refuse.

**screening** The use of a *screen*.

**screenings** Coarse solids removed by *screens*. In wastewater treatment works the screenings quickly putrefy, especially in hot weather. They are macerated or disposed of by tipping or *incineration*. The volume of screenings is very variable but should not exceed 5 cm<sup>3</sup> per person per day for screens with 5 cm spacing and 25 cm<sup>3</sup> per person per day for 1.5 cm spacing. Screenings are only 20 to 30% solids.

**screenings disintegrator** See *disintegrator* (2).

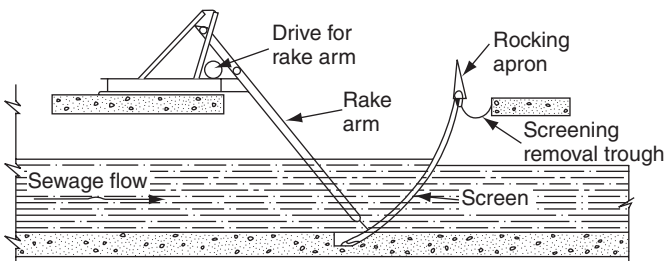

**Figure S.1** Screen showing mechanical raking arm.

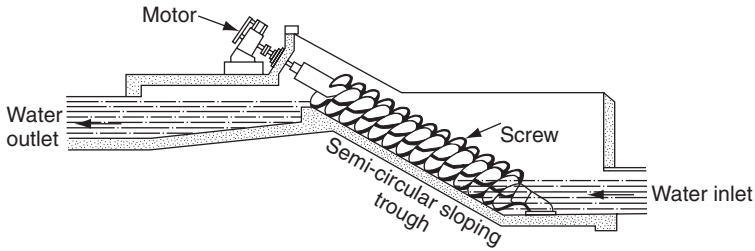

Figure S.2 Screw pump (longitudinal section).

**screw classifier** A *mineral dressing* device resembling a *screw pump*, with a sloping trough in which an *Archimedean screw* rotates, separating the light (or fine) material in the overflow from the dense (or coarse) material in the *underflow*.

**screw pump** An *Archimedean screw* in a semi-circular or circular trough set at an angle of 30 to 40° to the horizontal (see *Figure S.2*). Screw pumps are efficient over a wide range of flows, and are ideal for pumping wastewater and similar substances. The greatest lift for one screw pump is about 10 m.

**scrubber** The removal of unwanted particulates or gaseous pollutants from an effluent gas. See *bioscrubber*, *dry scrubber*, *semi-dry scrubber*, *wet scrubber*.

**scum, skimmings** Any material that floats to the top of still water, especially in *sedimentation tanks*. Wastewater scum contains plastics, polythene and terylene film, fats, oils, greases, soaps as well as *rising sludge*. Scum should be removed regularly because it smells and may attract birds. It can block pipes and the distributors of *trickling filters*. Scum is usually disposed of with sludge. Scrapers may be designed to drag it over a scum weir. The insoluble precipitates formed by soap in hard water are also scum—calcium and magnesium salts of the soap substance.

**scum board, s. baffle, inverted weir** A board that prevents scum floating out with the stream of effluent. Those provided at the outlet from *sedimentation tanks* in wastewater treatment are about 0.45 m high, projecting 75 to 150 mm above the surface and dipping about 0.3 m below it across the full width of the channel.

**scum trough** A trough in or beside a *sedimentation tank*, down which the scum flows away. For *horizontal flow sedimentation tanks* the scum trough should be at the inlet end.

**scum weir, skimming w.** A *weir* with an adjustable crest that can be lowered to remove scum. Often a scraper pushes the scum over the scum weir to the *scum trough*.

**SDWA** *Safe Drinking Water Act*.

**SEA Directive** *Strategic Environmental Assessment Directive*.

**sea dumping** See *MARPOL*, *North Sea conferences*, *Oslo convention*.

**sea outfall** Pipes on the seabed or tunnels in rock that are used to discharge wastewater or treated effluents into the sea. Tunnels have the advantage

that ships dragging their anchors cannot break them, which may happen to pipes. Tunnels may be more expensive or impracticable. *See diffuser* (2).  
**sea water intrusion** *See saline intrusion.*

**secator conveyor separator** An *inertial separator* consisting of a rapidly rotating wheel that throws dense objects a long way while objects such as paper fall short.

**secondary air** (1) or **overfire air** The air supplied to a combustion chamber of an incinerator that is fed in from above the grates and material that is being burnt, unlike the *primary air*. The secondary air ensures excess air for combustion and provides turbulence, thereby ensuring that the volatiles emitted from the waste are burnt. (2) The air supplied to the *secondary combustion chamber* in a two stage incinerator. *See starved air incineration.*

**secondary air pollution** *Secondary emission.*

**secondary barrier** In a landfill site, the second liner in an *multi-liner* system.

**secondary clarifier** *Secondary sedimentation tank.*

**secondary combustion chamber** Volatilised organics from the *primary combustion chamber* of a two stage incinerator are heated to a temperature where they are completely oxidised, typically at 1000 to 1200 °C.

**secondary digestion** *High rate anaerobic sludge digestion* usually operates as a two stage process with the primary digestion tank being heated and mixed, while the secondary digester allows the digestion process to finish and the digested sludge to settle and thicken. The secondary digester may have a retention time of about 15 days.

**secondary effluent** Effluent from *secondary sedimentation tanks.*

**secondary emission, secondary air pollution** Pollutants, such as *photochemical smog*, which originate from reactions in air polluted by *primary emissions*

**secondary main** A pipe that distributes water from a *trunk main* to street *service mains* but may also provide water direct to an industrial consumer.

**secondary particulates** Particles formed in the atmosphere from gaseous pollutants.

**secondary pollutant** A pollutant that is formed by chemical reactions that rise out of the presence of primary pollutants, e.g. *ozone* is formed in the atmosphere by various chemical reactions of primary pollutants.

**secondary sedimentation tank, s. settling tank, s. clarifier** Sedimentation tanks used after biological treatment of a wastewater to settle out the *biomass* that has formed in the biological reactor from the treated effluent. These tanks are also known as biomass separators, *activated sludge settling tanks* or *humus tanks* (when used after *trickling filters*). *Radial flow* tanks are common but *horizontal flow* tanks are also used. Tanks are typically 2.5 to 4 m deep and the *surface loading rate* is from 20 to 45 m<sup>3</sup> per day per m<sup>2</sup> of tank surface area. In small treatment works, *pyramidal sedimentation tanks*, or *pebble bed clarifiers* may be preferred. *See secondary sludge, solids surface loading rate.*

**secondary shredding or pulverising** The second stage of *shredding* or pulverising refuse to about 3 cm in size and preceded by *primary shredding* (or pulverising). *Magnetic separators* that are used to sort out iron and steel

from refuse, may be situated between the primary and secondary shredder. Secondary shredding may be followed by a further stage of shredding, as in multi-stage shredding.

**secondary sludge** *Sludge* from *secondary sedimentation tanks* (return activated sludge or *humus sludge*). In temperate climates secondary sludge is often returned to the *primary sedimentation* tanks and is there thickened to give a *mixed sludge*. In hot climates this may be unsuitable because the secondary sludge becomes *anaerobic* very quickly and *rising sludge* is seen in the primary tanks. *Flotation* may be better than sedimentation for secondary sludges in warm climates. *See sludge production.*

**secondary treatment** In wastewater treatment, the treatment process that follows *primary treatment*. It is used to remove the remaining organic solids that have not been removed in primary treatment together with the 90% or more of the dissolved organics. *Aerobic biological treatment* is commonly used. Secondary treatment may also incorporate *nitrification* and *biological phosphorus removal*.

**second stage biochemical oxygen demand** *Nitrogenous BOD.*

**sediment, silt** Particles eroded from the river bed or nearby land, which are carried suspended by the stream and dropped when the flow is low or in a reservoir or estuary. *See sediment load.*

**sedimentation** Settlement, sinking. In water and wastewater treatment it means the removal of *settleable solids* in a *clarifier, grit chamber, sedimentation tank, gravity sludge thickener*, etc. Chemicals may be used to help sedimentation. *See coagulation, settling regimes.*

**sedimentation tank, settling t.** An important treatment process in which the tank is used to settle out solid material from the water or wastewater. In water treatment, sedimentation tanks are used after *coagulation* and *floc-culation* and are normally known as *clarifiers*. *Primary sedimentation* is common in the treatment of domestic wastewater after *screening* and *grit removal*. Sedimentation tanks are used after biological treatment of a wastewater to settle out the *biomass* that has formed in the biological reactor from the treated effluent. These tanks have various names, including *activated sludge settling tanks, biomass separators, humus tanks* or *secondary sedimentation tanks*. Sedimentation tanks may be *horizontal flow* (Figure H.3), *radial flow* (Figure R.1) or *upward flow* (Figure U.3). They are often designed on *surface loading rate*. The performance of the tanks may be upgraded by the use of *inclined plate and tube settlers* (Figure I.3). In wastewater treatment, a clarifier is synonymous with *sedimentation tank*. In sludge treatment, *gravity thickening* tanks are a type of sedimentation tank.

**sediment load, s. yield** All rivers or streams carry material downstream as suspended *sediment* or *bed load*, or by both methods. The total of the two is called sediment load. Reservoirs are provided with *scouring sluices* to enable their sediment to be washed out periodically.

**Secchi depth** The depth at which a *Secchi disc* is no longer visible in the water. It may be 30 m or more in a clean lake but as little as 0.5 m in a turbid *eutrophic* lake.



**Seechi disc** A 200 mm black and white disc that is lowered into water until it is no longer visible. It is used as a measure of the turbidity of a natural water body such as a lake.

**seeding, inoculation** Bringing in suitable bacteria and other organisms to help biochemical reactions. The return of *activated sludge* is one example. To start a new activated sludge plant, the *aeration tank* may be seeded with activated sludge from another plant. *Digested sludge* can be added to undigested sludge to seed it before digestion. Samples in the BOD test also need to be seeded with appropriate bacteria.

**seepage** Leakage of water into or out of or through a soil or other granular material.

**seepage bed** A *soakaway*.

**seepage pit** An *absorption pit*.

**seiche** (French for 'tidal wave') In a lake, a tide caused by wind raising the water level at the lee end and correspondingly lowering it at the windward end. When the wind drops, the water flows slowly back to the windward end and returns with diminishing amplitude. It helps to mix the water.

**segmental lining** The use of prefabricated segments that are placed in a defective water pipe or sewer to form a new lining. The segments are usually sealed at the joints and grouted.

**selective medium** A *medium* which favours the growth of a particular group or species of micro-organisms to the exclusion of others—e.g. *MacConkey's broth* for growing and identifying bacteria of the *coliform group*.

**selenium, Se** A micronutrient that is highly toxic at high concentrations affecting the central nervous system. Selenium may be present in some natural waters. Selenium may be present in municipal refuse because of its use in some types of paper. See *Table D.2 Drinking water standards*.

**self cleansing** Description of the power of the environment to remove pollution. For example, in the atmosphere large particles drop to earth, entering the topsoil, and smaller ones are caught in leaves or buildings or by rain or are removed by wind. See also *self purification*.

**self cleansing gradient** For each pipe diameter a range of slopes at which wastewater carries all solids with it. This should occur daily during the peak flow. See below.

**self cleansing velocity, scouring v.** The speed of water flowing down a sewer which sweeps all solids away. At lower speeds some solids are stranded and the sewer may become *septic*. Organic matter is kept suspended at speeds of about 0.6 m/s, but sand and grit need a minimum speed of 0.75 m/s. See above.

**self digestion** *Autolysis*.

**self purification, natural purification** The ability of natural water to purify itself of pollution. It is possible because bacteria and other micro-organisms in the water feed on the organic material and reduce its concentrations while using up the dissolved oxygen. If the self purification capacity is exceeded (i.e. the water is overloaded with organic pollution) the dissolved oxygen decreases substantially. Eventually all the oxygen

- may disappear from the water. As the river recovers, fish are among the last creatures to reappear. *See oxygen balance.*
- semi-dry scrubber** A method for cleaning gases in which a slurry is sprayed into the gases in order to collect the unwanted gaseous pollutants. For example, calcium hydroxide slurry may be sprayed into the gas when cooled below 160 °C in order to collect SO<sub>2</sub> or HCl from the gas as calcium sulphate and calcium chloride. The slurry dries to a powder in the gas stream and is then removed in a fabric filter.
- semi-permeable membrane** A skin or sheet (membrane) that allows *solvent* to pass through it but not *solute* (dissolved salts etc.). It often occurs in nature, and is used in *reverse osmosis*, dialysis, etc. *Electrodialysis* makes use of *ion exchange membranes*. *See membrane processes.*
- senescent lake** A lake that has nearly filled in with sediments and rooted water plants. It is the last stage before the area becomes a marsh.
- sensitive areas** The *Urban Wastewater Treatment Directive, 1991* contains various definitions of this term. The definitions include natural waters which are *eutrophic* or may become eutrophic if protective action is not taken. They also include surface freshwaters intended for the abstraction of drinking water which could contain excessive nitrate.
- sentinel well** A *monitoring well* that is positioned so that the samples from the well give warning of movement in the groundwater of a specific pollutant from its designated location (e.g. a *landfill* site) towards a sensitive area (e.g. a groundwater abstraction borehole).
- SEPA** *Scottish Environment Protection Agency.*
- separate sewer system, rigidly separate system** Two separate sewer systems, one taking the *stormwater*, the other taking the domestic wastewater and industrial effluents. The stormwater discharges direct to the receiving water and should not cause pollution (*compare combined sewer system*). In general, separate systems are likely to be more expensive because of the two pipes but it overcomes the problem of water pollution that can occur from *combined sewer overflows*. *See also partially separate systems, sustainable urban drainage.*
- separate stage nitrification** In the biological treatment of wastewaters, a process used for *nitrification* after a separate treatment process has been used for BOD removal. An example is a *nitrification filter*. *Compare single stage nitrification.*
- separation at source** The recycling of household waste is greatly assisted if the householder separates the domestic waste into differing bags or bins. Glass, plastics, paper, metals and putrescible material may be sorted prior to collection. The differing wastes can then be collected separately and processed individually to give more economic *waste recycling*.
- separation/incineration, s. and i.** Salvage of iron and steel and some other materials before *incineration*. The method was common when batch incinerators were in use.
- separation weir** A *combined sewer overflow*.
- Sepedonium** A *fungus* that grows on *trickling filters* and has a lower optimum temperature than most other active micro-organisms in the *biofilm*. It may reach a thickness of 2 cm in winter and thus contribute to *ponding*.

**septage, black water** The wastewater from toilets or the contents pumped out from a *septic tank* or *vault latrine*. Septage has a much higher BOD than mixed domestic wastewater because it has a greater concentration of organic material. It may be mixed with the *sullage* and flow in sewers to a nearby wastewater works for treatment. Septage may be disposed separately from sullage, in which case the septage may be transported by tanker to a wastewater treatment works or it may be disposed onto land using *land treatment*.

**septicisation** *Deoxygenation* of wastewater because of oxygen uptake by *aerobic, heterotrophic* micro-organisms that transform the organic substances and remove the oxygen.

**septic sewage** Wastewater in which micro-organisms have used all the dissolved oxygen. The organics in the wastewater are then biodegraded anaerobically and foul smells are produced. Warm weather and long travel in sewers increase the likelihood of wastewater becoming septic. *See sulphide corrosion.*

**septic tank** A covered, horizontal flow tank (*Figure S.3*) that involves a series of treatments and is used for isolated dwellings which are uneconomic to connect to a wastewater treatment system. The minimum volume of a septic tank in litres is  $180N + 2000$ ,  $N$  being the population served. Where *garbage grinders* are used, the factor 180 should become 250, and for schools or other intermittent uses it should be 90. A rectangular septic tank is normally at least 1 m wide, with a length : width ratio of 3 : 1 to 2 : 1 and a minimum depth of 1.5 m. The tank is often divided into two sections, the first being twice as long as the second. Circular pre-formed *GRP* tanks are available. The solids settle to the floor and undergo anaerobic digestion. Some of the gas evolved lifts the sludge and forms a thick scum which traps other floating solids grease and fats. The inlet and outlet weirs should be below the scum level. The effluent from a septic tank is very variable, with a  $BOD_5$  of 100 to 300 mg/l and suspended solids from 70 to 150 mg/l. In general, the effluent has about 50% less BOD and 70%

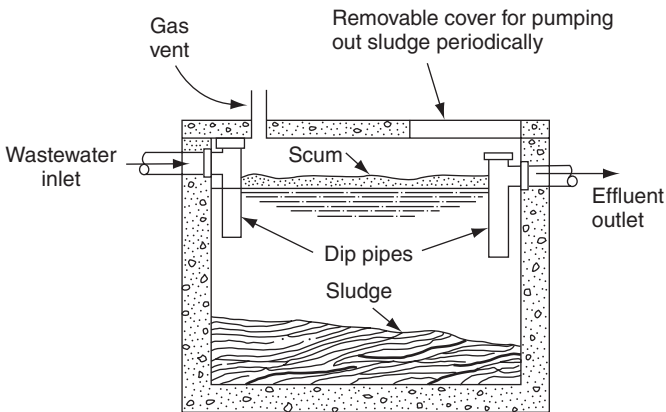

**Figure S.3** Septic tank, single compartment type.

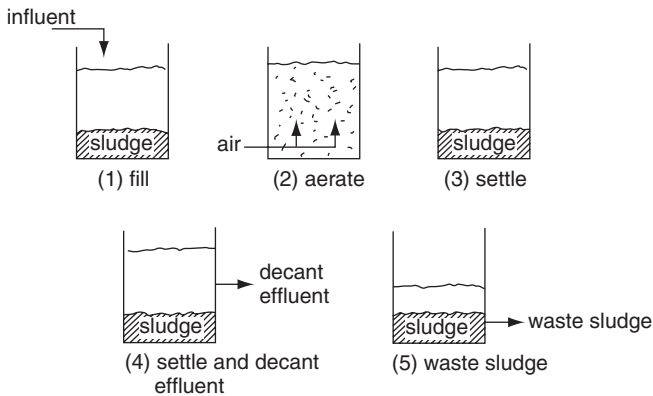

**Figure S.4** Sequencing batch reactor, other cycles can be added to obtain denitrification or biological phosphorus removal.

less suspended solids than the wastewater influent. The poor BOD reductions are partly caused by *hydrolysis* of the sludge particles. Further treatment by *soakaway* or *trickling filter* may be needed. Septic tanks should be desludged once every two years and about one sixth of the sludge should be left to *seed* the new sludge. The sludge usually contains 10% or more solids.

**sequencing batch reactor, SBR** A wastewater treatment that consists of a sequence of different cycles in a reactor, but flow neither enters nor leaves the reactor until the treatment is completed, i.e. it operates on a fill and draw. An example of biological treatment in a SBR for the removal of BOD and nitrification from a wastewater is given in *Figure S.4*. Other cycles can be added, for example, after filling, the next sequences can be mixed anaerobic conditions, followed by anoxic conditions, followed by aerobic conditions in order to obtain *biological phosphorus removal*. The next sequence would be sedimentation allowing discharge of the effluent. The final sequence would be the inflow of more wastewater that requires treatment.

**sequestering** See *complexing*.

**service main** The water (or gas) *main*, buried in the street, from which domestic consumers draw their water or gas.

**service pipe** The pipe that connects the water (or gas) main to the building. See *communication pipe, supply pipe*.

**service reservoir, distribution r., clearwater r.** A reservoir that is supplied, often by a gravity *trunk main*, from the water treatment plant. It supplies water to the consumers in one *pressure zone*. Unlike an *impounding reservoir*, it stores treated water and is therefore roofed to prevent pollution by birds or airborne material. A water tower is a service reservoir or tank raised above ground level. Service reservoirs usually contain 1 to 3 days' storage for the zone they serve. This allows for interruptions to the supply from the water treatment plant in the event of a burst trunk main, etc.

**service stations** See *VOC*.

**sessile** Fixed or stationary. A *biofilm* is a sessile micro-organism growth on a solid media or stones.

**seston** The smallest *plankton*, living or dead. It adds *turbidity* to water.

**set out set back collection** A system for collecting refuse from domestic households in which part of the crew carries the bin or bag to the kerbside from the storage area. The waste is then collected from the kerbside and the third part of the crew replaces the bin back in the storage area by the house.

**settleability** Ease of settling. An indication of the ability of a *secondary sludge* to settle in a *sedimentation tank* can be obtained by a *settling column* analysis or the *sludge density index*.

**settleable solids** The solids in wastewater which are large or dense enough to settle in the time that is allowed for the wastewater to pass through the *sedimentation tank*. The colloids or lighter particles remain in the effluent and do not settle. Settleable solids are measured in an *Imhoff cone*. Compare *suspended solids*.

**settled wastewater, s. sewage** The effluent from *primary sedimentation tanks*.

**settlement** See *sedimentation*, and below.

**settlement of landfill** All *landfills* compress and settle under the weight of the material over them. If the landfill has domestic refuse or other biodegradable waste, some of the settlement is due to biodegradation of the solid material to methane and CO<sub>2</sub>. In order to maximise the tipping space in a landfill site, a *steel wheeled compactor* is commonly used on site. The density of loose tipped refuse is about 0.2 tonne/m<sup>3</sup> but with a steel wheeled compactor the density can be increased to 1 tonne/m<sup>3</sup>. The settlement of domestic refuse landfill is about 10 to 30%. However the settlement is uneven and not fully completed until the fill is stabilised (i.e. finished biodegrading).

**settlement plate** A square of asbestos cement or a glass microscope slide that is fixed on a jetty pile, buoy or other fixture, with others over a wide area below or partly below water level. They are regularly harvested and replaced. Growths on the plates are recorded and indicate the quality of the water and its life.

**settling chamber** See *gravity settling chamber*.

**settling column** A unit of laboratory equipment for measuring settlement rates in a suspension, usually a vertical tube with tapping points at intervals. To avoid interference between the particles and the tube wall, the tube diameter should be at least 100 times the diameter of the largest particle.

**settling flux** *Solids flux*.

**settling module** See *inclined plate and tube settlers*.

**settling pond, s. lagoon** A pond or lagoon where dirty water or sludge is allowed to settle and clarify before discharge to the river.

**settling regimes** Particles in a liquid settle in four main ways, important in both water and wastewater treatment:

Type 1 The discrete settling of granular particles that do not flocculate and are not hindered by interaction with other particles. They have

a constant settling velocity, calculated from *Stokes' law*, but only if they are spherical.

Type 2 The settling of *flocculent* particles, in low concentrations. The *flocs* grow and therefore their settling velocity may increase but the forces on the settling floc may break it up. Hence, the floc is continually re-forming.

Type 3 Hindered settling or zone settling. Individual flocs are close, interfere with one another, and the mass of particles settles as a block.

Type 4 Compression settling. At high concentrations of solids the particles are in contact with one another and settlement is by compaction of the particles because of the weight of those above them. Any downward movement of floc corresponds to an upward movement of water, which slows down settlement.

The *sludge blanket* in *sedimentation tanks* or *clarifiers* consists of zone settling and compression settling areas.

**settling tank** A *sedimentation tank* or *clarifier*.

**sewage Wastewater.**

**sewage effluent disinfection Wastewater disinfection.**

**sewage farm** Land on which wastewater or effluent is poured, and where crops are grown, using *land treatment*.

**sewage fungus** A greyish, slimy mass of *filamentous organisms* which may be seen growing on rocks or the banks of polluted water. The name is misleading, because sewage fungus often includes bacteria such as *Sphaerotilus natans* and *protozoa* such as *Carchesium*, as well as true fungi such as *Leptomitus* or *Geotrichum*. It may consist of only one or two species of bacteria or fungi.

**sewage sick** A description of land that has had too much wastewater or sludge over it. Its fertility drops and it may also be smelly.

**sewage sludge** See *sludge*.

**sewage treatment Wastewater treatment.**

**sewer** A *culvert* or buried pipe that leads away domestic and industrial wastewaters for treatment and disposal. Sewers may be in *combined systems* or *separate systems* or *partially separate systems*. Sewers in cities were originally only culverts to allow traffic to pass over streams, whether in ancient Rome, Paris, London or elsewhere. In London wastewater was excluded from them until 1815. Early sewers were of brick or stone, since pipes for sewerage did not exist, and became *combined sewers* as soon as house drains were allowed to be connected to them. Apart from ancient Rome at the time of Christ, waterborne sewage systems existed in India around 4500 B.C. and near Baghdad about 2500 B.C. Modern sewers are usually circular, although very large rectangular sewers have been built. Pipes are normally of concrete or *PVC-U* but may also be of brick, asbestos cement, cast iron or vitrified clay. They are laid at a slope which will achieve a *self cleansing velocity* at least once in 24 h. To avoid excessive wear of the pipe material, the velocity of flow should not exceed 2.5 m/s. *Foul sewers* should accommodate 4 to 6 times the *dwf* when flowing full, without *surcharging*. Combined sewers should take a once

in 3 years storm without surcharging. See *building sewer, collector sewer, egg shaped sewer, interceptor sewer, stormwater sewer, trunk sewer*.

**sewerage** A network of *sewers* or the science of sewers.

**sewer assessment** Investigations into *sewer rehabilitation* include assessment of the structural condition, hydraulic performance and environmental impact of the sewer system. The deficiencies and causes of deficiencies are identified so that a rehabilitation plan (known as a drainage area plan) can be developed and implemented in order to achieve efficient operation and maintenance of the sewer network.

**sewer chimney** A *back drop*.

**sewer cleaning** Cleaning of sewers may use a large flow of water (flushing) or high pressure water (jetting). Mechanical cleaning methods are common, such as *pigging* or *rodding*. Prior to sewer rehabilitation, *rack feed boring* or *drag scraping* may be used.

**sewer deterioration** This usually starts with the formation of initial defect during sewer construction or placement (e.g. bad bedding, leaking joints). The defect causes water to flow out of or into the sewer. The joint material may be eroded and the soil may be lost from around the sewer reducing support. Finally the weakened structure collapses. See also below.

**sewer corrosion** See *sulphide corrosion*.

**sewer gas** Any gas in a sewer, including petrol vapour, carbon monoxide, carbon dioxide, *hydrogen sulphide, methane* or combinations of them.

**sewer network modelling** Computer programmes for the analysis, simulation and design of sewerage systems have been available since the 1970s. Complex models are now readily available. The input to these models includes data on the pipe system, catchment area, inflows and ancillary structures (manholes, *combined sewer overflows* etc.). Most of the modelling packages include quality aspects (e.g. pollutants loads discharged to a watercourse), but the physical processes in sewers are complex and may be difficult to simulate.

**sewer overflow** See *combined sewer overflow*.

**sewer rehabilitation** The techniques for *in situ* sewer rehabilitation often include putting a lining inside the old sewer. Processes include *ferrocement lining, glass reinforced cement lining, gunite lining, pumped lining, sliplining*. Other alternatives include *close fit lining* and *epoxy lining*. Complete replacement of the old pipe by a new plastic pipe can be achieved by *pipe bursting* or *rolldown* or *soft lining* or *swagelining*. The loss of diameter in the sewer that can occur due to rehabilitation is usually more than compensated by the improved hydraulic characteristics of the rehabilitated pipe. See also **sewer cleaning**.

**sewer separation** Laying extra sewers in order to convert a *combined sewer system* into a *separate sewer system*.

**sewer ventilation** Ventilation of sewers is essential to stop sewer gas building up and to prevent air locks in them. In temperate climates the wastewater is usually warmer than the outside air. In hot climates the wastewater is cooler than its surroundings and forced ventilation of sewers is often needed. *Odour control* may be needed at the ventilation shafts.

**SF constructed wetland** Subsurface flow *constructed wetland*.

- shaduf, shadoof** A simple method for raising water out of a shallow water well. It comprises of a bucket connected by a pole to a long counter balanced lever. An individual pulls down on the lever and raises a bucket full of water.
- shaft reactor** *See deep shaft system.*
- shake deflate baghouse** A *baghouse* that is cleaned by stopping the air flow, allowing the bags to deflate and then shaking the bags to remove the dust accumulation.
- shale heap** *See spoil heap.*
- shallow bed filter** A *rapid gravity filter* with the filter bed of about 0.3 m as in the *pulsed bed sand filter*.
- shallow depth sedimentation** The use of *inclined plate and tube settler*, instead of conventional deep *sedimentation tanks*.
- shallow well** A well that is less than 10 m deep is usually considered to be shallow. The water can be pumped out by locating a pump on the surface. *Compare deep well.*
- shears** *See alligator shears.*
- shellfish** Oysters, mussels or other shellfish from polluted water can harbour *pathogenic* organisms that may cause, if they are eaten, *typhoid fever*, diarrhoea, *gastroenteritis* and other waterborne diseases. After harvesting from polluted waters, shellfish may be purified of bacterial hazards by leaving them first in chlorinated water and then in tanks of clean water. However, it is still possible for them to contain toxic chemicals in proportions much higher than the surrounding water. Some shellfish act as an intermediate host to parasites that harm humans—for example, *flukes*.
- Shellfish Directive 1979** The EU Directive that set physical, chemical and microbiological water quality parameters for areas in EU coastal water from which shellfish can be taken for human consumption.
- shigellosis, bacillary dysentery** An acute bacterial intestinal disease, generally producing fever and diarrhoea. It occurs world-wide with most patients being children. The main species responsible are *Shitella dysenteriae*, *S. sonnei*, *S. flexneri* and *S. boydii*. Transmission may involve ingestion of food or water that has been contaminated by excreta from an infected person.
- Shipment of Radioactive Waste Directive 1992** The EU Directive that controls the movement of radioactive waste, within, into or out of the EU.
- shock load** A sudden increase in the quantity of pollutant that arrives at a treatment process.
- short chain fatty acids** *Volatile fatty acids.*
- short circuiting** Some of the flow in a treatment process may stay in the process for less time than the expected period, e.g. due to *density currents*. It also infers that some of the flow is spending too much time in the process. This poor distribution of flow can reduce the effectiveness of the treatment process.
- short term exposure limits, STEL** An *occupational exposure limit* over a short time period, such as 10 minutes.
- shredder, shredding machine** Shredders are dry machines that have metal cutting blades, typically on a horizontal rotating shaft or two intermeshing horizontal shafts. The shaft(s) operate at slow speeds, rotating at



about 1 rpm. They can be designed to shred refuse, metal, plastics, tyres, paper, entire car bodies, etc. They are quieter than dry *pulverisers* such as *hammer mills*. In wastewater treatment, a shredder may mean a *comminutor*. See below.

**shredding** In waste management, the reduction in size of refuse or other waste by cutting probably together with some crushing, grinding, shearing, etc. The term is often used synonymously with *pulverising*. Shredding is undertaken in a *shredder*. For municipal refuse, dry shredding or pulverising can be important processes prior for efficient *composting* of refuse or to produce *refuse derived fuel*. *Two stage shredding* (or pulverising) is often used with primary shredding to about 15 cm in size and secondary shredding of refuse to about 3 cm in size. *Magnetic separators*, that are used to sort out iron and steel from the refuse, operate more efficiently on shredded refuse. The separator may be situated between the primary and secondary shredder. Shredding (or pulverising) may be included to improve the burn of the refuse in an *incinerator*.

**shrimps** See *freshwater shrimps*.

**SIBR** *Suspended immobilised biomass reactors*.

**sick activated sludge** An *activated sludge*, that does not react as it should, appears dark brown or black and may be difficult to settle. It may become sick because of toxic chemicals in the wastewater or too little air going into the *aeration tanks*. A sick activated sludge may suffer from *bulking*.

**sick building syndrome** The common symptoms may include some of the following: eye, nose or throat infection, sore eyes or throat, dry mucous membranes and skin, mental fatigue, lethargy, headaches, coughs, itching, nausea, dizziness, erythema (skin rash). Sick building syndrome can produce noticeable reductions in staff productivity. The significant physical factors can be wide ranging and difficult to pinpoint. Some of the important aspects are *thermal comfort*, *ventilation rates*, appropriate lighting, bacteria and fungal spores in air, *VOCs* and gaseous pollutants. Sick buildings are easier to avoid at the design stage than taking remedial action when building is completed and in use. The willingness and capacity of management to act on complaints is important in combating sick building syndrome. Appropriate maintenance and cleaning schedules should be adhered to in the building

**side stream phosphorus removal** The removal of phosphates from a wastewater by treating a portion of the return *activated sludge* as in the *PhoStrip process*.

**side weir overflow** A common *combined sewer overflow* with a weir parallel to the sewer or open channel. Double sided weir overflow may be used (see *Figure S.5*). As the flow increases, the depth of flow increases until the excess flow (e.g. the wastewater flow that is in excess of the treatment works capacity) flows over the weir for discharge elsewhere. When located in a sewer and the weir crest is below the horizontal diameter of the sewer, it is known as a low side weir overflow. When the weir crest is above the horizontal diameter, it is known as a high side weir overflow. The structure may be covered with manhole access or, in a wastewater treatment works, it is open.

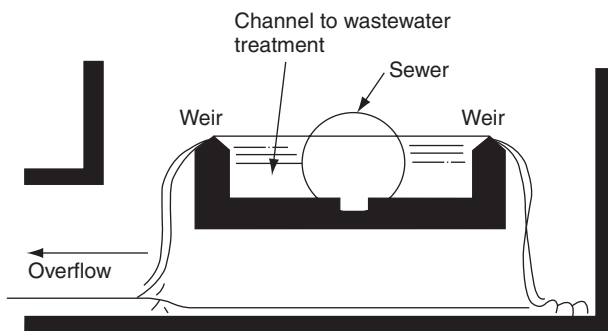

Figure S.5 High double side weir overflow (in vertical section).

**siemens, mho** Two names for the unit of *electrical conductance*.

**sieves** See *mesh, screen*.

**sievert, Sv** The SI unit for radiation dose equivalent, which is the radiation dose multiplied by appropriate factors to take account that some forms of radiation have a greater effect on cells, tissues etc.  $1 \text{ Sv} = 1 \text{ Gray} \times$  appropriate factors.

**sigmoid growth curve** The *microbial growth curve*.

**signature method** Methods of separation of minerals or refuse which involve the use of a computers to recognise the signature of the material in question. *Impact deceleration* and *infrared spectroscopy* are two methods.

**silage liquor** Cut grass is kept in anaerobic conditions to produce silage that is then used as animal feed. The waste liquor from silage production is highly polluting and its accidental discharge can be a major source of river pollution in agricultural areas. The waste liquor can have a BOD of 50 000 mg/l and a total nitrogen concentration of 20 000 mg/l. The liquor must be collected and then it is usually mixed with slurry and applied to the land.

**silica** Silica is found in most hard waters up to about 40 mg/l at about 1 mg/l in moorland water, and in river waters intermediately. In boiler *feed water* it is undesirable because it can form a very hard scale.

**silicon carbide** A *refractory* that provides good protection to a combustion chamber wall at grate level in an *incinerator*. It can also be used to protect a *water wall* that is liable to be excessively corroded.

**silt, silting, siltation** The fine material deposited from the *sediment load* of a stream.

**silver** Silver impregnated filters have been used for small scale water disinfection. Excessive intake of silver in humans gives the disease argyrosis, an infirmity which disfigures the complexion. See *Table D.2 Drinking water standards, filter candle*.

**Silvex**, See *2,4,5-TP*.

**Simater sand filter** A *horizontal flow sand filter*.

**simazine** A herbicide of the *triazine* group with a similar chemical formula to atrazine. It is widely used, particularly on land not used for agriculture.

It is long lasting and can migrate into the water system. The USEPA *MCL* in drinking water is 4 µg/l. The WHO guideline maximum value is 2 µg/l in drinking water. The EU Drinking Water Directive states a mandatory maximum of 0.1 µg/l. The EU lists it as a *priority substance* in relation to aquatic discharges.

**Simuliidae** Blackfly such as *Simulium*.

**Simulium** A genus of blackfly or buffalo gnat that both transmits *Onchocerca volvulus* to humans and receives it from them when it bites and drinks human blood. The *Simulium* larva lives on rocks in torrential water in warm climates. When a river is dammed, many of the rapids are drowned, thus reducing the breeding grounds of *Simulium*, but increasing the likelihood of *schistosomiasis*. See *onchocerciasis*.

**single cell protein, SCP** Bacteria are single celled, as also are many algae and fungi. Some of them can become food—for example, yeast and *Spirulina maxima*, the edible alga. A range of biotechnologies are being developed to produce SCP from sugars or natural gas or other substrates. It is important for the cheap protein manufacture of feed for livestock or humans.

**single filtration, single stage f.**

**single liner** A lining system at the base and sides of a *landfill* site in which one liner is installed. Drainage layers are installed above the liner to collect the leachate and below the liner. The liner may be made from *geomembranes* or compacted clay. This system may be appropriate for landfill sites containing waste material with a low hazard risk. See *landfill liner* and *Figure L.4*.

**single pass flocculator clarifier** See *flocculator clarifier*.

**single stage nitrification** In the biological treatment of wastewaters, one process is used for both BOD removal and *nitrification*. Compare *separate stage nitrification*.

**sink** In pollution, a sink is where the pollutant is removed, e.g. plants are a sink for carbon dioxide from the atmosphere. It is the opposite of a source.

**sink and float treatment** *Float and sink treatment*.

**sinking agent** A chemical put onto oil spills so that the oil sinks with the agent.

**sinous flow** *Turbulent flow*.

**sinous river** A river with many bends and curves.

**siphon** A pipe shaped like a ‘U’ upside down (∩). *Inverted siphons*, U-shapes, are used in *dosing siphons* and the *siphon overflow* and in a sewer to ensure *sewer flushing*.

**Sirofloc** The use 1 to 10 µm particles of the iron ore magnetite to adsorb colloidal particles, colour or some metal ions from water. After mixing the magnetite and water for about 12 minutes, the mixture passes through a magnetic field so that the magnetite aggregates can then be readily settled out in a settling tank. The magnetite is recovered from the settling tank, washed in caustic soda to collect the colloidal material, colour, etc. It is then reused in the process.

**site licensing** See *landfill site licensing*.

**size distribution of particles** See *particle size distribution*.

**size reduction machine** A *pulveriser* or *shredder*.

**skeletal fluorosis** See *fluorosis*.

**skimming** Removing floating material, not only scum, from the surface of water, such as solids (wood) or liquids that do not mix with water or semi-liquid greases, which are removed in a *flotation tank* or skimming tank.

**slabbing** Slicing flattened cars into slices, producing a contaminated steel, of less value than a shredded scrap car.

**slag** Ash that has completely melted, unlike *clinker*.

**slagging incineration** See *vitrification*.

**slaked lime** See *lime*.

**slaking** The formation of calcium hydroxide by the reaction of quicklime (CaO) and water. See *lime*.

**slaughterhouse wastewater** See *meat processing wastewater*.

**sleek** See *slick*.

**sleeping sickness** *Trypanosomiasis*.

**slick, sleek** A batch of oil, scum, wastewater or other pollution on a water surface.

**slime** See *biofilm*.

**sliplining, loose fit liner** A method of water pipe or sewer rehabilitation in which a replacement polyethylene pipe is inserted into the existing pipe. The gap between the liner and the existing pipe is grouted. The pipe must be carefully cleaned before the liner is installed. Sliplining reduces the diameter of the pipe, but this may be more than compensated by the improved hydraulic characteristics of the new pipe. The technique can be used when the pipe is structurally unsound. See *close fit lining, rolldown, swagelining*.

**slope** In *microbiology*, a small quantity of *medium* that has solidified in a stoppered incubating bottle tilted so that it is nearly horizontal, which results in a large surface for *cultures*.

**slot type screen** A *band screen* or *drum screen* in which the screen is made from slotted metal.

**sloughing off, unloading** The washing or dropping off of *biofilm* from an *attached growth process* (e.g. a *rotating biological contactor* or *trickling filter*).

**slow rate anaerobic sludge digestion** *Anaerobic sludge digestion* with a retention time of 25 days or more. The digestion tank is heated to about 35°C using the sludge gas, but it may not be mixed. There is no secondary digestion tank. See *cold digestion*.

**slow rate land treatment** A *land treatment* system where the settled wastewater is applied to the land and percolates down through the soil. This soil must be moderately permeable. The wastewater is treated biologically and filtered as it moves down through the soil. Some of the wastewater may be used by the vegetation. No surface runoff should occur (unlike *overland flow land treatment*) but any that is collected is then re-applied to the land. The area required is between 10 and 50 ha per 1000 m<sup>3</sup>/d of flow. See *Figure L.5 Compare rapid infiltration land treatment*.

**slow sand filter** (*Figure S.6*) One of the earliest filters for water treatment, developed in 1829 by James Simpson. It has a sand layer up to 1.0 m deep over a layer of gravel about up to 0.3 m deep. Perforated concrete or clay

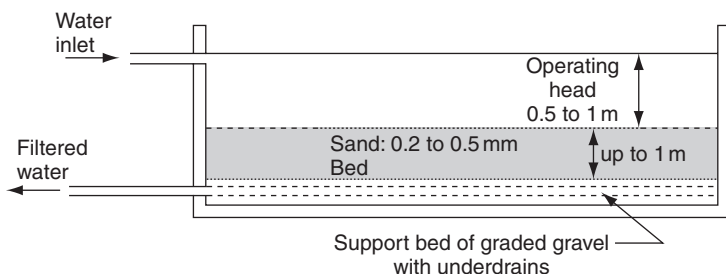

**Figure S.6** Slow sand filter.

underdrains laid in the gravel remove the filtered water. The  $D_{10}$  effective size of the sand is 0.2 to 0.4 mm, with a *uniformity coefficient* of 1.6 to 2.5. The sand is drowned under about 1 m of water. The filter is cleaned every few weeks or months by draining the water and scraping off the top 15 to 25 cm of sand. This is repeated until filtration is no longer efficient, and the sand bed is then renewed. Slow sand filters are capable of removing tastes, odours, some bacteria and some protozoa from the water. The *surface loading rate* is 2.5 to 7 m<sup>3</sup>/d per m<sup>2</sup> of filter surface area. In wastewater treatment, slow sand filters can be used for tertiary treatment with a surface loading less than 10 m<sup>3</sup>m<sup>-2</sup>d<sup>-1</sup>. See *schmutzdecke*.

**sludge** Solids settled out from water or wastewater, but still containing high percentage of water. Sludge from wastewater treatment is known as *biosolids* See *wastewater sludge*, *water works sludge* and below.

**sludge age** The *mean cell residence time* of *activated sludge*.

**sludge application to land** See *land application of sludge*.

**sludge blanket** The mass of sludge in a *sedimentation tank* or *clarifier*. The bottom of the blanket may rest on the bottom of the tank or it may be a suspension, as in the *sludge blanket clarifier*. The *settling regime* of the sludge blanket is either zone settling or compressive settling. See also *upflow anaerobic sludge blanket*.

**sludge blanket clarifier, floc blanket c., upward flow c., upward flow floc blanket c.** A type of *solids contact clarifier* in which the inlet flow passes up through the suspended *sludge blanket*. The particles from the coagulated water are 'filtered' out by and amalgamate with the blanket. When the sludge level rises too high, some sludge is wasted from the tank. The top of the sludge blanket must be well beneath the top water level. The clarified water flows over weirs at the surface of the clarifier. (see *Figure S.7*). The *surface loading rate* may be 40 to 120 m<sup>3</sup>/d per m<sup>2</sup> of tank surface area, depending on the quality of the inlet water.

**sludge cake** Sludge that has been thickened to 80% can be picked up with a shovel and is called cake. *Filter plate presses* can reduce water works and wastewater sludges to less than 70% water. *Belt filter presses* and *centrifuges* can reduce wastewater sludges to about 75% water.

**sludge circulation clarifier** A *solids recirculation clarifier*.

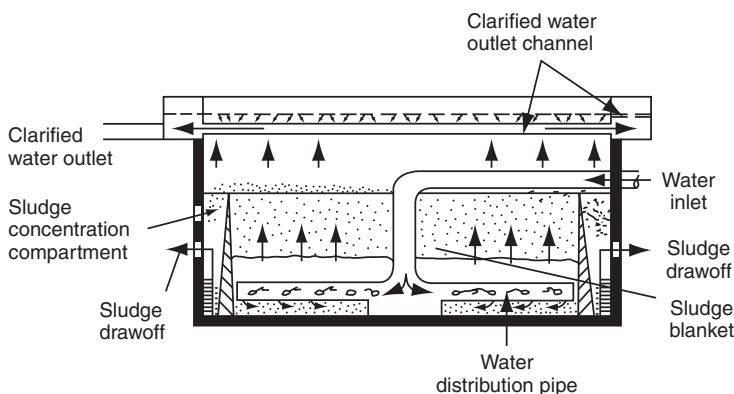

Figure S.7 Sludge blanket clarifier.

**sludge composting** See *composting*.

**sludge conditioners, s conditioning** See *chemical conditioning, conditioning*.

**sludge density** See *specific gravity*.

**sludge density index, Donaldson s.d.i.** A measure of the *settleability* of *activated sludge*. The index is equal to 100 times the reciprocal of the *sludge volume index*—i.e.  $100/\text{sludge volume index}$ .

**sludge dewatering** See *dewatering of sludge*.

**sludge digestion** Usually *anaerobic sludge digestion* (see Figures A.9 and W.2), a treatment that stabilises *raw sludge*. Fully *digested sludge* has little readily biodegradable organic matter. It is not smelly and about 50% of the solids are inorganic. Sludge can also be digested aerobically. See *aerobic digester*.

**sludge disposal** The main routes for sludge disposal are *incineration, land application of sludge* or *landfill*.

**sludge drying** See below, and *dewatering of sludge, heat drying of sludge*.

**sludge drying bed** An open area for drying *digested sludge*, consisting of rectangular, concrete floored lagoons surrounded by walls 0.9 m high and provided with *land drains* over the concrete (Figure S.8), sometimes also with a *decanting valve*. The bottom layer of the bed, covering the drains, is 0.3 m of *clinker* or stone of 25 to 38 mm. A filter is formed by covering it with 5 to 7.5 cm of finer clinker or stone of 6 to 13 mm. This

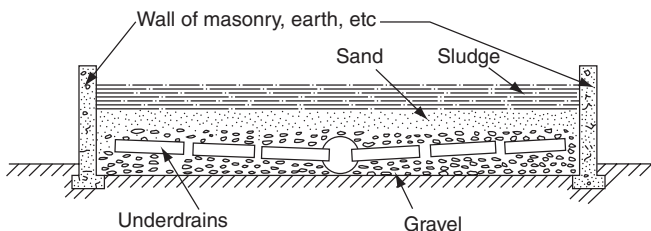

Figure S.8 Sludge drying bed.

may be overlain by 10 cm of sand. A depth of about 25 cm of sludge is allowed to flow in. When the drying sludge is removed by spade, at up to 55% solids, the top layer of fine sand or clinker is removed with it and this has to be replaced. The dried sludge can be removed mechanically, to minimise the loss of sand or clinker. Drying beds occupy a large area of land, which may be expensive. The area needed can be from 0.15 to 0.25 m<sup>2</sup> per person. Consequently, *mechanical dewatering of sludge* may be preferred. *Raw sludge* is too smelly for open drying beds.

**sludge flotation** See *dissolved air flotation*.

**sludge freezing** See *freezing* (2).

**sludge flux** *Solids flux*.

**sludge gas, digester g.** Gas produced from *anaerobic sludge digesters* contains methane, CH<sub>4</sub>, carbon dioxide, CO<sub>2</sub>, and small quantities of other gases. The gas generated is usually collected and used on the plant in heat exchangers to heat the digesters or the offices. In hot weather more gas may be produced than is needed, so the excess gas is often flared. Sludge gas is stored in a gasometer or in the space above the anaerobic digestion tank under the floating roof.

**sludge growth index** See *sludge production*.

**sludge hopper** The lowest part of a *sedimentation tank*, where the settled sludge collects, either by flowing or being scraped in. This deep part is at the centre of an *upward flow tank* or *radial flow tank* and usually at the inlet end of a *horizontal flow tank*. Its capacity, in *primary sedimentation*, should be 1.4 litres per person, which should provide enough space for 24 h *sludge production*. With sides sloping at 60° to the horizontal, it should be deep enough to ensure some consolidation of the sludge by compression settling. See *settling regime, sludge withdrawal*.

**sludge lagoon** A pond where sludge is allowed to digest and thicken. If land is plentiful and cheap, the method is economical but lagoons can be extremely smelly if wastewater sludge is undigested. Some water evaporates.

**sludge loading rate, SLR** The *F : M ratio*.

**sludge melting** The *incineration* and melting of sludge at a temperature of 1200–1500 °C or higher so that a glassy substance is formed on cooling (i.e. vitrification). Some source of silica or silicates may have to be added to the sludge melter in order to maintain a flow of the molten vitrified sludge. The majority of the sludge solids are destroyed in the process and the residual solids are thereby minimised. It has been used in Japan, but it is substantially more expensive than the usual incineration of wastewater sludge. *Figure S.9* shows an example of a coke bed furnace for sludge melting. Another example is the electric arc furnace, which is similar to furnaces used in steel production.

**sludge nutrients** See *land application of wastewater sludge*.

**sludge pasteurisation (or pasteurization)** See *pasteurisation*.

**sludge pressing** The use of *filter plate presses* or *belt filter presses* for dewatering sludge.

**sludge production** (1) The mass of *primary sludge* accumulated per day in wastewater treatment is estimated by multiplying the wastewater flow by

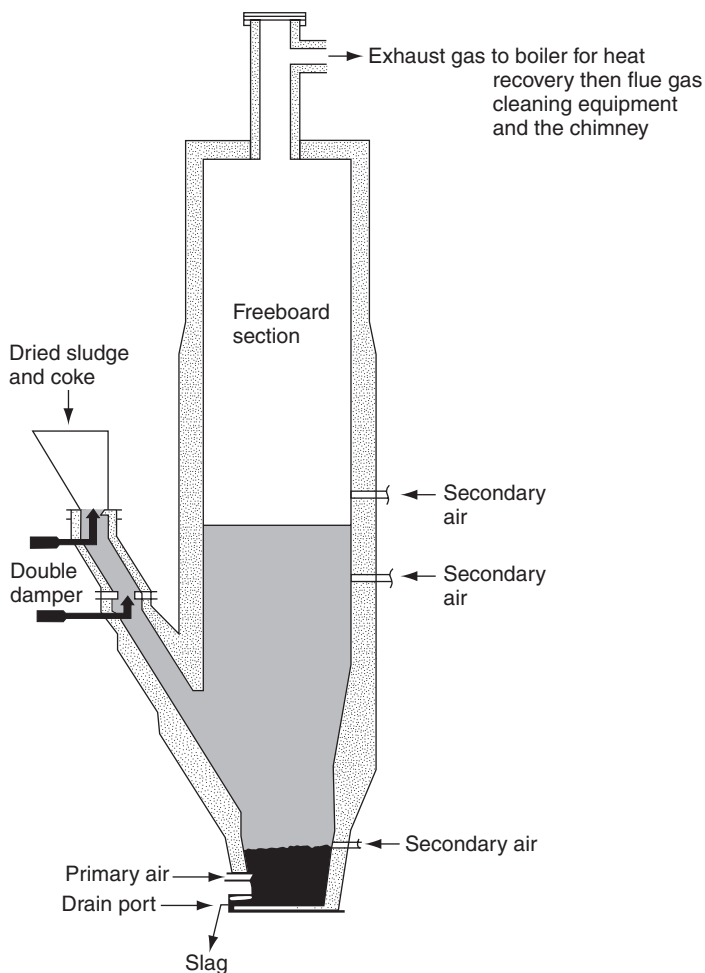

**Figure S.9** Coke bed furnace for sludge melting.

its concentration of suspended solids and by the percentage removal of solids in the *primary sedimentation* tank (typically 60%). Primary sludge production may be about 50 g per person per day. (2) *Secondary sludge* production is often stated as the number of kg of sludge produced per kg BOD<sub>5</sub> removed or applied to the *secondary treatment*, a figure sometimes known as the sludge growth index. For standard rate *trickling filters* it is about 0.7. For *activated sludge* it is about 0.75 at a *F:M ratio* of 0.4 per day and may drop to 0.4 at a *F:M* of 0.1 per day. Standard rate trickling filters produce about 30 g of humus sludge per person per day. Activated sludge production varies from 30 g per person per day for conventional



plants to 15 g per person per day for *extended aeration*. (All sludge figures are stated as dry solids).

**sludge pumping** Sludge with 4% solids, when pumped, involve friction losses in the pipes of 50% more than when clean water is pumped. At 10% solids, pumping becomes difficult because of high friction losses. *Reciprocating pumps* can be used for moving thick sludges.

**sludge recirculation clarifier** A *solids recirculation clarifier*.

**sludge recycle line** The pipe connection between the secondary settling tank and the *aeration tank*, along which the *return activated sludge* passes.

**sludge residence time** In *activated sludge* plants, the *mean cell residence time*.

**sludge respiration** The absorption by sludge of oxygen from solution in the water around it. *See respiration rate*.

**sludge return ratio, s. recirculation ratio** In an *activated sludge* plant, the rate of flow of the *return activated sludge* expressed as a percentage of the average flow rate of wastewater through the plant.

**sludge screening** The screens used for sludge screening are usually *band screen, bar screen* or *drum screen*.

**sludge stabilisation, s. stabilization** Raw wastewater sludge is highly malodorous. Stabilisation renders this sludge relatively odour free and safe to dispose onto agricultural land (*see land application of sludge*) or to *landfill*, depending on the quality of the stabilised sludge. The most common biological method is *anaerobic sludge digestion*, but *aerobic digestion*, such as *composting*, may be used. The main chemical method is *lime stabilisation*. Alternatively, the sludge may be stored for 6 months in order to achieve stabilisation.

**sludge thickening** The difference between two sludges that are, respectively, 98 and 94% water is that the first, at 2% solids, occupies three times the volume of the second for the same weight of dry solids. Therefore, thickening gives good reductions in volume for small increases in solids content. Sludge may be thickened by a variety of techniques. *Gravity thickening* is common. *See belt thickening, centrifuge thickening, deep cone thickening, dissolved air flotation, rotary drum thickening*.

**sludge treatment** *See wastewater sludge treatment, water works sludge*.

**sludge volume index, SVI, Mohlman index** A measurement of the *settleability* of *activated sludge* made in a one litre graduated cylinder:

$$\text{SVI} = \frac{\text{settled volume of sludge in 30 min}(\%) \times 10\,000}{\text{MLSS}(\text{mg/l})}$$

For conventional activated sludge plant, the SVI should be less than 150 and not more than 300, otherwise the sludge will not easily settle in *secondary sedimentation*. However, for plants running at a high *MLSS* these values are reduced. For example, if the *MLSS* is about 10 000 mg/l and the sludge does not settle at all in 30 min (i.e. settled volume is 100%) the SVI is still 100. Therefore, comparisons of SVI values can be misleading. *See stirred sludge volume index*.

**sludge volume ratio** In *sludge thickening*, the volume of thickened sludge held in the thickener divided by the flow of thickened sludge removed per day. Units are days.

**sludge withdrawal** Sludge is withdrawn from *sedimentation tanks* under its hydrostatic head through a pipe, often using a *telescopic valve*.

**slug** See *plug flow*.

**sluice gate** A *penstock*.

**sluice valve** A *gate valve*.

**slurry** A fluid mixture of water with a powder such as cement, or a *tailings* slurry from *mineral dressing*.

**slurry phase treatment, s. p. bioremediation** Solid wastes or thickened sludges are mixed with water or waste water to form a slurry. The slurry may then be aerated in a lagoon to allow biodegradation to occur. This technique has been used to treat contaminated soil, dredgings or sludges.

**slurry wall** A *cut off wall* made from a slurry placed in an excavated trench. The slurry may be soil-bentonite or cement-bentonite. See *permeable active barrier*.

**small bore sewers, effluent drains** Sewers with diameters of 75 mm or possibly less, which may be used to reduce the cost of replacing sewers, or for the sanitary pipework in a *pour flush latrine*.

**smell** See *odour control, odour threshold*.

**smog** Smoky fog. See *London smog, photochemical smog*.

**smoke** Flue gas after it has left the chimney that includes suspended dust, grit, *fly ash*, tar, vapour, soot, carbon dioxide, sulphur dioxide, oxygen, nitrogen, etc., and rarely a coloured gas such as *nitrogen dioxide*. See *gas cleaning plant, tobacco smoke*.

**smoke density meter, opacity m., smoke photometer** An instrument that can be installed at a flue to record the darkness of the smoke that passes through it. A light ray passes through the smoke on to a photoelectric cell.

**smoke test** A method for testing of drainage installations. It involves injecting smoke into the stack and looking for leaks of smoke.

**SNARL Suggested No Adverse Response Level** The concentration or dose of a toxic chemical that is expected not to cause an adverse health effect.

**sneakage** In an *electrostatic precipitator*, the wires and plates cannot reach completely to the top, bottom and sides of its container because of the high charge on the wires. Some of the gas inevitably passes through a region of poor collection. This is known as sneakage.

**snow fence** A light fence of vertical pales nailed to alternate sides of the fence, thus leaving gaps for wind to pass through but holding back snow.

**SO<sub>2</sub>** Sulphur dioxide.

**SO<sub>3</sub>** Sulphur trioxide. See *sulphur dioxide*.

**soakaway, absorption trench, disposal field, leachfield, percolation area, seepage bed, soil absorption system, tile field, trench absorption system** A series of porous pipes or tiles or trenches placed 0.4 to 1.5 m below the surface so that rainwater or wastewater effluent or septic tank effluent can soak away into the soil. Trenches are typically 0.5 m wide (see *Figure S.10*). For a pipe system, the pipe of about 100 mm diameter is laid on a porous

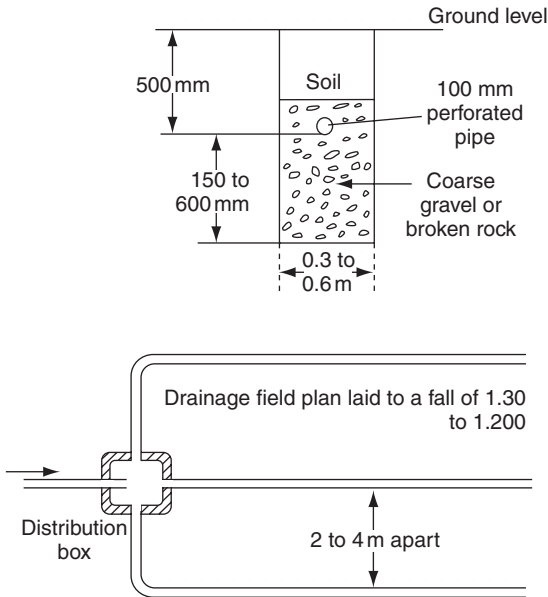

**Figure S.10** Soakaway.

bed of pebbles or crushed rock. The trenches or pipes should be laid at a gentle gradient *Soil percolation tests* are required to ensure the soil is suitable for a soakaway. The loading rates for a sandy loam are about 24l/d per m<sup>2</sup> of the bottom area of soakaway trench. See *absorption pit, detention basin, infiltration trench, soil percolation test*.

**soda ash** Commercial sodium carbonate, used in *water softening* during the *lime soda softening of water*.

**sodium adsorption ratio, SAR** Although sodium is required in limited amount for most plant growth, it can be highly toxic at high concentrations. The SAR is used as an indicator of the effect of sodium in a water on the soil and crops:

$$\text{SAR} = \text{Na} / [0.5(\text{Ca} + \text{Mg})]^{0.5}$$

where Na, Ca and Mg are the concentrations in milliequivalents per litre of sodium, calcium and magnesium in the irrigation water. The SAR calculation may be adjusted for the calcium solubility in the soil water. For crop irrigation, the acceptable SAR depends on the crop type and chemistry of the soil, but in general should be less than 15. The SAR is important when domestic wastewater effluent is used for irrigation because of its sodium content.

**sodium bicarbonate, NaHCO<sub>3</sub>** A common chemical which has been added to water or wastewater to improve its alkalinity and buffering capacity.

**sodium chloride, NaCl** Common salt. See *chlorides, brine*.

**sodium fluorosilicate, sodium silica fluoride, sodium silicofluoride,  $\text{Na}_2\text{SiF}_6$**  The chemical commonly used for *fluoridation* of drinking water.

**sodium hexametaphosphate,  $(\text{NaPO}_3)_6$ , Calgon** A cyclic *polyphosphate* used as a corrosion inhibitor and added to boiler *feed water* in doses of 1 to 2 mg/l. It is able to prevent pitting of iron and steel and the precipitation of *calcium carbonate* and iron compounds.

**sodium restricted diet** Some evidence exists linking hypertension in humans with sodium intake. See *Table D.2 Drinking water standards*.

**sodium silicofluoride** *Sodium fluorosilicate*.

**sodium thiosulphate, hypo,  $\text{Na}_2\text{S}_2\text{O}_3$**  A substance which, at a concentration of at least 100 mg/l, has a stabilising effect on a population of coliform bacteria and is used for this purpose in bacterial sample bottles. Hypo also *dechlorinates* any *free residual chlorine*.

**sodium tripolyphosphate, STP,  $\text{Na}_5\text{P}_3\text{O}_{10}$**  A *builder* in *synthetic detergents*, responsible for up to 70% of the phosphates in domestic wastewater.

**soffit** The under surface of a ceiling or of the top of an arch inside a sewer, pipe, etc., opposite the *invert*.

**Sofia Protocol** An agreement passed in 1988 that commits the signatories to the reduction of emissions of *nitrogen oxides* to the atmosphere. The UK is not a signatory to this protocol.

**soft detergent** A *synthetic detergent* which is readily *biodegradable*.

**softening** See *water softening*.

**soft lining, soft insertion lining** A method of water pipe or sewer rehabilitation in which a 'sock' of felt impregnated with resin and catalyst is inserted into the existing, precleaned pipe. Once in place, the resin is cured (cured in place pipe, CIPP), which may sometimes include heating by use of warm water. Softlining has been used on sewers up to a diameter of 1.2 m. This technique is useful for sealing leaks and adding to the structural integrity of the sewer.

**soft pesticides** *Biodegradable* (non-persistent) *pesticides*.

**soft water** Water with little or no *carbonate hardness* or *non-carbonate hardness*. It may originate in the hard rock areas or from peaty moorland, but not from chalk, nor from limestone formations. Soft water may be corrosive, as in *plumbosolvency*. See *corrosiveness of water, sodium restricted diet*.

**soil absorption system** See *soakaway*.

**soil aquifer treatment** A type of *rapid infiltration land treatment* in which wastewater effluent is applied to the land and percolates down through the soil and into an aquifer from which it is removed via extraction wells (see *Figure S.11*). The effluent is treated biologically and filtered as it moves through the soil and aquifer. It is a method for the *reclamation of wastewater*.

**soil attenuation** See *attenuation*.

**soil biopiles** *Soil heaping*.

**soil flushing, s. leaching** A technique for the *in situ* treatment of contaminated land. Water is applied to the soil and collected in drains or pumped from wells thereby flushing or leaching some of the contaminants out of the

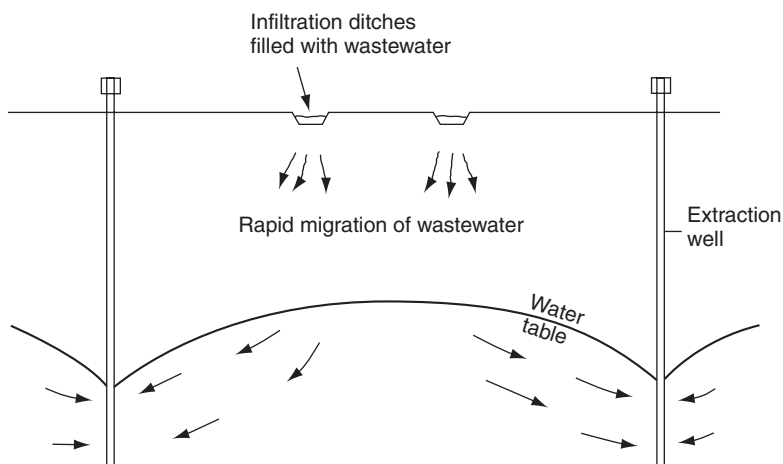

**Figure S.11** Soil aquifer treatment.

soil. Chemicals, such as surfactants or miscible solvents, may be added to enhance release of the contaminants. *Compare soil washing.*

**soil heaping, soil biopiles** A treatment technique for contaminated soil in which the soil is placed in large mounds. Air is then pumped into the mound to assist *bioremediation*. *Compare landfarming* (1).

**soil leaching** *Soil flushing.*

**soil moisture deficit** The difference between the *field capacity* of a soil and the actual moisture level in the soil.

**soil percolation test** A variety of tests exist for the on site measurement of the suitability of the soil to be used as a *soakaway* for effluent. The tests involve digging a hole filling it with water and measuring the time for the water level to drop a measured distance. In the UK, a test hole is dug 250 mm below the invert of the proposed soakaway. The hole is filled with water and left overnight. The following day the hole is filled with water again and the time for the water level to drop a measured distance is noted. The percolation value,  $V_p$ , is calculated as the time in seconds divided by distance of the drop of water level in mm. The floor area of the soakaway in  $m^2$  is then equal to  $V_p \times \text{population equivalent} \times 0.2$ .

**soil recovery** *See contaminated land treatment technologies.*

**soil vapour extraction, SVE, soil gas vapour extraction, bioventing** A technique for removing *VOCs* from contaminated land. Wells (or perforated pipe) are put into the soil and placed under vacuum in order to remove the *VOCs* from the soil. Air may be forced into the soil down a central well in order to assist the extraction at the other wells. The SVE system may be able to extract *VOCs* from depths up to 7 m. *See biosparging.*

**soil washing** An economically successful technique for the treatment of contaminated soil. The soil is excavated washed and then replaced. *Compare soil flushing, solvent extraction.*

**soil water zone** The zone, extending from the surface, which is penetrated by plant roots. The water in this zone is soil water, not *groundwater*. See *field capacity, unsaturated zone*.

**sol** A suspension of *colloid* sized solid particles dispersed in a liquid, sometimes illogically called a colloidal solution.

**solid bowl centrifuge** See *centrifuge*.

**solidification of hazardous waste** See *encapsulation*.

**solid liquid separation** For water treatment, the main methods are *clarification* or *dissolved air flotation*. These processes are normally preceded by *coagulation* and *flocculation* in order to enhance the solids removal. *Rapid deep bed filters* are commonly used to complete the solids removal. In wastewater treatment, the main methods for removing solids are *screens, grit chambers* and *sedimentation*. In sludge treatment, *gravity thickening* and *mechanical dewatering* are common solid liquid separation methods.

**solid phase treatment** Treatment of wastes or wastewaters or contaminated land at a low moisture levels. Options include *composting* or *soil heaping*.

**solids contact clarifier, accelerated c.** A *clarifier* used in water treatment, in which the separated solids or sludge are in direct contact with the incoming water. This accelerates *flocculation* and reduces the amount of *coagulants* used. The *surface loading rate* can be at least twice that of a simple *flocculator clarifier* for a given raw water. See *sludge blanket clarifier, solids recirculation clarifier*.

**solids flux, settling f., sludge f.** In *sedimentation tanks* for wastewater treatment, the product of the concentration of suspended solids and the settling velocity.

**solids flux curve** In the design of *activated sludge settling tanks*, a graph of *solids flux* against suspended solids concentration.

**solids loading rate** The flow into a tank multiplied by the suspended solids concentration in that flow and divided by the surface area of the tank. The units are mass/time per surface area of tank, e.g.  $\text{kg}\cdot\text{m}^{-2}\cdot\text{d}^{-1}$ . It is a parameter that is used for the design of *activated sludge settling tanks* or *gravity thickening* tanks.

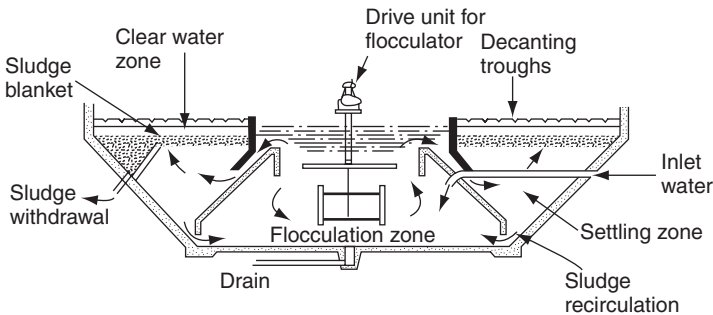

Figure S.12 Solids recirculation flocculator clarifier.

**solids recirculation clarifier** (*Figure S.12*) A type of *solids contact clarifier* in which the separated solids (sludge) are recirculated and mixed with the raw water either within the tank or in a mixer outside. This recirculation of chemical sludge accelerates *flocculation* and reduces the amount of *coagulants* used. They are usually circular in plan, up to 30 m diameter. The *surface loading rate* is 60 to 120 m<sup>3</sup> per day per m<sup>2</sup> of surface area, depending on the quality of the raw water. The flow pattern is a mixture of radial and upward flow, and the incoming water may flow up through a *sludge blanket*.

**solids retention time** The *mean cell residence time* in a biological treatment process.

**solids separation facility** For water or wastewater treatment, a *sedimentation tank* or *clarifier* or *dissolved air flotation*. In sludge treatment, a *sludge thickening tank* or *mechanical dewatering*. For air pollution control, see *particulate removal*.

**solid waste** The term includes *commercial waste*, construction and demolition waste, *domestic waste*, *garden waste*, industrial waste etc. The term may exclude specific wastes which are solid but have more important characteristics such as *hazardous waste* and *radioactive waste*. See *organics in solid waste*, *waste recycling*.

**solid waste arising** The waste generated.

**solid waste treatment** Treatments of solid waste may include one or more of the following: *composting*, *incineration*, *landfill*, *mechanical sorting plant*, *pulverising*, *pyrolysis*, *shredding*, *waste recycling*.

**solubility** The extent to which a substance can dissolve in a *solvent*, measured in grams or *moles* per litre. See *dissolved oxygen*, *molar solution*, *saturated solution*.

**solute** A dissolved substance, forming a *solution* in a *solvent*.

**solution** *Solute* dispersed either as ions or as molecules or both, in a *solvent*. In a solution of solid in liquid the solid disappears completely. Other types of solution exist: liquid in liquid, gas in solid, solid in solid.

**solvent** A liquid or other substance that dissolves another to form a *solution*. Thus, in a solution of salt in water, the salt is the *solute* and water is the solvent.

**solvent extraction** A pollutant may be removed from a waste or wastewater by mixing with a solvent and thereby extract the pollutant from the aqueous phase. Organic, water insoluble, solvents have been used to remove a range of polluting organics from contaminated soil that has been removed from a site.

**soot blower** High pressure air or steam is blown onto the surfaces of the tubes in a boiler to remove the accumulation of soot. It can produce *dark smoke*.

**sorption** A general term for the processes of *absorption*, *adsorption* and *chemisorption* and may include *ion exchange*.

**sough** An *adit*.

**source reduction** The minimisation of the quantity and/or toxicity of waste produced.

**SOUR** *Specific oxygen uptake rates*.

**SO<sub>x</sub>, sox** See *sulphur dioxide*.

**source separation** See *separation at source*.

**sparge** To inject air into water. See *biosparging*.

**sparger, sparge pipe** A pipe or tube that is used to inject air bubbles into water, e.g. to produce *coarse bubble aeration* in an aeration tank.

**sparger turbine aerator** An aeration device that is a *turbine aerator* with a *sparger pipe* added.

***Spartina townsendii*** A grass that is often found in salt marshes between high water neap and high water spring tides. It has been killed by oil refinery effluent containing 25 to 30 mg/l of oil, resulting eventually in the scouring away of the marsh soil.

**spate** A river with an exceptionally high flow compared to its normal flow.

**special waste** A term used in the UK for waste that is hazardous as defined in the 1996 Special Waste Regulations. It is covered by special legislative procedures. Movement of a special waste is regulated by the *consignment note* procedure.

**Special Waste Regulations 1996** Regulations, with their subsequent amendments, that define the legal requirements in dealing with *special waste*.

**species** The division, one of the smallest in *taxonomy*, that is below genus.

**specific capacity of a well** The rate of withdrawal of water from a well in m<sup>3</sup> per minute per metre of *drawdown*, as shown in a yield/drawdown curve of depth against pumping rate. See *storage coefficient*.

**specific conductance** See *electrical conductivity*.

**specific gravity, SG, relative density** The ratio of the mass of a substance to that of the same volume of water at 4°C. The s.g. of dry wastewater solids is about 1.2 and of wastewater sludge at 5% dry solids is about 1.01.

**specific ion electrode** An *ion selective electrode*.

**specific oxygen uptake rates, SOUR, respiration rate** For *activated sludge*, the rate of absorption of oxygen expressed in mg O<sub>2</sub> per g *MLVSS* per hour. See *oxygen uptake rates*.

**specific resistance, r** A measure of the resistance to *filtration of sludge* through a filter cloth:

$$r = \frac{2bPA^2}{C\mu}$$

where,  $P$  = filtration pressure, normally 49 kPa (49 kilonewton/m<sup>2</sup>);  $A$  = area of filtration m<sup>2</sup>;  $C$  = weight of dry solids per unit volume of unfiltered sludge, kg/m<sup>3</sup>;  $\mu$  = dynamic *viscosity* of the *filtrate* in kg m<sup>-1</sup>s<sup>-1</sup> (= N.s/m<sup>2</sup>);  $b$  = slope of the graph  $\theta/V$  versus  $V$  (units = s/m<sup>6</sup>).  $V$  = volume of filtrate collected in time  $\theta$ . Then the dimension of  $r$  is m/kg.

The test resembles the *Buchner funnel test*, except that the volume of filtrate is measured at intervals of 1 min or less. The test can be used to optimise the *chemical conditioning* of the sludge and to assess the difficulty of dewatering it mechanically. A value greater than 10<sup>13</sup> m/kg indicates a difficult sludge to dewater, while 10<sup>11</sup> m/kg indicates



one that is readily dewatered mechanically. Compare *capillary suction time*.

**specific speed,  $N_s$**  A concept indicating the design of the runner, used in the choice of pumps and turbines for a known duty. For a pump with a known performance it is

$$N_s = \frac{N\sqrt{Q}}{H^{0.75}} \text{ (rev/min)}$$

in which  $N$  = speed (rev/min);  $Q$  = discharge ( $\text{m}^3/\text{min}$ ); and  $H$  = optimum pumping head (m).

**specific surface** A measure of the fineness of a powder, stated as the number of  $\text{m}^2$  of surface area per gram.

**specific surface area** In a *gravity thickener*, the surface area of the tank divided by the solids load into the tank. The solids load is the flow multiplied by suspended solids concentration. It is the reciprocal of the *solids loading rate*.

**specific treatment technology** See *TT*.

**specific yield, effective porosity** Of an *aquifer*, the amount of water it yields when it drains by gravity. The value can occasionally reach 45% of the volume of the aquifer but this is exceptional. Ordinarily, a good gravel yields 25% and a clay not more than 3%.

**spent liquor** The effluent from a *coke plant wastewater* after the free ammonia has been distilled from the *ammoniacal liquor*. The spent liquor contains phenols, thiocyanates, ferrocyanides, thiosulphates and some fixed ammonia. Such liquor can be treated by *activated sludge* if the sludge is acclimatised—i.e. if the sludge contains the necessary micro-organisms to break down phenols, thiocyanates, etc.

***Sphaerotilus natans*** One of the *filamentous organisms*, a bacterium found in *sewage fungus* and in *bulking sludge*. See *iron bacteria*.

**spillway, wasteway, waste weir** An open channel or pipe that receives the overflow from a reservoir. Many different types exist, but all need to dissipate the energy of the overflowing water in a *stilling pond* downstream of the spillway.

**spinner** Stationary, helically curved vanes, usually at the inlet to a *cyclone* or other *dust arrestor*, which cause the incoming dusty air to swirl (spin).

**Spiractor** A *pellet reactor*.

**spiral classifier** A *screw classifier*.

**spiral flow aeration tank** An *aeration tank* with *diffusers* or *spargers* placed on one side so as to swirl the liquid, giving roughly spiral flow to it down the tank, as in *aerated grit channels*.

**spiral flow grit chamber** An *aerated grit channel*.

**spirochaete, Spirochaeta** Heterotrophic bacteria shaped like flexible spirals. They can be 500  $\mu\text{m}$  long but only 0.3  $\mu\text{m}$  across. Spirochaetes are found in muds and water or inside a *host*. Some of them cause diseases (e.g. syphilis and *leptospirosis*).

**spirochaetosis** *Leptospirosis*.

***Spirulina maxima*** A single cell protein, an alga that can be harvested and used as food after drying.

**spoil heap, s. bank** A pile of waste, usually rock, from a mine or other industry. Colliery spoil heaps are no longer built as cones with a pointed top. They are compacted during construction by earth moving vehicles running over them and are therefore flat topped as convenient for landscaping. This gentle slope reduces polluting runoff.

**spore** A seed or reproductive but dormant cell. All fungi, some algae and a few protozoa reproduce by spore formation. Spores resist *disinfection*, heat and desiccation. Bacterial spores are called *endospores*.

**spore forming protozoa, Sporozoa** Parasites, some of which, the four species of *Plasmodium*, cause *malaria*, transmitted by *anopheline mosquitoes*.

**spray aerator** An *aerator* in which the water is shot into the air as a fountain with many jets.

**spray chamber** The simplest form of a *wet scrubber*. In a gravitational spray chamber or tower, the gases flow upwards through downward directed sprays (see Figure S.13). The efficiency is about 99% removal of particles greater than 25  $\mu\text{m}$  and about 90% removal of particles of about 5  $\mu\text{m}$ . An alternative is to incorporate a spray within a *gravity settling chamber*

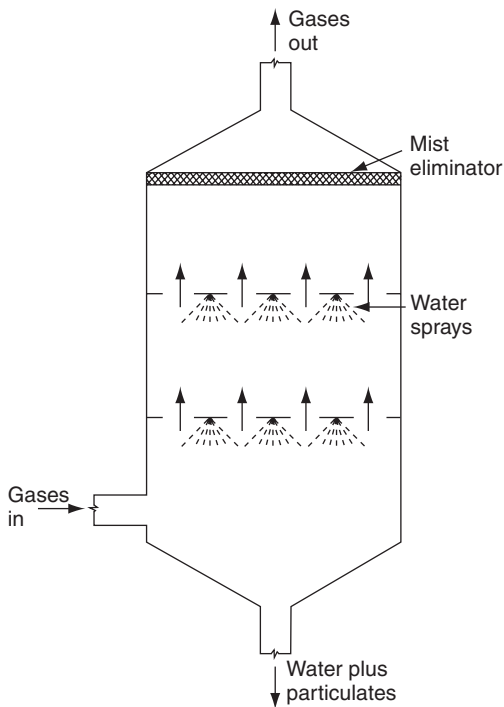

Figure S.13 Gravitational spray chamber.

- which is known as a *gravity spray chamber*. Compare *baffle type scrubber*, *packed bed scrubber*.
- spray dryer** Sludge cake is fed into a *centrifuge* which breaks the sludge into small particles and then the sludge is passed onto a hot drying chamber. Spraying nozzles may be used instead of a centrifuge but the nozzles may suffer from clogging.
- spray drying** Conversion of a solute to powder by spraying the solution into hot air, causing quick evaporation which frees the solute.
- spray field** An area of land being used for *land treatment*, with the wastewater effluent being applied via sprinklers or spray nozzles.
- spray irrigation** Sprinkling water over land intended for growing crops. Wastewater effluents can be sprayed over crops or grass as a final treatment. See *land treatment*, *rain gun*.
- spray lining** Spaying on a lining of cement mortar or gunite or resin by rotating a spray head which is winched through the existing pipeline. See *cement mortar lining*, *gunite lining*.
- spray tower** (1) A *spray chamber*. (2) A *packed bed scrubber*. (3) A *plate tower scrubber* (4) An *evaporative tower*.
- spreading area, s. basin, s. pit, recharge basin or pit** A basin or pit used for *artificial recharge* of groundwater.
- springback** In refuse compaction, the increase in the volume after it has been released from the compactor.
- springtail, Collembola** Insects without wings, some of which graze on *trickling filters*—e.g. *Hypogastrura viatica*. They can feed on bacteria, fungi or decaying organic matter.
- spring turnover, s. overturn** In temperate climates, if a lake freezes in winter, the lake is not mixed by wind action. In the spring, the ice melts and the surface warms making the density similar to the lower parts of the lake (water at 0°C is less dense than water at 4°C). The wind starts to mix (turnover) the lake.
- sprinkling filter** A *trickling filter*.
- spun iron pipe** Cast iron pipe made by pouring the molten metal into a horizontal, water cooled mould rotating at high speed. For the same size and strength, the wall thickness of a spun iron pipe is less than that of a sand cast iron pipe.
- SS** *Suspended solids* or, occasionally, *settleable solids*.
- SSDI** *Stirred sludge density index*.
- SSR** *Step sludge recirculation*.
- SSVI** *Stirred sludge volume index*.
- stabilisation, stabilization** (1) In drinking water, prevention of the deposition of solids from the water. Ordinarily, this means that *calcium carbonate*,  $\text{CaCO}_3$ , should not precipitate from it (see *precipitation*). carbon dioxide gas may be lost by heating or *aeration* of a water, resulting in the formation of a *scale* of  $\text{CaCO}_3$ . After water has been softened by adding *lime*, small amounts of  $\text{CaCO}_3$  may continue to precipitate for some time, forming scale in the water pipes. Addition of  $\text{CO}_2$  may prevent this, reversing the reaction (stabilisation by *recarbonation*). *Polyphosphates* form soluble

complexes with calcium or magnesium salts and doses of 1 or 2 mg/l may be used to stabilise a water. Strong acids, such as hydrochloric acid, HCl, which form soluble calcium salts may also be used to stabilise the water. Stabilisation with strong acid is called vaccination. (2) **Sludge stabilisation.** (3) As applied to heaps of refuse or *tailings*, preventing them from subsiding or blowing away. This is done by earthing over, watering, compacting with steel wheeled tractors or bulldozers, seeding with grass, etc. When a tip has ceased to subside, it is said to be stable. This may be 20 years or more. (4). *See below.*

**stabilisation of hazardous waste and contaminated land** The addition of material to hazardous waste to reduce its toxicity and minimise the mobility of the waste by binding the waste. Normally this involves *encapsulation*. With contaminated land, stabilisation may involve introducing filling material into the soil in order to entirely fill the voids and encapsulate the contaminants into a low permeability, inert soil.

**stabilisation pond** A *waste stabilisation pond*.

**stability** (1) The 'keeping' quality of a wastewater its ability to stay oxygenated and not to putrefy when it is kept out of contact with air for, e.g. 5 days at 20 °C. Stability can be measured by the *methylene blue stability test*. (2) In meteorology, any rate of change of the air temperature upwards that is equal to or less than the *adiabatic lapse rate* is stable, lessening the dispersion of air pollutants.

**stabilization** An alternative spelling of *stabilisation*.

**stack** (1) A vertical pipe in a building that collects wastewater and is connected to the sewer. For a domestic house a 100 mm diameter single stack vented above the roof is adequate for the wastewater drainage system. Flats and office blocks have a discharge stack of 100 to 150 mm diameter. (2) A *chimney*.

**stack gas** *See flue gas.*

**stack gas cleaning** *See flue gas cleaning.*

**stack gas reheating** Heating of *flue gas*, usually after *wet scrubbing* so as to ensure *buoyancy of the stack gas* and dryness in the chimney. It also helps to achieve an invisible vapour plume and reduces pollution at ground level, although this may be unimportant if the scrubbing has removed the pollutants. Even so, the descent of a fog outside a chimney can be unpleasant.

**stack height** *See effective chimney height.*

**stack sampling** Sampling of flue gases, usually with a *sampling train*.

**stage, gage height** The water depth in a river, reservoir, lake, etc., measured from a reference level especially chosen to indicate the flow rate.

**staged combustion** Staged combustion requires that part of the fuel and all of the air is burnt in the primary combustion zone. The lower temperatures that result reduces the production of *nitrogen oxides* in the incinerator. The remaining fuel is added to the secondary combustion zone.

**stage discharge curve, rating c.** A graph of water level (stage) against flow rate (discharge) for a particular point in a stream. It indicates the flow rate there for any water level. Every measuring station should have such a curve drawn for it.

**stagnation** (1) Stillness, a condition of the air under an *inversion*. (2) Lack of movement of the water in a main. It is undesirable and may lead to poorer quality of water.

**stain** In *microbiology*, a dye used to colour microbes selectively—for example, *Gram stain*.

**stainless steel** Steel with substantial additions of nickel (6 to 12%) and chromium (12 to 18%). The amounts of nickel and chromium can greatly alter the mechanical properties. In aerobic conditions a stable, hard oxide film forms on the surface, protecting the metal from corrosion. In the absence of air or oxygen, once the protective oxide layer is removed by erosion from grit, etc., it is not replaced and the material then corrodes as quickly as mild steel. Chloride ions attack the common nickel chromium steels, which therefore cannot be used in sea water. Corrosion by chlorides can be controlled by adding up to 1% molybdenum to the steel.

**stale sewage** Wastewater that has lost its dissolved oxygen and becomes septic if it is not re-aerated.

**stalked ciliates** See *ciliate protozoa*.

**Standard Method for the Examination of Water and Wastewater** A reference book on water testing, published jointly by the American Public Health Association, the American Water Works Association and the Water Environment Federation. It lists not only standard analyses, but also *bioassays*.

**standard rate trickling filter** See *trickling filter*.

**standard trihalomethane potential, STM** A measure of the possible production of *trihalomethanes* for a given water and disinfection protocol.

**standby capacity** Equipment that is not needed for ordinary work but has to be kept in case of breakdown or other emergencies. To reduce expense there must be a balance between the amount of excess plant and the risk of failure.

**standing water level** The level at which the water in a borehole or pit stands when it is left undisturbed for some days without pumping. A large number of such levels forms the *water table* of an unconfined aquifer or the *piezometric surface* of *confined groundwater*.

**standing wave** A *hydraulic jump*.

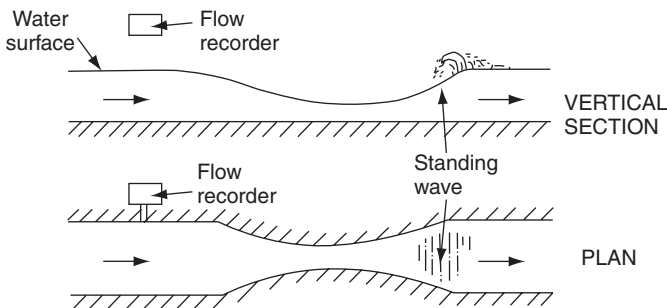

Figure S.14 Standing wave flume.

**standing wave flume** (*Figure S.14*) A measuring flume with a *hydraulic jump* downstream of its throat:

$$\text{flow rate} = 1.705 BH^{1.5} (\text{m}^3/\text{s})$$

in which,  $B$  = width of flume (m) and  $H$  = total upstream head plus kinetic energy head (m). In practice the kinetic energy can be ignored; thus,  $H$  = depth. Such flumes are used to control the flow in a *constant velocity grit channel*.

**stand pipe** A vertical pipe connected to the water *main* and used for water supply in the street. Some 20% or more of city dwellers in poor countries have to use stand pipes to obtain drinking water.

**Staphylococcus** A species of spherical bacterium (coccus). *Staphylococcus aureus* can infect the skin or wounds. Some strains now found in hospitals are immune to antibiotics (although they were at first easily treated by it). The strains are known as MRSA, multiple resistant *Staphylococcus aureus*.

**starved air incineration, controlled air incineration, pyrolytic incinerator, two stage incinerator** An incinerator with two stages of combustion. The *primary combustion chamber* is a pyrolytic stage, with a shortage of oxygen. This is followed by a combustion stage in the *secondary combustion chamber*. These incinerators are more controllable and tend to lead to a lower emission of VOCs and particulates in the effluent gases. They have been used for incineration of *clinical wastes*.

**static compaction, stationary c.** (1) Compression of refuse by a small stationary machine into disposal sacks. (2) Compression of refuse into a steel skip, sometimes with a mechanism that is electrically driven and built into the skip. Other types have an external ram.

**static pile composting** See *aerated static pile*

**stationary phase of growth** The phase of the *microbial growth curve* in which the food source is exhausted and the number of microbes is constant, with growth of new organisms equalling the death of others.

**statutory control of dams** See *ICOLD*.

**statutory nuisance** Specific nuisances that are defined by law or statute. They may be included in the environmental legislation, particularly the Environmental Protection Act, 1990. It often relates to air pollution and noise.

**Statutory Water Quality Objectives, SWQO** Objectives set for various water quality parameters in natural waters that should be attained in the near or medium term (e.g. 5 or 10 years).

**steam generation from incineration** See *waste to energy plants*.

**steam stripping** (1) Steam can be used instead of air in order to strip volatile or semi-volatile organics from the waste or wastewaters. For example, chlorinated hydrocarbons, xylenes, pentachlorophenol can be steam stripped from a wastewater. Typically the steam flows up a *plate tower reactor* and the wastewater, preheated to near boiling, flows down over the plates. (2) For *in situ* treatment of contaminated soil, hot water or steam under pressure can be pumped down boreholes to remove contaminated water or *VOCs* from the soil by pumping the water out via another nearby well.

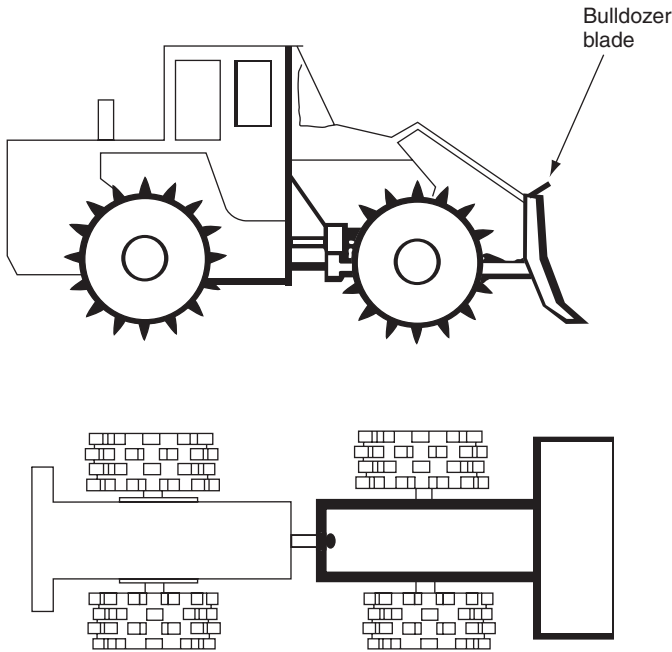

**Figure S.15** Steel wheeled compactor.

**stearated limestone dust** See *hydrophobic chalk*.

**steel** Mild steel is a purified cast iron containing only about 0.1% carbon.

Other elements may be added to improve the strength and other properties—e.g. to make *stainless steel*. Steel water pipes should have external and internal protection against corrosion.

**steel wheeled compactor** A wheeled bulldozer with large steel wheels carrying radial cleats or teeth (see *Figure S.15*), which compact refuse to a density of about 1 tonne/m<sup>3</sup>. The vehicle is specialized for work on a *landfill* site and may not travel under its own power on public roads. The front wheels and blade are often hinged from the rest of the body and rear axle so that considerable rear axle swing is possible for increased maneuverability.

**STEL** *Short term exposure limit*.

**stenohaline** Organisms that can only survive in a narrow range of salt concentrations.

**stenothermophiles** Micro-organisms that prefer to grow at temperatures greater than 60°C.

**stenotopic** Organisms that can only survive in a narrow range of habitats.

**step aeration, s. feeding, incremental loading** Incremental loading best describes this method of feeding the wastewater into an *aeration tank* in *activated sludge* treatment (see *Figure S.16*). It is added at several inlets spaced out along the tank between the main inlet and the outlet, but all the

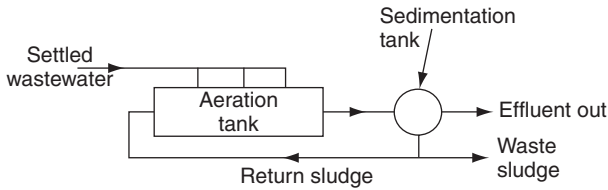

Figure S.16 Step aeration of activated sludge, flow diagram.

- return sludge** is added at the main inlet. The organic load is more evenly distributed along the tank and there is no need for *tapered aeration*.
- step sludge recirculation, SSR** In an *activated sludge* plant, the sludge recycle is fed back to various stages throughout the aeration tank, rather than being returned to the inlet of the aeration tank.
- STEP septic tank effluent pumping** The use of pumps and pressure sewers to enable wastewater from individual households *septic tanks* to flow along sewers that do not have sufficient head to allow for gravity flow.
- sterilisation, sterilization** Destruction of all living micro-organisms. *Compare disinfection.*
- sterilising filter** A filter with pores that are small enough to remove bacteria, as in *microfiltration*. The removal of viruses requires filtration through extremely small pore filter. This can be achieved in *ultrafiltration* or *nanofiltration*, which are more correctly termed *membrane processes*.
- Stigeoclonium** A filamentous green alga that may be found in polluted water.
- stilling basin, s. pool, s. pond** (1) A mass of water that absorbs the energy of flow downstream of a dam *spillway*, to ensure that the river bed is not scoured. (2) A rectangular basin used as part of a *combined sewer overflow*. The pond has two out flow pipes. One pipe is located at the base of the pond and flows onto the wastewater treatment work. This pipe will carry away any sinking solids. The second outlet is a weir that takes the flow from the basin that exceeds that hydraulic capacity of the bottom pipe.
- stilling pond overflow** An overflow downstream of a *stilling basin* (1).
- stilling well, gauge w.** A chamber that communicates with the main body of water by only a small inlet, thus protecting the instrument within it from waves or surges. Often it contains a gauge that automatically records the water level.
- stimulation of a well** Artificially increasing or maintaining the output from a well by methods such as *acidising* an *aquifer* containing limestone or dolomite, or breaking it with high pressure water or explosives, or any combination of these methods.
- stirred sludge density index, SSDI** The SSDI equals 100/SSVI. *See* below.
- stirred sludge volume index, SSVI** Like the *sludge volume index*, a measure of *settleability* for *activated sludge*, except that a 4 litre cylinder is slowly stirred with three vertical 5 mm diameter rods rotating at 1 rev/min:

$$SSVI = \frac{\% \text{ settled volume of sludge in 30 min}}{MLSS, \text{mg/l}} \times 10000 \text{ (ml/g)}$$



**stirred tank reactor, stirred reactor** See *continuous stirred tank reactor*.

**STM** *Standard trihalomethane potential*.

**stochastic** In statistics, random, having an element of chance.

**Stokes' diameter** The diameter of a sphere of the same relative density and free falling speed under *Stokes' law* as the particle under consideration.

See *volume diameter*.

**Stokes' law, S. formula** An expression for the terminal falling velocity of a spherical particle dropping freely in a gas or liquid. If  $d$  is the particle diameter in m and  $\rho$  is the density ( $\text{kg/m}^3$ ), the terminal falling velocity in m/sec is

$$\frac{g d^2 [\rho(\text{solid}) - \rho(\text{fluid or gas})]}{18 \times \text{dynamic viscosity (kg.m}^{-1}\text{s}^{-1})} \quad \text{where } g \text{ is } 9.81 \text{ m/s}$$

Stoke's law applies to low *Reynolds numbers* ( $< 0.3$ ). It does not apply to *flocculent* particles.

**stone fly, Plecoptera** The *larvae* live in clean, well *aerated* water in upland streams. See *Leuctra*.

**stop log** A temporary dam, often in the form of one or more concrete or steel or wooden beams, inserted at a water intake to a reservoir so as to prevent *abstraction* while *screens* are being repaired or to lower the water level for any other reason.

**storage coefficient, storativity** Of an *aquifer*, the volume of water that it releases when the water level falls by a unit of depth. See *specific capacity of a well*.

**storage of petrol** See *VOC*.

**storage of water** See *reservoir, raw water storage*.

**storativity** *Storage coefficient*.

**storm drain** A term for a *stormwater sewer*.

**storm overflow** *Combined sewer overflow*.

**storm relief sewer** A *stormwater sewer*.

**storm sewage** *Stormwater*.

**storm tanks** *Stormwater tanks*.

**stormwater** Water from any form of *precipitation*. In wastewater engineering it means the *overland flow* that enters the sewers, which can be estimated from the *rational method* or from *unit hydrographs*.

**stormwater management** See *best management practices, urban pollution management*.

**stormwater overflow** *Combined sewer overflow*.

**stormwater sewer, storm relief s.** A sewer that only has flow after rain. It usually discharges direct to the receiving water. In a *combined sewer* system, a stormwater sewer is designed to accept the excess flow of wastewater diverted away from the sewer at a *combined sewer overflow*. In this situation, the water in the storm sewer is diluted untreated wastewater and may cause pollution in the receiving water. At a wastewater treatment works, the wastewater flow exceeding the capacity of the wastewater treatment is diverted away from the works during periods of heavy rain. *Sustainable urban drainage* (SUDS) is a method used to minimise stormwater flows.

**stormwater tank, storm t.** A *sedimentation* tank provided at a wastewater treatment works served by sewers in a *combined system* or *partially separate system*, which stores *stormwater* so that it can be returned for treatment when the rain has stopped. If the stormwater exceeds the tank capacity, the effluent is discharged without further treatment. They may be used for equalising the daytime and night time flow, which restricts their use as stormwater tanks during the day. Their total capacity is often equal to the capacity of the *primary sedimentation* tanks, but other methods of calculation exist, including use of the figure of 0.68 m<sup>3</sup> per person served. It may be desirable to build the primary and stormwater tanks with the same dimensions, scrapers, etc., and with suitable pipework to ensure that the tanks are interchangeable, allowing flexible operation. *Tank sewers*, used for storing the stormwater in the sewer itself, may be located away from the wastewater treatment works.

**STP Sodium tripolyphosphate.**

**straight through cyclone, vortex air cleaner** A *cyclone* in which there is no reversal of the air flow. The dust is removed from the wall of the cyclone through a narrow annular slot which bleeds off some 10% of the air towards a dust bunker. The cleaning efficiency can be further improved by wetting the walls (irrigation) to prevent bounce back and re-entrainment of the dust.

**straining** Removing particles that are larger than the opening of a *screen* or *filter*. *Compare filtration.*

**Strategic Environmental Assessment Directive 2001, SEA Directive** This EU Directive expands the requirements to produce *environmental impact assessments* as part of the planning stage of new projects. It extends the coverage of the EU Directives on EIA enacted in 1985 and 1997. Quality checks and post evaluation of the EIA are now required. SEA considers the cumulative effects of new projects in a given area, as opposed to looking at each project in isolation.

**stratification** Separation into layers. *See density currents, destratification, thermal stratification.*

**stream** *See waterway.*

**streamflow** Flow in a natural open channel. *Compare pipe flow.*

**streamflow routing** *Flood routing.*

**streamline flow** *Laminar flow.*

**street inlet** A *gully*.

**strength of wastewater** Ordinarily, strength means the content of organic or other oxidisable matter in unit volume of wastewater. This depends on many factors, including the population's water consumption, the industrial effluents, the *infiltration* water entering sewers, and whether they form a *combined system* or a *separate system*. It is usually measured by *BOD<sub>5</sub>* or *COD*.

**Streptococcus** A genus of spherical bacterium (coccus) linked to its neighbours in chain form. Some species cause diseases such as pneumonia and scarlet fever.

**Streptococcus faecalis** This bacterium has been renamed *Enterococcus faecalis*.

**stressor** A factor or chemical or agent that causes stress.

**stripping tower** A tower used for removing unwanted gases from water or wastewater, such as ammonia, carbon dioxide, radioactive gases, etc. *See air stripping, ammonia stripping, cascade aerator (Figure C.1), packed tower aerator.*

**strontium 90, <sup>90</sup>Sr** One of the main *radioisotopes in fallout* and in *radioactive wastes*. With its long *half life* of 28 years, it can be a hazard to health, particularly since it can replace calcium in the bone. Belonging to the same chemical family as calcium, it can also be removed from water by any *water softening* process that removes calcium.

**struvite** This crystalline compound is magnesium ammonium phosphate. It can form adherent deposits on the inside of pipelines in sludge digestion systems. Magnesium hydroxide can be dosed into the liquors that emanate from wastewater sludge processing so that phosphate is removed by struvite precipitation.

**styrene** The monomer of *polystyrene*. Styrene is a hydrocarbon with an ethene (ethylene) group substituted on a benzene ring. It can adversely affect the nervous system or liver and is a possible carcinogen. The *USEPA MCL* in drinking water is 0.1 mg/l and the WHO guideline maximum value is 0.02 mg/l.

**subadiabatic** A lapse rate less than *adiabatic*. It tends to produce more stable air and potentially less mixing of pollutants.

**subcritical flow** Flow in an open channel at a speed below the *critical velocity*.

**subkingdom** A *phylum*.

**sublethal toxicity** Toxicity that does not kill but nevertheless may be exceedingly harmful in the long term.

**submerged aerated biological filter** *See biological aerated filter.*

**submerged bed aeration** *See biological aerated filter.*

**submerged biological contactor, SBC** A variant of a *rotating biological contactor* with the discs fully submerged and air supplied via diffusers along the side of the unit so that aerobic conditions are maintained. The air system is arranged so that the air also rotates the discs.

**submerged filter** A *biofilter* (1) that is submerged in wastewater as in *anaerobic filter* or *anoxic filter* or *biological aerated filter*.

**submerged weir, drowned w.** A *weir* with the tailwater above its crest.

**submergence** The state of being covered by a fluid. In wastewater sludge dewatering, the submergence of a *vacuum filter* is usually 25 to 40%. *Rotating biological contactors* are usually 25 to 40% submerged to keep the outer layers of the biofilm aerobic.

**submicron particle** A particle smaller than 1  $\mu\text{m}$  (0.001 mm).

**subnatant liquid** The bottom water or sludge, which sinks below the *supernatant liquid*.

**subsidence inversion** An *inversion* in which air is warmed by its own downward movement.

**substrate** A physical background—e.g. one on which a paint or a plaster is laid or a micro-circuit is fastened. In microbiology it means nutrients as a whole, the substances on which *enzymes* act.

**subsurface filtration** A wastewater treatment used where *subsurface irrigation* is not practicable, using specially prepared sand beds, as in *land filtration*. The effluent is introduced to the *sand filter* by *land drains* that are covered

with topsoil to keep flies away, and is removed by *underdrains* buried at the bottom of the filter.

**subsurface flow *Interflow*** and other *groundwater* flow.

**subsurface flow constructed wetland** *See constructed wetland.*

**subsurface irrigation** Watering of crops by the use of the natural flow of water below ground level or by injection into *land drains*. It is mainly used where sandy soil lies just above an impermeable layer. The *irrigation* water then stays near the surface and can be used by crops. In wastewater treatment, the method provides a type of *soakaway* for treating effluent, usually from *septic tanks*.

**suction hood** *See dust-extraction hood.*

**SUDS** *Sustainable urban drainage.*

**sugar beet wastewater** *See beet sugar wastewater.*

**sulfate, sulfur** *Sulphate, sulphur.*

**sullage, grey water** The wastewater from sinks, baths, washbasins, showers, washing machines, etc. It is not from toilets (i.e. it is not *septage*). Sullage may form two thirds of domestic wastewater, but only one third of the organic waste content. It may be mixed with the septage and flow in sewers to a nearby wastewater works for treatment or it may be disposed into land via a *soakaway* or *land treatment*. In order to reduce water demand, it can be recycled (probably after on site treatment) and used for toilet flushing.

**sulphate reducing bacteria** Bacteria, including *Desulphovibrio desulphuricans*, which oxidise organic compounds, using oxygen from sulphates in water, usually producing sulphides or possibly thiosulphates (ending in  $S_2O_3$ ). In acid water this may come out as *hydrogen sulphide* gas,  $H_2S$ . Sulphides occur in black (*anaerobic*) muds, *septic wastewater*, *sludge*, etc.

**sulphate resistant cement** A cement that contains less than 5% tricalcium aluminate, the part of cement that is most easily attacked by sulphates. However, these cements cannot resist the sulphuric acid that occurs in *sulphide corrosion*.

**sulphates,  $SO_4$**  Excessive sulphate in drinking water can have a laxative effect. Calcium sulphate,  $CaSO_4$ , is *gypsum*. *See Table D.2 Drinking water standards.*

**sulphide corrosion** (*Figure S.17*) Sewers are eaten away by sulphuric acid produced in them by a series of reactions. If the wastewater becomes *septic*, *sulphate reducing bacteria* reduce sulphates to sulphides. In neutral or acid water some of the sulphide will be present as *hydrogen sulphide* gas,  $H_2S$ , which will bubble out at turbulent points in the sewer, and some of this  $H_2S$  will redissolve in the layer of water inside the pipe above water level. This is an ideal growing area for *Thiobacillus* bacteria, particularly the species *T. concretovorvus*. These bacteria oxidise the  $H_2S$  to sulphuric acid,  $H_2SO_4$ . The acidity in the slime above water level may drop to pH 1.0. This strong acid attacks the cement in the concrete pipe and its crown eventually falls in. The process depends on the sulphate content and temperature of the wastewater. For domestic wastewater the production of  $H_2S$  takes considerable time below  $12^\circ C$  and so is not a great problem in temperate climates. However, at wastewater temperatures above  $15^\circ C$

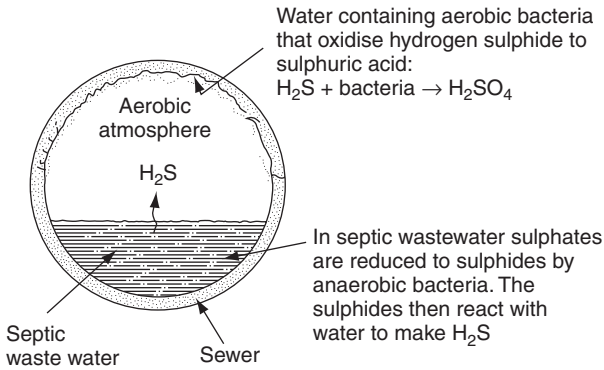

**Figure S.17** Sulphide corrosion in a sewer.

the wastewater becomes septic fast and  $H_2S$  is produced even in short sewers. The life of a conventional concrete sewer may be as short as 5 years in a hot climate. **Sulphate resisting cements** have little advantage over ordinary cement in this strong acid. Possible remedies include the use of plastic pipes or epoxy linings inside the concrete. Regularly spaced **back drops** with forced ventilation at each one will bring the  $H_2S$  out of solution because of the turbulence, and it is then vented to atmosphere. Alternatively,  $H_2S$  production can be stopped by injecting the wastewater with air or oxygen. Another possibility is for the sewers to be designed to run full under pressure. *Thiobacillus* bacteria then cannot grow because they are strict **aerobes**. Despite these possible solutions, sulphide corrosion of sewers remains a major problem of sewerage in hot climates.

**sulphonator** Equipment to inject and meter sulphur dioxide for **dechlorination** of water.

**sulphur bacteria** A general name covering both **sulphur oxidising** and **sulphate reducing bacteria**. It often implies only the oxidising bacteria.

**sulphur content** Municipal refuse generally has a very low sulphur content, well below 1%. Coals and cokes average 1.6%, most of which is oxidised to sulphur dioxide. Only 10% of the sulphur is held in the ash. Crude oil also contains sulphur, most of which passes into the residual fuel oil, which can have up to 4.5% S. In general, the lighter the distillate, the less S it contains, but even distillate fuel oil of 35 s viscosity can contain 1.5% S, although fuel oil with 0.3% S are available.

**sulphur dioxide,  $SO_2$**  An acidic gas that can be washed out of the air to give **acid rain**. It may be present with small quantities of sulphur trioxide ( $SO_3$ ). This mixture is known as  $SO_x$  (sometimes pronounced as sox).  $SO_x$  are a risk to human health and vegetation can also suffer due to excessive  $SO_x$  in the air and from acid rain. Processing and smelting of sulphur rich ores (e.g.  $CuFeS_2$ ) may produce 2 to 10%  $SO_2$  in the gaseous effluent which can be oxidised to  $SO_3$  using vanadium catalyst and then dissolved in water to produce  $H_2SO_4$ . The major source of  $SO_2$  in the air is the waste

gas stream from burning coal or oil, particularly in power generation plants which can yield about 0.1% SO<sub>2</sub> in the waste gas. This is too low for economic recovery as H<sub>2</sub>SO<sub>4</sub>. One option is to burn low sulphur fuels or desulphurised fuels. Alternatively, the SO<sub>2</sub> should be removed from the effluent gases (*see flue gas desulphurisation*). The EU Directive for SO<sub>2</sub> concentration states a one hour mean of 350 µg/m<sup>3</sup> in the ambient air, which must not be exceeded more than 24 times a year, and a 24 hour mean of 125 µg/m<sup>3</sup> in the ambient air, which must not be exceeded more than 3 times a year. In the USA, *NAAQS* has set an SO<sub>2</sub> ambient air quality standard of 80 µg/m<sup>3</sup> (0.03 ppm) averaged over a year and 365 µg/m<sup>3</sup> (0.14 ppm) averaged over a 24 hour period.

**sulphur dioxide absorber** *See flue gas desulphurisation.*

**sulphur hexafluoride SF<sub>6</sub>** A greenhouse gas that is used in electrical switch gear.

**sulphur oxidising bacteria** A diffuse group of bacteria that oxidise sulphides to sulphur or sulphates, or any other form of sulphur to a more oxidised state. The group includes the families of *photosynthetic* bacteria known as *Chlorobiaceae* and *Thiothrix*. *Thiobacillus* is important to *sulphide corrosion*.

**sulphur trioxide, SO<sub>3</sub>** *See sulphur dioxide.*

**sulphur water** Water containing unpleasant levels of dissolved hydrogen sulphide gas.

**summer stagnation in lakes** *See thermal stratification.*

**sump oil** Used lubricating oil from internal combustion engines.

**superadiabatic lapse rate** A *lapse rate* more than adiabatic e.g. 1.4 °C drop per 100 m rise. This produces highly unstable air. *See looping.*

**superchlorination** The use of comparatively large doses of chlorine in *chlorination* (up to 20 mg/l) to eliminate objectionable taste or smell in drinking water. It should be followed by *dechlorination*.

**supercritical flow** Flow in an open channel at a velocity greater than the *critical velocity*.

**supercritical fluid** Materials that have properties between those of gas and liquid.

**supercritical fluids extraction, SCF extraction** Hazardous waste is placed under pressure in a reaction vessel with a supercritical fluid. The organic contaminants dissolve in the supercritical fluid. The supercritical fluid is then separated off and passed to a zone of lower pressure. The organic contaminants come out of solution and can be collected, while the fluid is re-pressurised and recycled to the reactor.

**supercritical water oxidation, SCWO** Water containing hazardous waste is put at high temperatures (e.g. 600 °C) and under high pressure and mixed with compressed air in a reactor. Oxidation of hazardous organic contaminants can occur within minutes.

**Superfund Amendments and Reauthorisation Act, SARA** USA legislation that extended the provisions of *CERCLA* and created \$8.5 billion fund for cleaning up abandoned waste disposal sites. *See Hazard Ranking System, National Priorities List.*

**Superfund sites** In the USA, an abandoned waste disposal facility may become a Superfund site if the clean up programme for the site is funded from *SARA*.

- supernatant** The liquid from the top of a tank in which sludge or solids are settling.
- superphosphate** An important phosphorus fertiliser which is a mixture of calcium phosphate, calcium sulphate, iron oxide, alumina, silica and water, and contains about 20% phosphorus as  $P_2O_5$ .
- supersaturated solution** See *saturated solution*.
- supply pipe** The water pipe that is owned by the property owner and within the boundary of the property. It connects via the *communication pipe* to the water main.
- surcharging** If the flow in a sewer is greater than its hydraulic capacity, the wastewater backs up and eventually come out of the manholes and can cause flooding and pollution.
- surface active agent** A *surfactant*.
- surface aeration** Mechanical *aeration* usually of *activated sludge* by violent agitation of the surface of an *aeration tank* or *lagoon* with *surface aerators*.
- surface aerator** Equipment to drive air into the surface of a liquid such as a *mixed liquor* in an *aeration tank*, by a rotating machine with either a horizontal or a vertical shaft. Horizontal shaft aerators—*brush aerators*—include the *Kessener brush*, the *TNO rotor* and the *Mammoth rotor*. Vertical shaft machines are usually *cone aerators*. Some vertical shaft machines are carried on floats for use on *aerobic lagoons*.
- surface area scrubber** A *packed bed scrubber* (1) or a *plate tower scrubber* (1).
- surface casing** The upper part of the wellcasing. It is solid in order to stop any surface or near surface pollution entering the well.
- surface charge** Many particles, including colloids, bacteria and algae, have a surface electrical potential, usually negative. Particles with similar charge repel one another and settle slowly because they will not unite. *Coagulation* is one method of overcoming the negative potential. Since the particles are negatively charged, a positively charged *coagulant* is used. See *electrophoresis*.
- surface detention** The thin sheet of water that is held on the surface either of the ground or of vegetation during rain. It may eventually evaporate or infiltrate into the ground.
- surface filters** Filters used in air pollution control that collect the particles and form a cake on the surface e.g. a *fabric filter*. Compare *depth filters*.
- surface irrigation** Watering the soil with water or effluent flowing directly on to the ground, as opposed to *spray irrigation* or *subsurface irrigation*. Surface irrigation may flood the land (*flood irrigation*) or the furrows between the rows of crops (*furrow irrigation*). The latter method reduces evaporation, since only part of the soil is flooded. See also *drip irrigation*.
- surface loading rate, surface loading, overflow rate, surface overflow rate** The flow in the tank divided by the surface area. The units are  $m^3$  per  $m^2$  of tank surface area per hour or day ( $m^3m^{-2}h^{-1}$  or  $m^3m^{-2}d^{-1}$ ). This simplifies to units of m/h or m/d. It is a common design criterion for clarifiers, sedimentation tanks, rapid deep bed filters, dissolved air flotation etc.
- surface runoff** *Overland flow*.
- surface solids loading rate** *Solids loading rate*.

**surface tension** The tendency of liquids to shape themselves at their surface into a form with minimum surface area, to oppose spreading.

**surface tension depressant** A *surfactant*.

**surface water** Water in a river, lake, stream, etc. In sewers it is also the rainwater from streets, roofs and paved areas. *See* below.

**Surface Water Directive, 1975** This EU Directive gave three categories of surface waters used for water supply. Classification A<sub>1</sub> are waters that are low in bacterial numbers and low in colour. These waters only require simple physical treatment and disinfection. Classification A<sub>2</sub> are waters that require normal physical and chemical treatment (*coagulation, flocculation, clarification* or *DAF* and *filtration*) and *disinfection*. Classification A<sub>3</sub> are waters that are more polluted and require extra treatment beyond that used for A<sub>2</sub> waters, for example *activated carbon* filtration for removal of low concentrations of pesticides.

**Surface Waters (River Ecosystem) (Classification) Regulations 1994** *See river classification*.

**Surface Water Treatment Rule, SWTR** In the USA, the level of treatment, as stated by the *USEPA*, that is required for a given source of surface water so that the water can be supplied for human consumption.

**surfactant, surface active agent, dispersant, emulsifier, wetting agent** A chemical that affects (normally reducing) the *surface tension* in water. *See synthetic detergents*.

**surge** (1) *See pressure surge in pipe flow*. (2) In the flow of bulk materials such as minerals or refuse on a belt, a temporary sharp increase of the mass of material, sometimes provided for by a *surge bunker* that takes in the extra material during surges and returns it to the circuit when the flow slackens.

**surge bunker** In a line of conveyors, an intermediate bunker with a volume calculated to accept the largest *surge* without overflowing.

**surge prevention** The prevention of any *pressure surge in pipeflow*, aimed at eliminating the damage to pipework caused by these sudden variations in pressure. Several methods exist which may be used in combination. An air vessel connected to the pump delivery pipe reduces *surges* both when the pump starts and when it stops. Surface feeder tanks (surge tanks) above the main, connected to it, fulfil a similar duty and are located every 10 m or so of rise and fall on the *hydraulic gradient*. Other methods include valves that close slowly and are operated by electric motor (motorised valves), relief by-passes or a flywheel on the pump drive, to slow down any change of pumping speed.

**surplus sludge, excess**. Sludge that has to be disposed of—in particular, that from *activated sludge* treatment which is in excess of the *return activated sludge*.

**suspended growth process or reactor, suspended biomass reactor, SBR** A biological treatment process in which the micro-organisms are suspended and mixed in the wastewater. The process is normally aerobic, e.g. *activated sludge* process, but a range of *anaerobic suspended growth* processes have also been developed.

**suspended immobilised biomass reactors, SIBRs, moving bed bio-reactor** Solid medium is added to a diffused air *activated sludge* aeration tank so that extra biomass can grow on and in the solid medium. The aeration tank is



followed by a sedimentation tank. The solid medium remains in suspension in the aeration tank. Various media have been used including 12 mm cubes of polyurethane pads (LINPOR process), corrugated plastic media (BIOFIX process) or rope of woven PVC fibres known as ring-lace. The addition of the media can relieve an overloaded activated sludge plant or allow an existing plant to have extra treatment capacity. When this system is utilised as a *roughing filter* loadings of 4 kg BOD/d per m<sup>3</sup> of aeration tank have been achieved.

**suspended magnet separator** An *overband separator*.

**suspended matter in water** Undissolved material that includes *suspended solids*, greases, tars or oils.

**suspended particles** *Particulates* in the air that settle so slowly that they are considered to remain in the air until they are washed out by rain etc. Typically, the particle diameter has to be less than 10 µm. Particles that settle out are dust. See *total suspended particulates*.

**suspended sediment** Fine sediment that remains in suspension in the river except at very low flows.

**suspended solids** The solids suspended in a liquid include settleable and non-settleable solids. The total suspended solids are measured by filtering the water through a 0.45 µm membrane filter (or possibly a glassfibre filter paper) and drying the paper at 105°C for 1 h. Oil, tar, etc., may be removed beforehand by washing the sample with a volatile organic solvent, but this operation can usually be omitted. The volatile suspended solids (VSS) are estimated by heating the filter paper with the suspended solids to 550°C. The VSS are thus oxidised to carbon dioxide. See *volatile solids*.

**suspension** A moving liquid or gas containing particles floating in it.

**suspension current** A *density current*.

**suspension firing** The burning of particles tiny enough to hang in the air. Burning is several times faster than on a grate. A rough criterion for the size of fuel that can be fired in suspension is: the burnout time in the furnace should be less than the time taken for the gases to pass through it, usually about 2 s. In the *vortex incinerator* the time may be longer. With suspension firing of coal or refuse the fuel is ordinarily blown into the furnace through pipes from the crusher or treatment plant.

**sustainable development** Developments in a given area that preserve and manage the natural resources. The resources are not depleted and the environment is not polluted.

**sustainable landfill** The concept that the present generation should deal with waste and not leave problems for future generations. Therefore *landfills* should be stabilised within 30 to 50 years so that the land can be utilised for other purposes. One method of securing this rate of stabilisation is to operating the landfill as a *flushing bioreactor landfill*.

**sustainable urban drainage, SUDS** An approach to the drainage of rainwater in urban areas that aims to reduce *stormwater* running off into the sewers or reduce flooding. SUDS incorporates permeable surfaces, *swales*, ponds and other infiltration devices so that a maximum of the stormwater infiltrates into the soil. This also enhances the recharging of groundwaters.

- Detention basins** may also be used in a SUDS system. *See urban pollution management.*
- sustained yield of a water source** *See borehole yield, yield of a water source.*
- Sv Sievert.**
- SVE Soil vapour extraction.**
- SVI** The *sludge volume index.*
- swagelining, swaging** A method of water pipe or sewer rehabilitation in which a replacement polyethylene pipe or PVC is inserted into the existing pipe. In this technique the pipe has a slightly larger diameter than the host pipe. The new pipes are butt fused together and then pulled, via a reducing die, inside the pre-cleaned host pipe. The new pipe may be preheated before being pulled through the die. The technique can be used for pipes between 0.2 and 1.6 m diameter with insertion lengths up to 400 m. *See rolldown.*
- swales, vegetated swales** Grassy drainage ditches (either natural or man-made) that are used to intercept surface runoff. Typically they are about 0.3 m wide at the base with gently sloping sides. Swales give short term storage of the stormwater and allow infiltration into the soil. This assists in minimising the quantity of stormwater runoff that enters the sewerage system. They are one method for *sustainable urban drainage.* *See urban pollution management.*
- sweating** The separation of metals by the use of their different melting points—e.g. lead at 327 °C or its alloys at lower temperatures.
- swimmer's itch** *Schistosoma dermatitis.*
- swimming ciliates** *See ciliate protozoa.*
- swimming pool water** *Disinfection* of swimming pool water by chlorine or sodium hypochlorite (or other disinfectants) is common in order to maintain good public health. Ammonia may be present in the pool water due to urination by children in the pool and so chlorination beyond the *break-point* is required. The pool water also requires filtration and sand filters are often used for large pools. These filters must be *backwashed* and maintained in good working order otherwise bacteria may flourish and *mud balls* can accumulate in the sand filter.
- SWQO** *Statutory Water Quality Objectives.*
- SWTR** *Surface Water Treatment Rule.*
- Sylvicola fenestralis, Anisopus fenestralis** A dipteran *filter fly* that is common on *trickling filters.* *See grazing fauna.*
- symbiont** Either of the two organisms that benefit from a *symbiosis.*
- symbiosis, symbiotic relationship, mutualism** Any relationship between two organisms (a symbiotic pair) from which both benefit and neither suffers. For example, algae in an oxidation pond consume carbon dioxide and release oxygen while the bacteria convert the oxygen back into carbon dioxide (*see Figure S.18*). Algae and bacteria are not always symbiotic in darkness, both need oxygen and release carbon dioxide.
- syndets** *Synthetic detergents.*
- synecology** The *ecology* of a community of organisms, as opposed to *autecology.*
- synergism** (1) Any interaction of two or more substances such that their total effect is greater than their effects separately. (2) The ability of two

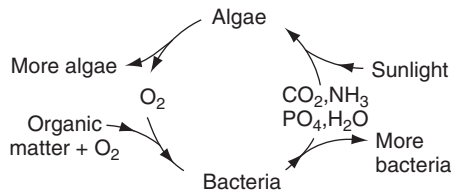

**Figure S.18** Symbiotic relationship between algae and bacteria.

or more organisms to produce effects or reactions that are enhanced by the presence of another organism. Synergistic reactions may be *symbiotic*. **synoptic air circulation** Air circulations on a scale of 100–1000 km e.g. travelling weather systems.

**synthesis** The building of complex substances from simple ones—e.g. *photosynthesis*.

**synthetic data** In *hydrology*, data obtained from computer models, often used in *unit hydrographs*.

**synthetic detergents, syndets** Water soluble substances that contain a *surfactant* plus a *builder* and possibly also a bleach or a brightener. Only 15 to 35% of commercial syndet is surfactant. Surfactants are long chain organic compounds containing water-soluble and oil soluble groups. The three types—*anionic*, *cationic* and *non-ionic*—are so called because of their electrical charge or lack of one when they dissolve in water. Anionic detergents are common in domestic washing powder and liquid detergents. Originally, as hard detergents they were made up of branched *alkyl benzene sulphonates*, which are only slowly biodegradable, and caused foaming at wastewater outfalls and elsewhere. *Linear alkyl sulphonates* are now used—soft detergents readily biodegradable. Non-ionic detergents usually contain numerous ethylene oxide polymers plus water-soluble groups. They are relatively biodegradable. Non-ionic surfactants are used in automatic dishwashers because they have low foaming characteristics. Cationic detergents, usually *quaternary ammonium compounds*, are expensive and used where a bactericidal detergent is needed, as in hospitals, and are not easily biodegradable.

**synthetic liner** A liner at a *landfill* site that uses *geomembranes*. See *landfill liner*.

**synthetic textile wastewater** In general, synthetic textile wastes are less polluting than *cotton textile wastewater* or *woollen industry wastewater* because the natural fibres have to be well washed before they can be processed. Wet processes include scouring (washing), dyeing or bleaching followed by rinsing. The BOD<sub>5</sub> of the mixed waste waters is unlikely to exceed 300 mg/l, with suspended solids of 100 mg/l or less.

**Synura** A green alga which may occur in large numbers (*blooms*), resulting in objectionable tastes and smells in a drinking water. In temperate climates it occurs in spring.



---

**2,4,5-T** *2,4,5 trichlorophenoxyacetic acid.*

**tablet chlorinator** A device in which tablets of calcium hypochlorite are placed. The tablets slowly dissolve to disinfect the water. The tablets must be renewed at appropriate intervals.

**tactic movement** *Taxis.*

**TAD** *Thermophilic anaerobic digestion.*

**Taenia** A genus of parasitic *tapeworm*. *Taenia saginata* larvae are found in cattle and *T. solium* in pigs, but both are also *parasites* in man causing taeniasis (beef tapeworm) or cysticercosis (pork tapeworm). Apart from transmission by undercooked meat, direct ingestion of the eggs from infected faeces is also possible. Prevention of the disease is by sanitary disposal of wastewater and thorough cooking of meat, particularly pork.

**taeniasis** Infection by the tapeworm *Taenia*.

**tagging, labelling** The use of *tracers*.

**tailings** (1) In refuse, tailings are the material left after ashes and dust have been screened off, and iron, steel and any other material salvaged. This material then goes to a landfill for disposal or to the incinerator for reduction in volume. (2) Waste material from *mineral preparation* plants, mainly fine solid *gangue* that becomes fluid if mixed with water.

**talweg** *Thalweg.*

**tanker ballast water** *See oil tanker washings.*

**tank sewer** A short length of sewer with a considerably larger diameter than most of its run, used for storing *stormwater*.

**tannery wastewater** *Chromium* salts (e.g. chromium sulphate) are often used, although some heavy leather products still require natural vegetable materials for tanning. The mixed waste water of pre-tanning and tanning are high in *total solids* (5000 to 20 000 mg/l), 5% being suspended solids, 95% dissolved. The BOD<sub>5</sub> varies between 400 and 4000 mg/l. Vegetable tanning produces more BOD than chrome tanning. The mixed wastes contain about 30 to 70 mg/l of trivalent chromium and 100 to 1000 mg/l of sulphide.

*See beamhouse wastewater fellmongering.*

**Tanypus** A midge found in rivers with mild organic pollution.

**tapered aeration** (*Figure T.1*) Provision of more air at the entrance to an *aeration tank* and less near its outlet. The oxygen demand of the *mixed liquor* is dependent on the BOD<sub>5</sub>. Thus in a *plug flow* reactor, where all the wastewater enters by the main inlet to the aeration tanks, the mixed liquor needs more air there than near the outlet. This can be achieved by having

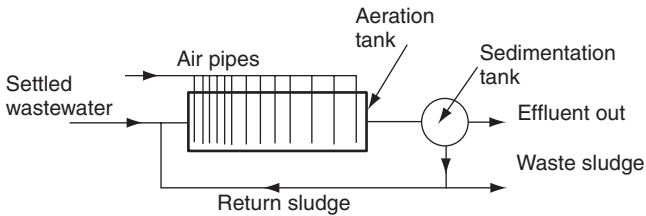

**Figure T.1** Tapered aeration of activated sludge, flow diagram.

more *diffusers* or *cone aerators* of larger capacity at the beginning of the tank. *Compare step aeration.*

**tape sampler, AISI sampler.** A strip of white paper that catches dust from air drawn automatically through it at pre-set intervals. The result is a sequence of spots on the tape, made every hour or half hour. The relative blackness of the spots can be measured by a light meter (photometer) and they can also be chemically analysed.

**tapeworms, Cestodes** Parasitic worms that are found in a variety of animals or fish. Some are parasitic in man, especially *Taenia*. Tapeworm eggs are excreted by the infected human and so are found in wastewater. Many of the eggs are removed into the sludge after *sedimentation*, but they remain alive in raw or *digested sludge* for many months. Tapeworm populations can be controlled by appropriate sanitary disposal of wastewater. Ground recently treated with wastewater sludge may become contaminated with tapeworms if the infection is endemic in the area. *See Diphyllbothrium latum, Hymenolepis nana.*

**TAPs** Toxic air pollutants. *See hazardous air pollutants.*

**taste and palatability of water** Human taste can distinguish only between four sensations on the tongue: bitter, sour, salt and sweet. However, the sense of smell combined with that of taste enables us to acquire an enormous range of apparent tastes that give palatability to what we eat and drink. Consequently, the palatability of a water depends almost entirely on its smell, since few waters have any real taste. Many harmless but unpalatable tastes and smells exist in water, caused by *actinomycetes, algae, trace organic* compounds, *chlorination*, etc. They can sometimes be removed by *filtration* with *activated carbon* or *ozonation*.

**taxis, tactic movement** Movement of a cell or organism in response to a stimulus. Phototaxis is movement towards light. Chemotaxis is caused by a chemical such as a *pheromone*.

**taxon** (plural **taxa**) A class or type of organism. *See below.*

**taxonomy** The classification of living organisms by their body structure, in a hierarchy of seven major divisions (*taxa*), reducing from (1) domain (2) *kingdom* to (3) *phylum*, (4) *class*, (5) *order*, (6) *family*, (7) *genus* and (8) *species*. Thus, *Escherichia coli* is a species of the genus *Escherichia* in the class of Eubacteria, in the phylum of bacteria. For bacteria the standard textbook is *Bergey's Manual of Determinative Bacteriology*.

**TBT** *Tributyl tin.*

**TCDD** 2,3,7,8 tetrachlorodibenzo-p-dioxin *See dioxin.*

**TCDF** 2,3,7,8 tetrachlorodibenzofuran *See dibenzofuran.*

**TCE** This may mean either *trichloroethane* or *trichloroethene*.

**TCLP** *Toxicity Characteristic Leaching Procedure.*

**TD50, tumour (USA: tumor) dose 50%** The dose rate of a chemical in mg of chemical per kg of body weight per day at which 50% of a species of animals develop tumours over the normal life-span of that animal.

**TDI** *Tolerable daily intake.*

**TDF** Tyre derived fuel.

**TDS** *Total dissolved solids* (or salts).

**telemetry** Remote measurement, including the long distance transmission of information from rain gauges, flow meters, level gauges, etc.

**telescopic valve** A type of *decanting valve* consisting of a vertical length of pipe outside a *sedimentation tank*, with a bellmouth at the top, which can be raised or lowered manually or by electric power. It is used for withdrawing sludge. The lower end of the pipe is connected to the bottom of the *sludge hopper*. When the bellmouth is lowered below the liquid level in the tank, the sludge naturally rises up into the bellmouth; the operator can see it and judge when de-sludging should stop, by the appearance of the sludge.

**telesmoke** A simple optical instrument with a series of shades etched onto a telescope lens. It enables *Ringelmann chart* readings to be taken.

**temperature inversion** *See inversion.*

**temporary hardness** *Carbonate hardness.*

**temporal** Relating to time.

**Tenten filter** A *moving bed sand filter*.

**TEQ** *Toxic equivalent.*

**teratogenic** Descriptive of a substance that deforms a foetus or otherwise causes offspring to be misshapen.

**terminal pond, t. pond** A *waste stabilisation pond* or lagoon with no overflow. The effluent evaporates or percolates into the soil.

**terminal velocity** Freely falling masses increase in downward speed to a maximum, the terminal velocity, reached when the fluid resistance equals the weight of the falling mass. *See Stokes' law.*

**tertiary barrier** In a *landfill* site, the third liner in an *multi-liner* system.

**tertiary filters** *Tertiary sand filters.*

**tertiary pond** *Maturation pond.*

**tertiary sand filters, tertiary filters** The use of a sand filter to give *tertiary treatment* to a wastewater effluent. They can be *rapid gravity sand filters* or *upward flow filters* or *moving bed sand filters*.

**tertiary sludge** waste sludge generated from a *tertiary treatment* process.

**tertiary treatment, effluent polishing** Wastewater treatment that improves on, and follows, efficient *secondary treatment*. Conventional wastewater treatment with *primary sedimentation*, plus secondary treatment in the form of biological oxidation with final sedimentation, can reliably produce a final effluent with suspended solids below 35 mg/l and BOD<sub>5</sub> below 25 mg/l. If, e.g., a 10 : 10 effluent is needed, tertiary treatment will polish the 35 : 25

- effluent by removing the fine suspended matter that remains in the effluent after aerobic biological treatment, with the consequent reduction in BOD. Tertiary processes include *aquatic based natural treatment systems, biological aerated filters, maturation ponds, microstrainers, rapid gravity filters, slow and filters. Wastewater disinfection* may also be considered as tertiary treatment. Sometimes tertiary treatment enables water to be immediately reused for an industrial or semi-industrial purpose—e.g. farming. Otherwise it may be necessary because the receiving water has a relatively small flow and consequent low *dilution*. See *advanced wastewater treatment*.
- tetrachlorobenzene** See *chlorinated benzenes*.
- tetrachlorodibenzofuran** See *dibenzofuran*.
- tetrachlorodibenzo-p-dioxin** See *dioxin*.
- tetrachloroethene, tetrachloroethylene, perchloroethylene, C<sub>2</sub>Cl<sub>4</sub>** A solvent commonly used in dry cleaning. The *USEPA MCL* in drinking water is 5 µg/l and the WHO guideline maximum value is 40 µg/l. The EU Drinking Water Directive states a mandatory maximum of 10 µg/l in summation with trichloroethene. See *chloroethenes*.
- tetrachloromethane** *Carbon tetrachloride*.
- tetraethyl lead, tetramethyl lead** See *lead in petrol*.
- Tetrahymena pyriformis*** A *ciliate protozoon* that is common in freshwater and salt marshes. The numbers of this species may be counted in *bioassays* of marshes—e.g. for assessing the effects of toxic chemicals.
- textile industry wastewater** See *cotton textile wastewater, synthetic textile wastewater, woollen industry wastewater*.
- thallium** Thallium compounds are rare in water but highly toxic to humans. See *Table D.2 Drinking water standards*.
- thalweg, talweg** The longitudinal profile along the bottom of a water course.
- theoretical oxygen demand** The oxygen demand that would be calculated from the chemical equation if all the parts of the sample were completely oxidised. See *ultimate oxygen demand*.
- therm** A unit of heat especially for gas; for other fuels it has been superseded by the megajoule (MJ). 1 therm = 100 000 British thermal units = 105.5 MJ.
- thermal comfort** Thermal comfort in a building depends on air temperature, relative humidity and air movement. The requirements vary between individuals. Typically the dry bulb temperature should be 20 °C in the living room, 13 to 15 °C in the bedroom and 20 °C in offices. Other requirements include an air movement of about 10 m/min with a minimum of 6 m/min. The temperature between floor and head height should be relatively even and the relative humidity should be in the range 30 to 70%.
- thermal conditioning of sludge** See *heat treatment of sludge*.
- thermal desorption system** *Thermal treatment of contamination land*.
- thermal drying of sludge** See *heat drying of sludge*.
- thermal NO** At high temperatures N<sub>2</sub> dissociates to nitrogen radicals which react with O<sub>2</sub> to produce nitric oxide (NO). This occurs in the internal combustion engine and it is the most important route for NO production.

**thermal oxidation** The use of heat to induce chemical oxidation. For waste treatment, the typical example is *incineration*.

**thermal pollution** Some effluents, e.g. cooling water from power generation, can be warm and generate a higher temperature in the receiving water. This may cause alteration in the ecology of the river. Thermal pollution reduces the maximum dissolved oxygen level and increases the microbial respiration rates. It also tends to increase the effect of toxic chemicals in the water.

**thermal precipitator** A dust sampling instrument containing an electrically heated wire, which determines the amount of dust in air.

**thermal processing of waste, thermal reduction** The processing and reduction in the volume of a waste or sludge by the use of heat, such as *incineration* or *pyrolysis*. Incineration, in chemical terms, is more correctly stated as thermal oxidation. *See also thermal treatment of contamination land.*

**thermal relief vent** A low stack in a waste incinerator which opens automatically in emergency conditions. Such conditions may occur due to excess temperature in the air pollution control system possibly caused by lack of water in the *wet scrubber*.

**thermal stratification** Water is most dense at 4°C and less dense at all other temperatures, a difference which causes many *density currents*. Large reservoirs, lakes or seas may stratify in summer into three distinguishable layers, the *epilimnion* at the top, the *thermocline* further down and the *hypolimnion* at the bottom (*see Figure T.2*). During the spring the water is cool and mixed by the storms of the preceding winter but the surface water is warming up, creating the warm epilimnion above the thermocline. The thermocline is a relatively narrow strip of water with a rapid change of temperature from the warmth above to the cold, stagnant hypolimnion below. In autumn the upper layers cool and tend to sink, until eventually the body of water becomes completely mixed in the autumn turnover. During the summer stratification the best water comes from the thermocline. The epilimnion may have many algae and the hypolimnion may be

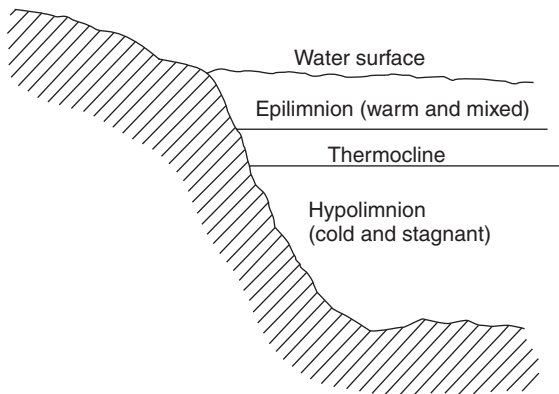

**Figure T.2** Thermal stratification of a lake or sea.



- anaerobic.** During the autumn turnover it is often difficult to obtain any good water. Lakes or reservoirs used for water supply are therefore often destratified as a matter of policy during the summer. Winter stratification may occur also, because the densest water, at 4 °C, remains at the bottom. The water at 0 °C floats on top and sometimes freezes. *See destratification of lakes and reservoirs, spring turnover.*
- thermal treatment of contamination land** Organic pollutants (e.g. oil) from contaminated land can be removed by heating the soil to about 600 °C to 1000 °C. The vapours extracted from the soil may pass to a second combustion chamber operating at about 1250 °C in order to achieve full destruction of the contaminants. The soil has to be removed from the site prior to the thermal treatment. *See also steam stripping (2), vitrification.*
- thermal treatment of sludge** A term that encompasses *gasification, heat drying, incineration, pyrolysis, sludge melting, wet air oxidation.*
- thermal VOC incinerator** A term that is used to describe an incinerator that consists of burning auxiliary fuel together with waste gases rich in *VOCs*, in order to destroy the *VOCs*. The incinerator temperature should be greater than 850 °C. *See catalytic VOC incinerator.*
- thermal wheel** A *heat recovery wheel.*
- thermochemical treatment of waste** Treatment process that uses heat to induce chemical reactions that decompose the waste, such as *gasification, pyrolysis* and *wet air oxidation.*
- thermocline, metalimnion** The thin horizontal layer of water that separates the warm *epilimnion* above from the cool *hypolimnion* below in summer in a lake, sea or deep reservoir. The temperature changes rapidly through the thermocline. *See thermal stratification.*
- thermo-osmosis** Other things being equal, water and water vapour underground move in the direction of flow of heat, towards cooler ground, because this also is the direction of increasing *surface tension*. Thermo-osmosis is important in icy regions where it causes accumulations of ice underground.
- thermophile** Any bacterium that thrives at temperatures above 40 °C. *See also steno-thermophile.*
- thermophilic anaerobic digestion** *Anaerobic sludge digestion* at about 50 °C, a more difficult process to control than *mesophilic digestion* and more expensive because of the extra heat needed, But the sludge digestion time is reduced.
- thermoplastics** Plastics that soften when heated and harden when cooled. They include *high density polyethylene (HDPE), low density polyethylene (LDPE), medium density polyethylene (MDPE), polyvinyl chloride (PVC), polypropylene (PP), polystyrene (PS) polyethylene terephthalate (PET).* They are the most common plastic material in municipal waste and they can be re-heated and remoulded. *See plastics recycling.*
- thermosets** *thermosets* Plastics that harden when cured. Examples include epoxy resins (*see epoxy lining, glassfibre reinforced plastic*) and *polyamides.* They cannot be remoulded.

**thermotolerant coliform bacteria** *Coliforms* that can grow at 44°C. This group includes *E. coli*.

**thickener, thickening** See *sludge thickening*.

**thio-** Prefix indicating a connection with sulphur.

**Thiobacillus** A genus of *sulphur oxidising bacteria* that are *aerobic* and *lithotropic* autotrophs, although some species also may be *heterotrophs*. Different species may oxidise sulphur or sulphides or thiosulphates or sulphites. *T. ferrooxidans* derives energy also from the oxidation of *ferrous salts* ( $\text{Fe}^{2+}$ ) to ferric ( $\text{Fe}^{3+}$ ). It lives in water at pH of 2 to 4 and is abundant at discharges of *acid mine drainage* water which contain much iron sulphide. *T. thiooxidans*, *T. neapolitanus* and *T. concretovorius* are important to the *sulphide corrosion* of sewers. The first two can grow at pH 6.0 but their production of sulphuric acid lowers the pH to about 3.0, when *T. concretovorius* begins to flourish, lowering the pH further to 1.0. *T. concretovorius* cannot exist at pH above 4. Some authors state that *T. concretovorius* may be only a strain of *T. thiooxidans*.

**thiocyanates** Compounds that include a SCN group.

**Thiorhodaceae** *Chromatiaceae*.

**Thiothrix** This *filamentous organism*, a sulphur bacterium related to *Beggiatoa*, is a *chemosynthetic* autotroph and *lithotroph*. It oxidises hydrogen sulphide to sulphur and can be recognised under the microscope by the yellow globules of intracellular sulphur. It may occur in *bulking* activated sludge.

**thiourea** *Allyl thiourea*.

**thixotropic** Description of a fluid that acts like a gel when stationary but like a viscous liquid when stirred. It is a useful property for drilling fluids in boreholes. Thick wastewater sludge also may be thixotropic.

**THMs** *Trihalomethanes*.

**threshold limit value, TLV** The highest concentration of a pollutant to which a worker is allowed to be subjected. Now known as *occupational exposure limit*.

**threshold number for taste and odour, TN, threshold odour number, TON, odour dilution number, ODU** A quantitative value for the measurement of taste and odour in water or odour in air. A panel of testers (typically eight people) finds the volume that the sample must be increased to (using clean water or air) so that no taste or odour is discernible from the sample for half the panel. Two methods of calculation are then used. If the volume of the original sample before dilution is  $V_1$  and the total volume after dilution (including the original sample) is  $V_D$ , then in the USA, the threshold number is  $V_1$  divided by  $V_D$ . The *USEPA* specifies a maximum TN of 3 in drinking water. In the UK, the threshold odour number or TON is  $(V_1 - V_D)$  divided by  $V_D$ . This is now known as the *dilution number*. The 1998 EU Drinking Water Directive states that the taste and odour must be acceptable to the consumer. See *butanol wheel, olfactometer, scentometer*.

**thrust boring, moling** A *trenchless technology* technique for laying pipes in a soil. The boring is started using steel rods driven forwards by hydraulic rams. The bore heads may include a device to allow location of the head.

- Lubrication at the bore head is improved by the use of bentonite slurries. For guided thrustboring, the bore head is eccentric to give some ability to direct the head. When the initial bore is complete, a **backreaming** head is used to enlarge the bore when pulling out the steel rods. For large diameters, multiple backreaming is required. At present the maximum bore that can be achieved is 450 mm. Hard rock can be a difficult problem.  
*See impact moling.*
- tile field** *See soakaway.*
- tilted plate separator** *See inclined plate and tube settlers.*
- time lag of a catchment, basin lag** The total delay between the centroid of a rainstorm and the peak **runoff**, seen in a **hydrograph** of the storm.
- time of concentration** For a **catchment** during a storm, the time taken for the flow rate in a given channel to reach the maximum. It is the **overland flow** time plus the open channel or pipe flow time. For **stormwater sewers** there is also the time of entry or inlet time, during which the rainwater flows through gutters and gulleys into the sewer (some 3 to 4 minutes in towns), also the time taken to flow to a given point in the sewer. *See unit hydrograph.*
- tipper** A term for a person who empties dust bins, a dustman.
- tippling trough** An automatic device with the same function as a **dosing siphon**, used at small works for applying effluent from **sedimentation tanks** to a **trickling filter**. The trough fills with wastewater effluent, tips over when full and discharges as a plug to the trickling filter. The flow is then strong enough to swing the distributor round.
- tip temperature** *See landfill.*
- tire derived fuel** *See rubber tyres.*
- TKN** Total nitrogen by the **Kjeldahl technique**.
- TLV** *Occupational exposure limit.*
- TL<sub>m</sub>** Median tolerance limit. *See LC<sub>50</sub>.*
- TNO** The Dutch public health association.
- TNO rotor** A **brush aerator** with a horizontal shaft. It is used in **oxidation ditches** with channel depths of 1 to 2 m. At maximum immersion the power required is about 1.5 kW per metre length of rotor. For plants serving a population above 10 000, it has been superseded by the **Mammoth rotor**.
- TNT** *Trinitrotoluene.*
- tobacco smoke** Tobacco smoke is the most widespread indoor pollutant. 3000 components have been found in tobacco smoke with carbon monoxide one of the most hazardous gaseous components. The smoke also contains nicotine, tar and numerous carcinogens, such as **benzo(a)pyrene**. All the inhabitants of a building are exposed to the pollutants from tobacco smoke and may suffer health problems. This exposure to tobacco smoke from others is known as passive smoking.
- TOC** *Total organic carbon.*
- TOD** *Total oxygen demand.*
- tolerable daily intake, TDI** The amount of a chemical in food or water that can be ingested over a lifetime without causing major health risks to the individual. It is expressed as kg of chemical per kg of body weight.

**toluene** An aromatic compound with one methyl group ( $-\text{CH}_3$ ) attached to a benzene ring. They are used in industry for a range of purposes. They are toxic to humans giving adverse effects on the nervous system and kidneys at high exposures. The *USEPA MCL* in drinking water is 1 mg/l and the corresponding WHO guideline is 0.7 mg/l.

**ton, tonne** A UK ton (or long ton) is 2240 lb. A US ton (or short ton) is 2000 lb. A tonne (or metric ton) is 1000 kg.

**TON** Threshold odour number. This is usually synonymous with the *dilution number*, but may mean the *threshold number for taste and odour* (TN).

**tortuosity** The path of a fluid through a *rapid deep bed filter* is long and twisting (tortuous), the length being a fair measure of its tortuosity. Thus, if the bed thickness is  $T$  and the length of the flow path is  $L$ , the tortuosity is  $L/T$ , a value greater than 1.

**tortuous flow** *Turbulent flow*.

**total alkalinity, methyl orange a.** In water supply this is defined as the *alkalinity* measured above pH 4.5, the endpoint of titrations using methyl orange as an indicator. It represents the pH when bicarbonate ions ( $\text{HCO}_3^-$ ) have reacted with strong acid to form  $\text{H}_2\text{CO}_3$ .

**total chlorine residual** *Chlorine residual*.

**total coliform count** A *bacterial count* of all the different coliform bacteria present in a sample, as opposed to that of one species—e.g. *E. coli*.

**total dissolved solids, t. d. salts, TDS** TDS are measured by evaporation at 103 to 105 °C of a filtered sample of water and weighing the residue, but they can also be estimated quickly from the *electrical conductivity* of the water. See *Table D.2 Drinking water standards*.

**total head** See *head of water*.

**total incineration** See *vitrification*.

**total Kjeldahl nitrogen** The sum of *ammoniacal nitrogen* and unoxidised *organic nitrogen*, measured by the *Kjeldahl technique*.

**total organic carbon, TOC** An instrumental method for measuring the organic content of water using either thermal oxidation or chemical oxidation of the organic material with subsequent measurement of the carbon dioxide produced. Only small samples (50 to 100  $\mu\text{l}$ ) can be used in the thermal technique whereas the chemical oxidation technique can use samples of 10 ml. Samples with high dissolved solids can produce clogging in the thermal oxidation technique. See *dissolved organic carbon*.

**total oxygen demand, TOD** TOD can be measured by the depletion of oxygen in a nitrogen oxygen carrier gas in a platinum catalysed combustion chamber.

**total recoverable petroleum hydrocarbons, TRPHs** A *USEPA* method for measuring the quantity of petroleum hydrocarbons in a sample of water, sludge, soil, etc. The hydrocarbons are extracted in a solvent and quantified by *infrared spectroscopy*. Some volatile hydrocarbons may be lost in the technique.

**total solids** Total solids in water are measured, like *total dissolved solids*, by evaporation at 103 to 105 °C. It is the sum of the suspended solids and dissolved solids.

**total suspended particulates, TSP** Material that can be collected from air by a *high volume air sampler*. Its use as an air quality standard in the USA has

- been substituted by *PM10*, because it is only the particles of 10 µm or less that are hazardous to human health.
- total suspended solids** See *suspended solids*.
- totting** Investigating and taking some of the contents of other people's dustbins, waste tips or from a *landfill*. It is an illegal form of recycling.
- Toveko filter** A type of *continuous backwashing upflow sand filter*.
- tower composter** A *vertical cell composter*.
- tower reactor** (1) An *activated sludge* plant located in a steel tower which may be 8 to 30 m tall. Air is injected at the bottom of the tower. Compared to a conventional activated sludge plant, the land area required is much smaller and higher *F : M ratios* are claimed. (2) A *packed bed scrubber* (1). (3) A *packed tower aerator*. (4) A *plate tower reactor*.
- toxaemia** The presence of toxins in the blood.
- toxaphene** A persistent insecticide that is toxic to humans affecting various human organs. It can undergo *biomagnification* in food chains. The USEPA *MCL* in drinking water is 5 µg/l. The EU Drinking Water Directive states a mandatory maximum of 0.1 µg/l.
- toxic** Poisonous.
- toxic air pollutants** See *hazardous air pollutants*.
- Toxicity Characteristic Leaching Procedure, TCLP** In the USA, the procedure whereby a waste sample is crushed to particles less than 9.5 mm. The crushed sample is mixed with acetic acid for 18 hours in order to extract (leach out) toxic substances. The sample is filtered and analysed. For wastes suspected to contain volatile hazardous chemicals, special procedures are adopted so that the volatile chemicals are not lost in the extraction procedure. If the concentration of specific chemicals in the extract exceeds stated limits listed in the appropriate legislation, the waste sample is deemed to be hazardous.
- toxicokinetics** The rate of the metabolism and storage of a toxic compound in an organism.
- Toxic Substances Control Act, 1976, TSCA** In the USA, this Act requires information about the toxicity of new materials to be disclosed before the materials go into commercial manufacture.
- toxic units** Toxic units acute ( $TU_a$ ) is the reciprocal of *LC50* times 100. Toxic units chronic ( $TU_c$ ) is the reciprocal of *NOEC* times 100.
- toxic waste** See *hazardous waste*.
- toxic waste treatment** See *hazardous waste treatment*.
- toxin** A poison produced by an organism.
- toxocariasis** *Toxocara canis* and *T. cati* are nematode parasites of the dog and cat respectively, which can produce severe symptoms in humans when the larvae migrate through tissues, particularly the liver. Humans are infected by contact with contaminated cat or dog faeces. The *Toxocara* eggs are found in untreated wastewater sludge.
- toxoid** A toxin that has been denatured.
- 2,4,5-TP, Silvex** 2,4,5 trichlorophenoxypropionic acid, one of the *chlorophenoxy herbicides*. The *USEPA MCL* for this chemical in drinking water is 0.05 mg/l. EU Drinking Water Directive states a mandatory maximum of 0.1 µg/l.

**TPHs** Total petroleum hydrocarbons. See *total recoverable petroleum hydrocarbons*.

**TPTHM, total potential trihalomethane** A test used to determine the *trihalomethane* (THM) production that may occur when a given water is disinfected with chlorine.

**trace element** An element at a concentration, in general, below 1 mg/l. See *micro-nutrients*.

**trace organics** Organic compounds found in minute quantities. In drinking water they may give an unpleasant smell or taste or they may be toxic, such as some of the *polycyclic aromatic hydrocarbons* or *organochlorine* compounds. Most of them can be removed from water by filtration through *activated carbon*.

**tracer** A substance injected into a tank, river, etc., to identify the water, and to show where it travels to and how quickly. Tracers can show *density currents* or other flow patterns in a tank. A groundwater tracer should move at the same rate as the water, and not be adsorbed on clays or other soils (like many *cations* and dyes) and so be lost. Tracers should be cheap, easily injected and harmless. The commonest radioactive tracers are phosphorus-32, carbon-14, *iodine-31*. Chemical tracers include dyes such as *fluorescein* (sodium salt) *rhodamine B* or metallic ions rarely found in natural water, such as *lithium salts*.

**trade effluent** See *industrial effluent*.

**trade waste incinerator** A batch *incinerator* that burns furniture, animal carcasses, bulky trade waste and other refuse unsuitable for disposal at a landfill. See *clinical waste*.

**train** A sequence. See *sampling train, treatment train*.

**tramp iron** Broken bolts, loose nuts or other stray iron or steel, often easily extracted from material flowing on a conveyor belt by a *magnetic separator*.

**tramp oil** Oil that should not be present in a fluid. It may sometimes be removed by *flotation*.

**transect** A strip of land that is surveyed for its plant and animal populations, often by frequency estimations. Re-surveys will indicate whether pollution has affected the life. A beach, for example, has been surveyed in a transect 10 m wide from low water at spring tides to above high water.

**transfer station** See *refuse transfer station*.

**Transfrontier Shipment of Radioactive Waste Regulations 1993** The Regulations in the UK that stipulate the requirements for control of the import or export of radioactive waste in the UK.

**Transfrontier Shipment of Waste Regulations 1994** The Regulations in the UK that stipulate the requirements for control of the import or export of waste in the UK.

**transitional waters** Surface waters in river estuaries which are partly saline. The EU *Water Framework Directive, 2000* classifies the status of these waters by reference to biological, physico-chemical quality and *hydromorphological* elements.

**transmissivity, transmissibility** For groundwater, a measure of the ability to transfer water through a soil or aquifer under a given hydraulic gradient

- through a unit width of aquifer through its entire depth. It equals the *hydraulic conductivity* multiplied by the thickness (height) of the saturated part of the aquifer.
- transpiration** Evaporation through the leaves of plants, of water brought up from the soil through roots. It increases with increasing wind, sunshine and temperature and as the plant gets more foliage. Transpiration varies from plant to plant. Soil moisture does not greatly affect it until the *wilting point* of the soil is reached. *See evapotranspiration, hydrological cycle.*
- transuranic radioactive waste** A waste containing isotopes above uranium in the periodic table. It is generated from the fuel assembly and reprocessing. The radioactivity may be low but the isotopes may be long lived with half lives greater than 20 years.
- trash can** A *dust bin*.
- trash rack** A *coarse screen* such as a *bar screen*.
- travelling bridge sand filter** A sand filter which is divided into various cells so that each cell can be backwashed individually while the rest of the filter is still in use. The travelling bridge backwash mechanism moves over the cell to be backwashed in order to facilitate this method of operation.
- travelling bridge scraper** A common method of scraping the sludge along the floor of *horizontal flow sedimentation tanks*. A bridge spanning the width of the tank has *scraper* blades hung from it. It scrapes from the outlet end of the tank to the *sludge hoppers* at the inlet end. The blades are then lifted off the bottom and the bridge returns. The mechanism is electrically driven through either a rack and pinion or a rope drive. (*See Figure H.3.*)
- travelling grate incinerator** *See moving grate incinerator.*
- tray reactor, tray tower** *Plate tower reactor.*
- treatability** For liquid wastes, usually this means the ability to undergo biological treatment.
- treatment pond** *See waste stabilisation pond.*
- treatment train** A sequence of treatment processes.
- treatment walls** A method for stopping the movement of a contaminant in the flow of groundwater. A chemical is introduced into the ground so that the contaminant chemical in the groundwater is precipitated or adsorbed or degraded the groundwater moves on without the contaminant.
- trematodes, Trematoda, flukes** Flukes can be parasitic to humans, such as the schistosome worm that causes *schistosomiasis* and *Fasciolopsis buski* that causes *fasciolopsiasis*.
- trench absorption system** A *soakaway*.
- trenching** Disposal of liquid sludge by partly filling a trench with it and ploughing and cultivating the land after it has dried.
- trenchless technology** For water pipes and sewers, methods for installing or replacing or repairing the pipe that minimises the digging up of the soil. Examples are listed under *sewer rehabilitation* and *water pipe rehabilitation*. *See also low-dig techniques.*
- trench method of landfilling** A method of operating a landfill, in which wide trenches about 2 to 3 m deep are dug. The waste is then put into the trench

and at the end of each day **daily cover** is used. The daily cover is the material that was excavated from the trench.

**Trent biotic index** A way of biologically classifying rivers according to their degree of pollution, by the frequency and types of animals (invertebrate) found in them, such as *caddis flies*, beetles, *may flies*, *stone flies*, worms, blood worms, leeches, *freshwater shrimps*. The index ranges from 0 for very polluted water without aquatic animals through nine other classes to class 10, without pollution and with abundant life.

**triangle olfactometer** See *olfactometer*.

**triazine** A group of herbicides based on a ring structure of 3 carbon and 3 nitrogen atoms in the ring. The most common triazines are *atrazine* and *simazine*.

**tributyl tin** As the oxide or hydroxide, this chemical is used as an anti-fouling agent on marine vessels. The WHO guideline maximum value for drinking water is 2 µg/l. The EU lists it as a **priority hazardous substance** in relation to aquatic discharges.

**trichloroacetic acid** See *haloacetic acids*.

**trichloramine, NCl<sub>3</sub>** See *chloramines*.

**trichlorobenzene, TCB** A *chlorinated benzene* used as a solvent. It can be toxic to humans. The *USEPA* sets a **MCL** of 70 µg/l in drinking water. The corresponding WHO guideline maximum value is 20 µg/l. The EU lists trichlorobenzenes as **priority substances** (under review for possible re-grading as priority hazardous substances) in relation to aquatic discharges.

**trichloroethanes, C<sub>2</sub>H<sub>3</sub>Cl<sub>3</sub>** A chemical used in glue, paint, industrial degreasers and aerosol sprays. By 1996, 1,1,1-trichloroethane was not made in the USA due to its effects on the ozone layer. The *USEPA* states a **MCL** in drinking water of 0.2 mg/l for 1,1,1-trichloroethane and 50 µg/l for 1,1,2-trichloroethane. The WHO guideline maximum value is 2 mg/l for 1,1,1-trichloroethane in drinking water. See *chloroethanes*.

**trichloroethene, trichloroethylene, C<sub>2</sub>HCl<sub>3</sub>** An industrial solvent used for cleaning, particularly de-greasing metal parts. High level of exposure can cause liver and kidney damage and have adverse effects on the nervous system. The WHO guideline maximum value for drinking water is 70 µg/l. The EU Drinking Water Directive states a mandatory maximum of 10 µg/l in summation with tetrachloroethene. See *chloroethenes*.

**trichlorofluoromethane, trichlorofluoromethane, fluorotrichloromethane, fluorocarbon-11, Freon-11** A *chlorofluorocarbon* (CFC) with the chemical formula CCl<sub>3</sub>F. It was used as an aerosol propellant with 100 000 tonnes released yearly into the atmosphere. See *ozone depletion*.

**trichloromethane** Chloroform, CHCl<sub>3</sub>. A chemical with a range of industrial uses. It is a weak **greenhouse gas**. The EU lists it as a **priority substance** in relation to aquatic discharges. See *trihalomethanes*.

**2,4,5 trichlorophenoxyacetic acid, 2,4,5-T** A *chlorophenoxyacetic acid* that was used as a herbicide. It is toxic to humans affecting the human nervous system, liver and kidneys. The WHO gives a guideline maximum value of 9 µg/l in drinking water. The EU Drinking Water Directive states a mandatory maximum of 0.1 µg/l.



**trichocephaliasis** *Trichuriasis*.

*Trichoptera* Caddis flies.

*Trichosporon* spp. Various species of this yeast that may be found in wastewater treatment processes. Some species are pathogenic to humans.

**trichuriasis, trichocephaliasis** The disease caused by the nematode *Trichuris trichiura* (whipworm, also known as *Trichocephalus trichiura*). Whipworm is common in moist, warm regions. It can cause diarrhoea with the passage of blood to the faeces. The eggs are passed in faeces of the infected human and passed on via contaminated food or water. It is found in domestic wastewater and wastewater sludge. It may be controlled by efficient wastewater disposal and the use of uncontaminated water supplies.

**trickling filter, percolating f., sprinkling f., biological f. bacteria bed** An *aerobic biological treatment* for wastewater that was developed in Salford, England in 1893. In a typical standard rate trickling filter (Figure T.3), the wastewater trickles down through a 2 m deep bed of coarse stones, 24 to 100 mm diameter. Many other types exist, possibly using *plastic media* in a packed tower, as in *high rate trickling filters*. It is an *attached growth process* with a *biofilm* developing on the media. The effluent flows to a sedimentation tank, sometimes known as a *humus tank*. The design of a standard rate trickling filter is usually on the basis of *organic loading* of 0.1 kg BOD<sub>5</sub> per day per m<sup>3</sup> of filter volume, or a flow of 0.4 m<sup>3</sup> per day per m<sup>2</sup> of plan area. This should reduce the effluent to a BOD<sub>5</sub> below 25 mg/l. In summer the effluent will probably be nitrified but in winter this is less likely. The attractions of the standard rate trickling filter are its low power cost and simplicity. Its disadvantages are the capital cost for large works, the large land area compared with activated sludge and the absence of versatility in operation. The trickling filter is not wholly *aerobic*. After the biofilm has formed, there is an *anaerobic* layer at the surface of the stones which little or no oxygen can reach. The main microorganisms are *aerobes*, *anaerobes* and *facultative anaerobic bacteria*, but fungi are present also on aerobic surfaces, where they compete with bacteria for food. Algae occur at the top of the filter where there is sunlight. Trickling filters have been used to nitrify activated sludge effluent, and *anaerobic filters* can be used for *denitrification*. See *dosing siphon, filter flies, maturing, ponding,*

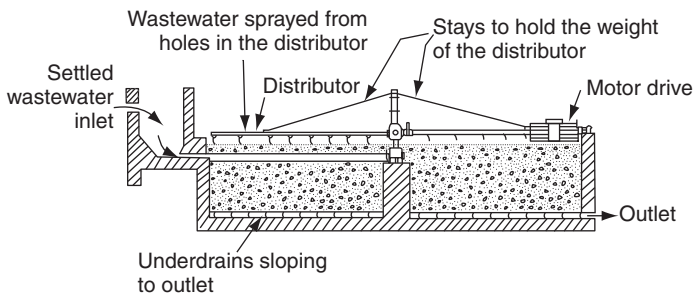

**Figure T.3** Trickling filter, cross section showing electrically driven distributor.

*sloughing, sludge production, tipping trough, and compare alternating double filtration, enclosed aerated filtration, high rate trickling filtration, nitrifying filtration, recirculation.*

**trickling filter solids contact process, trickling filter—activated sludge process**

An aerobic biological treatment system that consists of a *trickling filter* followed by an *activated sludge* process (i.e. an aeration tank and a sedimentation tank). The sludge recycle from the sedimentation tank is returned to the aeration tank.

**trifluralin** A widely used herbicide. The WHO guideline maximum value is 20 µg/l in drinking water. The EU Drinking Water Directive states a mandatory maximum of 0.1 µg/l. The EU lists it as a *priority substance* (under review for possible re-grading as a priority hazardous substance) in relation to aquatic discharges.

**trigger concentrations** The acceptable maximum concentration of contaminants in soil that are relevant to particular potential uses of the land, as set in the UK by the ICRCL (*Interdepartmental Committee on the Redevelopment of Contaminated Land*).

**trihalomethanes, THMs** A group of chemicals based on the substitution of three hydrogen atoms in methane for halogen atoms. They can be *disinfection by-products* formed by the reaction between chlorine with water containing organic material. The typical example is chloroform (trichloromethane, CHCl<sub>3</sub>). The other three THMs that may be found in chlorinated water are bromoform (CHBr<sub>3</sub>), bromodichloromethane (CHCl<sub>2</sub>Br), dibromochloromethane (CHBr<sub>2</sub>Cl). The compounds are carcinogenic to humans. The quantity of THMs produced increases with the initial *total organic carbon* (TOC) concentration, chlorine dose and contact time. The removal of THMs from water is expensive and entails adsorption on activated carbon. The most appropriate method to reduce THMs is the removal of the *precursors* of THM formation or the use of disinfectants that do not have a tendency to produce THMs. The *USEPA MCL* in drinking water for total of all four THMs (total THM, TTHM) is reducing to 0.08 mg/l in 2002. The WHO guideline maximum value for each of the four compounds ranges from 0.2 mg/l for chloroform to 0.06 mg/l for bromodichloromethane. The EU Drinking Water Directive mandatory maximum is 150 µg/l for the sum of the 4 THMs starting from 2005 and then it drops to 100 µg/l from 2010. Chlorodifluoromethane (CHClF<sub>2</sub>) is the *hydrochlorofluorocarbon* HCFC-22 which is used as a refrigerant.

**trimedia filter** *Multi-media filter*.

**trinitrotoluene, TNT** An organic compound with three nitro (—NO<sub>2</sub>) groups attached to the benzene ring of a *toluene* molecule.

**tripolite** *Diatomite*.

**trippage** (1) The number of trips made by a *returnable container*. (2) The number of round trips of a vehicle between two places in a given period of time.

**tritium oxide, T<sub>2</sub>O or HTO** An unusual form of *heavy water* which is radioactive because of its tritium content. It can be used as a tracer. The EU Drinking Water Directive for tritium states a maximum of 100 Bq/l.

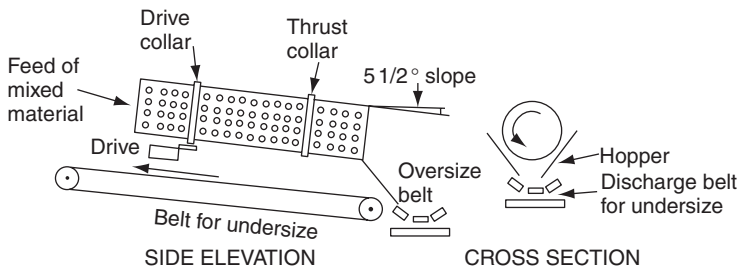

**Figure T.4** Trommel for sorting mixed refuse into two sizes (casing omitted). A trommel for sorting into three sizes has two different opening sizes, with the larger openings downhill.

**trommel** (German for 'drum'), **rotary screen** A rotating steel plate cylinder with holes punched in it (See Figure T.4) which functions as a screen. Because of its rotation it is not easily blocked and is often used for separating municipal refuse into different sizes. One trommel may be inside another; if so, the bigger holes are in the smaller trommel. When two sizes of hole are used on one trommel, the larger holes are downhill from the smaller ones. Material is often screened out of municipal refuse at about 20 mm. This minus 20 mm material is mainly ash, broken glass and other dense material. See *rotary screen magnet*.

**trophic** Concerned with nutrition.

**trophic chain** A *food chain*.

**trophic level** The location of an organism in the *food chain*. In an ecological pyramid, each level of the pyramid feeds off the level below it.

**Trophic Ranking Score, TRS** A method for assessing the nutrient levels in natural waters by looking for various indicator plant species. A score of between 1 to 10 can be used for the plants as they relate to the extent of *eutrophication*.

**Trophic State Index, TSI** An assessment of the extent of *eutrophication* by measuring the transparency of the water, chlorophyll content and phosphate concentrations.

**TRPHs** *Total recoverable petroleum hydrocarbons*.

**trunk main** A supply main from a water treatment plant to a *service reservoir* or *water tower*, not normally used for supplying water to a consumer.

**trunk sewer** Large sewers that collect the wastewater discharged from *collector sewers* or *interceptor sewers* and feed the wastewater to the treatment works (or the river or sea if the wastewater is untreated).

**Trypanosoma** A genus of flagellate protozoa which includes *T. zambianse* (or *gambiense*) and *T. rhodesiense*. See below.

**trypanosomiasis** A disease that includes African sleeping sickness (African trypanosomiasis) and Chaga's disease (American trypanosomiasis). Both are caused by pathogenic *protozoa*, the former by *Trypanosoma gambiense* or *T. rhodiense* and the latter by *T. cruzi*. Sleeping sickness is mainly confined to central and southern Africa whereas Chaga's disease is

confined to Mexico, Central and South America. The typical symptom is *myocarditis*. In chronic infections, the central nervous system is affected and the mortality can be high. Humans are infected by the bite of an infected insect which is the tsetse fly in the African form.

**TSCA** In the USA, *Toxic Substances Control Act, 1976*.

**tsetse fly** See *trypanosomiasis*.

**TSD** Treatment storage or disposal.

**TSI** *Trophic State Index*.

**TSP** *Total suspended particulates*.

**TT** The enforceable standards set by the *USEPA* for drinking water quality in all USA states are set as *maximum contaminant level* (MCL). Most of the standards are in concentrations but some are quoted as TT, which means that a specific treatment technology is prescribed to remove this contaminant from the water if it is present.

**TTHM** Total *trihalomethanes*.

**tube and plate separator** See *inclined plate and tube settlers*.

**tube diffuser** See *diffuser* (1).

**tube module** See *inclined plate and tube settlers*.

**tube precipitator** An *electrostatic precipitator* that collects liquid such as sulphuric acid mist, and is equipped with tubes instead of the plates of the precipitator for collecting solids.

**tube press, multiple t. p.** A slurry dewatering device that can dewater difficult, fine, industrial slurries such as steel furnace scrubber liquid (from 1.5% solids concentrated to 15% solids), etc. It is built up from pairs of concentric tubes, 2 to 2.4 m long and of 0.3 and 0.2 m diameter. The inner tube is perforated and surrounded by stainless steel mesh supporting a replaceable filter *membrane*. The *filter cake* collects outside it and is periodically removed by lowering the inner tube, which allows the cake to drop off. The slurry has to be pumped into the annulus between the tubes. On the outer edge of the annulus, just inside the outer tube, is another tube, of strong rubber. Pressure is applied outside the rubber tube by hydraulic fluid, compressing the rubber, reducing its diameter and forcing the clear water through the filter into the inner tube, from which it flows away. The major disadvantage is high capital cost compared with other mechanical dewatering devices.

**tuberculation** The formation of tubercles or nodules on the inside of a pipe. This can occur in cast iron pipes as part of the corrosion of the pipe.

**tuberculosis** This lung disease is usually transmitted by airborne droplets from an infected person. The bacterium that causes the disease is commonly *Mycobacterium tuberculosis* or *M. bovis*, the latter from cattle giving bovine tuberculosis. The bacteria are obligate aerobes that multiply in lesions within the lung.

**tube settler** See *inclined plate and tube settlers*.

**tube sheet, t. plate** A sheet or plate of steel through which holes have been punched or drilled. Boiler tubes are inserted into these holes and a gastight joint made between the tube and the plate. Tube plates are also used in *fabric filters* to carry the thimbles that hold the filter bags.

**tube well** A well that is constructed by driving or boring a tube into the ground. Wells can be hand bored down to 40 m. *See deep wells, jetted tube well, palm and sludger tube well.*

**Tubificidae** A family of red worms (e.g. *Tubifex*) typical of severely organically polluted mud which may occur also on highly overloaded **trickling filters**.

**tularaemia, tularemia** A highly infectious bacterial disease that can cause fever and death if it is not treated. The causative bacteria is *Francisella tularensis* (also known as *Bacterium tularensis* or *Pasteurella tularensis*). It particularly affects rodents, rabbits and hares. The disease can be contracted from the bite of ticks, mosquitoes, deer flies, etc. Infection can be from handling infected animals, ingestion of undercooked rabbit or hare meat, drinking contaminated water or from contact with contaminated material such as soil or grain.

**tumbling bay** A **back drop**.

**tumour (USA: tumor) dose** *See TD50.*

**tunnel composter** A method for **in-vessel composting** of organic waste by placing it at the appropriate moisture content in a long tunnel, typically 20 to 30 m long and 4 to 5 m across. The height of the waste in the tunnel is about half the tunnel height. Air is blown into the tunnel, via a perforated floor or pipes, in order to maintain aerobic conditions. Water sprays may be included from the roof of the tunnel in order to maintain the correct moisture content. As new waste is loaded into one end of the tunnel (typically every day), an equivalent quantity of waste is discharged from the outlet end. The composting waste travels along the tunnel in a **plug flow**. The retention time in the tunnel may be about 15 to 20 days for composting of the organic part of shredded municipal waste or sewage sludge cake. Thereafter curing of the compost is required, possibly for up to 3 months.

**Turbellaria, planarians** Free living flatworms. Some species may be found in water that is clean or mildly polluted with organic matter—e.g. *Dendrocoelum lacteum*. The main ones are **flukes** and **tapeworms**.

**turbid** Water that is not transparent is turbid. **Turbidity** is caused usually by particles of **colloid** size, including micro-organisms.

**turbidimeter, turbidity meter** An instrument such as a **nephelometer** which measures the **turbidity** of water.

**turbidity** Suspended or colloidal particles that reduce the transparency of water. *See turbidity unit.*

**turbidity breakthrough** Excessive **turbidity** (dirt) in a **filtrate**.

**turbidity current** A **density current**.

**turbidity unit, TU** Various units are used to measure turbidity in water. One method is to use a suspension of silica. Another method is to compare the water to a standard formazin solution as measured in a **nephelometer**. This gives the **nephelometric turbidity unit** (NTU) or **formazin turbidity unit** (FTU). The 1998 EU Drinking Water Directive states that the turbidity must be acceptable to the consumer. A value of 1 NTU ex water treatment works is the desirable maximum. The WHO guideline maximum value is

- an average of 1 NTU for drinking water. *See also Jackson turbidity unit (JTU), Secchi disc.*
- turbine aerator** A vertical shaft rotating at high speed with submerged blades at the bottom of the shaft. It can be used to mix and aerate water or wastewater. It may be used in conjunction with air supplied from a *sparger pipe* or *diffuser*.
- turbine pump** A multistage *centrifugal pump* with *diffuser* passages, which is often used in boreholes. It may be fitted with mixed flow *impellers* as opposed to purely *centrifugal* impellers in order to prevent overloading of the motor if the *head of water* drops below the design level.
- turbulent contact absorber** A *moving bed scrubber* with several beds about 30 cm deep when still.
- turbulent flow, eddy f., sinuous f., tortuous f.** Flow faster than *laminar flow*, in which the fluid eddies and does not move steadily.
- turnover of lakes** *See spring turnover, thermal stratification.*
- turnover time** The time required for water to lose a quantity of phosphorus (or other nutrient) equal to the total amount present.
- tuyeres, tuyers** A horizontal ring of holes at hearth level through the wall of a *cupola* or blast furnace, which provides the hot or cold blast of air or oxygen for burning the fuel.
- twin pit latrine** *Double vaulted pit latrine.*
- TWL** Top water level.
- two drum magnetic separator** A *magnetic separator* that recovers iron and steel in clean condition without additional treatment, by the use of two magnetic drums. The first drum at the end of the refuse conveyor picks up the iron and steel and drops them on to a short subsidiary belt that feeds the second drum. Much of the paper, etc., drops off, and of what remains, the bulk is removed at the second drum, rotating against the direction of the subsidiary belt. The second drum lifts up the magnetic material and drops it on to the main belt for iron and steel.
- two layer filter** A *dual media filter*.
- two stage digestion** *See anaerobic sludge digestion.*
- two stage filtration** (1) An air or liquid filtration system where two filters are in series so that the first stage removes the larger particles and the second stage can filter out finer particles. (2) The use of two *trickling filters* in series usually with a sedimentation tank between them and after the second filter.
- two stage incinerator** *See starved air incineration.*
- two stage sedimentation** The use of two sets of *sedimentation tanks* in series. For the first stage tanks *desludging* is more frequent than for the second stage, where there is a smaller quantity of more watery sludge. The treatment is little used in wastewater treatment works.
- two stage shredding (or pulverising), double shredding (or pulverising)** Shredding or pulverising of refuse is often undertaken in two stages. Primary shredding of refuse to about 15 cm in size and secondary shredding of refuse to about 3 cm in size. *See shredder.*
- two storey tank** A tank with one compartment over the other—e.g. the *hydrolytic tank*, the *Imhoff tank*.

**tywers** *See* tuyeres.

**tyndallisation** Steaming a culture *medium* for short periods at 100°C on three successive days, to avoid the damage to heat sensitive substances in the medium which might be caused by the longer period in an *autoclave*. The process is intended also to kill *cysts*. Cysts are encouraged to grow by the first heating and develop out of the cyst form but they are killed by the second or third.

**typhoid fever** A serious enteric disease caused by intake of water containing the bacterium *Salmonella typhi* which has been excreted by an infected person. The disease produces a fever but other symptoms are varied. Typhoid may produce constipation rather than diarrhoea. Mortality can be greater than 10% with poor treatment but less than 1% with good treatment. Even after recovery from the disease, a small proportion of humans continue to pass *S. typhi* in their faeces for several months. The bacteria can live but not multiply for some months in water.

**Typhus** *See rickettsiae*.

**tyre derived fuel** *See rubber tyres*.



**UASB** *Upflow anaerobic sludge blanket.*

**UCT process, University of Cape Town process** An adaptation of the *activated sludge* process that can achieve the *nitrification, denitrification* and *biological phosphorus removal*. The four stage process involves an anaerobic zone followed by one or two *anoxic* zones and finally an aerobic zone (see *Figure U.1*). The aerobic zone is used for BOD removal and nitrification. The return activated sludge from the sedimentation tank is fed back to the first anoxic zone. Recycles occur within the process in order to achieve denitrification in the anoxic zones. The first zone is required in order to obtain biological phosphorus removal. The percentage removal can be in excess of 95% for nitrogen and 90% for phosphates.

**UKEA** An acronym occasionally used erroneously to mean 'UK Environment Agency'. There is no such body as the UK Environment Agency. The *Environment Agency* is responsible for England and Wales only, Scotland and Northern Ireland have their own agencies.

**Ulothrix** A wire shaped green alga found in a variety of fresh waters, polluted or unpolluted, and on *trickling filters*.

**ultimate oxygen demand, UOD** Either the *theoretical oxygen demand* or the ultimate biochemical oxygen demand, the maximum value of the BOD test, ordinarily reached after 25 to 30 days' incubation. The UOD is the sum of the ultimate *carbonaceous BOD* and the ultimate *nitrogenous BOD*.

**ultrafiltration** Filtering water through a thin, slightly porous membrane that can remove large molecules. The pore size of the membrane is

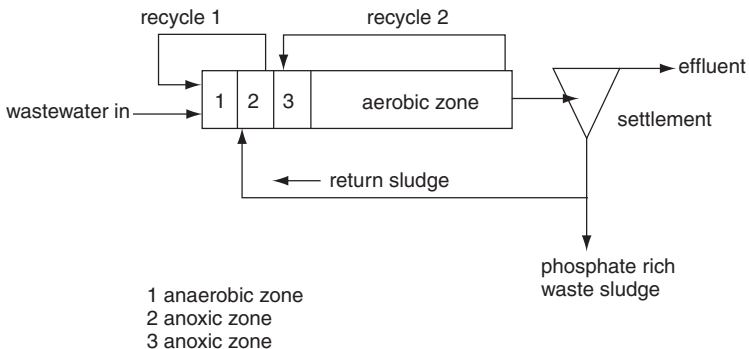

**Figure U.1** UCT process, flow diagram.



- 0.01 – 0.05  $\mu\text{m}$ . The operating pressure is 1–4 bar which is less than *nanofiltration* but higher than *microfiltration*. Ultrafiltration can filter out colour and micro-organisms from water. *See membrane fouling.*
- ultrapyrolysis** *Pyrolysis* that has a fast heating rate up to 1000 °C and the end products are mainly gaseous. *Compare gasification.*
- ultraviolet radiation** *See UV.*
- Ulva, sea lettuce** A green seaweed that grows in organically polluted, nutrient rich estuaries and gives off *hydrogen sulphide* when it rots. It is a multi-cellular *green alga*, attached to sediments or rocks on the bottom.
- unaccounted for water** Water lost in a distribution system by *leakage* or by unofficial connections to the water system.
- uncased hole, open h.** A borehole without *well casing*.
- UNCED** United Nations Commission on Environment and Development often called the *Rio Earth Summit*.
- unconfined groundwater** *Groundwater* that is overlain by an *unsaturated zone*, unlike *confined groundwater*. *See Figure A.11.*
- unconfined aquifer**
- underdrains** Pipes under a *trickling filter* or true filter which remove the water. In the *rapid gravity filter* they also provide access for the backwash water. Their design should be such as to provide adequate backwash water. *Sludge drying beds, grass plots*, etc. also have underdrains but without backwash.
- underfire air** *Primary air*.
- underflow** The flow from the bottom of the tank e.g. the rate of sludge withdrawal from a sedimentation tank or sludge thickener.
- undersize** The material that passes through the holes of a *screen*. *Compare oversize.*
- undulant fever** *Brucellosis*.
- UNECE** United Nations Economic Commission for Europe.
- UNECE Protocol** An agreement passed in 1991 that commits the signatories to the reduction of *VOC* emissions to the atmosphere. The UK is a signatory to this protocol.
- UNEP** United Nations Environment Programme.
- uniform flow** Flow in an open channel of constant cross section or in a closed conduit with an established velocity distribution across the conduit, which is constant along it. *See nonuniform flow.*
- Uniform Hazardous Waste Manifest** In the USA, the documentation to give *cradle to grave* management of hazardous waste.
- uniformity coefficient, c. of u.** A measure of the uniformity or variability of the grains of sand in a batch. It is the size of opening through which 60% of the sand by weight passes, divided by the size of opening through which 10% of it will pass. In other words, it is the  $D_{60}$  *effective particle size* divided by the  $D_{10}$  size.
- unit hydrograph** A *hydrograph* that shows for a particular basin the varying *overland flow* that results from unit rainfall (e.g. 25 mm) over it in a given time. Its early shape is determined by the make up of the *time of concentration*.
- Unox system** An *oxygen activated sludge* process.

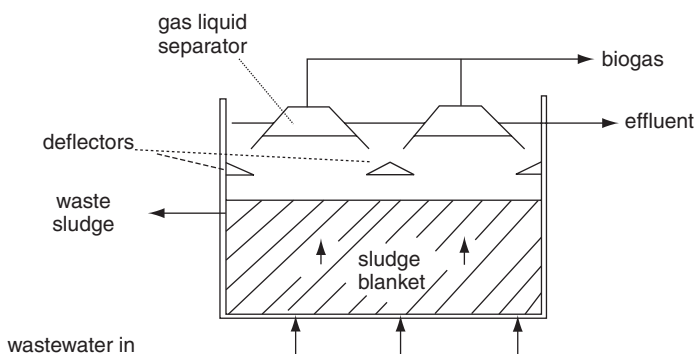

**Figure U.2** Upflow anaerobic sludge blanket (UASB) reactor. Deflectors ensure that gas bubbles rise up into the gas liquid separator.

**unplasticised PVC, uPVC *PVC-U*.**

**unsaturated zone, zone of aeration, vadose zone** The ground above the water table. The voids between the soil particles are filled with air and possibly some water. Below the unsaturated zone is the *zone of saturation*. The water in the unsaturated zone is divided into *soil water*, *pellicular water* and the *capillary fringe*, in sequence downwards.

**UNSCEAR** The United Nations Scientific Committee on the effects of Atomic Radiation.

**UOD** The *ultimate oxygen demand*.

**upflow anaerobic sludge blanket, UASB** An *anaerobic treatment* process for wastewater in which the wastewater flows into the bottom of the reactor and up through a sludge blanket which is composed of biological particles that have grown in the reactor (*see Figure U.2*). The gases that are produced by the anaerobes may attach to the particles lifting them to the top of the reactor where they contact a mesh or other material and are degassed. The process has been used to treat wastewaters with high BODs. Organic loadings of 5 kg/d of BOD per m<sup>3</sup> of tank are typical. The process can be slow at temperature below 12 °C. Excess sludge production is low, but a separate settling tank may be added to ensure good removal of the biological solids from the effluent.

**upflow clarifier** (1) A *pebble bed clarifier*. (2) A *sludge blanket clarifier*. (3) An *upward flow sedimentation tank*.

**upflow contact filter** An *upflow filter*.

**upflow contactor** An upward flow *carbon adsorption bed*.

**upflow filter, upward flow filter** A filter in which the water (or gas) flows from the bottom of the tank to the top as in a *upflow sand filter*.

**upflow floc blanket clarifier** A *sludge blanket clarifier*.

**upflow rate** *Upflow velocity*.

**upflow sand filter** A *rapid deep bed filter* in which the water flows from the bottom of the tank to the top. A 2 m bed of sand is typical. The sand may be restrained by a retaining grid on top of the sand, such as in the

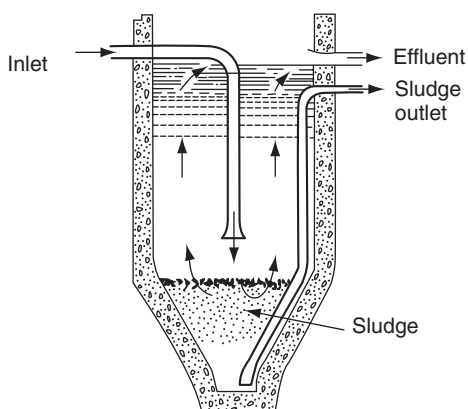

**Figure U.3** Upflow sedimentation tank, cross section.

Immediate filters. Upflow sand filters require *backwashing* which tends to leave the coarser sand at the bottom of the bed. Consequently they operate with *coarse to fine filtration* and can give improved filtration of the water or wastewater. Alternatively, the sand bed in an upflow sand filter may move, as in a *continuous backwashing upflow filter* or a *moving bed sand filter*.

**upflow sedimentation tank** (Figure U.3) A *sedimentation tank* in which the wastewater enters above the sludge level but substantially below the top water level, as in the *Dortmund tank*.

**upflow solids contact** A *sludge blanket clarifier*.

**upflow velocity, *u*, rate** The upward flow in the tank divided by the surface area. The units are  $\text{m}^3$  per  $\text{m}^2$  of tank surface area per hour or day ( $\text{m}^3\text{m}^{-2}\text{h}^{-1}$  or  $\text{m}^3\text{m}^{-2}\text{d}^{-1}$ ). This simplifies to units of m/h or m/d.

**upland catchment water** Water from land that is hilly or mountainous. In many countries it is less likely to be polluted by wastewater because many large cities are near sea level or on lower flatter land. Surface upland water, especially from moorland, is likely to have low bacterial numbers, but it may contain organic acids if the ground is peaty, in which case, the waters are soft and *plumbosolvent*.

**UPM** *urban pollution management*.

**upsizing** In the renewal of water pipe lines or sewers, bursting of the pipe or sewer so that a new larger pipe can be put in place. See *pipe bursting*.

**uPVC** *PVC-U*.

**upward flow** See *upflow*.

**uranine** See *fluorescein*.

**uranium** Uranium and its compounds are radioactive and carcinogenic to humans. See *Table D.2 Drinking water standards*.

**urban drainage** The drainage from urban areas includes the wastewater from domestic and industrial properties together with stormwater. See below and *combined sewer overflow, sewer, sustainable urban drainage*.

**urban drainage engineering** The engineering of *urban drainage* has become an integral part of reducing pollution from urban conurbations. It includes analysis, design and maintenance of the sewerage network together with the associated structures.

**urban pollution management, UPM, u. drainage m., u. runoff m., u. stormwater m.**

The management of wastewaters from *urban drainage*, in particular, the reduction and control of pollution in stormwater runoff from urban areas. Urban areas have much of the land covered by impervious surfaces. Consequently, the runoff from rainfall in urban areas can be greater compared to vegetated surfaces due to the lack of infiltration. It is also more polluting due to the urban runoff picking up contaminants from the road, roofs etc. (see *first foul flush*). Furthermore, in *combined systems*, the capacity of the sewerage system (or wastewater treatment facility) may be exceeded in storm conditions and *combined sewer overflows* then operate which can result in the discharge of dilute untreated wastewater to the receiving water course. Procedures for UPM include initial planning, data collection, modelling of the systems, development of solutions, testing for compliance, obtaining approval and detailed design. Management strategies for UPM may include source control, which includes maximising infiltration by use of *infiltration trenches* or *swales* or *porous pavements* or other techniques. UPM may include treatment control of the urban runoff, for example, by use of *constructed wetlands* or *stilling basins*. Improved performance of drainage schemes can be achieved by actively managing the storage in the drainage system to changing rainfall conditions. Pollution prevention to reduce the contact between the rainfall and pollutants is also adopted in good practice UPM. This includes effective street cleaning and maintenance of sewers. See *best management practices, sustainable urban drainage*.

**Urban Wastewater Treatment Directive 1991** This EU Directive set criteria for the collection and treatment of wastewater for all sewered areas serving a *population equivalent* of 2000 or more. The effluent standard from the wastewater treatment works must not exceed 25 mg/l of BOD, 35 mg/l of suspended solids and 125 mg/l of COD. The minimum removal is 70 to 90% of BOD and 75% of COD. The Directive states the maximum permitted number of samples that are allowed to fail (e.g. 9 samples in a 100). Where the effluent is being discharged to more *sensitive areas*, limits on total phosphorus and nitrogen in the effluent are included and the minimum removal is 80% of P and 70 to 80% of N. For PE up to 100 000, the discharge standard for more sensitive areas is 2 mg/l of P and 15 mg/l of N. Over 100 000 PE, the standard is 1 mg/l of P and 10 mg/l of N. Where the effluent is being discharged to less sensitive areas, only *primary treatment* may be required.

**urea, CO(NH<sub>2</sub>)<sub>2</sub>** Urine contains about 2 to 5% of urea, although it is rarely found except in fresh domestic wastewater, because it changes to ammonia in water.

**urease** An *enzyme* possessed by some bacteria, which converts *urea* to ammonia.

**USCOLD** The US Commission on Large Dams, a body that is particularly interested in safety in dams in the USA. *See ICOLD.*

**USDOT** US Department of Transport.

**USEPA** The US Environmental Protection Agency which was formed in 1973 to oversee the prevention of pollution of air, water and land in the USA. It is involved in drinking water standards, wastewater effluent standards, air pollution control, noise, solid waste, hazardous waste, etc.

**USEPA Contaminant Candidate List** *See Drinking Water Contaminant Candidate List.*

**USPHS** The US Public Health Service.

**UV, ultraviolet radiation** UV light is in the range 100–400 nm. UV wavelengths between 280 to 320 nm are known as UVB. They cause redness and burning of the skin. UVA rays (320 to 400 nm) can penetrate deep into the skin and may produce long term damage such as skin cancer. UV radiation breaks down many organic molecules and it can be used for destroying pathogenic organisms. A wavelength of 254 nm is usually used. Water absorbs UV radiation and so the maximum depth of irradiation should be less than 120 mm. Turbidity and colour also reduces the penetration of the UV radiation into the water. Disinfection with UV radiation is used in small-scale water supplies. It is a popular choice for wastewater effluent or stormwater disinfection.

**UV/ozone process, UV/H<sub>2</sub>O<sub>2</sub> process, H<sub>2</sub>O<sub>2</sub>/ozone process** A chemical oxidation technique using a combination of two processes to enhance the overall ability to oxidise contaminants. It can be used to oxidise chlorinated *VOCs* or other organics present in hazardous waste or contaminated waters. H<sub>2</sub>O<sub>2</sub> is hydrogen peroxide.



**vaccination of water** See *stabilisation* (1).

**vacuum breaker** In a water supply system, a valve that closes under positive pressure and allows in air under negative pressure.

**vacuum filter** A horizontal shaft, continuously rotating drum with filter cloth or metal coil stretched around it, subjected to vacuum inside the drum. The lower 25 to 40% of the drum is submerged in the fluid being filtered or dewatered. Rotation is slow, at 2 to 9 rev/min allowing a cake of sludge to form outside the cloth. There are several methods of discharging the cake, with, e.g. drum type filters having the cloth attached all the way round the drum, discharging by pressure blowback just ahead of the knife discharge. String discharge filters use strings about 1.3 cm apart passing around most of the drum but departing from it at the top over discharge rolls to carry the cake away from the drum. Belt type filters use a continuous woven cloth or metal belt which acts as the filter medium but it also is led away from the drum to discharge and washing rolls. This facility for continuously washing the cloth reduces *blinding*. Coil type filters use two layers of stainless steel coil springs which leave the drum in the same way as on the belt filter. The two layers are then separated and the cake discharges from the upper layer. The coils are washed and re-applied to the drum by grooved aligning rolls. Vacuum filters may reduce wastewater sludge to about 80% water. **Conditioning** with suitable

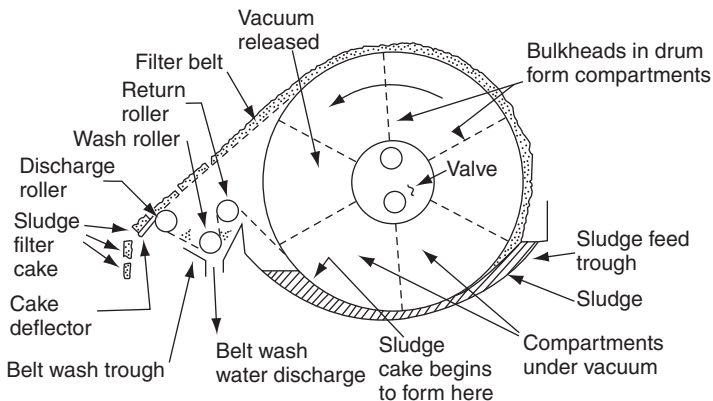

**Figure V.1** Vacuum filter with a continuous filter belt.

chemicals is normally essential. The effluent from the filter is highly polluting. Vacuum filters are used in many industries besides wastewater sludge treatment. Sometimes a series of vertical rotating discs (disc filter) replaces the horizontal cylinder. The discs are faced with nylon cloth and a knife discharges the cake from them. They have a high surface area for a given cost but are little used for dewatering water or wastewater sludge.

**vacuum flotation** A flotation tank in which a partial vacuum is maintained.

Water or wastewater saturated with air enters the tank and the partial vacuum causes minute bubbles to come out of solution thereby allowing flotation of solids. *Compare dissolved air flotation.*

**vacuum latrine** A type of flush toilet with a negative pressure in the sewer to suck the wastewater down. A flush of only 1 or 2 litres is thus possible instead of the 9 litres usual for WCs and drains do not have to slope at the *self cleansing gradient*.

**vacuum sewers** The use of vacuum pumps to enable wastewater to flow along sewers that do not have sufficient head to allow for gravity flow. The wastewater from a household flows by gravity to a holding tank where the wastewater can enter the vacuum sewer via a valve that enables the vacuum to be maintained in the sewer. In general, vacuum sewers are an expensive option compared to pumping the wastewater.

**vacuum vehicle, gulley tanker** A tanker vehicle that can be used to suck out the contents of a gulley or *septic tank* or *vault latrine* (see Figure V.2). The tanker then takes its wastewater load to an appropriate location for treatment and disposal.

**vadose water** Water in the *unsaturated zone*, suspended against the force of gravity.

**vadose zone** *Unsaturated zone.*

**valve** See *air release valve, decanting valve, isolating valve, non-return valve, plug valve, sluice valve, telescopic valve, washout valve.*

**van der Waal's forces** Forces of attraction between molecules or particles of comparable size, which can, among other things, help in *filtration*.

**vane axial cyclone** An *axial inlet cyclone*.

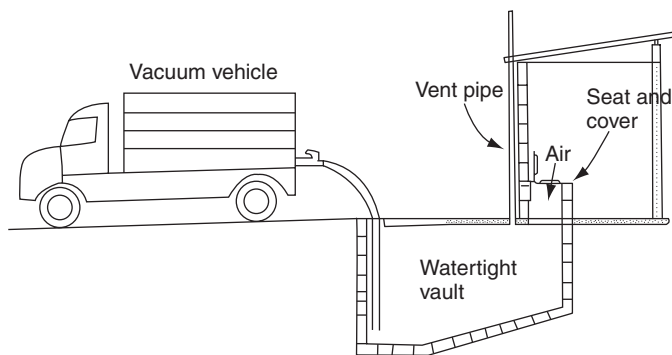

**Figure V.2** Vault latrine being emptied by a vacuum vehicle.

**vapor** The USA spelling of vapour.

**vapour extraction** See *soil vapour extraction*.

**vapour pressure** The pressure exerted by the molecules of vapour contained in air measured in kPa.

**vapour resistivity** The resistance to the passage of water vapour by 1 m<sup>2</sup> by 1 m thick of material. The vapour resistivity of concrete is 30–100 mN·s/g·m compared to 25–150 mN·s/g·m for brick and granite at 400 mN·s/g·m.

**variable volume filter press** See *membrane press*.

**vault latrine, v. toilet** A latrine or toilet with a watertight vault situated below the squatting area or toilet pan. There is no overflow from the vault and so it has to be emptied when it is becoming full. Access for emptying is from outside the property. In many low income areas in the world, particularly Asia, emptying may be undertaken by dipping a long ladle (a dipper) into the vault to scoop the contents out and put into a cart. The *cartage* system may be upgraded and mechanised by the use of *vacuum vehicles* (see *Figure V.2*).

**VCM** *Vinyl chloride monomer*.

**vector** An organism which transmits a pathogen. Vectors may be an essential part of the life cycle of some pathogens.

**vector control** Elimination or reduction of vectors of disease, for example, the removal of stagnant water can reduce the numbers of mosquitoes and mosquito borne diseases.

**vee blade scraper** A scraper for a flat bottomed *radial flow sedimentation tank* or *horizontal flow sedimentation tank*. The scraper blades are connected to form a series of about four vee shapes. The moving scraper pushes sludge which has settled on the bottom of the tank to the back of the vee, from which it is continuously removed by an *air lift pump* or a *siphon*. Sludge can be removed very quickly after it has settled but its solids concentration may be low.

**vee notch weir** (1) A vee-shaped notch in a thin plate for measuring the flow of a water. For a 90° notch, the flow,  $Q$  in m<sup>3</sup>/s, is calculated by  $Q = 1.42 H^{2.5}$ , where  $H$  is the measured head (in m) at the weir. (2) A type of *weir plate*.

**vegetated stormwater treatment facility** A *constructed wetland* used for the treatment of stormwater. Fourteen days retention during the wettest month of the year is sometimes used as the design criteria.

**vegetated submerged bed constructed wetland** See *constructed wetland*.

**vegetated swales** *Swales*.

**velocity control grit chamber** See *constant velocity grit channel*.

**velocity head** The energy per unit mass of fluid, resulting from its speed of flow. It is related to kinetic energy as follows:

$$\frac{\text{kinetic energy}}{\text{mass}} = \text{velocity head} = \frac{V^2}{2g}$$

where  $V$  is the velocity and  $g$  is the acceleration of gravity.

**ventilated improved pit latrine** See *pit latrine*.



**ventilation rates** In buildings, the rate of ventilation is often based on control of humidity and air pollutants. Buildings require, at least, background ventilation. *See air changes, humidity, indoor air pollution.*

**venting of landfill** *See gas vents.*

**vent pipe, v. stack** A vertical pipe in a building which allows ventilation of the stack or sewer. For domestic buildings less than 10 storeys the vent pipe is 40 to 50 mm diameter. The vent pipe can also be important to maintain atmospheric pressure in the sanitary pipework. Discharges of wastewater running from the upper levels of a high rise building can produce high velocities in the discharge stack and may induce lower pressures, resulting in siphonage of *water seals* from other utilities in the building. A vent pipe can assist in overcoming this problem.

**Venturi** A constriction in a pipe or channel so that the velocity of flow increases and the pressure drops.

**Venturi flume** An open channel specially shaped so that the flow in it can be calculated from the heads (depths) upstream and at the throat. If the level of the water flowing away is low enough to prevent backing up into the flume, only the upstream head needs to be measured. The upstream part of the Venturi flume converges to a narrow throat and widens out again to the usual parallel width. *Compare standing wave flume.*

**Venturi scrubber** A *wet scrubber* in which *flue gases* pass through a Venturi throat at very high speed, 60 to 100 m/s. atomising water injected at the throat to a fine spray. The spray is carried with the gases to a separator chamber where some of the water settles out with the impurities it has picked up (*see Figure V.3*). The remainder passes on to an *entrainment separator*. A pressure drop of 1 m or more water gauge may be expected in the gases but Venturi scrubbers can extract 100% of particles less than

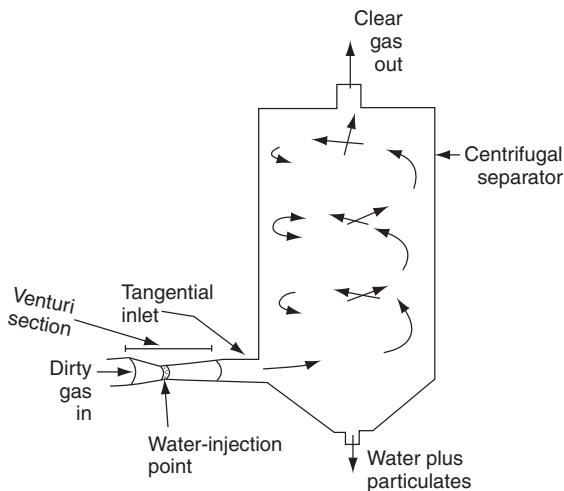

**Figure V.3** Venturi scrubber.

- 5µm. The *cut diameter* is about 0.5µm. See *cyclonic spray scrubber, ejector Venturi scrubber*.
- vermicomposting** A range of organic wastes can be composted by utilising earthworms, particularly *Eisenia foetida*. The process requires warm ambient air temperatures, otherwise the process is very slow.
- vernal slough** The sloughing off of *biofilm* from a *attached growth process* in the spring.
- vertical cell composter, v. continuous flow composter, v. cell digester, tower composter** A method for *in-vessel composting* of refuse and sludge. After segregation of the metals, plastics, etc. sludge (or water) is added to the refuse to give 40 to 55% moisture. The mixture is then fed into a vertical tower with air bubbled into the bottom of the cell. The cell may have mechanical mixing. The cell may be used to start the composting process of segregated municipal refuse, which then takes 4 to 6 weeks to finish the composting process in *windrows* or *aerated static piles*.
- vertical flow wetland** See *constructed wetland*.
- vertical shaft aerator** See *surface aerator*.
- Vexillifera* An *amoeba* in seawater that consumes *Escherichia coli*.
- VFA Volatile fatty acids.**
- viable bacteria** Bacteria that are alive and can multiply.
- vibrating screen** A *screen* for mineral or wastewater treatment, set at a slight incline to the horizontal. The water passes down through the screen with the fines. The screen is activated so that the coarse solids travel down to the lower end, where they drop off.
- Vibrio cholerae, V. comma* A bacterium that flourishes in the small intestine and causes *cholera*.
- vinyl chloride monomer, VCM, monochloroethene, monochloroethylene, CH<sub>2</sub> = CHCl** The monomer of *polyvinyl chloride* (PVC). Vinyl chloride is carcinogenic to humans. The *USEPA MCL* in drinking water is 2µg/l. The WHO guideline maximum value is 5µg/l in drinking water. The EU Drinking Water Directive gives a mandatory maximum of 0.5µg/l. Vinyl chloride is one of the *chloroethenes*.
- VIP latrine** Ventilated improved pit latrine. See *pit latrine*.
- VIP process Virginia Initiative Plant process** An adaptation of the *activated sludge* process that can achieve the *nitrification, denitrification* and *biological phosphorus removal*. The three stage process involves an anaerobic zone followed by an *anoxic* zone and finally an aerobic zone. In the process the third zone is used for BOD removal and nitrification. The return activated sludge from the sedimentation tank is fed back to the middle of the anoxic zone. The recycle from the end of the third zone back to the inlet of the second zone (see *Figure V.4*) results in the nitrate being mixed with the wastewater and return sludge in the anoxic zone and the nitrate is denitrified to nitrogen gas. The first zone is required in order to obtain biological phosphorus removal. The percentage removal can be in excess of 95% for nitrogen and 90% for phosphates.
- viricide** A chemical that kills viruses.
- virion** One *virus*, a viral cell.

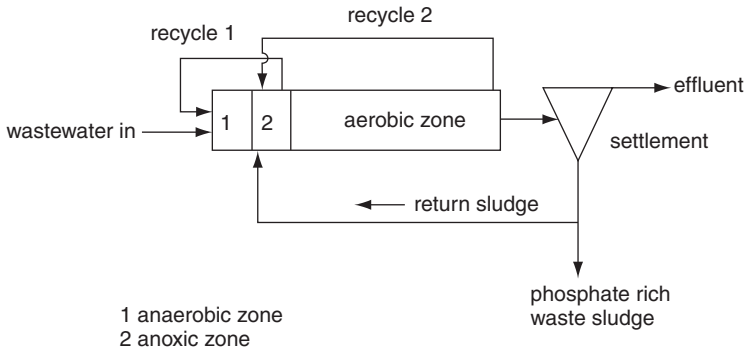

Figure V.4 VIP process, flow diagram.

**virology** The science of *viruses*.

**virus** (plural **viruses**) Important disease producing bodies smaller than bacteria. They can be from 10 to 300  $\mu\text{m}$  long (0.01 to 0.30  $\mu\text{m}$ ) and can be seen under an *electron microscope*. They are totally parasitic, depending on living cells even for reproduction, and can infect animals, plants and bacteria. They can be separated from other micro-organisms by passing through a filter with pore size of 0.45  $\mu\text{m}$  through which only viruses pass. A *virion* is nucleic acid in the core and *protein* outside. Although they reproduce in a *host* cell, they are not truly living, and are not killed but inactivated. Viral diseases include a range of human diseases such as influenza, poliomyelitis, *yellow fever*. Some can be waterborne such as *hepatitis A* and *Norwalk virus*. The *USEPA* states that treatment techniques for surface waters (or groundwater under the direct influence of surface water) to produce drinking water must remove/inactivate 99.99% of the viruses. See *inactivation of viruses*.

**viscosity** The treachiness of a fluid. Viscosity is noted as either dynamic viscosity or kinematic viscosity. The kinematic viscosity equals the dynamic viscosity divided by the density. The dynamic viscosity has units of  $\text{kg}\cdot\text{m}^{-1}\cdot\text{s}^{-1}$  or  $\text{N}\cdot\text{s}\cdot\text{m}^{-2}$  or pascal.sec. These units are equivalent because newtons (N) are units of force and one newton equals  $1\text{ kg}\cdot\text{m}\cdot\text{s}^{-2}$ . One pascal equals  $1\text{ N}\cdot\text{m}^{-2}$ . The alternative unit for dynamic viscosity is poise (P), where 1 P equals  $0.1\text{ N}\cdot\text{s}\cdot\text{m}^{-2}$ . The kinematic viscosity has units of  $\text{m}^2\cdot\text{s}^{-1}$ . The alternative unit for kinematic viscosity is stoke (st), where 1 st equals  $10^{-4}\text{ m}^2\cdot\text{s}^{-1}$ . Most fluids become less viscous when they become warmer.

**viscous flow** *Laminar flow*.

**vitrification** The heating and melting of a material that contains silica or silicates to a temperature of 1200–1500  $^{\circ}\text{C}$  or higher so that the residual solids form a glassy substance on cooling. Waste material has been treated in this manner and is sometimes known as slagging incineration or total incineration. The few contaminants that may have not been destroyed or volatilised in the heating process are immobilised in the glassy material.

It has been used in some specialist treatment of contaminated soil and in *sludge melting* for total incineration of wastewater sludge.

**vlp** Virus-like particle.

**VOC incinerator** An incinerator that is used to burn and destroy the VOCs as in a *catalytic VOC incinerator* or *thermal VOC incinerator*.

**VOCs, volatile organic compounds** Organic compounds that have a boiling point just above ambient temperatures and they therefore readily volatilise at ambient temperatures. VOCs are important in various aspects of the environmental pollution.

(1) Over 500 organics have been found as indoor air pollutants. Significant quantities of VOCs have been found in a range of buildings including schools and hospitals. Sources of VOCs include adhesives, furniture, cosmetics, dry cleaned clothes, sealants, deodorisers, polishes and stains. Although the concentration of each VOC may be low, the effects can be synergistic. One most notable VOC in indoor air pollution is *formaldehyde* which can cause irritation of eyes, nose and throat.

(2) A wide variety of sources of VOCs can produce air pollution in the outdoor air, e.g. car exhausts, paints, solvents, various wastewater treatment processes, etc. The control of VOCs from a gaseous effluent can be achieved by a variety of methods, such as adsorption onto a bed of *activated carbon* or by combustion (e.g. flares at oil refineries) or by condensation (e.g. refrigerate the gas and condense the VOCs) or by *bioscrubbers*.

(3) VOC emissions resulting from the storage of petrol (gasoline) and its distribution from terminals to service stations are controlled by the EU Directive passed in 1994. The facilities built prior to December 1995 have between 3 to 9 years to implement the VOC control. Service stations supplying less than 100 m<sup>3</sup>/yr of fuel are exempt.

(4) VOCs can be present in water and wastewaters. Their removal is usually by *air stripping*.

**Voest-Alpine process** A process for *gasification* of plastics at 1600 °C. The plastics decompose to gases which can be used as a fuel. Some inert glassy residues are formed that can be used as a fill material.

**void ratio, voids r.** The volume of the voids in a soil or filter or *trickling filter*, divided by the volume of the solids. *Compare porosity*.

**volatile acids** Organic acids generally, typically with low molecular weight—e.g. acetic, propionic and butyric acids.

**volatile fatty acids** Organic *fatty acids* that have a low molecular weight and short carbon chain. They are volatile at ambient temperatures. They include acetic, propionic and butyric acids. They are formed in the anaerobic biodegradation of complex organics (*acid fermentation*).

**volatile solids** The solids, whether dissolved or suspended solids, which can be oxidised to carbon dioxide at a temperature of 550 °C. Being organic, the ratio between them and the total solids is the organic fraction of the solids.

**volatilisation, volatilization** The movement of a chemical from liquid (or aqueous solution) to a gas. This may require heat, but some chemicals are volatile at ambient temperatures (e.g. gasoline).

- volume diameter** The diameter of a sphere possessing the same volume as the particle under consideration. *Compare Stokes diameter.*
- volumetric loading** (1) In a biological treatment system, the *organic load* per unit volume of reactor, usually expressed as kg of BOD<sub>5</sub> applied per day m<sup>3</sup> of tank, pond or filter. *Activated sludge* plants are more commonly designed on *F:M ratio*. (2) *Hydraulic loading* (1).
- volute** In a *centrifugal pump* the volute is the spiral casing surrounding the *impeller*. The volute centrifugal pump has no *diffuser* passages and can therefore pass some solids. It is best suited to pumping large volumes against low heads.
- vortex** Swirling fluid.
- vortex air cleaner, vortex box** A *straight through cyclone*.
- vortex finder** In a cyclone *dust arrestor*, the tube projecting from the cylinder at the top as an outlet for the clean air; or in a *wet cyclone*, for the clean water; or in a *dense medium cyclone*, for the 'floats'.
- vortex grit separator** A conical grit separating tank with the apex of the tank downwards. It is used in wastewater *preliminary treatment*. The appropriate velocity in the tank may be maintained by power driven rotating paddles (see Figure V.5) or by the design velocity of the incoming wastewater. This

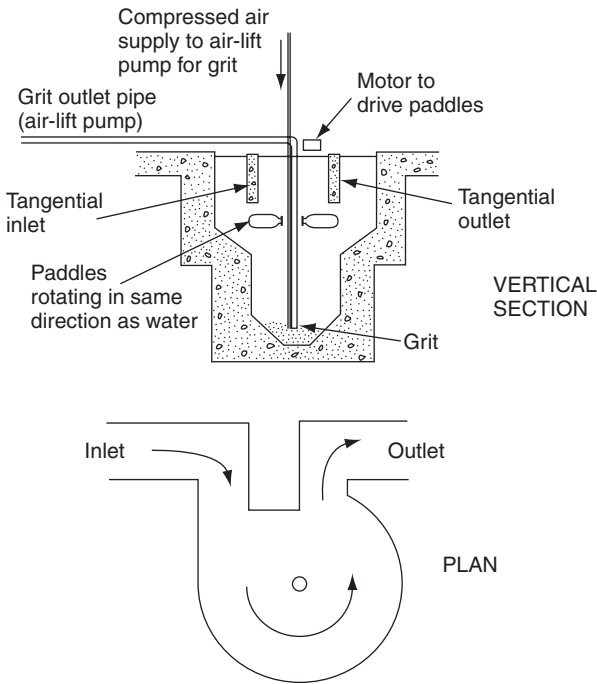

**Figure V.5** Vortex grit separator, Pista or Jeta design.

keeps the organic material in suspension while allowing the grit to settle.

The grit is lifted from the bottom of the tank by an *air lift pump*.

**vortex grit washer** A *wet cyclone* separator used for washing grit.

**vortex incinerator** An *incinerator* without a *grate*, originally developed by the US Bureau of Mines for burning waste paper. It is a vertical cylinder into which the combustion air is blown tangentially above the burning material. The air spirals down to it and then rises up the middle of the cylinder as in a *cyclone*, carrying with it all the ash and some still burning material.

**Vorticella** A stalked *ciliate protozoon*. Its presence usually indicates that an *activated sludge* is in good condition. It may also occur in *trickling filters* or in organic polluted streams.

**V<sub>p</sub>** Percolation value *See soil percolation test*.

**VSS, volatile suspended solids** *See MLVSS, volatile solids*.



---

**waffle bottom anaerobic digester** An anaerobic digestion tank built egg shaped which aims to reduce the need for cleaning. The digester forms steep sides in the ‘waffle’ at the bottom which facilitates the removal of grit.

**wall collection devices** See *impingement separator*.

**Wallingford tables, HR Wallingford tables, Barr and HR Wallingford tables**

A set of tables giving solutions to the *Colebrook-White formula* for flows in pipes, sewers and channels. The most recent additions are the Barr and HR Wallingford tables.

**Warburg respirometer** A type of *respirometer*. See *Figure R.5*.

**washing of sludge** *Elutriation*.

**wash load** Suspended *sediment load*, consisting of particles smaller than those in the river bed, usually washed into the stream by rain. It travels downstream until a slow flowing area is reached, and is there dropped.

**washout** In air pollution, removal of particles or gases by collision with descending raindrops. Compare *rainout*.

**washout valve, scour v.** A valve provided at a low point in a main which allows debris to be flushed out at a point where the waste water can conveniently drain away. Compare *air valve, scouring sluice*.

**wash water** (1) The water used for *backwashing* deep bed filters, the mesh of *microstrainers*, etc. In *tertiary treatment of wastewater* effluents backwashing water is usually returned to the works inlet or to the primary *sedimentation* tanks, which increases the quantity of sludge. In waterworks, backwash water is allowed to settle in *wash water recovery tanks*. (2) Any water used for cleaning an industrial process.

**wash water recovery tank** A tank where dirt in the *wash water* settles out and the top water is recovered to pass through the water treatment plant again, while the sludge is removed for thickening and dewatering.

**wash water trough** Troughs are provided above the filter sand or anthracite in *rapid gravity filters*, etc. to remove *wash water*. The troughs should be about 0.5 m above the level of the *medium* when it has settled. This allows for expansion of the bed during *backwashing* and ensures that media is not lost with wash water.

**waste arisings** The waste that is generated.

**waste audit** An audit that may be undertaken by an industrialist to identify the source and quantity of the waste streams and establish the mechanisms for waste minimisation. Later audits evaluate the progress of waste minimisation.

**waste compactor** (1) A *steel wheeled compactor*. (2) *On site compactor*.

**waste derived fuel, WDF** *Refuse derived fuel.*

**waste disposal unit** A *garbage grinder.*

**Waste Management Papers, WMP** A series of documents published in the UK that gives code of practice for various waste management techniques.

In particular, WMP no 26 is a series of documents on landfilling of waste and WMP no 27 deals with the management of landfill gas.

**waste minimisation, w. minimization** *See waste reduction.*

**waste recycling, w reclamation** Collection, separation and processing of waste so that it is reusable. Glass, plastics, paper and a range of metals may be recycled. In developed countries the recycling of solid waste is often undertaken by the householder who separates the waste into different bins or bags (*separation at source*) which are then collected at the kerb side. Bottles, paper, plastics and cans may be recycled via containers that are positioned as appropriate at various localities in the community or at a local *drop off centre*. The sorting and recycling of mixed domestic waste may be undertaken at a *materials recycling facility*. *Pyrolysis* and *composting* are indirect ways of recycling the waste. The extent of recycling in developing countries is high. Much of the metals, plastics or other recyclable material that has any local value is used by someone in the poorer economic community, possibly by the mixed deposited waste being sorted by individuals at the landfill site. *See aluminium recycling, glass recycling, Packaging and Packaging Waste Directive 1994, paper recycling, plastics recycling, rubber tyres.*

**waste reduction, w. minimisation, w. minimization** Reduction of the waste generated at the source as opposed to *waste recycling* which is after the waste has been generated.

**waste re-use** The re-use of packaging of a product, such as the re-use of glass bottles.

**waste segregation, w. separation** *See drop off centre, waste recycling, separation at source.*

**Waste Shipment Regulations 1994** The EU Regulation that controls the movement of waste, within, into or out of the EU. The Regulation divides wastes into *green list waste, amber list waste* and *red list waste*. In the UK this Regulation is enacted in the *Transfrontier Shipment of Wastes Regulation 1994*.

**waste sludge** *See wastewater sludge, water works sludge.*

**waste stabilisation (or stabilization) pond, s. pond, lagoon, oxidation p.** A pond or lagoon that receives wastewater which is treated by sedimentation and the actions of algae and bacteria. This treatment method is common in warm climates where land is cheap and plentiful. It can offer a low cost treatment of wastewater with simple operation. A typical wastewater treatment scheme using waste stabilisation ponds may consist of *anaerobic ponds* followed by *facultative ponds* (*see Figure F.2*) followed by *maturation ponds*. *See also aerated lagoon, high rate anaerobic pond, sludge lagoon.*

**waste to energy plants, WTE plants** Incinerators, such as *mass burn incinerators*, that use waste as a fuel and include *heat recovery*, which is used to generate electricity or for district heating systems. The incinerator furnace



has water filled tubes to recover the heat as steam. WTE plants can generate about 600 kWh per tonne of waste.

**waste treatment** See *solid waste treatment, wastewater treatment*.

**wastewater** Water that has been used. In urban areas it is a mixture of the wastewater from households, offices and industrial effluents. The organic strength of a wastewater is measured by the **BOD** or **COD**. Other important characteristics include ammonia, nitrate and phosphate content. Numerous pathogens are present in domestic wastewaters.

**wastewater biosolids** *Wastewater sludge*.

**wastewater collection** See *sewer*.

**wastewater disinfection, w. effluent d.** *Disinfection* of wastewater effluent is used to significantly reduce the pathogens in the effluent. It is not sterilisation, which is the destruction of all microscopic life. The disinfection of effluents from wastewater treatment works discharging to coastal bathing waters in the EU countries is now common because of the implementation of the *Bathing Water Directive (1976)*. The practice is also common in many countries outside the EU and the USA has undertaken disinfection of wastewater effluents for many years. The disinfection technique must be effective against pathogens but safe after dosing for disposal of the effluent to the receiving water. Although chlorine is commonly used as a water disinfectant, it is less desirable as a wastewater disinfectant because the *chlorine residual* can adversely affect the receiving water. *UV radiation* is a popular choice for wastewater effluent disinfectants. *Ozone* is also successfully used. Other techniques include *microfiltration* and *peroxyacetic acid*. See *chlorination, disinfection by-products*.

**wastewater engineering** Engineering of the *sewerage* system and the *wastewater treatment* and disposal, including the treatment and disposal of the sludge that is produced. It includes wastewaters from domestic premises and *industrial wastewater management*.

**wastewater reclamation** The treatment of wastewater so that it can be reused. *Land treatment* can be used to reclaim a wastewater effluent for *wastewater re-use*. *Artificial recharge* of groundwater with wastewater effluent is a form of reclamation since the groundwater is later pumped out as raw water.

**wastewater recycling** The re-use of the wastewater by collecting and directly reusing the water for the same or similar purpose. An industrialist may recycle the water in order to minimise the cost of water usage.

**wastewater re-use** The use of treated wastewater for beneficial uses such as irrigation or piped into house for use in toilet flushes. This is non-potable re-use. For some crops, a limiting factor for re-use in crop irrigation can be that domestic wastewater is salty. For *direct re-use* into the consumable water supply, wastewater requires extensive extra treatment. See *indirect re-use, wastewater reclamation*.

**wastewater sludge** Solids settled out from wastewater, but still containing a high percentage of water. It is also known as biosolids. The sludge may be from settling of the raw wastewater or from the biomass produced during biological treatment. See *activated sludge, digested*

*sludge, humus sludge, mixed sludge, primary sludge, raw sludge, secondary sludge.*

**wastewater sludge treatment** Raw wastewater sludge is highly malodorous.

The two major routes for the treatment are shown in *Figures W.1* and *W.2*, although other routes exist. The route of **mechanical dewatering, heat drying** and **incineration** is widely used in many countries. In the other route, **anaerobic sludge digestion** renders the sludge relatively odour free and safe to dispose onto agricultural land (*see land application of sludge*) or to **landfill**, depending on the quality of the stabilised sludge. Although anaerobic sludge digestion is the most common method for sludge stabilisation, **aerobic digestion**, such as **composting**, may be used. Less common is the chemical method of **lime stabilisation**. The treatment and disposal of sludge can account for 40% of the cost of wastewater treatment.

**wastewater treatment** Domestic wastewater is 99% water and so its treatment is to remove much of the 1% pollutants as economically as possible. A generalised flow diagram for the treatment of domestic wastewater is shown in *Figure W.3*. **Screens** and **grit removal** are known as **preliminary treatment**. This is followed by **primary treatment** (i.e. **primary sedimentation**) which removes about 50 to 70% of suspended solids and about 30% of BOD from domestic wastewater. This is followed by **secondary treatment** (i.e. **aerobic biological treatment**) to remove the remaining organic solids that are not removed in primary treatment together with the 90% or more of the dissolved organics. Further improvements in the effluent quality can be obtained by **tertiary treatment** or **advanced wastewater treatment**. The treatment and disposal of the sludge that is produced is a further part of the overall treatment process. *See industrial wastewater management, wastewater disinfection, wastewater sludge treatment.*

**waste way, w. weir** A **spillway** (overflow channel) over a dam.

**Water Act, 1989** UK legislation, which applied only to England and Wales, which paved the way for the sale of the utility functions of the then water authorities to the private sector. It provided for terms of appointment and financial arrangements for new limited companies to provide water and wastewater services. The Act established the **National Rivers Authority** as environment regulator and provided for the appointment of a Director General of Water Services (**OFWAT**) responsible for the economic regulation of the water industry. The Act also established a new statutory framework for the control of drinking water quality, river water quality and other standards. In particular the Water Companies were required to supply wholesome drinking water in compliance with the **Water Supply (Water Quality) Regulations 1989**.

**water balance of landfill** *See leachate production* and *Figure L.6*.

**water bloom** **Bloom**.

**waterborne disease** Many infectious diseases are carried by water. Pathogenic organisms excreted by humans or animals may pass via water to other humans. Diseases carried by drinking water kill five million babies annually and make one-sixth of the world population ill. In London as recently as 1854, when the population was only 2.5 million, 10 000 died of **cholera** in one year

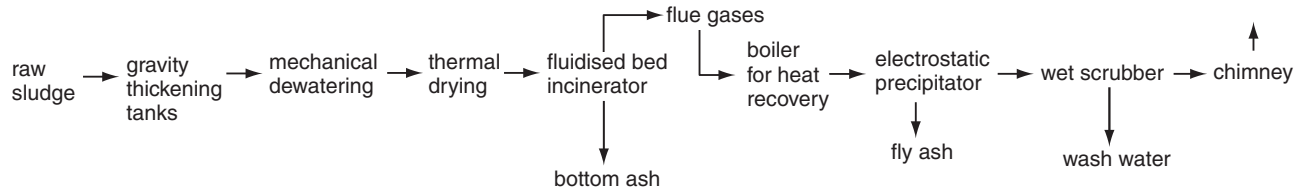

**Figure W.1** Wastewater sludge treatment by dewatering, drying and incineration, flow diagram.

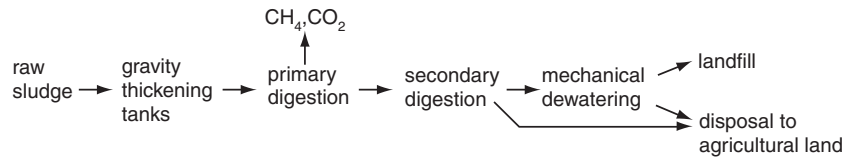

**Figure W.2** Wastewater sludge treatment by digestion and land disposal, flow diagram.

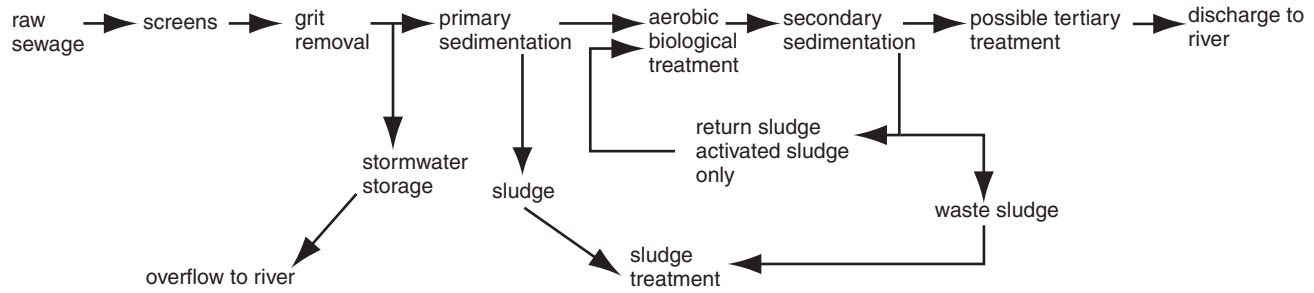

**Figure W.3** Wastewater treatment, flow diagram.

- because of a polluted well in Broad Street. Waterborne diseases include *ascariasis*, *amoebic meningoencephalitis*, *cholera*, *cryptosporidiosis*, *dysentery*, *giardiasis*, *hepatitis*, *leptospirosis*, *paratyphoid*, *salmonellosis*, *shigellosis*, *tularaemia*, *typhoid*. The main defences against waterborne disease are *water treatment*, including *disinfection*, and proper sanitation. See *water related diseases*.
- water bugs, Hemiptera** A family of winged insects. Different species have widely different tolerance to pollution.
- water bylaws** In the UK a range of bylaws that indicate the correct and incorrect methods of installing plumbing in a building. They contain procedures for avoiding *back siphonage*, contamination of stored water, damage to pipes by frost, etc. They include appropriate material for pipes, their correct jointing, installation of valves, etc.
- water conservation** The preservation, control and development of water resources above and below ground, the prevention of pollution, etc.
- water consumption** See *water demand*.
- water cycle** *Hydrological cycle*.
- water demand** In developed countries, the consumption of fresh water for domestic usage can vary from 300 l/d or more per capita in hot climates to 200 l/d per capita in temperate climates. In developing countries, the demand is the same in wealthy districts but reduces down to as little as 40 l/d or less per capita in very poor districts. The demand varies throughout the day and can vary with the season, economic growth or decline and population growth or decline. In water supply, the topic of *demand management* is becoming increasingly important.
- water distribution network modelling** Computer programs can be used to design and analyse water distribution systems by using a set of mathematical equations that describe the flow and pressure of water in the pipeline network. The model will include flow from storage tanks, reservoirs, and wells throughout the distribution area together with a range of other information specific to the distribution network.
- Water Environment Federation, WEF** The main USA technical and educational organisation that is involved in research, publication and training on wastewater treatment, water quality protection, pollution control, hazardous waste, residuals management, and groundwater. It was previously known as the Water Pollution Control Federation.
- Water Framework Directive, 2000** (Framework for Community action in the field of water policy) An extensive EU Directive which enhances the legislation for the protection of surface waters and ground waters within the EU. It includes new requirements for the adoption of river basin management plans which include mapping of surface waters and groundwaters; estimation of point and diffuse pollution; results of monitoring programmes; the controls on water abstraction and pollution discharges. A list of environmental quality objectives (EQOs) must be given together with the measures needed to meet these EQOs. The Directive defines the status of rivers, lakes, *transitional waters*, coastal waters. Rivers in the EU are to be classified in four general classifications; high status, good status, moderate status and poor (or bad) status. The objective of achieving

'good' water status must be pursued. Classifications are to be based on the ecological, *hydromorphological* and physico-chemical parameters. *Phytoplankton, macrophytes, phytobenthos, benthic invertebrates* and fish are used in assessing the ecological status in rivers and lakes. The monitoring regime for these waters is also defined. Groundwater quality status is defined in terms of abstraction rate and chemical quality, together with the monitoring regime. The Directive establishes a strategy to harmonise the emission of certain substances to the aquatic environment. These are known as *priority substances* and *priority hazardous substances* (see *Table P.1*) which must be phased out from discharges within a defined time period (e.g. 20 years).

**water gauge** A water filled U-tube, a *manometer* applied to gas or air flows.

**water grid** A network of several bulk water supplies, such that a supply to an area may come from lakes, reservoirs or rivers, depending on the availability and quality of each at the time.

**water hammer** *Pressure surge in pipe flow.*

**water hog, w. louse** *Asellus aquaticus.*

**water hyacinth, *Eichhornia crassipes*** A floating plant that can double in numbers every 10 days but will not grow much at any temperature below 10°C. Thus, in warm climates, nearly 18 tonnes per day per hectare of wet vegetation can be produced from domestic wastewater. This is about 212 tonnes per year dry. This plant also absorbs the salts of *heavy metals*. It needs a warm climate and is a catastrophic weed in warm, slow flowing rivers such as the Nile, the Congo or the Mississippi. The plant has been used in *floating aquatic plant treatment systems*.

**Water Industry Act, 1991** UK legislation, which applies to England and Wales only, and relates to the appointment of water and sewerage undertakers, the conditions of appointment, supply of water and provision of sewerage services. The Act also sets out the functions of the Director General of Water Services.

**water jetting** A method for the internal cleansing of pipelines using high pressure water jets, to clean walls and flush debris.

**water leakage** *See leakage.*

**water main rehabilitation** *Water pipe rehabilitation.*

**water metering** In many developed countries over 60% of water usage is unmetered. The use of water meters for industrial supplies is common but to reduce water demand, water metering of private supplies is becoming more common.

**water pipeline failures** Failure of water pipelines can be structural failure (e.g. bursts), hydraulic failures (e.g. lack of flow or pressure) or failure of water quality due to deterioration of the pipe material. Failure is often a combination of age of pipe, overstressing and environmental conditions rather than due to a single catastrophic event. The causes of failure and leakage may be poor pipe manufacture, careless installation, superimposed loads, soil movement (loss of support or bedding), excess internal pressures or chemical attack on pipe both internally and externally. Pipe joints are often the weakest points and are more prone to failure. *See pin holes, pipe barrel failures.*

**water pipe cleaning** Cleaning of a water main can use high pressure water (jetting). Prior to rehabilitation, mechanical cleaning methods are common, such as *rack feed boring* or *drag scraping*. *Pressure scraping* is also used.

**water pipe inspection techniques** Visual inspection of the pipe is possible if it is uncovered. Investigations *in situ* are more difficult. See *fibrescope*, *closed circuit television*.

**water pipe rehabilitation, w. p. refurbishment, w. p. renewal** A range of techniques are available for *in situ* pipe rehabilitation or renewal, such as *cement mortar lining*, *close fit lining*, *epoxy lining*, *rolldown*, *pipe bursting*, *sliplining*, *soft lining*, *swagelining*.

**Water Pollution Control Federation** See *Water Environment Federation*.

**water pressure** See *pressure management*.

**water protection zone** In the UK, an area the Environment Agency has restricted or prohibited specific activities in order to control pollution of the natural waters in that area.

**Water Quality Act, WQA** USA legislation passed in 1987 that produced stricter regulations for wastewater treatment and wastewater sludge treatment and disposal.

**Water Quality Index, WQI** A chemical index of water pollution that measures a range of parameters in the natural water and produces a score describing the quality. Parameters chosen may include dissolved oxygen, BOD<sub>5</sub>, pH, ammonia, nitrate, chloride, phosphates suspended solids, temperature and coliform bacteria. In several versions of WQIs the overall value lies between 10 (i.e. highly polluted) and 100 (i.e. exceptional clean), See *biotic index*, *river classification*.

**water quality standards** See *bathing water*, *drinking water standards*, *irrigation*, *swimming pool water*.

**water reclamation** See *wastewater reclamation*.

**water related diseases** Various infectious diseases which are not strictly water-borne but water is needed for its transmission. Examples include *dengue*, *filariasis*, *malaria*, *onchocerciasis*, *schistosomiasis* and *yellow fever*. The vectors of these diseases may flourish in rivers and lakes and water management schemes may influence their prevalence.

**Water Resources Act, 1991** UK legislation, affecting England and Wales only, concerning the maintaining and enhancing of the quality of "controlled waters", the setting of statutory water quality objectives, the regulation of discharges to natural waters, the definition of (water) pollution offences, defences and penalties, and the provision of Public Registers. Those sections of the Act covering the functions of the *National Rivers Authority* were repealed following the abolition of the NRA in 1996 and the establishment of the *Environment Agency*.

**water re-use** See *wastewater re-use*.

**water seal** A water seal of 50 mm is required in the drainage from a toilet, sink, bath, shower, etc. in order to isolate the atmosphere in the sewer from the air in the building. The loss of water seal from a trap gives a pathway for odours from the sewer to enter the building. The loss may occur due to self



siphonage or induced siphonage (i.e. suction). If a property is not in use for some period the water seal may be lost due to evaporation.

**watershed** (1) The line between two *catchments*, therefore a summit line, also known as a divide. (2) A *catchment* area.

**water side** Description of the surface of a boiler tube or drum that is in contact with steam or water, not the *fire side*.

**water softening** Removal of *hardness* from water. The calcium and magnesium ions can be removed by chemical precipitation. Alternatively, cation *ion exchange resins* can be used to exchange the calcium and magnesium for sodium ions. Ion exchange resins that exchange other cations for hydrogen ions, produce an acid water, because the bicarbonates, sulphates and chlorides become carbonic acid, sulphuric acid and hydrochloric acid. However, by mixing this with hard water all the bicarbonates in the raw water can be removed and the acids in the softened water are neutralised—e.g.

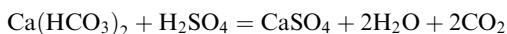

The carbon dioxide can be removed by aeration. This process reduces the *carbonate hardness* to zero, although some *non-carbonate hardness* remains. See *demineralisation, excess lime softening, lime soda softening, lime softening, sodium restricted diet*.

**water springtail** *Springtail*.

**water storage tanks** See *cistern*.

**water supply sizing pipes** The flow in water pipes in building is often intermittent and it depends on usage of the facilities. In the UK, the sizing of water pipes in buildings uses *loading units* (as described in BS 6700) or *demand units* (as described by *CIBSE*). Both systems relate to the *equivalent pipe length*, the head and either the loading or demand units for each part of the building. Charts are then used to give a pipe size.

**water supply in developing countries** In the world, 20% of the urban population and 50% the rural population do not have reasonable access to safe water. Urban poor may buy water of dubious quality from water vendors. In rural areas, women may spend considerable time on water collection. The benefits of access to safe water give an immediate time saving for women and, in the medium term, the health of the populace is improved. Community involvement and self help schemes are important together with hygiene education. Water supply schemes must have realistic objectives and take note of local customs and traditions. See *O and M, pot chlorinator, well pollution*.

**Water Supply (Water Quality) Regulations** The regulations that enact the EU Directive on Drinking Water in England and Wales. In Scotland, the Directive is enacted in the Water Supply (Water Quality) (Scotland) Regulations. The Regulations include the required minimum level of sampling of the water supply and the frequency of analysis for each quality parameter. The water quality data is available to the public.

**water table, saturation line, phreatic surface** The surface, which may be undulating, of the *standing water* level of an *unconfined* groundwater.

See *perched water table; compare piezometric surface*. See *Figure A.11*.

**water tower** A *service reservoir*, usually small, raised above ground.

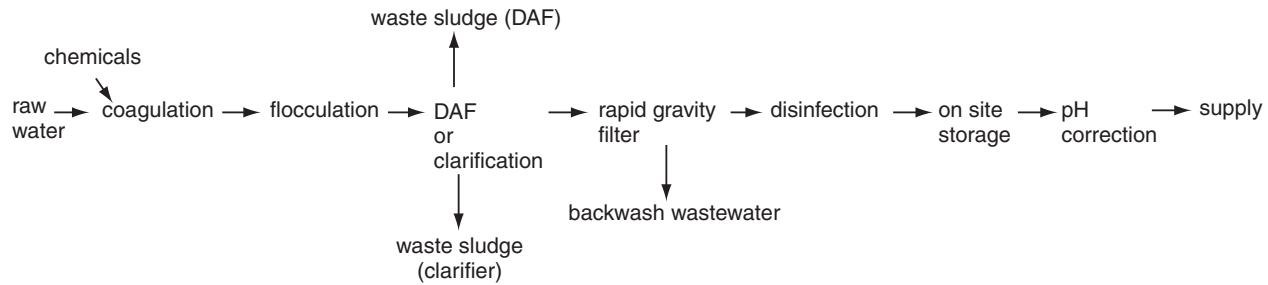

**Figure W.4** Water treatment, flow diagram.

**water treatment** (Figure W.4) *Screening*, then *coagulation*, *flocculation* and *clarification* or *dissolved air flotation*, followed by *filtration* and *disinfection*, is a typical treatment which converts raw water to drinking water. It removes colour, suspended and *colloidal* matter from reasonably clean water but cannot reduce their *salinity* without *desalination*. A *carbon adsorption bed* also may be needed. The *sedimentation* that occurs during *raw water storage* can also be regarded as part of the treatment.

**water velvet** *Azolla filiculoides*.

**water wall boiler** The part of an incinerator which has tubes of water which are heated by the hot gases generated in the incinerator. The hot water can then be used for electricity generation or district heating, i.e. a *waste to energy plant*.

**waterway** A river, canal or stream.

**waterworks** A site where raw water receives water treatment.

**waterworks sludge** The main types of waterworks sludge are the sludges from the *clarifier* or *dissolved air flotation* and the wash water from the backwashing of the *rapid deep bed filters*. Waterworks sludges from these processes are a mainly inorganic metallic hydroxide. Sludges from *water softening* are largely calcium carbonate and magnesium hydroxide, depending on the processes being used. Waterworks sludges are usually thickened and mechanically dewatered possibly using a *filter plate press*. The sludge cake is then dumped. Waterworks sludges can be more difficult to dewater than sludges from wastewater treatment. The thickening and dewatering processes may be preceded by *conditioning*. See *gravity thickening*.

**watt** A unit of electrical power, a rate of consumption of energy equal to one joule per second. If provided as heat rather than electricity, it may be written  $W_{th}$  for 'thermal watt'.

**waxes** See *lipids*.

**WDF** Waste derived fuel. See *refuse derived fuel*.

**wedge wire screen** A *screen* made of wire of wedge shaped cross-section with the thin ends of the wedges down, so that the openings enlarge downwards.

**WEF** *Water Environment Federation*.

**weighbridge, scales** A platform on which lorries or trailers, or on a railway, rail wagons can be weighed. One is provided at every *incinerator* as well as at most *landfills*.

**weighting** Many methods, in statistics, of giving higher value or weight to one or more of several numbers being averaged, thus ensuring that their greater importance is seen in the result. See *composite sample*.

**Weil's disease** *Leptospirosis*.

**weir loading, w. overflow rate, w. rate** The flow of water or wastewater from a tank per unit length of outlet weir, thus:

$$\text{weir loading} = \frac{\text{maximum flow (m}^3/\text{day)}}{\text{total length of outlet weir (m)}}$$

If the weir loading is excessive, the approach velocity of the effluent may lift the sludge from the bottom of the tank. The usual design value is  $220 \text{ m}^3$  per m per day but *sedimentation tanks* with weir loadings above

- 1000 have worked efficiently. Weir loadings have much less effect than *surface loading rates* on the efficiency of *sedimentation* tanks. *See* below.
- weir plates** Horizontal adjustable metal plates set on a *weir* to form a crest that can be accurately adjusted to level. At weir overflow rates below 100 m<sup>3</sup> per metre length of weir per day the plain horizontal weir is affected by *surface tension* and is not self-cleaning. Consequently, for lower flows than this, *vee notch* or castellated plates are usual. Such plates efficiently reduce the length of weir that is in use. A vee notch reduces the weir length more as the flow rate decreases. Vee notches should be used as outlet weirs for *sedimentation tanks* or *clarifiers*. Each notch should have a maximum depth of 35 mm. Enough notches should be provided to ensure a maximum flow per notch of 30 to 40 m<sup>3</sup>/day.
- weir rate** *See weir loading.*
- well** *See* below and *deep well, injection well, disposal well, shallow well, tube well, wet well.*
- well casing, w. lining** To prevent contamination of a water well or borehole, a steel tube, the casing, should be inserted to seal off any ground that might pollute the water. Cement grout is forced into the gap between the casing and the ground to prevent seepage of contaminants. The casing should extend above ground and the ground surface around the well head should be concreted.
- well field** An area over which wells are being used to abstract water.
- Wellman-Lord process** A *flue gas desulphurisation* system that allows regeneration of the original reagents. The sulphur dioxide reacts with sodium sulphite (Na<sub>2</sub>SO<sub>3</sub>) to form sodium bisulphite (Na<sub>2</sub>HSO<sub>3</sub>). The sodium bisulphite can be heated to reform sodium sulphite and recover sulphur dioxide in a concentrated form which has an economic value. At present this process is less economic than alternative flue gas desulphurisation processes.
- wellpointing** A series of pumped wells connected together with the aim of reducing the water table around a particular area.
- well pollution** Pollution can occur due to polluted groundwater or seepage into the well from polluted surface water. In developing countries, water may be collected from the well by individuals. Animals may be around the well drinking the spilled water. Water taken from the well can become polluted from the vessels used for collecting the water. To prevent well pollution, the wells must be protected by covers and with a concrete apron around the well. Spilled water should be drained away from the well and the well should be located away from polluted subsurface water or polluted groundwater. The area around the well should be kept clean and pleasant and reflect local customs. *See well casing.*
- well screen** Tubular mesh or sheet steel with slots in it, to admit fluids and exclude soil, inserted into an oil or gas or water well at the producing depth (horizon). In a water well a coarse gravel filter may be placed outside the screen to reduce the particles entering the well.
- well yield** *See borehole yield.*
- wet air oxidation, Zimpro process** A treatment process for wastewater sludge in order to improve its dewaterability. The sludge is heated to

150 to 250 °C and pumped, with air, into a pressure reaction vessel for about 30 minutes. Steam is injected into the reactor. Many of the organics in the sludge are hydrolysed and oxidised to CO<sub>2</sub> and water. The remaining sludge can be dewatered more easily than the raw sludge. The liquor from the dewatering is highly polluting, with high ammonia concentrations. The process generates malodorous gases. Scale forms within the pressure reactor and it requires descaling regularly.

**wet arrestor, wet collector** See *wet scrubber*.

**wet classifier** Any device that separates solids in water into two or more size classes—e.g. a *screw classifier*.

**wet cyclone** (1) A *cyclone* (2) in which water is also used to assist the cleaning of the gas, as in a *cyclonic spray scrubber* or a *Venturi scrubber*. (2) or *liquid cyclone, hydrocyclone*. A cyclone (2) in which water or other liquids circulate rather than air.

**wet detention pond** *Detention basin*.

**wet-dry air pollution control, wet-dry APC** An air pollution control system that contains processes some of which use water whereas other parts of the system are dry processes. For example, the gas stream from an incinerator can be treated by passing through a *spray tower* for SO<sub>2</sub> removal followed by a *fabric filter* for removal of particles. Compared *dry-dry air pollution control*.

**wetlands** Wetlands have surface water depths of about 0.5 m. They can be used for the treatment of a wastewater, after primary sedimentation. See *constructed wetlands*.

**wetout** A *soft lining* pipeline rehabilitation technique in which resin is injected and distributed into a tube which is then installed into a pipe and cured *in situ*.

**wet pond** *Retention pond*.

**wet pulveriser, wet pulverizer, drum p.** A wet process for the reduction in the size of waste. A horizontal steel drum rotates slowly at 2 to 12 rpm. Refuse, or other waste is added together with an appropriate quantity of water. In some machines a central shaft rotating in the other direction carries arms that help to break up the material. Most types include an internal *trommel* through which the material drops out when it is small enough. Large objects pass out as oversize. Wet pulverising of refuse may be undertaken prior to composting. The smaller size of waste may compost quicker and the wet process can ensure the correct moisture content for efficient composting throughout the material. Prior sorting of the refuse to remove metals can be important for effective wet pulverising.

**wet reduction** Size reduction of materials, such as refuse, in a pulveriser that uses water, e.g. a *wet pulveriser* or a *rasp mill*.

**wet scrubber** The use of water to assist in the removal of dust particles or polluting gases, such as SO<sub>2</sub>, by contacting the dirty gas stream with liquid drops. The liquid flow divided by the gas flow is about 10<sup>-3</sup>. Wet scrubbers allow particles less than 1 μm to be collected on a 50 μm droplet of water and then use a simple technique to remove the water droplets. The pumping of water may be costly and the discharged wash water is polluted. For SO<sub>2</sub> removal, the wash water is alkaline (see *flue gas desulphurisation*). Many types of wet scrubber exist such as *baffle type scrubber, collision scrubber, cyclonic*

- spray scrubber, ejector Venturi scrubber (Figure E.1), low energy scrubber, moving bed scrubber (Figure M.4), packed bed scrubber (Figure P.1), plate tower scrubber, spray chamber (Figure S.13), Venturi scrubber (Figure V.3).* A *dry scrubber* and *semi-dry scrubber* are techniques to minimise water usage.
- wetted perimeter** The length of the wetted cross-section of an open channel.
- wetting rate** Of a *trickling filter*, the flow of fluid per day per unit plan area of the filter. *Compare hydraulic loading.*
- wet well** The part of a pumphouse that contains the liquid to be pumped. In a wet-well pumping station, the pump is submerged in the wet well with a (dry) motor room above. There is no dry well. In a dry well pumping station, the pumps are in a *dry well* and the adjoining wet well is used as a sump (storage well). The motor room is above the dry well. Wet wells should be small enough for wastewater not to become septic and for solids not to settle, yet large enough to eliminate frequent starting and stopping of pumps. Ten starts per hour is the desirable maximum for a pump.
- WFD** The *Water Framework Directive*.
- wheel cleaning, w. washing** Mud and dirt picked up by wheels of vehicles on a *landfill* site must be cleaned before the vehicle goes back onto the public roads. Automated wheel washing devices may be used.
- wheeled bins** These plastic dustbins may have from 120 to over 1000 litres of storage with a tough plastic lid. The containers are wheeled to the collection vehicle which is specially adapted to pick up and empty them.
- whipworm** *See trichuriasis.*
- white goods** Large household appliances such as refrigerators and washing machines.
- WHO guidelines for drinking water quality** *See World Health Organisation.*
- wilting coefficient, w. point** The water content of a soil, below which plants wilt and die even in damp air. It varies from about 2% of the dry weight of a coarse sand to about 15% for a clay. *See field capacity.*
- wind blown refuse** Wind blown refuse usually consists of paper and plastic and can be a problem when waste collection vehicles discharge their loads at the *landfill* site. It is important that the discharged waste is compacted as soon as possible. One option for reducing windblown refuse is the use of mobile fences around the tipping area. The refuse that accumulates on the fences must be removed regularly as the collected material builds up wind resistance and the fences blow over.
- windrowing, windrow composting** A method of *composting* in which the refuse or other waste material is piled in rows about 1 to 2 m high, 3 to 4 m wide and about 20 m long. The piles or windrows are turned regularly (once or twice a week) in order to maintain aerobic biodegradation in the waste. Domestic refuse may take over 3 months before it is fully composted and curing of the compost for several more months is then required. *See aerated static pile, in-vessel composting.*
- windrow turner** A mobile machine resembling earthmoving equipment which can turn the windrows of composting material, when driven past them. Some windrow turners also shred the refuse.

**Winkler test** The standard chemical method for determining how much oxygen is dissolved in a water or waste water. It involves adding manganese sulphate,  $\text{MnSO}_4$ , then a mixture of sodium hydroxide,  $\text{NaOH}$ , and potassium iodide,  $\text{KI}$ :

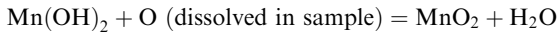
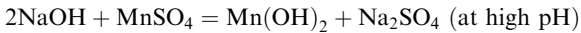

Concentrated sulphuric acid is then added:

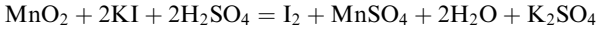

Therefore one atom of oxygen liberates one molecule of iodine,  $\text{I}_2$ .  $\text{I}_2$  is then measured by titrating against *sodium thiosulphate* with starch as an indicator. There are many modifications of the test to avoid interferences by other ions, particularly nitrite.

**wood pulp** See *paper and pulp manufacturing wastewater*.

**woollen industry wastewater** Raw wool contains many impurities and raw wool scouring therefore produces an effluent with a high content of inert and organic solids, greases and detergents. Pollution by finishing processes, including dyeing, varies with the process. Mixed wastes from raw wool scouring and finishing have a  $\text{BOD}_5$  of 500 to 2000 mg/l, pH above 9.0, and suspended solids up to 2000 mg/l.

**working face** See *advancing face*.

**World Health Organisation, WHO** Among the many tasks of the WHO, it sets guidelines for drinking water quality throughout the world. They cover physical, chemical, microbiological and radiological water quality parameters. WHO Resolution 35/17 relates to *environmental impact assessment*.

**World Water Assessment Programme, WWAP** A UN programme that aims to improve management practices and policies in water supply and freshwater resources. It focuses on assessing the developing situation as regards freshwater throughout the world. The primary output of the WWAP is the periodic World Water Development report (WWDR).

**worm diseases** *Helminthic diseases*.

**WPCF** Water Pollution Control Federation renamed the *Water Environment Federation*.

**WQA** *Water Quality Act*.

**WQI** *Water Quality Index*.

**WQO** Water quality objective. See *Statutory Water Quality Objective*.

**WRAP** Waste Resources Action Programme. A UK Government programme that aims to promote sustainable waste management and increase the recycling of waste.

**WTE plants** See *waste to energy plants*.

***Wucheria bancrofti*** A parasitic *nematode* worm that causes *wucheriasis*.

**wucheriasis** A type of *filariasis* caused by *Wucheria bancrofti*.

**WWAP** *World Water Assessment Programme*.

**WWDR** World Water Development report, see *World Water Assessment Programme*.



**xenobiotic** A synthetic chemical foreign to that environment.

**xylenes** An aromatic compound with two methyl groups ( $-\text{CH}_3$ ) attached to a benzene ring. They are used in industry for a range of purposes. They are toxic to humans giving adverse effects on the nervous system, liver and kidneys. The **USEPA MCL** in drinking water is 10 mg/l and the corresponding WHO guideline maximum value is 0.5 mg/l.





**yard waste** *Garden waste.*

**yellow fever** A viral disease that can result in haemorrhaging and jaundice.

It is transmitted by the mosquito, *Aedes aegypti*. Mortality can be as high as 50%.

**Yersinia** The bacteria *Yersinia enterocolitica* and *Y. pseudotuberculosis* can cause yersiniosis in humans, which is diarrhoea plus a range of other symptoms. The common route of transmission is **faecal-oral** via food or water. *Y. pestis* is the causative organism of the plague or black death.

This organism is harboured by rats and can be spread by rodent fleas.

**yield drawdown curve** *See specific capacity of a well.*

**yield of a water resource** There are numerous definitions of the term 'yield',

A common one is: the steady supply that could safely be maintained through a drought of a given probability. However, the safe yield is the rate at which water can be abstracted from a river or lake or groundwater so that the yield is sustainable in the long term and the overall environmental effects are minimal. *See borehole yield.*



**zeolite** Either a natural mineral or an artificial product, but always a hydrated sodium aluminium silicate which can give up its sodium in exchange for the calcium and magnesium in water, thus reducing *hardness* by *ion exchange*. When the zeolite ceases to soften the water it is 'spent', but can be regenerated by passing a strong solution of sodium chloride through it. Zeolites cannot be used for *turbid*, acid or iron-bearing waters, and *lime soda softening* may be preferable for these. See *clinoptilolite*, *ion exchange resins*, *regeneration*.

**zero discharge layout** Design of an industrial plant to release no effluent, whether *cooling water* (by *closed recirculation system*) or industrial effluent.

**zero drift** Movement of the zero point of an instrument in one direction, away from the correct zero, causing errors in all readings, although the difference between any two readings may be correct.

**zig-zag separator** An *air column separator* that is either zig-zag in shape or has baffles on alternate sides of the vertical shaft (see *Figure Z.1*).

**zinc equivalent** A number related to the contents of *copper*, *zinc* and *nickel* in sludge, which can be used to estimate the safe amounts of these metals

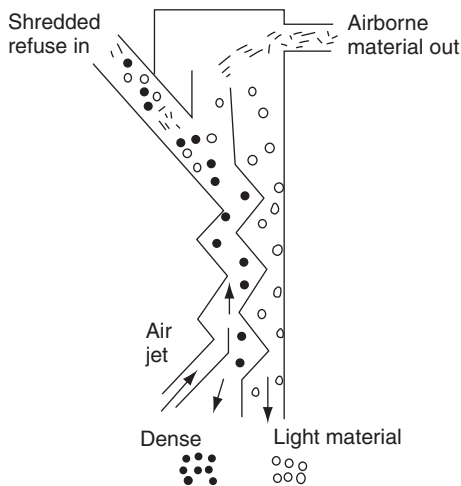

**Figure Z.1** Zig zag classifier for shredded refuse.

to be applied to the soil. The zinc equivalent should not exceed 250 mg/l and is calculated by multiplying the copper content of the sludge by 2 and the nickel content by 8, and adding them to the zinc content.

**zone of saturation** The ground below the *water table* in *groundwater* where the voids are filled with water under hydrostatic pressure.

**zone settling** See *settling regimes*.

**zones of water supply** See *pressure zones*.

**zoobenthos** Aquatic animals which live on, in, or near bottom of rivers, lakes, etc.

**zooflagellates** *Flagellate protozoa* that are not *photosynthetic*.

**zooplankton** *Plankton* that are not *photosynthetic*. They graze on *phytoplankton* which can be one of the main limitations to their numbers.

**zwitterion** A molecule which has positive and negative ions contained in its structure but has zero net charge—e.g. amino acids at the *isoelectric point*.

**zymosis** (1) *Fermentation*. (2) Reactions induced by *enzymes*.

# Appendix: Abbreviations and conversion factors of units

bhp	brake horsepower
Btu	British thermal unit
cc	cubic centimetre (millilitre)
cm	centimetre
cuft, ft <sup>3</sup>	cubic foot
d	day
dia.	diameter
fpm	feet per minute
ft	feet
g	gram (or gravity acceleration)
gal	gallon
gpm	gallon per minute
h	hour
hp	horsepower
in	inch
imp. gal.	imperial gallon
J	joule
kg	kilogram
kJ	kilojoule
km	kilometre
kN	kilonewton
kN/m <sup>2</sup>	kilonewtons per square metre
l	litre
lb	pound
m	metre (USA: meter)
m <sup>3</sup>	cubic metre
mm	millimetre
mg	milligram
mgd	million gallons per day
min	minute
ml	millilitre
MN/m <sup>2</sup>	meganewtons per square metre
Pa	pascal
psi	pounds per square inch
rpm	rev/min, revolutions per minute
s	second
sq.	square
US gal	US gallon

yd        yard  
yd<sup>3</sup>     cu yd, cubic yard

### *Length*

1 in = 25.4 mm  
1 m = 39.37 in = 3.281 ft  
1 mile = 5280 ft = 1760 yd = 1.609 km = 1609 m  
1 international sea mile (nautical mile) = 1852 m = 1.151 miles  
1 fathom = 6 ft = 1.829 m

### *Area*

1 in<sup>2</sup> = 645 mm<sup>2</sup> = 6.45 cm<sup>2</sup>  
1 m<sup>2</sup> = 10.76 ft<sup>2</sup> = 1.196 yd<sup>2</sup>  
1 are = 100 m<sup>2</sup> = 119.6 yd<sup>2</sup>  
1 km<sup>2</sup> = 10 000 ares = 100 hectares  
1 acre = 4840 yd<sup>2</sup> = 0.4047 hectare  
1 mile<sup>2</sup> = 640 acres = 2.59 km<sup>2</sup>

### *Volume*

1 US gal = 0.833 imp. gal. = 3.785 litres  
1 imp. gal = 4.546 litres = 1.201 US gal  
1 acre-foot = 43560 ft<sup>3</sup> = 1234 m<sup>3</sup>  
1 m<sup>3</sup> = 1000 litres = 35.31 ft<sup>3</sup> = 1.308 yd<sup>3</sup> = 264 US gal (220 imp. gal)  
1 ft<sup>3</sup> = 0.02831 m<sup>3</sup> = 28.31 litres = 7.48 US gal (6.23 imp. gal)  
1 imp. gal of water weighs 10 lb (4.54 kg)  
62.4 lb of water occupy 1 ft<sup>3</sup>  
1 litre of water weighs 1 kg and occupies 0.264 US gal (0.22 imp. gal)

### *Weight*

1 lb = 16 ounces = 7000 grains = 454 g  
1 long ton (UK ton) = 20 hundredweight (cwt) = 2240 lb = 1016 kg  
1 short ton (US ton) = 2000 lb = 2 kilopounds  
1 tonne (metric ton) = 1000 kg = 2200 lb

### *Heat and Energy*

1000 joules = 1 kJ = 0.948 Btu  
1 Btu/ft<sup>3</sup> = 37.26 kJ/m<sup>3</sup>  
1 MJ/m<sup>3</sup> = 4.31 Btu/imp. gal = 3.59 Btu/US gal  
1 Btu/lb = 2.324 kJ/kg  
1 joule = 1 newton-metre = 1 watt-second = 1 pascal-cubic metre  
1 kw-h = 3600 kJ  
1 Btu = 0.252 kg-calorie = 1055 joules  
1 Btu/s = 1.055 kW  
1 kg-m = 7.22 ft-lb = 9.81 joules

1 hp = 746 watts = 76 kg-m/sec = 550 ft-lb/sec  
1 metric hp = 75 kg-m/sec = 0.987 US and British hp.  
°C = degrees Celsius, formerly degrees Centigrade  
°F = degrees Fahrenheit = (1.8 × °C) + 32  
K (Kelvin) = °C + 273.15

#### *Velocity, Flow and Hydraulic Loadings*

1 m/h = 3.281 ft/h = 0.0547 ft/min = 0.409 US gal/ft<sup>2</sup> · min  
1 m<sup>3</sup>/s (cumec) = 35.31 ft<sup>3</sup>/s (cusec) = 2119 ft<sup>3</sup>/min  
= 220 imp. gal/s = 19.0 million imp. gal/day  
= 264 US gal/s = 22.8 million US gal/day  
1 m<sup>3</sup>/d = 264 US gal/day  
1 m<sup>3</sup>/m = 67.1 imp. gal/ft = 80.5 US gal/ft  
1 m<sup>3</sup>/m<sup>2</sup> = 20.45 imp. gal/ft<sup>2</sup> = 184 imp. gal/yd<sup>2</sup> = 890 000 imp. gal/acre  
= 24.54 US gal/ft<sup>2</sup> = 221 US gal/yd<sup>2</sup> = 1.069 million US gal/acre  
= 3.281 ft<sup>3</sup>/ft<sup>2</sup>  
1 m<sup>3</sup>/ha = 107 US gal/acre  
1 m<sup>3</sup>/m<sup>3</sup> = 0.161 ft<sup>3</sup>/imp. gal = 168 imp. gal/yd<sup>3</sup> = 6.22 imp. gal/ft<sup>3</sup>  
= 0.134 ft<sup>3</sup>/US gal = 202 US gal/yd<sup>3</sup> = 7.47 US gal/ft<sup>3</sup>

#### *Mass Loadings and Concentrations*

1 kg/m = 0.672 lb/ft  
1 kg/m<sup>2</sup> = 0.205 lb/ft<sup>2</sup>  
1 kg/hectare = 0.892 lb/acre  
1 tonne/hectare = 0.446 US tons/acre  
1 mg/litre = 1 g/m<sup>3</sup> = 1000 µg/l  
= 8.345 lb/million US gal = 10 lb/million imp. gal  
1 kg/m<sup>3</sup> = 1 g/litre = 1000 mg/litre = 0.0624 lb/ft<sup>3</sup> = 1.69 lb/yd<sup>3</sup>  
= 8.345 lb/10<sup>3</sup> US gal = 8345 lb/Mgal (US)  
1 grain/ft<sup>3</sup> = 2.288 g/m<sup>3</sup>  
In air 1 mole of a gas at standard temperature and pressure occupies 22.4 litres (0.0224 m<sup>3</sup>)  
Therefore, for air pollution,

$$1 \mu\text{g}/\text{m}^3 = \frac{\text{concentration in ppm} \times \text{molecular weight of substance}}{0.0224}$$

#### *Pressure*

1 pascal (Pa) = 1 newton per sq. metre (N/m<sup>2</sup>) = 0.000145 psi  
1 megapascal (MPa) = 1 million Pa = 1 MN/m<sup>2</sup> = 10 bar  
= 145 psi = 0.065 ton/in<sup>2</sup> = 10.2 kg/cm<sup>2</sup>  
1 'technical atmosphere' = 1 kg/cm<sup>2</sup> = 14.2 psi = 10 m head of water  
1 'standard atmosphere' = 760 mm mercury at 0 °C  
= 101.3 kPa = 1013 millibar = 14.7 psi  
1 psi = 6895 Pa (N/m<sup>2</sup>) = 0.069 bar

This Page Intentionally Left Blank