

*Ionic Liquids in Synthesis*. Edited by Peter Wasserscheid, Thomas Welton  
Copyright © 2002 Wiley-VCH Verlag GmbH & Co. KGaA  
ISBNs: 3-527-30515-7 (Hardback); 3-527-60070-1 (Electronic)

*P. Wasserscheid and T. Welton (Eds.)*  
**Ionic Liquids in Synthesis**

*Ionic Liquids in Synthesis*. Edited by Peter Wasserscheid, Thomas Welton  
Copyright © 2002 Wiley-VCH Verlag GmbH & Co. KGaA  
ISBNs: 3-527-30515-7 (Hardback); 3-527-60070-1 (Electronic)

### **Related Titles from WILEY-VCH**

P.G. Jessop and W. Leitner (eds.)

#### **Chemical Synthesis Using Supercritical Fluids**

1999. 500 pages.  
Hardcover.  
ISBN 3-527-29605-0

F. Zaragoza Dörwald (ed.)

#### **Organic Synthesis on Solid Phase Supports, Linkers, Reactions**

2nd Edition,  
2002. ca. 580 pages.  
Hardcover.  
ISBN 3-527-30603-X

A. Loupy (ed.)

#### **Microwaves in Organic Synthesis**

2002. ca. 350 pages.  
Hardcover.  
ISBN 3-527-30514-9

K. Tanaka (ed.)

#### **Solvent-free Organic Synthesis**

2003. ca. 300 pages.  
Hardcover.  
ISBN 3-527-30612-9

*Ionic Liquids in Synthesis*. Edited by Peter Wasserscheid, Thomas Welton  
Copyright © 2002 Wiley-VCH Verlag GmbH & Co. KGaA  
ISBNs: 3-527-30515-7 (Hardback); 3-527-60070-1 (Electronic)

*P. Wasserscheid and T. Welton (Eds.)*

## **Ionic Liquids in Synthesis**

 **WILEY-VCH**

*Ionic Liquids in Synthesis*. Edited by Peter Wasserscheid, Thomas Welton  
Copyright © 2002 Wiley-VCH Verlag GmbH & Co. KGaA  
ISBNs: 3-527-30515-7 (Hardback); 3-527-60070-1 (Electronic)

**Volume Editors**

**Dr. Peter Wasserscheid**

RWTH Aachen  
Institute for Technical and  
Macromolecular Chemistry  
Worringer Weg 1  
52074 Aachen  
Germany

**Dr. Thomas Welton**

Imperial College of Science,  
Technology and Medicine  
Department of Chemistry  
South Kensington  
London SW7 2AY  
UK

This book was carefully produced. Nevertheless, editors, authors and publisher do not warrant the information contained therein to be free of errors. Readers are advised to keep in mind that statements, data, illustrations, procedural details or other items may inadvertently be inaccurate.

**Library of Congress Card No.: applied for**

A catalogue record for this book is available from the British Library.

**Bibliographic information published by  
Die Deutsche Bibliothek**

Die Deutsche Bibliothek lists this publication in the Deutsche Nationalbibliografie; detailed bibliographic data is available in the Internet at <http://dnb.ddb.de>

© 2003 WILEY-VCH Verlag  
GmbH & Co. KGaA, Weinheim  
All rights reserved (including those of translation in other languages). No part of this book may be reproduced in any form – by photoprinting, microfilm, or any other means – nor transmitted or translated into machine language without written permission from the publishers. Registered names, trademarks, etc. used in this book, even when not specifically marked as such, are not to be considered unprotected by law.

Printed in the Federal Republic of  
Germany.

Printed on acid-free paper.

**Typesetting** Hagedorn Kommunikation,  
Viernheim

**Printing** Strauss Offsetdruck GmbH,  
Mörlenbach

**Bookbinding** J. Schäffer GmbH & Co. KG,  
Grünstadt

**ISBN** 3-527-30515-7



## Contents

	<b>Preface</b>	<i>XI</i>
	<b>Contributors</b>	<i>XV</i>
<b>1</b>	<b>Introduction</b>	<i>1</i>
<b>2</b>	<b>Synthesis and Purification of Ionic Liquids</b>	<i>7</i>
2.1	Synthesis of Ionic Liquids	<i>7</i>
2.1.1	Introduction	<i>7</i>
2.1.2	Quaternization Reactions	<i>9</i>
2.1.3	Anion-exchange Reactions	<i>12</i>
2.1.3.1	Lewis Acid-based Ionic Liquids	<i>12</i>
2.1.3.2	Anion Metathesis	<i>14</i>
2.1.4	Purification of Ionic Liquids	<i>17</i>
2.1.5	Conclusions	<i>19</i>
2.2	Quality Aspects and Other Questions Related to Commercial Ionic Liquid Production	<i>21</i>
2.2.1	Introduction	<i>21</i>
2.2.2	Quality Aspects of Commercial Ionic Liquid Production	<i>22</i>
2.2.2.1	Color	<i>23</i>
2.2.2.2	Organic Starting Materials and other Volatiles	<i>24</i>
2.2.2.3	Halide Impurities	<i>25</i>
2.2.2.4	Protic Impurities	<i>26</i>
2.2.2.5	Other Ionic Impurities from Incomplete Metathesis Reactions	<i>26</i>
2.2.2.6	Water	<i>27</i>
2.2.3	Upgrading of Commercial Ionic Liquids	<i>27</i>
2.2.4	Scaling-up of Ionic Liquid Synthesis	<i>28</i>
2.2.5	HSE data	<i>29</i>
2.2.6	Future Price of Ionic Liquids	<i>30</i>
2.2.7	Intellectual Property Aspects Regarding Ionic Liquids	<i>31</i>
2.3	Synthesis of Task-specific Ionic Liquids	<i>33</i>

<b>3</b>	<b>Physicochemical Properties of Ionic Liquids</b>	<b>41</b>
3.1	Melting Points and Phase Diagrams	41
3.1.1	Introduction	41
3.1.2	Determination of Liquidus Ranges	43
3.1.2.1	Melting points	43
3.1.2.2	Upper limit decomposition temperature	44
3.1.3	Effect of Ion Sizes on Salt Melting Points	45
3.1.3.1	Anion size	46
3.1.3.2	Mixtures of anions	47
3.1.3.3	Cation size	48
3.1.3.4	Cation symmetry	49
3.1.4.1	Imidazolium salts	50
3.1.4.2	Imidazolium substituent alkyl chain length	50
3.1.4.3	Branching	52
3.1.5	Summary	53
3.2	Viscosity and Density of Ionic Liquids	56
3.2.1	Viscosity of Ionic Liquids	56
3.2.1.1	Viscosity measurement methods	56
3.2.1.2	Ionic liquid viscosities	59
3.2.2	Density of Ionic Liquids	65
3.2.2.1	Density measurement	66
3.2.2.2	Ionic liquid densities	66
3.3	Solubility and Solvation in Ionic Liquids	68
3.3.1	Introduction	68
3.3.2	Metal Salt Solubility	70
3.3.2.1	Halometalate salts	70
3.3.2.2	Metal complexes	70
3.3.3	Extraction and Separations	72
3.3.3.1	Anionic extractants	73
3.3.3.2	Organic extractants	73
3.3.4	Organic Compounds	75
3.3.5	Conclusions	79
3.4	Gas Solubilities in Ionic Liquids	81
3.4.1	Introduction	81
3.4.2	Experimental Techniques	83
3.4.2.1	Gas solubilities and related thermodynamic properties	83
3.4.2.2	Stoichiometric technique	84
3.4.2.3	Gravimetric technique	85
3.4.2.4	Gas chromatography	85
3.4.3	Gas Solubilities	86
3.4.3.1	Water vapor	86
3.4.3.2	Other gases	88
3.4.4	Applications	89
3.4.4.1	Reactions involving gases	89
3.4.4.2	Gas separations	90

3.4.4.3	Extraction of solutes from ionic liquids with compressed gases or supercritical fluids	91
3.4.5	Summary	91
3.5	Polarity	94
3.5.1	Chromatographic Measurements	94
3.5.2	Absorption Spectra	96
3.5.3	Fluorescence Spectra	99
3.5.4	Refractive Index	99
3.5.5	Organic Reactions	100
3.5.5.1	Alkylation of sodium 2-naphthoxide	100
3.5.5.2	Diels–Alder reactions	100
3.5.5.3	Photochemical reactions	101
3.5.6	General Conclusions	102
3.6	Electrochemical Properties of Ionic Liquids	103
3.6.1	Electrochemical Potential Windows	104
3.6.2	Ionic Conductivity	109
3.6.3	Transport Properties	118
<b>4</b>	<b>Molecular Structure and Dynamics</b>	<b>127</b>
4.1	Order in the Liquid State and Structure	127
4.1.1	Neutron Diffraction	127
4.1.2	Formation of Deuteriated Samples	128
4.1.3	Neutron Sources	129
4.1.3.1	Pulsed (spallation) neutron sources	129
4.1.3.2	Reactor sources	129
4.1.4	Neutron Cells for Liquid Samples	130
4.1.5	Examples	131
4.1.5.1	Binary mixtures	131
4.1.5.2	Simple salts	133
4.1.6	X-ray Diffraction	134
4.1.6.1	Cells for liquid samples	135
4.1.6.2	Examples	135
4.1.7	Extended X-ray Absorption Fine-structure Spectroscopy	139
4.1.7.1	Experimental	140
4.1.7.2	Examples	142
4.1.8	X-ray Reflectivity	145
4.1.8.1	Experimental set-up	146
4.1.8.2	Examples	146
4.1.9	Direct Recoil Spectrometry (DRS)	147
4.1.9.1	Experimental set-up	148
4.1.9.2	Examples	149
4.1.10	Conclusions	149
4.2	Quantum Mechanical Methods for Structure Elucidation	152
4.2.1	Introduction	152
4.2.3	Ion-pair Models and Possible Corrections	153

VIII | Contents

- 4.2.4 Ab Initio Structures of Ionic Liquids 154
- 4.2.5 DFT Structure of 1-Methyl-3-nonylimidazolium Hexafluorophosphate 155
- 4.2.6 Additional Information Obtained from Semi-empirical and Ab Initio Calculations 156
- 4.3 Molecular Dynamics Simulation Studies 157
- 4.3.1 Performing Simulations 157
- 4.3.2 What can we Learn? 159
- 4.4 Translational Diffusion 162
- 4.4.1 Main Aspects and Terms of Translational Diffusion 162
- 4.4.2 Use of Translational Diffusion Coefficients 164
- 4.4.3 Experimental Methods 165
- 4.4.4 Results for Ionic Liquids 166
- 4.5 Molecular Reorientational Dynamics 168
- 4.5.1 Introduction 168
- 4.5.2 Experimental Methods 168
- 4.5.3 Theoretical Background 169
- 4.5.4 Results for Ionic Liquids 171
  
- 5 Organic Synthesis 174**
- 5.1 Stoichiometric Organic Reactions and Acid-Catalyzed Reactions in Ionic Liquids 174
- 5.1.1 Stoichiometric Organic Reactions 175
- 5.1.1.1 Molten salts as reagents 175
- 5.1.1.2 Reactions in chloroaluminate(III) and related ionic liquids 177
- 5.1.1.3 Reactions in neutral ionic liquids 181
- 5.1.2 Acid-Catalyzed Reactions 191
- 5.1.2.1 Electrophilic substitutions and additions 191
- 5.1.2.2 Friedel–Crafts alkylation reactions 196
- 5.1.2.3 Friedel–Crafts acylation reactions 203
- 5.1.2.4 Cracking and isomerization reactions 208
- 5.2 Transition Metal Catalysis in Ionic Liquids 213
- 5.2.1 Why use Ionic Liquids as Solvents for Transition Metal Catalysis? 217
- 5.2.1.1 Their nonvolatile natures 217
- 5.2.1.2 New opportunities for biphasic catalysis 218
- 5.2.1.3 Activation of a transition metal catalyst in ionic liquids 220
- 5.2.2 The Role of the Ionic Liquid 220
- 5.2.2.1 The ionic liquid as “innocent” solvent 221
- 5.2.2.2 Ionic liquid as solvent and co-catalyst 221
- 5.2.2.3 Ionic liquid as solvent and ligand/ligand precursor 222
- 5.2.2.4 Ionic liquid as solvent and transition metal catalyst 225
- 5.2.3 Methods of Analysis of Transition Metal Catalysts in Ionic Liquids 226
- 5.2.4 Selected Examples of the Application of Ionic Liquids in Transition Metal Catalysis 229
- 5.2.4.1 Hydrogenation 229

5.2.4.2	Oxidation reactions	232
5.2.4.3	Hydroformylation	234
5.2.4.4	Heck, Suzuki, Stille, and Negishi coupling reactions	241
5.2.4.5	Dimerization and oligomerization reactions	244
5.2.5	Concluding Remarks	252
5.3	Ionic Liquids in Multiphasic Reactions	258
5.3.1	Multiphasic Reactions: General Features, Scope, and Limitations	258
5.3.2	Multiphasic Catalysis: Limitations and Challenges	259
5.3.3	Why Ionic Liquids in Multiphasic Catalysis?	261
5.3.4	Different Technical Solutions to Catalyst Separation through the Use of Ionic Liquids	263
5.3.5	Immobilization of Catalysts in Ionic Liquids	266
5.3.6	Scaling up Ionic Liquid Technology from Laboratory to Continuous Pilot Plant Operation	270
5.3.6.1	Dimerization of alkenes catalyzed by Ni complexes	271
5.3.6.2	Alkylation reactions	275
5.3.6.3	Industrial use of ionic liquids	277
5.3.7	Concluding Remarks and Outlook	278
5.4	Multiphasic Catalysis with Ionic Liquids in Combination with Compressed CO <sub>2</sub>	281
5.4.1	Introduction	281
5.4.2	Catalytic Reaction with Subsequent Product Extraction	282
5.4.3	Catalytic Reaction with Simultaneous Product Extraction	282
5.4.4	Catalytic Conversion of CO <sub>2</sub> in an Ionic Liquid/scCO <sub>2</sub> Biphasic Mixture	283
5.4.5	Continuous Reactions in an Ionic Liquid/Compressed CO <sub>2</sub> System	283
5.4.6	Concluding Remarks and Outlook	287
<b>6</b>	<b>Inorganic Synthesis</b>	<b>289</b>
6.1	Directed Inorganic and Organometallic Synthesis	289
6.1.1	Coordination Compounds	289
6.1.2	Organometallic Compounds	290
6.1.3	Other Reactions	292
6.1.4	Outlook	293
6.2	Making of Inorganic Materials by Electrochemical Methods	294
6.2.1	Electrodeposition of Metals and Semiconductors	294
6.2.1.1	General considerations	294
6.2.1.2	Electrochemical equipment	295
6.2.1.3	Electrodeposition of less noble elements	297
6.2.1.4	Electrodeposition of metals that can also be obtained from water	300
6.2.1.5	Electrodeposition of semiconductors	303
6.2.2	Nanoscale Processes at the Electrode/Ionic Liquid Interface	305
6.2.2.1	General considerations	305
6.2.2.2	The scanning tunneling microscope	305
6.2.2.3	Results	306
6.2.3	Summary	316

x | Contents

<b>7</b>	<b>Polymer Synthesis in Ionic Liquids</b>	<b>319</b>
7.1	Introduction	319
7.2	Acid-catalyzed Cationic Polymerization and Oligomerization	320
7.3	Free Radical Polymerization	324
7.4	Transition Metal-catalyzed Polymerization	326
7.4.1	Ziegler–Natta Polymerization of Ethylene	326
7.4.2	Late Transition Metal-catalyzed Polymerization of Ethylene	327
7.4.3	Metathesis Polymerization	328
7.4.4	Living Radical Polymerization	329
7.5	Preparation of Conductive Polymers	331
7.6	Conclusions	332
<b>8</b>	<b>Biocatalytic Reactions in Ionic Liquids</b>	<b>336</b>
8.1	Introduction	336
8.2	Biocatalytic Reactions and their Special Needs	336
8.3	Examples of Biocatalytic Reactions in Ionic Liquids	339
8.3.1	Whole-cell Systems and Enzymes other than Lipases in Ionic Liquids	339
8.3.2	Lipases in Ionic Liquids	342
8.4	Conclusions and Outlook	345
<b>9</b>	<b>Outlook</b>	<b>348</b>
	<b>Index</b>	<b>356</b>

## Preface

*"We prided ourselves that the science we were doing could not, in any conceivable circumstances, have any practical use. The more firmly one could make that claim, the more superior one felt."*

*The Two Cultures*, C.P. Snow (1959)

A book about ionic liquids? Over three hundred pages? Why? Who needs it? Why bother? These aren't simply rhetorical questions, but important ones of a nature that must be addressed whenever considering the publication of any new book. In the case of this one, as two other books about ionic liquids will appear in 2002, the additional question of differentiation arises – how is this distinctive from the other two? All are multi-author works, and some of the authors have contributed to all three books.

Taking the last question first, the answer is straightforward but important. The other two volumes are conference proceedings (one of a NATO Advanced Research Workshop, the other of an ACS Symposium) presenting cutting-edge snapshots of the state-of-the-art for experts; this book is *structured*. Peter Wasserscheid and Tom Welton have planned an integrated approach to ionic liquids; it is detailed and comprehensive. This is a book designed to take the reader from little or no knowledge of ionic liquids to an understanding reflecting our best current knowledge. It is a teaching volume, admirable for use in undergraduate and postgraduate courses, or for private learning. But it is not a dry didactic text - it is a user's manual! Having established a historical context (with an excellent chapter by one of the fathers of ionic liquids), the volume describes the synthesis and purification of ionic liquids (the latter being crucially important), and the nature of ionic liquids and their physical properties. Central to this tome (both literally and metaphorically) is the use of ionic liquids for organic synthesis, and especially green organic synthesis, and this chapter is (appropriately) the largest, and the *raison d'être* for the work. The book concludes with much shorter chapters on the synthesis of inorganic materials and polymers, the study of enzyme reactions, and an overview and prospect for the area. This plan logically and completely covers the whole of our current knowledge of ionic liquids, in a manner designed to enable the tyro reader to feel confident in using them, and the expert to add to their understanding. This is the first book to

attempt this task, and it is remarkably successful for two reasons. Firstly, the volume has been strongly and wisely directed, and is unified despite being a multi-author work. Secondly, the choice of authors was inspired; each one writes with authority and clarity within a strong framework. So, yes, this book is more than justified, it is a crucial and timely addition to the literature. Moreover, it is written and edited by the key people in the field.

Are ionic liquids really green? A weakly argued letter from Albrecht Salzer in *Chemical and Engineering News* (2002, 80 [April 29], 4-6) has raised this nevertheless valid question. Robin Rogers gave a tactful, and lucid, response, and I quote directly from this: "Salzer has not fully realized the magnitude of the number of potential ionic liquid solvents. I am sure, for example, that we can design a very toxic ionic liquid solvent. However, by letting the principles of green chemistry drive this research field, we can ensure that the ionic liquids and ionic liquid processes developed are in fact green. [. . .] The expectation that real benefits in technology will arise from ionic liquid research and the development of new processes is high, but there is a need for further work to demonstrate the credibility of ionic liquid-based processes as viable green technology. In particular, comprehensive toxicity studies, physical and chemical property collation and dissemination, and realistic comparisons to traditional systems are needed. It is clear that while the new chemistry being developed in ionic liquids is exciting, many are losing sight of the green goals and falling back on old habits in synthetic chemistry. Whereas it is true that incremental improvement is good, it is hoped that by focusing on a green agenda, new technologies can be developed that truly are not only better technologically, but are cleaner, cheaper, and safer as well."

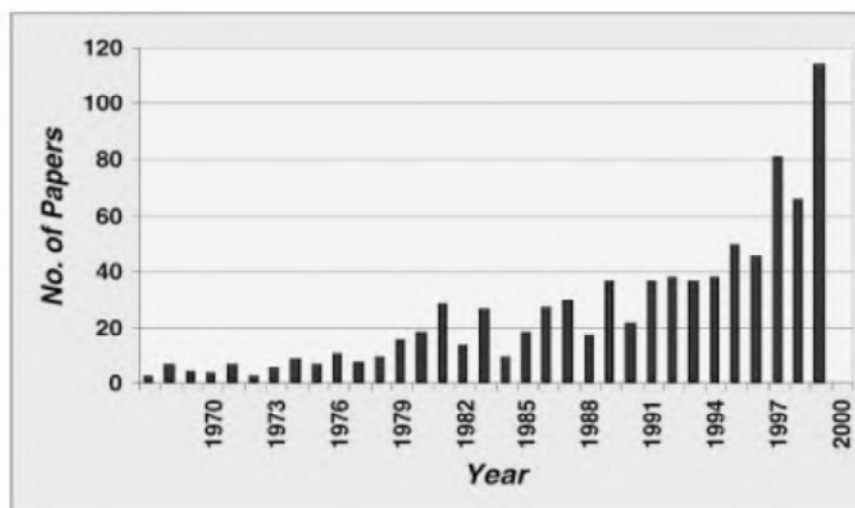

Figure 1: The rise in publications concerning ionic liquids as a function of time, as determined using SciFinder.



Robin's response is insightful. It reflects, in part, the burgeoning growth of papers in this area (see Figure 1) combined with the inevitable (and welcomed) rise in new researchers entering the area. However, with increasing activity comes the inevitable increasing "garbage" factor. In recent years we have (unfortunately) seen papers reporting physical data on ionic liquids that were demonstrably impure, liquids reported as solids and solids reported as liquids because of the impurity level, communications "rediscovering" and publishing work (without citation) already published in the patent literature, the synthesis of water-sensitive ionic liquids under conditions that inevitably result in hydrolysis, and academically weak publications appearing in commercial journals with lax refereeing standards. I truly believe that this book will help combat this; it should, and will, be referred to by all workers in the field. Indeed, if the authors citing it actually read it too, then the garbage factor should become insignificantly small!

In conclusion, this volume reflects well the excitement and rapid progress in the field of ionic liquids, whilst effectively providing an invaluable hands-on instruction manual. The lacunae are emphasised, and the directions for potential future research are clearly signposted. Unlike Snow in his renowned *Two Cultures* essay, many of us (Mamantov, Osteryoung, Wilkes, and Hussey, to name but a few of the founding fathers) who entered this area in its early (but not earliest!!) days prided ourselves that the science we were doing could not fail to have a practical use. Whether that use was battery applications, fuel cells, electroplating, nuclear reprocessing, or green industrial synthesis, we all believed that ionic liquids (or room-temperature molten salts, as they were then commonly known) offered a unique chemical environment that would (*must*) have significant industrial application. Because of this, we suffered then (and to some extent now) from the disdain of the "pure" scientists, who failed (and still fail) to appreciate that, if selecting an example to study to illustrate a fundamental scientific principle, there is actually some merit in selecting a product manufactured at the one million ton per annum level, rather than an esoteric molecule of no use and even less interest. Unfortunately, the pride and superiority Snow refers to is still alive and well, and living in the hearts of some of the academic establishment. I believe that this book will help tackle this prejudice, and illustrate that useful practical applications and groundbreaking fundamental science are not different, opposing areas, but synergistic sides of the same coin.

K.R. Seddon  
May, 2002

## A note from the editors

This book has been arranged in several chapters that have been prepared by different authors, and the reader can expect to find changes in style and emphasis as they go through it. We hope that, in choosing authors who are at the forefront of their particular specialism, this variety is a strength of the book. The book is intended to be didactic, with examples from the literature used to illustrate and explain. Therefore, not all chapters will give a comprehensive coverage of the literature in the area. Indeed, with the explosion of interest in some applications of ionic liquids comprehensive coverage of the literature would not be possible in a book of this length. Finally, there is a point when one has to stop and for us that was the end of 2001. We hope that no offence is caused to anyone whose work has not been included. None is intended.

## Acknowledgements

We would like to sincerely thank everyone who has been involved in the publication of this book. All of our authors have done a great job in preparing their chapters and it has been a pleasure to read their contributions as they have come in to us. When embarking on this project we were both regaled with stories of books that never saw the light of day because of missed deadlines and the general tardiness of contributors. All of our colleagues have met their commitments in the most timely and enthusiastic manner. We are truly grateful for them making our task so painless. We would also like to thank the production team at VCH-Wiley, particularly Dr. Karen Kriese.

Finally, in a project like this, someone must take responsibility for any errors that have crept in. Ultimately we are the editors and this responsibility is ours. So we apologise unreservedly for any mistakes that have found their way into the book.

P. Wasserscheid, T. Welton  
August, 2002

## Contributors

Prof. Dr. Joan F. Brennecke  
Department of Chemical Engineering  
University of Notre Dame  
Notre Dame, IN 46556

Prof. James H. Davis, jr.  
Department of Chemistry  
University of South Alabama  
Mobile, Alabama 36688  
USA

Dr. Martyn J. Earle  
School of Chemistry  
The Queen's University of Belfast  
Stranmills Road  
Belfast BT9 5AG, Northern Ireland

Dr. Frank Endres  
Institut für Physikalische Chemie  
Universität Karlsruhe  
D-76128 Karlsruhe

PD Dr. Andreas Dölle  
Institut für Physikalische Chemie  
RWTH Aachen  
D-52056 Aachen  
Germany

Dr. Charles M. Gordon  
University of Strathclyde  
Department of Pure and  
Applied Chemistry  
Thomas Graham Building  
295 Cathedral Street  
Glasgow G1 1XL  
Scotland, UK

Prof. Dr. David M. Haddleton  
University of Warwick  
Department of Chemistry  
Coventry CV4 7AC  
U.K.

Dr. Chris Hardacre  
Physical Chemistry  
School of Chemistry  
The Queen's University of Belfast  
Stranmillis Road  
BELFAST BT9 5AG  
Northern Ireland

Dr. Claus Hilgers  
Solvent Innovation GmbH  
Alarichstraße 14-16  
D-0679 Köln  
Germany

xvi | *Contributors*

Dr. John Holbrey  
Department of Chemistry  
The University of Alabama  
Tuscaloosa, AL 35487  
jholbrey@bama.ua.edu

Prof. Dr. Udo Kragl  
Technische Chemie,  
Universität Rostock  
Fachbereich Chemie  
Buchbinderstr. 9  
D-18051 Rostock

Dr. Hugh C. de Long  
Department of Chemistry  
US Naval Academy  
572 Holloway RD  
Annapolis, MD 21402-5026  
USA

Dr. H el ene Olivier-Bourbigou  
Division cinetique a Catalyse  
Institut Francais du Petrole  
129 Av. DeBois-Preau  
92852 Rueil-Malmaison, France

Prof. Dr. Robin D. Rogers  
Professor of Chemistry  
Director, Center for  
Green Manufacturing  
Department of Chemistry  
The University of Alabama  
Tuscaloosa, AL 35487

Prof. K. R. Seddon  
Chair of Inorganic Chemistry  
School of Chemistry  
The Queen's University of Belfast  
Stranmillis Road  
BELFAST BT9 5AG  
Northern Ireland

Dr. Paul C. Trulove  
AFOSR/NL  
801 North Randolph Street  
Arlington, VA 22203-1977  
USA

Dr. Peter Wasserscheid  
Institut f ur Technische Chemie und  
Makromolekulare Chemie der  
RWTH Aachen  
Worringer Weg 1  
D-52074 Aachen  
Germany

Dr. Tom Welton  
Department of Chemistry  
Imperial College  
London SW7 2AY UK

Prof. John S. Wilkes  
Department of Chemistry  
2355 Fairchild Drive, Suite 2N255  
USAF, Colorado 80840-6230  
USA

## Index

### a

- ab initio method 153 ff.
  - acetate 5, 64
  - acetylation 208
  - acetylation reaction 204 ff.
  - acidity 43
  - activation energy 164
  - acylation 291, 343 ff.
  - addition reaction 191, 193
  - alkanesulfonate 99
  - alkylammonium 2, 94, 96, 137
    - chloride 2, 137
    - nitrate 2, 96
    - sulfonate 96
    - thiocyanate 96
  - alkylation 9, 24 f., 29, 77, 89, 100, 185, 193, 196, 198 ff., 201 ff., 264, 270, 275, 277
  - 1-alkylimidazole 9, 11, 327
  - alkylimidazolium 59, 111, 123, 189
  - 1-alkylimidazolium 9
    - chloride 9
    - nitrate 9
    - tetrafluoroborate 9
  - 1-alkyl-3-methylimidazolium [RMIM] 9, 11 f., 16 f., 24, 43 ff., 50 ff., 73 ff., 128, 136 ff., 146 ff., 149, 328
    - bis(trifluoromethylsulfonyl)imide 51, 52, 73
    - bromide 52
    - chloride 52
    - halide 11, 16
    - hexafluorophosphate 52, 74, 146 ff., 328
    - tetrachloroaluminate 52
    - tetrachloropalladate 146
    - tetrafluoroborate 51 ff., 146, 149
    - triflate 52
  - alkylphosphonium 137
  - alkylpyridinium 4
  - 1-alkylpyridinium 9, 12, 135, 138, 145
    - alkylsulphate 138
    - chloride 145
  - allylation 187
  - allylic alkylation 252
  - allylic substitution 252
  - aluminium 295, 297 ff., 302, 306 ff., 309 ff., 312
  - aluminium chloride 3, 12, 17, 33, 43, 47, 52, 70, 108 ff., 117 ff., 131, 135, 143 ff., 177 ff., 180 ff., 192, 194, 196 ff., 201 ff., 210, 215, 224 ff., 228, 245 ff., 266, 273, 275 ff., 278, 290 ff., 299, 306 ff., 309 ff., 319 ff., 322 ff., 327 ff., 331 f.
  - amidation 340
  - amine 36
  - 1-(3-aminopropyl)imidazole 35 ff.
  - ammonium 34 ff., 39, 42, 46, 100, 107, 136, 200
    - halide 100
  - anion exchange 8
  - antimony 298, 300 ff., 304 ff.
  - Arrhenius equation 164, 170
  - arsenic 298, 304
  - aza-Diels-Alder reaction 183
- ### b
- battery 2, 5, 45, 70, 103, 298, 350, 353
  - Beckmann rearrangement 189
  - Beer-Lambert relationship 140
  - benzenesulfonate 240
  - benzimidazolium 138
  - benzoylation 208
  - Berson's W scale 100
  - Biginelli reaction 190
  - binary mixture 47

- biocatalysis 336 ff., 339, 342, 345, 353  
 biocatalyst 338, 343, 346  
 biotransformation 336 ff., 340, 345  
 biphasic reaction 190  
 biphasic system 69 ff., 72, 77  
 bis(trifluoromethylsulfonyl)imide  
   15, 30, 33, 35, 44, 47, 53, 64, 66, 76, 107, 114, 137, 221  
 Born-Landé equation 45  
 Bragg's law 134  
 bromide 5, 104, 107, 137, 242  
 bromoaluminate 66, 131  
 Brønsted acid 191, 196  
 Brønsted superacid 18  
 buffered ionic liquid 109  
 butylation 198  
 1-butyl-3-ethyl-imidazolium [BEIM]  
   61, 64, 66, 113  
   – bis(trifluoromethylsulfonyl)imide 61, 113  
   – mesylate 61, 113  
   – triflate 61, 113  
   – trifluoroacetate 61, 113  
 1-butylimidazole 35  
 1-butyl-3-methylimidazolium [BMIM]  
   16, 18 ff., 25 ff., 29, 37, 53, 59, 61 f., 64 ff., 73 ff., 77 ff., 84, 86 ff., 96 ff., 99 f., 104, 106, 113, 115, 144 ff., 149, 154, 163 ff., 166 f., 171 ff., 181, 183, 185 ff., 190 ff., 194 ff., 201 ff., 207 ff., 215 ff., 218, 223, 225 ff., 229 ff., 234 ff., 242 ff., 245 ff., 249 ff., 261 ff., 264, 266, 268, 270 ff., 273, 277, 281 ff., 290 ff., 304, 306 ff., 309 ff., 312 ff., 319, 325 ff., 329, 331 ff., 337, 339 ff.  
   – bis(trifluoromethylsulfonyl)imide 25, 27, 61, 77, 97, 106, 113, 261, 270, 337, 339, 343 ff.  
   – bromide 223, 242, 268, 290  
   – chloride 18, 29, 77, 97, 201 ff., 215, 225 ff., 245 ff., 273, 277, 292 ff., 306 ff., 309 ff., 319  
   – chloroaluminate 62, 115  
   – chloroferrate 207 ff.  
   – chlorostannate 234  
   – chlorozincate 264  
   – halide 261  
   – hexafluoroantimonate 195, 201, 229 ff., 261, 343  
   – hexafluorophosphate 19, 26, 37, 53, 59, 61, 73 ff., 77 ff., 84, 86 ff., 97, 99 f., 113, 144 ff., 149, 154, 163 ff., 166 f., 171 ff., 181, 185 ff., 190 ff., 194, 201, 215, 218, 231 ff., 235 ff., 242, 249 ff., 261 ff., 264, 266, 270 ff., 281 ff., 304, 312 ff., 325 ff., 329, 331 ff., 337, 339 ff., 343 ff.  
   – hydrogensulfate 201  
   – lactate 183  
   – methylsulphate 340  
   – nitrate 18, 88, 261  
   – octylsulfate 216  
   – perchlorate 97  
   – tetracarbonylcobaltate 225  
   – tetrachloropalladate 146  
   – tetrafluoroborate 16, 65 ff., 89 ff., 97, 104, 106, 149, 187 ff., 190 ff., 194 ff., 215, 223, 225, 229, 231, 234, 242 ff., 251 ff., 261 ff., 266, 270 ff., 282, 291, 337, 340, 342 ff.  
   – triflate 61, 97, 113, 195, 251, 261, 271  
   – trifluoroacetate 61, 113, 261, 343 ff.  
 1-butyl-4-methylpyridinium 275  
   – chloride 275  
 1-butylpyridinium [BP] 12, 41, 62 f., 88, 106, 108, 115 f., 120, 122, 135, 145, 181, 189, 324, 331 ff.  
   – bis(trifluoromethylsulfonyl)imide 63, 116, 120, 122  
   – chloride 108, 135, 181, 331  
   – chloroaluminate 62, 115  
   – hexafluorophosphate 145  
   – tetrafluoroborate 63, 88, 106, 116, 120, 122, 145, 189, 324, 332  
 butyltriphenylphosphonium 240  
   – tosylate 240
- c**  
 cadmium 301  
 capacitor 103  
 carbene 34, 145, 223 ff., 242, 267 ff., 290, 329  
 carbonylation 252  
 Carius tube 10  
 catalysis 25 f., 39, 145, 174, 210, 213 ff., 218 ff., 221 ff., 225, 230, 234, 244, 253, 258 ff., 263, 266 ff., 269 ff., 288, 293, 302, 327, 338, 353  
   – biphasic 71, 214, 218 ff., 230, 234, 244, 258 ff., 266 ff., 269 ff., 293

- heterogeneous 218 ff., 222, 253, 258, 288
  - homogeneous 70, 213 ff., 218 ff., 222, 253, 258 ff., 263, 288, 353
  - multiphasic 220, 259 ff., 263
  - phase-transfer 258
  - transition metal, *see* transition metal catalysis
  - catalyst 33, 69 ff., 77 ff., 193, 201 ff., 207, 214, 218, 222, 225 ff., 229 ff., 234 ff., 241, 243 ff., 246, 248, 250 ff., 258 ff., 263, 265 ff., 269 ff., 275 ff., 278, 281, 283 ff., 287, 300, 319, 326, 328 ff., 332, 336, 338, 348, 352 f.
    - activity 319
    - complex 213 ff., 218 ff.
    - concentration 271, 281
    - consumption 241, 272, 281
    - deactivation 244
    - decomposition 72, 283
    - heterogeneous 338
    - layer 218, 243, 251 f.
    - leaching 70 ff., 235
    - lifetime 220, 235, 250
    - phase 219, 229, 252, 259 ff., 269, 287
    - poison 270
    - precursor 225, 285
    - recovery 277 f.
    - recycling 70, 234, 243, 248, 260, 276, 278, 284, 328 f.
    - removal 329
    - separation 234, 248, 258, 263, 276, 281
    - solubility 69, 213, 221
    - solution 237, 251, 283
    - solvent 219, 252, 266, 272
    - stability 336
    - structure 319
    - support 78
    - system 77, 244
  - C-C-coupling 217
  - cerium 297, 300
  - charge density 87
  - chemical stability 43
  - chloride 44, 46, 59, 69 ff., 84, 99, 104, 107, 109, 120 ff., 131, 137, 142 ff., 159 ff., 185, 224, 227, 278, 291, 299, 332
  - chlorination 192 ff.
  - chloroaluminate 3 ff., 18, 22 f., 27, 33 ff., 41, 43, 64 ff., 104 ff., 107 ff., 120 ff., 131, 144, 156, 174 ff., 177, 179 ff., 191 ff., 198, 200 f., 203, 205, 207 ff., 214 ff., 221, 225 ff., 245 ff., 266, 270, 275 f., 278, 289, 292, 297 ff., 309, 320 ff., 326 ff., 332 f.
  - chloroferrate 225
  - chlorogallate 198, 200
  - chlorostannate 207, 221, 227
  - chromium 246, 300
  - Claisen rearrangement 191, 194
  - cluster 145
  - coal 193
  - cobalt 214, 230, 235 ff., 299, 302, 338
  - cobaltocinium 235, 267
  - co-catalyst 221, 352
  - co-dimerization 251, 275, 285
  - color 17, 23 ff., 28
  - co-miscibility 69
  - compressed carbon dioxide 251, 265, 281, 283 ff.
  - compressibility 81
  - computational chemistry 152
  - conductivity 3, 59 ff., 103 ff., 109 ff., 112 ff., 115 ff., 121, 123, 164, 166, 262, 295, 297, 324, 331, 348, 350, 352
  - coordination 70
  - copolymerization 326 ff.
  - copper 210, 297, 299, 301 ff., 309 ff., 329 ff.
  - corrosion 216, 294, 299, 303
  - co-solvent 64 ff., 117 ff., 218, 259, 262, 263 f., 270, 304, 336 ff., 339, 342
  - Coulombic attraction 45 ff., 53
  - Coulombic interaction 51, 95, 98, 158
  - cracking 208 ff.
  - crown ether 73
  - crystallization 164
  - crystal structure 75
  - cyclic voltammetry 104, 296 ff., 306 ff., 309 ff., 313
  - cyclization reaction 175, 178 ff., 194, 196 f., 203 ff., 328
  - cycloaddition 35, 100
  - cyclodehydration 196, 198
  - cyclodimerization 251
  - cyclovoltammetry 166
- d**
- deactivation 220, 230, 235, 243, 264, 286, 338

- dealkylation 193, 223  
 dealkylation reaction 175  
 debromination 225  
 decomposition 261  
 decomposition temperature 44  
 dehydrogenase 342  
 denaturation 339  
 density 3, 18, 49, 52, 56 ff., 60 ff.,  
 65 ff., 81, 112 ff., 115 ff., 164, 174,  
 272  
 Density Functional Theory (DFT)  
 153 ff.  
 deoxochlorination 290  
 detergent 320  
 deuteration 128, 191, 226  
 diacetylation 205  
 dialkylammonium 96 ff.  
 – thiocyanate 97  
 dialkylimidazolium 5, 30, 269, 272  
 – chloroaluminate 272  
 1,3-dialkylimidazolium 189, 261  
 diastereoselectivity 187  
 dibutylammonium 324  
 – chloride 324  
 dielectric constant 76, 94  
 Diels-Alder reaction 100 ff., 181 ff.,  
 319  
 Difasol process 246, 274 ff., 278  
 differential scanning calorimetry  
 (DSC) 43  
 1,3-dimethylimidazolium [MMIM]  
 60, 62, 112, 115, 133 ff., 158 ff., 224,  
 261, 337, 340, 342  
 – bis(trifluoromethylsulfonyl)imide  
 60, 112  
 – chloride 133 ff., 160  
 – chloroaluminate 62, 115  
 – hexafluorophosphate 261  
 – methylsulphate 337, 340, 342  
 – tetrafluoroborate 224  
 diffusion 89, 119, 123, 160, 164, 261  
 diffusion coefficient 118 ff.  
 diffusion, mutual 162 ff.  
 diffusion, translational 162  
 digital image holography 165, 167  
 dimerization 89, 179, 210, 214, 217,  
 244 ff., 251 ff., 266, 270, 274 ff.,  
 278, 319 ff.  
 Dimersol process 245, 270 ff., 275,  
 319  
 discoloration 10, 13, 18  
 disposal 278  
 distribution of charge 45  
 dysprosium 195
- e**  
 electrocatalysis 331  
 electrochemical analysis 25  
 electrochemical behavior 3  
 electrochemical window 103 ff.,  
 106 ff., 294 ff., 300, 303, 305,  
 313, 349, 354  
 electrochemistry 42, 104 f., 294, 299  
 electrodeposition 43, 294 ff., 297 ff.,  
 305 ff., 309, 312, 314 ff., 350, 353  
 electrodisolution 315 ff.  
 electrolysis 294, 297  
 electrolyte 42, 45, 68, 70, 103, 118,  
 121, 324, 349 f.  
 electrooxidation 315  
 electrophilicity 222, 227, 244, 249,  
 266  
 electrophilic substitution 191  
 electroplating 70  
 electroreduction 298, 306  
 electrosynthesis 68  
 electrowinning 70  
 enantioselectivity 182, 230 ff., 270,  
 285, 287, 342, 344 ff.  
 enthalpy of absorption 87  
 enthalpy of adsorption 89  
 enthalpy of melting 44  
 enzyme 337 ff.  
 epoxidation 233, 319  
 esterase 344  
 esterification reaction 181, 344  
 ethylammonium 9, 182, 339 ff.  
 – nitrate 9, 182, 339 ff.  
 ethyldiisopropylammonium 192  
 – trifluoroacetate 192  
 ethylimidazolium 158  
 1-ethyl-3-methylimidazolium [EMIM]  
 5, 10, 13 ff., 18, 25 ff., 41, 43, 46 ff.,  
 52, 60, 62, 64 ff., 70, 77, 79, 88,  
 99 f., 105 ff., 111 f., 115, 117 ff.,  
 120 ff., 133, 143 ff., 147, 180 ff.,  
 188 ff., 191 ff., 198 ff., 201, 205 ff.,  
 210, 215 ff., 224, 228, 233, 278,  
 285 ff., 290 ff., 298, 301, 304,  
 320 ff., 324, 327 ff., 332, 340, 343  
 – acetate 18, 60, 106, 112  
 – bis(trifluoromethylsulfonyl)imide  
 60, 99, 106, 111 f., 120, 122, 216,  
 285 ff., 292, 340, 343  
 – bromide 100  
 – bromoaluminate 62, 115  
 – chloride 10, 13 ff., 17 f., 25, 43,  
 47 ff., 64 ff., 70, 77, 105, 108,  
 117 ff., 133, 143 ff., 180 ff.,



191 ff., 198 ff., 205 ff., 210, 215, 224, 228, 278, 290, 298, 301, 304, 320 ff., 327 ff., 332

- chloroaluminate 62, 115, 120, 122, 191
- chloroferrate 207
- ethylsulphate 88
- fluoride 106
- halide 47
- hexafluoroantimonate 201
- hexafluorophosphate 14, 47, 60, 112, 188 ff., 191, 233, 343
- iodide 181, 291
- mesylate 60, 112
- tetrachloroaluminate 48
- tetrachloronickelate 143 ff.
- tetrafluoroborate 25 ff., 60, 106, 111 f., 120, 122, 188 ff., 191 ff., 233, 285, 301, 324, 340, 343
- triflate 60, 106, 112, 191 ff.
- trifluoroacetate 60, 112, 120

1-ethylpyridinium [EP] 3, 62, 115

- chloroaluminate 62, 115

ETN value 96 ff.

eutectic composition 47 ff.

extended X-ray absorption fine structure (EXAFS) 127, 139 ff., 228

extraction 36, 69 ff., 78, 82, 91, 164, 174, 182, 189 ff., 214, 218, 220, 233, 243, 263 ff., 281 ff., 330, 336, 339 ff., 350 f., 353

**f**

fermentation 336, 339 f.

Fick diffusion 119

Fick's first law 162

Fick's second law 163, 166

fluorescence spectroscopy 99

fluoride 107

fluorous tails 38

Franklin acid 196

Friedel-Crafts acylation 186, 203 ff., 207, 225, 319

Friedel-Crafts alkylation 196, 201, 225, 319

Friedel-Crafts reaction 5, 191, 196, 202

Fries rearrangement 204 ff.

**g**

gallium 298, 304

gas chromatography 85, 92, 94 f., 350

gas-liquid chromatography 76

germanium 303 ff., 312 ff.

glass formation 43

glass transition 48, 51 ff.

glass transition temperature 44

gold 302 ff., 306 ff., 309 ff., 313 ff.

Grignard reaction 186

guanidinium 237 ff.

**h**

hafnium 327

halide 73, 95, 104, 107, 149, 250, 330

halogenation 191

Hartree-Fock (HF) 153 ff.

heat capacity 81, 351

heat of fusion 53

Heck reaction 145, 223, 241, 264, 268, 319

Henry's law 83

Henry's law constant 83 ff., 87 ff.

hexafluoroantimonate 17, 201, 229

hexafluorophosphate 5, 15, 17, 22, 31 ff., 35, 44, 46, 54, 69, 81, 99, 105, 107, 147, 149, 201, 215 ff., 221 ff., 229, 240, 252, 266

1-hexyl-3-methylimidazolium [HMIM] 36 ff., 61, 74, 77 ff., 113, 145, 189 ff., 201, 261, 271, 330

- chloride 145
- hexafluoroantimonate 201
- hexafluorophosphate 36 ff., 61, 74, 77 ff., 113, 189 ff., 330
- tetrafluoroborate 261, 330
- triflate 271

Hildebrand solubility parameter 101

Hittorff method 121

Horner-Wadsworth-Emmons reaction 189

HSE data 29 ff.

hydrodimerization 225

hydroformylation 37, 82, 89 ff., 214, 216 ff., 234 ff., 258 ff., 264 ff., 267, 270, 283 ff., 319

hydrogenation 71, 77, 82, 89 ff., 180, 214, 217, 229, 231 ff., 234, 261, 263, 266 ff., 270, 282 ff., 319 ff., 352

hydrogen bond 53 f., 64, 69, 76, 82, 87, 95 ff., 98 f., 101, 121, 137, 153 ff., 183, 337

hydrolysis 12 f., 26, 32, 201, 214 ff., 240, 267, 338, 340 ff., 344

hydrophilicity 337

hydrophobicity 69, 72 ff., 76, 78, 114

hydrovinylation 216, 251, 284 ff.

- i**
- ideal gas law 84
- imidazole 34, 36, 38, 191, 193
- imidazolium 5, 9, 27, 34 ff., 36 ff., 42, 49, 64, 66, 75, 96, 98, 101, 107, 109, 111, 128, 133, 159, 182, 191, 193, 200, 222 ff., 239 ff., 242, 262, 267 ff., 290, 322, 324
- bis(trifluoromethylsulfonyl)imide 96
  - chloride 182
  - chloroaluminate 5
  - halide 27
  - hexafluorophosphate 96
  - tetrafluoroborate 96
  - triflate 96
  - trifluoroacetate 182
- immobilization 70, 72, 214, 235, 237 ff., 253, 258, 266, 287 f., 338
- impedance 109 ff.
- indium 190, 195, 300 ff., 304 ff.
- infinite dilution activity coefficient 83, 86
- intellectual property (IP) 31 ff.
- intermolecular coupling 178
- intramolecular coupling 178
- iodide 104
- ion chromatography 25, 27
- ion exchange resin 15
- ionic liquid, chiral 182 ff.
- ion-ion packing 49
- ion-ion pairing 43
- ion-pair 44, 153 ff., 258
- ion size 45 ff., 64, 66
- iron 190, 207 ff., 251 ff., 291 ff., 298 ff.
- isomerization 196, 198, 207 ff., 210, 247 ff., 250, 263, 284, 286, 322
- k**
- Kaputinskii equation 45
- Karl-Fischer titration 19, 28
- kinetic resolution 336, 343 ff.
- Knoevenagel condensation 35, 189 ff.
- l**
- lanthanum 195, 295, 297, 300
- lattice energy 45
- leaching 37, 229, 235, 238, 248, 258 ff., 267, 283 ff.
- Lewis acid 12, 43, 47, 70, 101, 179, 182 ff., 190 ff., 194 ff., 204, 221 f., 246, 266, 320 ff., 323
- Lewis base 70, 109
- ligand 71, 73, 213, 218, 222, 227, 230, 234 ff., 238, 241 ff., 246 ff., 251, 253, 259 ff., 265, 267, 272, 283 ff., 287, 329
- lipase 336, 339 ff., 342 ff.
- lipophilicity 52, 69, 71, 74, 76 ff., 79
- liquid crystal 135
- liquid–solid transition 49
- liquidus range 43, 45
- lithium 298
- loop reactor 275 f.
- m**
- magnesium 295
- manganese 190 ff., 234, 292 ff., 338, 352
- mass transfer 84, 89 ff., 214, 250, 260 ff., 265, 269, 288
- mass transport 29, 339, 346
- melting point 34, 41 ff., 44 ff., 204, 234, 262, 264, 304, 324, 327
- membrane 91, 265 ff., 345, 348, 350
- mesophase 135 ff.
- mesylate 64, 66
- metathesis 12, 14, 16, 18, 22, 26, 35, 38, 252, 263, 328
- methylation 198
- 1-methylimidazole 10 ff., 17, 24 ff., 35
- methylimidazolium 158
- 1-methyl-3-nonylimidazolium [NMIM] 155
- hexafluorophosphate 155
- 1-methyl-3-octylimidazolium [OMIM] 11, 61, 74, 77 ff., 84, 86 ff., 97 ff., 113, 149, 232, 330, 339 ff., 344
- bis(trifluoromethylsulfonyl)imide 97
  - bromide 149
  - chloride 97, 149
  - hexafluorophosphate 61, 74, 77 ff., 84, 86 ff., 97, 113, 149, 330, 339 ff., 344
  - tetrafluoroborate 84, 86 ff., 149, 232, 330
- 1-methyl-3-pentylimidazolium 201
- hexafluorophosphate 201
- 1-methyl-3-propylimidazolium [PMIM] 53, 60, 62, 112, 115, 283
- chloroaluminate 62, 115
  - hexafluorophosphate 53, 60, 112
- 1-methylpyridinium [MP] 62, 115
- chloroaluminate 62, 115

methyl tosylate 12  
 methyl triflate 12  
 miconazole 33  
 microwave 191  
 miscibility 69, 78, 260, 274, 297  
 molecular dynamics simulation 157, 159  
 molten salt 1, 2 ff., 41, 43 ff., 175, 178 ff., 183 ff., 196, 203 ff., 294 ff., 297, 299 ff., 303, 305  
 molybdenum 289, 328  
 monoalkylammonium 96 ff.  
 – chloride 97  
 – nitrate 96 ff.  
 – thiocyanate 96 ff.  
 Moving Boundary method 121

**n**

Nafion-H 190  
 nanofiltration 345  
 nanostructure 299  
 nanotechnology 298, 302 ff., 305, 316  
 Negishi coupling 241, 243 ff.  
 Newtonian fluid 56  
 neutron diffraction 127 ff., 134  
 neutron source 129  
 nickel 214 f., 221 ff., 226 ff., 232, 245 ff., 258, 266, 270 ff., 275, 278, 284 ff., 299 ff., 302, 319, 327 ff., 354  
 niobium 289, 299  
 nitrate 5, 17, 35, 99, 191  
 nitration 191  
 nitrite 95  
 NMR spin-echo method 165, 167  
 nuclear Overhauser enhancement (NOE) 168 ff., 172  
 nucleophilic displacement reaction 184 ff.  
 nucleophilicity 221, 250, 266, 268, 285, 354  
 Nyquist Plot 110

**o**

octylsulphate 240  
 oligomerization 77, 210, 217, 219, 221 ff., 244 ff., 250, 258, 263, 286, 320, 322, 328  
 oxidation 82, 89 ff., 104, 119, 178 ff., 190 ff., 217, 232 ff., 235, 284, 298 f., 306 ff., 314 ff., 319, 332, 336  
 oxidoreductase 342  
 oxophilicity 327

**p**

palladium 145, 217, 223 ff., 230, 237, 241 ff., 251 ff., 264, 266 ff., 295, 300, 302  
 patent 31  
 perfluorocarboxylate 76  
 pervaporation 345  
 phase behavior 81  
 phase diagram 41, 44, 47 ff., 51, 77  
 phase equilibrium 3  
 phase-transfer reagents 42  
 phenylguanidinium 267  
 phosgene 289  
 phosphine 10, 37, 239, 241, 246 ff., 249, 264 ff., 269, 283  
 phosphite 239, 264, 267  
 phosphonium 34, 39, 42, 48, 94, 100, 183, 200, 216, 240, 264  
 – halide 100  
 – tosylate 183, 216, 264  
 phosphorus 298  
 photochemical applications 24  
 photochemical reaction 101  
 picrate 95  
 platinum 214 ff., 221, 224, 227, 234, 267, 297, 300 ff., 314  
 polarity 68, 76 ff., 94, 97, 99 ff., 221, 265, 337 ff., 354  
 polarizability 88, 98 f., 158  
 polyalkylation 196, 198  
 polymer electrolyte 324 ff.  
 polymer film 332  
 polymerization 214, 320 ff., 324 ff.  
 price 23, 28, 30 ff.  
 propylation 198  
 1-propylpyridinium [PP] 62, 115  
 – chloroaluminate 62, 115  
 protease 339, 342  
 protein 338  
 pseudohalide 73  
 purity 7, 11, 14, 23, 84, 104, 107, 250, 278, 332, 338, 345, 352  
 pycnometer 66  
 pyrazolium 63, 106 f., 116  
 pyridine 10, 34  
 pyridinium 5, 7, 42, 63, 107, 116, 135, 139, 175, 193 ff., 200, 224 ff., 239, 267, 276 f.  
 – chloride 175, 276  
 – chloroaluminate 5, 193 ff.  
 – hydrochloride 7, 48  
 pyrrolidinium 63, 116

**q**

quality 21, 28  
 quantum dot 301, 303 ff.  
 quaternization 9 ff., 12, 18 f.

**r**

rearrangement reaction 196  
 red oil 2  
 reduction 104 f., 119, 188, 290, 298,  
 304, 309, 340, 342  
 Reformatsky reaction 187  
 refractive index 99, 165, 174  
 regioselectivity 100, 238, 267, 278  
 registration 29  
 Reichardt's dye 96, 98  
 relaxation, longitudinal 168 ff.  
 reorientational correlation time  
 168 ff., 172  
 rhodium 37, 214, 216 ff., 229 ff.,  
 232, 234 ff., 258 ff., 264 ff., 270,  
 282 ff., 352  
 Robinson annulation reaction 189 ff.  
 ruthenium 214 f., 230 ff., 235, 264,  
 266, 282 ff., 328 ff.

**s**

samarium 195  
 scaling-up 28 f., 269  
 scandium 183, 194 ff., 201  
 Scholl reaction 178  
 Schrödinger equation 152, 157  
 selectivity 235 ff., 238 ff., 242, 246,  
 248, 250, 252, 258, 261 ff., 272, 274,  
 276 f., 282 f., 319, 328, 336, 344 f.  
 self-diffusion 119, 121, 162 ff., 352  
 semiconductor 294 ff., 298, 301, 303,  
 305, 312, 316, 331  
 semiempirical method 152 ff.  
 sensor 348 ff., 353  
 separation 68 ff., 72, 79, 81 ff., 91 f.,  
 174, 203, 219, 230, 234, 237, 251,  
 259 ff., 263 ff., 278, 287, 322, 330, 350  
 silicon 303, 312, 316  
 silver 295, 297, 299, 301 ff.  
 smetic phase 136 ff.  
 sodium 297 ff.  
 solid–solid transition 44  
 solid support 201 ff.  
 solubility 38, 68 ff., 76 ff., 81 ff.,  
 85 ff., 103, 174, 213, 218, 229 ff.,  
 233 ff., 238, 247, 250, 252, 258 ff.,  
 261 ff., 267, 270 ff., 276, 278,  
 281 ff., 288, 293, 295, 327, 331, 333,  
 336 ff., 342, 350

solvation 68, 71, 95, 103, 117, 221,  
 230, 321  
 sonication 191  
 stability 261, 272, 331, 338 f., 345 f.  
 Stille coupling 241, 243  
 Stokes' law 56  
 substitution 9  
 substitution reaction 177  
 sulphate 5  
 sulfonium 34, 63, 106 ff., 114, 116  
 supercritical carbon dioxide 69, 82,  
 174, 185, 213, 231 ff., 240, 261, 263,  
 265, 281 ff., 286, 345  
 supported liquid membrane 82,  
 90 ff.  
 surfactant 42  
 Suzuki coupling 241, 243, 266, 319,  
 352  
 symmetry 49 ff., 53

**t**

tantalum 299  
 task-specific ionic liquids (TSIL)  
 33 ff., 36 ff., 71, 75, 79, 353  
 tellurium 301, 304  
 telomerization 225, 232, 252, 264  
 tetraalkylammonium 8, 43, 48 ff.,  
 63, 95 ff., 106, 116, 241  
 – alkanesulfonate 95  
 – bis(trifluoromethylsulfonyl)imide  
 63, 106, 116  
 – bromide 48 ff., 241  
 – chloride 97  
 – halide 95  
 – nitrate 97  
 – tetrafluoroborate 63, 116  
 tetrabutylammonium 49, 95, 100,  
 175, 177, 185, 190, 241 ff.  
 – bromide 100, 241 ff.  
 – chloride 190  
 – fluoride 175, 177  
 – halide 185  
 – thiocyanate 49  
 tetrabutylphosphonium 15, 95, 100,  
 185, 214, 235  
 – bromide 100, 214 f., 235  
 – chloride 100  
 – halide 185  
 – phosphonium 100  
 tetrachloroaluminate 46, 70, 131 ff.,  
 135, 177, 197, 289  
 tetraethylammonium 214, 233 ff.,  
 267, 322  
 – bromide 233

- chloride 322
  - chlorostannate 214 f., 234, 267
  - tetrafluoroborate 5, 17, 22, 31 ff., 44, 46, 54, 64, 66, 81, 87, 99, 107, 114, 137, 149, 201, 214 ff., 221, 229, 252, 302, 338
  - thermal conductivity 81
  - thermal decomposition 43
  - thermal stability 82, 91, 216
  - thermofluid 350, 353
  - thiazolium 63
  - thiocyanate 99
  - tin 302 f.
  - titanium 215, 221, 299 ff., 327
  - tosylate 240
  - toxicity 30, 261, 278, 338
  - tppms 71
  - tppts 71
  - transalkylation 194
  - transesterification 340 ff., 343 ff.
  - transition metal 70 ff., 213 ff., 220 ff., 225 ff., 228 ff., 239, 244, 253, 264, 266 ff., 278, 281, 284, 287, 319 ff., 326 ff., 332, 354
    - catalysis 70, 213 ff., 220 ff., 229, 253, 284, 354
    - catalyst 18, 27, 71 ff., 213 f., 221, 225 ff., 264, 281, 319 ff., 326, 328, 354
    - complex 72, 213, 218, 220, 222, 225 ff., 228, 239, 244, 266 ff., 278, 281, 287
    - polymerization catalyst 332
    - salt 71
  - transport number 118, 121 ff.
  - trialkylammonium 95 ff.
  - trialkylphosphonium 95
  - trialkylsulfonium 8
    - iodide 8
  - tributylhexylammonium 202
    - bis(trifluoromethylsulfonyl)imide 202
  - triethylammonium 184
    - halide 184
  - triethylhexylammonium 145, 184
    - bis(trifluoromethylsulfonyl)imide 145
    - triethylhexylborate 184
  - triflate 17, 64, 66, 76, 95, 107, 201
  - trifluoroacetate 17, 54, 64, 66
  - trifluoromethanesulfonate 137 ff.
  - trimethylammonium 323
    - chloride 323
  - trimethylsulfonium 15, 63, 114, 116
    - bis(trifluoromethylsulfonyl)imide 63, 116
    - chloroaluminate 63, 116
  - triphenylphosphine 145, 235 ff., 251, 259, 291
  - Trost-Tsuji-coupling 252, 319
  - tungsten 246, 297 ff., 300 ff.
  - turnover frequency (TOF) 234, 236, 243, 246 ff., 250 ff., 271, 283
  - turnover number (TON) 238, 246
- u**
- ultrasonic bath 214
- v**
- van der Waals interaction 49, 51, 53, 76, 153
  - van't Hoff equation 84
  - vapor pressure 3, 43
  - 1-vinylimidazole 37
  - viscosity 3, 15, 18, 43, 52, 56 ff., 60 ff., 81, 84, 89, 112 ff., 115 ff., 160, 164, 173 f., 214, 216, 265, 288, 325, 332, 339
  - Vogel-Tammann-Fulcher equation (VTF) 111, 164
- w**
- Walden plot 117 ff.
  - Walden product 60, 112 ff., 115 ff.
  - Walden's rule 114
  - water 27 ff., 32, 35, 43, 59, 65, 69, 71 ff., 76 ff., 84, 86 ff., 89, 91, 97, 101, 104 ff., 107, 114, 127, 130, 159, 177 ff., 181 ff., 189, 203, 216, 219, 221, 225, 231 ff., 234, 237, 240, 242 ff., 250, 252 f., 258 ff., 264 ff., 269, 278, 282, 289, 292, 294, 298, 300, 337 ff., 341 f., 344 ff., 348
  - water activity 337 ff., 342 ff.
  - whole cell 337 ff.
  - Wittig reagent 39
- x**
- X-ray diffraction 134, 136, 138
  - X-ray scattering 43, 127, 137, 139
- y**
- ytterbium 195
- z**
- zeolite 202
  - Ziegler-Natta catalyst 214, 258, 327
  - zinc 182, 187, 243 ff., 251, 302 ff., 338
  - zirconium 327

## 1

### Introduction

*John S. Wilkes*

Ionic liquids may be viewed as a new and remarkable class of solvents, or as a type of materials that have a long and useful history. In fact, ionic liquids are both, depending on your point of view. It is absolutely clear though, that whatever “ionic liquids” are, there has been an explosion of interest in them. Entries in Chemical Abstracts for the term “ionic liquids” were steady at about twenty per year through 1995, but had grown to over 300 in 2001. The increased interest is clearly due to the realization that these materials, formerly used for specialized electrochemical applications, may have greater utility as reaction solvents.

For purposes of discussion in this volume we will define ionic liquids as salts with a melting temperature below the boiling point of water. That is an arbitrary definition based on temperature, and says little about the composition of the materials themselves, except that they are completely ionic. In reality, most ionic liquids in the literature that meet our present definition are also liquids at room temperature. The melting temperature of many ionic liquids can be problematic, since they are notorious glass-forming materials. It is a common experience to work with a new ionic liquid for weeks or months to find one day that it has crystallized unexpectedly. The essential feature that ionic liquids possess is one shared with traditional molten salts: a very wide liquidus range. The liquidus range is the span of temperatures between the melting point and boiling point. No molecular solvent, except perhaps some liquid polymers, can match the liquidus range of ionic liquids or molten salts. Ionic liquids differ from molten salts in just where the liquidus range is in the scale of temperature.

There are many synonyms used for ionic liquids, which can complicate a literature search. “Molten salts” is the most common and most broadly applied term for ionic compounds in the liquid state. Unfortunately, the term “ionic liquid” was also used to mean “molten salt” long before there was much literature on low-melting salts. It may seem that the difference between ionic liquids and molten salts is just a matter of degree (literally); however the practical differences are sufficient to justify a separately identified niche for the salts that are liquid around room temperature. That is, in practice the ionic liquids may usually be handled like ordinary solvents. There are also some fundamental features of ionic liquids, such as strong



ion-ion interactions that are not often seen in higher-temperature molten salts. Synonyms in the literature for materials that meet the working definition of ionic liquid are: “room temperature molten salt”, “low-temperature molten salt”, “ambient-temperature molten salt”, and “liquid organic salt.”

Our definition of an ionic liquid does not answer the general question, “What is an ionic liquid?” This question has both a chemical and a historical answer. The details of the chemical answer are the subject of several subsequent chapters in this book. The general chemical composition of ionic liquids is surprisingly consistent, even though the specific composition and the chemical and physical properties vary tremendously. Most ionic liquids have an organic cation and an inorganic, polyatomic anion. Since there are many known and potential cations and anions, the potential number of ionic liquids is huge. To discover a new ionic liquid is relatively easy, but to determine its usefulness as a solvent requires a much more substantial investment in determination of physical and chemical properties. The best trick would be a method for predicting an ionic liquid composition with a specified set of properties. That is an important goal that awaits a better fundamental understanding of structure-property relationships and the development of better computational tools. I believe it can be done.

The historical answer to the nature of present ionic liquids is somewhat in the eye of the beholder. The very brief history presented here is just one of many possible ones, and is necessarily biased by the point of view of just one participant in the development of ionic liquids. The earliest material that would meet our current definition of an ionic liquid was observed in Friedel-Crafts reactions in the mid-19th century as a separate liquid phase called the “red oil.” The fact that the red oil was a salt was determined more recently, when NMR spectroscopy became a commonly available tool. Early in the 20th century, some alkylammonium nitrate salts were found to be liquids [1], and more recently liquid gun propellants based on binary nitrate ionic liquids have been developed [2]. In the 1960s, John Yoke at Oregon State University reported that mixtures of copper(I) chloride and alkylammonium chlorides were often liquids [3]. These were not as simple as they might appear, since several chlorocuprous anions formed, depending on the stoichiometry of the components. In the 1970s, Jerry Atwood at the University of Alabama discovered an unusual class of liquid salts he termed “liquid clathrates” [4]. These were composed of a salt combined with an aluminium alkyl, which then formed an inclusion compound with one or more aromatic molecules. A formula for the ionic portion is  $M[Al_2(CH_3)_6X]$ , where M is an inorganic or organic cation and X is a halide.

None of the interesting materials just described are the direct ancestors of the present generation of ionic liquids. Most of the ionic liquids responsible for the burst of papers in the last several years evolved directly from high-temperature molten salts, and the quest to gain the advantages of molten salts without the disadvantages. It all started with a battery that was too hot to handle.

In 1963, Major (Dr.) Lowell A. King (Figure 1.1) at the U.S. Air Force Academy initiated a research project aimed at finding a replacement for the LiCl/KCl molten salt electrolyte used in thermal batteries.

**Figure 1.1:** Major (Dr.) Lowell A. King at the U.S. Air Force Academy in 1961. He was an early researcher in the development of low-temperature molten salts as battery electrolytes. At that time “low temperature” meant close to 100 °C, compared to many hundreds of degrees for conventional molten salts. His work led directly to the chloroaluminate ionic liquids.



Since then there has been a continuous molten salts/ionic liquids research program at the Air Force Academy, with only three principal investigators: King, John Wilkes (Figure 1.2), and Richard Carlin. Even though the LiCl/KCl eutectic mixture has a low melting temperature (355 °C) for an inorganic salt, the temperature causes materials problems inside the battery, and incompatibilities with nearby devices. The class of molten salts known as chloroaluminates, which are mixtures of alkali halides and aluminium chloride, have melting temperatures much lower than nearly all other inorganic eutectic salts. In fact NaCl/AlCl<sub>3</sub> has a eutectic composition with a melting point of 107 °C, very nearly an ionic liquid by our definition [5]. Chloroaluminates are another class of salts that are not simple binary mixtures, because the Lewis acid-base chemistry of the system results in the presence of the series of the anions Cl<sup>-</sup>, [AlCl<sub>4</sub>]<sup>-</sup>, [Al<sub>2</sub>Cl<sub>7</sub>]<sup>-</sup>, and [Al<sub>3</sub>Cl<sub>10</sub>]<sup>-</sup> (although fortunately not all of these in the same mixture). Dr. King taught me a lesson that we should take heed of with the newer ionic liquids: if a new material is to be accepted as a technically useful material, the chemists must present reliable data on the chemical and physical properties needed by engineers to design processes and devices. Hence, the group at the Air Force Academy, in collaboration with several other groups, determined the densities, conductivities, viscosities, vapor pressures, phase equilibria, and electrochemical behavior of the salts. The research resulted in a patent for a thermal battery that made use of the NaCl/AlCl<sub>3</sub> electrolyte, and a small number of the batteries were manufactured.

Early in their work on molten salt electrolytes for thermal batteries, the Air Force Academy researchers surveyed the aluminium electroplating literature for electrolyte baths that might be suitable for a battery with an aluminium metal anode and chlorine cathode. They found a 1948 patent describing ionically conductive mixtures of AlCl<sub>3</sub> and 1-ethylpyridinium halides, mainly bromides [6]. Subsequently, the salt 1-butylpyridinium chloride/AlCl<sub>3</sub> (another complicated pseudo-binary)





**Figure 1.2:** Captain (Dr.) John S. Wilkes at the U.S. Air Force Academy in 1979. This official photo was taken about when he started his research on ionic liquids, then called “room-temperature molten salts.”



**Figure 1.3:** Prof. Charles Hussey of the University of Mississippi. The photo was taken in 1990 at the U.S. Air Force Academy while he was serving on an Air Force Reserve active duty assignment. Hussey and Wilkes collaborated in much of the early work on chloroaluminate ionic liquids.

was found to be better behaved than the earlier mixed halide system, so its chemical and physical properties were measured and published [7]. I would mark this as the start of the modern era for ionic liquids, because for the first time a wider audience of chemists started to take interest in these totally ionic, completely nonaqueous new solvents.

The alkyipyridinium cations suffer from being relatively easy to reduce, both chemically and electrochemically. Charles Hussey (Figure 1.3) and I set out a program to predict cations more resistant to reduction, to synthesize ionic liquids on the basis of those predictions, and to characterize them electrochemically for use as battery electrolytes.

**Figure 1.4:** Dr. Michael Zaworotko from Saint Mary's University in Halifax, Nova Scotia. He was a visiting professor at the U.S. Air Force Academy in 1991, where he first prepared many of the water-stable ionic liquids popular today.



We had no good way to predict if they would be liquid, but we were lucky that many were. The class of cations that were the most attractive candidates was that of the dialkylimidazolium salts, and our particular favorite was 1-ethyl-3-methylimidazolium [EMIM]. [EMIM]Cl mixed with  $\text{AlCl}_3$  made ionic liquids with melting temperatures below room temperature over a wide range of compositions [8]. We determined chemical and physical properties once again, and demonstrated some new battery concepts based on this well behaved new electrolyte. We and others also tried some organic reactions, such as Friedel–Crafts chemistry, and found the ionic liquids to be excellent both as solvents and as catalysts [9]. It appeared to act like acetonitrile, except that it was totally ionic and nonvolatile.

The pyridinium- and the imidazolium-based chloroaluminate ionic liquids share the disadvantage of being reactive with water. In 1990, Mike Zaworotko (Figure 1.4) took a sabbatical leave at the Air Force Academy, where he introduced a new dimension to the growing field of ionic liquid solvents and electrolytes.

His goal for that year was to prepare and characterize salts with dialkylimidazolium cations, but with water-stable anions. This was such an obviously useful idea that we marveled that neither we nor others had tried to do it already. The preparation chemistry was about as easy as the formation of the chloroaluminate salts, and could be done outside of the glove-box [10]. The new tetrafluoroborate, hexafluorophosphate, nitrate, sulfate, and acetate salts were stable (at least at room temperature) towards hydrolysis. We thought of these salts as candidates for battery electrolytes, but they (and other similar salts) have proven more useful for other applications. Just as Zaworotko left, Joan Fuller came to the Air Force Academy, and spent several years extending the catalog of water-stable ionic liquids, discovering better ways to prepare them, and testing the solids for some optical properties. She made a large number of ionic liquids from the traditional dialkylimidazolium cations, plus a series of mono- and trialkylimidazoliums. She combined those cations with the water-stable anions mentioned above, *plus* the additional series of bromide, cyanide, bisulfate, iodate, trifluoromethanesulfonate, tosylate, phenyl-

phosphonate, and tartrate. This resulted in a huge array of new ionic liquids with anion sizes ranging from relatively small to very large.

It seems obvious to me and to most other chemists that the table of cations and anions that form ionic liquids can and will be extended to a nearly limitless number. The applications will be limited only by our imagination.

## References

- 1 Walden, P., *Bull. Acad. Imper. Sci. (St Petersburg)* **1914**, 1800.
- 2 CAS Registry Number 78041-07-3.
- 3 Yoke, J. T., Weiss, J. F., Tollin, G., *Inorg. Chem.* **1963**, *2*, 1210–1212.
- 4 Atwood, J. L., Atwood, J. D., *Inorganic Compounds with Unusual Properties*, Advances in Chemistry Series No. 150, American Chemical Society: Washington, DC, **1976**, pp 112–127.
- 5 For a review of salts formerly thought of as low-temperature ionic liquids, see Mamantov, G., *Molten salt electrolytes in secondary batteries*, in *Materials for Advanced Batteries* (Murphy, D. W., Broadhead, J., and Steele, B.C. H. eds.), Plenum Press, New York, **1980**, pp. 111–122.
- 6 Hurley, F. H., U.S. Patent 4,446,331, **1948**. Wier, T. P. Jr., Hurley, F. H., U.S. Patent 4,446,349, **1948**. Wier, T. P. Jr., US Patent 4,446,350, **1948**. Wier, T. P. Jr., US Patent 4,446,350, **1948**.
- 7 Gale, R. J., Gilbert, B., Osteryoung, R. A., *Inorg. Chem.*, **1978**, *17*, 2728–2729. Nardi, J. C., Hussey, C. L., King, L. A., U.S. Patent 4,122,245, **1978**.
- 8 Wilkes, J. S., Levisky, J. A., Wilson R. A., Hussey, C. L. *Inorg. Chem.* **1982**, *21*, 1263.
- 9 Boon, J., Levisky, J. A., Pflug, J. L., Wilkes, J. S., *J. Org. Chem.* **1986**, *51*, 480–483.
- 10 Wilkes, J. S., Zaworotko, M. J., *J. Chem. Soc., Chem. Commun.* **1992**, 965–967.

## 2

### Synthesis and Purification of Ionic Liquids

*James H. Davis, Jr., Charles M. Gordon, Claus Hilgers, and Peter Wasserscheid*

#### 2.1

##### Synthesis of Ionic Liquids

*Charles M. Gordon*

##### 2.1.1

###### Introduction

Despite the ever-growing number of papers describing the applications of ionic liquids, their preparation and purification has in recent years taken on an air of “need to know”. Although most researchers employ similar basic types of chemistry, it appears that everyone has their own tricks to enhance yields and product purity. This chapter is an attempt to summarize the different methods reported to date, and to highlight the advantages and disadvantages of each. The purity of ionic liquids is also an area of increasing interest as the nature of their interactions with different solutes comes under study, so the methods used for the purification of ionic liquids are also reviewed. The aim is to provide a summary for new researchers in the area, pointing to the best preparative methods, and the potential pitfalls, as well as helping established researchers to refine the methods used in their laboratories.

The story of ionic liquids is generally regarded as beginning with the first report of the preparation of ethylammonium nitrate in 1914 [1]. This species was formed by the addition of concentrated nitric acid to ethylamine, after which water was removed by distillation to give the pure salt, which was liquid at room temperature. The protonation of suitable starting materials (generally amines and phosphines) still represents the simplest method for the formation of such materials, but unfortunately it can only be used for a small range of useful salts. The possibility of decomposition through deprotonation has severely limited the use of such salts, and so more complex methods are generally required. Probably the most widely used salt of this type is pyridinium hydrochloride, the applications of which may be found in a thorough review by Pagni [2].

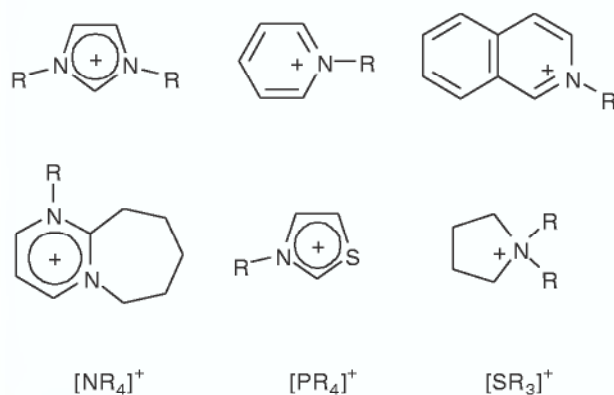

**Figure 2.1-1:** Examples of cations commonly used for the formation of ionic liquids.

Thus, most ionic liquids are formed from cations that do not contain acidic protons. A summary of the applications and properties of ionic liquids may be found in a number of recent review articles [3]. The most common classes of cations are illustrated in Figure 2.1-1, although low melting point salts based on other cations, such as complex polycationic amines [4] and heterocycle-containing drugs [5], have also been prepared.

The synthesis of ionic liquids can generally be split into two sections: the formation of the desired cation, and anion exchange where necessary to form the desired product (demonstrated for ammonium salts in Scheme 2.1-1).

In some cases only the first step is required, as with the formation of ethylammonium nitrate. In many cases the desired cation is commercially available at reasonable cost, most commonly as a halide salt, thus requiring only the anion exchange reaction. Examples of these are the symmetrical tetraalkylammonium salts and trialkylsulfonium iodide.

This chapter will concentrate on the preparation of ionic liquids based on 1,3-dialkylimidazolium cations, as these have dominated the area over the last twenty

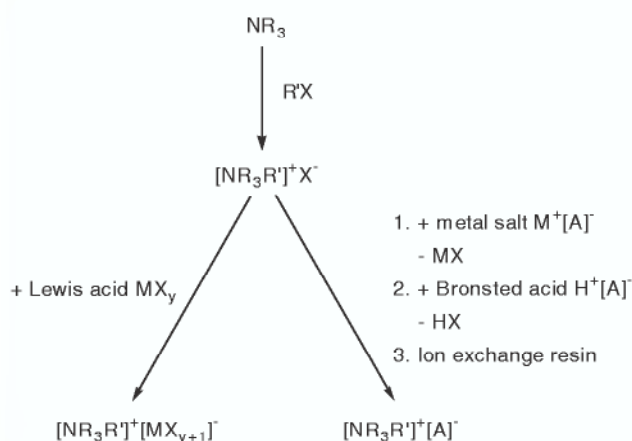

**Scheme 2.1-1:** Typical synthesis paths for the preparation of ionic liquids (adapted from Ref. 3c).

years. The techniques discussed in this chapter are generally applicable to the other classes of cations indicated in Figure 2.1-1, however. The original decision by Wilkes et al. to prepare 1-alkyl-3-methylimidazolium ([RMIM]<sup>+</sup>) salts was prompted by the requirement for a cation with a more negative reduction potential than Al(III) [6]. The discovery that the imidazolium-based salts also generally displayed lower melting points than the 1-alkylpyridinium salts used prior to this cemented their position as the cations of choice since then. Indeed, the method reported by Wilkes et al. for the preparation of the [RMIM]Cl/AlCl<sub>3</sub>-based salts remains very much that employed by most workers to this day.

### 2.1.2

#### Quaternization Reactions

The formation of the cations may be carried out either by protonation with a free acid as noted above, or by quaternization of an amine or a phosphine, most commonly with a haloalkane. The protonation reaction, as used in the formation of salts such as ethylammonium nitrate, involves the addition of 3 M nitric acid to a cooled, aqueous solution of ethylamine [7]. A slight excess of amine should be left over, and this is removed along with the water by heating to 60 °C in vacuo. The same general process may be employed for the preparation of all salts of this type, but when amines of higher molecular weight are employed, there is clearly a risk of contamination by residual amine. A similar method has been reported for the formation of low melting point, liquid crystalline, long alkyl chain-substituted 1-alkylimidazolium chloride, nitrate, and tetrafluoroborate salts [8]. For these a slight excess of acid was employed, as the products were generally crystalline at room temperature. In all cases it is recommended that addition of acid be carried out with cooling of the amine solution, as the reaction can be quite exothermic.

The alkylation process possesses the advantages that (a) a wide range of cheap haloalkanes are available, and (b) the substitution reactions generally occur smoothly at reasonable temperatures. Furthermore, the halide salts formed can easily be converted into salts with other anions. Although this section will concentrate on the reactions between simple haloalkanes and the amine, more complex side chains may be added, as discussed later in this chapter. The quaternization of amines and phosphines with haloalkanes has been known for many years, but the development of ionic liquids has resulted in several recent developments in the experimental techniques used for the reaction. In general, the reaction may be carried out with chloroalkanes, bromoalkanes, and iodoalkanes, with the reaction conditions required becoming steadily more gentle in the order Cl → Br → I, as expected for nucleophilic substitution reactions. Fluoride salts cannot be formed in this manner.

In principle, the quaternization reactions are extremely simple: the amine (or phosphine) is mixed with the desired haloalkane, and the mixture is then stirred and heated. The following section refers to the quaternization of 1-alkylimidazoles, as these are the most common starting materials. The general techniques are similar, however, for other amines such as pyridine [9], isoquinoline [10], 1,8-diazabicyclo[5,4,0]-7-undecene [11], 1-methylpyrrolidine [12], and trialkylamines [13], as



well as for phosphines. The reaction temperature and time are very dependent on the haloalkane employed, chloroalkanes being the least reactive and iodoalkanes the most. The reactivity of the haloalkane also generally decreases with increasing alkyl chain length. As a general guide, in the author's laboratory it is typically found necessary to heat 1-methylimidazole with chloroalkanes to about 80 °C for 2–3 days to ensure complete reaction. The equivalent reaction with bromoalkanes is usually complete within 24 hours, and can be achieved at lower temperatures (ca. 50–60 °C). In the case of bromoalkanes, we have found that care must be taken with large-scale reactions, as a strong exotherm can occur as the reaction rate increases. Besides the obvious safety implications, the excess heat generated can result in discoloration of the final product. The reaction with iodoalkanes can often be carried out at room temperature, but the iodide salts formed are light-sensitive, requiring shielding of the reaction vessel from bright light.

A number of different methodologies have been reported, but most researchers use a simple round-bottomed flask/reflux condenser experimental setup for the quaternization reaction. If possible, the reaction should be carried out under dinitrogen or some other inert gas in order to exclude water and oxygen during the quaternization. Exclusion of oxygen is particularly important if a colorless halide salt is required. Alternatively, the haloalkane and 1-methylimidazole may be mixed in Carius tubes, degassed by freeze-pump-thaw cycles, and then sealed under vacuum and heated in an oven for the desired period. The preparation of salts with very short alkyl chain substituents, such as [EMIM]Cl, is more complex, however, as chloroethane has a boiling point of 12 °C. Such reactions are generally carried out in an autoclave, with the chloroethane cooled to below its boiling point before addition to the reaction mixture. In this case, the products should be collected at high temperature, as the halide salts are generally solids at room temperature. An autoclave may also be useful for the large-scale preparation of the quaternary salts.

In general, the most important requirement is that the reaction mixture be kept free of moisture, as the products are often extremely hygroscopic. The reaction may be carried out without the use of a solvent, as the reagents are generally liquids and mutually miscible, while the halide salt products are usually immiscible in the starting materials. A solvent is often used, however; examples include the alkyl halide itself [6], 1,1,1-trichloroethane [14], ethyl ethanoate [15], and toluene [16], although no particular advantage appears to accrue with any specific one. The unifying factor for all of these is that they are immiscible with the halide salt product, which will thus form as a separate phase. Furthermore, the halide salts are generally more dense than the solvents, so removal of excess solvent and starting material can be achieved simply by decantation. In all cases, however, after reaction is complete and the solvent is decanted, it is necessary to remove all excess solvent and starting material by heating the salt under vacuum. Care should be taken at this stage, as overheating can result in a reversal of the quaternization reaction. It is not advised to heat the halide salts to temperatures greater than about 80 °C.

The halide salts are generally solids at room temperature, although some examples – such as e.g. the 1-methyl-3-octylimidazolium salts – remain viscous oils even at room temperature. Crystallization can take some time to occur, however, and

many salts remain as oils even when formed in good purity. Purification of the solid salts is best achieved by recrystallisation from a mixture of dry acetonitrile and ethyl ethanoate. In cases of salts that are not solid, it is advisable to wash the oil as best as possible with an immiscible solvent such as dry ethyl ethanoate or 1,1,1-trichloroethane. If the reactions are carried out on a relatively large scale, it is generally possible to isolate product yields of >90 % even if a recrystallisation step is carried out, making this an extremely efficient reaction. A drybox is not essential, but can be extremely useful for handling the salts, as they tend to be very hygroscopic, particularly when the alkyl chain substituents are short. In the author's experience, solid 1-alkyl-3-methylimidazolium halide salts can form as extremely hard solids in round-bottomed flasks. Therefore, if a drybox is available the best approach is often to pour the hot salt into shallow trays made of aluminium foil. Once the salt cools and solidifies, it may be broken up into small pieces to aid future use.

The thermal reaction has been used in almost all reports of ionic liquids, being easily adaptable to large-scale processes, and providing high yields of products of acceptable purity with relatively simple methods. An alternative approach involving the use of microwave irradiation has recently been reported, giving high yields with very short reaction times (minutes rather than hours) [17]. The reaction was only carried out for extremely small quantities of material, however, and it is unlikely that it could be scaled up with any great feasibility.

By far the most common starting material is 1-methylimidazole. This is readily available at a reasonable cost, and provides access to the majority of cations likely to be of interest to most researchers. There is only a limited range of other N-substituted imidazoles commercially available, however, and many are relatively expensive. The synthesis of 1-alkylimidazoles may be achieved without great difficulty, though, as indicated in Scheme 2.1-2.

A wider range of C-substituted imidazoles is commercially available, and the combination of these with the reaction shown in Scheme 2.1-2 permits the formation of many different possible starting materials. In some cases, however, it may still be necessary to carry out synthesis of the heterocycle from first principles. For reasons of space, this topic is not covered here.

Relatively little has been reported regarding the determination of the purity of the halide salts other than by standard spectroscopic measurements and microanalysis. This is largely because the halide salts are rarely used as solvents themselves, but are generally simply a source of the desired cation. Also, the only impurities likely to be present in any significant quantity are unreacted starting materials and residual reaction solvents. Thus, for most applications it is sufficient to ensure that they are free of these by use of  $^1\text{H}$  NMR spectroscopy.

The removal of the haloalkanes and reaction solvents is generally not a problem, especially for the relatively volatile shorter chain haloalkanes. On the other hand,

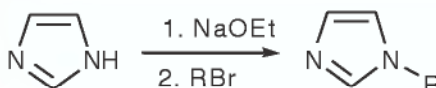

Scheme 2.1-2: Synthesis of alkylimidazoles.



the presence even of small quantities of unreacted 1-methylimidazole (a coordinating base) could cause problems in many applications. Furthermore, its high boiling point (198 °C) means that it can prove difficult to remove from ionic liquids. Holbrey has reported a simple colorimetric determination based on the formation of the blue  $[\text{Cu}(\text{MIM})_4]^{2+}$  ion, which is sensitive to 1-methylimidazole in the 0–3 mol% concentration range [18]. Although this does not solve the problem, it does allow samples to be checked before use, or for the progress of a reaction to be monitored.

It should be noted that it is not only halide salts that may be prepared in this manner. Quaternization reactions between 1-alkylimidazoles and methyl triflate [14], tri-alkylamines and methyl tosylates [19], and triphenylphosphine and octyl tosylate [20] have also been used for the direct preparation of ionic liquids, and in principle any alkyl compound containing a good leaving group may be used in this manner. The excellent leaving group abilities of the triflate and tosylate anions mean that the direct quaternization reactions can generally be carried out at ambient temperatures. It is important that these reactions be carried out under an inert atmosphere, as the alkyl triflates and tosylates are extremely sensitive to hydrolysis. This approach has the major advantage of generating the desired ionic liquid with no side products, and in particular no halide ions. At the end of the reaction it is necessary only to ensure that all remaining starting materials are removed either by washing with a suitable solvent (such as ethyl ethanoate or 1,1,1-trichloroethane) or in vacuo.

### 2.1.3

#### Anion-exchange Reactions

The anion-exchange reactions of ionic liquids can really be divided into two distinct categories: direct treatment of halide salts with Lewis acids, and the formation of ionic liquids by anion metathesis. These two approaches are dealt with separately, as quite different experimental methods are required for each.

##### 2.1.3.1 Lewis Acid-based Ionic Liquids

The formation of ionic liquids by treatment of halide salts with Lewis acids (most notably  $\text{AlCl}_3$ ) dominated the early years of this area of chemistry. The great breakthrough came in 1951, with the report by Hurley and Weir on the formation of a salt that was liquid at room temperature, based on the combination of 1-butylpyridinium with  $\text{AlCl}_3$  in the relative molar proportions 1:2 ( $X = 0.66$ ) [21].<sup>1</sup> More recently, the groups of Osteryoung and Wilkes have developed the technology of room temperature chloroaluminate melts based on 1-alkylpyridinium [22] and  $[\text{RMIM}]^+$  cations [6]. In general terms, treatment of a quaternary halide salt  $\text{Q}^+\text{X}^-$  with a Lewis acid  $\text{MX}_n$  results in the formation of more than one anion species, depending on the relative proportions of  $\text{Q}^+\text{X}^-$  and  $\text{MX}_n$ . Such behavior can be illus-

<sup>1</sup> Compositions of Lewis acid-based ionic liquids are generally referred to by the mole fraction (X) of monomeric acid present in the mixture.

trated for the reaction between [EMIM]Cl and AlCl<sub>3</sub> by a series of equilibria as given in Equations (2.1-1)–(2.1-3).



When [EMIM]Cl is present in a molar excess over AlCl<sub>3</sub>, only equilibrium (2.1-1) need be considered, and the ionic liquid is basic. When a molar excess of AlCl<sub>3</sub> over [EMIM]Cl is present on the other hand, an acidic ionic liquid is formed, and equilibria (2.1-2) and (2.1-3) predominate. Further details of the anion species present may be found elsewhere [23]. The chloroaluminates are not the only ionic liquids prepared in this manner. Other Lewis acids employed have included AlEtCl<sub>2</sub> [24], BCl<sub>3</sub> [25], CuCl [26], and SnCl<sub>2</sub> [27]. In general, the preparative methods employed for all of these salts are similar to those indicated for AlCl<sub>3</sub>-based ionic liquids as outlined below.

The most common method for the formation of such liquids is simple mixing of the Lewis acid and the halide salt, with the ionic liquid forming on contact of the two materials. The reaction is generally quite exothermic, which means that care should be taken when adding one reagent to the other. Although the salts are relatively thermally stable, the build-up of excess local heat can result in decomposition and discoloration of the ionic liquid. This may be prevented either by cooling the mixing vessel (often difficult to manage in a drybox), or else by adding one component to the other in small portions to allow the heat to dissipate. The water-sensitive nature of most of the starting materials (and ionic liquid products) means that the reaction is best carried out in a drybox. Similarly, the ionic liquids should ideally also be stored in a drybox until use. It is generally recommended, however, that only enough liquid to carry out the desired task be prepared, as decomposition by hydrolysis will inevitably occur over time unless the samples are stored in vacuum-sealed vials.

If a drybox is not available, the preparation can also be carried out by use of a dry, unreactive solvent (typically an alkane) as a “blanket” against hydrolysis. This has been suggested in the patent literature as a method for the large-scale industrial preparation of Lewis acid-based ionic liquids, as the solvent also acts as a heat-sink for the exothermic complexation reaction [28]. At the end of the reaction, the ionic liquid forms an immiscible layer beneath the protecting solvent. The ionic liquid may then either be removed by syringe, or else the solvent may be removed by distillation before use. In the former case it is likely that the ionic liquid will be contaminated with traces of the organic solvent, however.

Finally in this section, it is worth noting that some ionic liquids have been prepared by treatment of halide salts with metal halides that are not usually thought of as Lewis acids. In this case only equilibrium (2.1-1) above will apply, and the salts formed are neutral in character. Examples of these include salts of the type

[EMIM]<sub>2</sub>[MCl<sub>4</sub>] (R = alkyl, M = Co, Ni) [29] and [EMIM]<sub>2</sub>[VOCl<sub>4</sub>] [30]. These are formed by treatment of two equivalents of [EMIM]Cl with one equivalent of MCl<sub>2</sub> and VOCl<sub>2</sub>, respectively.

### 2.1.3.2 Anion Metathesis

The first preparation of relatively air- and water-stable ionic liquids based on 1,3-dialkyl-methylimidazolium cations (sometimes referred to as “second generation” ionic liquids) was reported by Wilkes and Zaworotko in 1992 [31]. This preparation involved a metathesis reaction between [EMIM]I and a range of silver salts (AgNO<sub>3</sub>, AgNO<sub>2</sub>, AgBF<sub>4</sub>, Ag[CO<sub>2</sub>CH<sub>3</sub>], and Ag<sub>2</sub>SO<sub>4</sub>) in methanol or aqueous methanol solution. The very low solubility of silver iodide in these solvents allowed it to be separated simply by filtration, and removal of the reaction solvent allowed isolation of the ionic liquids in high yields and purities. This method remains the most efficient for the synthesis of water-miscible ionic liquids, but is obviously limited by the relatively high cost of silver salts, not to mention the large quantities of solid by-product produced. The first report of a water-insoluble ionic liquid was two years later, with the preparation of [EMIM][PF<sub>6</sub>] from the reaction between [EMIM]Cl and HPF<sub>6</sub> in aqueous solution [32]. The procedures reported in the above two papers have stood the test of time, although subsequent authors have suggested refinements of the methods employed. Most notably, many of the [EMIM]<sup>+</sup>-based salts are solid at room temperature, facilitating purification, which may be achieved by recrystallisation. In many applications, however, a product that is liquid at room temperature is required, so most researchers now employ cations with 1-alkyl substituents of a chain length of four or greater, which results in a considerable lowering in melting point. Over the past few years, an enormous variety of anion exchange reactions has been reported for the preparation of ionic liquids. Table 2.1-1 gives a representative selection of both commonly used and more esoteric examples, along with references that give reasonable preparative details.

The preparative methods employed generally follow similar lines, however, and representative examples are therefore reviewed below. The main goal of all anion

**Table 2.1-1:** Examples of ionic liquids prepared by anion metathesis.

<b>Salt</b>	<b>Anion Source</b>	<b>Reference</b>
[Cation][PF <sub>6</sub> ]	HPF <sub>6</sub>	9, 15, 32, 33
[Cation][BF <sub>4</sub> ]	HBF <sub>4</sub> , NH <sub>4</sub> BF <sub>4</sub> , NaBF <sub>4</sub>	31, 32, 33, 34, 35
[Cation][(CF <sub>3</sub> SO <sub>2</sub> ) <sub>2</sub> N]	Li[(CF <sub>3</sub> SO <sub>2</sub> ) <sub>2</sub> N]	14, 33
[Cation][(CF <sub>3</sub> SO <sub>3</sub> )]	CF <sub>3</sub> SO <sub>3</sub> CH <sub>3</sub> , NH <sub>4</sub> [(CF <sub>3</sub> SO <sub>3</sub> )]	14, 36
[Cation][CH <sub>3</sub> CO <sub>2</sub> ]	Ag[CH <sub>3</sub> CO <sub>2</sub> ]	31
[Cation][CF <sub>3</sub> CO <sub>2</sub> ]	Ag[CF <sub>3</sub> CO <sub>2</sub> ]	31
[Cation][CF <sub>3</sub> (CF <sub>2</sub> ) <sub>3</sub> CO <sub>2</sub> ]	K[CF <sub>3</sub> (CF <sub>2</sub> ) <sub>3</sub> CO <sub>2</sub> ]	14
[Cation][NO <sub>3</sub> ]	AgNO <sub>3</sub> , NaNO <sub>3</sub>	14, 33, 37
[Cation][N(CN) <sub>2</sub> ]	Ag[N(CN) <sub>2</sub> ]	38
[Cation][CB <sub>11</sub> H <sub>12</sub> ]	Ag[CB <sub>11</sub> H <sub>12</sub> ]	39
[Cation][AuCl <sub>4</sub> ]	HAuCl <sub>4</sub>	40

exchange reactions is the formation of the desired ionic liquid uncontaminated with unwanted cations or anions, a task that is easier for water-immiscible ionic liquids. It should be noted, however, that low-melting salts based on symmetrical onium cations have been prepared by anion-exchange reactions for many years. For example, the preparation of tetrahexylammonium benzoate, a liquid at 25 °C, from tetrahexylammonium iodide, silver oxide, and benzoic acid was reported as early as 1967 [41]. The same authors also commented on an alternative approach involving the use of an ion-exchange resin for the conversion of the iodide salt to hydroxide, but concluded that this approach was less desirable. Low-melting salts based on cations such as tetrabutylphosphonium [42] and trimethylsulfonium [43] have also been produced by very similar synthetic methods.

To date, surprisingly few reports of the use of ion-exchange resins for large-scale preparation of ionic liquids have appeared in the open literature, to the best of the author's knowledge. One recent exception is a report by Lall et al. regarding the formation of phosphate-based ionic liquids with polyammonium cations [4]. Wasserscheid and Keim have suggested that this might be an ideal method for their preparation in high purity [3c].

As the preparation of water-immiscible ionic liquids is considerably more straightforward than that of the water-soluble analogues, these methods are considered first. The water solubility of the ionic liquids is very dependent on both the anion and cation present, and in general will decrease with increasing organic character of the cation. The most common approach for the preparation of water-immiscible ionic liquids is firstly to prepare an aqueous solution of a halide salt of the desired cation. The cation exchange is then carried out either with the free acid of the appropriate anion, or else with a metal or ammonium salt. Where available, the free acid is probably to be favored, as it leaves only HCl, HBr, or HI as the by-product, easily removable from the final product by washing with water. It is recommended that these reactions be carried out with cooling of the halide salt in an ice bath, as the metathesis reaction is often exothermic. In cases where the free acid is unavailable or inconvenient to use, however, alkali metal or ammonium salts may be substituted without major problems. It may also be preferable to avoid use of the free acid in systems where the presence of traces of acid may cause problems. A number of authors have outlined broadly similar methods for the preparation of  $[\text{PF}_6]^-$  and  $[(\text{CF}_3\text{SO}_2)_2\text{N}]^-$  salts that may be adapted for most purposes [14, 15].

When free acids are used, the washing should be continued until the aqueous residues are neutral, as traces of acid can cause decomposition of the ionic liquid over time. This can be a particular problem for salts based on the  $[\text{PF}_6]^-$  anion, which will slowly form HF, particularly on heating if not completely acid-free. When alkali metal or ammonium salts are used, it is advisable to check for the presence of halide anions in the wash solutions, for example by testing with silver nitrate solution. The high viscosity of some ionic liquids makes efficient washing difficult, even though the presence of water results in a considerable reduction in the viscosity. As a result, a number of authors have recently recommended dissolution of these liquids in either  $\text{CH}_2\text{Cl}_2$  or  $\text{CHCl}_3$  prior to carrying out the washing step. Another advantage of this procedure is that the organic solvent/ionic liquid

mixture may be placed over a drying agent such as  $\text{MgSO}_4$  prior to removal of the organic solvent, thus greatly reducing the amount of water contamination of the final product.

The preparation of water-miscible ionic liquids can be a more demanding process, as separation of the desired and undesired salts may be complex. The use of silver salts described above permits the preparation of many salts in very high purity, but is clearly too expensive for large-scale use. As a result, a number of alternative methodologies that employ cheaper salts for the metathesis reaction have been developed. The most common approach is still to carry out the exchange in aqueous solution with either the free acid of the appropriate anion, the ammonium salt, or an alkali metal salt. When using this approach, it is important that the desired ionic liquid can be isolated without excess contamination from unwanted halide-containing by-products. A reasonable compromise has been suggested by Welton et al. for the preparation of  $[\text{BMIM}][\text{BF}_4]$  [35]. In this approach, which could in principle be adapted to any water-miscible system, the ionic liquid is formed by metathesis between  $[\text{BMIM}]\text{Cl}$  and  $\text{HBF}_4$  in aqueous solution. The product is extracted into  $\text{CH}_2\text{Cl}_2$ , and the organic phase is then washed with successive small portions of deionized water until the washings are pH neutral. The presence of halide ions in the washing solutions can be detected by testing with  $\text{AgNO}_3$ . The  $\text{CH}_2\text{Cl}_2$  is then removed on a rotary evaporator, and the ionic liquid then further purified by mixing with activated charcoal for 12 hours. Finally, the liquid is filtered through a short column of acidic or neutral alumina and dried by heating in vacuo. Yields of around 70 % are reported when this approach is carried out on large (~ 1 molar) scale. Although the water wash can result in a lowering of the yield, the aqueous wash solutions may ultimately be collected together, the water removed, and the crude salt added to the next batch of ionic liquid prepared. In this manner, the amount of product lost is minimized, and the purity of the ionic liquid prepared appears to be reasonable for most applications.

Alternatively, the metathesis reaction may be carried out entirely in an organic solvent such as  $\text{CH}_2\text{Cl}_2$ , as described by Cammarata et al. [33], or acetone, as described by Fuller et al. [36]. In both of these systems the starting materials are not fully soluble in the reaction solvent, so the reaction is carried out with a suspension. In the case of the  $\text{CH}_2\text{Cl}_2$  process, it was performed by stirring the 1-alkyl-3-methylimidazolium halide salt with the desired metal salt at room temperature for 24 hours. After this, the insoluble halide by-products were removed by filtration. Although the halide by-products have limited solubility in  $\text{CH}_2\text{Cl}_2$ , they are much more soluble in the ionic liquid/ $\text{CH}_2\text{Cl}_2$  mixture. Thus, when this method is employed it is important that the  $\text{CH}_2\text{Cl}_2$  extracts be washed with water to minimize the halide content of the final product. This approach clearly results in a lowering of the yield of the final product, so care must be taken that the volume of water used to carry out the washing is low. Lowering of the temperature of the water to near 0 °C can also reduce the amount of ionic liquid lost. The final product was purified by stirring with activated charcoal followed by passing through an alumina column, as described in the previous paragraph. This process was reported to give final yields in the region of 70–80 %, and was used to prepare ionic liquids containing a



wide variety of anions ( $[\text{PF}_6]^-$ ,  $[\text{SbF}_6]^-$ ,  $[\text{BF}_4]^-$ ,  $[\text{ClO}_4]^-$ ,  $[\text{CF}_3\text{SO}_3]^-$ ,  $[\text{NO}_3]^-$ , and  $[\text{CF}_3\text{CO}_2]^-$ ). For the acetone route,  $[\text{EMIM}]\text{Cl}$  was stirred with  $\text{NH}_4\text{BF}_4$  or  $\text{NH}_4[\text{CF}_3\text{SO}_3]$  at room temperature for 72 hours. In this case all starting materials were only slightly soluble in the reaction solvent. Once again, the insoluble  $\text{NH}_4\text{Cl}$  by-product was removed by filtration. No water wash was carried out, but trace organic impurities were removed by stirring the acetone solution with neutral alumina for two hours after removal of the metal halide salts by filtration. The salts were finally dried by heating at 120 °C for several hours, after which they were analyzed for purity by electrochemical methods, giving quoted purities of at least 99.95 %.

#### 2.1.4

##### Purification of Ionic Liquids

The lack of significant vapor pressure prevents the purification of ionic liquids by distillation. The counterpoint to this is that any volatile impurity can, in principle, be separated from an ionic liquid by distillation. In general, however, it is better to remove as many impurities as possible from the starting materials, and where possible to use synthetic methods that either generate as few side products as possible, or allow their easy separation from the final ionic liquid product. This section first describes the methods employed to purify starting materials, and then moves on to methods used to remove specific impurities from the different classes of ionic liquids.

The first requirement is that all starting materials used for the preparation of the cation should be distilled prior to use. The author has found the methods described by Amarego and Perrin to be suitable in most cases [44]. In the preparation of  $[\text{RMIM}]^+$  salts, for example, we routinely distil the 1-methylimidazole under vacuum from sodium hydroxide, and then immediately store any that is not used under nitrogen in the refrigerator. The haloalkanes are first washed with portions of concentrated sulfuric acid until no further color is removed into the acid layer, then neutralized with  $\text{NaHCO}_3$  solution and deionized water, and finally distilled before use. All solvent used in quaternization or anion-exchange reactions should also be dried and distilled before use. If these precautions are not taken, it is often difficult to prepare colorless ionic liquids. In cases where the color of the ionic liquids is less important, the washing of the haloalkane may be unnecessary, as the quantity of colored impurity is thought to be extremely low, and thus will not affect many potential applications. It has also been observed that, in order to prepare  $\text{AlCl}_3$ -based ionic liquids that are colorless, it is usually necessary to sublime the  $\text{AlCl}_3$  prior to use (often more than once). It is recommended that the  $\text{AlCl}_3$  should be mixed with sodium chloride and aluminium wire for this process [22b].

$\text{AlCl}_3$ -based ionic liquids often contain traces of oxide ion impurities, formed by the presence of small amounts of water and oxygen. These are generally referred to as  $[\text{AlOCl}_2]^-$ , although  $^{17}\text{O}$  NMR measurements have indicated that a complex series of equilibria is in fact occurring [45]. It has been reported that these can be efficiently removed by bubbling phosgene ( $\text{COCl}_2$ ) through the ionic liquid [46]. In this

case the by-product of the reaction is  $\text{CO}_2$ , and thus easily removed under vacuum. This method should be approached with caution due to the high toxicity of phosphene, and an alternative approach using the less toxic triphosgene has also been reported more recently [47]. In the presence of water or other proton sources, chloroaluminate-based ionic liquids may contain protons, which will behave as a Brønsted superacid in acidic melts [48]. It has been reported that these may be removed simply by the application of high vacuum ( $< 5 \times 10^{-6}$  Torr) [49].

Purification of ionic liquids formed by anion metathesis can throw up a different set of problems, as already noted in Section 2.1.3.2. In this case the most common impurities are halide anions, or unwanted cations inefficiently separated from the final product. The presence of such impurities can be extremely detrimental to the performance of the ionic liquids, particularly in applications involving transition metal-based catalysts, which are often deactivated by halide ions. In general this is much more of a problem in water-soluble ionic liquids, as water-immiscible salts can usually be purified quite efficiently by washing with water. The methods used to overcome this problem have already been covered in the previous section. The problems inherent in the preparation of water-miscible salts have been highlighted by Seddon et al. [37], who studied the  $\text{Na}^+$  and  $\text{Cl}^-$  concentrations in a range of ionic liquids formed by treatment of [EMIM]Cl and [BMIM]Cl with  $\text{Ag}[\text{BF}_4]$ ,  $\text{Na}[\text{BF}_4]$ ,  $\text{Ag}[\text{NO}_3]$ ,  $\text{Na}[\text{NO}_3]$ , and  $\text{HNO}_3$ . They found that the physical properties such as density and viscosity of the liquids can be radically altered by the presence of unwanted ions. The results showed that all preparations using  $\text{Na}^+$  salts resulted in high residual concentrations of  $\text{Cl}^-$ , while the use of  $\text{Ag}^+$  salts gave rise to much lower levels. The low solubility of  $\text{NaCl}$  in the ionic liquids, however, indicates that the impurities arise from the fact that the reaction with the  $\text{Na}^+$  salts does not proceed to completion. Indeed, it was reported in one case that unreacted [BMIM]Cl was isolated by crystallization from [BMIM][ $\text{NO}_3$ ]. A further example of the potential hazards of metal-containing impurities in ionic liquids is seen when [EMIM][ $\text{CH}_3\text{CO}_2$ ] is prepared from [EMIM]Cl and  $\text{Pb}[\text{CH}_3\text{CO}_2]_4$  [50]. The resulting salt has been shown to contain ca. 0.5 M residual lead [51].

In practical terms, it is suggested that, in any application where the presence of halide ions may cause problems, the concentration of these be monitored to ensure the purity of the liquids. This may be achieved either by the use of an ion-sensitive electrode, or alternatively by use of a chemical method such as the Völlhard procedure for chloride ions [52]. Seddon et al. have reported that effectively identical results were obtained with either method [37].

Most ionic liquids based on the common cations and anions should be colorless, with minimal absorbance at wavelengths greater than 300 nm. In practice, the salts often take on a yellow hue, particularly during the quaternization step. The amount of impurity causing this is generally extremely small, being undetectable by  $^1\text{H}$  NMR or CHN microanalysis, and in many applications the discoloration may not be of any importance. This is clearly not the case, however, when the solvents are required for photochemical or UV/visible spectroscopic investigations. To date, the precise origins of these impurities have not been determined, but it seems likely that they arise from unwanted side reactions involving oligomerization or polymer-

ization of small amounts of free amine, or else from impurities in the haloalkanes. Where it is important that the liquids are colorless, however, the color may be minimized by following a few general steps:

- All starting materials should be purified as discussed above [44].
- The presence of traces of acetone can sometimes result in discoloration during the quaternization step. Thus, all glassware used in this step should be kept free of this solvent.
- The quaternization reaction should be carried out either in a system that has been degassed and sealed under nitrogen, or else under a flow of inert gas such as nitrogen. Furthermore the reaction temperature should be kept as low as possible (no more than ca. 80 °C for Cl<sup>-</sup> salts, and lower for Br<sup>-</sup> and I<sup>-</sup> salts).

If the liquids remain discolored even after these precautions, it is often possible to purify them further by first stirring with activated charcoal, followed by passing the liquid down a short column of neutral or acidic alumina as discussed in Section 2.1.3.2 [33].

Clearly, the impurity likely to be present in largest concentrations in most ionic liquids is water. The removal of other reaction solvents is generally easily achieved by heating the ionic liquid under vacuum. Water is generally one of the most problematic solvents to remove, and it is generally recommended that ionic liquids be heated to at least 70 °C for several hours with stirring to achieve an acceptably low degree of water contamination. Even water-immiscible salts such as [BMIM][PF<sub>6</sub>] can absorb up to ca. 2 wt.% water on equilibration with the air, corresponding to a water concentration of ca. 1.1 M. Thus it is advised that all liquids be dried directly before use. If the amount of water present is of importance, it may be determined either by Karl–Fischer titration, or a less precise determination may be carried out using IR spectroscopy.

#### 2.1.5

#### Conclusions

It is hoped that this section will give the reader a better appreciation of the range of ionic liquids that have already been prepared, as well as a summary of the main techniques involved and the potential pitfalls. While the basic chemistry involved is relatively straightforward, the preparation of ionic liquids of known purity may be less easily achieved, and it is hoped that the ideas given here may be of assistance to the reader. It should also be noted that many of the more widely used ionic liquids are now commercially available from a range of suppliers, including some specializing in the synthesis of ionic liquids [53].



## References

- 1 P. Walden, *Bull. Acad. Imper. Sci. (St. Petersburg)* **1914**, 1800.
- 2 R.M. Pagni, *Advances in Molten Salt Chemistry* **6**, Eds. G. Mamantov, C.B. Mamantov, and J. Braunstein, Elsevier: New York **1987**, pp 211–346.
- 3 (a) C.M. Gordon, *Appl. Cat. A, General* **2001**, *222*, 101. (b) R.A. Sheldon, *Chem. Commun.* **2001**, 2399. (c) P. Wasserscheid and W. Keim, *Angew. Chem., Int. Ed.* **2000**, *39*, 3772. (d) J.D. Holbrey and K.R. Seddon, *Clean Prod. Processes* **1999**, *1*, 223. (e) T. Welton, *Chem. Rev.* **1999**, *99*, 2071.
- 4 S.I. Lall, D. Mancheno, S. Castro, V. Behaj, J.L.I. Cohen, and R. Engel, *Chem. Commun.* **2000**, 2413.
- 5 J.H. Davis, Jr., K.J. Forrester, and T. Merrigan, *Tetrahedron Lett.* **1998**, *39*, 8955.
- 6 J.S. Wilkes, J.A. Levisky, R.A. Wilson, and C.L. Hussey, *Inorg. Chem.* **1982**, *21*, 1263.
- 7 D.F. Evans, A. Yamouchi, G.J. Wei, and V.A. Bloomfield, *J. Phys. Chem.* **1983**, *87*, 3537.
- 8 C.K. Lee, H.W. Huang, and I.J.B. Lin, *Chem. Commun.* **2000**, 1911.
- 9 C.M. Gordon, J.D. Holbrey, A.R. Kennedy, and K.R. Seddon, *J. Mater. Chem.* **1998**, *8*, 2627.
- 10 A.E. Visser, J.D. Holbrey, and R.D. Rogers, *Chem. Commun.* **2001**, 2484.
- 11 T. Kitazume, F. Zulfiqar, and G. Tanaka, *Green Chem.* **2000**, *2*, 133.
- 12 D.R. MacFarlane, P. Meakin, J. Sun, N. Amini, and M. Forsyth, *J. Phys. Chem. B* **1999**, *103*, 4164.
- 13 J. Sun, M. Forsyth, D.R. MacFarlane, *J. Phys. Chem. B* **1998**, *102*, 8858.
- 14 P. Bonhôte, A.-P. Dias, N. Papageorgiou, K. Kalyanasundaram, and M. Grätzel, *Inorg. Chem.* **1996**, *35*, 1168.
- 15 J.G. Huddleston, H.D. Willauer, R.P. Swatowski, A.E. Visser, and R.D. Rogers, *Chem. Commun.* **1998**, 1765.
- 16 P. Lucas, N. El Mehdi, H.A. Ho, D. Bélanger, and L. Breau, *Synthesis* **2000**, 1253.
- 17 R.S. Varma and V.V. Nambodiri, *Chem. Commun.* **2001**, 643.
- 18 J.A. Holbrey, K.R. Seddon, and R. Wareing, *Green Chem.* **2001**, *3*, 33.
- 19 H. Waffenschmidt, Dissertation, RWTH Aachen, Germany **2000**.
- 20 N. Karodia, S. Guise, C. Newlands, and J.-A. Andersen, *Chem. Commun.* **1998**, 2341.
- 21 F.H. Hurley and T.P. Wier, *J. Electrochem. Soc.* **1951**, *98*, 203.
- 22 (a) H.L. Chum, V.R. Koch, L.L. Miller, and R.A. Osteryoung, *J. Am. Chem. Soc.* **1975**, *97*, 3264. (b) J. Robinson and R.A. Osteryoung, *J. Am. Chem. Soc.* **1979**, *101*, 323.
- 23 H.A. Øye, M. Jagtoyen, T. Oksefjell, J.S. Wilkes, *Mater. Sci. Forum* **1991**, *73–75*, 183.
- 24 (a) Y. Chauvin, S. Einloft, and H. Olivier, *Ind. Eng. Chem. Res.* **1995**, *34*, 1149. (b) B. Gilbert, Y. Chauvin, H. Olivier, F. DiMarco-van Tiggelen, *J. Chem. Soc., Dalton Trans.* **1995**, 3867.
- 25 S.D. Williams, J.P. Schoebrechts, J.C. Selkirk, G. Mamantov, *J. Am. Chem. Soc.* **1987**, *109*, 2218.
- 26 Y. Chauvin and H. Olivier-Bourbigou, *CHEMTECH* **1995**, *25*, 26.
- 27 G.W. Parshall, *J. Am. Chem. Soc.* **1972**, *94*, 8716.
- 28 S. Mori, K. Ida, H. Suzuki, S. Takahashi, I Saeki, *Eur. Pat.*, EP 90111879.4 (Check!)
- 29 P.B. Hitchcock, K.R. Seddon, and T. Welton, *J. Chem. Soc., Dalton Trans.* **1993**, 2639.
- 30 P.B. Hitchcock, R.J. Lewis, and T. Welton, *Polyhedron* **1993**, *12*, 2039.
- 31 J.S. Wilkes and M.J. Zaworotko, *Chem. Commun.* **1992**, 965.
- 32 J. Fuller, R.T. Carlin, H.C. DeLong, and D. Haworth, *Chem. Commun.* **1994**, 299.
- 33 L. Cammarata, S. Kazarian, P. Salter, and T. Welton, *Phys. Chem. Chem. Phys.* **2001**, *3*, 5192.
- 34 J.D. Holbrey and K.R. Seddon, *J. Chem. Soc., Dalton Trans.* **1999**, 2133.
- 35 N. L. Lancaster, T. Welton, G.B. Young, *J. Chem. Soc., Perkin Trans. 2* **2001**, 2267.

- 36 J. Fuller and R.T. Carlin, *Proc. Electrochem. Soc.* **1999**, 98, 227.
- 37 K.R. Seddon, A. Stark, and M.-J. Torres, *Pure Appl. Chem.* **2000**, 72, 2275.
- 38 D.R. McFarlane, J. Golding, S. Forsyth, M. Forsyth, and G.B. Deacon, *Chem. Commun.* **2001**, 2133.
- 39 A.S. Larsen, J.D. Holbrey, F.S. Tham, and C.A. Reed, *J. Am. Chem. Soc.* **2000**, 122, 7264.
- 40 M. Hasan, I.V. Kozhevnikov, M.R.H. Siddiqui, A. Steiner, and N. Winter-ton, *Inorg. Chem.* **1999**, 38, 5637.
- 41 C.G. Swain, A. Ohno, D.K. Roe, R. Brown, and T. Maugh, II, *J. Am. Chem. Soc.* **1967**, 89, 2648.
- 42 R.M. Pomaville, S.K. Poole, L.J. Davis, and C.F. Poole, *J. Chromatog.* **1988**, 438, 1.
- 43 H. Matsumoto, T. Matsuda, and Y. Miyazaki, *Chem. Lett.* **2000**, 1430.
- 44 W.L.F. Armarego and D.D. Perrin, *Purification of laboratory chemicals*, 4<sup>th</sup> Ed., Butterworth-Heinemann **1997**.
- 45 T.A. Zawodzinski and R.A. Osteryoung, *Inorg. Chem.* **1990**, 29, 2842.
- 46 (a) A.K. Abdul-Sada, A.G. Avent, M.J. Parkington, T.A. Ryan, K.R. Seddon, and T. Welton, *Chem. Commun.* **1987**, 1643. (b) A.K. Abdul-Sada, A.G. Avent, M.J. Parkington, T.A. Ryan, K.R. Seddon, and T. Welton, *J. Chem. Soc., Dalton Trans.* **1993**, 3283.
- 47 A.J. Dent, A. Lees, R.J. Lewis, and T. Welton, *J. Chem. Soc., Dalton Trans.* **1996**, 2787.
- 48 (a) G.P. Smith, A.S. Dworkin, R.M. Pagni, and S.P. Zing, *J. Am. Chem. Soc.* **1989**, 111, 525. (b) G.P. Smith, A.S. Dworkin, R.M. Pagni, and S.P. Zing, *J. Am. Chem. Soc.* **1989**, 111, 5075. (c) S.-G. Park, P.C. Trulove, R.T. Carlin, and R.A. Osteryoung, *J. Am. Chem. Soc.* **1991**, 113, 3334.
- 49 M.A.M. Noel, P.C. Trulove, and R.A. Osteryoung, *Anal. Chem.* **1991**, 63, 2892.
- 50 B. Ellis, *Int. Pat.*, WO 96/18459 **1996**.
- 51 J.T. Hamill, C. Hardacre, M. Nieuwenhuyzen, K.R. Seddon, S.A. Thompson, and B. Ellis, *Chem. Commun.* **2000**, 1929.
- 52 A.I. Vogel, *A Textbook of Quantitative Inorganic Analysis*, 3<sup>rd</sup> ed., Longmans, Green and Co., London, **1961**.
- 53 (a) <http://www.solvent-innovation.com>. (b) <http://www.covalentassociates.com>.

## 2.2

### Quality Aspects and Other Questions Related to Commercial Ionic Liquid Production

*Claus Hilgers and Peter Wasserscheid*

#### 2.2.1

##### Introduction

From Section 2.1 it has become very clear that the synthesis of an ionic liquid is in general quite simple organic chemistry, while the preparation of an ionic liquid of a certain quality requires some know-how and experience. Since neither distillation nor crystallization can be used to purify ionic liquids after their synthesis (due to their nonvolatility and low melting points), maximum care has to be taken before and during the ionic liquid synthesis to obtain the desired quality.

Historically, the know-how to synthesize and handle ionic liquids has been treated somehow like a “holy grail”. Up to the mid-1990s, indeed, only a small number of specialized industrial and academic research groups were able to prepare and

handle the highly hygroscopic chloroaluminate ionic liquids that were the only ionic liquid systems available in larger amounts. Acidic chloroaluminate ionic liquids, for example, have to be stored in glove-boxes to prevent their contamination with traces of water. Water impurities are known to react with the anions of the melt with release of superacidic protons. These cause unwanted side reactions in many applications and possess considerable potential for corrosion (a detailed description of protic and oxidic impurities in chloroaluminate melts is given in Welton's 1999 review article [1]). This need for very special and expensive handling techniques has without doubt prevented the commercial production and distribution of chloroaluminate ionic liquids, even up to the present day.

The introduction of the more hydrolysis-stable tetrafluoroborate [2] and hexafluorophosphate systems [3], and especially the development of their synthesis by means of metathesis from alkali salts [4], can be regarded as a first key step towards commercial ionic liquid production.

However, it still took its time. When the authors founded Solvent Innovation [5] in November 1999, the commercial availability of ionic liquids was still very limited. Only a small number of systems could be purchased from Sigma–Aldrich, in quantities of up to 5 g [6].

Besides Solvent Innovation, a number of other commercial suppliers nowadays offer ionic liquids in larger quantities [7]. Moreover, the distribution of these liquids by Fluka [8], Acros Organics [9], and Wako [10] assures a certain availability of different ionic liquids on a rapid-delivery basis.

From discussions with many people now working with ionic liquids, we know that, at least for the start of their work, the ability to buy an ionic liquid was important. In fact, a synthetic chemist searching for the ideal solvent for his or her specific application usually takes solvents that are ready for use on the shelf of the laboratory. The additional effort of synthesizing a new special solvent can rarely be justified, especially in industrial research. Of course, this is not only true for ionic liquids. Very probably, nobody would use acetonitrile as a solvent in the laboratory if they had to synthesize it before use.

The commercial availability of ionic liquids is thus a key factor for the actual success of ionic liquid methodology. Apart from the matter of lowering the “activation barrier” for those synthetic chemists interested in entering the field, it allows access to ionic liquids for those communities that do not traditionally focus on synthetic work. Physical chemists, engineers, electrochemists, and scientists interested in developing new analytical tools are among those who have already developed many new exciting applications by use of ionic liquids [11].

### 2.2.2

#### **Quality Aspects of Commercial Ionic Liquid Production**

With ionic liquids now commercially available, it should not be forgotten that an ionic liquid is still a quite different product from traditional organic solvents, simply because it cannot be purified by distillation, due to its nonvolatile character. This, combined with the fact that small amounts of impurities can influence the

ionic liquid's properties significantly [12], makes the quality of an ionic liquid quite an important consideration.

Ionic liquid synthesis in a commercial context is in many respects quite different from academic ionic liquid preparation. While, in the commercial scenario, labor-intensive steps add significantly to the price of the product (which, next to quality, is another important criterion for the customer), they can easily be justified in academia to obtain a purer material. In a commercial environment, the desire for absolute quality of the product and the need for a reasonable price have to be reconciled. This is not new, of course. If one looks into the very similar business of phase-transfer catalysts or other ionic modifiers (such as commercially available ammonium salts), one rarely finds absolutely pure materials. Sometimes the active ionic compound is only present in about 85 % purity. However, and this is a crucial point, the product is well specified, the nature of the impurities is known, and the quality of the material is absolutely reproducible from batch to batch.

From our point of view, this is exactly what commercial ionic liquid production is about. Commercial producers try to make ionic liquids in the highest quality that can be achieved at reasonable cost. For some ionic liquids they can guarantee a purity greater than 99 %, for others perhaps only 95 %. If, however, customers are offered products with stated natures and amounts of impurities, they can then decide what kind of purity grade they need, given that they do have the opportunity to purify the commercial material further themselves. Since trace analysis of impurities in ionic liquids is still a field of ongoing fundamental research, we think that anybody who really needs (or believes that they need) a purity of greater than 99.99 % should synthesize or purify the ionic liquid themselves. Moreover, they may still need to develop the methods to specify this purity.

The following subsections attempt to comment upon common impurities in commercial ionic liquid products and their significance for known ionic liquid applications. The aim is to help the reader to understand the significance of different impurities for their application. Since chloroaluminate ionic liquids are not produced or distributed commercially, we do not deal with them here.

#### 2.2.2.1 Color

From the literature one gets the impression that ionic liquids are all colorless and look almost like water. However, most people who start ionic liquid synthesis will probably get a highly colored product at first. The chemical nature of the colored impurities in ionic liquids is still not very clear, but it is probably a mixture of traces of compounds originating from the starting materials, oxidation products, and thermal degradation products of the starting materials. Sensitivity to coloration during ionic liquid synthesis can vary significantly with the type of cation and anion of the ionic liquid. Pyridinium salts, for instance, tend to form colored impurities more easily than imidazolium salts do.

Section 2.1 excellently describes methods used to produce colorless ionic liquids. From this it has become obvious that freshly distilled starting materials and low-temperature processing during the synthesis and drying steps are key aspects for avoidance of coloration of the ionic liquid.

From a commercial point of view, it is possible to obtain colorless ionic liquids, but not on a large scale at reasonable cost. If one wants to obtain colorless material, then the labor-intensive procedures described in Section 2.1 have to be applied.

For a commercial producer, three points are important in this context:

- a) The colored impurities are usually present only in trace amounts. It is impossible to detect them by NMR or by analytical techniques other than UV/VIS spectroscopy. Hence the difficulty in determining the chemical structure of the colored impurities.
- b) For almost all applications involving ionic liquids, the color is not the **crucial** parameter. In catalytic applications, for example, it appears that the concentration of colored impurities is significantly lower than commonly used catalyst concentrations. Exceptions are, of course, any application in which UV spectroscopy is used for product or catalyst analysis and for all photochemical applications.
- c) Prevention of coloration of the ionic liquid is not really compatible with the aim of a rational economic ionic liquid production. Additional distillative cleaning of the feedstocks consumes time and energy, and additional cleaning by chromatography after synthesis is also a time-consuming step. The most important restriction, however, is the need to perform synthesis (mainly the alkylation step) with good feedstocks at the lowest possible temperature, and thus at the slowest rate. This requires long reaction times and therefore high plant cost.

A compromise between coloration and economics in commercial ionic liquid production is therefore necessary. Since chromatographic decoloration steps are known and relatively easy to perform (see Section 2.2.3), we would not expect there to be a market for a colorless ionic liquid, if the same substance can be made in a slightly colored state, but at a much lower price.

#### 2.2.2.2 Organic Starting Materials and other Volatiles

Volatile impurities in an ionic liquid may have different origins. They may result from solvents used in the extraction steps during the synthesis, from unreacted starting materials from the alkylation reaction (to form the ionic liquid's cation), or from any volatile organic compound previously dissolved in the ionic liquid.

In theory, volatile impurities can easily be removed from the nonvolatile ionic liquid by simple evaporation. However, this process can sometimes take a considerable time. Factors that influence the time required for the removal of all volatiles from an ionic liquid (at a given temperature and pressure) are: a) the amount of volatiles, b) their boiling points, c) their interactions with the ionic liquid, d) the viscosity of the ionic liquid, and e) the surface of the ionic liquid.

A typical example of a volatile impurity that can be found as one of the main impurities in low-quality ionic liquids with alkylmethylimidazolium cations is the methylimidazole starting material. Because of its high boiling point (198 °C) and its strong interaction with the ionic liquid, this compound is very difficult to remove from an ionic liquid even at elevated temperature and high vacuum. It is therefore important to make sure, by use of appropriate alkylation conditions, that no unreacted methylimidazole is left in the final product.



Traces of bases such as methylimidazole in the final ionic liquid product can play an unfavorable role in some common applications of ionic liquids (such as biphasic catalysis). Many electrophilic catalyst complexes will coordinate the base in an irreversible manner and be deactivated.

A number of different methods to monitor the amount of methylimidazole left in a final ionic liquid are known. NMR spectroscopy is used by most academic groups, but may have a detection limit of about 1 mol%. The photometric analysis described by Holbrey, Seddon, and Wareing has the advantage of being a relatively quick method that can be performed with standard laboratory equipment [13]. This makes it particularly suitable for monitoring of the methylimidazole content during commercial ionic liquid synthesis. The method is based on the formation and colorimetric analysis of the intensely colored complex of 1-methylimidazole with copper(II) chloride.

### 2.2.2.3 Halide Impurities

Many ionic liquids (among them the most commonly used tetrafluoroborate and hexafluorophosphate systems) are still made in two-step syntheses. In the first step, an amine or phosphine is alkylated to form the cation. For this reaction, alkyl halides are frequently used as alkylating agents, forming halide salts of the desired cation. To obtain a non-halide ionic liquid, the halide anion is exchanged in a second step. This can be achieved variously by addition of the alkali salt of the desired anion (with precipitation of the alkali halide salt), by treatment with a strong acid (with removal of the hydrohalic acid), or by use of an ion-exchange resin (for more details see Section 2.1). Alternative synthetic procedures involving the use of silver [2] or lead salts [14] are – at least from our point of view – not acceptable for commercial ionic liquid production.

All the halide exchange reactions mentioned above proceed more or less quantitatively, causing greater or lesser quantities of halide impurities in the final product. The choice of the best procedure to obtain complete exchange depends mainly on the nature of the ionic liquid that is being produced. Unfortunately, there is no general method to obtain a halide-free ionic liquid that can be used for all types of ionic liquid. This is explained in a little more detail for two defined examples: the synthesis of [BMIM][ $(\text{CF}_3\text{SO}_2)_2\text{N}$ ] and the synthesis of [EMIM][ $\text{BF}_4$ ].

[BMIM][ $(\text{CF}_3\text{SO}_2)_2\text{N}$ ] has a miscibility gap with water (about 1.4 mass% of water dissolves in the ionic liquid [15]) and shows high stability to hydrolysis. It is therefore very easy to synthesize this ionic liquid in a halide-free state. In a procedure first described by Böhne and Grätzel [15], [BMIM]Cl (obtained by alkylation of methylimidazole with butyl chloride) and  $\text{Li}[(\text{CF}_3\text{SO}_2)_2\text{N}]$  are both dissolved in water. As the aqueous solutions are mixed, the ionic liquid is formed as a second layer. After separation from the aqueous layer, the ionic liquid can easily be washed with water to a point where no traces of halide ions are detectable in the washing water (by titration with  $\text{AgNO}_3$ ). After drying of the ionic liquid phase, an absolutely halide-free ionic liquid can be obtained (determination by ion chromatography, by titration with  $\text{AgNO}_3$ , or by electrochemical analysis).

The halide-free preparation of [EMIM][BF<sub>4</sub>], however, is significantly more difficult. Since this ionic liquid is completely miscible with water and so cannot be re-extracted from aqueous solution with CH<sub>2</sub>Cl<sub>2</sub> or other organic solvents, removal of the halide ions by a washing procedure with water is not an option. A metathesis reaction in water-free acetone or CH<sub>2</sub>Cl<sub>2</sub> is possible, but suffers from the low solubility of Na[BF<sub>4</sub>] in these solvents and the long reaction times. Exchange reactions in this type of suspension therefore take a long time and, when carried out on larger scales, tend to be incomplete even after long reaction times. Consequently, to synthesize [EMIM][BF<sub>4</sub>] of completely halide-free quality, special procedures have to be applied. Two examples are synthesis with use of an ion-exchange resin [16] or the direct alkylation of ethylimidazole with Meerwein's reagent [Me<sub>3</sub>O][BF<sub>4</sub>].

Generally, the presence of halide impurities is not (as with the ionic liquid's color) a question of having a nice-looking ionic liquid or not. On the contrary, the halide content can seriously affect the usefulness of the material as a solvent for a given chemical reaction. Apart from the point that some physicochemical properties are highly dependent on the presence of halide impurities (as demonstrated by Seddon and al. [12]), the latter can chemically act as catalyst poisons [17], stabilizing ligands [18], nucleophiles, or reactants, depending on the chemical nature of the reaction. It is consequently necessary to have an ionic liquid free of halide impurities to investigate its properties for any given reaction, especially in catalysis, in which the amount of catalyst used can be in the range of the concentration of the halide impurities in the ionic liquid.

#### 2.2.2.4 Protic Impurities

Protic impurities have to be taken into account for two groups of ionic liquids: those that have been produced by an exchange reaction involving a strong acid (often the case, for example, for [BMIM][PF<sub>6</sub>]), and those that are sensitive to hydrolysis. In the latter case, the protons may originate from the hydrolysis of the anion, forming an acid that may be dissolved in the ionic liquid.

For ionic liquids that do not mix completely with water (and which display sufficient hydrolysis stability), there is an easy test for acidic impurities. The ionic liquid is added to water and a pH test of the aqueous phase is carried out. If the aqueous phase is acidic, the ionic liquid should be washed with water to the point where the washing water becomes neutral. For ionic liquids that mix completely with water we recommend a standardized, highly proton-sensitive test reaction to check for protic impurities.

Obviously, the check for protic impurities becomes crucial if the ionic liquid is to be used for applications in which protons are known to be active compounds. For some organic reactions, one has to be sure that an "ionic liquid effect" does not turn out to be a "protic impurity effect" at some later stage of the research!

#### 2.2.2.5 Other Ionic Impurities from Incomplete Metathesis Reactions

Apart from halide and protic impurities, ionic liquids can also be contaminated with other ionic impurities from the metathesis reaction. This is especially likely if the alkali salt used in the metathesis reaction shows significant solubility in the



ionic liquid formed. In this case, the ionic liquid can contain significant amounts of the alkali salt. While this may not be a problem even for some catalytic applications (since the presence of the alkali cation may not affect the catalytic cycle of a transition metal catalyst), it is of great relevance for the physicochemical properties of the melt.

In this context it is important to note that the detection of this kind of alkali cation impurity in ionic liquids is not easy with traditional methods for reaction monitoring in ionic liquid synthesis (such as conventional NMR spectroscopy). More specialized procedures are required to quantify the amount of alkali ions in the ionic liquid or the quantitative ratio of organic cation to anion. Quantitative ion chromatography is probably the most powerful tool for this kind of quality analysis.

Because of these analytical problems, we expect that some of the disagreements in the literature (mainly concerning the physicochemical data of some tetrafluoroborate ionic liquids) may have their origins in differing amounts of alkali cation impurities in the ionic liquids analyzed.

#### 2.2.2.6 Water

Without special drying procedures and completely inert handling, water is omnipresent in ionic liquids. Even the apparently hydrophobic ionic liquid [BMIM][ $(CF_3SO_2)_2N$ ] saturates with about 1.4 mass% of water [15], a significant molar amount. For more hydrophilic ionic liquids, water uptake from air can be much greater. Imidazolium halide salts in particular are known to be extremely hygroscopic, one of the reasons why it is so difficult to make completely proton-free chloroaluminate ionic liquids.

For commercial ionic liquid production, this clearly means that all products contain some greater or lesser amount of water. Depending on the production conditions and the logistics, the ionic liquids can reasonably be expected to come into some contact with traces of water.

Water in an ionic liquid may be a problem for some applications, but not for others. However, one should in all cases know the approximate amount of water present in the ionic liquid used. Moreover, one should be aware of the fact that water in the ionic liquid may not be inert and, furthermore, that the presence of water can have significant influence on the physicochemical properties of the ionic liquid, on its stability (some wet ionic liquids may undergo hydrolysis with formation of protic impurities), and on the reactivity of catalysts dissolved in the ionic liquid.

### 2.2.3

#### Upgrading of Commercial Ionic Liquids

For all research carried out with commercial ionic liquids we recommend a serious quality check of the product prior to work. As already mentioned, a good commercial ionic liquid may be colored and may contain some traces of water. However, it should be free of organic volatiles, halides (if not an halide ionic liquid), and all ionic impurities.

To remove water, commercial ionic liquids used for fundamental research purposes should be dried at 60 °C in vacuo overnight. The water content should be checked prior to use. This can be done qualitatively by infrared spectroscopy or cyclic voltametric measurements, or quantitatively by Karl–Fischer titration. If the ionic liquids cannot be dried to zero water content for any reason, the water content should always be mentioned in all descriptions and documentation of the experiments to allow proper interpretation of the results obtained.

Regarding the color, we only see a need for colorless ionic liquids in very specific applications (see above). One easy treatment that often reduces coloration quite impressively, especially of imidazolium ionic liquids, is purification by column chromatography/filtration over silica 60. For this purification method, the ionic liquid is dissolved in a volatile solvent such as  $\text{CH}_2\text{Cl}_2$ . Usually, most of the colored impurities stick to the silica, while the ionic liquid is eluted with the solvent. By repetition of the process several times, a seriously colored ionic liquid can be converted into an almost completely colorless material.

#### 2.2.4

#### Scaling-up of Ionic Liquid Synthesis

For commercial ionic liquid synthesis, quality is a key factor. However, since availability and price are other important criteria for the acceptance of this new solvent concept, the scaling-up of ionic liquid production is a major research interest too.



**Figure 2.2-1:** One of Solvent Innovation's production plants at the Institut für Technische Chemie und Makromolekulare Chemie, University of Technology Aachen, Germany.

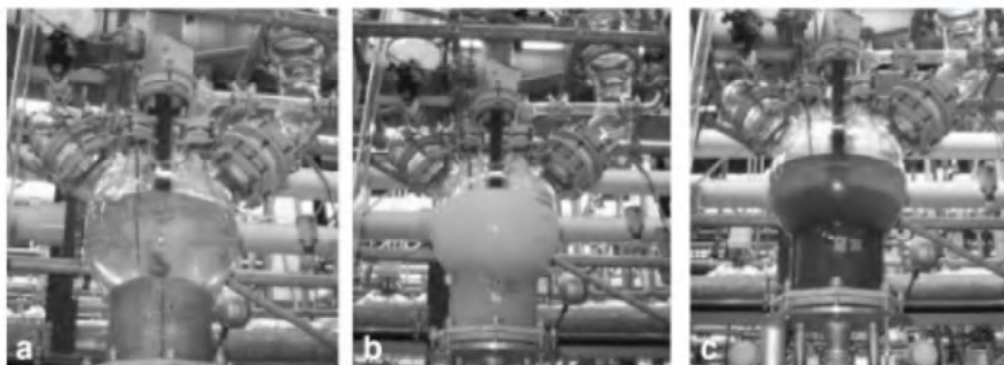

**Figure 2.2-2:** Synthesis of [BMIM]Cl in a 30 litre scale in three stages. a) start of the reaction; b) the reaction vessel after 10 min reaction time; c) some ionic liquid product at elevated temperature.

Many historical ways to make ionic liquids proved to be impractical on larger scales. Sometimes expensive starting materials are used (anion-exchange with silver salts, for example [2]), or very long reaction times are necessary for the alkylation steps, or filtration procedures are included in the synthesis, or hygroscopic solids have to be handled. All these have to be avoided for a good synthesis on larger scales.

Other important aspects to consider during the scaling-up of ionic liquid synthesis are heat management (alkylation reactions are exothermic!) and proper mass transport. For both of these the proper choice of reactor set-up is of crucial importance.

Figure 2.2-1 shows one of Solvent Innovation's production plants at the Institut für Technische Chemie und Makromolekulare Chemie, Aachen University of Technology, Germany. Figure 2.2-2 shows the synthesis of [BMIM]Cl on a 30 liter scale in three stages: a) start of the reaction, b) the reaction vessel after 10 min reaction time, and c) some ionic liquid product at elevated temperature.

### 2.2.5

#### HSE data

The production of ionic liquids on larger scales raises the question of registration of these new materials and the acquisition of HSE data. Surprisingly enough, although ionic liquids have been around for quite some years, very few data are available in this respect. Early investigations studied the effect of a basic chloroaluminate systems on the skin of rats [19]. Very recently, the acute toxicity of 1-hexyloxymethyl-3-methylimidazolium tetrafluoroborate was assessed by Pernak et al., by the Gadumm method [20]. The values were found to be  $LD_{50} = 1400 \text{ mg kg}^{-1}$  for female Wistar rats and  $LD_{50} = 1370 \text{ mg kg}^{-1}$  for males. The authors concluded that the tetrafluoroborate salt could be used safely.

These preliminary studies notwithstanding, much more HSE data for ionic liquids will be needed in the near future. We anticipate that commercial suppliers will

play a leading role in the acquisition of these data, since considerable sums of money are involved in full HSE characterization of ionic liquids.

In the meantime, we believe that the best prediction of the toxicity of an ionic liquid of type [cation][anion] can be derived from the often well known toxicity data for the salts [cation]Cl and Na[anion]. Since almost all chemistry in nature takes place in aqueous media, the ions of the ionic liquid can be assumed to be present in dissociated form. Therefore, a reliable prediction of ionic liquids' HSE data should be possible from a combination of the known effects of the alkali metal and chloride salts. Already from these, very preliminary, studies, it is clear that HSE considerations will be an important criterion in selection and exclusion of specific ionic liquid candidates for future large-scale, technical applications.

#### 2.2.6

#### Future Price of Ionic Liquids

The price of ionic liquids is determined by many parameters, such as personnel, overheads, and real production costs. One can imagine that production on a small scale would be mostly determined by the personnel cost and little by the material cost. On a large scale, the material cost should become more important and mainly determine the price of an ionic liquid. This means that the price of a large-scale commercial ionic liquid should be dictated by the price of the cation and anion source.

Table 2.2-1 shows a list of typical cations and anions ordered by their rough price on an industrial scale.

This table illustrates pretty well that the large-scale ionic liquid will probably not comprise a dialkylimidazolium cation and a  $[\text{CF}_3\text{SO}_2)_2\text{N}]^-$  anion. Over a medium-term timescale, we would expect a range of ionic liquids to become commercially available for € 25–50 per liter on a ton scale. Halogen-free systems made from cheap anion sources are expected to meet this target first.

**Scheme 2.2-1:** Typical ions making up ionic liquids, ordered according to their rough price on an industrial scale.

Cheap	Expensive
cations:	
$[\text{HNR}_3]^+$ $[\text{HPR}_3]^+$	$[\text{NR}_4]^+$ $[\text{PR}_4]^+$
	alkylmethylimidazolium- dialkylimidazolium- alkylpyridinium-
anions:	
$[\text{Cl}]^-$ $[\text{MeSO}_4]^-$ [acetate] $[\text{NO}_3]^-$	$[\text{PF}_6]^-$ $[\text{BF}_4]^-$ $[\text{CF}_3\text{SO}_3]^-$ $[(\text{CF}_3\text{SO}_2)_2\text{N}]^-$
	$[\text{SbF}_6]^-$

## 2.2.7

**Intellectual Property Aspects Regarding Ionic Liquids**

The future price of ionic liquids will also reflect intellectual property considerations. While the currently most frequently requested ionic liquids, the tetrafluoroborate and hexafluorophosphate ionic liquids, are all patent-free, many recently developed, new ionic liquid systems are protected by “state of matter” patents. Table 2.2-2 gives an overview of some examples published after 1999.

**Table 2.2-1:** Selected examples of “state of matter” patents concerning ionic liquids published since 1999.

<i>Title</i>	<i>Typical protected compound</i>	<i>Company</i>	<i>Year of pub.</i>	<i>Ref.</i>
Preparation of N-alkoxyalkylimidazolium salts and ionic liquids or gels containing them	1-Methyl-3-methoxyethyl imidazolium bromide	Foundation for Scientific Technology Promotion, Japan	2002	21
Ionic liquids	[EMIM][PF <sub>3</sub> (C <sub>2</sub> F <sub>5</sub> ) <sub>3</sub> ]	Merck Patent GmbH, Germany	2001	22
Ionic liquids	[EMIM] bis(1,2-oxalato-O,O')borate	Merck Patent GmbH, Germany	2001	23
Preparation of phosphonium salts as ionic liquids	[PiBu <sub>3</sub> Et][tosylate]	Cytec Technology Corp., USA	2001	24
Ionic liquids derived from Lewis acids based on Ti, Nb, Sn, Sb	[NR <sub>3</sub> R']X/SbF <sub>5</sub>	Atofina, France	2001	25
Preparation of chiral ionic liquids	(S)-4-isopropyl-2,3-dimethyloxazolium [BF <sub>4</sub> ]	Solvent Innovation GmbH, Germany	2001	26
Immobilized ionic liquids	Chloroaluminate ionic liquids on inorganic supports	ICI, UK	2001	27
Preparation of ionic liquids and their use	[NR <sub>3</sub> R'] <sub>x</sub> [P(OPh-SO <sub>3</sub> ) <sub>x</sub> (OPh) <sub>y</sub> ]	Celanese Chemicals Europe, GmbH, Germany	2000	28
Ionic liquids prepared as low-melting salts ...	[NR <sub>3</sub> R']Cl/ZnCl <sub>2</sub>	University of Leicester, UK	2000	29
Preparation of ionic liquids for catalysis	[BMIM][HSO <sub>4</sub> ], [HNR <sub>3</sub> ][HSO <sub>4</sub> ]	BP Chemicals, UK; Akzo Nobel NV, Netherlands; Elementis Specialities, UK	2000	30
Preparation of ionic liquids by treatment of amines with halide donors in the presence of metal halides	[HNR <sub>3</sub> ]Cl/AlCl <sub>3</sub>	Akzo Nobel NV, Netherlands	2000	31



Without a doubt, tetrafluoroborate and hexafluorophosphate ionic liquids have shortcomings for larger-scale technical application. The relatively high cost of their anions, their insufficient stability to hydrolysis for long-term application in contact with water (formation of corrosive and toxic HF during hydrolysis!), and problems related to their disposal have to be mentioned here. New families of ionic liquid that should meet industrial requirements in a much better way are therefore being developed. However, these new systems will probably be protected by state-of-matter patents.

In this respect, there is one important statement to make. It is our belief that the owners of state-of-matter patents for promising new classes of ionic liquids should never stop or hinder academic research dealing with these substances. On the contrary, we think that only through fundamental academic research will we be able to gain a full understanding of a given material over time. Only this full understanding will allow the full scope and limitations of a new family of ionic liquids to be explored.

Research in ionic liquid methodology is still young and there is still a lot to explore. Prevention of fundamental research on some new families of ionic liquids by exploitation of an IP position would simply kill off a lot of future possibilities.

## References

- 1 T. Welton, *Chem. Rev.* **1999**, *99*, 2071–2083.
- 2 J. S. Wilkes, M. J. Zaworotko, *J. Chem. Soc. Chem. Commun.* **1992**, 965–967.
- 3 J. Fuller, R. T. Carlin, H. C. de Long, D. Haworth, *J. Chem. Soc. Chem. Commun.* **1994**, 299–300.
- 4 P. A. Z. Suarez, J. E. L. Dullius, S. Einloft, R. F. de Souza, J. Dupont, *Polyhedron* **1996**, *15*(7), 1217–1219.
- 5 Solvent Innovation GmbH, Cologne ([www.solvent-innovation.com](http://www.solvent-innovation.com)).
- 6 M. Tinkl, *Chem. Rundschau* **1999**, *2*, 59.
- 7 a) Covalent Associates ([www.covalent-associates.com](http://www.covalent-associates.com)), b) SACHEM Inc. ([www.sacheminc.com](http://www.sacheminc.com)).
- 8 Fluka ([www.fluka.com](http://www.fluka.com))
- 9 Acros Organics ([www.acros.com](http://www.acros.com)); ionic liquids are offered in collaboration with QUILL ([quill.qub.ac.uk](http://quill.qub.ac.uk)).
- 10 Wako ([www.wako-chem.co.jp](http://www.wako-chem.co.jp)).
- 11 For example: a) D. W. Armstrong, L. He, Y.-S. Liu, *Anal. Chem.* **1999**, *71*, 3873–3876; b) D. W. Armstrong, *Anal. Chem.* **2001**, *73*, 3679–3686; c) F. Endres, *Phys. Chem. Chem. Phys.* **2001**, *3*, 3165; d) C. Ye, W. Liu, Y. Chen, L. Yu, *Chem. Commun.* **2001**, 2244–2245.
- 12 K. R. Seddon, A. Stark, M. J. Torres, *Pure Appl. Chem.* **2000**, *72*, 2275–2287.
- 13 J. D. Holbrey, K. R. Seddon, R. Wareing, *Green Chem.* **2001**, *3*, 33–36.
- 14 B. Ellis, WO 9618459 (to BP Chemicals Limited, UK) **1996** [Chem. Abstr. **1996**, *125*, 114635].
- 15 P. Bonhôte, A.-P. Dias, N. Papageorgiou, K. Kalyanasundaram, M. Grätzel, *Inorg. Chem.* **1996**, *35*, 1168–1178.
- 16 H. Waffenschmidt, dissertation, RWTH Aachen, **2000**.
- 17 For example: Y. Chauvin, L. Mußmann, H. Olivier, *Angew. Chem. Int. Ed. Engl.* **1995**, *34*, 2698–2700.
- 18 For example: C. J. Mathews, P. J. Smith, T. Welton, A. J. P. White, D. J. Williams, *Organometallics* **2001**, *20*(18), 3848–3850.
- 19 W. J. Mehm, J. B. Nold, R. C. Zernach, *Aviat. Space Environ. Med.* **1986**, *57*, 362.
- 20 J. Pernak, A. Czepukowicz, R. Pozniak, *Ind. Eng. Chem. Res.* **2001**, *40*, 2379–2283.

- 21 N. Imizuka, T. Nakashima, JP 2002003478 (to Foundation for Scientific Technology Promotion, Japan), 2002 [Chem. Abstr. 2002, 136, 85811].
- 22 M. Schmidt, U. Heider, W. Geissler, N. Ignatyev, V. Hilarius, EP 1162204 (to Merck Patent GmbH, Germany), 2001 [Chem. Abstr. 2001, 136, 20157].
- 23 V. Hilarius, U. Heider, M. Schmidt EP 1160249 (to Merck Patent GmbH, Germany) 2001 [Chem. Abstr. 2001, 136, 6139].
- 24 A. J. Robertson, WO 0187900 (to Cytec Technology Corp., USA), 2001 [Chem. Abstr. 2001, 135, 371866].
- 25 P. Bonnet, E. Lacroix, J.-P. Schirmann, WO 0181353 [to Atofina, France) 2001 [Chem. Abstr. 2001, 135, 338483].
- 26 P. Wasserscheid, W. Keim, C. Bolm, A. Boesmann, WO 0155060 (to Solvent Innovation GmbH, Germany) 2001 [Chem. Abstr. 2001, 135, 152789].
- 27 M. H. Valkenberg, E. Sauvage, C. P. De Castro-Moreira, W. F. Hölderich, WO 0132308 2001 [Chem. Abstr. 2001, 134, 342374].
- 28 H. Bahrmann, H. Bohnen, DE 19919494 (to Celanese Chemicals Europe GmbH, Germany) 2000 [Chem. Abstr. 2000, 133, 321998].
- 29 A. P. Abbott, D. L. Davies, WO 0056700 (to University of Leicester, UK) 2000 [Chem. Abstr. 2000, 133, 269058].
- 30 W. Keim, W. Korth, P. Wasserscheid WO 0016902 (to BP Chemicals Limited, UK; Akzo Nobel NV; Elementis UK Limited) 2000 [Chem. Abstr. 2000, 132, 238691].
- 31 C. P. M. Lacroix, F. H. M. Dekker, A. G. Talma, J. W. F. Seetz EP 989134 (to Akzo Nobel N. V., Netherlands) 2000 [Chem. Abstr. 2000, 132, 238691].

## 2.3

### Synthesis of Task-specific Ionic Liquids

*James H. Davis, Jr.*

Early studies probing the feasibility of conducting electrophilic reactions in chloroaluminate ionic liquids (ILs) demonstrated that the ionic liquid could act both as solvent and catalyst for the reaction [1–3]. The success of these efforts hinged upon the capacity of the salt itself to manifest the catalytic activity necessary to promote the reaction. Specifically, it was found that the capacity of the liquid to function as an electrophilic catalyst could be adjusted by varying the  $\text{Cl}^-/\text{AlCl}_3$  ratio of the complex anion. Anions that were even marginally rich in  $\text{AlCl}_3$  catalyzed the reaction.

Despite the utility of chloroaluminate systems as combinations of solvent and catalysts in electrophilic reactions, subsequent research on the development of newer ionic liquid compositions focused largely on the creation of liquid salts that were water-stable [4]. To this end, new ionic liquids that incorporated tetrafluoroborate, hexafluorophosphate, and bis(trifluoromethyl)sulfonamide anions were introduced. While these new anions generally imparted a high degree of water-stability to the ionic liquid, the functional capacity inherent in the IL due to the chloroaluminate anion was lost. Nevertheless, it is these water-stable ionic liquids that have become the de rigueur choices as solvents for contemporary studies of reactions and processes in these media [5].



A 1998 report on the formation of ionic liquids by relatively large, structurally complex ions derived from the antifungal drug miconazole reemphasized the possibilities for the formulation of salts that remain liquids at low temperatures, even with incorporation of functional groups in the ion structure [6]. This prompted the introduction of the concept of “task-specific” ionic liquids [7]. Task-specific ionic liquids (TSILs) may be defined as ionic liquids in which a functional group is covalently tethered to the cation or anion (or both) of the IL. Further, the incorporation of this functionality should imbue the salt with a capacity to behave not only as a reaction medium but also as a reagent or catalyst in some reaction or process. The definition of TSILs also extends to “conventional” ionic liquids to which are added ionic solutes that introduce a functional group into the liquid. Logically, when added to a “conventional” ionic liquid, these solutes become integral elements of the overall “ion soup” and must then be regarded as an element of the ionic liquid as a whole, making the resulting material a TSIL.

Viewed in conjunction with the solid-like, nonvolatile nature of ionic liquids, it is apparent that TSILs can be thought of as liquid versions of solid-supported reagents. Unlike solid-supported reagents, however, TSILs possess the added advantages of kinetic mobility of the grafted functionality and an enormous operational surface area (Figure 2.3-1). It is this combination of features that makes TSILs an aspect of ionic liquids chemistry that is poised for explosive growth.

Conceptually, the functionalized ion of a TSIL can be regarded as possessing two elements. The first element is a core that bears the ionic charge and serves as the locus for the second element, the substituent group. Save for the well documented chloroaluminate ionic liquids, established TSILs are largely species in which the functional group is cation-tethered. Consequently, discussion of TSIL synthesis from this point will stress the synthesis of salts possessing functionalized cations, though the general principles outlined are pertinent to the synthesis of functionalized anions as well.

The incorporation of functionality into an ion slated for use in formulation of an ionic liquid is usually a multi-step process. Consequently, a number of issues must be considered in planning the synthesis of the ion. The first of these is the choice of the cationic core. The core of a TSIL cation may be as simple as a single

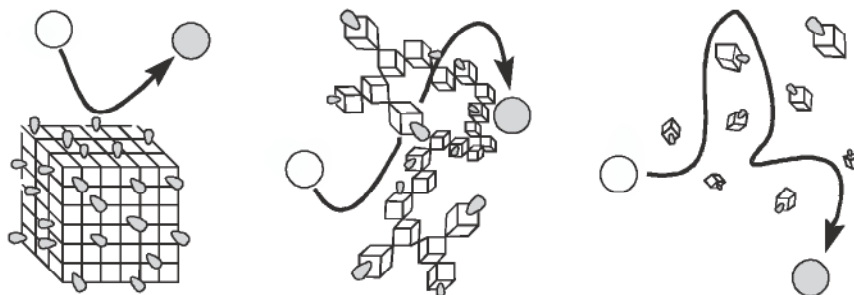

Figure 2.3-1: Substrate interactions with (l to r): solid-supported reagent, polymer gel supported reagent, task specific ionic liquid.

atom such as N, P, or S, as found in ammonium, phosphonium, or sulfonium ions, respectively. Alternatively, the core of the ion may be (and frequently is) a heterocycle such as imidazole or pyridine. The choices made in this regard will play a large role in determining both the chemical and physical properties of the resulting salt. For example, ionic liquids incorporating phosphonium cations generally exhibit the greatest thermal stability, but also commonly possess melting points higher than those of salts of other cations [8]. Thus, if the desired ionic liquid is to be used in a process intended to be conducted at 0 °C, it may prove especially challenging to build the cation core around a phosphonium ion. If the ionic liquid is to be used in a metal-catalyzed reaction, the use of an imidazolium-based ionic liquid might be critical, especially in view of the possible involvement in some reactions of imidazolylidene carbenes originating with the IL solvent [9].

The second element of general importance in the synthesis of a task-specific ionic liquid is the source of the functional group that is to be incorporated. Key to success here is the identification of a substrate containing two functional groups with different reactivities, one of which allows the attachment of the substrate to the core, and the other of which either is the functional group of interest or is modifiable to the group of interest. Functionalized alkyl halides are commonly used in this capacity, although the triflate esters of functionalized alcohols work as well.

The choice of reaction solvent is also of concern in the synthesis of new TSILs. Toluene and acetonitrile are the most widely used solvents, the choice in any given synthesis being dictated by the relative solubilities of the starting materials and products. The use of volatile organic solvents in the synthesis of ionic liquids is decidedly the least “green” aspect of their chemistry. Notably, recent developments in the area of the solventless synthesis of ionic liquids promise to improve this situation [10].

The choice of the anion ultimately intended to be an element of the ionic liquid is of particular importance. Perhaps more than any other single factor, it appears that the anion of the ionic liquid exercises a significant degree of control over the molecular solvents (water, ether, etc.) with which the IL will form two-phase systems. Nitrate salts, for example, are typically water-miscible while those of hexafluorophosphate are not; those of tetrafluoroborate may or may not be, depending on the nature of the cation. Certain anions such as hexafluorophosphate are subject to hydrolysis at higher temperatures, while those such as bis(trifluoromethane)sulfonamide are not, but are extremely expensive. Additionally, the cation of the salt used to perform any anion metathesis is important. While salts of potassium, sodium, and silver are routinely used for this purpose, the use of ammonium salts in acetone is frequently the most convenient and least expensive approach.

Although the first ionic liquid expressly categorized as being “task-specific” featured the incorporation of the function within the cation core, subsequent research has focused on the incorporation of functionality into a branch appended to the cation [11]. In this fashion, a number of task-specific ionic liquids built up from 1-methyl- and 1-butylimidazole have been prepared, produced by means of the reaction between these imidazoles and haloalkanes also incorporating a desired functional group (Scheme 2.3-1). Bazureau has used this approach to prepare imida-

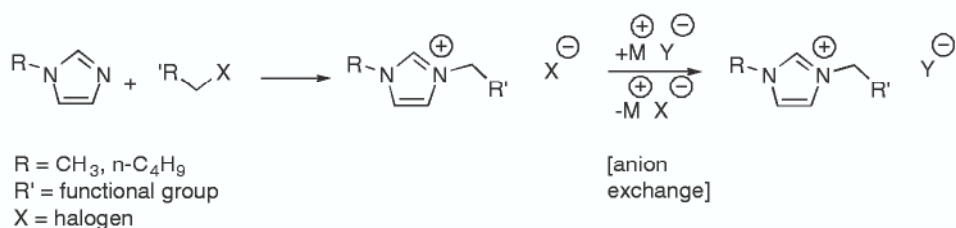

**Scheme 2.3-1:** General synthesis of task-specific ionic liquids from 1-alkylimidazoles. The preparation of functionalized pyridinium, phosphonium, etc. cations may be accomplished in like fashion.

zolium ions with appended carboxylic acid groups, which have been used as replacements for solid polymer supports in the heterogeneous-phase synthesis of small organic molecules by means of Knoevenagel and 1, 3-dipolar cycloaddition reactions [12].

Another commercially available imidazole “scaffold” upon which a number of other functionalized cations have been constructed is 1-(3-aminopropyl)imidazole. The appended amino group in this material is a versatile reactive site that lends itself to conversion into a variety of derivative functionalities (Scheme 2.3-2).

Treatment of 1-(3-aminopropyl)imidazole with isocyanates and isothiocyanates gives urea and thiourea derivatives [13]. These elaborated imidazoles can then be quaternized at the ring nitrogen by treatment with alkyl iodides to produce the corresponding N(3)-alkylimidazolium salts. Because of a competing side reaction arising from the interaction of the alkylating species with the urea or thiourea groups, the reactions must be conducted within relatively narrow temperature and solvent parameters (below reflux in acetonitrile). Similar care must be exercised in the synthesis of IL cations with appended acetamide and formamide groups.

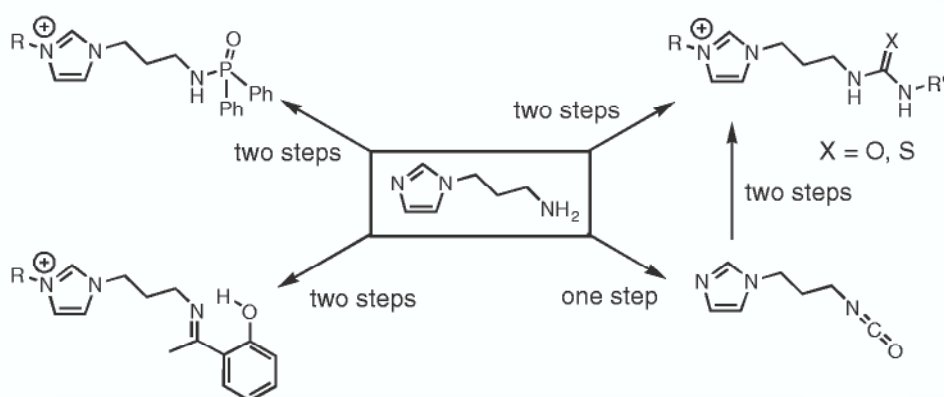

**Scheme 2.3-2:** Representative syntheses of task-specific ionic liquids beginning with 1-(3-aminopropyl)imidazole. Step one of the synthetic transformations is the conversion of the

primary amine moiety into the functional group of interest. Step two of the process is the quaternization of the imidazole ring by alkylation at N(3).

A variation on this overall synthetic approach allows the formation of related TSIL ureas by initial conversion of 1-(3-aminopropyl)imidazole into an isocyanate, followed by treatment with an amine and alkylating agent. This approach has been used to append both amino acids and nucleic acids onto the imidazolium cation skeleton [14].

The incorporation of more “inorganic” appendages into TSIL cations has also been achieved through the use of 1-(3-aminopropyl)imidazole. Phosphoramidate groups are readily synthesized by treatment of phosphorous(V) oxyhalides with primary or secondary amines. In just such an approach, 1-(3-aminopropyl)imidazole was allowed to react with commercially available  $(\text{C}_6\text{H}_5)_2\text{POCl}_2$  in dichloromethane. After isolation, the resulting phosphoramidate was then quaternized at the imidazole N(3) position by treatment with ethyl iodide (Scheme 2.3-2). The viscous, oily product was found to mix readily with more conventional ionic liquids such as [HMIM][PF<sub>6</sub>], yielding a more tractable material. This particular TSIL has been used to extract a number of actinide elements from water. Similarly, the thiourea-appended TSILs discussed earlier have been used for the extraction of Hg<sup>2+</sup> and Cd<sup>2+</sup> from IL-immiscible aqueous phases.

While certain TSILs have been developed to pull metals into the IL phase, others have been developed to keep metals in an IL phase. The use of metal complexes dissolved in IL for catalytic reactions has been one of the most fruitful areas of IL research to date. However, these systems still have a tendency to leach dissolved catalyst into the co-solvents used to extract the product of the reaction from the ionic liquid. Consequently, Wasserscheid et al. have pioneered the use of TSILs based upon the dissolution into a “conventional” IL of metal complexes that incorporate charged phosphine ligands in their structures [16–18]. These metal complex ions become an integral part of the ionic medium, and remain there when the reaction products arising from their use are extracted into a co-solvent. Certain of the charged phosphine ions that form the basis of this chemistry (e.g., P(*m*-C<sub>6</sub>H<sub>4</sub>SO<sub>3</sub><sup>-</sup>Na<sup>+</sup>)<sub>3</sub>) are commercially available, while others may be prepared by established phosphine synthetic procedures.

An example of this approach to TSIL formulation is the synthesis from 1-vinylimidazole of a series of imidazolium cations with appended tertiary phosphine groups [Scheme 2.3-3]. The resulting phosphines are then coordinated to a Rh(I) organometallic and dissolved in the conventional IL [BMIM][PF<sub>6</sub>], the mixture constituting a TSIL. The resulting system is active for the hydroformylation of 1-octene, with no observable leaching of catalyst [17].

Task-specific ionic liquids designed for the binding of metal ions need not be only monodentate in nature. Taking a hint from classical coordination chemistry, a bidentate TSIL has been prepared and used in the extraction of Ni<sup>2+</sup> from an aqueous solution. This salt is readily prepared in a two-step process. Firstly, 1-(3-aminopropyl)imidazole is condensed with 2-salicylaldehyde under Dean–Stark conditions, giving the corresponding Schiff base. This species is readily alkylated in acetonitrile to form the imidazolium salt. Mixed as the [PF<sub>6</sub>]<sup>-</sup> salt in a 1:1 (v/v) fashion with [HMIM][PF<sub>6</sub>], this new TSIL quickly decolorizes green, aqueous solutions containing Ni<sup>2+</sup> when it comes into contact with them, the color moving completely into the IL phase (Scheme 2.3-4).

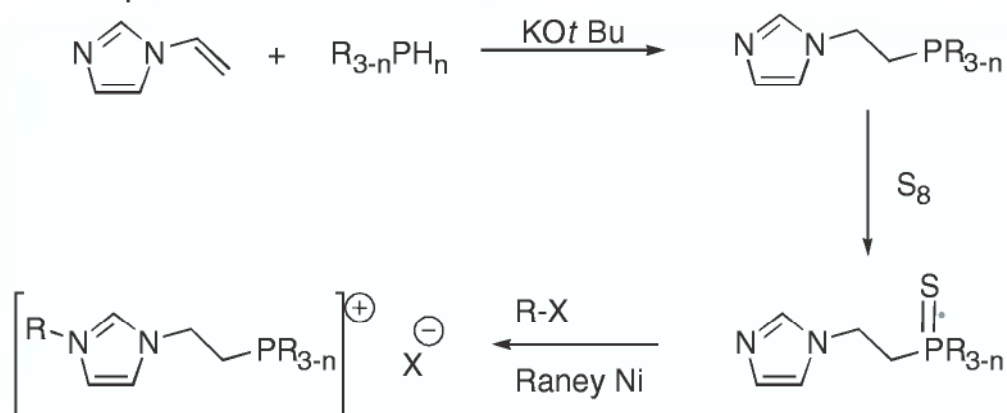

**Scheme 2.3-3:** Synthesis of phosphine-appended imidazolium salts. Combination of these species with the conventional IL [BMIM]PF<sub>6</sub> and Rh(I) gives rise to a task-specific ionic liquid active for the hydroformylation of 1-octene.

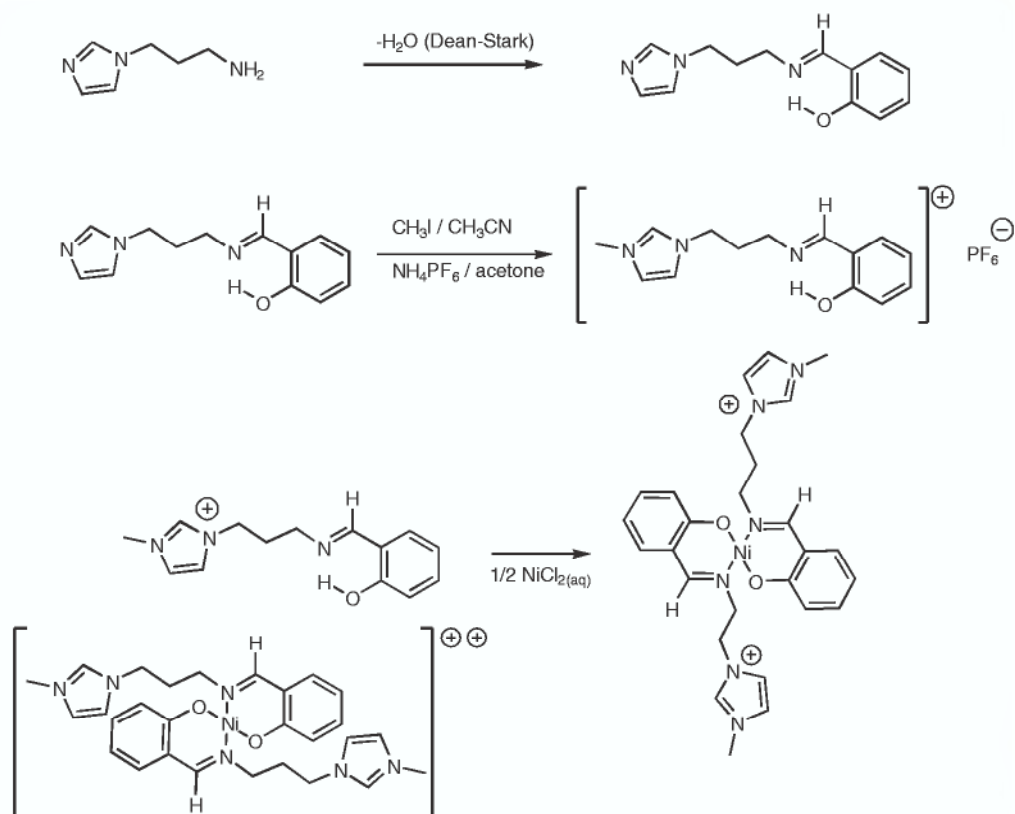

**Scheme 2.3-4:** Synthesis of a chelating task-specific ionic liquid and its utilization for metal extraction.

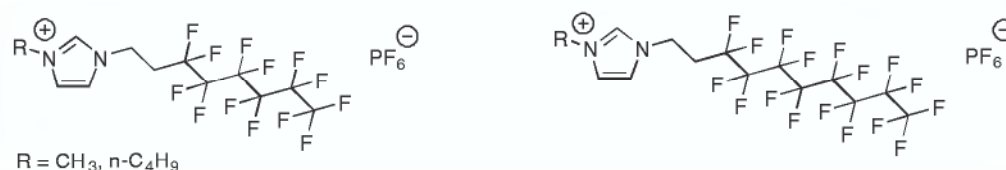

**Figure 2.3-5:** Imidazolium-based task-specific ionic liquids with cation-appended fluorinated tails.

The types of functional groups incorporated into TSILs need not be limited to those based upon nitrogen, oxygen, or phosphorus. Ionic liquids containing imidazolium cations with long, appended fluorinated tails have been reported, for example, (Figure 2.3-2). Although these species are not liquids at room temperature (melting in the 60–150 °C range), they nevertheless exhibit interesting chemistry when “alloyed” with conventional ILs. While their solubility in conventional ionic liquids is rather limited (saturation concentrations of about 5 mM), the TSILs apparently form fluorinated micelles in the ILs. Thus, when a conventional ionic liquid doped with a fluorinated TSIL is mixed with perfluorocarbons, extremely stable emulsions can be formed. These may be of use in the development of two-phase fluorinated/ionic liquid reaction systems [19]. As with many other TSILs reported so far, these compounds are prepared by direct treatment of 1-alkylimidazoles with a (poly-fluoro)alkyl iodide, followed by anion metathesis.

While the overwhelming bulk of research on and with TSILs has been done on imidazolium-based systems, there is little obvious reason for this to remain the case. Rather, because of the relatively high cost of commercial imidazole starting materials, economic considerations would suggest that future research place more emphasis on the less costly ammonium- and phosphonium-based systems. Indeed, it is notable that a huge number of functionalized phosphonium salts (mostly halides) are in the literature, having been synthesized over the past forty-odd years as Wittig reagent precursors [20]. Many of these compounds will probably be found to give rise to ionic liquids when the cations are paired with an appropriate anion. In similar fashion, large numbers of known natural products are quaternized (or quarternizable) ammonium species that incorporate other, useable functional groups elsewhere in their structure. Many of these molecules are optically active, and could form the basis of entirely new TSIL systems for use in catalysis and chiral separations. Clearly, the potential for development of new TSILs is limited only by the imaginations of the chemists working to do so.



## References

- 1 J. A. Boon, J. A. Levisky, J. L. Pflug, and J. S. Wilkes, *J. Org. Chem.* **1986**, *51*, 480.
- 2 Y. Chauvin, A. Hirschauer, and H. Olivier, *J. Mol. Catal.* **1994**, *92*, 155.
- 3 J. A. Boon, S. W. Lander, Jr., J. A. Leviski, J. L. Pflug, L. M. Skrzynecki-Cooke, and J. S. Wilkes, *Proc. Electrochem. Soc. 87-7 (Proc. Jt. Int. Symp. Molten Salts)* **1987**, 979.
- 4 J. S. Wilkes and M. J. Zaworotko, *J. Chem. Soc., Chem. Commun.* **1990**, 965.
- 5 T. Welton, *Chem. Rev.* **1999**, *99*, 2071.
- 6 K. J. Forrester, T. L. Merrigan, and J. H. Davis, Jr., *Tetrahedron Letters* **1998**, *39*, 8955.
- 7 A. Wierzbicki, and J. H. Davis, Jr., *Proceedings of the Symposium on Advances in Solvent Selection and Substitution for Extraction*, March 5–9, **2000**, Atlanta, Georgia. AIChE, New York, **2000**.
- 8 N. Karodia, S. Guise, C. Newlands, and J. -A. Andersen, *Chem. Commun.* **1998**, 2341.
- 9 C. J. Mathews, P. J. Smith, T. Welton, A. J. P. White, and D. J. Williams, *Organometallics* **2001**, *20*, 3848.
- 10 R. S. Varma, and V. V. Namboodiri, *Chem. Commun.* **2001**, 643.
- 11 K. J. Forrester, and J. H. Davis, Jr., *Tetrahedron Letters* **1999**, *40*, 1621.
- 12 J. Fraga-Dubreuil and J. P. Bazureau, *Tetrahedron Letters* **2001**, *42*, 6097.
- 13 A. E. Visser, R. P. Swatloski, W. M. Reichert, R. Mayton, S. Sheff, A. Wierzbicki, J. H. Davis, Jr., and R. D. Rogers, *Chemical Communications* **2001**, 135.
- 14 J. H. Davis, Jr. and E. D. Bates, unpublished results.
- 15 J. H. Davis, Jr., "Working Salts: Syntheses and Uses of Ionic Liquids Containing Functionalised Ions," *ACS Symp. Ser.* **2002**, *in press*.
- 16 C. C. Brasse, U. Englert, A. Salzer, H. Waffenschmidt, and P. Wasserscheid, *Organometallics* **2000**, *19*, 3818.
- 17 K. W. Kottsieper, O. Stelzer, and P. Wasserscheid, *J. Mol. Catal. A.* **2001**, *175*, 285.
- 18 D. J. Brauer, K. W. Kottsieper, C. Liek, O. Stelzer, H. Waffenschmidt, and P. Wasserscheid, *J. Organomet. Chem.* **2001**, *630*, 177.
- 19 T. L. Merrigan, E. D. Bates, S. C. Dorman, and J. H. Davis, Jr., *Chemical Communications* **2000**, 2051–2052.
- 20 A. W. Johnson, *Ylides and Imines of Phosphorous*, Wiley-Interscience, New York, **1993**.



### 3 Physicochemical Properties of Ionic Liquids

*Jennifer L. Anthony, Joan F. Brennecke, John D. Holbrey, Edward J. Maginn,  
Rob A. Mantz, Robin D. Rogers, Paul C. Trulove, Ann E. Visser, and Tom Welton*

#### 3.1 Melting Points and Phase Diagrams

*John D. Holbrey and Robin D. Rogers*

##### 3.1.1 Introduction

What constitutes an *ionic liquid*, as distinct from a *molten salt*? It is generally accepted that ionic liquids have relatively low melting points, ideally below ambient temperature [1, 2]. The distinction is arbitrarily based on the salt exhibiting liquidity at or below a given temperature, often conveniently taken to be 100 °C. However, it is clear from observation that the principle distinction between the materials of interest today as ionic liquids (and more as specifically room-temperature ionic liquids) and conventional molten salts is that ionic liquids contain organic cations rather than inorganic ones. This allows a convenient differentiation without concern that some 'molten salts' may have lower melting points than some 'ionic liquids'.

It should also be noted that terms such as 'high temperature' and 'low temperature' are also subjective, and depend to a great extent on experimental context. If we exclusively consider ionic liquids to incorporate an organic cation, and further limit the selection of salts to those that are liquid below 100 °C, a large range of materials are still available for consideration.

The utility of ionic liquids can primarily be traced to the pioneering work by Osteryoung et al. [3] on *N*-butylpyridinium-containing, and by Wilkes and Hussey [4–6] on 1-ethyl-3-methylimidazolium-containing ionic liquids for electrochemical studies. These studies have strongly influenced the choice of ionic liquids for subsequent research [7]. The vast majority of work published to date on room-temperature ionic liquids relates to *N*-butylpyridinium and 1-ethyl-3-methylimidazolium [EMIM] tetrachloroaluminate(III) systems. The large variety of available ion combi-

nations (and composition variation in mixtures) gives rise to extensive ranges of salts and salt mixtures, with solidification points ranging from  $-90\text{ }^{\circ}\text{C}$  upwards.

However, ionic liquids containing other classes of organic cations are known. Room-temperature ionic liquids containing organic cations including quaternary ammonium, phosphonium, pyridinium, and – in particular – imidazolium salts are currently available in combination with a variety of anions (Figure 3.1-1 provides some common examples) and have been studied for applications in electrochemistry [7, 8] and in synthesis [9–11].

It should be emphasized that ionic liquids are simply organic salts that happen to have the characteristic of a low melting point. Many ionic liquids have been widely investigated with regard to applications other than as liquid materials: as electrolytes, phase-transfer reagents [12], surfactants [13], and fungicides and biocides [14, 15], for example.

The wide liquid ranges exhibited by ionic liquids, combined with their low melting points and potential for tailoring size, shape, and functionality, offer opportunities for control over reactivity unobtainable with molecular solvents. It is worth noting that quaternary ammonium, phosphonium, and related salts are being widely reinvestigated [16–18] as the best ionic liquid choices for particular applications, particularly in synthetic chemistry, are reevaluated. Changes in ion types, substitution, and composition produce new ionic liquid systems, each with a unique set of properties that can be explored and hopefully applied to the issues. With the potential large matrix of both anions and cations, it becomes clear that it will be impossible to screen any particular reaction in all the ionic liquids, or even all within a subset containing only a single anion or cation. Work is clearly needed to determine how the properties of ionic liquids vary as functions of anion/cation/substitution patterns etc., and to establish which, if any, properties change in systematic (that is, predictable) ways.

The most simple ionic liquids consist of a single cation and single anion. More complex examples can also be considered, by combining of greater numbers of

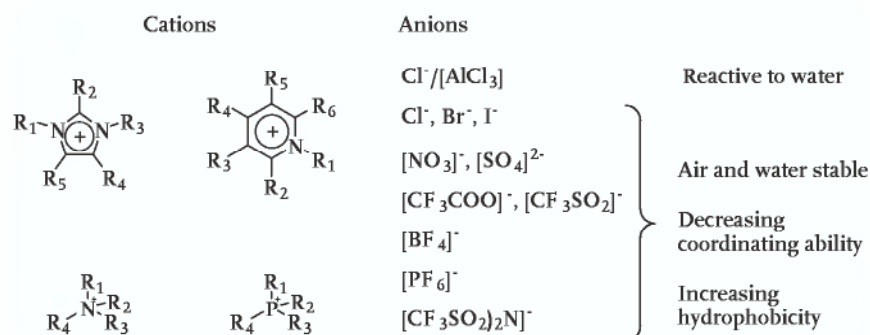

Figure 3.1-1: Examples of common cation and anion pairs used in the formation of ionic liquids, and general progression of changes in IL properties with anion type.

cations and/or anions, or when complex anions are formed as the result of equilibrium processes, as can be seen in Equation (3.1-1):



Chloroaluminate(III) ionic liquid systems are perhaps the best established and have been most extensively studied in the development of low-melting organic ionic liquids with particular emphasis on electrochemical and electrodeposition applications, transition metal coordination chemistry, and in applications as liquid Lewis acid catalysts in organic synthesis. Variable and tunable acidity, from basic through neutral to acidic, allows for some very subtle changes in transition metal coordination chemistry. The melting points of [EMIM]Cl/AlCl<sub>3</sub> mixtures can be as low as -90 °C, and the upper liquid limit almost 300 °C [4, 6].

The following discussion concerns the thermal liquidus ranges available in different ionic liquids, as functions of cation and anion structure and composition. In particular, those structural features of cation and anion that promote these properties (while providing other desirable, and sometimes conflicting characteristics of the liquid, such as low viscosity, chemical stability, etc.) and variations in liquidus ranges and stabilities are the focus of this chapter.

The general observations made regarding structural influences on melting points are transferable across cation type, and apply in each case. The primary focus is on 1-alkyl-3-methylimidazolium cations, coupled with simple organic and inorganic anions. Complex anions, such as mixed X /MX<sub>n</sub> systems, are mentioned, as are other series of cations (including some examples of tetraalkylammonium salts).

### 3.1.2

#### Determination of Liquidus Ranges

The liquidus ranges exhibited by ionic liquids can be much greater than those found in common molecular solvents. Water, for example, has a liquidus range of 100 °C (0 to 100 °C), and dichloromethane has one of 145 °C (-95 to 40 °C). The lower temperature limit, solidification (either as crystallization or glassification), is governed by the structure and interactions between the ions. Ionic liquids, consisting of totally ionized components and displaying relatively weak ion-ion pairing (in comparison to molten salts), have little or no measurable vapor pressure. In contrast to molecular solvents, the upper liquidus limit for ionic liquids is usually that of thermal decomposition rather than vaporization.

#### 3.1.2.1 Melting points

The solid-liquid transition temperatures of ionic liquids can (ideally) be below ambient and as low as -100 °C. The most efficient method for measuring the transition temperatures is differential scanning calorimetry (DSC). Other methods that have been used include cold-stage polarizing microscopy, NMR, and X-ray scattering.

The thermal behavior of many ionic liquids is relatively complex. For a typical IL, cooling from the liquid state causes glass formation at low temperatures; solidifica-

tion kinetics are slow. On cooling from the liquid, the low-temperature region is not usually bounded by the phase diagram liquidus line, but rather is extended down to a lower temperature limit imposed by the glass transition temperature [19]. This tendency is enhanced by addition of lattice-destabilizing additives, including organic solutes, and by mixing salts. Solidification (glass) temperatures recorded on cooling are not true measures either of heating  $T_g$  values or of melting points, and represent kinetic transitions. Thermodynamic data must be collected in heating mode to obtain reproducible results. Hence, in order to obtain reliable transition data, long equilibration times, with small samples that allow rapid cooling, are needed to quench non-equilibrium states in mixtures. Formation of metastable glasses is common in molten salts. In many cases, the glass transition temperatures are low: for 1-alkyl-3-methylimidazolium salts, glass transition temperatures recorded are typically in the region between  $-70$  and  $-90$  °C. In many cases, heating from the glassy state yields an exothermic transition associated with sample crystallization, followed by subsequent melting.

In some cases there is evidence of multiple solid–solid transitions, either crystal–crystal polymorphism (seen for  $\text{Cl}^-$  salts [20]) or, more often, formation of plastic crystal phases – indicated by solid–solid transitions that consume a large fraction of the enthalpy of melting [21], which also results in low-energy melting transitions. The overall enthalpy of the salt can be dispersed into a large number of fluxional modes (vibration and rotation) of the organic cation, rather than into enthalpy of fusion. Thus, energetically, crystallization is often not overly favored.

### 3.1.2.2 Upper limit decomposition temperature

The upper limit of the liquidus range is usually bounded by the thermal decomposition temperature of the ionic liquid, since most ionic liquids are nonvolatile. In contrast to molten salts, which form tight ion-pairs in the vapor phase, the reduced Coulombic interactions between ions energetically restricts the ion-pair formation required for volatilization of salts, producing low vapor pressures. This gives rise to high upper temperature limits, defined by decomposition of the IL rather than by vaporization. The nature of the ionic liquids, containing organic cations, restricts upper stability temperatures, pyrolysis generally occurs between  $350$ – $450$  °C if no other lower temperature decomposition pathways are accessible [22]. In most cases, decomposition occurs with complete mass loss and volatilization of the component fragments. Grimmer et al. have studied the decomposition of imidazolium halides [22] and identified the degradation pathway as E2 elimination of the *N*-substituent, essentially the reverse of the  $S_N2$  substitution reaction to form the ionic liquid.

If then decomposition temperatures for a range of ionic liquids with differing anions are compared, the stability of the ionic liquid is inversely proportional to the tendency to form a stable alkyl-X species. As can be seen from TGA decomposition data for a range of  $[\text{RMIM}]^+$  salts (Figure 3.1-2) collected by anion type, the decomposition temperatures vary with anion type and follow the general stability order,  $\text{Cl}^- < [\text{BF}_4]^- \sim [\text{PF}_6]^- < [\text{NTf}_2]^-$ , so that ionic liquids containing weakly coordinating anions are most stable to high-temperature decomposition [23–27].

**Figure 3.1-2:** Thermal decomposition temperature ranges (in °C) for ionic liquids containing 1-alkyl-3-methylimidazolium cations. The thermal stability of the ionic liquids depends on the nucleophilicity of the anion.

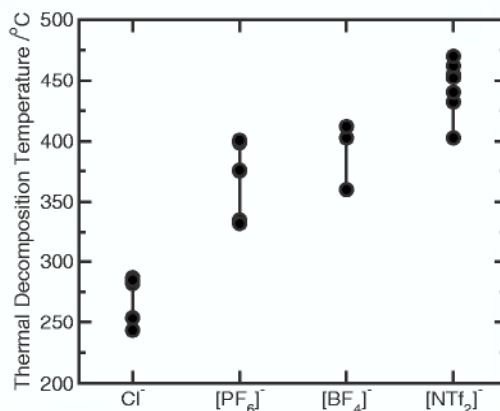

Ngo et al. [24] have shown that the thermal decomposition of ionic liquids, measured by TGA, varies depending on the sample pans used. Increased stabilization of up to 50 °C was obtained in some cases on changing from aluminium to alumina sample pans.

### 3.1.3

#### Effect of Ion Sizes on Salt Melting Points

It is well known that the characteristic properties of ionic liquids vary with the choice of anion and cation. The structure of an ionic liquid directly impacts upon its properties, in particular the melting point and liquidus ranges. The underlying principles behind the drive to reduce the melting points (and thus operational range limits) for battery electrolytes have been described elsewhere [4]. Exploitation of the changes in these characteristics enables ionic liquids with a wide range of properties to be designed.

The charge, size and distribution of charge on the respective ions are the main factors that influence the melting points of the salts, as generic classes. Within a similar series of salts, however, small changes in the shape of uncharged, covalent regions of the ions can have an important influence on the melting points of the salts.

The dominant force in ionic liquids is Coulombic attraction between ions. The Coulombic attraction term is given by Equation (3.1-2):

$$E_c = MZ^+Z^-/4\pi\epsilon_0 r \quad (3.1-2)$$

where  $Z^+$  and  $Z^-$  are the ion charges, and  $r$  is the inter-ion separation.

The overall lattice energies of ionic solids, as treated by the Born–Landé or Kaputinskii equations, thus depends on (i) the product of the net ion charges, (ii) ion–ion separation, and (iii) packing efficiency of the ions (reflected in the Madelung constant,  $M$ , in the Coulombic energy term). Thus, low-melting salts should be most

preferred when the charges on the ions are  $\pm 1$  and when the sizes of the ions are large, thus ensuring that the inter-ion separation ( $r$ ) is also large. In addition, large ions permit charge delocalization, further reducing overall charge density.

This can be illustrated for a series of sodium salts, shown in Table 3.1-1, in which the size of the anion is varied.

As the size of the anion increases, the melting point of the salt decreases, reflecting the weaker Coulombic interactions in the crystal lattice. With increasing thermochemical radius of the anion, from  $\text{Cl}^-$  to  $[\text{BF}_4]^-$  to  $[\text{PF}_6]^-$  to  $[\text{AlCl}_4]^-$ , the melting points of the sodium salts decrease from 801 to 185 °C. The results from the sodium salts can be roughly extrapolated to room temperature, and indicate that in order to obtain a salt that would melt at room temperature, the anion would be required to have a radius in excess of about 3.4–4 Å [28]. Large anions are, in general, non-spherical and have significant associated covalency. A similar increase is observed with increasing cation size, on moving down a group in the periodic table, for example. Lithium salts tend to be higher melting than their sodium or cesium analogues. If the charge on the ion can also be delocalized or if the charge-bearing regions can be effectively isolated in the interior of the ionic moiety, then Coulombic terms are further reduced.

Reduction in melting points can, simplistically, be achieved by increasing the size of the anion, or that of the cation. Ionic liquids contain organic cations that are large in comparison to the thermodynamic radii of inorganic cations. This results in significant reductions in the melting points for the organic salts, as illustrated by the  $[\text{EMIM}]^+$  examples in Table 3.1-1. The Coulombic attraction terms for ionic liquids are of comparable magnitude to the intermolecular interactions in molecular liquids.

### 3.1.3.1 Anion size

As shown above, increases in anion size give rise to reductions in the melting points of salts through reduction of the Coulombic attraction contributions to the lattice energy of the crystal and increasing covalency of the ions. In ionic liquids generally, increasing anion size results in lower melting points, as can be seen for a selection of  $[\text{EMIM}]\text{X}$  salts in Table 3.1-2.

Ionic liquids containing carborane anions, described by Reed et al. [35], contain large, near-spherical anions with highly delocalized charge distributions. These ionic liquids have low melting points relative to the corresponding lithium and ammonium salts, but these melting points are higher than might be anticipated

$X^-$	$r$	Melting point	
		$\text{NaX}$	$[\text{EMIM}]\text{X}$
$\text{Cl}^-$	1.7	801	87
$[\text{BF}_4]^-$	2.2	384	6
$[\text{PF}_6]^-$	2.4	> 200	60
$[\text{AlCl}_4]^-$	2.8	185	7

**Table 3.1-1:** Melting points (°C) and thermochemical radii of the anions (Å) for  $\text{Na}^+$  and  $[\text{EMIM}]^+$  salts. The ionic radii of the cations are 1.2 Å ( $\text{Na}^+$ ) and  $2 \times 2.7$  Å ( $[\text{EMIM}]^+$ , non-spherical).



**Table 3.1-2:** [EMIM]X salts and melting points, illustrating anion effects.

Anion [X]	Melting point (°C)	Reference
Cl <sup>-</sup>	87	4
Br <sup>-</sup>	81	22
I <sup>-</sup>	79–81	22
[BF <sub>4</sub> ] <sup>-</sup>	15	6, 29, 26
[AlCl <sub>4</sub> ] <sup>-</sup>	7	4, 6
[GaCl <sub>4</sub> ] <sup>-</sup>	47	30
[AuCl <sub>3</sub> ] <sup>-</sup>	58	31
[PF <sub>6</sub> ] <sup>-</sup>	62	32
[AsF <sub>6</sub> ] <sup>-</sup>	53	
[NO <sub>3</sub> ] <sup>-</sup>	38	33
[NO <sub>2</sub> ] <sup>-</sup>	55	33
[CH <sub>3</sub> CO <sub>2</sub> ] <sup>-</sup>	ca. 45	33
[SO <sub>4</sub> ]·2H <sub>2</sub> O <sup>2-</sup>	70	33
[CF <sub>3</sub> SO <sub>3</sub> ] <sup>-</sup>	-9	25
[CF <sub>3</sub> CO <sub>2</sub> ] <sup>-</sup>	-14	25
[N(SO <sub>2</sub> CF <sub>3</sub> ) <sub>2</sub> ] <sup>-</sup>	-3	25
[N(CN) <sub>2</sub> ] <sup>-</sup>	-21	34
[CB <sub>11</sub> H <sub>12</sub> ] <sup>-</sup>	122	35
[CB <sub>11</sub> H <sub>6</sub> Cl <sub>6</sub> ] <sup>-</sup>	114	35
[CH <sub>3</sub> CB <sub>11</sub> H <sub>11</sub> ] <sup>-</sup>	59	35
[C <sub>2</sub> H <sub>5</sub> CB <sub>11</sub> H <sub>11</sub> ] <sup>-</sup>	64	35

from a simplistic model based solely on comparison of the size of the anions. Similarly, it should be noted that [EMIM][PF<sub>6</sub>] [33] appears to have a higher melting point than would be anticipated. In other large anions – tetraphenylborate, for example [39] – additional attractive interactions such as aromatic  $\pi$ - $\pi$  stacking can give rise to increased melting points.

Anion and cation contributions cannot be taken in isolation; induced dipoles can increase melting points through hydrogen bonding interactions, seen in the crystal structures of [EMIM]X (X = Cl, Br, I) salts [36] and absent from the structure of [EMIM][PF<sub>6</sub>] [32]. In addition to increasing ion-ion separations, larger (and in general, more complex) anions can allow greater charge delocalization. For salts with the anion [(CF<sub>3</sub>SO<sub>2</sub>)<sub>2</sub>N]<sup>-</sup> [25, 37, 38], this is effected by -SO<sub>2</sub>CF<sub>3</sub> groups, which effectively provide a steric block, isolating the delocalized [S-N-S]<sup>-</sup> charged region in the center of the anion.

### 3.1.3.2 Mixtures of anions

Complex anions, formed when halide salts are combined with Lewis acids (e.g., AlCl<sub>3</sub>) produce ionic liquids with reduced melting points through the formation of eutectic compositions [8]. The molar ratio of the two reactants can influence the melting point of the resultant mixed salt system through speciation equilibria. For [EMIM]Cl/AlCl<sub>3</sub>, an apparently simple phase diagram for a binary mixture forming a 1:1 compound and exhibiting two eutectic minima is formed, with a characteristic W-shape to the melting point transition [4, 6] (Figure 3.1-3). Polyanionic species



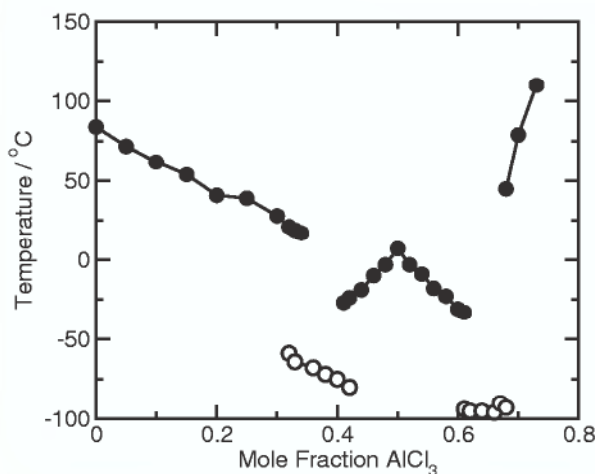

Figure 3.1-3: Phase diagram for [EMIM]Cl/AlCl<sub>3</sub>: (○) melting and freezing points; (●) glass transition points.

including [Al<sub>2</sub>Cl<sub>7</sub>]<sup>-</sup> and [Al<sub>3</sub>Cl<sub>10</sub>]<sup>-</sup> have been identified. Only at 50 % composition is the compound [EMIM][AlCl<sub>4</sub>] formed.

The two eutectic minima, corresponding to 1:2 and 2:1 compositions, result in liquids with very low solidification temperatures; the glass transition temperature for [EMIM]Cl/AlCl<sub>3</sub> (0.33:0.66) is -96 °C. Similar compositional variation should be anticipated in the phase diagrams of other metal halide ionic liquids. The phase behavior of [EMIM]Cl/CuCl [40, 41] and [EMIM]Cl/FeCl<sub>3</sub> [42], for example, is similar. For the [EMIM]Cl/CuCl system, the lower liquidus temperatures in the basic and acidic regions are -40 and -65 °C, respectively. More complex phase diagrams have been reported; one example is [HPy]Cl/ZnCl<sub>2</sub> [19], in which a range of multinuclear zinc halide anions can exist.

The presence of several anions in these ionic liquids has the effect of significantly decreasing the melting point. Considering that the formation of eutectic mixtures of molten salts is widely used to obtain lower melting points, it is surprising that little effort has been put into identifying the effects of mixtures of cations or anions on the physical properties of other ionic liquids [17].

### 3.1.3.3 Cation size

The sizes and shapes of cations in ionic liquids are important in determining the melting points of the salts. On a simple basis, large ions tend to produce reductions in the melting points. Tetraalkylammonium and phosphonium salts are examples of salts containing large cations with delocalized, or more correctly alkyl-shielded charge. The cation radius,  $r$ , is large, and the salts correspondingly display melting points lower than those of their Group 1 analogues. The reduction in melting point over a series of tetraalkylammonium bromide salts with increasing cation size, for example, is shown in Table 3.1-3.

Additionally, the salts contain linear alkyl substituents, which have many rotational degrees of freedom, allowing the alkyl chains to 'melt' at temperatures below

**Table 3.1-3:** Changes in melting points for symmetric tetraalkylammonium bromide salts with increasing size of alkyl substituents.

Cation	Melting point (°C)
[NMe <sub>4</sub> ]	> 300
[NEt <sub>4</sub> ]	284
[NBu <sub>4</sub> ]	124–128
[NHex <sub>4</sub> ]	99–100
[NOct <sub>4</sub> ]	95–98

the melting point and resulting in solid–solid polymorphic transitions. For example, tetrabutylammonium thiocyanate ionic liquid (mp 49.5 °C) has a number of solid–solid transitions associated with changes in alkyl chain conformation [43], which change the density of the solid below the melting point.

In these salts, the interactions in the liquid phase are Coulombic terms also present in the ionic crystalline phase. The ionic attractions are relatively small in comparison to those in analogous inorganic salts, and they are dispersed by the large, hydrocarbon-rich cations. The liquid–solid transition is largely caused by a catastrophic change in the rotational and vibrational freedom of these ions. Since the charge terms are dominant, substituents only appear to contribute to symmetry (rotational freedom) and to dispersal of the charge–charge interactions (large charge–charge separation and distortion from cubic salt-like packing), until sufficient hydrocarbon groups are introduced that van der Waals interactions start to contribute to the crystal ordering.

#### 3.1.3.4 Cation symmetry

Melting points of organic salts have an important relationship to the symmetry of the ions: increasing symmetry in the ions increases melting points, by permitting more efficient ion–ion packing in the crystal cell. Conversely, a reduction in the symmetry of the cations causes a distortion from ideal close-packing of the ionic charges in the solid state lattice, a reduction in the lattice energy, and depression of melting points. A change from spherical or high-symmetry ions such as Na<sup>+</sup> or [NMe<sub>4</sub>]<sup>+</sup> to lower-symmetry ions such as imidazolium cations distorts the Coulombic charge distribution. In addition, cations such as the imidazolium cations contain alkyl groups that do not participate in charge delocalization.

Reduction in cation symmetry (ideally to C<sub>1</sub>) lowers the freezing point and markedly expands the range of room-temperature liquid salts. Table 3.1-4 shows the effect of symmetry for a series of [NR<sub>4</sub>]X salts, in which all the cations contain 20 carbon atoms in the alkyl substituents [44].

Room-temperature liquids are obtained for the salts [N<sub>6554</sub>]Br, [N<sub>10,811</sub>]Br, [N<sub>6644</sub>]Br, [N<sub>8543</sub>][ClO<sub>4</sub>], [N<sub>10,811</sub>][ClO<sub>4</sub>], [N<sub>9551</sub>][ClO<sub>4</sub>], and [N<sub>8651</sub>][ClO<sub>4</sub>], whereas the salts containing cations with high symmetry have much higher melting points. It can be seen that the melting points of these isomeric salts vary by over 200 °C depending on the symmetry of the cation.

Cation ( $[N_{nmop}]^+$ )	$Br^-$	$[ClO_4]^-$	$[BPh_4]^-$
5555	101.3	117.7	203.3
6554	83.4		
6644	83.0		
8444	67.3		
8543	<i>l</i>	109.5	
6662	46.5		
7733	<i>l</i>	45–58	138.8
8663	<i>l</i>	<i>l</i>	110.2
7751	<i>l</i>	104	
8651	<i>l</i>		
9551	<i>l</i>		
9641	<i>l</i>	<i>l</i>	
11333	67–68	65.5	
11432	<i>l</i>		
8822	62		
9821	<i>l</i>		
13331	71–72	52–53	
9911	<i>l</i>		
10811	<i>l</i>	<i>l</i>	
14222	170	152	
16211	180	155	
17111	210	205	

**Table 3.1-4:** Effects of cation symmetry on the melting points of isomeric tetraalkylammonium salts. In each case the cation (designated  $[N_{nmop}]^+$ ) has four linear alkyl substituents, together containing a total of 20 carbons. Salts that are liquid at room temperature are indicated by *l*.

#### 3.1.4.1 Imidazolium salts

Changes in the ring substitution patterns can have significant effects on the melting points of imidazolium salts, beyond those anticipated by simple changes in symmetry or H-bonding interactions (i.e., substitution at the C(2,4,5)-positions on an imidazolium ring affects packing and space-filling of the imidazolium cations). Substitution at the C(2)-position of the imidazolium ring, for example, increases the melting points of the salts. This is not necessarily an obvious or straightforward result, but may be caused by changes in the cation structure that can induce aromatic stacking or methyl- $\pi$  interactions between cations. The introduction of other functionalities around the periphery of the ions can also change the interactions between ions. In most cases, additional functions, such as ether groups, increase the number of interactions, and thus increase melting points.

#### 3.1.4.2 Imidazolium substituent alkyl chain length

The data in Table 3.1-4 illustrate the changes in melting points that can be achieved by changing the symmetry of the cation.  $[RMIM]^+$  salts with asymmetric *N*-substitution have no rotation or reflection symmetry operations. A change in the alkyl chain substitution on one of the ring heteroatoms does not change the symmetry of the cation. However, manipulation of the alkyl chain can produce major changes in the melting points, and also in the tendency of the ionic liquids to form glasses rather than crystalline solids on cooling, by changing the efficiency of ion packing.

**Figure 3.1-4:** Changes in liquefaction points for 1-alkyl-3-methylimidazolium tetrafluoroborate and bis(triflyl)imide ionic liquids as a function of chain length, showing true melting points (solid fill) and glass transitions (open symbols).

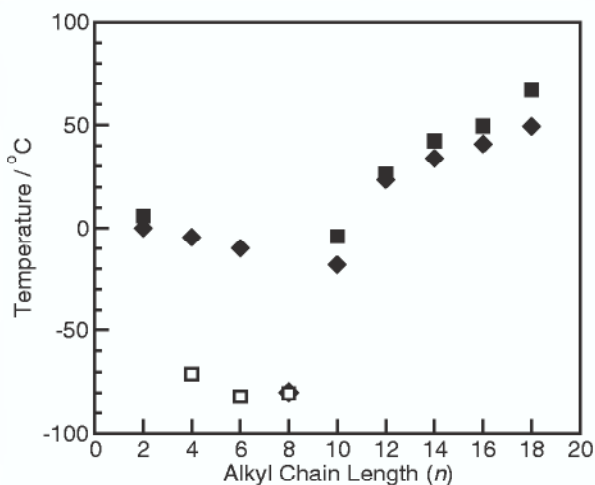

Figure 3.1-4 shows the changes in liquefaction points (either melting points or glass transitions) for a series of 1-alkyl-3-methylimidazolium tetrafluoroborate [26] and bis(triflyl)imide [45] ionic liquids with changing length of the linear alkyl-substituent on the *N*(3)-position.

It is immediately noticeable that an increase in the substituent length initially reduces the melting point of the IL, with the major trend towards glass formation on cooling for  $n = 4$ –10. On extending the alkyl chain lengths beyond a certain point (around 8–10 carbons for alkyl-methylimidazolium salts), the melting points of the salts start to increase again with increasing chain length, as van der Waals interactions between the long hydrocarbon chains contribute to local structure by induction of microphase separation between the covalent, hydrophobic alkyl chains and charged ionic regions of the molecules.

Consideration of the changes in molecular structure and the underlying effects that this will have in both the liquid and crystal phases helps to explain changes in melting points with substitution. The crystalline phases of the ionic liquid are dominated by Coulombic ion–ion interactions, comparable to those in typical salt crystals, although since the ions are larger, the Coulombic interactions are weaker (decreasing with  $r^2$ ). An effect of this is that many organic salts (including ‘ionic liquids’) crystallize with simple, salt-like packing of the anions and cations.

The reported transition temperatures for a range of [RMIM]<sup>+</sup> ionic liquids [6, 23–26, 46] are shown in Figure 3.1-5, with varying anion and alkyl chain substituent length.

The melting transition varies by up to 100 °C with changes in anion (common cation) and almost 250 °C with changes in cation. The phase diagram shows a number of salts that are liquid at or substantially below room temperature. A steady decrease in melting point with increasing chain length, up to a minimum around  $n = 6$ –8, is followed by a progressive increase in melting points with increasing chain length for the longer chain homologues, which form ordered, lamellar ionic

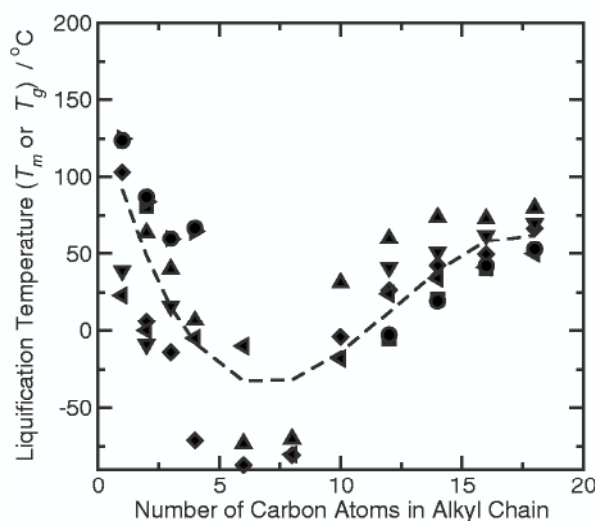

**Figure 3.1-5:** Variation in melting point with alkyl chain length for ionic liquids containing 1-alkyl-3-methylimidazolium cations: chloride (circle), bromide (square), tetrafluoroborate (diamond), hexafluorophosphate (triangle), bis(triflyl)imide (left triangle), triflate (down triangle), and tetrachloroaluminate (right triangle). The data show the general trend for decreasing melting point with increasing  $n$  up to  $n = 8$ , followed by an increase in melting point with  $n$ .

liquid crystalline phases on melting. Most of the salts that are ionic liquids at room temperature form glasses rather than crystalline phases on cooling. The glass transition temperatures all tend towards  $-90$  °C, which is comparable with the  $T_g$  observed for the [EMIM]Cl/AlCl<sub>3</sub> (0.33/0.66) ionic liquid system.

Increased asymmetric substitution on 1-alkyl-3-methylimidazolium salts increases the asymmetric disruption and distortion of the Coulombic packing of ions, giving rise to substantial decreases in the melting point as the efficiency of packing and crystallization is reduced. This results in (i) melting point reduction and (ii) a pronounced tendency towards glass formation rather than crystallization on cooling, on extending the alkyl substituents. This is indicative of inefficient packing within the crystal structures, which is a function of the low-symmetry cations employed. Increasing alkyl chain substitution can also introduce other rheological changes in the ionic liquids, including increased viscosity, reduced density, and increased lipophilicity, which must also be taken into account.

The incorporation of alkyl substituents of increasing chain length in a non-symmetrical arrangement on the ions results in the introduction of 'bulk' into the crystalline lattice, which disrupts the attractive charge-charge lattice. Relatively short alkyl chains act as buffers in this manner, and do not pack well into the available space in the crystalline lattice; high rotational freedom results in low occupation densities over a relatively large volume of space. This free rotation volume probably gives rise to the 'void-space' considered by Brennecke [48] to explain the extraordinary propensity for *sc*-CO<sub>2</sub> to dissolve in ILs without substantially changing the volume of the liquid phase.

#### 3.1.4.3 Branching

Table 3.1-5 provides data for a series of ionic liquids in which the only difference is the degree of branching within the alkyl chain at the imidazolium ring 3-position [24, 47].

**Table 3.1-5:** Melting points and heats of fusion for isomeric [BMIM][PF<sub>6</sub>] and [PMIM][PF<sub>6</sub>] ionic liquids, showing melting point and crystal stability increasing with the degree of branching in the alkyl substituent.

<i>N</i> (1)-Substitution	Melting point (°C)	$\Delta H_{\text{fusion}}$ (kJ mol <sup>-1</sup> )
<i>n</i> -Butyl	6.4	31
<i>sec</i> -Butyl	83.3	72
<i>tert</i> -Butyl	159.7	83
<i>n</i> -Propyl	40	
Isopropyl	102	

The melting points and enthalpies of the three isomeric 1-butyl-3-methylimidazolium hexafluorophosphate salts [BMIM][PF<sub>6</sub>] [47] increase with the degree of chain branching, reflecting the changes in efficiency of the crystal packing as free-rotation volume decreases and atom density is increased. The same effects are also observed for the two isomers of 1-propyl-3-methylimidazolium hexafluorophosphate [PMIM][PF<sub>6</sub>] [24].

### 3.1.5

#### Summary

Liquid structure is defined by short-range ordering, with long-range disorder. The short-range (near neighbor) structuring of the liquids is a combination of dominant Coulombic charge-charge attractions balanced against rotational and vibrational freedom of the ions. Changes in the degrees of freedom and increases in nonparticipating portions of the cation that do not contribute to Coulombic stabilization of the crystal in salt-like lattices result in decreases in melting points and heats of formation. At longer chain lengths, amphiphilic nature is manifested, resulting in hydrophobic van der Waals contributions and formation of bilayer lattices.

The effects of cation symmetry are relatively clear: the melting points of symmetrically substituted 1,3-dialkylimidazolium cations are higher than those of the unsymmetrical cations, and continue to decrease with increasing alkyl substitution up to a critical point around 8–10 carbons, then increase with increasing additional substitution. Both alkyl substitution and ion asymmetry interfere with efficient packing of ions into a crystalline lattice based on Coulombic attractions. However, there appears to be no simple correlation with hydrogen-bonding ability. The absence of strong H-bonding is certainly a major contributor to low melting points, but ionic liquids containing strongly H-bonding anions (such as [CH<sub>3</sub>COO]<sup>-</sup>) have melting points similar to those of ionic liquids incorporating anions that are highly delocalized and unable to H-bond (such as [(CF<sub>3</sub>SO<sub>2</sub>)<sub>2</sub>N]<sup>-</sup>). Similarly, C(2)-substitution might be expected to suppress melting points, by suppressing hydrogen-bonding. This does not appear to be the case, with significant increases in melting points occurring with C(2)-substitution. This implies that the effects of van der Waals interactions through the methyl group, or methyl- $\pi$  interactions, etc., are more important than the electrostatic interactions through the C(2)-hydrogen.



Hagiwara and Ito [49] and Bonhôte et al. [25] have indicated that there appears to be no overall correlation, based on non-systematic changes in cation substitution and anion types, between the composition of an ionic liquid and its melting point. Ngo et al. [24] indicate that the melting points decrease with incorporation of larger, more asymmetrical cations. Ionic liquids containing highly fluorinated anions –  $[\text{BF}_4]^-$ ,  $[\text{PF}_6]^-$ ,  $[(\text{CF}_3\text{SO}_2)_2\text{N}]^-$ ,  $[\text{CF}_3\text{COO}]^-$ , etc. – are generally liquid down to low temperatures, forming glasses on solidification (slow crystallization prior to melting is often observed on heating). However, Katritzky et al. [50, 51] have started to show that the physical properties of imidazolium and pyridinium salts (including ionic liquids) can be modeled by QSPR and CODESSA computational methods, allowing melting points to be predicted with reasonable confidence.

It is important that the forces and interactions that govern the melting points of ionic liquids are not considered in isolation; these interactions also control the dissolution and solubility of other components in the ionic liquids. If, for example, there is a requirement for an ionic liquid to have strong H-bond accepting character (in the anion), then it should be anticipated that this will also give rise to hydrogen-bonding interactions between ions, resulting in greater attractive forces and elevated melting points.

## References

- 1 Seddon, K. R., *J. Chem. Tech. Biotech.* **1997**, *68*, 351.
- 2 Rogers, R. D., *Green Chem.* **2000**, *5*, G94.
- 3 Osteryoung, R. A., Gale, R. J., Robinson, J., Linga, H., Cheek, G., *J. Electrochem. Soc.* **1981**, *128*, 79.
- 4 Wilkes, J. S., Levisky, J. A., Wilson, R. A., Hussey, C. L., *Inorg. Chem.* **1982**, *21*, 1263.
- 5 Fannin, A. A., King, L. A., Levisky, J. A., Wilkes, J. S. *J. Phys. Chem.* **1984**, *88*, 2609.
- 6 Fannin, A. A., Floreani, D. A., King, L. A., Landers, J. S., Piersma, B. J., Stech, D. J., Vaughn, R. L., Wilkes, J. S., Williams, J. L., *J. Phys. Chem.* **1984**, *88*, 2614.
- 7 Hussey, C. L. *Adv. Molten Salt Chem.* **1983**, *5*, 185.
- 8 Cooper, E. I., Sullivan, E. S. M., *Eighth International Symposium on Molten Salts*, Vol. 92-16; The Electrochemical Society: Pennington, NJ, **1992**, 386.
- 9 Welton, T., *Chem. Rev.* **1999**, *99*, 2071.
- 10 Holbrey, J. D., Seddon, K. R., *Clean Prod. Proc.* **1999**, *1*, 233.
- 11 Keim, W., Wasserscheid, P., *Angew. Chem. Int. Ed.* **2000**, *39*, 3772.
- 12 Albanese, D., Landini, D., Maia, A., Penso, M., *J. Mol. Catal. A* **1999**, *150*, 113.
- 13 Blackmore, E. S., Tiddy, G. J. T., *J. Chem. Soc., Faraday Trans. 2* **1988**, *84*, 1115.
- 14 Pernak, J., Krysinski, J., Skrzypczak, A., *Pharmazie* **1985**, *40*, 570.
- 15 Pernak, J., Czepukowicz, A., Pozniak, R., *Ind. Eng. Chem. Res.* **2001**, *40*, 2379.
- 16 Sun, J., Forsyth, M., MacFarlane, D. R., *J. Phys. Chem. B* **1998**, *102*, 8858.
- 17 MacFarlane, D. R., Meakin, P., Sun, J., Amini, N., Forsyth, M., *J. Phys. Chem. B* **1999**, *103*, 4164.
- 18 Abdallah, D. J., Robertson, A., Hsu, H.-F., Weiss, R. G., *J. Amer. Chem. Soc.* **2000**, *122*, 3053.



- 19 Eastale, E. J., Angell, C. A., *J. Phys. Chem.* **1970**, *74*, 3987.
- 20 Holbrey, J. D., Seddon, K. R., Rogers, R. D., unpublished data.
- 21 Hardacre, C., Holbrey, J. D., McCormac, P. B., McMath, S. E. J., Nieuwenhuyzen, M., Seddon, K. R., *J. Mat. Chem.* **2001**, *11*, 346.
- 22 Chan, B. K. M., Chang, N.-H., Grimmett, M. R., *Aust. J. Chem.* **1977**, *30*, 2005.
- 23 Huddleston, J. G., Visser, A. E., Reichert, W. M., Willauer, H. D., Broker, G. A., Rogers, R. D., *Green Chem.* **2001**, 156.
- 24 Ngo, H. L., LeCompte, K., Hargens, L., McEwan, A. B., *Thermochim. Acta.* **2000**, *357-358*, 97.
- 25 Bonhôte, P., Dias, A. P., Papageorgiou, N., Kalyanasundaram, K., Grätzel, M., *Inorg. Chem.* **1996**, *35*, 1168.
- 26 Holbrey, J. D., Seddon, K. R., *J. Chem. Soc., Dalton Trans.* **1999**, 2133.
- 27 Takahashi, S., Koura, N., Kohara, S., Saboungi, M.-L., Curtiss, L. A., *Plasmas & Ions* **1999**, *2*, 91.
- 28 Rooney, D. W., Seddon, K. R., 'Ionic Liquids' in *Handbook of Solvents* (Wypych, G., ed.), ChemTec, Toronto, **2001**, p. 1459.
- 29 Fuller, J., Carlin, R. T., Osteryoung, R. A., *J. Electrochem. Soc.* **1997**, *144*, 3881.
- 30 Wicelinski, S. P., Gale, R. J., Wilkes, J. S., *J. Electrochem. Soc.* **1987**, *134*, 262.
- 31 Hasan, M., Kozhevnikov, I. V., Siddiqui, M. R. H., Steiner, A., Winter-ton, N., *Inorg. Chem.* **1999**, *38*, 5637.
- 32 Fuller, J., Carlin, R. T., De Long, H. C., Haworth, D., *Chem. Commun.* **1994**, 229.
- 33 Wilkes, J. S., Zaworotko, M. J., *J. Chem. Soc., Chem. Commun.* **1992**, 965.
- 34 MacFarlane, D. R., Golding, J., Forsyth, S., Forsyth, M., Deacon, G. B., *Chem. Commun.* **2001**, 1430.
- 35 Larsen, A. S., Holbrey, J. D., Tham, F. S., Reed, C. A., *J. Amer. Chem. Soc.* **2000**, *122*, 7264.
- 36 Elaiwi, A., Hitchcock, P. B., Seddon, K. R., Srinivasan, N., Tan, Y. M., Welton, T., Zora, J. A., *J. Chem. Soc., Dalton Trans.* **1995**, 3467.
- 37 Golding, J. J., MacFarlane, D. R., Spicca, L., Forsyth, M., Skelton, B. W., White, A. H., *Chem. Commun.* **1998**, 1593.
- 38 Noda, A., Hayamizu, K., Watanabe, M., *J. Phys. Chem. B* **2001**, *105*, 4603.
- 39 Suarez, P. A. Z., Dupont, J., Souza, R. F., Burrow, R. A., Kintzinger, J.-P., *Chem. Eur. J.* **2000**, 2377.
- 40 Bolkan, S. A., Yoke, J. T., *J. Chem. Eng. Data.* **1986**, *31*, 194.
- 41 Bolkan, S. A., Yoke, J. T. *Inorg. Chem.*, **1986**, *25*, 3587.
- 42 Sitze, M. S., Schreiter, E. R., Patterson, E. V., Freeman, R. G., *Inorg. Chem.* **2001**, *40*, 2298.
- 43 Coker, T. G., Wunderlich, B., Janz, G. J., *Trans. Faraday Soc.* **1969**, *65*, 3361.
- 44 Gordon, J. E., SubbaRao, G. N., *J. Amer. Chem. Soc.* **1978**, *100*, 7445.
- 45 Holbrey, J. D., Johnston, S., Rogers, G., Rooney, D. W., Seddon, K. R., unpublished data.
- 46 Gordon, C. M., Holbrey, J. D., Kennedy, A., Seddon, K. R., *J. Mater. Chem.* **1998**, *8*, 2627.
- 47 Carmichael, A. J., Hardacre, C., Holbrey, J. D., Nieuwenhuyzen, M., Seddon, K. R., *Eleventh International Symposium on Molten Salts*, Vol. 99-41 (Truelove, P. C., De Long, H. C., Stafford, G. R., Deki, S. eds.), The Electrochemical Society, Pennington, NJ, **1999**, 209.
- 48 Blanchard, L. A., Gu, Z., Brennecke, J. F., *J. Phys. Chem. B* **2001**, 2437.
- 49 Hagiwara, R., Ito, Y., *J. Fluor. Chem.* **2000**, *105*, 221.
- 50 Katritzky, A. R., Lomaka, A., Petrukhin, R., Jain, R., Karelson, M., Visser, A. E., Rogers, R. D., *J. Chem. Inf. Comp. Sci.* **2002**, *42*, 71.
- 51 Katritzky, A. R., Jain, R., Lomaka, A., Petrukhin, R., Karelson, M., Visser, A. E., Rogers, R. D., *J. Chem. Inf. Comp. Sci.* **2002**, *42*, 225.

## 3.2

**Viscosity and Density of Ionic Liquids***Robert A. Mantz and Paul C. Trulove*

## 3.2.1

**Viscosity of Ionic Liquids**

The viscosity of a fluid arises from the internal friction of the fluid, and it manifests itself externally as the resistance of the fluid to flow. With respect to viscosity there are two broad classes of fluids: Newtonian and non-Newtonian. Newtonian fluids have a constant viscosity regardless of strain rate. Low-molecular-weight pure liquids are examples of Newtonian fluids. Non-Newtonian fluids do not have a constant viscosity and will either thicken or thin when strain is applied. Polymers, colloidal suspensions, and emulsions are examples of non-Newtonian fluids [1]. To date, researchers have treated ionic liquids as Newtonian fluids, and no data indicating that there are non-Newtonian ionic liquids have so far been published. However, no research effort has yet been specifically directed towards investigation of potential non-Newtonian behavior in these systems.

Experimentally determined viscosities are generally reported either as absolute viscosity ( $\eta$ ) or as kinematic viscosity ( $\nu$ ). Kinematic viscosity is simply the absolute viscosity normalized by the density of the fluid. The relationship between absolute viscosity ( $\eta$ ), density ( $\rho$ ), and kinematic viscosity ( $\nu$ ) is given by Equation 3.2-1.

$$\frac{\eta}{\rho} = \nu \quad (3.2-1)$$

The unit of absolute viscosity is the Poise (P,  $\text{g cm}^{-1}\text{s}^{-1}$  or  $\text{mPa s}$ ), while the unit for kinematic viscosity is the Stoke (St,  $\text{cm}^2\text{s}^{-1}$ ). Because of the large size of these viscosity units, absolute viscosities for ionic liquids are usually reported in centipoises (cP) and kinematic viscosities reported in centistokes (cSt).

**3.2.1.1 Viscosity measurement methods**

The viscosities of ionic liquids have normally been measured by one of three methods: falling ball, capillary, or rotational. Falling ball viscometers can easily be constructed from a graduated cylinder and appropriately sized ball bearings. The ball bearing material and the diameter can be varied. The experiment is conducted by filling the graduated cylinder with the fluid to be investigated and carefully dropping the ball through the fluid. After the ball has reached steady state, the velocity is measured. The absolute viscosity can then be calculated by Stokes' law (Equation 3.2-2) [1]:

$$\eta = \left(\frac{2}{9}\right) \frac{(\rho_s - \rho)gR^2}{\nu} \quad (3.2-2)$$

where  $\eta$  is the absolute viscosity,  $\rho_s$  is the density of the ball,  $\rho$  is the density of the fluid,  $g$  is the gravity constant ( $980 \text{ cm s}^{-2}$ ),  $R$  is the radius of the ball, and  $v$  is the steady-state velocity of the ball. A falling ball viscometer is commonly calibrated with a standard fluid similar in viscosity to the fluid of interest, and an instrument constant ( $k$ ) is then determined. Comparisons between the standard fluid and the unknown fluid can then be made by means of Equation 3.2-3

$$v = k(\rho_s - \rho)\theta \quad (3.2-3)$$

where  $\theta$  is the time of fall between two fiducial marks on the viscometer tube. This technique does have several limitations: the fluid must be Newtonian, the density of the fluid must be known, and the downward velocity of the ball should not exceed  $\sim 1 \text{ cm s}^{-1}$  to aid in time measurement. The falling ball method is generally used to measure absolute viscosities from  $10^{-3}$  to  $10^7 \text{ P}$  [2].

Capillary viscometers are simple and inexpensive. They are normally constructed from glass and resemble a U-tube with a capillary section between two bulbs. The initial design originated with Ostwald and is shown as part A in Figure 3.2-1. The Cannon–Fenske type, a popular modification of the Ostwald design that moves the bulbs into the same vertical axis, is shown as part B in Figure 3.2-1.

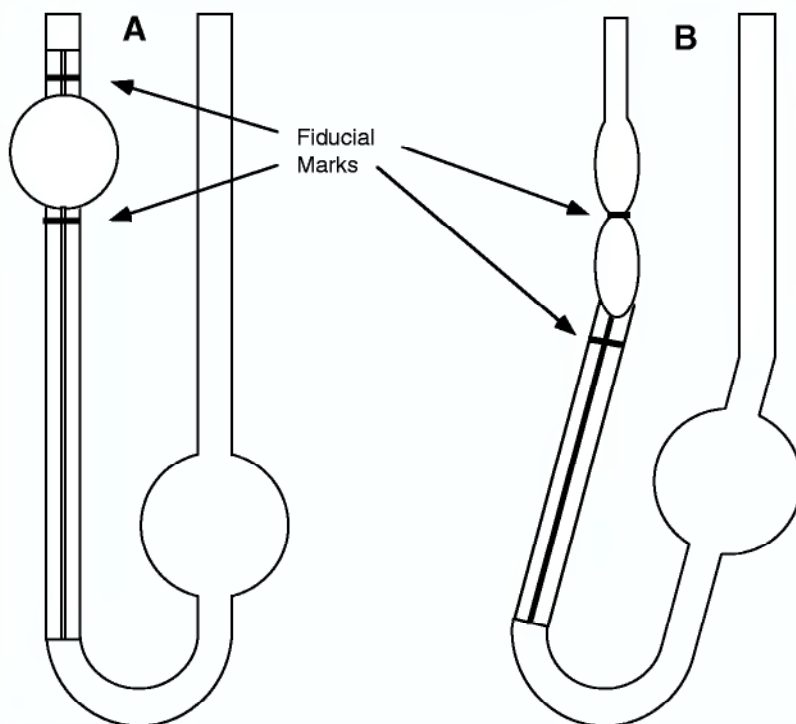

Figure 3.2-1: Diagrams of (A) Ostwald and (B) Cannon–Fenske capillary viscometers.

Capillary viscometers are normally immersed in a constant-temperature bath, to regulate the sample temperature precisely during the experiment. To determine the viscosity, the fluid in the viscometer is drawn into the upper bulb by vacuum. The vacuum is released, and the time for the fluid to fall past the marks above and below the bulb is measured. The main driving force for flow in this type of viscometer is gravity, although pressure can be applied to one side of the viscometer to provide an additional driving force (increased head pressure) [1]. Since the driving pressure is governed by the difference in heights of the liquid in the viscometer, it is important always to use the same volume of liquid in each experiment. The kinematic viscosity can be calculated by Equation 3.2-4 [2]:

$$\nu = \frac{[\pi g (z_1 - z_2) D^4]}{128LV_o} \Delta t \quad (3.2-4)$$

where  $(z_1 - z_2)$  is the difference in height,  $D$  is the capillary inner diameter,  $L$  is the length of the capillary, and  $V_o$  is the volume between the fiducial marks. This equation only holds as long as the liquid behaves as a Newtonian fluid and the length-to-diameter ratio of the capillary tube is large.

Capillary viscometers measure the kinematic viscosity directly, because the head pressure is generated by the weight of the fluid. In order to convert to absolute viscosity, the kinematic viscosity must be multiplied by the fluid density [Equation (3.2-1)]. Obviously this requires additional experiments to determine fluid density so that the absolute viscosity can be calculated. The capillary type viscometer is normally used to measure kinematic viscosities spanning the range from  $4 \times 10^{-3}$  to  $1.6 \times 10^2$  Stokes, with experimental times ranging from 200 to 800 seconds [1]. This range of kinematic viscosities corresponds to absolute viscosities of  $6 \times 10^{-3}$  to  $2.4 \times 10^2$  P, assuming an average ionic liquid density of  $1.5 \text{ g cm}^{-3}$ .

The last type of widely used viscometer is the rotational viscometer. These can adopt a variety of geometries, including concentric cylinders, cone and plate, and parallel disks. Of the three geometries, the concentric cylinders is the most common, because it is well suited for low-viscosity fluids [2]. Rotational viscometers consist of two main elements: a rotating element and a fixed element. The liquid to be measured is placed in the space between the two elements. The viscosity is determined by measurement of the torque transferred between the two elements by the liquid. For the concentric cylinder geometry, the outer cylinder is often rotated at a fixed speed and the torque is measured on the fixed center cylinder immersed in the liquid. By measuring the angular speed of the rotating cylinder and the torque on the fixed cylinder, the fluid viscosity can be calculated by Equation 3.2-5 [2]:

$$\eta = \left\{ \frac{[\beta^2 - 1]}{[4\pi R_2^2 L_e]} \right\} \frac{T}{\omega_2} \quad (3.2-5)$$

where  $\beta$  is the ratio of the cylinder radii,  $R_2$  is the radius of the outer cylinder,  $L_e$  is the effective length of the cylinder,  $T$  is the torque applied to the rotating cylinder, and  $\omega_2$  is the rotational speed of the outer cylinder [2]. The effective length of the

cylinder ( $L_e$ ) consists of the immersion depth of the center cylinder plus an end effect correction. This equation requires  $\beta$  to be less than 1.2.

All three methods discussed above appear to provide equally high quality ionic liquid viscosity data. However, the rotational viscometer could potentially provide additional information concerning the Newtonian behavior of the ionic liquids. The capillary method has been by far the most commonly used to generate the ionic liquid viscosity data found in the literature. This is probably due to its low cost and relative ease of use.

### 3.2.1.2 Ionic liquid viscosities

As a group, ionic liquids are more viscous than most common molecular solvents. Ionic liquid viscosities at room temperature range from a low of around 10 cP to values in excess of 500 cP. For comparative purposes, the viscosities of water, ethylene glycol, and glycerol at room temperature are 0.890, 16.1, and 934 cP, respectively [3]. The room-temperature viscosity data (also conductivity and density data) for a wide variety of ionic liquids are listed in Tables 3.2-1, 3.2-2, and 3.2-3. These tables are organized by the general type of ionic liquid. Table 3.2-1 contains data for non-haloaluminate alkylimidazolium ionic liquids, Table 3.2-2 for the haloaluminate ionic liquids, and Table 3.2-3 for other types of ionic liquids. There are multiple listings for several of the ionic liquids in Tables 3.2-1–3.2-3. These represent measurements by different researchers and have been included to help emphasize the significant variability in the viscosity data found in the literature.

The viscosities of many ionic liquids are strongly dependent upon temperature. For example, the viscosity of 1-butyl-3-methylimidazolium hexafluorophosphate increases 27 % with a 5 degree change between 298 and 293 K [16]. Clearly some of the apparent variability in the literature data seen in Tables 3.2-1–3.2-3 may have resulted from errors associated with control of experimental temperature. However, much of this variability is probably the result of impurities in the ionic liquids. Recent work with non-haloaluminate alkylimidazolium ionic liquids has established the ubiquitous nature of impurities in these ionic liquids, and has demonstrated the dramatic impact relatively that small amounts of impurities can have on ionic liquid viscosity [28]. In this study, a series of ionic liquids were prepared and purified by a variety of techniques. They were then analyzed for impurities and their physical properties evaluated. Chloride concentrations of up to 6 wt. % were found for some of the preparative methods. Residual chloride concentrations of between 1.5 and 6 wt. % increased the observed viscosity by between 30 and 600 % [28]. This work also showed the strong propensity of the non-haloaluminate alkylimidazolium ionic liquids to absorb water from laboratory air, and the significant solubility of water in these same ionic liquids (up to 14 wt. % for one ionic liquid). Surprisingly, as little as 2 wt. % (20 mol %) water (as well as other co-solvents, *vide infra*) reduced the observed viscosity of [BMIM][BF<sub>4</sub>] by more than 50 %. Given this information, it is highly likely that many of the ionic liquids listed in Table 3.2-1 (and by analogy Tables 3.2-2 and 3.2-3) contained significant concentrations of impurities (especially water). This, in turn, complicates the evaluation of the literature data, and any conclusions drawn below must consequently be used with care.

Table 3.2-1: Specific conductivity data for non-haloaluminate alkylimidazolium-based ionic liquids.

Cation	Anion	Temperature (K)	Conductivity ( $\kappa$ ), mS cm <sup>-1</sup>	Conductivity method	Viscosity ( $\eta$ ), cP	Viscosity method	Density ( $\rho$ ), g cm <sup>-3</sup>	Density method	Molar Conductivity ( $\Lambda$ ), cm <sup>2</sup> Ω <sup>-1</sup> mol <sup>-1</sup>	Walden product ( $\Lambda\eta$ )	Ref.
[MMIM] <sup>+</sup>	[(CF <sub>3</sub> SO <sub>2</sub> ) <sub>2</sub> N] <sup>-</sup>	293	8.4	B	44	R	1.559	U	2.03	89.44	4
[EMIM] <sup>+</sup>	[BF <sub>4</sub> ] <sup>-</sup>	295	12	I							5
[EMIM] <sup>+</sup>	[BF <sub>4</sub> ] <sup>-</sup>	298	14	B	34	U	1.240	U	2.24	76.22	6
[EMIM] <sup>+</sup>	[BF <sub>4</sub> ] <sup>-</sup>	298	14	I	32	R	1.279	I	2.17	68.91	7 <sup>a</sup>
[EMIM] <sup>+</sup>	[BF <sub>4</sub> ] <sup>-</sup>	299	13	B	43	R					8
[EMIM] <sup>+</sup>	[BF <sub>4</sub> ] <sup>-</sup>	303	20	I							9
[EMIM] <sup>+</sup>	[PF <sub>6</sub> ] <sup>-</sup>	299	5.2	B							8
[EMIM] <sup>+</sup>	[CH <sub>3</sub> CO <sub>2</sub> ] <sup>-</sup>	293	2.8	B	162	R					4
[EMIM] <sup>+</sup>	[CF <sub>3</sub> CO <sub>2</sub> ] <sup>-</sup>	293	9.6	B	35	R	1.285	U	1.67	58.62	4
[EMIM] <sup>+</sup>	[C <sub>3</sub> F <sub>7</sub> CO <sub>2</sub> ] <sup>-</sup>	293	2.7	B	105	R	1.450	U	0.60	63.39	4
[EMIM] <sup>+</sup>	[CH <sub>3</sub> SO <sub>3</sub> ] <sup>-</sup>	298	2.7	B	160	C	1.240	V	0.45	71.86	10
[EMIM] <sup>+</sup>	[CF <sub>3</sub> SO <sub>3</sub> ] <sup>-</sup>	293	8.6	B	45	R	1.390	U	1.61	72.45	4
[EMIM] <sup>+</sup>	[CF <sub>3</sub> SO <sub>3</sub> ] <sup>-</sup>	298	9.2	B	43	C	1.380	V	1.73	74.08	10
[EMIM] <sup>+</sup>	[CF <sub>3</sub> SO <sub>3</sub> ] <sup>-</sup>	303	8.2	B							11 <sup>b</sup>
[EMIM] <sup>+</sup>	[(CF <sub>3</sub> SO <sub>2</sub> ) <sub>2</sub> N] <sup>-</sup>	293	8.8	B	34	R	1.520	U	2.27	77.03	4
[EMIM] <sup>+</sup>	[(CF <sub>3</sub> SO <sub>2</sub> ) <sub>2</sub> N] <sup>-</sup>	298	5.7	I	31	R	1.518	I	1.47	44.82	7 <sup>c</sup>
[EMIM] <sup>+</sup>	[(CF <sub>3</sub> SO <sub>2</sub> ) <sub>2</sub> N] <sup>-</sup>	303	10	I							11 <sup>b</sup>
[EMIM] <sup>+</sup>	[(CF <sub>3</sub> SO <sub>2</sub> ) <sub>2</sub> N] <sup>-</sup>	298	9.2	B	34	U	1.510	U	2.38	81.06	12
[EMIM] <sup>+</sup>	[(CF <sub>3</sub> SO <sub>2</sub> ) <sub>2</sub> N] <sup>-</sup>	299	8.4	B	28	R					8
[EMIM] <sup>+</sup>	[(C <sub>2</sub> F <sub>5</sub> SO <sub>2</sub> ) <sub>2</sub> N] <sup>-</sup>	299	3.4	B	61	R					8
[EMMIM] <sup>+</sup>	[(CF <sub>3</sub> SO <sub>2</sub> ) <sub>2</sub> N] <sup>-</sup>	293	3.2	B	88	R	1.495	U	0.87	76.35	4
[EMM(5)IM] <sup>+</sup>	[CF <sub>3</sub> SO <sub>3</sub> ] <sup>-</sup>	293	6.4	B	51	R	1.334	U	1.32	67.11	4
[EMM(5)IM] <sup>+</sup>	[(CF <sub>3</sub> SO <sub>2</sub> ) <sub>2</sub> N] <sup>-</sup>	293	6.6	B	37	R	1.470	U	1.82	67.34	4
[PMIM] <sup>+</sup>	[PF <sub>6</sub> ] <sup>-</sup>	293					1.333	V			13
[PMMIM] <sup>+</sup>	[BF <sub>4</sub> ] <sup>-</sup>	295	5.9	I							14
[PMMIM] <sup>+</sup>	[PF <sub>6</sub> ] <sup>-</sup>	308	0.5	B							8
[PMMIM] <sup>+</sup>	[(CF <sub>3</sub> SO <sub>2</sub> ) <sub>2</sub> N] <sup>-</sup>	299	3.0	B	60	R					8





Table 3.2-2: Specific conductivity data for binary haloaluminate ionic liquids.

Ionic liquid System	Cation	Anion(s)	Temperature, (K)	Conductivity ( $\kappa$ ), $\text{mS cm}^{-1}$	Conductivity method	Viscosity ( $\eta$ ), cP	Viscosity method	Density ( $\rho$ ), $\text{g cm}^{-3}$	Density method	Molar conductivity ( $\Lambda$ ), $\text{cm}^2 \text{S}^{-1} \text{mol}^{-1}$	Walden product ( $\Lambda\eta$ )	Ref.
34.0–66.0 mol% [MIM]Cl/AlCl <sub>3</sub>	[MIM] <sup>+</sup>	[Al <sub>2</sub> Cl <sub>7</sub> ] <sup>-</sup>	298	15.0	B	17	C	1.404	P	4.26	72.07	17 <sup>a</sup>
34.0–66.0 mol% [EMIM]Cl/AlCl <sub>3</sub>	[EMIM] <sup>+</sup>	[Al <sub>2</sub> Cl <sub>7</sub> ] <sup>-</sup>	298	15.0	B	14	C	1.389	P	4.46	62.95	17 <sup>a</sup>
50.0–50.0 mol% [EMIM]Cl/AlCl <sub>3</sub>	[EMIM] <sup>+</sup>	[AlCl <sub>4</sub> ] <sup>-</sup>	298	23.0	B	18	C	1.294	P	4.98	89.07	17 <sup>a</sup>
60.0–40.0 mol% [EMIM]Cl/AlCl <sub>3</sub>	[EMIM] <sup>+</sup>	Cl <sup>-</sup> , [AlCl <sub>4</sub> ] <sup>-</sup>	298	6.5	B	47	C	1.256	P	1.22	57.77	17 <sup>a</sup>
34.0–66.0 mol% [EMIM]Br/AlBr <sub>3</sub>	[EMIM] <sup>+</sup>	[Al <sub>2</sub> Br <sub>7</sub> ] <sup>-</sup>	298	5.8	B	32	C	2.219	P	1.89	59.64	18 <sup>ab</sup>
60.0–40.0 mol% [EMIM]Br/AlBr <sub>3</sub>	[EMIM] <sup>+</sup>	Br <sup>-</sup> , [AlBr <sub>4</sub> ] <sup>-</sup>	298	5.7	B	67	C	1.828	P	1.15	76.72	18 <sup>ab</sup>
40.0–60.0 mol% [PMIM]Cl/AlCl <sub>3</sub>	[PMIM] <sup>+</sup>	[AlCl <sub>4</sub> ] <sup>-</sup> , [Al <sub>2</sub> Cl <sub>7</sub> ] <sup>-</sup>	298	11.0	B	18	C	1.351	P	2.94	53.44	17 <sup>a</sup>
50.0–50.0 mol% [PMIM]Cl/AlCl <sub>3</sub>	[PMIM] <sup>+</sup>	[AlCl <sub>4</sub> ] <sup>-</sup>	298	12.0	B	27	C	1.262	P	2.79	76.29	17 <sup>a</sup>
60.0–40.0 mol% [PMIM]Cl/AlCl <sub>3</sub>	[PMIM] <sup>+</sup>	Cl <sup>-</sup> , [AlCl <sub>4</sub> ] <sup>-</sup>	298	3.3	B	27	C	1.262	P	2.79	76.29	17 <sup>a</sup>
34.0–66.0 mol% [BMIM]Cl/AlCl <sub>3</sub>	[BMIM] <sup>+</sup>	[Al <sub>2</sub> Cl <sub>7</sub> ] <sup>-</sup>	298	9.2	B	19	C	1.334	P	3.04	58.45	17 <sup>a</sup>
50.0–50.0 mol% [BMIM]Cl/AlCl <sub>3</sub>	[BMIM] <sup>+</sup>	[AlCl <sub>4</sub> ] <sup>-</sup>	298	10.0	B	27	C	1.238	P	2.49	67.42	17 <sup>a</sup>
34.0–66.0 mol% [BBIM]Cl/AlCl <sub>3</sub>	[BBIM] <sup>+</sup>	[Al <sub>2</sub> Cl <sub>7</sub> ] <sup>-</sup>	298	6.0	B	24	C	1.252	P	2.32	55.36	17 <sup>a</sup>
50.0–50.0 mol% [BBIM]Cl/AlCl <sub>3</sub>	[BBIM] <sup>+</sup>	[AlCl <sub>4</sub> ] <sup>-</sup>	298	5.0	B	38	C	1.164	P	1.50	56.83	17 <sup>a</sup>
33.3–66.7 mol% [MP]Cl/AlCl <sub>3</sub>	[MP] <sup>+</sup>	[Al <sub>2</sub> Cl <sub>7</sub> ] <sup>-</sup>	298	8.1	B	21	C	1.441	P	2.23	46.12	19 <sup>a</sup>
33.3–66.7 mol% [EP]Cl/AlCl <sub>3</sub>	[EP] <sup>+</sup>	[Al <sub>2</sub> Cl <sub>7</sub> ] <sup>-</sup>	298	10.0	B	18	C	1.408	P	2.91	51.29	19 <sup>a</sup>
33.3–66.7 mol% [EP]Br/AlCl <sub>3</sub>	[EP] <sup>+</sup>	[Al <sub>2</sub> Cl <sub>7</sub> ] <sup>-</sup> , [Al <sub>2</sub> Cl <sub>6</sub> Br <sub>2</sub> ] <sup>-</sup>	298	8.4	B	22	C	1.524	P	2.91	51.29	19 <sup>a</sup>
33.3–66.7 mol% [EP]Br/AlCl <sub>3</sub>	[EP] <sup>+</sup>	[Al <sub>2</sub> Cl <sub>7</sub> ] <sup>-</sup>	298	17.0	B	25	C	1.524	P	2.91	51.29	19 <sup>a</sup>
33.3–66.7 mol% [EP]Br/AlBr <sub>3</sub>	[EP] <sup>+</sup>	[Al <sub>2</sub> Br <sub>7</sub> ] <sup>-</sup>	298	8.0	B	50	C	2.20	V	2.47	44.93	19 <sup>b</sup>
33.3–66.7 mol% [PP]Cl/AlCl <sub>3</sub>	[PP] <sup>+</sup>	[Al <sub>2</sub> Cl <sub>7</sub> ] <sup>-</sup>	298	8.0	B	18	C	1.375	P	2.47	44.93	19 <sup>b</sup>
33.3–66.7 mol% [BP]Cl/AlCl <sub>3</sub>	[BP] <sup>+</sup>	[Al <sub>2</sub> Cl <sub>7</sub> ] <sup>-</sup>	298	6.7	B	21	C	1.346	P	2.18	45.81	19 <sup>b</sup>

I = complex impedance, B = conductivity bridge, C = capillary viscometer, P = pycnometer or dilatometer, V = volumetric glassware, I = instrument, U = method unknown (not provided in the reference). <sup>a</sup> Conductivity at 298K calculated from least-squares-fitted parameters given in reference. <sup>b</sup> Conductivity estimated from graphical data provided in the reference.

Table 3.2-3: Specific conductivity data for other room-temperature ionic liquids

Cation	Anion	Temperature, (K)	Conductivity ( $\kappa$ ), mS cm <sup>-1</sup>	Conductivity method	Viscosity ( $\eta$ ), cP	Viscosity method	Density ( $\rho$ ), g cm <sup>-3</sup>	Density method	Molar conductivity ( $\Lambda$ ), cm <sup>2</sup> $\Omega^{-1}$ mol <sup>-1</sup>	Walden product ( $\Delta\eta$ )	Ref
<b>Ammonium</b>											
	[(CH <sub>3</sub> ) <sub>2</sub> (C <sub>2</sub> H <sub>5</sub> )(CH <sub>3</sub> OC <sub>2</sub> H <sub>4</sub> )N] <sup>+</sup>	298	1.7	B							22
	[(n-C <sub>3</sub> H <sub>7</sub> )(CH <sub>3</sub> ) <sub>2</sub> N] <sup>+</sup>	298	3.3	B	72	U	1.440	U	0.88	63.09	12
	[(n-C <sub>6</sub> H <sub>13</sub> )(C <sub>2</sub> H <sub>5</sub> ) <sub>2</sub> N] <sup>+</sup>	298	0.67	I	167	C	1.270	V	0.25	41.10	23
	[(n-C <sub>8</sub> H <sub>17</sub> )(C <sub>2</sub> H <sub>5</sub> ) <sub>2</sub> N] <sup>+</sup>	298	0.33	I	202	C	1.250	V	0.13	26.37	23
	[(n-C <sub>8</sub> H <sub>17</sub> )(C <sub>4</sub> H <sub>9</sub> ) <sub>2</sub> N] <sup>+</sup>	298	0.13	I	574	C	1.120	V	0.07	38.56	23
	[(CH <sub>3</sub> )(CH <sub>3</sub> OC <sub>2</sub> H <sub>4</sub> ) <sub>2</sub> N] <sup>+</sup>	298	4.7	B	50	U	1.510	U	1.20	59.81	12
	1-methyl-1-propyl-pyrrolidinium	298	1.4	B	63	C	1.45	V			24
	1-butyl-1-methyl-pyrrolidinium	298	2.2	B	85	C	1.41	V			24
<b>Pyrazolium</b>											
	1,2-dimethyl-4-fluoropyrazolium [BF <sub>4</sub> ] <sup>-</sup>	298	1.3	B							25
<b>Pyridinium</b>											
	[BP] <sup>+</sup>	298	1.9	I	103	R	1.220	I	0.35	35.77	7 <sup>a</sup>
	[BP] <sup>+</sup>	303	3.0	I							9
	[BP] <sup>+</sup>	298	2.2	I	57	R	1.449	I	0.63	35.91	7 <sup>a</sup>
<b>Sulfonium</b>											
	[(CH <sub>3</sub> ) <sub>3</sub> S] <sup>+</sup>	298	34	B	20.5	C	1.74	P	4.62	95.33	21
	[(CH <sub>3</sub> ) <sub>3</sub> S] <sup>+</sup> <sup>b</sup>	298	56	B	8.3	C	1.79	P	8.41	69.80	21
	[(CH <sub>3</sub> ) <sub>2</sub> S] <sup>+</sup>	298	5.5	B	39.3	C	1.40	V	1.49	58.56	27
	[(CH <sub>3</sub> ) <sub>2</sub> S] <sup>+</sup>	298	5.5	B	54.9	C	1.59	V	1.12	61.60	27
	[(CH <sub>3</sub> ) <sub>2</sub> S] <sup>+</sup>	298	4.21	B	138	C	2.40	V	0.41	57.17	27
	[(CH <sub>3</sub> ) <sub>2</sub> S] <sup>+</sup>	298	1.44	B	44	U	1.580	U	1.85	81.59	27
	[(CH <sub>3</sub> ) <sub>2</sub> S] <sup>+</sup>	318	8.2	B	30	U	1.460	U	1.94	58.27	27
	[(C <sub>2</sub> H <sub>5</sub> ) <sub>2</sub> S] <sup>+</sup>	298	7.1	B	75	U	1.290	U	0.52	39.36	27
	[(n-C <sub>4</sub> H <sub>9</sub> ) <sub>3</sub> S] <sup>+</sup>	298	1.4	B							
<b>Thiazolium</b>											
	1-ethylthiazolium [CF <sub>3</sub> SO <sub>3</sub> ] <sup>-</sup>	298	4.2	B			1.50	V			10

I = complex impedance, B = conductivity bridge, C = capillary viscometer, P = pycnometer or dilatometer, V = volumetric glassware, I = instrument, U = method unknown (not provided in the reference). <sup>a</sup> Conductivity at 298K calculated from VTF. Parameters given in reference. <sup>b</sup> Binary composition of 42.0–58.0 mol % [(CH<sub>3</sub>)<sub>3</sub>S]Br–HBr.

Within a series of non-haloaluminate ionic liquids containing the same cation, a change in the anion clearly affects the viscosity (Tables 3.2-1 and 3.2-3). The general order of increasing viscosity with respect to the anion is:  $[(CF_3SO_2)_2N]^- \cong [BF_4]^- \cong [CF_3CO_2]^- \cong [CF_3SO_3]^- < [(C_2H_5SO_2)_2N]^- < [C_3F_7CO_2]^- < [CH_3CO_2]^- \cong [CH_3SO_3]^- < [C_4F_9SO_3]^-$ . Obviously, this trend does not exactly correlate with anion size. This may be due to the effect of other anion properties on the viscosity, such as their ability to form weak hydrogen bonds with the cation.

The viscosities of non-haloaluminate ionic liquids are also affected by the identity of the organic cation. For ionic liquids with the same anion, the trend is that larger alkyl substituents on the imidazolium cation give rise to more viscous fluids. For instance, the non-haloaluminate ionic liquids composed of substituted imidazolium cations and the bis-triflyl imide anion exhibit increasing viscosity from  $[EMIM]^+$ ,  $[EEIM]^+$ ,  $[EMM(5)IM]^+$ ,  $[BEIM]^+$ ,  $[BMIM]^+$ ,  $[PMMIM]^+$ , to  $[EMMIM]^+$  (Table 3.2-1). Were the size of the cations the sole criteria, the  $[BEIM]^+$  and  $[BMIM]^+$  cations from this series would appear to be transposed and the  $[EMMIM]^+$  would be expected much earlier in the series. Given the limited data set, potential problems with impurities, and experimental differences between laboratories, we are unable to propose an explanation for the observed disparities.

The haloaluminate ionic liquids are prepared by mixing two solids, an organic chloride and an aluminium halide (e.g.,  $[EMIM]Cl$  and  $AlCl_3$ ). These two solids react to form ionic liquids with a single cation and a mix of anions, the anion composition depending strongly on the relative molar amounts of the two ingredients used in the preparation. The effect of anionic composition on the viscosity of haloaluminate ionic liquids has long been recognized. Figure 3.2-2 shows the absolute viscosities of the  $[EMIM]Cl/AlCl_3$  ionic liquids at 303 K over a range of compositions.

When the amount of  $[EMIM]Cl$  is below 50 mol %, the viscosity is relatively constant, only varying from 14 to 18 cP. However, when the  $[EMIM]Cl$  exceeds 50 mol %, the absolute viscosity begins to increase, eventually rising to over 190 cP at 67 mol %  $[EMIM]Cl$  [17]. This dramatic increase in viscosity is strongly correlated to the corresponding growth in chloride ion concentration as the  $[EMIM]Cl$  mol % increases, and appears to be the result of hydrogen bonding between the  $Cl^-$  anions and the hydrogen atoms on the imidazolium cation ring [29–32].

The size of the cation in the chloroaluminate ionic liquids also appears to have an impact on the viscosity. For ionic liquids with the same anion(s) and compositions, the trend is for greater viscosity with larger cation size (Table 3.2-2). An additional contributing factor to the effect of the cation on viscosity is the asymmetry of the alkyl substitution. Highly asymmetric substitution has been identified as important for obtaining low viscosities [17].

The addition of co-solvents to ionic liquids can result in dramatic reductions in the viscosity without alteration of the cations or anions in the system. The haloaluminate ionic liquids present a challenge, due to the reactivity of the ionic liquid. Nonetheless, several compatible co-solvents including benzene, dichloromethane, and acetonitrile have been investigated [33–37]. The addition of as little as 5 wt. % acetonitrile or 15 wt. % benzene or methylene chloride was able to reduce the

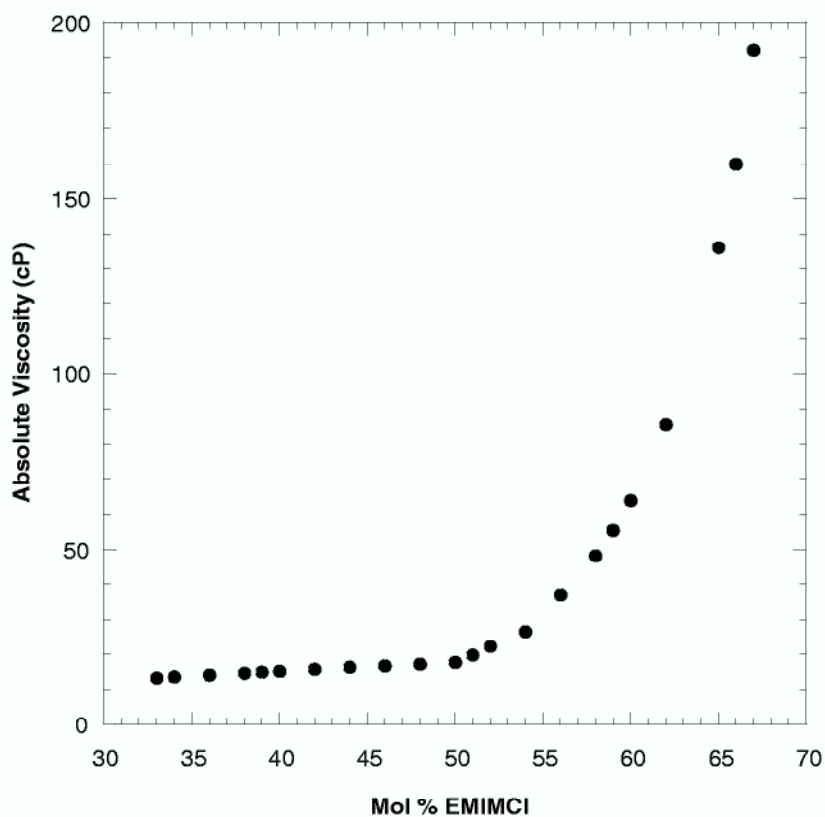

**Figure 3.2-2:** Change in the absolute viscosity (cP) as a function of the [EMIM]Cl mol % in an [EMIM]Cl/AlCl<sub>3</sub> ionic liquid at 303 K.

absolute viscosity by 50 % for [EMIM]Cl/AlCl<sub>3</sub> ionic liquids with less than 50 mol % AlCl<sub>3</sub> [33]. Non-haloaluminate ionic liquids have also been studied with a range of co-solvents including water, toluene, and acetonitrile. The ionic liquid response is similar to that observed in the haloaluminate ionic liquids. The addition of as little as 20 mol % co-solvent reduced the viscosity of a [BMIM][BF<sub>4</sub>] melt by 50 % [28].

### 3.2.2

#### Density of Ionic Liquids

Densities are perhaps the most straightforwardly determined and unambiguous physical property of ionic liquids. Given a quality analytical balance and good volumetric glassware the density of an ionic liquid can be measured gravimetrically (i.e., the sample can be weighed).

### 3.2.2.1 Density measurement

To measure density properly with a minimal amount of sample, a pycnometer should be employed. A pycnometer removes the ambiguity of measuring the bottom of the meniscus in a piece of glassware calibrated with aqueous solutions that have potentially very different surface tensions. The most common types of pycnometers are the Ostwald–Sprengel and the Weld or stopper pycnometer. These devices are generally constructed of glass and consist of a reservoir connected to a capillary or capillaries with fiducial marks. The pycnometer is weighed while empty, filled with the fluid of interest, and allowed to equilibrate thermally. The fluid above the fiducial marks is removed and the pycnometer is weighed [38, 39]. Pycnometers must be calibrated prior to use to determine the exact volume. The density is then calculated by dividing the mass of the fluid by the pycnometer volume.

### 3.2.2.2 Ionic liquid densities

The reported densities of ionic liquids vary between  $1.12 \text{ g cm}^{-3}$  for  $[(n\text{-C}_8\text{H}_{17})(\text{C}_4\text{H}_9)_3\text{N}][(\text{CF}_3\text{SO}_2)_2\text{N}]$  and  $2.4 \text{ g cm}^{-3}$  for a 34–66 mol%  $[(\text{CH}_3)_3\text{S}]\text{Br}/\text{AlBr}_3$  ionic liquid [21, 23]. The densities of ionic liquid appear to be the physical property least sensitive to variations in temperature. For example, a 5 degree change in temperature from 298 to 303 K results in only a 0.3 % decrease in the density for a 50.0:50.0 mol %  $[\text{EMIM}]\text{Cl}/\text{AlCl}_3$  [17]. In addition, the impact of impurities appears to be far less dramatic than in the case of viscosity. Recent work indicates that the densities of ionic liquids vary linearly with wt. % of impurities. For example, 20 wt. % water (75 mol %) in  $[\text{BMIM}][\text{BF}_4]$  results in only a 4 % decrease in density [33].

In the binary haloaluminate ionic liquids, an increase in the mole percent of the imidazolium salt decreases the density of the liquid (see Table 3.2-2). The bromoaluminate ionic liquids are substantially denser than their chloroaluminate counterparts, being between  $0.57 \text{ g cm}^{-3}$  and  $0.83 \text{ g cm}^{-3}$  denser than the analogous chloroaluminate ionic liquids (see Table 3.2-2). Variation of the substituents on the imidazolium cation in the chloroaluminate ionic liquids has been shown to affect the density on the basis of the cation size [17].

Within a series of non-haloaluminate ionic liquids containing the same cation species, increasing anion mass corresponds to increasing ionic liquid density (see Tables 3.2-1 and 3.2-3). Generally, the order of increasing density for ionic liquids composed of a single cation is:  $[\text{CH}_3\text{SO}_3]^- \approx [\text{BF}_4]^- < [\text{CF}_3\text{CO}_2]^- < [\text{CF}_3\text{SO}_3]^- < [\text{C}_3\text{F}_7\text{CO}_2]^- < [(\text{CF}_3\text{SO}_2)_2\text{N}]^-$ .

The densities of the non-haloaluminate ionic liquids are also affected by the identity of the organic cation. As in the haloaluminate ionic liquids, the density decreases as the size of the cation increases. In non-haloaluminate ionic liquids composed of substituted imidazolium cations and the triflate anion, for instance, the density decreases from  $1.390 \text{ g cm}^{-3}$  for  $[\text{EMIM}]^+$  to  $1.334 \text{ g cm}^{-3}$  for  $[\text{EMM}(5)\text{IM}]^+$ , to  $1.330 \text{ g cm}^{-3}$  for  $[\text{EEIM}]^+$ , to  $1.290 \text{ g cm}^{-3}$  for  $[\text{BMIM}]^+$ , and  $1.270 \text{ g cm}^{-3}$  for  $[\text{BEIM}]^+$  (see Table 3.2-3).



## References

- 1 J. R. Van Wazer, J. W. Lyons, K. Y. Kim, R. E. Colwell, *Viscosity and Flow Measurement: A Laboratory Handbook of Rheology*, Interscience Publishers-John Wiley, New York, 1963, chapters 2, 4, and 5.
- 2 G. E. Leblanc, R. A. Secco, M. Kostic, in *Mechanical Variables Measurement: Solid, Fluid, and Thermal* (J. G. Webster, ed.), CRC Press: Boca Raton, 2000, chapter 11.
- 3 Handbook of Chemistry and Physics, 82<sup>nd</sup> Edition, D. R. Linde, Ed., CRC Press, New York, 2001, pp. 6-182 – 6-186.
- 4 P. Bonhôte, A.-P. Dias, N. Papageorgiou, K. Kalyanasundaram, M. Grätzel, *Inorg. Chem.* 1996, 35, 1168.
- 5 T. E. Sutto, H. C. De Long, P. C. Trulove, in *Progress in Molten Salt Chemistry 1* (R. W. Berg, H. A. Hjuler, eds.), Elsevier: Paris, 2000, 511.
- 6 a. J. Fuller, R. T. Carlin, R. A. Osteryoung, *J. Electrochem. Soc.*, 1997 144, 3881. b. J. Fuller, R. A. Osteryoung, R. T. Carlin, *Abstracts of Papers, 187<sup>th</sup> Meeting of The Electrochemical Society*, Reno, NV, 1995, Vol. 95-1, p. 27.
- 7 a. A. Noda, K. Hayamizu, M. Watanabe, *J. Phys. Chem. B* 2001, 105, 4603; b. A. Noda, M. Watanabe, in *Proceedings of the Twelfth International Symposium on Molten Salts* (P. C. Trulove, H. C. De Long, G. R. Stafford, S. Deki, eds.), The Electrochemical Society: Pennington NJ, 2000, Vol. 99-41, pp. 202–208.
- 8 A. B. McEwen, H. L. Ngo, K. LeCompte, J. L. Goldman, *J. Electrochem. Soc.* 1999, 146, 1687.
- 9 A. Noda, M. Watanabe, *Electrochem. Acta* 2000, 45, 1265.
- 10 E. I. Cooper, E. J. M. O'Sullivan, in *Proceedings of the Eighth International Symposium on Molten Salts* (R. J. Gale, G. Blomgren, eds.), The Electrochemical Society: Pennington NJ, 2000, Vol. 92-16, pp. 386–396.
- 11 H. Every, A.G. Bishop, M. Forsyth, D. R. MacFarlane, *Electrochim. Acta* 2000, 45, 1279.
- 12 H. Matsumoto, M. Yanagida, K. Tanimoto, M. Nomura, Y. Kitagawa, Y. Miyazaki, *Chem. Lett.* 2000, 922.
- 13 S. Chun, S. V. Dzyuba, R. A. Bartsch, *Anal. Chem.* 2001, 73, 3737.
- 14 T. E. Sutto, H. C. De Long, P. C. Trulove, in *Progress in Molten Salt Chemistry 1* (R. W. Berg, H. A. Hjuler, eds.), Elsevier, Paris, 2000, 511.
- 15 J. Fuller, A. C. Breda, R. T. Carlin, *J. Electroanal. Chem.* 1998, 459, 29.
- 16 S. N. Baker, G. A. Baker, M. A. Kane, F. V. Bright, *J. Phys. Chem. B* 2001, 105, 9663.
- 17 a. J. S. Wilkes, J. A. Levisky, R. A. Wilson, C. L. Hussey, *Inorg. Chem.* 1982, 21, 1263. b. A. A. Fannin Jr., D. A. Floreani, L. A. King, J. S. Landers, B. J. Piersma, D. J. Stech, R. J. Vaughn, J. S. Wilkes, J. L. Williams, *J. Phys. Chem.* 1984, 88, 2614.
- 18 a. J. R. Sanders, E. H. Ward, C. L. Hussey, in *Proceedings of the Fifth International Symposium on Molten Salts* (M.-L. Saboungi, K. Johnson, D. S. Newman, D. Inman, Eds.), The Electrochemical Society: Pennington NJ 1986, Vol. 86-1, pp.307–316. b. J. R. Sanders, E. H. Ward, C. L. Hussey, *J. Electrochem. Soc.*, 1986, 133, 325.
- 19 R. A. Carpio, L. A. King, R. E. Lindstrom, J. C. Nardi, C. L. Hussey, *J. Electrochem. Soc.* 1979, 126, 1644.
- 20 V. R. Koch, L. L. Miller, R. A. Osteryoung, *J. Am. Chem. Soc.* 1976, 98, 5277.
- 21 M. Ma, K. E. Johnson, in *Proceedings of the Ninth International Symposium on Molten Salts* (C. L. Hussey, D. S. Newman, G. Mamantov, Y. Ito, eds.), The Electrochemical Society: Pennington NJ, 1994, Vol. 94-13, pp. 179–186.
- 22 E. I. Cooper, C. A. Angell, *Solid State Ionics* 1983, 9–10, 617.

- 23 a. J. Sun, M. Forsyth, D. R. MacFarlane, *Molten Salt Forum*, **1998**, 5–6, 585. b. J. Sun, M. Forsyth, D. R. MacFarlane, *J. Phys. Chem. B* **1998**, *102*, 8858.
- 24 D. R. MacFarlane, P. Meakin, J. Sun, N. Amini, M. Forsyth, *J. Phys. Chem. B* **1999**, *103*, 4164.
- 25 J. Caja, T. D. J. Dunstan, D. M. Ryan, V. Katovic, in *Proceedings of the Twelfth International Symposium on Molten Salts* (P. C. Trulove, H. C. De Long, G. R. Stafford, S. Deki, eds.), The Electrochemical Society: Pennington NJ, **2000**, Vol. 99-41, pp. 150–161.
- 26 S. D. Jones, G. E. Blomgren, in *Proceedings of the Seventh International Symposium on Molten Salts* (C. L. Hussey, S. N. Flengas, J. S. Wilkes, Y. Ito, eds.), The Electrochemical Society: Pennington NJ, **1990**, Vol. 90-17, pp. 273–280.
- 27 H. Matsumoto, T. Matsuda, Y. Miyazaki, *Chem. Lett.* **2000**, 1430.
- 28 K. R. Seddon, A. Stark, M.-J. Torres, *Pure Appl. Chem.* **2000**, *72*, 2275.
- 29 C. J. Dymek, D. A. Grossie, A. V. Fratini, W. W. Adams, *J. Mol. Struct.* **1989**, *213*, 25.
- 30 C. J. Dymek, J. J. Stewart, *Inorg. Chem.* **1989**, *28*, 1472.
- 31 A. G. Avent, P. A. Chaloner, M. P. Day, K. R. Seddon, T. Welton, in *Proceedings of the Seventh International Symposium on Molten Salts* (C. L. Hussey, J. S. Wilkes, S. N. Flengas, Y. Ito, eds.), The Electrochemical Society: Pennington NJ, **1990**, Vol. 90-17, pp. 98–133.
- 32 A. G. Avent, P. A. Chaloner, M. P. Day, K. R. Seddon, T. Welton, *J. Chem. Soc. Dalton Trans.* **1994**, 3405.
- 33 R. L. Perry, K. M. Jones, W. D. Scott, Q. Liao, C. L. Hussey, *J. Chem. Eng. Data* **1995**, *40*, 615.
- 34 Q. Liao, C. L. Hussey, *J. Chem. Eng. Data* **1996**, *41*, 1126.
- 35 N. Papageorgiou, Y. Athanassov, M. Armand, P. Bonhôte, H. Pattersson, A. Azam, M. Grätzel, *J. Electrochem. Soc.* **1996**, *143*, 3099.
- 36 R. Moy, R.-P. Emmenegger, *Electrochimica Acta* **1992**, *37*, 1061.
- 37 J. Robinson, R. C. Bugle, H. L. Chum, D. Koran, R. A. Osteryoung, *J. Am. Chem. Soc.* **1979**, *101*, 3776.
- 38 D. P. Shoemaker, C. W. Garland, J. I. Steinfeld, J. W. Nibler, *Experiments in Physical Chemistry*, 4<sup>th</sup> ed., McGraw-Hill: New York, **1981**, exp. 11.
- 39 H. Eren, in *Mechanical Variables Measurement: Solid, Fluid, and Thermal* (J. G. Webster, ed.), CRC Press: Boca Raton, **2000**, chapter 2.

### 3.3

#### Solubility and Solvation in Ionic Liquids

John D. Holbrey, Ann E. Visser, and Robin D. Rogers

##### 3.3.1

#### Introduction

Interest in using ionic liquid (IL) media as alternatives to traditional organic solvents in synthesis [1–4], in liquid/liquid separations from aqueous solutions [5–9], and as liquid electrolytes for electrochemical processes, including electrosynthesis, primarily focus on the unique combination of properties exhibited by ILs that differentiate them from molecular solvents.

ILs are considered to be polar solvents, but can be non-coordinating (mainly depending on the IL's anion). Solvatochromatic studies indicate that ILs have polarities similar to those of short-chain alcohols and other polar, aprotic solvents

(DMSO, DMF, etc.) [10–14]. That is, the polarity of many ILs is intermediate between water and chlorinated organic solvents and varies, depending on the nature of the IL components (for more details see Section 3.5).

By changing the nature of the ions present in an IL, it is possible to change the resulting properties of the IL. For example, the miscibility with water can be varied from complete miscibility to almost total immiscibility, by changing the anion from, for example,  $\text{Cl}^-$  to  $[\text{PF}_6]^-$ . Similarly, the lipophilicity of an IL is modified by the degree of cation substitution. Primary solvent features of ILs include the capability for H-bond donation from the cation to polar or dipolar solutes, H-bond accepting functionality in the anion (this is variable –  $\text{Cl}^-$  is a good H-bond acceptor, for example, whereas  $[\text{PF}_6]^-$  is poor), and  $\pi$ – $\pi$  or C–H... $\pi$  interactions (which enhance aromatic solubility) (for more details see Section 3.5). ILs tend to be immiscible with alkanes and other non-polar organic solvents and hence can be used in two-phase systems. Similarly, it is possible to design ILs that are hydrophobic and can be used in aqueous/IL biphasic systems.

The solubilities both of organic compounds and of metal salts in ILs are important with regard to stoichiometric chemical synthesis and catalytic processes. Not only must reagents and catalysts be sufficiently soluble in the solvent, but differential solubilities of reagents, products, and catalysts are required in order to enable effective separation and isolation of products. As well as requiring a knowledge of solute solubility in ILs, to assess the relative merits of a particular IL for chemical or separations processes, relative solubility and partitioning information about the preference of the solutes for IL phases relative to extractants is needed in order to design systems in which both reactions and extractions can be performed efficiently. However, only limited systematic data on these properties are available in the literature. In many cases, solutes and solvents are described as immiscible in a particular IL on the basis of the observation that two phases are formed, rather than compositional analysis to determine the limits of solubility or co-miscibility.

ILs have been investigated as alternatives to traditional organic solvents in liquid/liquid separations. Reports highlighting separations based on ILs [5, 15–18] for implementation into industrial separations systems demonstrate the design principles, and have identified hydrophobic ILs as replacements for VOCs in aqueous/IL biphasic separations schemes. Other work on novel solvent media has shown how  $sc\text{H}_2\text{O}$  [19, 20],  $sc\text{CO}_2$  [15], and fluorous phases [21] can be used in efforts to broaden the scope of possibilities available for more environmentally responsible processes. From the synthetic perspective, desirable features of an IL are: (i) catalyst solubility, enabling high catalyst capacity, immobilization to extraction processes, (ii) reagent solubility, ideally in high concentration, and (iii) product extractability.

Extractions and separations in two-phase systems require knowledge of the miscibilities and immiscibilities of ILs with other solvents compatible with the process. These are most usually IL/aqueous biphasic systems in which the IL is the less polar phase and organic/IL systems in which the IL is used as the polar phase. In these two-phase systems, extraction both to and from the IL phase is important.

## 3.3.2

**Metal Salt Solubility**

Transition metal catalysis in liquid/liquid biphasic systems principally requires sufficient solubility and immobilization of the catalysts in the IL phase relative to the extraction phase. Solubilization of metal ions in ILs can be separated into processes, involving the dissolution of simple metal salts (often through coordination with anions from the ionic liquid) and the dissolution of metal coordination complexes, in which the metal coordination sphere remains intact.

3.3.2.1 **Halometalate salts**

The formation of halometalate ionic liquids by the use of the equilibrium reactions of organic halide salts with metal halide compounds is well established and has been reviewed by Hussey [22]. A wide range of metalates have been prepared and investigated, primarily as liquid electrolytes for electrochemistry and battery applications, and for electroplating, electrowinning, and as Lewis acid catalysts for chemical synthesis. In particular, acidic tetrachloroaluminate(III) ILs have been used in place of solid  $\text{AlCl}_3$ , with the IL acting as a liquid catalyst and with product separation from the IL encouraged by differential solubility of the reagents and products.

Many simple metal compounds (ionic salts) are dissolved in 'basic' ionic liquids, containing coordinating Lewis base ligands, by complexation mechanisms; most metal halides can be dissolved in chloride-rich ILs as chloro-containing metalate species. This is the basis for the formation of chlorometalate ionic liquids, containing metal complex anions. Among the more novel recent examples of metal-containing ILs is the gold-containing  $[\text{EMIM}][\text{AuCl}_4]$  [23]. Seddon and Hussey have investigated the dissolution of many transition metals in halometalate ILs (see, for example, references [24–26]).

Metal halide compounds can be dissolved in basic tetrachloroaluminate ionic liquids, but can in many cases be precipitated from acidic ILs. For example, crystals of  $[\text{EMIM}]_2[\text{PdCl}_4]$  were obtained by dissolving  $\text{PdCl}_2$  in acidic  $[\text{EMIM}]\text{Cl}/\text{AlCl}_3$  IL [27]. This reflects changes in ligating ability of the predominant anions present in tetrachloroaluminate ILs on changing from the basic regime ( $\text{Cl}^-$ ) through to acidic ( $[\text{AlCl}_4]^-$ ). Simple metal salts can also be dissolved in other ionic liquids, containing coordinating anions such as nitrates.

3.3.2.2 **Metal complexes**

Examination of metal complex solubility in ILs has mainly stemmed from requirements for metal complex solubility for transition metal catalysis. The most effective method is through selective solubility and immobilization of the catalyst in the reacting phase, allowing product separation (with no catalyst leaching) into a second, extracting phase. In the context of emerging separations and extraction investigations and homogeneous catalysis, efficient recycling of metal catalysts is an absolute necessity. Systematic studies of metal complex solubility in ILs have yet to be reported and warrant investigation.

As a set of general observations:

- (i) Simple ionic *compounds* are generally poorly soluble in ILs.
- (ii) Ionic *complexes* are more soluble.
- (iii) Compounds are solubilized by complexation.
- (iv) The peripheral environments of the ligands are important in affecting solubility, and can be modified to provide better solubility.

Solubility depends on the nature of the IL and on solvation or complex formation. Most metal ions display preferential partitioning into water in IL aqueous systems and are hence less soluble in the IL than in water.

Simple metal compounds are poorly soluble in non-coordinating ILs, but the solubility of metal ions in an IL can be increased by addition of lipophilic ligands. However, enhancement of lipophilicity also increases the tendency for the metal complex to leach into less polar organic phases.

Ionic complexes tend to be more soluble than neutral complexes in ILs. Representative examples of transition metal salts and complexes that have been used as homogeneous catalysts in IL systems include  $[\text{LNiCH}_2\text{CH}_3][\text{AlCl}_4]$ , used in the Difa-sol olefin oligomerization process,  $[\text{Rh}(\text{nbd})(\text{PPh}_3)_2][\text{PF}_6]$  [28],  $[\text{Rh}(\text{cod})_2][\text{BF}_4]_2$  [29], and  $[\text{H}_4\text{Ru}(\pi^6\text{-C}_6\text{H}_6)_4][\text{BF}_4]_2$  [30] complexes, which have been described as catalysts for hydrogenation reactions. In catalytic hydrogenation studies, Chauvin has noted that neutral catalysts, such as  $\text{Rh}(\text{CO})_2(\text{acac})$ , are leached into the organic phase whereas charged species are maintained in the IL phase [31] (see Chapter 5.2 for more detail).

Precipitation of neutral complexes from solution, or extraction into a secondary phase, has enormous implications in the design of two-phase catalytic systems (to eliminate catalyst leaching) and in extractions (where selective extraction from either aqueous or organic phases is required, followed by controlled stripping of metals from the IL phase for recovery). Metal ion solubility in ILs can be increased by changing the complexing ligands present, for example by the use of soluble organic complexants such as crown ethers, or by modifying the ligands to increase solubility in the IL.

Chauvin showed that sulfonated triphenylphosphine ligands (e.g., *tppts* and *tpmps*) (iv) in Figure 3.3-1 prevented leaching of neutral Rh hydrogenation catalysts from ILs [28], although Cole-Hamilton and co-workers [32] have noted that the solubility of Rh-*tppts* complexes in ILs is low. Wasserscheid and co-workers [33] and Olivier-Bourbigou and co-workers [34] have demonstrated that addition of cationic functionality to the periphery of otherwise neutral ligands can be used to increase solubility and stability of metal complexes in the IL phase relative to leaching into an organic extractant phase ((i), (ii), (iv), and (v) in Figure 3.3-1). This approach mimics that taken to confer greater water solubility on metal complexes for aqueous-biphasic catalysis, and is equivalent to the TSIL approach of Davis, Rogers and co-workers [6] for enhanced metal transfer and binding in IL phases for extractions ((iii) in Figure 3.3-1).

ILs have also been used as inert additives to stabilize transition metal catalysts during evaporative workup of reactions in organic solvent systems [35,36]. The non-



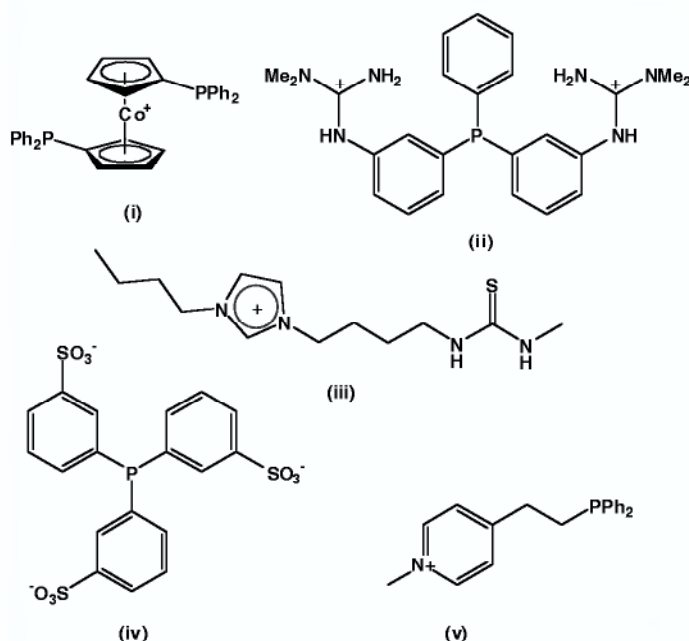

**Figure 3.3-1:** Incorporation of groups with high affinities for ILs (such as cobaltocenium (i), guanadinium (ii), sulfonate (iv), and pyridinium (v)) or even groups that are themselves ionic liquid moieties (such as imidazolium (iii)) as peripheral functionalities on coordinating ligands increases the solubility of transition metal complexes in ILs.

volatile IL component solubilizes the catalyst upon concentration and removal of organic solvent and products, thereby preventing catalyst decomposition and enabling catalysts to be recycled and reused in batch processes.

### 3.3.3

#### Extraction and Separations

Studies of extractions and separations provide information on the relative solubilities of solutes between two phases, such as partitioning data, required in order to design systems in which a solute is either selectively extracted from, or immobilized in one phase. Liquid/liquid separation studies of metal ions are principally concerned with aqueous/organic two-phase systems, with relevance for extraction and concentration of metal ions in the organic phase. In terms of IL/aqueous partitioning, there is considerable interest in the replacement of organic extracting phases with ILs for recovery of metals from waste water in mining, in nuclear fuel and waste reprocessing, and in immobilization of transition metal catalysts. The hydrated natures of most metal ions lower their affinity for the less-polar extracting phases; this is the case in IL systems, where hydrated metal ions do not partition into the IL from water, except for the most hydrophobic cations [8]. The affinity of metal



ions for less polar phases can be enhanced by changing the hydration environments of the metal ions either by using organic ligands [37–39], which provide more hydrophobic regions around the metal, or with inorganic anions [40] that form softer, more extractable anionic complexes with the metal.

Ideally, to ensure the complete removal of the metal ions from the aqueous phase, the complexant and the metal complex should remain in the hydrophobic phase. Thus, the challenges for separations include the identification of extractants that quantitatively partition into the IL phase and can still readily complex target metal ions, and also the identification of conditions under which specific metal ion species can be selectively extracted from aqueous streams containing inorganic complexing ions.

#### 3.3.3.1 Anionic extractants

Most hydrated metal ions are more soluble in water than in ILs. The distribution ratios of some metal ions between aqueous and IL phases may be enhanced in the presence of coordinating anions, such as halides or pseudohalides, capable of modifying the metal complex hydrophobicity, increasing partitioning from water [41]. The effect of halide, cyanate, cyanide, and thiocyanate ions on the partitioning of  $\text{Hg}^{2+}$  in  $[\text{BMIM}][\text{PF}_6]$ /aqueous systems (Figure 3.3-2) has been studied [8]. The results indicate that the metal ion transfer to the IL phase depends on the relative hydrophobicity of the metal complex.  $\text{Hg-I}$  complexes have the highest formation constants, decreasing to those of  $\text{Hg-F}$  [42]. Results from pseudohalides, however, suggest a more complex partitioning mechanism, since  $\text{Hg-CN}$  complexes have even higher formation constants [42], but display the lowest distribution ratios.

#### 3.3.3.2 Organic extractants

Macrocyclic ligands such as crown ethers have been widely used for metal ion extraction, the basis for metal ion selectivity being the structure and cavity size of the crown ether. The hydrophobicity of the ligand can be adjusted by attachment of alkyl or aromatic ligands to the crown. Impressive results have been obtained with dicyclohexano-18-crown-6 as an extractant for  $\text{Sr}^{2+}$  in  $[\text{RMIM}][(\text{CF}_3\text{SO}_2)_2\text{N}]$  IL/aqueous

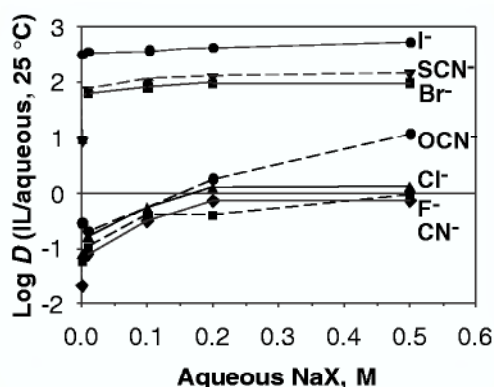
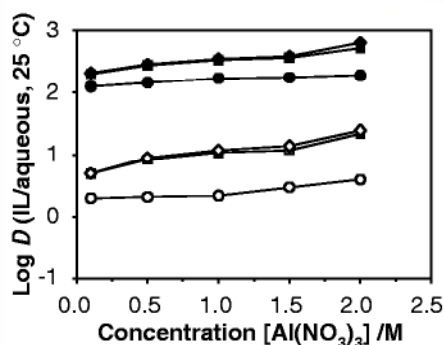

Figure 3.3-2:  $\text{Hg}^{2+}$  distribution ratios with increasing aqueous halide concentrations in  $[\text{BMIM}][\text{PF}_6]$ /aqueous systems. From reference [8].



**Figure 3.3-3:** Distribution ratios for  $\text{Sr}^{2+}$  (closed symbol) and  $\text{Cs}^{+}$  (open symbol) with dibenzo-18-crown-6 (0.1 M) as extractant in IL/aqueous systems ( $[\text{BMIM}][\text{PF}_6]$  (●),  $[\text{HMIM}][\text{PF}_6]$  (■),  $[\text{OMIM}][\text{PF}_6]$  (◆)) as a function of increasing aqueous phase concentrations of  $[\text{Al}(\text{NO}_3)_3]$  (M). From reference [7].

ous systems [17] and with 18-crown-6, dicyclohexano-18-crown-6, and 4,4'-(5')-bis-(*tert*-butylcyclohexano)-18-crown-6 in  $[\text{RMIM}][\text{PF}_6]$ /aqueous systems as extractants for  $\text{Sr}^{2+}$ ,  $\text{Cs}^{+}$ , and  $\text{Na}^{+}$  (Figure 3.3-3) [7]. Metal ion extraction into the IL is greatest at high anion concentration in the aqueous phase, but decreases with increasing acid concentration, in contrast to typical solvent extraction, where the higher distribution ratios are obtained with increasing acid concentrations. Results indicate that metal ion partitioning is very complex in IL-based liquid/liquid systems, and that other factors such as aqueous phase composition and water content of the IL have a dramatic effect on the metal ion extraction and the stability of the IL.

Organic extractants can be used to complex metal ions and to increase lipophilicity. The traditional metal extractants 1-(2-pyridylazo)naphthol (PAN) and 1-(2-thiazolyl)-2-naphthol (TAN) have been used in polymer-based aqueous biphasic systems [43] and traditional solvent extraction systems [44]. These are conventional metal extractants widely used in solvent extraction applications. When the aqueous phase is basic, both molecules are ionized, yet they quantitatively partition into  $[\text{HMIM}][\text{PF}_6]$  over the pH range 1–13. The distribution ratios for  $\text{Fe}^{3+}$ ,  $\text{Co}^{2+}$ , and  $\text{Cd}^{2+}$  (Figure 3.3-4) show that the coordinating and complexing abilities of the extractants are dependent on pH and that metal ions can be extracted from the

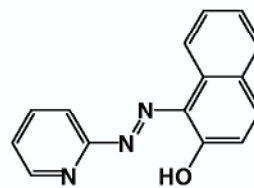
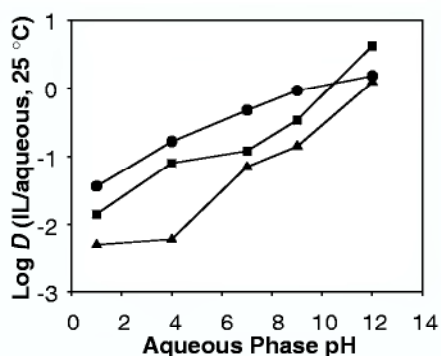

**Figure 3.3-4:** Metal ion distribution ratios for  $\text{Fe}^{3+}$  (●),  $\text{Cd}^{2+}$  (▲), and  $\text{Co}^{2+}$  (■) with 0.1 mM PAN in  $[\text{HMIM}][\text{PF}_6]$ /aqueous systems as a function of aqueous phase pH. From reference [8].

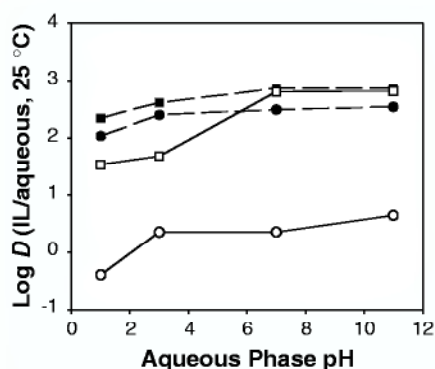
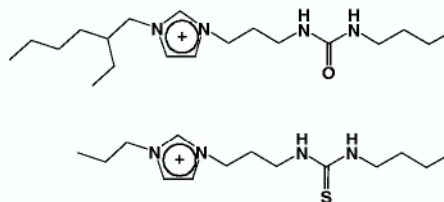

Figure 3.3-5:  $\text{Hg}^{2+}$  (■) and  $\text{Cd}^{2+}$  (○) distribution ratios between IL and aqueous phase with 1:1 [BMIM][PF<sub>6</sub>] and urea-appended (dashed lines) or thiourea-appended (solid lines) TSILs as the extracting phase.



aqueous phase at basic pH and stripped from the IL under acidic conditions, as is the case when more conventional organic extracting phases are utilized.

Davis first introduced the term Task-specific Ionic Liquid (TSIL) to describe ILs prepared using the concept of increasing the IL affinity of the extractants through incorporation of the complexing functionality as an integral part of the IL [9]. It is thus possible to prepare ILs with built in extracting capability, and to achieve differentiation from both aqueous and organic phases through modification of the IL co-miscibility. These TSILs can be used as IL extracting phases, or may be mixed with a second, more conventional IL to modify rheological properties. Metal ion-ligating groups are incorporated into the cationic moiety of the IL by tethering to the imidazolium cation; thioether, urea, and thiourea-derivatized imidazolium ILs have been investigated as  $\text{Hg}^{2+}$  and  $\text{Cd}^{2+}$  extractants (see Figure 3.3-5) [9]. The distribution ratios are typically higher for  $\text{Hg}^{2+}$  and a change in the aqueous phase pH has only a slight effect on the partitioning.

In liquid/liquid systems that use ILs as alternatives to organic solvents, the tendency for metal ions to remain in the aqueous phase can be offset by the presence in the system either of organic or inorganic extractants or of TSILs. These extractants serve to modify the hydration environment of metal ions through complexation with ligating functional groups, increasing metal ion partitioning to the IL phase. In the design of an IL, fine-tuning of the properties can be achieved by changing the cation substituent groups and/or anion identity, or by mixing two types of IL with differing, but defined characteristics.

#### 3.3.4

##### Organic Compounds

In general, ILs behave as moderately polar organic solvents with respect to organic solutes. Unlike the organic solvents to which they are commonly compared, however, they are poorly solvating and are rarely found as solvates in crystal structures.

Armstrong and co-workers [45] have investigated the interactions of solutes with ILs by using the ILs as stationary phases for gas-liquid chromatography (GLC), and have shown that ILs appear to act as low-polarity phases in their interactions with non-polar compounds and that the solubility increases with increasing lipophilicity (alkyl chain length etc.). However, polar molecules or those containing strong proton donor functionality (such as phenols, carboxylic acids, diols) also interact strongly with ILs. Compounds with weak proton donor/acceptor functions (such as aromatic and aliphatic ketones, aldehydes, and esters) appear to interact with the ionic liquids through induced ion dipole, or weak van der Waals interactions.

Bonhôte and co-workers [10] reported that ILs containing triflate, perfluorocarboxylate, and bistriflylimide anions were miscible with liquids of medium to high dielectric constant ( $\epsilon$ ), including short-chain alcohols, ketones, dichloromethane, and THF, while being immiscible with low dielectric constant materials such as alkanes, dioxane, toluene, and diethyl ether. It was noted that ethyl acetate ( $\epsilon = 6.04$ ) is miscible with the 'less-polar' bistriflylimide and triflate ILs, and only partially miscible with more polar ILs containing carboxylate anions. Brennecke [15] has described miscibility measurements for a series of organic solvents with ILs with complementary results based on bulk properties.

We have shown that ILs in general display partitioning properties similar to those of dipolar aprotic solvents or short chain alcohols. The relationship between octanol/water partitioning and IL/water partitioning [46] (Figure 3.3-6), despite the clear polarity differences between the solvents, allows the solubility or partitioning of organic solutes with ILs to be predicted from the relative polarities of the materials (by use of solvatochromatic scales etc.). Complex organic molecules such as cyclodextrins, glycolipids [45], and antibiotics [16] can be dissolved in ILs; the solubility of these complex molecules increases in the more polar ILs. The interactions are greatest when the ILs have H-bond acceptor capability (chloride-containing ILs, for example). The miscibility of ILs with water varies with cation substitution and with anion types; coordinating anions generally produce water-soluble ILs, whereas the presence of large, non-coordinating, charge-diffuse anions generates hydrophobic ILs.

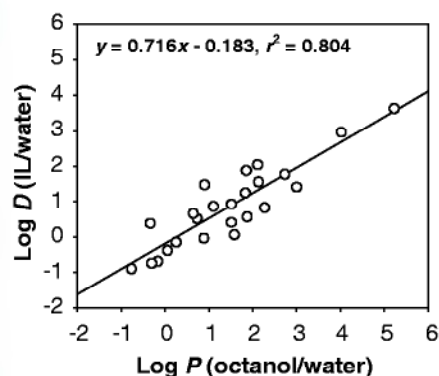

**Figure 3.3-6:** The distribution ratios between [BMIM][PF<sub>6</sub>] and water (neutral pH) for organic solutes correlate with literature partition functions of the solutes between octanol and water ( $\log P$ ).

From empirical observation, ILs tend to be immiscible with non-polar solvents. They can therefore be washed or brought into contact with diethyl ether or hexane to extract non-polar reaction products. Among solvents of greater polarity, esters (ethyl acetate, for example) exhibit variable solubility with ILs, depending on the nature of the IL. Polar or dipolar solvents (including chloroform, acetonitrile, and methanol) appear to be totally miscible with all ILs (excepting tetrachloroaluminate IL and the like, which react). Among notable exceptions, [EMIM]Cl and [BMIM]Cl are insoluble in dry acetone.

Although hydrocarbons are poorly soluble in most ILs, they are not insoluble. The relative solubility of short-chain hydrocarbons over oligomers and polymers is the basis for the efficient separation of products described for alkylation, oligomerization, and hydrogenation reactions using IL catalyst systems. The lipophilicity of the IL and the solubility of non-polar solutes can be increased by adding additional non-polar alkyl-functionality to the IL, thus reducing further Coulombic ion-ion interactions. Alkanes, for example, are essentially insoluble in all ILs, while the solubility of linear alkenes [34] is low, but increases with increased alkyl chain substitution in the IL cations and with delocalization of charge in the anion. Aromatic compounds are more soluble in ILs: benzene can be dissolved in [EMIM]Cl/ $\text{AlCl}_3$ , [BMIM][PF<sub>6</sub>], and [EMIM]((CF<sub>3</sub>SO<sub>2</sub>)<sub>2</sub>N) at up to ca. 1:1 ratios, reflecting the importance of CH... $\pi$  and  $\pi$ - $\pi$  stacking interactions and formation of liquid clathrate structures. Similarly, [BMIM][PF<sub>6</sub>], [EMIM][BF<sub>4</sub>], and [BMIM][PF<sub>6</sub>] form liquid clathrates in chloroform, readily observable by <sup>1</sup>H NMR spectroscopy.

We have recently shown that the hydrophobic hexafluorophosphate ILs can in fact be made totally miscible with water by addition of alcohols [47, 48]; the ternary phase diagram for [BMIM][PF<sub>6</sub>]/water/ethanol (left part of Figure 3.3-7) shows the

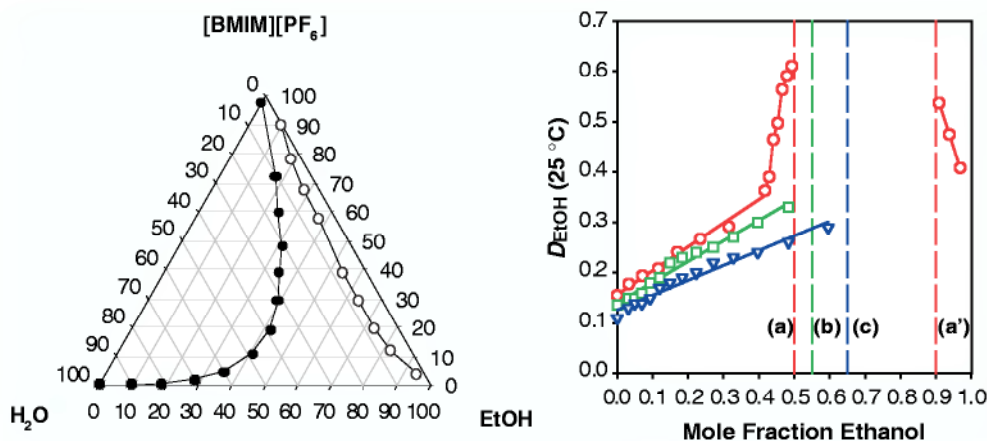

Figure 3.3-7: Ethanol/water/[BMIM][PF<sub>6</sub>] ternary phase diagram (a, left) and solute distribution in EtOH/water/IL mixtures (b, right) for [BMIM][PF<sub>6</sub>] (○), [HMIM][PF<sub>6</sub>] (□), and [OMIM][PF<sub>6</sub>] (▽) as a function of initial mole fraction of ethanol in the aqueous phase, measured at 25 °C. From references [47, 48].

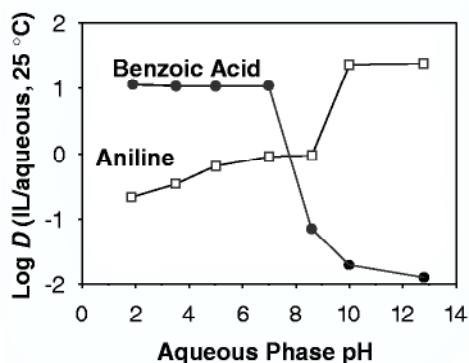

Figure 3.3-8: Distribution ratios for aniline ( $pK_b = 9.42$ ) and benzoic acid ( $pK_a = 4.19$ ) in [BMIM][PF<sub>6</sub>]/aqueous systems as a function of the pH of the aqueous phase.

large co-miscibility region of the three components. In fact, ethanol forms biphasic mixtures with [BMIM][PF<sub>6</sub>], [HMIM][PF<sub>6</sub>], and [OMIM][PF<sub>6</sub>], the degree of miscibility depending on temperature and on the water composition of the mixtures (right part of Figure 7). In each case, increasing the water content of the IL increases ethanol solubility. This process has many potential uses for washing and removal of ionic liquids from products and reactors or catalyst supports and has important implications in the design of IL/aqueous two-phase extraction systems.

With charged or ionizable solutes, changes in the pH of the aqueous phase resulted in certain ionizable solutes exhibiting pH-dependent partitioning such that their affinity for the IL decreased upon ionization [6]. Solute ionization effects, as demonstrated for aniline and benzoic acid (Figure 3.3-8), can modify solubility and partitioning of solutes into an IL by several orders of magnitude difference in the partitioning.

The pH-dependent partitioning of the ionizable, cationic dye thymol blue has also been investigated [6]. In its neutral, zwitterionic, and monoanionic forms, the dye preferentially partitions into the IL phase (from acidic solution), the partition coefficient to the IL increasing with increasing IL hydrophobicity. Under basic conditions, the dye is in the dianionic form and partitions into water (Figure 3.3-9).

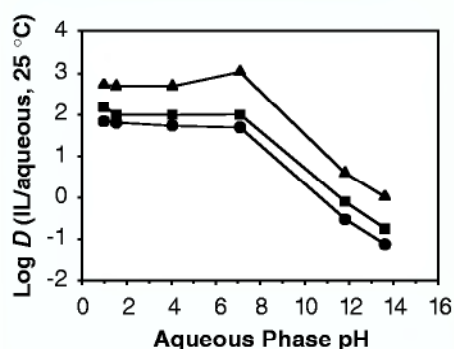

Figure 3.3-9: pH-switchable partitioning of the ionic dye thymol blue in [BMIM][PF<sub>6</sub>] (●), [HMIM][PF<sub>6</sub>] (■), [OMIM][PF<sub>6</sub>] (▲)/aqueous biphasic systems. From reference [6].



Partitioning and solubility of specific organic compounds in ILs depends on the solubilizing interactions between the solute and IL components. As observed, ionized or polar compounds have high affinities for IL phases. It has been recognized that aromatic compounds have relatively high solubilities in ILs, even benzene being soluble to high concentrations in a wide range of ILs, presumably through C-H... $\pi$  and  $\pi$ - $\pi$  aromatic interactions with the IL cations. Atwood has shown that the high solubility of aromatics can be attributed to clathrate formation [49] and has described model extractions of toluene from toluene/heptane mixtures with [EMIM][I<sub>3</sub>] and [BMIM][I<sub>3</sub>] [50].

ILs containing 1-alkylisoquinolinium cations combined with the bis(perfluoroethylsulfonyl)imide anion ( $[\text{N}(\text{SO}_2\text{CF}_2\text{CF}_3)_2]^-$ , [BETI]<sup>-</sup>) have been reported [51] and tested for organic partitioning in aqueous/IL two-phase systems. The large, extended aromatic cores in the cations of these ILs were expected to exhibit greater affinities for aromatic solutes in IL/aqueous partitioning experiments, and it was found, in particular, that the distribution ratio for 1,2,4-trichlorobenzene in [C<sub>14</sub>isoq][BETI] was much greater than that in [BMIM][PF<sub>6</sub>] [5, 46]. It is not yet clear whether interactions of aromatic solutes with the extended aromatic region of the isoquinolinium cations or increased lipophilicity factors were responsible for the increased aromatic partitioning.

### 3.3.5

#### Conclusions

Ionic liquids are similar to dipolar, aprotic solvents and short-chain alcohols in their solvent characteristics. These vary with anion (from very 'ionic' Cl<sup>-</sup> to more 'covalent' [BETI]<sup>-</sup>). ILs become more lipophilic with increasing alkyl substitution, resulting in increasing solubility of hydrocarbons and non-polar organics.

For separations, challenges lie in reconciling the partitioning results with those from more traditional systems. Continued study of organic solute behavior in IL-based liquid/liquid separations may facilitate a molecular level understanding of the partitioning mechanisms for neutral and ionic solutes, ultimately providing a predictive tool for their behavior. Exploration of the driving forces for organic solute partitioning should contribute to the understanding of metal ion extractants and partitioning mechanisms in IL systems. Incorporation of new concepts such as task-specific ionic liquids for separations should broaden both understanding and applicability.

## References

- 1 R. Sheldon, *Chem. Commun.* **2001**, 2399.
- 2 W. Keim, P. Wasserscheid, *Angew. Chem. Int. Ed.* **2000**, *39*, 3772.
- 3 T. Welton, *Chem. Rev.* **1999**, *99*, 2071.
- 4 J. D. Holbrey, K. R. Seddon, *Clean Prod. Proc.* **1999**, *1*, 233.
- 5 J. G. Huddleston, A. E. Visser, W. M. Reichert, H. D. Willauer, G. A. Broker, R. D. Rogers, *Green Chem.* **2001**, *3*, 156.
- 6 A. E. Visser, R. P. Swatloski, R. D. Rogers, *Green Chem.* **2000**, *2*, 1.
- 7 A. E. Visser, R. P. Swatloski, W. M. Reichert, S. T. Griffin, R. D. Rogers, *Ind. Eng. Chem. Res.* **2000**, *39*, 3596.
- 8 A. E. Visser, R. P. Swatloski, S. T. Griffin, D. H. Hartman, R. D. Rogers, *Sep. Sci. Technol.* **2001**, *36*, 785.
- 9 A. E. Visser, R. P. Swatloski, W. M. Reichert, R. D. Rogers, R. Mayton, S. Sheff, A. Wierzbicki, J. H. Davis, Jr., *Chem. Commun.* **2001**, 135.
- 10 P. Bonhôte, A.-P. Dias, N. Papageorgiou, K. Kalyanasundaram, M. Grätzel, *Inorg. Chem.* **1996**, *35*, 1168.
- 11 A. J. Carmichael, K. R. Seddon, *J. Phys. Org. Chem.* **2000**, *13*, 591.
- 12 M. J. Muldoon, C. M. Gordon, I. R. Dunkin, *J. Chem. Soc., Perkin Trans. 2* **2001**, 433.
- 13 S. N. V. K. Aki, J. F. Brennecke, A. Samanta, *Chem. Commun.* **2001**, 413.
- 14 D. Behar, C. Gonzalez, P. Neta, *J. Phys. Chem. A* **2001**, *105*, 7607.
- 15 L. A. Blanchard, J. F. Brennecke, *Ind. Eng. Chem. Res.* **2001**, *40*, 287.
- 16 S. G. Cull, J. D. Holbrey, V. Vargas-Mora, K. R. Seddon, G. J. Lyc, *Biotech. Bioeng.* **2000**, *69*, 227.
- 17 S. Dai, Y. H. Ju, C. E. Barnes, *J. Chem. Soc. Dalton Trans.* **1999**, 1201.
- 18 W. R. Pittner, D. W. Rooney, K. R. Seddon, R. C. Thied, *WO 99/41752*, **2000**.
- 19 Z. Fang, S. Xu, J. A. Kozinski, *Ind. Eng. Chem. Res.*, **2000**, *39*, 4536.
- 20 M. Sasaki, Z. Fang, Y. Fukuskima, T. Adschiri, K. Arai, *Ind. Eng. Chem. Res.* **2000**, *39*, 2883.
- 21 C. Ohrenberg, W. E. Geiger, *Inorg. Chem.* **2000**, *39*, 2948.
- 22 C. L. Hussey, *Pure Appl. Chem.* **1988**, *60*, 1763.
- 23 M. Hasan, I. V. Kozhevnikov, M. R. H. Siddiqui, A. Steiner, N. Winterton, *Inorg. Chem.*, **1999**, *38*, 5637.
- 24 D. Appleby, P. B. Hitchcock, K. R. Seddon, J. E. Turp, J. A. Zora, C. L. Hussey, J. R. Sanders, T. A. Ryan, *J. Chem. Soc., Dalton Trans.* **1990**, *6*, 1879.
- 25 D. Appleby, R. I. Crisp, P. B. Hitchcock, C. L. Hussey, T. A. Ryan, J. R. Sanders, K. R. Seddon, J. E. Turp, J. A. Zora, *J. Chem. Soc., Chem. Commun.* **1986**, 483.
- 26 D. Appleby, C. L. Hussey, K. R. Seddon, J. E. Turp, *Nature* **1986**, *323*, 614.
- 27 M. Ortwerth, M. J. Wyzlic, R. Baughman, *Acta. Crystallogr.* **1998**, *C54*, 1594.
- 28 Y. Chauvin, L. Mussmann, H. Olivier, *Angew. Chem. Int. Ed.* **1996**, *34*, 2698.
- 29 S. Einloft, F. K. Dietrich, R. F. Desouza, J. Dupont, *Polyhedron* **1996**, *15*, 3257.
- 30 P. J. Dyson, D. J. Ellis, D. G. Parker, T. Welton, *Chem. Commun.* **1996**, 25.
- 31 Y. Chauvin, H. Olivier-Bourbigou, *CHEMTECH* **1995**, *25*, 26.
- 32 M. F. Sellin, P. B. Webb, D. J. Cole-Hamilton, *Chem. Commun.* **2000**, 781.
- 33 P. Wasserscheid, H. Waffenschmidt, P. Machnitzki, K. W. Kottseiper, O. Stetzler, *Chem. Commun.* **2001**, 451.
- 34 F. Favre, H. Olivier-Bourbigou, D. Commercuc, L. Saussine, *Chem. Commun.* **2001**, 1360.
- 35 S. V. Ley, C. Ramarao, M. D. Smith, *Chem. Commun.* **2001**, 2278.
- 36 C. E. Song, E. J. Roh, *Chem. Commun.* **2000**, 837.
- 37 E. P. Horwitz, A. C. Muscatello, D. G. Kalina, L. Kaplan, *Sep. Sci. Technol.* **1981**, *16*, 1127.
- 38 E. P. Horwitz, K. A. Martin, H. Diamond, L. Kaplan, *Solv. Extr. Ion Exch.* **1986**, *4*, 449.
- 39 R. A. Sachleben, Y. Deng, D. R. Bailey, B. A. Moyer, *Solv. Extr. Ion Exch.*, **1997**, *14*, 995.

- 40 B. A. Moyer, P. V. Bonnesen, in *Physical Factors in Anion Separations* (A. Bianchi, K. Bowman-James, K. Garcia-Espana eds.), Wiley, New York, 1997, 1–38.
- 41 R. D. Rogers and S. T. Griffin, *J. Chrom. B* 1998, 711, 277.
- 42 NIST Database 46: Critically Selected Stability Constants of Metal Complexes Database, U.S. Department of Commerce, Gaithersburg, MD, 1998, ver. 5.0.
- 43 A. E. Visser, S. T. Griffin, D. H. Hartman, R. D. Rogers, *J. Chromatogr. B* 2000, 743, 107.
- 44 J. Gao, G. Hu, J. Kang, G. Bai, *Talanta* 1993, 40, 195.
- 45 D. W. Armstrong, L. He, Y. S. Lui, *Anal. Chem.* 1999, 71, 3873.
- 46 J. G. Huddleston, H. D. Willauer, R. P. Swatloski, A. E. Visser, R. D. Rogers, *Chem. Commun.* 1998, 1765.
- 47 R. P. Swatloski, A. E. Visser, W. M. Reichert, G. A. Broker, L. M. Farina, J. D. Holbrey, R. D. Rogers, *Chem. Commun.* 2001, 2070.
- 48 R. P. Swatloski, A. E. Visser, W. M. Reichert, G. A. Broker, L. M. Farina, J. D. Holbrey, R. D. Rogers, *Green Chem.* 2002, 4, 81.
- 49 J. L. Atwood, 'Liquid Clathrates', in *Inclusion Compounds* (J. L. Atwood, J. E. D. Davies, D. D. MacNicol eds.), Academic Press: London, 1984, Vol. 1.
- 50 M. S. Selvan, M. D. McKinley, R. H. Dubois, J. L. Atwood, *J. Chem. Eng. Data.* 2000, 45, 841.
- 51 A. E. Visser, J. D. Holbrey, R. D. Rogers, *Chem. Commun.* 2001, 2484.

### 3.4

#### Gas Solubilities in Ionic Liquids

Joan F. Brennecke, Jennifer L. Anthony, and Edward J. Maginn

##### 3.4.1

#### Introduction

A wide variety of physical properties are important in the evaluation of ionic liquids (ILs) for potential use in industrial processes. These include pure component properties such as density, isothermal compressibility, volume expansivity, viscosity, heat capacity, and thermal conductivity. However, a wide variety of *mixture* properties are also important, the most vital of these being the phase behavior of ionic liquids with other compounds. Knowledge of the phase behavior of ionic liquids with gases, liquids, and solids is necessary to assess the feasibility of their use for reactions, separations, and materials processing. Even from the limited data currently available, it is clear that the cation, the substituents on the cation, and the anion can be chosen to enhance or suppress the solubility of ionic liquids in other compounds and the solubility of other compounds in the ionic liquids. For instance, an increase in alkyl chain length decreases the mutual solubility with water, but some anions ( $[\text{BF}_4]^-$ , for example) can increase mutual solubility with water (compared to  $[\text{PF}_6]^-$ , for instance) [1–3]. While many mixture properties and many types of phase behavior are important, we focus here on the solubility of gases in room temperature ILs.

A primary motivation for understanding gas solubilities in ILs is to be found in the many successful demonstrations of the use of ILs as solvents for reactions [4–6]. Some of these reactions, such as hydrogenations, oxidations, and hydroformylations, involve treatment of substrates in the ionic liquid solution with permanent and condensable gases. If a gas has limited solubility in the IL, then significant efforts will have to be made to increase interfacial area and enhance mass transfer, and/or high-pressure operation will be required. This may limit the ability of ILs to compete with conventional solvents, unless there are other significant chemical processing advantages to the IL. Conversely, high solubility or selective solubility of the desired gases might make ILs quite attractive.

A second motivation for understanding gas solubilities in ILs is the possibility of using ILs to separate gases. Because they are not volatile [7, 8] and would not contaminate the gas stream in even small amounts, ILs have an automatic advantage over conventional absorption solvents for the performance of gas separations. In addition, their high thermal stabilities mean that they could be used to perform gas separations at higher temperatures than is possible with conventional absorption solvents. Whether used in a conventional absorber arrangement or as a supported liquid membrane, the important physical properties for this application (besides low volatility) are the solubility and diffusivity of the gases of interest in the ILs.

A third motivation for studying gas solubilities in ILs is the potential to use compressed gases or supercritical fluids to separate species from an IL mixture. As an example, we have shown that it is possible to recover a wide variety of solutes from ILs by supercritical CO<sub>2</sub> extraction [9]. An advantage of this technology is that the solutes can be removed quantitatively without any cross-contamination of the CO<sub>2</sub> with the IL. Such separations should be possible with a wide variety of other compressed gases, such as C<sub>2</sub>H<sub>6</sub>, C<sub>2</sub>H<sub>4</sub>, and SF<sub>6</sub>. Clearly, the phase behavior of the gas in question with the IL is important for this application.

Finally, a fourth motivation for exploring gas solubilities in ILs is that they can act as probes of the molecular interactions with the ILs. Information can be discerned on the importance of specific chemical interactions such as hydrogen bonding, as well as dipole–dipole, dipole–induced dipole, and dispersion forces. Of course, this information can be determined from the solubility of a series of carefully chosen liquids, as well. However, gases tend to be of the smallest size, and therefore the simplest molecules with which to probe molecular interactions.

In this section, we first discuss various experimental techniques that can be used to measure gas solubilities and related thermodynamic properties in ILs. We then describe the somewhat limited data currently available on gas solubilities in ILs. Finally, we discuss the impact that gas solubilities in ILs have on the applications described above (reactions, gas separations, separation of solutes from ILs) and draw some conclusions.

## 3.4.2

**Experimental Techniques**

In this section we describe some of the various experimental techniques that can be used to measure gas solubilities and related thermodynamic properties.

**3.4.2.1 Gas solubilities and related thermodynamic properties**

In general, gas solubilities are measured at constant temperature as a function of pressure. Permanent gases (gases with critical temperatures below room temperature) will not condense to form an additional liquid phase no matter how high the applied pressure. However, condensable gases (those with critical temperatures above room temperature) will condense to form a liquid phase when the vapor pressure is reached. The solubilities of many gases in normal liquids are quite low and can be adequately described at ambient pressure or below by Henry's law. The Henry's law constant is defined as

$$H_1(T, P) \equiv \lim_{x_1 \rightarrow 0} \frac{f_1^L}{x_1} \quad (3.4-1)$$

where  $x_1$  is the mole fraction of gas in the liquid and  $f_1^L$  the fugacity of the gas (species 1) in the liquid phase. If the gas phase behaves ideally (i.e., the fugacity coefficient is close to 1), then the fugacity is equal to the pressure of gas above the IL sample. This is because there is essentially no IL in the vapor phase, due to its nonvolatility. Experimentally, the Henry's law constant can be determined from the limiting slope of the solubility as a function of pressure. A large Henry's law constant indicates a low gas solubility, and a small Henry's law constant indicates a high gas solubility. One might also choose to express the limiting gas solubility (especially for condensable gases) in terms of an infinite dilution activity coefficient, where the standard state is pure condensed liquid at the temperature of the experiment ( $P_1^{sat}$ ). In this case, the infinite dilution activity coefficient,  $\gamma_1^\infty$  can be related to the Henry's law constant simply by  $\gamma_1^\infty = H_1(T, P)P_1^{sat}(T)$

Also of importance is the effect of temperature on the gas solubility. From this information it is possible to determine the enthalpy and entropy change experienced by the gas when it changes from the ideal gas state ( $h_1^{ig}$  and  $s_1^{ig}$ ) to the mixed liquid state ( $\bar{h}_1$  and  $\bar{s}_1$ ).

$$\Delta h_1 = \bar{h}_1 - h_1^{ig} = R \left( \frac{\partial \ln P}{\partial (1/T)} \right)_{x_1} \quad (3.4-2)$$

$$\Delta s_1 = \bar{s}_1 - s_1^{ig} = -R \left( \frac{\partial \ln P}{\partial \ln T} \right)_{x_1} \quad (3.4-3)$$

Thus,  $\Delta h_1$  and  $\Delta s_1$  can be obtained by determining the pressure required to achieve a specified solubility at several different temperatures and constant composition,  $x_1$ . In the Henry's law region,  $\Delta h_1$  and  $\Delta s_1$  can be found directly from the temperature



dependence of the Henry's law constant, as given by the familiar van't Hoff equations:

$$\Delta h_1 = R \left( \frac{\partial \ln H_1}{\partial (1/T)} \right)_p \quad (3.4-4)$$

$$\Delta s_1 = -R \left( \frac{\partial \ln H_1}{\partial \ln T} \right)_p \quad (3.4-5)$$

The enthalpy and entropy of gas dissolution in the IL provide information about the strength of the interaction between the IL and the gas, and about the ordering that takes place in the gas/IL mixture, respectively.

Of course, a primary concern for any physical property measurement, including gas solubility, is the purity of the sample. Since impurities in ILs have been shown to affect pure component properties such as viscosity [10], one would anticipate that impurities might affect gas solubilities as well, at least to some extent. Since ILs are hygroscopic, a common impurity is water. There might also be residual impurities, such as chloride, present from the synthesis procedure. Surprisingly though, we found that even as much as 1400 ppm residual chloride in 1-*n*-octyl-3-methylimidazolium hexafluorophosphate and tetrafluoroborate ([OMIM][PF<sub>6</sub>] and [OMIM][BF<sub>4</sub>]) did not appear to have any detectable effect on water vapor solubility [1].

#### 3.4.2.2 Stoichiometric technique

The simplest method to measure gas solubilities is what we will call the stoichiometric technique. It can be done either at constant pressure or with a constant volume of gas. For the constant pressure technique, a given mass of IL is brought into contact with the gas at a fixed pressure. The liquid is stirred vigorously to enhance mass transfer and to allow approach to equilibrium. The total volume of gas delivered to the system (minus the vapor space) is used to determine the solubility. If the experiments are performed at pressures sufficiently high that the ideal gas law does not apply, then accurate equations of state can be employed to convert the volume of gas into moles. For the constant volume technique, a known volume of gas is brought into contact with the stirred ionic liquid sample. Once equilibrium is reached, the pressure is noted, and the solubility is determined as before. The effect of temperature (and thus enthalpies and entropies) can be determined by repetition of the experiment at multiple temperatures.

The advantage of the stoichiometric technique is that it is extremely simple. Care has to be taken to remove all gases dissolved in the IL sample initially, but this is easily accomplished because one does not have to worry about volatilization of the IL sample when the sample chamber is evacuated. The disadvantage of this technique is that it requires relatively large amounts of ILs to obtain accurate measurements for gases that are only sparingly soluble. At ambient temperature and pressure, for instance, 10 cm<sup>3</sup> of 1-*n*-butyl-3-methylimidazolium hexafluorophosphate ([BMIM][PF<sub>6</sub>]) would take up only 0.2 cm<sup>3</sup> of a gas with a Henry's law constant of



5000 bar. Also, small temperature variations can cause large uncertainties. For instance, for 50 cm<sup>3</sup> of gas, a temperature fluctuation of just 1 °C would also cause about a 0.2 cm<sup>3</sup> volume change. For some metal apparatus of this type, gas adsorption on the metal surfaces can be an additional source of error. Thus, stoichiometric measurements are best for high-solubility gases and, in general, require excellent temperature and pressure control and measurement, as well as relatively large samples.

#### 3.4.2.3 Gravimetric technique

An alternative technique to the stoichiometric method for measuring gas solubilities has evolved as a result of the development of extremely accurate microbalances. The gravimetric technique involves the measurement of the weight gain of an IL sample when gases are introduced into a sample chamber at a given pressure. There are various commercial apparatus (e.g., Hiden Analytical, Cahn, Rubotherm) well suited for this purpose. The gravimetric technique was originally designed for gas uptake by solids (such as zeolites), but it is well suited for ILs. Even the powerful vacuum ( $\sim 10^{-9}$  bar) used to evacuate the system prior to gas introduction does not evaporate the ionic liquid.

The main advantage of the gravimetric technique is that it requires a much smaller sample than the stoichiometric technique. In many cases, samples as small as 70 mg are sufficient. Accurate temperature and pressure control and measurement are still required, but gas adsorption on the metal walls of the equipment is no longer a concern because it is only the weight gain of the sample that is measured.

There are two main disadvantages to this technique. Firstly, the sample is placed in a static sample “bucket”, and so there is no possibility of stirring. Equilibrium is thus reached solely by diffusion of the gas into the IL sample. For the more viscous samples this can require equilibration times of as much as several hours. Secondly, the weight gain must be corrected for the buoyancy of the sample in order to determine the actual gas solubility. While the mass is measured accurately, the density of the sample must also be known accurately for the buoyancy correction. This is a particularly important problem for low-solubility gases, where the buoyancy correction is a large percentage of the weight gain. For example, the density of an IL must be known to at least  $\pm 0.5$  % if one wishes to measure the solubility of gases with Henry’s law constants greater than 2000 bar accurately. A detailed description of a Hiden Analytical (IGA003) microbalance and its use for the measurement of gas solubilities in ILs can be found elsewhere [1].

#### 3.4.2.4 Gas chromatography

Another method to determine infinite dilution activity coefficients (or the equivalent Henry’s law coefficients) is gas chromatography [11, 12]. In this method, the chromatographic column is coated with the liquid solvent (e.g., the IL). The solute (the gas) is introduced with a carrier gas and the retention time of the solute is a measure of the strength of interaction (i.e., the infinite dilution activity coefficient,  $\gamma_i^\infty$ ) of the solute in the liquid. For the steady-state method,  $\gamma_i^\infty$  is given by [11, 12]:

$$F^o(t-t_{ref})J_3^2 = \frac{RTn_2^1}{\gamma_1^o P_1^{sat}} \quad (3.4-6)$$

where  $F^o$  is the flow rate of the carrier gas,  $t$  and  $t_{ref}$  are the retention times of the solute of interest and a solute that is not retained, respectively,  $J_3^2$  is a correction factor for the pressure drop across the column,  $R$  is the gas constant,  $T$  is the temperature,  $n_2^1$  is the mass of solvent on the column, and  $P_1^{sat}$  is the vapor pressure of the solute. Additional corrections are required for a high pressure, non-ideal gas phase. This technique has been used to measure the infinite dilution activity coefficients of a wide variety of liquid solutes in ionic liquids [13] and could conceivably be used to determine the infinite dilution activity coefficients of condensable gases as well. This technique would work for condensable gases that were retained by the IL more strongly than the carrier gas (usually helium), which may well be the case for many of the alkanes and alkenes of interest, as shown below.

### 3.4.3

#### Gas Solubilities

Although the solubilities of gases in ILs are extremely important, at the time of this writing the number of published studies are limited. Some measurements were presented in oral and poster presentations at a five day symposium dedicated to ionic liquid research at the American Chemical Society national meeting in San Diego in April, 2001. Scovazzo et al. [14], for instance, presented preliminary results for  $\text{CO}_2$  and  $\text{N}_2$  solubility in  $[\text{BMIM}][\text{PF}_6]$ , and Rooney et al. [15] presented the solubility of several gases in several different ILs as determined by the stoichiometric technique. A recent manuscript [16] presented Henry's law constants for  $\text{H}_2$  in two ILs. Given the lack of availability of other data, we concentrate below on the data collected in our laboratories.

#### 3.4.3.1 Water vapor

The solubility of water vapor in ionic liquids is of interest because ionic liquids are extremely hygroscopic. In addition, the solubility of water vapor in ILs is an excellent test of the strength of molecular interactions in these fluids. By using the gravi-

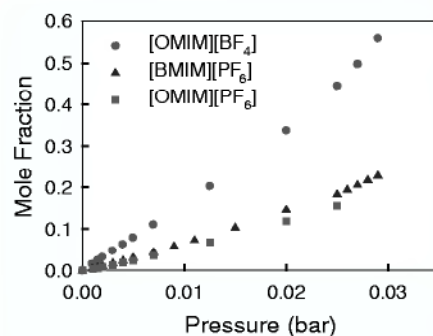

Figure 3.4-1: Solubility of water vapor in  $[\text{BMIM}][\text{PF}_6]$ ,  $[\text{OMIM}][\text{PF}_6]$ , and  $[\text{OMIM}][\text{BF}_4]$  at 25 °C.

**Table 3.4-1:** Henry's Law Constants,  $H_1$ , for water in [OMIM][BF<sub>4</sub>], [BMIM][PF<sub>6</sub>], and [OMIM][PF<sub>6</sub>].

$T$ (°C)	$P_{sat}$ (bar)	[OMIM][BF <sub>4</sub> ]	[BMIM][PF <sub>6</sub> ]	[OMIM][PF <sub>6</sub> ]
		$H_1$ (bar)	$H_1$ (bar)	$H_1$ (bar)
10	0.012	$0.033 \pm 0.014$	$0.09 \pm 0.02$	$0.11 \pm 0.03$
25	0.031	$0.055 \pm 0.006$	$0.17 \pm 0.02$	$0.20 \pm 0.03$
35	0.055	$0.118 \pm 0.014$	$0.25 \pm 0.04$	$0.30 \pm 0.02$
50	0.122	–	$0.45 \pm 0.05$	–

metric technique (Hiden Analytical IGA003) we have measured the solubility of water vapor in [BMIM][PF<sub>6</sub>], [OMIM][PF<sub>6</sub>], and [OMIM][BF<sub>4</sub>] at temperatures between 10 and 50 °C and pressures up to about 80 % of the saturation pressure at each temperature [1]. The data for the three compounds at 25 °C, at which the saturation pressure is just 0.031 bar, are shown in Figure 3.4-1.

The solubility of water vapor is much greater in the IL containing [BF<sub>4</sub>]<sup>-</sup> as the anion, perhaps due to the greater charge density [17] or simply to there being more space for the water molecules [18]. Increasing the length of the alkyl chain on the imidazolium ring decreases the solubility of water, as would be expected. The Henry's law constants are shown in Table 3.4-1. The small values indicate extremely high water vapor solubility in all the ILs.

The  $\Delta h_1$  and  $\Delta s_1$  values for the absorption of water into the three ILs are most similar to water absorption into polar compounds such as 2-propanol. The enthalpy change when water vapor is dissolved in the ILs is compared to dissolution in various organics solvents in Figure 3.4-2 [19, 20]. The enthalpies for absorption of water vapor into polar and protic solvents are much greater than for its absorption into non-polar solvents, indicating much stronger molecular interactions between water and the polar solvents (including opportunities for hydrogen-bonding). In fact, the enthalpy for the absorption of water vapor into the ILs is almost as great as the value for water condensation, which is  $-44$  kJ/mol. Thus, the interactions between water and the ILs are quite strong and probably involve hydrogen bonding.

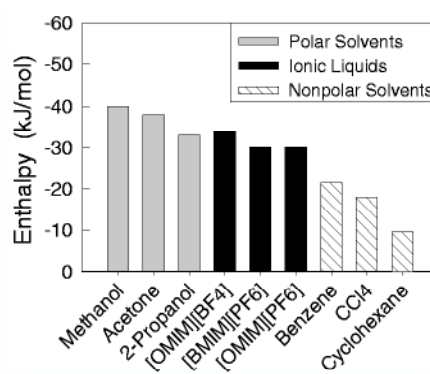
**Figure 3.4-2:** Enthalpy of absorption for water vapor in various solvents at 25 °C.

### 3.4.3.2 Other gases

We have also used the gravimetric technique to measure the solubilities of CO<sub>2</sub>, C<sub>2</sub>H<sub>6</sub>, C<sub>2</sub>H<sub>4</sub>, CH<sub>4</sub>, O<sub>2</sub>, Ar, H<sub>2</sub>, N<sub>2</sub>, and CO in [BMIM][PF<sub>6</sub>] at temperatures between 10 and 50 °C and pressures to 13 bar [21, 22]. In complementary work, we used a constant pressure stoichiometric technique to measure the solubility of CO<sub>2</sub> in [BMIM][PF<sub>6</sub>], [OMIM][PF<sub>6</sub>], [OMIM][BF<sub>4</sub>], 1-*n*-butyl-3-methylimidazolium nitrate ([BMIM][NO<sub>3</sub>]), 1-ethyl-3-methylimidazolium ethylsulfate ([EMIM][EtSO<sub>4</sub>]), and *N*-butylpyridinium tetrafluoroborate ([BP][BF<sub>4</sub>]) at 40, 50, and 60 °C and pressures to 95 bar [23].

CO<sub>2</sub> has by far the highest solubility of all of the gases tested (with the exception of water vapor), as can be seen from Table 3.4-2, which gives the Henry's law constants of the various gases in [BMIM][PF<sub>6</sub>] at 25 °C. In the high-pressure measurements, CO<sub>2</sub> solubilities reached as high as 70 mole % [23]. Although there were some differences (e.g., at a given pressure the CO<sub>2</sub> solubility in [EMIM][EtSO<sub>4</sub>] was about half that in [BMIM][PF<sub>6</sub>]), the solubility of CO<sub>2</sub> was remarkably high in all of the ILs tested. However, CO<sub>2</sub>/IL mixtures did not become single-phase at higher pressures and there was no detectable IL dissolved in the CO<sub>2</sub>-rich gas phase. Even more interestingly, the dissolution of the CO<sub>2</sub> in the IL was accompanied by very little volume increase.

Of the remaining gases, C<sub>2</sub>H<sub>4</sub>, C<sub>2</sub>H<sub>6</sub>, and CH<sub>4</sub> are the next most soluble, in that order. O<sub>2</sub> and Ar display some measurable solubility, but the solubilities of H<sub>2</sub>, N<sub>2</sub>, and CO are below the detection limit of our equipment. The estimates of these detection limits for each gas, which depend on the molecular weight of the gas, are listed in Table 3.4-2. H<sub>2</sub> is particularly difficult to measure by the gravimetric techniques, due to its low molecular weight. For the low-solubility gases, the greatest source of uncertainty in the measurements is the uncertainty in the IL density needed for the buoyancy correction. The solubilities of the non-polar gases, apart from CO<sub>2</sub>, which has a large quadrupole moment, correlate reasonably well with the polarizabilities of the gases. On the basis of this correlation, we would predict Henry's law constants for H<sub>2</sub>, N<sub>2</sub>, and CO of 20,000 bar, 6000 bar, and 5000 bar, respectively, at 25 °C. This would suggest that we should have been able to measure the Henry's law constants for N<sub>2</sub> and CO, but this was not the case. Similar trends are observed at the other temperatures [22].

Gas	Henry's Law Constant (Bar)
CO <sub>2</sub>	53.4 ± 0.3
C <sub>2</sub> H <sub>4</sub>	173 ± 17
C <sub>2</sub> H <sub>6</sub>	355 ± 36
CH <sub>4</sub>	1690 ± 180
O <sub>2</sub>	8000 ± 5400
Ar	8000 ± 3800
H <sub>2</sub>	Non-detectable (>1500)
N <sub>2</sub>	Non-detectable (>20000)
CO	Non-detectable (>20000)

**Table 3.4-2:** Henry's Law Constants,  $H_1$ , for various gases in [BMIM][PF<sub>6</sub>] at 25 °C.

Berger and coworkers [16] presented measurements for the Henry's law constant (defined as  $M = K \cdot P$ , where  $M$  is the gas solubility in  $\text{mol L}^{-1}$ ,  $K$  is the constant in  $\text{mol L}^{-1}\text{atm}^{-1}$ , and  $P$  is the gas partial pressure in atm.) of  $\text{H}_2$  in  $[\text{BMIM}][\text{PF}_6]$  and  $[\text{BMIM}][\text{BF}_4]$  of  $3.0 \times 10^{-3} \text{ mol L}^{-1} \text{ atm}^{-1}$  and  $8.8 \times 10^{-4} \text{ mol L}^{-1} \text{ atm}^{-1}$ , respectively. The value for  $[\text{BMIM}][\text{PF}_6]$  corresponds to about 5700 bar, which is consistent with our measurements. However, it should be noted that Berger et al. [16] used a constant volume stoichiometric technique with a  $50 \text{ cm}^3$  vessel, pressurized to 50 atm. and containing  $10 \text{ cm}^3$  of IL. The resulting pressure drop when the gas is absorbed into the liquid would only be on the order of 0.005 atm. The authors do not report the uncertainty of their Henry's constants, nor the accuracy of their pressure gauge. Unless a highly accurate differential pressure transducer was employed, it is likely that these values are good order of magnitude estimates only.

Not surprisingly, the enthalpy of adsorption of  $\text{CO}_2$  is the highest of the gases listed in Table 3.4-2, indicating strong interactions between the  $\text{CO}_2$  and  $[\text{BMIM}][\text{PF}_6]$ . However, it is significantly less than that for the dissolution of  $\text{H}_2\text{O}$  vapor in  $[\text{BMIM}][\text{PF}_6]$ . The enthalpies decrease in magnitude in the order of decreasing solubility. Interestingly,  $\text{O}_2$  and Ar exhibit positive enthalpies of absorption, indicating that there are no measurable attractive forces and that their dissolution in the IL is entirely entropically driven. Thus, gas solubilities are a useful "probe" of interactions in ILs.

#### 3.4.4

#### Applications

The solubilities, discussed above, of the various gases in the ionic liquids have important implications for applications of ILs. The impact of gas solubilities on reactions, gas separations and the use of compressed gases or supercritical fluids to separate solutes from ILs are discussed below.

##### 3.4.4.1 Reactions involving gases

In general, the rates of most reactions depend on the concentration of the reacting species, by some positive power. Thus, it is generally desirable to have high solubilities of reactants. For reactions in ILs involving gases, this means that one would desire high gas solubilities. This is true in all cases except for instances in which the inherent reaction rate is extremely slow (i.e., slower than the natural diffusion of the gas into the IL). Otherwise, one would have to resort to high-pressure operation or vigorous stirring in an attempt to increase interfacial area and to promote faster mass transfer. In this case, the reaction rate is limited by the rate at which the gas is transferred into the liquid, rather than by the inherent reaction kinetics. This could be a particular challenge when using ILs as solvents, since they tend to be more viscous than conventional solvents [10, 24]. High viscosity means lower diffusivities and more difficulties in attempts to promote adequate mass transfer.

Some types of reactions involving gases that have been studied in ILs are hydrogenations [16, 25–37], oxidations [38, 39], and hydroformylations [25, 40–45]. In addition, some dimerizations and alkylations may involve the dissolution of condensable gases (e.g., ethylene, propylene, isobutene) in the IL solvent [46–50].



Surprisingly, no effort was made to determine the influence of gas solubility in most of these reaction studies, nor whether the reaction was, in fact, mass-transfer limited. Because of the low solubilities of  $H_2$ ,  $O_2$ , and CO in [BMIM][PF<sub>6</sub>], one of the most common IL solvents used in the above studies, however, most of the reactions in these studies are likely to have been mass transfer-limited. Suarez et al. [27], for example, noted that in the absence of stirring the consumption of hydrogen in their hydrogenation reaction stopped completely. This same group [16] is also responsible for the estimate of the Henry's law constant of hydrogen in [BMIM][PF<sub>6</sub>] and [BMIM][BF<sub>4</sub>], as discussed above. They correctly note that, on comparing reaction results in different ILs, the important physical parameter to hold constant is the gas solubility rather than the gas partial pressure. Moreover, for mass transfer-limited reactions, it is not possible to compare results of reaction rates for reactions performed by different research groups. This is because the rates depend solely on the quality of the interphase mass transfer, and all the researchers perform the reactions with different mixing conditions.

As mentioned above, the solubilities of the gases needed for hydrogenation reactions ( $H_2$ ), oxidation reactions ( $O_2$ ), and hydroformylation reactions ( $H_2$  and CO) in [BMIM][PF<sub>6</sub>] are extremely low. In fact, the solubilities are generally lower than in conventional organic solvents [22]. The solubility of these gases may be higher in other ILs; for instance, Berger et al. [16] estimate that  $H_2$  solubility is four times greater in [BMIM][BF<sub>4</sub>] than in [BMIM][PF<sub>6</sub>]. However, one would not expect orders of magnitude changes in solubility when the anion or substituents on the cation were changed slightly. The primary substrate in the hydroformylation reactions is an alkene, the lightest example of which would be ethylene. Since the ethylene solubility is quite high, the limiting factors are likely to be the CO and  $H_2$  solubilities, rather than the solubility of the alkene. Thus, overall, [BMIM][PF<sub>6</sub>] does not appear to be a good industrial solvent for reactions involving permanent gases such as  $H_2$ ,  $O_2$ , or CO, because these reactions would have to be carried out at extremely high pressures or would be limited by interphase mass transfer. While there are certainly examples of commercial biphasic reactions that are limited by interphase mass transfer [51], that type of reactor configuration is generally not preferred. There would have to be significant independent factors favoring the IL solvent (such as higher selectivity) to warrant the use of the IL solvent.

#### 3.4.4.2 Gas separations

ILs, on the other hand, are uniquely suited for use as solvents for gas separations. Since they are non-volatile, they cannot evaporate to cause contamination of the gas stream. This is important when selective solvents are used in conventional absorbers, or when they are used in supported liquid membranes. For conventional absorbers, the ability to separate one gas from another depends entirely on the relative solubilities (ratio of Henry's law constants) of the gases. In addition, ILs are particularly promising for supported liquid membranes, because they have the potential to be incredibly stable. Supported liquid membranes that incorporate conventional liquids eventually deteriorate because the liquid slowly evaporates. Moreover, this finite evaporation rate limits how thin one can make the membrane. This



means that the net flux through the membrane is decreased. These problems could be eliminated with a non-volatile liquid. In the absence of facilitated transport (such as complexation of CO<sub>2</sub> with amines to form carbamates), permeability of gases through supported liquid membranes depends both on the solubility and on the diffusivity. The flux of one gas relative to the other can be estimated by a simplified solution-diffusion model:

$$\frac{N_A}{N_B} = \frac{H_B D_A}{H_A D_B} \quad (3.4-7)$$

where  $N$  is the flux,  $H$  is the Henry's law constant, and  $D$  is the diffusivity. Thus, the ratio of Henry's law constants is critical in determining the performance of an IL-based supported liquid membrane.

The solubilities of the various gases in [BMIM][PF<sub>6</sub>] suggests that this IL should be an excellent candidate for a wide variety of industrially important gas separations. There is also the possibility of performing higher-temperature gas separations, thanks to the high thermal stability of the ILs. For supported liquid membranes this would require the use of ceramic or metallic membranes rather than polymeric ones. Both water vapor and CO<sub>2</sub> should be removed easily from natural gas since the ratios of Henry's law constants at 25 °C are ~9950 and 32, respectively. It should be possible to scrub CO<sub>2</sub> from stack gases composed of N<sub>2</sub> and O<sub>2</sub>. Since we know of no measurements of H<sub>2</sub>S, SO<sub>x</sub>, or NO<sub>x</sub> solubility in [BMIM][PF<sub>6</sub>], we do not know if it would be possible to remove these contaminants as well. Nonetheless, there appears to be ample opportunity for use of ILs for gas separations on the basis of the widely varying gas solubilities measured thus far.

#### 3.4.4.3 Extraction of solutes from ionic liquids with compressed gases or supercritical fluids

We have shown that it is possible to extract a wide variety of solutes from ILs with supercritical CO<sub>2</sub> [9, 52]. The advantage of this technique is that it combines two potentially environmentally benign solvents to perform the reaction and separation steps. Subsequently, several groups have shown that this strategy can be combined with reaction operations [36, 37, 45]. The key to this separation is the phase behavior of ILs with CO<sub>2</sub>. Although large amounts of CO<sub>2</sub> dissolve in the IL, no measurable IL dissolves in the CO<sub>2</sub>. Conceivably, it should be possible to extract solutes from IL mixtures with other supercritical fluids or compressed gases. For instance, supercritical ethane and propane are excellent solvents for a wide variety of non-polar and aromatic species. These are not as environmentally benign as CO<sub>2</sub> but may be options if it is shown that the ILs have negligible solubility in them, as well.

#### 3.4.5

##### Summary

The solubility of various gases in ionic liquids is extremely important in evaluating ILs as solvents for reactions, separations, and materials processing. There are a number of viable techniques for measuring gas solubilities in ILs, including the

stoichiometric method, gravimetric methods, or even gas chromatography. In general, the measurement of these solubilities is facilitated by the non-volatility of the solvent. For [BMIM][PF<sub>6</sub>], we have shown very large solubility differences between the relatively high-solubility gases (CO<sub>2</sub>, C<sub>2</sub>H<sub>4</sub>, C<sub>2</sub>H<sub>6</sub>, and CH<sub>4</sub>) and the low-solubility gases (CO, H<sub>2</sub>, O<sub>2</sub>, Ar, and N<sub>2</sub>). Unfortunately, many of the gases of interest for reactions (H<sub>2</sub>, O<sub>2</sub> and CO) are only sparingly soluble in the IL. Conversely, the large differences in the solubilities of different gases in the IL suggest that ILs may be ideal solvents for performing gas separations. Limited measurements of CO<sub>2</sub> solubility in different ILs suggest that the trends found for [BMIM][PF<sub>6</sub>] may be representative. However, the wide variety of choice of cations, anions, and substituents make the possibility of tailoring ILs for specific gas separations or reactions involving gases an exciting option.

## References

- 1 J. L. Anthony, E. J. Maginn, J. F. Brennecke, *J. Phys. Chem. B* **2001**, *105*, 10,942–10,949.
- 2 A. G. Fadeev, M. M. Meagher, *Chem. Commun.* **2001**, 295–296.
- 3 K. R. Seddon, A. Stark, M. J. Torres, *Pure Appl. Chem.* **2000**, *72*, 2275–2287.
- 4 J. D. Holbrey, K. R. Seddon, *Clean Products and Processes* **1999**, *1*, 233–236.
- 5 T. Welton, *Chem. Rev.* **1999**, *99*, 2071–2083.
- 6 P. Wasserscheid, W. Keim, *Angew. Chem. Int. Ed.* **2000**, *39*, 3772–3789.
- 7 C. L. Hussey, *Pure Appl. Chem.* **1988**, *60*, 1763–1772.
- 8 K. R. Seddon, *Kinet. Catal.* **1996**, *37*, 693–697.
- 9 L. A. Blanchard, J. F. Brennecke, *Ind. Eng. Chem. Res.* **2001**, *40*, 287–292.
- 10 K. R. Seddon, A. Stark, M. J. Torres, *ACS Symp. Ser.* (L. Moens, M. Abraham eds.), *ACS Symp. Ser. 819* (L. Moens, M. Abraham eds.), **2002**, p. 34–49. The title of the symposium series is “Clean Solvents”.
- 11 R. J. Laub, R. L. Pecsok, *Physicochemical Applications of Gas Chromatography*, **1978**, Wiley, New York.
- 12 H. Orbey, S. I. Sandler, *Ind. Eng. Chem. Res.* **1991**, *30*, 2006–2011.
- 13 A. Heintz, D. V. Kulikov, S. P. Verevkin, *J. Chem. Eng. Data* **2001**, *46*, 1526–1529.
- 14 P. Scovazzo, A. E. Visser, J. H. Davis, R. D. Rogers, R. D. Noble, C. Koval, *Abstracts of Papers of the American Chemical Society* **2001**, *221*, 28-IEC.
- 15 D. W. Rooney, C. Hardacre, S. Kadare, *Abstracts of Papers of the American Chemical Society* **2001**, *221*, 56-IEC.
- 16 A. Berger, R. F. de Souza, M. R. Delgado, J. Dupont, *Tetrahedron: Asymmetry* **2001**, *12*, 1825–1828.
- 17 A. B. McEwen, H. L. Ngo, K. LeCompte, J. L. Goldman, *J. Electrochem. Soc.* **1999**, *146*, 1687–1695.
- 18 I. Jureviciute, S. Bruckenstein, A. R. Hillman, *J. Electroanal. Chem.* **2000**, *488*, 73–81.
- 19 S. Goldman, *Can. J. Chem.* **1974**, *88*, 1668.
- 20 J. Gmehling, J. Menke, M. Schiller, *Activity Coefficients at Infinite Dilution*; DECHEMA, Frankfurt, **1994**.
- 21 J. L. Anthony, E. J. Maginn, J. F. Brennecke, *ACS Symp. Series 818* (R. D. Rogers, K. R. Seddon, Eds.), **2002**, p. 260–270.
- 22 J. L. Anthony, E. J. Maginn, J. F. Brennecke, *J. Phys. Chem. B*, **2002**, *106*, 7315–7320.

- 23 L. A. Blanchard, Z. Gu, J. F. Brennecke, *J. Phys. Chem. B* **2001**, *105*, 2437–2444.
- 24 P. Bonhôte, A.-P. Dias, N. Papageorgiou, K. Kalyanasundaram, M. Grätzel, *Inorg. Chem.* **1996**, *35*, 1168–1178.
- 25 Y. Chauvin, L. Mussmann, H. Olivier, *Angew. Chem. Int. Ed. Engl.* **1995**, *34*, 2698–2700.
- 26 P. A. Z. Suarez, J. E. L. Dullius, S. Einloft, R. F. de Souza, J. Dupont, *Polyhedron* **1996**, *15*, 1217–1219.
- 27 P. A. Z. Suarez, J. E. L. Dullius, S. Einloft, R. F. de Souza, J. Dupont, *Inorganica Chimica Acta* **1997**, *255*, 207–209.
- 28 A. L. Monteiro, F. K. Zinn, R. F. de Souza, J. Dupont, *Tetrahedron: Asymmetry* **1997**, *8*, 177–179.
- 29 R. T. Carlin, J. Fuller, *Chem. Commun.* **1997**, 1345–1346.
- 30 T. H. Cho, J. Fuller, R. T. Carlin, *High Temp. Material Processes* **1998**, *2*, 543–558.
- 31 L. A. Müller, J. Dupont, R. F. de Souza, *Macromol. Rapid Commun.* **1998**, *19*, 409–411.
- 32 P. J. Dyson, D. J. Ellis, D. G. Parker, T. Welton, *Chem. Commun.* **1999**, 25–26.
- 33 D. J. Ellis, P. J. Dyson, D. G. Parker, T. Welton, *J. Mol. Cat. A* **1999**, *150*, 71–75.
- 34 S. Steines, P. Wasserscheid, B. Drißßen-Hölscher, *J. Prakt. Chem.* **2000**, *342*, 348–354.
- 35 S. Guernik, A. Wolfson, M. Herskowitz, N. Greenspoon, S. Geresh, *Chem. Commun.* **2001**, 2314–2315.
- 36 R. A. Brown, P. Pollet, E. McKoon, C. A. Eckert, C. L. Liotta, P. G. Jessop, *J. Am. Chem. Soc.* **2001**, *123*, 1254–1255.
- 37 F. Liu, M. B. Abrams, R. T. Baker, W. Tumas, *Chem. Commun.* **2001**, 433–434.
- 38 J. Howarth, *Tetrahedron Lett.* **2000**, *41*, 6627–6629.
- 39 L. Gaillon, F. Bedioui, *Chem. Commun.* **2001**, 1458–1459.
- 40 N. Karodia, S. Guise, C. Newlands, J. Anderson, *Chem. Commun.* **1998**, 2341–2342.
- 41 W. Keim, D. Vogt, H. Waffenschmidt, P. Wasserscheid, *J. Catalysis* **1999**, *186*, 481–484.
- 42 C. C. Brasse, U. Englert, A. Salzer, H. Waffenschmidt, P. Wasserscheid, *Organometallics* **2000**, *19*, 3818–3823.
- 43 F. Favre, H. Olivier-Bourbigou, D. Commereuc, L. Saussine, *Chem. Commun.* **2001**, 1360–1361.
- 44 D. J. Brauer, K. W. Lottsieper, C. Like, O. Stelzer, H. Waffenschmidt, P. Wasserscheid, *J. Organometallic Chem.* **2001**, *630*, 177–184.
- 45 M. F. Sellin, P. B. Webb, D. J. Cole-Hamilton, *Chem. Commun.* **2001**, 781–782.
- 46 Y. Chauvin, B. Gilbert, I. Guibard, *J. Chem. Soc., Chem. Commun.* **1990**, 1715–1716.
- 47 Y. Chauvin, A. Hirschauser, H. Olivier, *J. Mol. Cat.* **1994**, *92*, 155–165.
- 48 Y. Chauvin, S. Einloft, H. Olivier, *Ind. Eng. Chem. Res.* **1995**, *34*, 1149–1155.
- 49 S. Einloft, F. K. Dietrich, R. F. de Souza, J. Dupont, *Polyhedron*, **1996**, *15*, 1257–1259.
- 50 Y. Chauvin, H. Olivier, C. N. Wyrwalski, L. C. Simon, R. F. de Souza, *J. Catalysis* **1997**, *165*, 275–278.
- 51 E. G. Kuntz, *CHEMTECH* **1987**, 570.
- 52 L. A. Blanchard, D. Hancu, E. J. Beckman, J. F. Brennecke, *Nature* **1999**, 399, 28–29.

### 3.5 Polarity

*Tom Welton*

It is well known that the choice of solvent can have a dramatic effect upon a chemical reaction [1]. As early as 1862 the ability of solvents to decelerate the reaction between acetic acid and ethanol had been noted [2]. Thirty years later the influence of solvents on reaction equilibria was demonstrated for the first time [3].

Once such effects had been noted, it became necessary to interpret the observed results and to classify the solvents. The earliest attempts at this were by Stobbe, who reviewed the effects of solvents on keto-enol tautomers [4]. Since then many attempts have been used to explain solvent effects, some based on observations of chemical reactions, others on physical properties of the solvents, and yet others on spectroscopic probes. All of these have their advantages and disadvantages and no one approach can be thought of as exclusively “right”. This review is organized by type of measurement, and the available information is then summarized at the end.

Most modern discussions of solvent effects rely on the concept of solvent polarity. Qualitative ideas of polarity are based on observations such as “like dissolves like” and are well accepted. However, quantification of polarity has proven to be extraordinarily difficult. Since the macroscopic property polarity arises from a myriad of possible microscopic interactions, this is perhaps unsurprising. Hence, it is important that care is taken when measuring the “polarity” of any liquid to ensure that it is clearly understood what is actually being measured.

The most common measure of polarity used by chemists in general is that of dielectric constant. It has been measured for most molecular liquids and is widely available in reference texts. However, direct measurement, which requires a non-conducting medium, is not available for ionic liquids. Other methods to determine the “polarities” of ionic liquids have been used and are the subject of this chapter. However, these are early days and little has been reported on ionic liquids themselves. I have therefore included the literature on higher melting point organic salts, which has proven to be very informative.

#### 3.5.1

##### **Chromatographic Measurements**

In a series of papers published throughout the 1980s, Colin Poole and his co-workers investigated the solvation properties of a wide range of alkylammonium and, to a lesser extent, phosphonium salts. Parameters such as McReynolds’ phase constants were calculated by using the ionic liquids as stationary phases for gas chromatography and analysis of the retention of a variety of probe compounds. However, these analyses were found to be unsatisfactory and were abandoned in favour of an analysis that used Abraham’s solvation parameter model [5].

Abraham's model was constructed to describe solute behavior, but it recognizes the intimacy of the solute–solvent relationship and so provides a useful model of solvent properties [6]. The model is based on solvation occurring in two steps. First, a cavity is generated in the solvent. This process is endoergic, as the self-association of the solvent is overcome. Then the solute is incorporated in the cavity. This step is exoergic, as the solvent–solute interactions are formed. By working with G.C., and therefore gaseous solutes, the self-association of the solute can be ignored. The form of the model used to investigate ionic liquid properties is given in Equation (3.5-1) [5]:

$$\log K_L = c + rR_2 + s\pi_2^H + a\alpha_2^H + b\beta_2^H + l \log L^{16} \quad (3.5-1)$$

Where  $K_L$  is the solute gas–liquid partition coefficient,  $r$  is the tendency of the solvent to interact through  $\pi$ - and n-electron pairs (Lewis basicity),  $s$  the contribution from dipole–dipole and dipole-induced dipole interactions (in molecular solvents),  $a$  is the hydrogen bond basicity of the solvent,  $b$  is its hydrogen bond acidity and  $l$  is how well the solvent will separate members of a homologous series, with contributions from solvent cavity formation and dispersion interactions.

This model has been applied to 38 different organic salts, primarily tetraalkylammonium halides and substituted alkanesulfonates [5]. For the range of salts included in the study, it was found that they were strong hydrogen-bond bases, with the basicity being diminished by fluorination of the anion. The organic salts had large  $s$  values, which were interpreted as a significant capacity for dipole–dipole and dipole–induced dipole interactions, but it is in the  $s$  value that any Coulombic effect would be expected to show itself.

Some exceptions to this general observation were found: halide and nitrite salts have unusually high hydrogen-bond basicities (as would be expected), while pentacyanopropionide, picrate, triflate, and perfluorobenzenesulfonate salts not only had unusually low hydrogen-bond basicities (also as would be expected) but also lower  $s$  values, perhaps due to the weakening of the Coulombic interactions by delocalization of the charge on the anions.

It was noted that, on going from tetrabutylammonium to tetrabutylphosphonium, salts with a common anion displayed identical solvation properties. Hence, with these simple cations, the solvent properties are dominated by the choice of anion. It is possible that, had cations with acidic protons, such as trialkylammonium and trialkylphosphonium, been included in the study, these may then have also had an influence.

One interesting point of note is that the component arising from the solvent's ability to form a cavity and its dispersion interactions is unusually high – in comparison to those for non-ionic polar solvents – for most of the ionic liquids with poorly associating anions and increases as the cation becomes bulkier. With the hydrogen bond base anions, this ability weakened. High values for  $l$  are usually associated with non-polar solvents. This observation agrees with the often repeated statement that ionic liquids have unusual mixing properties (see Sections 3.3 and 3.4).



Finally, none of the ionic liquids were found to be hydrogen bond acids [5], although this may well be a consequence of the salts selected, none of which had a cation that would be expected to act as a hydrogen bond donor. Earlier qualitative measurements on ionic liquid stationary phases of mono-, di-, and trialkylammonium salts suggest that hydrogen bond donation can be important where a potentially acidic proton is available [7–9]. More recent work, with [BMIM]<sup>+</sup> salts, also indicates that these ionic liquids should be considered to be hydrogen bond donor solvents [10]. However, this has yet to be quantified.

### 3.5.2 Absorption Spectra

The longest-wavelength absorption band of Reichardt's dye (2,4,6-triphenylpyridinium-*N*-4-(2,6-diphenylphenoxy) betaine, Figure 3.5-1) shows one of the largest solvatochromic shifts known (375 nm between diphenyl ether and water) [11]. It can register effects arising from solvent dipolarity, hydrogen bonding, and Lewis acidity, with the greatest contribution coming from the hydrogen bond donor property of the solvent [12]. The  $E_T^N$  values of a small number of alkylammonium nitrate, thiocyanate, and sulfonate salts [13, 14] have been recorded, as have those of some substituted imidazolium tetrafluoroborate, hexafluorophosphate, triflate, and trifluoromethanesulfonylimide salts [15]. It has been noted that these measurements are highly sensitive to the preparation of the ionic liquids used [15], so it is unfortunate that there are no examples that appear in all studies.

Table 3.5-1 lists the  $E_T^N$  values for the alkylammonium thiocyanates and nitrates and the substituted imidazolium salts. It can be seen that the values are dominated by the nature of the cation. For instance, values for monoalkylammonium nitrates and thiocyanates are ca. 0.95–1.01, whereas the two tetraalkylammonium salts have values of ca. 0.42–0.46. The substituted imidazolium salts lie between these two extremes, with those with a proton at the 2-position of the ring having higher values than those with this position methylated. This is entirely consistent with the expected hydrogen bond donor properties of these cations.

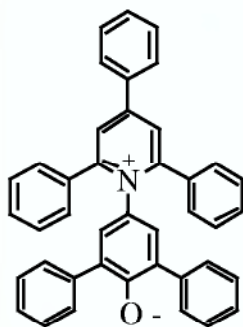

Figure 3.5-1: Reichardt's Dye.



Table 3.5-1: Solvent polarity measurements for some ionic liquids.

Salt	$E_T^N$	$\pi^*$	$\alpha$	$\beta$	$\Omega$
[Pr <sub>2</sub> NH <sub>2</sub> ][SCN]	1.006	1.16	0.97	0.39	
[sec-BuNH <sub>3</sub> ][SCN]	1.006	1.28	0.91		
Water	1.000	1.09	1.17	0.47	0.869
[EtNH <sub>3</sub> ][NO <sub>3</sub> ]	0.954	1.24	0.85	0.46	0.82
[BuNH <sub>3</sub> ][SCN]	0.948	1.23	0.92		
[PrNH <sub>3</sub> ][NO <sub>3</sub> ]	0.923	1.17	0.88	0.52	
[Bu <sub>3</sub> NH][NO <sub>3</sub> ]	0.802	0.97	0.84		
[BMIM][ClO <sub>4</sub> ]	0.684				0.67
[BMIM][BF <sub>4</sub> ]	0.673	1.09	0.73	0.72	0.66
[BMIM][TfO]	0.667				0.65
[BMIM][PF <sub>6</sub> ]	0.667	0.91	0.77	0.41	0.68
Ethanol	0.654	0.54	0.75	0.75	0.718
[BMIM][Tf <sub>2</sub> N]	0.642				
[BMIM]Cl		1.17	0.41	0.95	
[EtNH <sub>3</sub> ]Cl	0.636				
[OMIM][PF <sub>6</sub> ]	0.633	0.88	0.58	0.46	
[OMIM][Tf <sub>2</sub> N]	0.630				
[OMIM]Cl		1.09	0.33	0.90	
[Pr <sub>4</sub> N][CHES]*	0.62	1.08	0.34	0.80	
[BMIM][CF <sub>3</sub> CO <sub>2</sub> ]	0.620				
[Bu <sub>4</sub> N][CHES]*	0.62	1.01	0.34	0.98	
[Pe <sub>4</sub> N][CHES]*	0.58	1.00	0.15	0.91	
[Bu <sub>4</sub> N][BES]*	0.53	1.07	0.14	0.81	
[BMMIM][Tf <sub>2</sub> N]	0.525				
[Bu <sub>4</sub> N][MOPSO]*	0.49	1.07	0.03	0.74	
[OMMIM][BF <sub>4</sub> ]	0.543				
[OMMIM][Tf <sub>2</sub> N]	0.525				
[Et <sub>4</sub> N][NO <sub>3</sub> ]	0.460				
Acetonitrile	0.460	0.75	0.19	0.31	0.692
[Et <sub>4</sub> N]Cl	0.454				
[Hx <sub>4</sub> N][PhCO <sub>2</sub> ]	0.420				
Diethyl ether	0.117	0.27	0.00	0.47	0.466
Cyclohexane	0.009	0.00	0.00	0.00	0.595

\*CHES is 2-(cyclohexylamino)ethanesulfonate, BES is 2- $\{$ bis(2-hydroxyethyl)amino $\}$ ethanesulfonate, MOPSO is 2-hydroxy-4-morpholinepropanesulfonate.

The role of the anion is less clear-cut. It can be seen that ionic liquids with the same cation but different anions have different  $E_T^N$  values. However, the difference in the values for [Et<sub>4</sub>N]Cl and [Et<sub>4</sub>N][NO<sub>3</sub>] is only 0.006, whereas the difference between [EtNH<sub>3</sub>]Cl and [EtNH<sub>3</sub>][NO<sub>3</sub>] is 0.318. Less dramatically, the difference in the values for [OMMIM][BF<sub>4</sub>] and [OMMIM][Tf<sub>2</sub>N] is only 0.018, whereas the difference between [BMIM][BF<sub>4</sub>] and [BMIM][Tf<sub>2</sub>N] is 0.031. Hence, it is clear that the effect of changing the anion depends on the nature of the cation.

If the cation has been unchanged, its ability to act as a hydrogen-bond donor has been unchanged, so why is an effect seen at all? I propose that there is competition between the anion and the Reichardt's dye solute for the proton. Thus, the  $E_T^N$  values of the ionic liquids are controlled by the ability of the liquid to act as a hydrogen bond donor (cation effect) moderated by its hydrogen bond acceptor ability (anion effect). This may be described in terms of two competing equilibria. The cation can hydrogen bond to the anion [Equation (3.5-2)]:

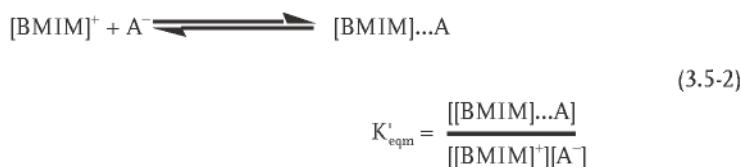

The cation can hydrogen bond to the solute (Reichardt's dye in this case) [Equation (3.5-3)]:

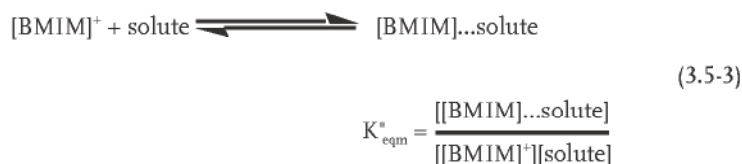

It can easily be shown that the value of  $K''$  is inversely proportional to the value of  $K'$  and that  $K'$  is dependent on both the cation and the anion of the ionic liquid. Hence, it is entirely consistent with this model that the difference made by changing the anion should depend on the hydrogen bond acidity of the cation.

Attempts have also been made to separate non-specific effects of the local electrical field from hydrogen-bonding effects for a small group of ionic liquids through the use of the  $\pi^*$  scale of dipolarity/polarizability, the  $\alpha$  scale of hydrogen bond donor acidity, and the  $\beta$  scale of hydrogen bond basicity (see Table 3.5-1) [13, 16].

The  $\pi^*$  values were high for all of the ionic liquids investigated (0.97–1.28) when compared to molecular solvents. The  $\pi^*$  values result from measuring the ability of the solvent to induce a dipole in a variety of solute species, and they will incorporate the Coulombic interactions from the ions as well as dipole–dipole and polarizability effects. This explains the consistently high values for all of the salts in the studies. The values for quaternary ammonium salts are lower than those for the monoalkylammonium salts. This probably arises from the ability of the charge center on the cation to approach the solute more closely for the monoalkylammonium salts. The values for the imidazolium salts are lower still, probably reflecting the delocalization of the charge in the cation.

The difference in the hydrogen bond acidities and basicities was far more marked. The  $\alpha$  value is largely determined by the availability of hydrogen bond donor sites on the cation. Values range from 0.8–0.9 for the monoalkylammonium salts, and are slightly lower (0.3–0.8) for the imidazolium salts. In the absence of a

hydrogen bond donor, cation values are lower still: in the 0.1–0.3 range. It appears that more basic anions give lower values of  $\alpha$  with a common cation. This is further evidence for the idea of competing equilibria detailed above for Reichardt's dye [Equations (3.5-2) and (3.5-3)].

At first glance the hydrogen bond basicity  $\beta$  is controlled solely by the anions, with basicity decreasing in the order  $\text{Cl}^- > [\text{RSO}_3]^- > [\text{BF}_4]^- > [\text{PF}_6]^- > [\text{NO}_3]^- > [\text{SCN}]^-$ . However, while the general trend is clear, this is not the order that one would have expected, and the cations are obviously playing a role. Again, this may be a consequence of competition for the basic site (anion) between the test solute and the acidic site (cation) of the ionic liquid. It is unfortunate that no study to date has used a common anion across all possible cations.

### 3.5.3

#### Fluorescence Spectra

A number of workers have attempted to study the polarity of ionic liquids with the aid of the fluorescence spectra of polycyclic aromatic hydrocarbons. Of these, the most commonly applied has been that of pyrene [17–19]. The measurements are of the ratio of the intensities of the first and third vibronic bands in the  $\pi$ – $\pi^*$  emission spectrum of monomer pyrene ( $I_1/I_3$ ). The increase in  $I_1/I_3$  values in more polar solvents has been attributed to a reduction in local symmetry [20], but the mechanism for this is poorly understood, although some contribution from solvent hydrogen bond acidity has been noted [21]. It is hence difficult to know what the measurements are telling us about the ionic liquids in anything other than the most general terms. These measurements have generally placed the ionic liquids in the polarity range of moderately polar solvents, with monoalkylammonium thiocyanates displaying values in the 1.01–1.23 range, [EMIM][ $(\text{CF}_3\text{SO}_2)_2\text{N}$ ] having a value of 0.85, and [BMIM][ $\text{PF}_6$ ] a particularly high value of 2.08 (water = 1.87, acetonitrile = 1.79, methanol = 1.35). It should be noted that the spectrum of pyrene would be expected to be sensitive to HF, which could well be present in these  $[\text{PF}_6]^-$  ionic liquids, and would give a high value of  $I_1/I_3$ . Other fluorescence probes that have been used give broadly similar results [17–22].

### 3.5.4

#### Refractive Index

The refractive index of a medium is the ratio of the speed of light in a vacuum to its speed in the medium, and is the square root of the relative permittivity of the medium at that frequency. When measured with visible light, the refractive index is related to the electronic polarizability of the medium. Solvents with high refractive indexes, such as aromatic solvents, should be capable of strong dispersion interactions. Unlike the other measures described here, the refractive index is a property of the pure liquid without the perturbation generated by the addition of a probe species.

Although the measurement of the refractive index of a liquid is relatively straightforward, few have been recorded for ionic liquids to date. Monoalkylammonium

nitrate and thiocyanates give moderate values, higher for thiocyanates than for nitrates with a common cation, and the refractive index increases with the chain length of the cation [23]. However, little more than that can be said at this stage, since there have been too few measurements reported to date.

### 3.5.5

#### Organic Reactions

An alternative avenue for the exploration of the polarity of a solvent is by investigation of its effect on a chemical reaction. Since the purpose of this book is to review the potential application of ionic liquids in synthesis, this could be the most productive way of discussing ionic liquid polarity. Again, the field is in its infancy, but some interesting results are beginning to appear.

##### 3.5.5.1 Alkylation of sodium 2-naphthoxide

The C- vs. O-alkylation of sodium 2-naphthoxide in simple molten phosphonium and ammonium halides (which are molten at temperatures of ca. 110 °C) has been studied in order to compare their properties with those of conventional organic solvents [24]. The regioselectivity of the reaction is dependent on the nature of the counterion of the 2-naphthol salt and the solvent. In dipolar aprotic solvents, O-alkylation is favoured. The use of  $[n\text{-Bu}_4\text{P}]\text{Br}$ ,  $[n\text{-Bu}_4\text{N}]\text{Br}$ ,  $[\text{EMIM}]\text{Br}$ , and  $[n\text{-Bu}_4\text{P}]\text{Cl}$  as solvents resulted in every case in high regioselectivity for the O-alkylation product (between 93 % and 97 %), showing the polar nature of the ionic liquids. Analysis by  $^1\text{H}$  and  $^{31}\text{P}$  NMR showed that the ionic liquids were unaffected by the reaction and could be reused to achieve the same results [24]. Almost identical findings were obtained for the alkylation of 2-naphthol in the ionic liquid  $[\text{BMIM}][\text{PF}_6]$  [25]. This would suggest that, for this reaction and with this range of ionic liquids, the specific ions that compose the ionic liquid are less important than the ionic nature of the medium in determining the outcome of the reaction.

##### 3.5.5.2 Diels–Alder reactions

One of the earliest solvent polarity scales is Berson's  $\Omega$  scale. This scale is based on the *endo/exo* ratio of the Diels–Alder reaction between cyclopentadiene and methyl acrylate (Figure 3.5-2,  $\Omega = \log_{10} \text{endo/exo}$ ). This reaction has been conducted in a number of ionic liquids, giving values in the 0.46–0.83 range [26].

Berson postulated that the transition state giving rise to the *endo* adduct should be more polar than that giving rise to the *exo* adduct, and so polar solvents should

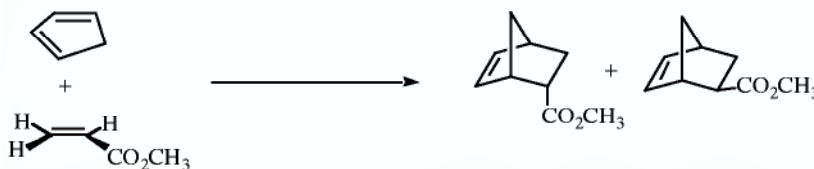
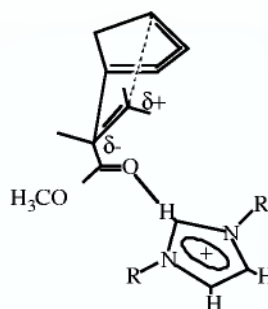

Figure 3.5-2: Diels–Alder cycloaddition between cyclopentadiene and methyl acrylate.

**Figure 3.5-3:** The hydrogen bond (Lewis acid) interaction of an imidazolium cation with the carbonyl oxygen of methyl acrylate in the activated complex of the Diels-Alder reaction.



favour the formation of the *endo* adduct in a kinetically controlled reaction. Alternative explanations, based on solvophobic interactions, have been advanced to explain the behavior of this reaction in water [27]. However, it has been shown that, at least in ionic liquids, the *endo/exo* ratio is controlled by the ability of the solvent to hydrogen-bond to the solute (Figure 3.5-3). Again, it was shown that the effect results from competition between the hydrogen bond acceptor sites of the methyl acrylate and the ionic liquid (anion) for the hydrogen bond donor site of the ionic liquid (cation). Clearly, in this case, the chemical natures of the ions of the ionic liquid are dominant in determining the outcome of the reaction, rather than the ionic nature of the medium itself.

### 3.5.5.3 Photochemical reactions

Radiolysis of solutions of  $\text{CCl}_4$  and  $\text{O}_2$  in [BMIM][PF<sub>6</sub>] results in the formation of  $\text{CCl}_3\text{O}_2^{\cdot}$  radicals [28]. These have then been allowed to react with the organic reductant chlorpromazine (ClPz) according to Equation (3.5-3):



This reaction has been investigated in a range of molecular solvents, and the rate constants have been correlated with the Hildebrand solubility parameter ( $\delta_{\text{H}}$ ). The  $\delta_{\text{H}}$  parameter is derived from the molar energy of vaporization of the solvent (clearly it is not possible to measure an energy of vaporization for a nonvolatile ionic liquid) and is a measure of the work required to create a cavity of the size of the solvent molecules in the solvent, with contributions from all of the possible nonspecific interactions between the solvent molecules. It does not take into account any interaction between the solvent and any potential solute. However, in these fast reactions, the reacting species would not be in equilibrium with their surroundings throughout the reaction process. Hence, direct solute–solvent interactions might be expected to play a secondary role in controlling the rate of the reaction and the ability of the solvent to reorganize itself to accommodate the activated complex of the reaction would become predominant. The second order rate constant for the reaction was found to lie between those of isopropanol and *tert*-butanol.

## 3.5.6

**General Conclusions**

To date, most studies of ionic liquids have used a small set of ionic liquids and have been based on the idea that, if the response of a particular probe molecule or reaction is like that in some known molecular solvent, then it can be said that the polarities of the ionic liquid and the molecular solvent are the same. This may not necessarily be the case. Only systematic investigations will show whether this is true, and only when a wide range of ionic liquids with a wide range of different solvent polarity probes have been studied will we be able to make any truly general statements about the polarity of ionic liquids. Indeed, in our attempts to understand the nature of solvent effects in ionic liquids, we will probably have to refine our notion of polarity itself. However, it is possible to draw some tentative general conclusions.

Not all ionic liquids are the same, different combinations of anions and cations produce solvents with different polarities. No ionic liquids have shown themselves to be “super-polar”; regardless of the method used to assess their polarities, ionic liquids come within the range of molecular solvents. Most general measures of overall polarity place ionic liquids in the range of the short- to medium-chain alcohols.

It becomes more interesting when the solvent properties are broken down into their component parts. Ionic liquids can act as hydrogen bond acids and/or hydrogen bond bases, or as neither. Generally, the hydrogen bond basicity is determined by the anion and the hydrogen bond acidity is determined by the cation. There is no obvious unique “ionic effect” to be seen in the available data, but this may yet be found after further study and might explain the consistently high  $\pi^*$  values (spectroscopic) and  $s$  values (chromatographic), where they have been measured [13].

**References**

- 1 C. Reichardt, “Solvents and Solvent Effects in Organic Chemistry”, 2<sup>nd</sup> ed., VCH, Weinheim, 1990.
- 2 M. Berthelot, L. Péan de Saint-Giles, *Ann. Chim. Et Phys.*, 3 Ser. **1862**, 65, 385; **1862** 66, 5; **1863**, 68, 255.
- 3 L. Claisen, *Liebigs Ann. Chem.* **1896**, 291, 25; W. Wislicenus, *Liebigs Ann. Chem.* **1896**, 291, 147; L. Knorr, *Liebigs Ann. Chem.* **1896**, 293, 70.
- 4 H. Stobbe, *Liebigs Ann. Chem.* **1903**, 326, 347.
- 5 S. K. Poole, C. F. Poole, *Analyst* **1995**, 120, 289 and references therein.
- 6 M. H. Abraham, *Chem. Soc. Rev.* **1993**, 73.
- 7 F. Pacholec, H. Butler, C. F. Poole, *Anal. Chem.*, **1982**, 54, 1938.
- 8 C. F. Poole, K. G. Furton, B. R. Kersten, *J. Chromatogr. Sci.*, **1986**, 24, 400.
- 9 M. E. Coddens, K. G. Furton, C. F. Poole, *J. Chromatogr.*, **1986**, 356, 59.
- 10 D. W. Armstrong, L. He, Y.-S. Liu, *Anal. Chem.*, **1999**, 71, 3873.
- 11 C. Reichardt, *Chem. Soc. Rev.* **1992**, 147.
- 12 R. W. Taft, M. J. Kamlet, *J. Am. Chem. Soc.* **1976**, 98, 2886.



- 13 S. K. Poole, P. H. Shetty, C. F. Poole, *Anal. Chim. Acta* **1989**, *218*, 241.
- 14 I. M. Herfort, H. Schneider, *Liebigs Ann. Chem.* **1991**, *27*.
- 15 M. J. Muldoon, C. M. Gordon, I. R. Dunkin, *J. Chem. Soc., Perkin Trans. 2* **2001**, 433.
- 16 J. G. Huddleston, G. A. Broker, H. D. Willauer, R. D. Rogers, in "Green (or greener) industrial applications of ionic liquids.", ACS Symposium Series, in press.
- 17 K. W. Street, Jr., W. E. Acree, Jr., J. C. Fetzer, P. H. Shetty, C. F. Poole, *Appl. Spectrosc.*, **1989**, *43*, 1149.
- 18 P. Bonhôte, A.-P. Dias, N. Papageorgiou, K. Kalyanasundaram, M. Grätzel, *Inorg. Chem.*, **1996**, *35*, 1168.
- 19 S. N. Baker, G. A. Baker, M. A. Kane, F. V. Bright, *J. Phys. Chem. B*, **2001**, *105*, 9663.
- 20 D. C. Dong, M. A. Winnik, *Can. J. Chem.* **1984**, *62*, 2560.
- 21 J. Catalán, *J. Org. Chem.*, **1997**, *62*, 8231.
- 22 S. N. V. K. Aki, J. F. Brennecke, A. Samanta, *Chem. Commun.* **2001**, 413.
- 23 C. F. Poole, B. R. Kersten, S. S. J. Ho, M. E. Coddens, K. G. Furton, *J. Chromatogr.* **1986**, *352*, 407.
- 24 M. Badri, J.-J. Brunet, R. Perron, *Tetrahedron Lett.* **1992**, *33*, 4435.
- 25 M. J. Earle, P. B. McCormac, K. R. Seddon, *J. Chem. Soc., Chem. Commun.* **1998**, 2245.
- 26 (a) A. Sethi, T. Welton, J. Wolff, *Tetrahedron Lett.*, **1999**, *40*, 793; (b) A. Sethi, T. Welton, in "Green (or greener) industrial applications of ionic liquids.", ACS Symposium Series, in press.
- 27 R. Breslow, *Acc. Chem. Res.*, **1991**, *24*, 159.
- 28 D. Behar, C. Gonzalez, P. Neta, *J. Phys. Chem. A* **2001**, *105*, 7607.

### 3.6

#### Electrochemical Properties of Ionic Liquids

*Paul C. Trulove and Robert A. Mantz*

The early history of ionic liquid research was dominated by their application as electrochemical solvents. One of the first recognized uses of ionic liquids was as a solvent system for the room-temperature electrodeposition of aluminium [1]. In addition, much of the initial development of ionic liquids was focused on their use as electrolytes for battery and capacitor applications. Electrochemical studies in the ionic liquids have until recently been dominated by work in the room-temperature haloaluminate molten salts. This work has been extensively reviewed [2–9]. Development of non-haloaluminate ionic liquids over the past ten years has resulted in an explosion of research in these systems. However, recent reviews have provided only a cursory look at the application of these "new" ionic liquids as electrochemical solvents [10, 11].

Ionic liquids possess a variety of properties that make them desirable as solvents for investigation of electrochemical processes. They often have wide electrochemical potential windows, they have reasonably good electrical conductivity and solvent transport properties, they have wide liquid ranges, and they are able to solvate a wide variety of inorganic, organic, and organometallic species. The liquid ranges of ionic liquids have been discussed in Section 3.1 and their solubility and solvation in

Section 3.3. In this section we deal specifically with the electrochemical properties of ionic liquids (electrochemical windows, conductivity, and transport properties); we will discuss the techniques involved in measuring these properties, summarize the relevant literature data, and discuss the effects of ionic liquid components and purity on their electrochemical properties.

### 3.6.1

#### Electrochemical Potential Windows

A key criterion for selection of a solvent for electrochemical studies is the electrochemical stability of the solvent [12]. This is most clearly manifested by the range of voltages over which the solvent is electrochemically inert. This useful electrochemical potential “window” depends on the oxidative and reductive stability of the solvent. In the case of ionic liquids, the potential window depends primarily on the resistance of the cation to reduction and the resistance of the anion to oxidation. (A notable exception to this is in the acidic chloroaluminate ionic liquids, where the reduction of the heptachloroaluminate species  $[\text{Al}_2\text{Cl}_7]^-$  is the limiting cathodic process). In addition, the presence of impurities can play an important role in limiting the potential windows of ionic liquids.

The most common method used for determining the potential window of an ionic liquid is cyclic voltammetry (or its digital analogue, cyclic staircase voltammetry). In a three-electrode system, the potential of an inert working electrode is scanned out to successively greater positive (anodic) and negative (cathodic) potentials until background currents rise dramatically due to oxidation and reduction of the ionic liquid, respectively. The oxidative and reductive potential limits are assigned when the background current reaches a threshold value. The electrochemical potential window is the difference between these anodic and cathodic potential limits. Since the choice of the threshold currents is somewhat subjective, the potential limits and corresponding electrochemical window have a significant uncertainty associated with them. Normally this is in the range of  $\pm 0.2$  V.

It must be noted that impurities in the ionic liquids can have a profound impact on the potential limits and the corresponding electrochemical window. During the synthesis of many of the non-haloaluminate ionic liquids, residual halide and water may remain in the final product [13]. Halide ions ( $\text{Cl}^-$ ,  $\text{Br}^-$ ,  $\text{I}^-$ ) are more easily oxidized than the fluorine-containing anions used in most non-haloaluminate ionic liquids. Consequently, the observed anodic potential limit can be appreciably reduced if significant concentrations of halide ions are present. Contamination of an ionic liquid with significant amounts of water can affect both the anodic and the cathodic potential limits, as water can be both reduced and oxidized in the potential limits of many ionic liquids. Recent work by Schröder et al. demonstrated considerable reduction in both the anodic and cathodic limits of several ionic liquids upon the addition of 3 % water (by weight) [14]. For example, the electrochemical window of ‘dry’  $[\text{BMIM}][\text{BF}_4]$  was found to be 4.10 V, while that for the ionic liquid with 3 % water by weight was reduced to 1.95 V. In addition to its electrochemistry, water can react with the ionic liquid components (especially anions) to produce products

that are electroactive in the electrochemical potential window. This has been well documented in the chloroaluminate ionic liquids, in which water will react to produce electroactive proton-containing species (e.g., HCl and  $[\text{HCl}_2]^-$ ) [4, 9]. In addition, water appears to react with some of the anions commonly used in the non-haloaluminate ionic liquids [15]. The  $[\text{PF}_6]^-$  anion, for example, is known to react with water to form HF [16, 17].

Glassy carbon (GC), platinum (Pt), and tungsten (W) are the most common working electrodes used to evaluate electrochemical windows in ionic liquids. The choice of the working electrode has some impact on the overall electrochemical window measured. This is due to the effect of the electrode material on the irreversible electrode reactions that take place at the oxidative and reductive limits. For example, W gives a 0.1 to 0.2 V greater oxidative limit for  $[\text{EMIM}]\text{Cl}/\text{AlCl}_3$  ionic liquids than Pt, due to a greater overpotential for the oxidation of the chloroaluminate anions [18]. In addition, GC (and to a lesser extent W) exhibits a large overpotential for proton reduction. Under normal circumstances, the electrochemistry of protonic impurities (i.e., water) will not be observed in the ionic liquid electrochemical window with GC. Pt, on the other hand, exhibits good electrochemical behavior for proton. Consequently, protonic impurities will give rise to a reduction wave(s) at Pt positive of the cathodic potential limit. Interestingly, comparison of the background electrochemical behavior of an ionic liquid at both Pt and GC working electrodes can be an excellent qualitative tool for determining if significant amounts of protonic impurities are present.

Figure 3.6-1 shows the electrochemical window of a 76–24 mol %  $[\text{BMMIM}][(\text{CF}_3\text{SO}_2)_2\text{N}]/\text{Li}[(\text{CF}_3\text{SO}_2)_2\text{N}]$  binary melt at both GC and Pt working electrodes [15]. For the purposes of assessing the electrochemical window, the current threshold for both the anodic and cathodic limits was set at an absolute value of  $100 \mu\text{A cm}^{-2}$ .

**Figure 3.6-1:** The electrochemical window of 76–24 mol %  $[\text{BMMIM}][(\text{CF}_3\text{SO}_2)_2\text{N}]/\text{Li}[(\text{CF}_3\text{SO}_2)_2\text{N}]$  binary melt at: a) a platinum working electrode (solid line), and b) a glassy carbon working electrode (dashed line). Electrochemical window set at a threshold of  $0.1 \text{ mA cm}^{-2}$ . The reference electrode was a silver wire immersed in  $0.01 \text{ M AgBF}_4$  in  $[\text{EMIM}][\text{BF}_4]$  in a compartment separated by a Vicor frit, and the counter-electrode was a graphite rod.

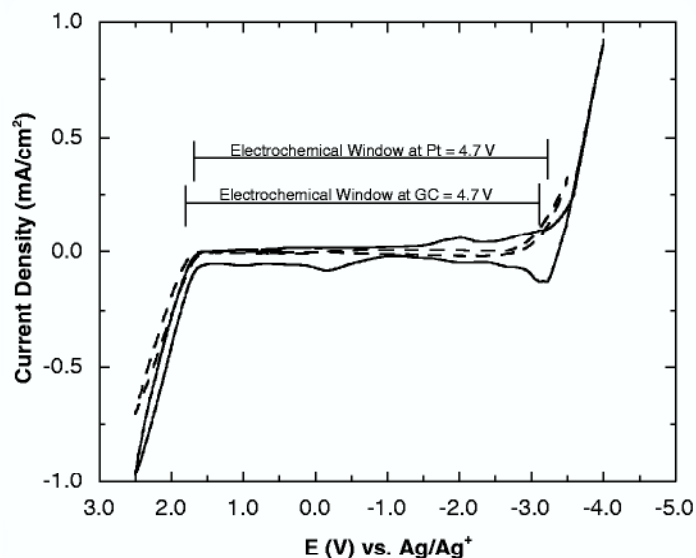

**Table 3.6-1:** The room-temperature electrochemical potential windows for non-haloaluminate ionic liquids.

Cation	Anion(s)	Working electrode <sup>c</sup>	Window (V)	Ref.
<i>Ammonium</i>				
[( <i>n</i> -C <sub>3</sub> H <sub>7</sub> )(CH <sub>3</sub> ) <sub>3</sub> N] <sup>+</sup>	[(CF <sub>3</sub> SO <sub>2</sub> ) <sub>2</sub> N] <sup>-</sup>	GC	5.7	19 <sup>a</sup>
[( <i>n</i> -C <sub>6</sub> H <sub>13</sub> )(C <sub>2</sub> H <sub>5</sub> ) <sub>3</sub> N] <sup>+</sup>	[(CF <sub>3</sub> SO <sub>2</sub> ) <sub>2</sub> N] <sup>-</sup>	GC	4.5 <sup>b</sup>	20
[( <i>n</i> -C <sub>8</sub> H <sub>17</sub> )(C <sub>2</sub> H <sub>5</sub> ) <sub>3</sub> N] <sup>+</sup>	[(CF <sub>3</sub> SO <sub>2</sub> ) <sub>2</sub> N] <sup>-</sup>	GC	5.0	20
[( <i>n</i> -C <sub>8</sub> H <sub>17</sub> )(C <sub>4</sub> H <sub>9</sub> ) <sub>3</sub> N] <sup>+</sup>	[(CF <sub>3</sub> SO <sub>2</sub> ) <sub>2</sub> N] <sup>-</sup>	GC	5.0	20
[(CH <sub>3</sub> ) <sub>3</sub> (CH <sub>3</sub> OCH <sub>2</sub> )N] <sup>+</sup>	[(CF <sub>3</sub> SO <sub>2</sub> ) <sub>2</sub> N] <sup>-</sup>	GC	5.2	19 <sup>a</sup>
1-butyl-1-methyl-pyrrolidinium	[(CF <sub>3</sub> SO <sub>2</sub> ) <sub>2</sub> N] <sup>-</sup>	GC	5.5	21
<i>Imidazolium</i>				
[EMIM] <sup>+</sup>	F <sup>-</sup>	Pt	3.1	22 <sup>a</sup>
[EMIM] <sup>+</sup>	[BF <sub>4</sub> ] <sup>-</sup>	Pt	4.3	23 <sup>a</sup>
[EMIM] <sup>+</sup>	[BF <sub>4</sub> ] <sup>-</sup>	Pt	4.5	24
[EMIM] <sup>+</sup>	[CH <sub>3</sub> CO <sub>2</sub> ] <sup>-</sup>	Pt	3.6	25 <sup>a</sup>
[EMIM] <sup>+</sup>	[CF <sub>3</sub> CO <sub>2</sub> ] <sup>-</sup>	Pt	3.8 <sup>b</sup>	26 <sup>a</sup>
[EMIM] <sup>+</sup>	[CF <sub>3</sub> SO <sub>3</sub> ] <sup>-</sup>	Pt	4.1	26 <sup>a</sup>
[EMIM] <sup>+</sup>	[CF <sub>3</sub> SO <sub>3</sub> ] <sup>-</sup>	Pt	4.3	25 <sup>a</sup>
[EMIM] <sup>+</sup>	[(CF <sub>3</sub> SO <sub>2</sub> ) <sub>2</sub> N] <sup>-</sup>	GC	4.1	27
[EMIM] <sup>+</sup>	[(CF <sub>3</sub> SO <sub>2</sub> ) <sub>2</sub> N] <sup>-</sup>	Pt	4.5	26 <sup>a</sup>
[EMIM] <sup>+</sup>	[(CF <sub>3</sub> SO <sub>2</sub> ) <sub>2</sub> N] <sup>-</sup>	GC	4.5	19 <sup>a</sup>
[EMIM] <sup>+</sup>	(C <sub>2</sub> F <sub>5</sub> SO <sub>2</sub> ) <sub>2</sub> N <sup>-</sup>	GC	4.1	27
[BMIM] <sup>+</sup>	[BF <sub>4</sub> ] <sup>-</sup>	Pt	4.1	14
[BMIM] <sup>+</sup>	[PF <sub>6</sub> ] <sup>-</sup>	Pt	4.2	14
[EMMIM] <sup>+</sup>	[(CF <sub>3</sub> SO <sub>2</sub> ) <sub>2</sub> N] <sup>-</sup>	Pt	4.7	26 <sup>a</sup>
[PMMIM] <sup>+</sup>	[(CF <sub>3</sub> SO <sub>2</sub> ) <sub>2</sub> N] <sup>-</sup>	GC	4.3	27
[PMMIM] <sup>+</sup>	[(CF <sub>3</sub> SO <sub>2</sub> ) <sub>2</sub> N] <sup>-</sup>	GC	5.2	28
[PMMIM] <sup>+</sup>	(CF <sub>3</sub> SO <sub>2</sub> ) <sub>3</sub> C <sup>-</sup>	GC	5.4	28
[PMMIM] <sup>+</sup>	[PF <sub>6</sub> ] <sup>-</sup>	GC	4.3 <sup>d</sup>	28 <sup>c</sup>
[PMMIM] <sup>+</sup>	[AsF <sub>6</sub> ] <sup>-</sup>	GC	4.4 <sup>d</sup>	28 <sup>c</sup>
<i>Pyrazolium</i>				
1,2-dimethyl-4-fluoropyrazolium	[BF <sub>4</sub> ] <sup>-</sup>	GC	4.1	29
<i>Pyridinium</i>				
[BP] <sup>+</sup>	[BF <sub>4</sub> ] <sup>-</sup>	Pt	3.4	23
<i>Sulfonium</i>				
[(C <sub>2</sub> H <sub>5</sub> ) <sub>3</sub> S] <sup>+</sup>	[(CF <sub>3</sub> SO <sub>2</sub> ) <sub>2</sub> N] <sup>-</sup>	GC	4.7	30
[( <i>n</i> -C <sub>4</sub> H <sub>9</sub> ) <sub>3</sub> S] <sup>+</sup>	[(CF <sub>3</sub> SO <sub>2</sub> ) <sub>2</sub> N] <sup>-</sup>	GC	4.8	30

<sup>a</sup> Voltage window estimated from cyclic voltammograms contained in the reference.<sup>b</sup> Voltage window may be limited by impurities.<sup>c</sup> Working electrode, Pt = platinum, GC = glassy carbon, W = tungsten.<sup>d</sup> Voltage window at 80 °C.<sup>e</sup> Voltage window determined assuming cathodic limit of 0.63 V vs. Li/Li<sup>+</sup> reference.

As shown in Figure 3.6-1, GC and Pt exhibit anodic and cathodic potential limits that differ by several tenths of volts. However, somewhat fortuitously, the electrochemical potential windows for both electrodes in this ionic liquid come out to be 4.7 V. What is also apparent from Figure 3.6-1 is that the GC electrode exhibits no significant background currents until the anodic and cathodic potential limits are reached, while the Pt working electrode shows several significant electrochemical processes prior to the potential limits. This observed difference is most probably due to trace amounts of water in the ionic liquid, which is electrochemically active on Pt but not on GC (vide supra).

Tables 3.6-1 and 3.6-2 contain electrochemical potential windows for a wide variety of ionic liquids. Only limited information concerning the purity of the ionic liquids listed in Tables 3.6-1 and 3.6-2 was available, so these electrochemical potential windows must be treated with caution, as it is likely that many of the ionic liquids would have had residual halides and water present.

Ideally, one would prefer to compare anodic and cathodic potential limits instead of the overall ionic liquid electrochemical window, because difference sets of anodic and cathodic limits can give rise to the same value of electrochemical window (see Figure 3.6-1). However, the lack of a standard reference electrode system within and between ionic liquid systems precludes this possibility. Consequently, significant care must be taken when evaluating the impact of changes in the cation or anion on the overall ionic liquid electrochemical window.

As indicated by the data in Tables 3.6-1 and 3.6-2, the trend in the electrochemical stabilities of the types of ionic liquid cations is: pyridinium < pyrazolium  $\leq$  imidazolium  $\leq$  sulfonium  $\leq$  ammonium. Overall, the quaternary ammonium-based ionic liquids are the potential window champs [36], the  $[(n\text{-C}_3\text{H}_7)(\text{CH}_3)_3\text{N}][(\text{CF}_3\text{SO}_2)_2\text{N}]$  ionic liquid exhibiting the largest electrochemical window, of 5.7 V, at GC [19]. (For comparison, one of the best non-aqueous electrolyte systems, acetonitrile/tetrabutylammonium hexafluorophosphate, exhibits a potential window of 6.3 V [12]). Because of uncertainties in the purity of the quaternary ammonium-based ionic liquids listed in Table 3.6-1, it is impossible to determine from the data listed what effect changes in the alkyl substituents have on the electrochemical stability of the cation. However, within the group of imidazolium-based ionic liquids there is a clear increase in cation stability when the 2-position on the imidazolium ring is capped by an alkyl substituent, as in [EMMIM]<sup>+</sup>. It has been proposed that the cathodic limiting reactions of imidazolium cations proceed initially by the reduction of ring protons to molecular hydrogen [37]. Since the 2-position on the imidazolium ring is the most acidic hydrogen [38], it is reasonable to conclude that substitution of an alkyl substituent at that position would result in an improvement in the reductive stability of the imidazolium cation. From the data in Tables 3.6-1 and 3.6-2, the anion stabilities towards oxidation appear to follow the order: halides ( $\text{Cl}^-$ ,  $\text{F}^-$ ,  $\text{Br}^-$ ) < chloroaluminates ( $[\text{AlCl}_4]^-$ ,  $[\text{Al}_2\text{Cl}_7]^-$ )  $\leq$  fluorinated ions ( $[\text{BF}_4]^-$ ,  $[\text{PF}_6]^-$ ,  $[\text{AsF}_6]^-$ )  $\leq$  triflate/triflyl ions ( $[\text{CF}_3\text{SO}_3]^-$ ,  $[(\text{CF}_3\text{SO}_2)_2\text{N}]^-$ ,  $[(\text{C}_2\text{F}_5\text{SO}_2)_2\text{N}]^-$ ,  $[(\text{CF}_3\text{SO}_2)_3\text{C}]^-$ ).

The electrochemical windows exhibited by the chloroaluminates tend to fall into three ranges that correspond to the types of chloroaluminate ionic liquids: basic,

**Table 3.6-2:** The room-temperature electrochemical potential windows for binary and ternary chloroaluminate and related ionic liquids.

<i>ionic liquid system</i>	<i>Cation(s)</i>	<i>Anion(s)</i>	<i>Working electrode<sup>e</sup></i>	<i>Window (V)</i>	<i>Ref.</i>
60.0–40.0 mol % [EMIM]Cl/AlCl <sub>3</sub>	[EMIM] <sup>+</sup>	[AlCl <sub>4</sub> ] <sup>-</sup> /Cl <sup>-</sup>	W	2.8	31 <sup>a</sup>
50.0–50.0 mol % [EMIM]Cl/AlCl <sub>3</sub>	[EMIM] <sup>+</sup>	[AlCl <sub>4</sub> ] <sup>-</sup>	W	4.4	31 <sup>a</sup>
45.0–55.0 mol % [EMIM]Cl/AlCl <sub>3</sub>	[EMIM] <sup>+</sup>	[Al <sub>2</sub> Cl <sub>7</sub> ] <sup>-</sup> / [AlCl <sub>4</sub> ] <sup>-</sup>	W	2.9	31 <sup>a</sup>
45.0–55.0 mol % [EMIM]Cl/AlCl <sub>3</sub>	[EMIM] <sup>+</sup>	[Al <sub>2</sub> Cl <sub>7</sub> ] <sup>-</sup> / [AlCl <sub>4</sub> ] <sup>-</sup>	W	2.9	31 <sup>a</sup>
60.0–40.0 mol % [PMMIM]Cl/AlCl <sub>3</sub>	[PMMIM] <sup>+</sup>	[AlCl <sub>4</sub> ] <sup>-</sup> /Cl <sup>-</sup>	GC	3.1	15 <sup>a</sup>
50.0–50.0 mol % [PMMIM]Cl/AlCl <sub>3</sub>	[PMMIM] <sup>+</sup>	[AlCl <sub>4</sub> ] <sup>-</sup>	GC	4.6	15 <sup>a</sup>
40.0–60.0 mol % [PMMIM]Cl/AlCl <sub>3</sub>	[PMMIM] <sup>+</sup>	[Al <sub>2</sub> Cl <sub>7</sub> ] <sup>-</sup> / [AlCl <sub>4</sub> ] <sup>-</sup>	GC	2.9	15 <sup>a</sup>
45.5–50.0–4.5 mol % [EMIM]Cl/AlCl <sub>3</sub> /LiCl	[EMIM] <sup>+</sup> /Li <sup>+</sup>	[AlCl <sub>4</sub> ] <sup>-</sup>	W	4.3	32 <sup>a,c</sup>
45.5–50.0–4.5 mol % [EMIM]Cl/AlCl <sub>3</sub> /LiCl	[EMIM] <sup>+</sup> /Li <sup>+</sup>	[AlCl <sub>4</sub> ] <sup>-</sup>	W	4.6	32 <sup>a,c,d</sup>
47.6–50.0–2.4 mol % [EMIM]Cl/AlCl <sub>3</sub> /NaCl	[EMIM] <sup>+</sup> /Na <sup>+</sup>	[AlCl <sub>4</sub> ] <sup>-</sup>	W	4.5	32 <sup>a,c</sup>
47.6–50.0–2.4 mol % [EMIM]Cl/AlCl <sub>3</sub> /NaCl	[EMIM] <sup>+</sup> /Na <sup>+</sup>	[AlCl <sub>4</sub> ] <sup>-</sup>	W	4.6	32 <sup>a,c</sup>
45.5–50.0–4.5 mol % [PMMIM]Cl/AlCl <sub>3</sub> /NaCl	[PMMIM] <sup>+</sup> /Na <sup>+</sup>	[AlCl <sub>4</sub> ] <sup>-</sup>	W	4.6	32 <sup>a,c</sup>
45.5–50.0–4.5 mol % [PMMIM]Cl/AlCl <sub>3</sub> /NaCl	[PMMIM] <sup>+</sup> /Na <sup>+</sup>	[AlCl <sub>4</sub> ] <sup>-</sup>	W	4.7	32 <sup>a,c,d</sup>
50.0–50.0 mol % [BP]Cl/AlCl <sub>3</sub>	[BP] <sup>+</sup>	[AlCl <sub>4</sub> ] <sup>-</sup>	W	3.6	31 <sup>a</sup>
52.0–48.0 mol % [EMIM]Cl/GaCl <sub>3</sub>	[EMIM] <sup>+</sup>	[GaCl <sub>4</sub> ] <sup>-</sup> /Cl <sup>-b</sup>	W	2.4	33 <sup>a</sup>
50.0–50.0 mol % [EMIM]Cl/GaCl <sub>3</sub>	[EMIM] <sup>+</sup>	[GaCl <sub>4</sub> ] <sup>-b</sup>	W	4.0	33 <sup>a</sup>
49.0–51.0 mol % [EMIM]Cl/GaCl <sub>3</sub>	[EMIM] <sup>+</sup>	[Ga <sub>2</sub> Cl <sub>7</sub> ] <sup>-</sup> / [GaCl <sub>4</sub> ] <sup>-b</sup>	W	2.2	33 <sup>a</sup>
52.0–48.0 mol % [BP]Cl/GaCl <sub>3</sub>	[BP] <sup>+</sup>	[GaCl <sub>4</sub> ] <sup>-</sup> /Cl <sup>-b</sup>	W	2.2	33 <sup>a</sup>
50.0–50.0 mol % [BP]Cl/GaCl <sub>3</sub>	[BP] <sup>+</sup>	[GaCl <sub>4</sub> ] <sup>-b</sup>	W	3.7	33 <sup>a</sup>
49.0–51.0 mol % [BP]Cl/GaCl <sub>3</sub>	[BP] <sup>+</sup>	[Ga <sub>2</sub> Cl <sub>7</sub> ] <sup>-</sup> / [GaCl <sub>4</sub> ] <sup>-b</sup>	W	2.2	33 <sup>a</sup>
Basic [(CH <sub>3</sub> ) <sub>2</sub> (C <sub>2</sub> H <sub>5</sub> )(C <sub>2</sub> H <sub>5</sub> OCH <sub>2</sub> )N]Cl/AlCl <sub>3</sub>	[(CH <sub>3</sub> ) <sub>2</sub> (C <sub>2</sub> H <sub>5</sub> )(C <sub>2</sub> H <sub>5</sub> OCH <sub>2</sub> )N] <sup>+</sup>	[AlCl <sub>4</sub> ] <sup>-</sup> /Cl <sup>-</sup>	Pt	3.5	34 <sup>a</sup>
33.0–67.0 mol % [(CH <sub>3</sub> ) <sub>3</sub> S]Cl/AlCl <sub>3</sub>	[(CH <sub>3</sub> ) <sub>3</sub> S] <sup>+</sup>	[Al <sub>2</sub> Cl <sub>7</sub> ] <sup>-</sup> / [AlCl <sub>4</sub> ] <sup>-</sup>	GC	2.5	35 <sup>a</sup>

<sup>a</sup> Voltage window estimated from cyclic voltammograms contained in the reference.<sup>b</sup> The exact nature of the anions is unknown; anions listed are those that would be expected if the system behaved similarly to the chloroaluminates.<sup>c</sup> Voltage window determined assuming anodic limit of 2.4 V vs. Al/Al(III) reference.<sup>d</sup> Small amount of [EMIM][HCl]<sub>2</sub> added.<sup>e</sup> Working electrode, Pt = platinum, GC = glassy carbon, W = tungsten.



neutral, and acidic. Basic ionic liquids contain an excess of the organic chloride salt (> 50 mol %), resulting in the presence of free chloride ion (a Lewis base); this, in turn, significantly restricts the anodic limit of the basic ionic liquids. Acidic ionic liquids are prepared with an excess of the aluminium chloride (organic chloride < 50 mol %), and contain two chloroaluminate species:  $[\text{AlCl}_4]^-$  and  $[\text{Al}_2\text{Cl}_7]^-$  (a Lewis acid). Both anions are significantly more stable towards oxidation than chloride ion. Furthermore, the  $[\text{Al}_2\text{Cl}_7]^-$  is more readily reduced than the organic cation. The acidic ionic liquids thus have a limited cathodic range, but an extended anodic potential range. In the special case in which the organic chloride salt and aluminium chloride are present in equal amounts (50 mol %), these ionic liquids are termed neutral, because they contain only the organic cation and  $[\text{AlCl}_4]^-$ . The neutral chloroaluminate ionic liquids possess the widest electrochemical windows, but they are difficult to prepare and to maintain at the exact neutral composition. A solution to this problem has been developed through the introduction of a third component, an alkali halide, to the chloroaluminate ionic liquids [39]. When an excess of alkali halide (e.g., LiCl, NaCl) is added to an acidic chloroaluminate ionic liquid it dissolves to the extent that it reacts with  $[\text{Al}_2\text{Cl}_7]^-$  ion to produce  $[\text{AlCl}_4]^-$  and the alkali metal cation; this results in an ionic liquid that is essentially neutral, and at that point the alkali halide is no longer soluble. This neutral ionic liquid is “buffered” to the addition either of more  $[\text{Al}_2\text{Cl}_7]^-$  or of organic chloride. Consequently, the buffered neutral ionic liquids possess wide, and stable, electrochemical windows. However, the cathodic limits of the imidazolium-based buffered neutral ionic liquids are not sufficient to obtain reversible alkali metal deposition and stripping. Interestingly, addition of small amounts of proton to the buffered neutral ionic liquids shifts the reduction of the imidazolium cation sufficiently negative such that reversible lithium and sodium deposition and stripping can be obtained [32, 37].

### 3.6.2

#### Ionic Conductivity

The ionic conductivity of a solvent is of critical importance in its selection for an electrochemical application. There are a variety of DC and AC methods available for the measurement of ionic conductivity. In the case of ionic liquids, however, the vast majority of data in the literature have been collected by one of two AC techniques: the impedance bridge method or the complex impedance method [40]. Both of these methods employ simple two-electrode cells to measure the impedance of the ionic liquid ( $Z$ ). This impedance arises from resistive ( $R$ ) and capacitive contributions ( $C$ ), and can be described by Equation (3.6-1):

$$Z = \sqrt{\left(\frac{1}{\omega C}\right)^2 + R^2} \quad (3.6-1)$$

where  $\omega$  is the frequency of the AC modulation. One can see from Equation 3.6-1 that as the AC frequency increases the capacitive contribution to the impedance becomes vanishingly small and Equation 3.6-1 reduces to  $Z = R$ , the resistance

of the ionic liquid in the impedance cell. Under these conditions the conductivity ( $\kappa$ ) of the ionic liquid may be obtained from the measured resistance by Equation 3.6-2:

$$\kappa = \frac{l}{AR} \quad (3.6-2)$$

where  $l$  is the distance between the two electrodes in the impedance cell and  $A$  is the area of the electrodes. The term in  $l/A$  is often referred to as the cell constant and it is normally determined by measuring the conductivity of a standard solution (usually aqueous KCl).

The impedance bridge method employs the AC version of a Wheatstone bridge (i.e., an Impedance Bridge) to measure the unknown cell impedance. Impedance measurements are carried out at a relatively high fixed frequency, normally in the range of a few kHz, in order to minimize the impact of capacitive contribution on the cell impedance. This contribution is often further reduced by increasing the electrode surface area, and correspondingly increasing its capacitance, with a fine deposit of platinum black. The complex impedance method involves the measurement of the cell impedance at frequencies ranging from a few Hz up to several MHz. The impedance data is collected with standard electrochemical impedance hardware (potentiostat/impedance analyzer) and is separated out into its real and imaginary components. These data are then plotted in the form of a Nyquist Plot (imaginary vs. real impedance), and the ionic liquid resistance is taken as the point at which the data crosses the real axis at high frequency.

In general, there appears to be no significant difference between the data collected by either method. There is some evidence that data collected by the bridge method, at lower frequencies, may provide an underestimation of the true conductivity [20, 24], but there is no indication that this error is endemic to the impedance bridge method. The instrumentation for the impedance bridge method, although somewhat specialized, is generally less costly than the instrumentation required by the complex impedance method. However, the complex impedance method has gained popularity in recent years, most probably due to the increased availability of electrochemical impedance hardware.

The conductivity of an electrolyte is a measure of the available charge carriers and their mobility. Superficially, one would expect ionic liquids to possess very high conductivities because they are composed entirely of ions. Unfortunately this is not the case. As a class, ionic liquids possess reasonably good ionic conductivities, comparable to the best non-aqueous solvent/electrolyte systems (up to  $\sim 10 \text{ mS cm}^{-1}$ ). However, they are significantly less conductive than concentrated aqueous electrolytes. The smaller than expected conductivity of ionic liquids can be attributed to the reduction of available charge carriers due to ion pairing and/or ion aggregation, and to the reduced ion mobility resulting from the large ion size found in many ionic liquids.

The conductivity of ionic liquids often exhibits classical linear Arrhenius behavior above room temperature. However, as the temperatures of these ionic liquids approach their glass transition temperatures ( $T_g$ s), the conductivity displays signif-

icant negative deviation from linear behavior. The observed temperature-dependent conductivity behavior is consistent with glass-forming liquids, and is often best described by the empirical Vogel–Tammann–Fulcher (VTF) equation (3.6-3):

$$\kappa = AT^{-1/2}\exp[-B/(T - T_0)] \quad (3.6-3)$$

where  $A$  and  $B$  are constants, and  $T_0$  is the temperature at which the conductivity ( $\kappa$ ) goes to zero [60]. Examples of Arrhenius plots of temperature-dependent conductivity data for three ionic liquids are shown in Figure 3.6-2 [15, 27, 41].

The data in Figure 3.6-2 are also fit to the VTF equation. As can be seen from these data, the change in conductivity with temperature clearly varies depending on the ionic liquid. The conductivity of [EMIM][BF<sub>4</sub>], for example, decreases by a factor of 10 over the 375 to 275 K temperature range, while the conductivity of [PMMIM][(CF<sub>3</sub>SO<sub>2</sub>)<sub>2</sub>N] decreases by a factor of 30 over the same range of temperatures (Figure 3.6-2). The temperature dependence of conductivity of an ionic liquid involves a complex interplay of short- and long-range forces that is strongly impacted by the type and character of the cation and anion. At our current level of understanding it is not possible to predict accurately how the conductivity of a given ionic liquid will vary with temperature [42].

The room temperature conductivity data for a wide variety of ionic liquids are listed in Tables 3.6-3, 3.6-4, and 3.6-5. These tables are organized by the general type of ionic liquid. Table 3.6-3 contains data for imidazolium-based non-haloaluminate alkylimidazolium ionic liquids, Table 3.6-4 data for the haloaluminate ionic liquids, and Table 3.6-5 data for other types of ionic liquids. There are multiple listings for several of the ionic liquids in Tables 3.6-3–3.6-5. These represent measurements by different researchers and have been included to help emphasize the significant vari-

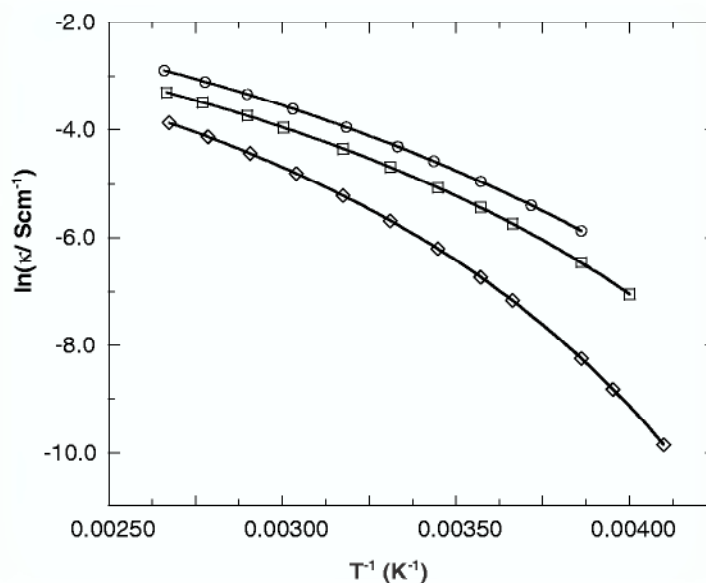

**Figure 3.6-2:** Examples of Arrhenius plots of temperature-dependent conductivity for [EMIM][BF<sub>4</sub>] (○), [EMIM][(CF<sub>3</sub>SO<sub>2</sub>)<sub>2</sub>N] (□), and [PMMIM][(CF<sub>3</sub>SO<sub>2</sub>)<sub>2</sub>N] (◇). The solid lines through each set of data represents the best fit of the data to the VTF equation.

Table 3.6-3: Specific conductivity data for non-haloaluminate alkylimidazolium-based ionic liquids.

Cation	Anion	Temperature (K)	Conductivity ( $\kappa$ ), mS cm <sup>-1</sup>	Conductivity method	Viscosity ( $\eta$ ), cP	Viscosity method	Density ( $\rho$ ), g cm <sup>-3</sup>	Density method	Molar Conductivity ( $\Lambda$ ), cm <sup>2</sup> Ω <sup>-1</sup> mol <sup>-1</sup>	Walden product ( $\Lambda\eta$ )	Ref.
[MMIM] <sup>+</sup>	[(CF <sub>3</sub> SO <sub>2</sub> ) <sub>2</sub> N] <sup>-</sup>	293	8.4	B	44	R	1.559	U	2.03	89.44	26
[EMIM] <sup>+</sup>	[BF <sub>4</sub> ] <sup>-</sup>	295	12	I							43
[EMIM] <sup>+</sup>	[BF <sub>4</sub> ] <sup>-</sup>	298	14	B	34	U	1.240	U	2.24	76.22	24
[EMIM] <sup>+</sup>	[BF <sub>4</sub> ] <sup>-</sup>	298	14	I	32	R	1.279	I	2.17	68.91	41 <sup>a</sup>
[EMIM] <sup>+</sup>	[BF <sub>4</sub> ] <sup>-</sup>	299	13	B	43	R					27
[EMIM] <sup>+</sup>	[BF <sub>4</sub> ] <sup>-</sup>	303	20	I							23
[EMIM] <sup>+</sup>	[PF <sub>6</sub> ] <sup>-</sup>	299	5.2	B							27
[EMIM] <sup>+</sup>	[CH <sub>3</sub> CO <sub>2</sub> ] <sup>-</sup>	293	2.8	B	162	R					26
[EMIM] <sup>+</sup>	[CF <sub>3</sub> CO <sub>2</sub> ] <sup>-</sup>	293	9.6	B	35	R	1.285	U	1.67	58.62	26
[EMIM] <sup>+</sup>	[C <sub>3</sub> F <sub>7</sub> CO <sub>2</sub> ] <sup>-</sup>	293	2.7	B	105	R	1.450	U	0.60	63.39	26
[EMIM] <sup>+</sup>	[CH <sub>3</sub> SO <sub>3</sub> ] <sup>-</sup>	298	2.7	B	160	C	1.240	V	0.45	71.86	25
[EMIM] <sup>+</sup>	[CF <sub>3</sub> SO <sub>3</sub> ] <sup>-</sup>	293	8.6	B	45	R	1.390	U	1.61	72.45	26
[EMIM] <sup>+</sup>	[CF <sub>3</sub> SO <sub>3</sub> ] <sup>-</sup>	298	9.2	B	43	C	1.380	V	1.73	74.08	25
[EMIM] <sup>+</sup>	[CF <sub>3</sub> SO <sub>3</sub> ] <sup>-</sup>	303	8.2	B							44 <sup>b</sup>
[EMIM] <sup>+</sup>	[(CF <sub>3</sub> SO <sub>2</sub> ) <sub>2</sub> N] <sup>-</sup>	293	8.8	B	34	R	1.520	U	2.27	77.03	26
[EMIM] <sup>+</sup>	[(CF <sub>3</sub> SO <sub>2</sub> ) <sub>2</sub> N] <sup>-</sup>	298	5.7	I	31	R	1.518	I	1.47	44.82	41 <sup>a</sup>
[EMIM] <sup>+</sup>	[(CF <sub>3</sub> SO <sub>2</sub> ) <sub>2</sub> N] <sup>-</sup>	303	10	I							44 <sup>a</sup>
[EMIM] <sup>+</sup>	[(CF <sub>3</sub> SO <sub>2</sub> ) <sub>2</sub> N] <sup>-</sup>	298	9.2	B	34	U	1.510	U	2.38	81.06	19
[EMIM] <sup>+</sup>	[(CF <sub>3</sub> SO <sub>2</sub> ) <sub>2</sub> N] <sup>-</sup>	299	8.4	B	28	R					27
[EMIM] <sup>+</sup>	[(C <sub>2</sub> F <sub>5</sub> SO <sub>2</sub> ) <sub>2</sub> N] <sup>-</sup>	299	3.4	B	61	R					27
[EMMIM] <sup>+</sup>	[(CF <sub>3</sub> SO <sub>2</sub> ) <sub>2</sub> N] <sup>-</sup>	293	3.2	B	88	R	1.495	U	0.87	76.35	26
[EMM(5)IM] <sup>+</sup>	[CF <sub>3</sub> SO <sub>3</sub> ] <sup>-</sup>	293	6.4	B	51	R	1.334	U	1.32	67.11	26
[EMM(5)IM] <sup>+</sup>	[(CF <sub>3</sub> SO <sub>2</sub> ) <sub>2</sub> N] <sup>-</sup>	293	6.6	B	37	R	1.470	U	1.82	67.34	26
[PMIM] <sup>+</sup>	[PF <sub>6</sub> ] <sup>-</sup>	293					1.333	V			45
[PMMIM] <sup>+</sup>	[BF <sub>4</sub> ] <sup>-</sup>	295	5.9	I							43
[PMMIM] <sup>+</sup>	[PF <sub>6</sub> ] <sup>-</sup>	308	0.5	B							27
[PMMIM] <sup>+</sup>	[(CF <sub>3</sub> SO <sub>2</sub> ) <sub>2</sub> N] <sup>-</sup>	299	3.0	B	60	R					27



ability in the conductivity data found in the literature. For example, there are five separate listings for the [EMIM][CF<sub>3</sub>SO<sub>2</sub>]<sub>2</sub>N] ionic liquid in Table 3.6-3, with conductivity values ranging from 5.7 to 10.0 mS cm<sup>-1</sup>. Some of these differences may be accountable for by slight differences in experimental temperature, or they could result from measurement error. However, most of this variability is undoubtedly due to impurities in the ionic liquids. Recent work has shown, for example, that contamination with chloride ion increases ionic liquid viscosity, while contamination with water decreases the viscosity [13]. This work has also shown the significant solubility of water in many so-called “hydrophobic” ionic liquids and the strong propensity of these same ionic liquids to absorb water from laboratory air. As can be seen in the discussion below, ionic liquid viscosity is strongly coupled to ionic conductivity. The likelihood that many of the ionic liquids listed in Tables 3.6-3–3.6-5 contained significant concentrations of impurities (especially water) makes evaluation of the literature data difficult. Consequently, any conclusions drawn below must be used with caution. Ionic liquid conductivity appears to be only weakly correlated with the size and type of the cation (Tables 3.6-3–3.6-5). Increasing cation size tends to give rise to lower conductivity, most probably due to the lower mobility of the larger cations.

The overall trend in conductivity with respect to cation type follows the order: imidazolium ≥ sulfonium > ammonium ≥ pyridinium. Interestingly, the correlation between the anion type or size and the ionic liquid conductivity is very limited. Other than the higher conductivities observed for ionic liquids with the [BF<sub>4</sub>]<sup>-</sup> anion, there appears to be no clear relationship between anion size and conductivity. Ionic liquids with large anions such as [(CF<sub>3</sub>SO<sub>2</sub>)<sub>2</sub>N]<sup>-</sup>, for example, often exhibit higher conductivities than those with smaller anions, such as [CH<sub>3</sub>CO<sub>2</sub>]<sup>-</sup>.

The conductivity and viscosity of an ionic liquid is often combined into what is termed Walden’s rule [Equation (3.6-4)] [54],

$$\Lambda\eta = \text{constant} \quad (3.6-4)$$

where  $\Lambda$  is the molar conductivity of the ionic liquid, and it is given by Equation (3.6-5)

$$\Lambda = \kappa M/\rho \quad (3.6-5)$$

where  $M$  is the equivalent weight (molecular weight) of the ionic liquid and  $\rho$  is the ionic liquid density. Ideally, the Walden Product ( $\Lambda\eta$ ) remains constant for a given ionic liquid regardless of temperature. The magnitude of the Walden Product for different ionic liquids has been shown to vary inversely with ion size [27, 54]. This inverse relationship between ion size and the magnitude of  $\Lambda\eta$  is generally followed for the cations in Tables 3.6-3–3.6-5. The clearest example of this can be seen for the sulfonium ionic liquids, in which increasing cation size from [(CH<sub>3</sub>)<sub>3</sub>S]<sup>+</sup>, [(C<sub>2</sub>H<sub>5</sub>)<sub>3</sub>S]<sup>+</sup>, and [(*n*-C<sub>4</sub>H<sub>9</sub>)<sub>3</sub>S]<sup>+</sup> results in Walden products of 81.59, 58.27, and 39.36, respectively. As was the case with conductivity, the size of the anions in Tables 3.6-3–3.6-5 exhibits no clear correlation to the magnitude of the Walden product.



Table 3.6-4: Specific conductivity data for binary haloaluminate ionic liquids.

Ionic liquid system	Cation	Anion(s)	Temperature (K)	Conductivity ( $\kappa$ ), $\text{mS cm}^{-1}$	Conductivity method	Viscosity ( $\eta$ ), cP	Viscosity method	Density ( $\rho$ ), $\text{g cm}^{-3}$	Density method	Molar Conductivity ( $\Lambda$ ), $\text{cm}^2 \Omega^{-1} \text{mol}^{-1}$	Walden product ( $\Lambda \eta$ )	Ref.
34.0–66.0 mol % [MMIM][Cl]/AlCl <sub>3</sub>	[MMIM] <sup>+</sup>	[Al <sub>2</sub> Cl <sub>7</sub> ] <sup>-</sup>	298	15.0	B	17	C	1.404	P	4.26	72.07	48 <sup>a</sup>
34.0–66.0 mol % [EMIM][Cl]/AlCl <sub>3</sub>	[EMIM] <sup>+</sup>	[Al <sub>2</sub> Cl <sub>7</sub> ] <sup>-</sup>	298	15.0	B	14	C	1.389	P	4.46	62.95	48 <sup>a</sup>
50.0–50.0 mol % [EMIM][Cl]/AlCl <sub>3</sub>	[EMIM] <sup>+</sup>	[AlCl <sub>4</sub> ] <sup>-</sup>	298	23.0	B	18	C	1.294	P	4.98	89.07	48 <sup>a</sup>
60.0–40.0 mol % [EMIM][Cl]/AlCl <sub>3</sub>	[EMIM] <sup>+</sup>	Cl <sup>-</sup> , [AlCl <sub>4</sub> ] <sup>-</sup>	298	6.5	B	47	C	1.256	P	1.22	57.77	48 <sup>a</sup>
34.0–66.0 mol % [EMIM][Br]/AlBr <sub>3</sub>	[EMIM] <sup>+</sup>	[Al <sub>2</sub> Br <sub>7</sub> ] <sup>-</sup>	298	5.8	B	32	C	2.219	P	1.89	59.64	49 <sup>ab</sup>
60.0–40.0 mol % [EMIM][Br]/AlBr <sub>3</sub>	[EMIM] <sup>+</sup>	Br <sup>-</sup> , [AlBr <sub>4</sub> ] <sup>-</sup>	298	5.7	B	67	C	1.828	P	1.15	76.72	49 <sup>ab</sup>
40.0–60.0 mol % [PMIM][Cl]/AlCl <sub>3</sub>	[PMIM] <sup>+</sup>	[AlCl <sub>4</sub> ] <sup>-</sup> , [Al <sub>2</sub> Cl <sub>7</sub> ] <sup>-</sup>	298	11.0	B	18	C	1.351	P	2.94	53.44	48 <sup>a</sup>
50.0–50.0 mol % [PMIM][Cl]/AlCl <sub>3</sub>	[PMIM] <sup>+</sup>	[AlCl <sub>4</sub> ] <sup>-</sup>	298	12.0	B	27	C	1.262	P	2.79	76.29	48 <sup>a</sup>
60.0–40.0 mol % [PMIM][Cl]/AlCl <sub>3</sub>	[PMIM] <sup>+</sup>	Cl <sup>-</sup> , [AlCl <sub>4</sub> ] <sup>-</sup>	298	3.3	B		C		P			48 <sup>a</sup>
34.0–66.0 mol % [BMIM][Cl]/AlCl <sub>3</sub>	[BMIM] <sup>+</sup>	[Al <sub>2</sub> Cl <sub>7</sub> ] <sup>-</sup>	298	9.2	B	19	C	1.334	P	3.04	58.45	48 <sup>a</sup>
50.0–50.0 mol % [BMIM][Cl]/AlCl <sub>3</sub>	[BMIM] <sup>+</sup>	[AlCl <sub>4</sub> ] <sup>-</sup>	298	10.0	B	27	C	1.238	P	2.49	67.42	48 <sup>a</sup>
34.0–66.0 mol % [BBIM][Cl]/AlCl <sub>3</sub>	[BBIM] <sup>+</sup>	[Al <sub>2</sub> Cl <sub>7</sub> ] <sup>-</sup>	298	6.0	B	24	C	1.252	P	2.32	55.36	48 <sup>a</sup>
50.0–50.0 mol % [BBIM][Cl]/AlCl <sub>3</sub>	[BBIM] <sup>+</sup>	[AlCl <sub>4</sub> ] <sup>-</sup>	298	5.0	B	38	C	1.164	P	1.50	56.83	48 <sup>a</sup>
33.3–66.7 mol % [MP][Cl]/AlCl <sub>3</sub>	[MP] <sup>+</sup>	[Al <sub>2</sub> Cl <sub>7</sub> ] <sup>-</sup>	298	8.1	B	21	C	1.441	P	2.23	46.12	50 <sup>a</sup>
33.3–66.7 mol % [EP][Cl]/AlCl <sub>3</sub>	[EP] <sup>+</sup>	[Al <sub>2</sub> Cl <sub>7</sub> ] <sup>-</sup>	298	10.0	B	18	C	1.408	P	2.91	51.29	50 <sup>a</sup>
33.3–66.7 mol % [EP][Br]/AlCl <sub>3</sub>	[EP] <sup>+</sup>	[Al <sub>2</sub> Cl <sub>x</sub> Br <sub>7-x</sub> ] <sup>-</sup>	298	8.4	B	22	C	1.524	P			50 <sup>a</sup>
33.3–66.7 mol % [EP][Br]/AlCl <sub>3</sub>	[EP] <sup>+</sup>	[Al <sub>2</sub> Cl <sub>x</sub> Br <sub>7-x</sub> ] <sup>-</sup>	298	17.0	B	25	C		P			51
33.3–66.7 mol % [EP][Br]/AlBr <sub>3</sub>	[EP] <sup>+</sup>	[Al <sub>2</sub> Br <sub>7</sub> ] <sup>-</sup>	298	8.0	B	50	C	2.20	V	2.47	44.93	50 <sup>b</sup>
33.3–66.7 mol % [PP][Cl]/AlCl <sub>3</sub>	[PP] <sup>+</sup>	[Al <sub>2</sub> Cl <sub>7</sub> ] <sup>-</sup>	298	8.0	B	18	C	1.375	P			50 <sup>b</sup>
33.3–66.7 mol % [BP][Cl]/AlCl <sub>3</sub>	[BP] <sup>+</sup>	[Al <sub>2</sub> Cl <sub>7</sub> ] <sup>-</sup>	298	6.7	B	21	C	1.346	P	2.18	45.81	50 <sup>b</sup>

I = complex impedance, B = conductivity bridge, C = capillary viscometer, P = pycnometer or dilatometer, V = volumetric glassware, I = instrument, U = method unknown (not provided in the reference).

<sup>a</sup> Conductivity at 298K calculated from least-squares-fitted parameters given in reference.

<sup>b</sup> Conductivity estimated from graphical data provided in the reference.

Table 3.6-5: Specific conductivity data for other room-temperature ionic liquids.

Cation	Anion	Temperature (K)	Conductivity ( $\kappa$ ), mS cm <sup>-1</sup>	Conductivity method	Viscosity ( $\eta$ ), cP	Viscosity method	Density ( $\rho$ ), g cm <sup>-3</sup>	Density method	Molar Conductivity ( $\Lambda$ ), cm <sup>2</sup> $\Omega^{-1}$ mol <sup>-1</sup>	Walden product ( $\Lambda\eta$ )	Ref.
<b>Ammonium</b>											
[(CH <sub>3</sub> ) <sub>2</sub> (C <sub>2</sub> H <sub>5</sub> )(CH <sub>3</sub> OC <sub>2</sub> H <sub>4</sub> )N] <sup>+</sup>	[BF <sub>4</sub> ] <sup>-</sup>	298	1.7	B							53
[( <i>m</i> -C <sub>3</sub> H <sub>7</sub> )(CH <sub>3</sub> ) <sub>2</sub> N] <sup>+</sup>	[(CF <sub>3</sub> SO <sub>2</sub> ) <sub>2</sub> N] <sup>-</sup>	298	3.3	B	72	U	1.440	U	0.88	63.09	19
[( <i>m</i> -C <sub>8</sub> H <sub>13</sub> )(C <sub>2</sub> H <sub>5</sub> ) <sub>3</sub> N] <sup>+</sup>	[(CF <sub>3</sub> SO <sub>2</sub> ) <sub>2</sub> N] <sup>-</sup>	298	0.67	I	167	C	1.270	V	0.25	41.10	20
[( <i>m</i> -C <sub>8</sub> H <sub>17</sub> )(C <sub>2</sub> H <sub>5</sub> ) <sub>3</sub> N] <sup>+</sup>	[(CF <sub>3</sub> SO <sub>2</sub> ) <sub>2</sub> N] <sup>-</sup>	298	0.33	I	202	C	1.250	V	0.13	26.37	20
[( <i>m</i> -C <sub>8</sub> H <sub>17</sub> )(C <sub>4</sub> H <sub>9</sub> ) <sub>3</sub> N] <sup>+</sup>	[(CF <sub>3</sub> SO <sub>2</sub> ) <sub>2</sub> N] <sup>-</sup>	298	0.13	I	574	C	1.120	V	0.07	38.56	20
[(CH <sub>3</sub> ) <sub>3</sub> (CH <sub>3</sub> OCH <sub>2</sub> ) <sub>2</sub> N] <sup>+</sup>	[(CF <sub>3</sub> SO <sub>2</sub> ) <sub>2</sub> N] <sup>-</sup>	298	4.7	B	50	U	1.510	U	1.20	59.81	19
1-propyl-1-methyl-pyrrolidinium	[(CF <sub>3</sub> SO <sub>2</sub> ) <sub>2</sub> N] <sup>-</sup>	298	1.4	B	63	C	1.45	V			21
1-butyl-1-methyl-pyrrolidinium	[(CF <sub>3</sub> SO <sub>2</sub> ) <sub>2</sub> N] <sup>-</sup>	298	2.2	B	85	C	1.41	V			21
<b>Pyrazolium</b>											
1,2-dimethyl-4-fluoropyrazolium	[BF <sub>4</sub> ] <sup>-</sup>	298	1.3	B							29
<b>Pyridinium</b>											
[BP] <sup>+</sup>	[BF <sub>4</sub> ] <sup>-</sup>	298	1.9	I	103	R	1.220	I	0.35	35.77	41 <sup>a</sup>
[BP] <sup>+</sup>	[BF <sub>4</sub> ] <sup>-</sup>	303	3.0	I							23
[BP] <sup>+</sup>	[(CF <sub>3</sub> SO <sub>2</sub> ) <sub>2</sub> N] <sup>-</sup>	298	2.2	I	57	R	1.449	I	0.63	35.91	41 <sup>a</sup>
<b>Sulfonium</b>											
[(CH <sub>3</sub> ) <sub>3</sub> S] <sup>+</sup>	[HBr] <sup>-</sup>	298	34	B	20.5	C	1.74	P	4.62	95.33	52
[(CH <sub>3</sub> ) <sub>3</sub> S] <sup>+</sup> <sup>b</sup>	[HBr] <sup>-</sup> , [H <sub>2</sub> Br <sub>3</sub> ] <sup>-</sup>	298	56	B	8.3	C	1.79	P	8.41	69.80	52
[(CH <sub>3</sub> ) <sub>3</sub> S] <sup>+</sup>	[Al <sub>2</sub> Cl <sub>7</sub> ] <sup>-</sup>	298	5.5	B							35
[(CH <sub>3</sub> ) <sub>3</sub> S] <sup>+</sup>	[Al <sub>2</sub> Cl <sub>7</sub> ] <sup>-</sup>	298	5.5	B	39.3	C	1.40	V	1.49	58.56	52
[(CH <sub>3</sub> ) <sub>3</sub> S] <sup>+</sup>	[Al <sub>2</sub> Cl <sub>6</sub> Br] <sup>-</sup>	298	4.21	B	54.9	C	1.59	V	1.12	61.60	52
[(CH <sub>3</sub> ) <sub>3</sub> S] <sup>+</sup>	[Al <sub>2</sub> Br <sub>7</sub> ] <sup>-</sup>	298	1.44	B	138	C	2.40	V	0.41	57.17	52
[(CH <sub>3</sub> ) <sub>3</sub> S] <sup>+</sup>	[(CF <sub>3</sub> SO <sub>2</sub> ) <sub>2</sub> N] <sup>-</sup>	318	8.2	B	44	U	1.580	U	1.85	81.59	30
[(C <sub>2</sub> H <sub>5</sub> ) <sub>3</sub> S] <sup>+</sup>	[(CF <sub>3</sub> SO <sub>2</sub> ) <sub>2</sub> N] <sup>-</sup>	298	7.1	B	30	U	1.460	U	1.94	58.27	30
[( <i>m</i> -C <sub>4</sub> H <sub>9</sub> ) <sub>3</sub> S] <sup>+</sup>	[(CF <sub>3</sub> SO <sub>2</sub> ) <sub>2</sub> N] <sup>-</sup>	298	1.4	B	75	U	1.290	U	0.52	39.36	30
<b>Thiazolium</b>											
1-ethylthiazolium	[CF <sub>3</sub> SO <sub>3</sub> ] <sup>-</sup>	298	4.2	B			1.50	V			25

I = complex impedance, B = conductivity bridge, C = capillary viscometer, P = pycnometer or dilatometer, V = volumetric glassware, I = instrument, U = method unknown (not provided in the reference). <sup>a</sup> Conductivity at 298 K calculated from VTF parameters given in reference. <sup>b</sup> Binary composition of 42.0–58.0 mol % [(CH<sub>3</sub>)<sub>3</sub>S][Br–HBr].

**Figure 3.6-3:** Plot of conductivity versus viscosity for the ionic liquids in Tables 3.6-3–3.6-5. The line represents the best fit of the data to a power function.

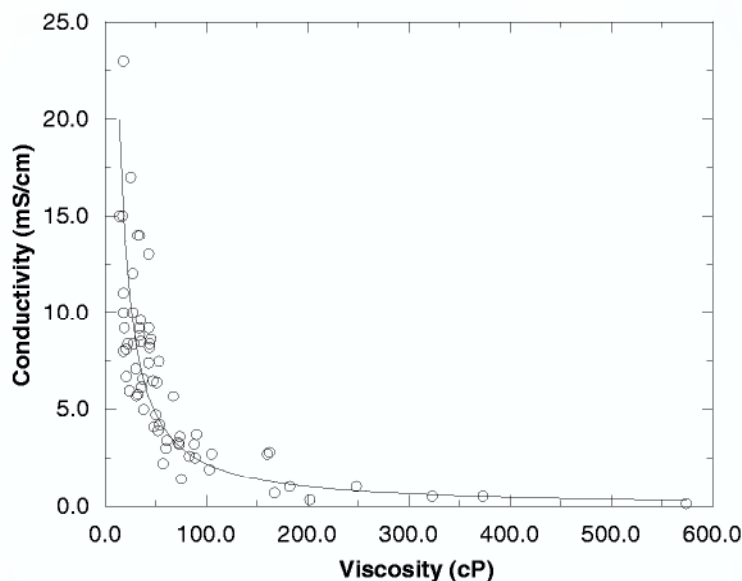

Ionic liquid conductivity appears to be most strongly correlated with viscosity ( $\eta$ ). Figure 3.6-3 shows a plot of conductivity versus viscosity for the data in Tables 3.6-3–3.6-5. This figure clearly demonstrates an inverse relationship between conductivity and viscosity.

The data in Figure 3.6-3 were fitted to a simple power function to give the resulting equation,  $\kappa = 390\eta^{-1.125}$ ,  $R^2 = 0.83$ . A potentially more informative way to look at the relationship between conductivity and viscosity is through the use of a Walden Plot ( $\log \Lambda$  versus  $\log \eta^{-1}$ ) [54]. Plotting the molar conductivity ( $\Lambda$ ) instead of the absolute conductivity ( $\kappa$ ) normalizes to some extent for the effects of molar concentration and density on the conductivity, and thus gives a better indication of the number of mobile charge carriers in an ionic liquid. Figure 3.6-4 shows the Walden Plot for the data in Tables 3.6-3–3.6-5.

A linear regression was performed on the data, giving a slope of 1.08, an intercept of 1.922, and  $R^2 = 0.94$ . The fit of the data to the linear relationship is surprisingly good when one considers the wide variety of ionic liquids and the unknown errors in the literature data. This linear behavior in the Walden Plot clearly indicates that the number of mobile charge carriers in an ionic liquid and its viscosity are strongly coupled.

The physical properties of ionic liquids can often be considerably improved through the judicious addition of co-solvents [55–58]. However, surprisingly, this approach has been relatively underutilized. Hussey and co-workers investigated the effect of co-solvents on the physical properties of [EMIM]Cl/ $\text{AlCl}_3$  ionic liquids [55, 56]. They found significant increases in ionic conductivity upon the addition of a variety of co-solvents. Figure 3.6-5 displays representative data from this work. The magnitude of the conductivity increase depends both on the type and amount of the co-solvent [55, 56].

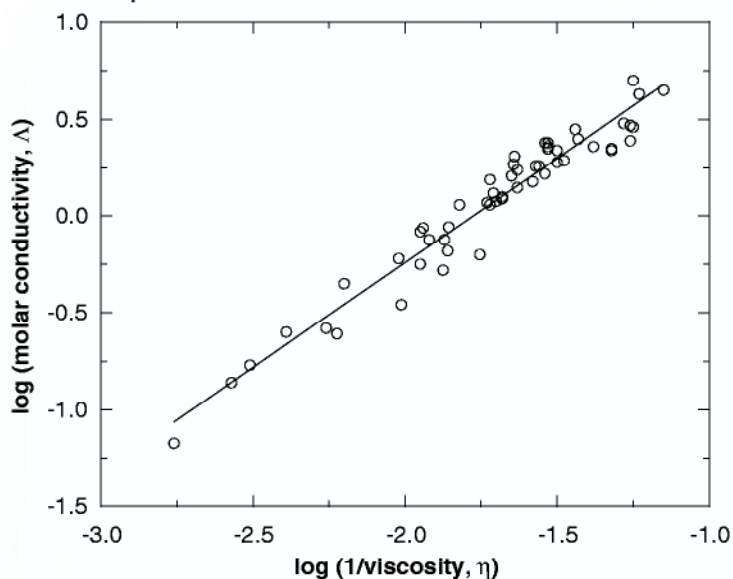

**Figure 3.6-4:** The Walden plot of the molar conductivity and viscosity data in Tables 3.6-3–3.6-5. The line represents the linear regression fit of the data.

The observed effect of co-solvent addition has been explained in terms of the solvation of the constituent ions of the ionic liquid by the co-solvent. This solvation, in turn, reduces ion-pairing or ion aggregation in the ionic liquid, resulting in an increase in the number of available charge carriers and an increase in the mobility of these charge carriers. Counteracting this solvating effect is the dilution of the number of free ions as the mole fraction of the co-solvent increases. These counteracting effects help to explain the observed maximum in conductivity for benzene added to a 40.00–60.00 mol % [EMIM]Cl/AlCl<sub>3</sub> ionic liquid, shown in Figure 3.6-5.

### 3.6.3

#### Transport Properties

The behavior of ionic liquids as electrolytes is strongly influenced by the transport properties of their ionic constituents. These transport properties relate to the rate of ion movement and to the manner in which the ions move (as individual ions, ion-pairs, or ion aggregates). Conductivity, for example, depends on the number and mobility of charge carriers. If an ionic liquid is dominated by highly mobile but neutral ion-pairs it will have a small number of available charge carriers and thus a low conductivity. The two quantities often used to evaluate the transport properties of electrolytes are the ion-diffusion coefficients and the ion-transport numbers. The diffusion coefficient is a measure of the rate of movement of an ion in a solution, and the transport number is a measure of the fraction of charge carried by that ion in the presence of an electric field.

**Figure 3.6-5:** Change in the conductivity of [EMIM]Cl/AlCl<sub>3</sub> ionic liquids with the mole fraction of co-solvent: (□) benzene or (○) CH<sub>2</sub>Cl<sub>2</sub> added to a 55.56–44.44 mol % [EMIM]Cl/AlCl<sub>3</sub> ionic liquid, and (◇) benzene added to a 40.00–60.00 mol % [EMIM]Cl/AlCl<sub>3</sub> ionic liquid.

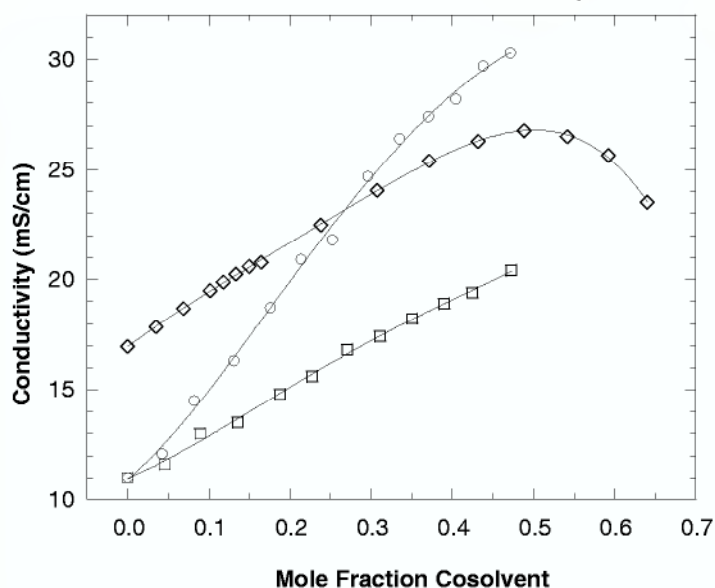

The diffusion coefficients of the constituent ions in ionic liquids have most commonly been measured either by electrochemical or by NMR methods. These two methods in fact measure slightly different diffusional properties. The electrochemical methods measure the diffusion coefficient of an ion in the presence of a concentration gradient (Fick diffusion) [59], while the NMR methods measure the diffusion coefficient of an ion in the absence of any concentration gradients (self-diffusion) [60]. Fortunately, under most circumstances these two types of diffusion coefficients are roughly equivalent.

There are a number of NMR methods available for evaluation of self-diffusion coefficients, all of which use the same basic measurement principle [60]. Namely, they are all based on the application of the spin-echo technique under conditions of either a static or a pulsed magnetic field gradient. Essentially, a spin-echo pulse sequence is applied to a nucleus in the ion of interest while at the same time a constant or pulsed field gradient is applied to the nucleus. The spin echo of this nucleus is then measured and its attenuation due to the diffusion of the nucleus in the field gradient is used to determine its self-diffusion coefficient. The self-diffusion coefficient data for a variety of ionic liquids are given in Table 3.6-6.

Electrochemically generated diffusion coefficients are normally determined from the steady state voltammetric limiting current arising from the reduction or oxidation of the ion of interest. In the case of ionic liquids this requires that the potential of a working electrode be scanned into the cathodic and anodic potential limits in the hopes of obtaining clear limiting current plateaus for the reduction of the cation and the oxidation of the anion, respectively. This process is fraught with difficulty and has met with limited success. The very large limiting currents encountered

scanning beyond the normal potential limits result in significant migration effects, and the irreversible electrode reactions (especially for the cation reduction) often foul the working electrode surface. The one successful application for these electrochemical methods in ionic liquids has been in the evaluation of the diffusion coefficient of the chloride ion in basic [EMIM]Cl/AlCl<sub>3</sub> ionic liquids [63, 64]. In slightly basic ionic liquids the chloride ion concentration is reasonably low and its oxidation well separated from that of the other anion present ([AlCl<sub>4</sub>]<sup>-</sup>). These diffusion coefficient data are given in Table 3.6-6.

Table 3.6-6: Diffusion coefficients for ionic liquids.

Ionic liquid system	Cation	$D_{R_s}$ ( $10^{11} \text{ m}^2 \text{ s}^{-1}$ )	Anion(s)	$D_{X^-}$ ( $10^{11} \text{ m}^2 \text{ s}^{-1}$ )	Temperature (K)	Method <sup>a</sup>	Ref
[EMIM][BF <sub>4</sub> ]	[EMIM] <sup>+</sup>	5.0	[BF <sub>4</sub> ] <sup>-</sup>	4.2	298	PNMR	41 <sup>b</sup>
[EMIM][BF <sub>4</sub> ]	[EMIM] <sup>+</sup>	3.0	[BF <sub>4</sub> ] <sup>-</sup>	-	300	PNMR	61 <sup>c</sup>
[EMIM][CF <sub>3</sub> SO <sub>2</sub> ]	[EMIM] <sup>+</sup>	5	[CF <sub>3</sub> SO <sub>2</sub> ] <sup>-</sup>	3	298	FNMR	44 <sup>c</sup>
[EMIM][CF <sub>3</sub> SO <sub>2</sub> N]	[EMIM] <sup>+</sup>	6.3	[(CF <sub>3</sub> SO <sub>2</sub> ) <sub>2</sub> N] <sup>-</sup>	3.5	298	PNMR	41 <sup>b</sup>
[EMIM][CF <sub>3</sub> SO <sub>2</sub> N]	[EMIM] <sup>+</sup>	5	[(CF <sub>3</sub> SO <sub>2</sub> ) <sub>2</sub> N] <sup>-</sup>	4	298	FNMR	44 <sup>e</sup>
[BP][BF <sub>4</sub> ]	[BP] <sup>+</sup>	0.91	[BF <sub>4</sub> ] <sup>-</sup>	1.0	298	PNMR	41 <sup>b</sup>
[BP][CF <sub>3</sub> SO <sub>2</sub> N]	[BP] <sup>+</sup>	2.4	[BF <sub>4</sub> ] <sup>-</sup>	2.0	298	PNMR	41 <sup>b</sup>
33.0-67.0 mol % [EMIM]Cl/AlCl <sub>3</sub>	[EMIM] <sup>+</sup>	14.4	[Al <sub>2</sub> Cl <sub>7</sub> ] <sup>-</sup> / [AlCl <sub>4</sub> ] <sup>-</sup>	-	303	DNMR	62
50.0-50.0 mol % [EMIM]Cl/AlCl <sub>3</sub>	[EMIM] <sup>+</sup>	18	[AlCl <sub>4</sub> ] <sup>-</sup>	-	298	PNMR	65 <sup>c</sup>
50.0-50.0 mol % [EMIM]Cl/AlCl <sub>3</sub>	[EMIM] <sup>+</sup>	12.7	[AlCl <sub>4</sub> ] <sup>-</sup>	-	303	DNMR	62
55.0-45.0 mol % [EMIM]Cl/AlCl <sub>3</sub>	[EMIM] <sup>+</sup>	10	Cl <sup>-</sup> / [AlCl <sub>4</sub> ] <sup>-</sup>	-	298	PNMR	65 <sup>c</sup>
60.0-40.0 mol % [EMIM]Cl/AlCl <sub>3</sub>	[EMIM] <sup>+</sup>	4.3	Cl <sup>-</sup> / [AlCl <sub>4</sub> ] <sup>-</sup>	-	298	PNMR	65 <sup>c</sup>
65.0-35.0 mol % [EMIM]Cl/AlCl <sub>3</sub>	[EMIM] <sup>+</sup>	2.2	Cl <sup>-</sup> / [AlCl <sub>4</sub> ] <sup>-</sup>	-	298	PNMR	65 <sup>c</sup>
70.0-30.0 mol % [EMIM]Cl/AlCl <sub>3</sub>	[EMIM] <sup>+</sup>	1.2	Cl <sup>-</sup> / [AlCl <sub>4</sub> ] <sup>-</sup>	-	298	PNMR	65 <sup>c</sup>
56.0-44.0 mol % [EMIM]Cl/AlCl <sub>3</sub>	[EMIM] <sup>+</sup>	-	Cl <sup>-</sup> / [AlCl <sub>4</sub> ] <sup>-</sup>	6.1 <sup>d</sup>	299	Elec	63
50.5-49.5 mol % [EMIM]Cl/AlCl <sub>3</sub>	[EMIM] <sup>+</sup>	-	Cl <sup>-</sup> / [AlCl <sub>4</sub> ] <sup>-</sup>	5.7 <sup>d</sup>	299	Elec	64
51.0-49.0 mol % [EMIM]Cl/AlCl <sub>3</sub>	[EMIM] <sup>+</sup>	-	Cl <sup>-</sup> / [AlCl <sub>4</sub> ] <sup>-</sup>	5.3 <sup>d</sup>	299	Elec	64
51.5-48.5 mol % [EMIM]Cl/AlCl <sub>3</sub>	[EMIM] <sup>+</sup>	-	Cl <sup>-</sup> / [AlCl <sub>4</sub> ] <sup>-</sup>	4.6 <sup>d</sup>	299	Elec	64

<sup>a</sup> PNMR = Pulse Gradient-Field Spin Echo (PGSE) NMR, DNMR = <sup>1</sup>H Diffusion Ordered Spectroscopy (DOSY) NMR, Elec = electrochemistry, FNMR = fringe field NMR. <sup>b</sup> Diffusion coefficients at 298 K Calculated from VTF Parameters given in reference. <sup>c</sup> Only cation diffusion coefficients were determined. <sup>d</sup> Diffusion coefficient for the chloride ion. <sup>e</sup> Diffusion coefficients estimated from graphical data provided in the reference.



The cation diffusion coefficient data in Table 3.6-6 correlate well with the corresponding ionic conductivity data given in Tables 3.6-3 and 3.6-4. As would be expected, the cation diffusion coefficient increases with increasing conductivity. The more limited anion diffusion coefficient data, on the other hand, do not show any significant correlation to conductivity. The cation diffusion coefficients for the [EMIM]Cl/AlCl<sub>3</sub> ionic liquids decrease significantly as the mol % of AlCl<sub>3</sub> decreases below 50 %. This “basic” composition regime is characterized by increasing chloride as the mole percent of AlCl<sub>3</sub> decreases. The decline in cation diffusion coefficients is consistent with the observation of significant hydrogen bonding between chloride ion and the [EMIM]<sup>+</sup> cation [4], which would be expected to cause reduced cation mobility.

Transport numbers are intended to measure the fraction of the total ionic current carried by an ion in an electrolyte as it migrates under the influence of an applied electric field. In essence, transport numbers are an indication of the relative ability of an ion to carry charge. The classical way to measure transport numbers is to pass a current between two electrodes contained in separate compartments of a two-compartment cell. These two compartments are separated by a barrier that only allows the passage of ions. After a known amount of charge has passed, the composition and/or mass of the electrolytes in the two compartments are analyzed. From these data the fraction of the charge transported by the cation and the anion can be calculated. Transport numbers obtained by this method are measured with respect to an external reference point (i.e., the separator), and, therefore, are often referred to as external transport numbers. Two variations of the above method, the Moving Boundary method [66] and the Hittorff method [66–69], have been used to measure cation ( $t_{R+}$ ) and anion ( $t_{X-}$ ) transport numbers in ionic liquids, and these data are listed in Table 3.6-7.

The measurement of transport numbers by the above electrochemical methods entails a significant amount of experimental effort to generate high-quality data. In addition, the methods do not appear applicable to many of the newer non-haloaluminate ionic liquid systems. An interesting alternative to the above method utilizes the NMR-generated self-diffusion coefficient data discussed above. If both the cation ( $D_{R+}$ ) and anion ( $D_{X-}$ ) self-diffusion coefficients are measured, then both the cation ( $t_{R+}$ ) and anion ( $t_{X-}$ ) transport numbers can be determined by using the following Equations (3.6-6) and (3.6-7) [41, 44]:

$$t_{R+} = \frac{D_{R+}}{D_{R+} + D_{X-}} \quad (3.6-6)$$

$$t_{X-} = \frac{D_{X-}}{D_{R+} + D_{X-}} \quad (3.6-7)$$

Transport numbers for several non-haloaluminate ionic liquids generated from ionic liquid self-diffusion coefficients are listed in Table 3.6-7. The interesting, and still open, question is whether the NMR-generated transport numbers provide the same measure of the fraction of current carried by an ion as the electrochemically

generated transport numbers. The electrochemical experiment measures the relative movement of charge carriers in the presence of an applied field, while the NMR experiment measures the movement of all ions regardless of whether they are free ions or neutral ion-pairs. If an ion spends a significant portion of its time as part of a neutral association of ions, will its NMR-generated transport number differ significantly from the electrochemical transport number? Clearly further work is needed to resolve this issue.

Table 3.6-7: External ion transport numbers in ionic liquids.

Ionic liquid system	cation	$t_{R+}$	Anion(s)	$t_{X-}$	Temperature (K)	Method <sup>a</sup>	Ref
[EMIM][BF <sub>4</sub> ]	[EMIM] <sup>+</sup>	0.54	[BF <sub>4</sub> ] <sup>-</sup>	0.46	298	PNMR	41 <sup>b</sup>
[EMIM][(CF <sub>3</sub> SO <sub>2</sub> ) <sub>2</sub> N]	[EMIM] <sup>+</sup>	0.64	[(CF <sub>3</sub> SO <sub>2</sub> ) <sub>2</sub> N] <sup>-</sup>	0.36	298	PNMR	41 <sup>b</sup>
[BP][BF <sub>4</sub> ]	[BP] <sup>+</sup>	0.48	[BF <sub>4</sub> ] <sup>-</sup>	0.52	298	PNMR	41 <sup>b</sup>
[BP][(CF <sub>3</sub> SO <sub>2</sub> ) <sub>2</sub> N]	[BP] <sup>+</sup>	0.55	[(CF <sub>3</sub> SO <sub>2</sub> ) <sub>2</sub> N] <sup>-</sup>	0.45	298	PNMR	41 <sup>b</sup>
45.0–55.0 mol % [EMIM]Cl/AlCl <sub>3</sub>	[EMIM] <sup>+</sup>	0.71	[AlCl <sub>4</sub> ] <sup>-</sup>	0.23	303	MH	68 <sup>c</sup>
			[Al <sub>2</sub> Cl <sub>7</sub> ] <sup>-</sup>	0.06	303	MH	68 <sup>c</sup>
50.0–50.0 mol % [EMIM]Cl/AlCl <sub>3</sub>	[EMIM] <sup>+</sup>	0.70	[AlCl <sub>4</sub> ] <sup>-</sup>	–	303	MH	66
50.0–50.0 mol % [EMIM]Cl/AlCl <sub>3</sub>	[EMIM] <sup>+</sup>	–	[AlCl <sub>4</sub> ] <sup>-</sup>	0.30	366	MB	66
60.0–40.0 mol % [EMIM]Cl/AlCl <sub>3</sub>	[EMIM] <sup>+</sup>	0.71	[AlCl <sub>4</sub> ] <sup>-</sup>	0.19	298	MH	67 <sup>c</sup>
			Cl <sup>-</sup>	0.10	298	MH	67 <sup>c</sup>
70.0–30.0 mol % [EMIM]Cl/AlCl <sub>3</sub>	[EMIM] <sup>+</sup>	0.71	[AlCl <sub>4</sub> ] <sup>-</sup>	0.12	298	MH	67 <sup>c</sup>
			Cl <sup>-</sup>	0.17	298	MH	67 <sup>c</sup>
45.0–55.0 mol % [EMIM]Br/AlBr <sub>3</sub>	[EMIM] <sup>+</sup>	0.76	[AlBr <sub>4</sub> ] <sup>-</sup>	0.22	333	MH	68 <sup>c</sup>
			[Al <sub>2</sub> Br <sub>7</sub> ] <sup>-</sup>	0.02	333	MH	68 <sup>c</sup>
50.0–50.0 mol % [EMIM]Br/AlBr <sub>3</sub>	[EMIM] <sup>+</sup>	0.76	[AlBr <sub>4</sub> ] <sup>-</sup>	0.24	333	MH	69
60.0–40.0 mol % [EMIM]Br/AlBr <sub>3</sub>	[EMIM] <sup>+</sup>	0.76	[AlBr <sub>4</sub> ] <sup>-</sup>	0.22	333	MH	69 <sup>c</sup>
			Br <sup>-</sup>	0.02	333	MH	67 <sup>c</sup>
70.0–30.0 mol % [EMIM]Br/AlBr <sub>3</sub>	[EMIM] <sup>+</sup>	0.76	[AlBr <sub>4</sub> ] <sup>-</sup>	0.16	333	MH	67 <sup>c</sup>
			Br <sup>-</sup>	0.08	333	MH	67 <sup>c</sup>

<sup>a</sup> MB = Moving boundary, MH = modified Hittorf, PNMR = Pulse Gradient-Field Spin Echo (PGSE) NMR. <sup>b</sup> Transport numbers at 298 K determined from self-diffusion data provided in the reference. <sup>c</sup> Anion transport numbers calculated from formulas provided in the reference.

As one can see from the data in Table 3.6-7, the [EMIM]<sup>+</sup> cation carries the major portion of the charge ( $t_{R^+} = 0.70$ ) for all the haloaluminate ionic liquids measured. This result is very surprising in view of the large size of the cation compared with that of the extant anions and the fact that the relative fraction of the charge carried by the anions remains essentially constant even with significant changes in the anion composition occurring with changes in ionic liquid composition. It has been proposed that these observations result from the fact that the smaller anions are more structurally constrained in the charge-transport process [67]. However, this explanation seems overly simplistic. The NMR-generated transport numbers in Table 3.6-7 indicate that, in general, more charge is carried by the cation. However, the relative fraction of this charge is significantly less than that observed in the electrochemical transport data for the haloaluminate ionic liquids.

It is unclear at this time whether this difference is due to the different anions present in the non-haloaluminate ionic liquids or due to differences in the two types of transport number measurements. The apparent greater importance of the cation to the movement of charge demonstrated by the transport numbers (Table 3.6-7) is consistent with the observations made from the diffusion and conductivity data above. Indeed, these data taken in total may indicate that the cation tends to be the majority charge carrier for all ionic liquids, especially the alkylimidazoliums. However, a greater quantity of transport number measurements, performed on a wider variety of ionic liquids, will be needed to ascertain whether this is indeed the case.

## References

- 1 a) F. H. Hurley, T. P. Wier, *J. Electrochem. Soc.*, **1951**, 98, 203; b) F. H. Hurley, T. P. Wier, *J. Electrochem. Soc.*, **1951**, 98, 207.
- 2 H. L. Chum, R. A. Osteryoung, in *Ionic Liquids* (D. Inman, D. G. Lovering eds.), Plenum Press, New York, **1981**, pp. 407–423.
- 3 R. J. Gale, R. A. Osteryoung, in *Molten Salt Techniques*, Vol. 1 (D. G. Lovering, R. J. Gale eds), Plenum Press, New York, **1983**, pp. 55–78.
- 4 C. L. Hussey, in *Advances in Molten Salt Chemistry* (G. Mamantov, C. B. Mamantov eds.), Elsevier, Amsterdam, **1983**, pp. 185–230.
- 5 G. Mamantov, in *Molten Salt Chemistry* (G. Mamantov, R. Marassi eds.), D. Reidel, New York, **1987**, pp. 259–270.
- 6 R. A. Osteryoung, in *Molten Salt Chemistry* (G. Mamantov, R. Marassi eds.), D. Reidel, New York, **1987**, pp. 329–364.
- 7 C. L. Hussey, *Pure Appl. Chem.*, **1988**, 60, 1763.
- 8 C. L. Hussey, in *Chemistry of Nonaqueous Solutions – Current Progress* (G. Mamantov, A. I. Popov eds.), VCH, New York, **1994**, pp. 227–275.
- 9 R. T. Carlin, J. S. Wilkes, in *Chemistry of Nonaqueous Solutions – Current Progress* (G. Mamantov, A. I. Popov eds.), VCH, New York, **1994**, pp. 277–306.
- 10 T. Welton, *Chem. Rev.*, **1999**, 99, 2071.
- 11 Y. Ito, T. Nohira, *Electrochim. Acta*, **2000**, 45, 2611.

- 12 A. Fry, W. E. Britton, in *Laboratory Techniques in Electroanalytical Chemistry* (P. T. Kissinger, W. R. Heineman eds.), Marcel Dekker, New York, 1984, chapter 13.
- 13 K. R. Seddon, A. Stark, M.-J. Torres, *Pure Appl. Chem.*, 2000, 72, 2275.
- 14 U. Schröder, J. D. Wadhawan, R. G. Compton, F. Marken, P. A. Z. Suarez, C. S. Consorti, R. F. de Souza, J. Dupont, *New J. Chem.*, 2000, 24, 1009.
- 15 T. E. Sutto, H. C. De Long, P. C. Trulove, unpublished results.
- 16 A. E. Visser, R. P. Swatloski, W. M. Reichert, S. T. Griffin, R. D. Rogers, *Ind. Eng. Chem. Res.*, 2000, 39, 3596.
- 17 J. G. Huddleston, A. E. Visser, W. M. Reichert, H. D. Willauer, G. A. Broker, R. D. Rogers, *Green Chem.*, 2001, 3, 156.
- 18 R. T. Carlin, T. Sullivan, *J. Electrochem. Soc.*, 1992, 139, 144.
- 19 H. Matsumoto, M. Yanagida, K. Tanimoto, M. Nomura, Y. Kitagawa, Y. Miyazaki, *Chem. Lett.*, 2000, 922.
- 20 a) J. Sun, M. Forsyth, D. R. MacFarlane, *Molten Salt Forum*, 1998, 5-6, 585; b) J. Sun, M. Forsyth, D. R. MacFarlane, *J. Phys. Chem. B.*, 1998, 102, 8858.
- 21 D. R. MacFarlane, P. Meakin, J. Sun, N. Amini, M. Forsyth, *J. Phys. Chem. B.*, 1999, 103, 4164.
- 22 a) R. Hagiwara, T. Hirashige, T. Tsuda, Y. Ito, *J. Fluorine Chem.*, 1999, 99, 1. b) R. Hagiwara, T. Hirashige, T. Tsuda, Y. Ito, *J. Electrochem. Soc.*, 2002, 149, D1.
- 23 A. Noda, M. Watanabe, *Electrochem. Acta*, 2000, 45, 1265.
- 24 a) J. Fuller, R. T. Carlin, R. A. Osteryoung, *J. Electrochem. Soc.*, 1997, 144, 3881. b) J. Fuller, R. A. Osteryoung, R. T. Carlin, *Abstracts of Papers*, 187<sup>th</sup> Meeting of The Electrochemical Society, Reno, NV, 1995, Vol. 95-1, p. 27.
- 25 E. I. Cooper, E. J. M. O'Sullivan, in *Proceedings of the Eighth International Symposium on Molten Salts* (R. J. Gale, G. Blomgren eds.), The Electrochemical Society: Pennington NJ, 2000, Vol. 92-16, pp. 386-396.
- 26 P. Bonhôte, A.-P. Dias, N. Papageorgiou, K. Kalyanasundaram, M. Grätzel, *Inorg. Chem.*, 1996, 35, 1168.
- 27 A. B. McEwen, H. L. Ngo, K. LeCompte, J. L. Goldman, *J. Electrochem. Soc.*, 1999, 146, 1687.
- 28 V. R. Koch, L. A. Dominey, C. Najundiah, M. J. Ondrechen, *J. Electrochem. Soc.*, 1996, 143, 798.
- 29 J. Caja, T. D. J. Dunstan, D. M. Ryan, V. Katovic, in *Proceedings of the Twelfth International Symposium on Molten Salts* (P. C. Trulove, H. C. De Long, G. R. Stafford, S. Deki eds.), The Electrochemical Society: Pennington NJ, 2000, Vol. 99-41, pp.150-161.
- 30 H. Matsumoto, T. Matsuda, Y. Miyazaki, *Chem. Lett.*, 2000, 1430.
- 31 M. Lipsztajn, R. A. Osteryoung, *J. Electrochem. Soc.*, 1983, 130, 1968.
- 32 a) T. L. Riechel, J. S. Wilkes, *J. Electrochem. Soc.*, 1992, 139, 977; b) C. Scordilis-Kelly, R. T. Carlin, *J. Electrochem. Soc.*, 1993, 140, 1606; c) C. Scordilis-Kelly, R. T. Carlin, *J. Electrochem. Soc.*, 1994, 141, 873.
- 33 S. P. Wicelinski, R. J. Gale, J. S. Wilkes, *J. Electrochem. Soc.*, 1987, 134, 262.
- 34 J. R. Stuff, S. W. Lander Jr., J. W. Rovang, J. S. Wilkes, *J. Electrochem. Soc.*, 1990, 137, 1492.
- 35 S. D. Jones, G. E. Blomgren, in *Proceedings of the Seventh International Symposium on Molten Salts* (C. L. Hussey, S. N. Flengas, J. S. Wilkes, Y. Ito eds.), The Electrochemical Society: Pennington NJ, 1990, Vol. 90-17, pp. 273-280.
- 36 In the publication, P. A. Z. Suarez, V. M. Selbach, J. E. L. Dullius, S. Einloft, C. M. S. Piatneccki, D. S. Azambuja, R. F. de Souza, J. Dupont, *Electrochim. Acta*, 1997, 42, 2533, the authors claim to have observed electrochemical windows for [BMIM][BF<sub>4</sub>] and [BMIM][PF<sub>6</sub>] of 6.1 V and 7.1 V, respectively, at a tungsten working electrode, while at a Pt working electrode the windows were 4.6 V and 5.7 V, respectively. The significant disparity between the windows given by the two working electrodes, plus the disagreement with values at Pt (4.1 V and

- 4.2 V, respectively) generated by this same group in a later publication [13], cause us to treat these impressive electrochemical windows as suspect. Consequently, they have not been included in Table 3.6-1.
- 37 G. E. Gray, J. Winnick, P. A. Kohl, *J. Electrochem. Soc.*, **1996**, *143*, 3820.
  - 38 J. D. Vaughn, A. Mughrabi, E. C. Wu, *J. Org. Chem.*, **1970**, *35*, 1141.
  - 39 T. J. Melton, J. Joyce, J. T. Maloy, J. A. Boon, J. S. Wilkes, *J. Electrochem. Soc.*, **1990**, *137*, 3865.
  - 40 F. J. Holler, C. G. Enke, in *Laboratory Techniques in Electroanalytical Chemistry* (P. T. Kissinger, W. R. Heineman eds.), Marcel Dekker, New York, **1984**, chapter 8.
  - 41 a) A. Noda, K. Hayamizu, M. Watanabe, *J. Phys. Chem. B*, **2001**, *105*, 4603; b) A. Noda, M. Watanabe, in *Proceedings of the Twelfth International Symposium on Molten Salts* (P. C. Trulove, H. C. De Long, G. R. Stafford, S. Deki eds.), The Electrochemical Society: Pennington NJ, **2000**, Vol. 99-41, pp. 202–208.
  - 42 C. A. Angell, in *Molten Salts: From Fundamentals to Applications* (M. Gaune-Escard, Ed.), Kluwer Academic Publishers, London, **2002**, pp. 305–320.
  - 43 T. E. Sutto, H. C. De Long, P. C. Trulove, in *Progress in Molten Salt Chemistry 1* (R. W. Berg, H. A. Hjuler eds.), Elsevier: Paris, **2000**, 511.
  - 44 H. Every, A. G. Bishop, M. Forsyth, D. R. MacFarlane, *Electrochim. Acta*, **2000**, *45*, 1279.
  - 45 S. Chun, S. V. Dzyuba, R. A. Bartsch, *Anal. Chem.*, **2001**, *73*, 3737.
  - 46 S. N. Baker, G. A. Baker, M. A. Kane, F. V. Bright, *J. Phys. Chem. B*, **2001**, *105*, 9663.
  - 47 J. Fuller, A. C. Breda, R. T. Carlin, *J. Electroanal. Chem.*, **1998**, *459*, 29.
  - 48 a) J. S. Wilkes, J. A. Levisky, R. A. Wilson, C. L. Hussey, *Inorg. Chem.*, **1982**, *21*, 1263; b) A. A. Fannin Jr., D. A. Floreani, L. A. King, J. S. Landers, B. J. Piersma, D. J. Stech, R. J. Vaughn, J. S. Wilkes, J. L. Williams, *J. Phys. Chem.*, **1984**, *88*, 2614.
  - 49 a) J. R. Sanders, E. H. Ward, C. L. Hussey, in *Proceedings of the Fifth International Symposium on Molten Salts* (M.-L. Saboungi, K. Johnson, D. S. Newman, D. Inman eds.), The Electrochemical Society: Pennington NJ, **1986**, Vol. 86-1, pp.307–316; b) J. R. Sanders, E. H. Ward, C. L. Hussey, *J. Electrochem. Soc.*, **1986**, *133*, 325.
  - 50 R. A. Carpio, L. A. King, R. E. Lindstrom, J. C. Nardi, C. L. Hussey, *J. Electrochem. Soc.*, **1979**, *126*, 1644.
  - 51 V. R. Koch, L. L. Miller, R. A. Osteryoung, *J. Am. Chem. Soc.*, **1976**, *98*, 5277.
  - 52 M. Ma, K. E. Johnson, in *Proceedings of the Ninth International Symposium on Molten Salts* (C. L. Hussey, D. S. Newman, G. Mamantov, Y. Ito eds.), The Electrochemical Society: Pennington NJ, **1994**, Vol. 94-13, pp.179–186.
  - 53 E. I. Cooper, C. A. Angell, *Solid State Ionics*, **1983**, *9-10*, 617.
  - 54 S. I. Smedley, *The Interpretation of Ionic Conductivity in Liquids*, Plenum, New York, **1980**, chapter 3.
  - 55 R. L. Perry, K. M. Jones, W. D. Scott, Q. Liao, C. L. Hussey, *J. Chem. Eng. Data*, **1995**, *40*, 615.
  - 56 Q. Liao, C. L. Hussey, *J. Chem. Eng. Data*, **1996**, *41*, 1126.
  - 57 R. Moy, R.-P. Emmenegger, *Electrochimica Acta*, **1992**, *37*, 1061.
  - 58 J. Robinson, R. C. Bugle, H. L. Chum, D. Koran, R. A. Osteryoung, *J. Am. Chem. Soc.*, **1979**, *101*, 3776.
  - 59 A. J. Bard, L. R. Faulkner, *Electrochemical Methods – Fundamentals and Applications*, 2<sup>nd</sup> Ed., Wiley, New York, **2001**, chap. 4.
  - 60 P. Stilbs, *Progress in NMR Spectroscopy*, **1987**, *19*, 1.
  - 61 J.-F. Huang, P.-Y. Chen, I.-W. Sun, S. P. Wang, *Inorg. Chim. Acta*, **2001**, *320*, 7.
  - 62 W. R. Carper, G. J. Mains, B. J. Piersma, S. L. Mansfield, C. K. Larive, *J. Phys. Chem.*, **1996**, *100*, 4724.
  - 63 R. T. Carlin, R. A. Osteryoung, *J. Electroanal. Chem.*, **1988**, *252*, 81.
  - 64 L. R. Simonsen, F. M. Donahue, *Electrochim. Acta*, **1990**, *35*, 89.

- 65 R. A. Mantz, H. C. De Long, R. A. Osteryoung, P. C. Trulove, in *Proceedings of the Twelfth International Symposium on Molten Salts* (P. C. Trulove, H. C. De Long, G. R. Stafford, S. Deki eds.), The Electrochemical Society: Pennington NJ, 2000, Vol. 99-41, pp.169-176.
- 66 C. J. Dymek, L. A. King, *J. Electrochem. Soc.*, **1985**, *132*, 1375.
- 67 C. L. Hussey, J. R. Sanders, H. A. Øye, *J. Electrochem. Soc.*, **1985**, *132*, 2156.
- 68 C. L. Hussey, H. A. Øye, *J. Electrochem. Soc.*, **1984**, *131*, 1623.
- 69 C. L. Hussey, J. R. Sanders, *J. Electrochem. Soc.*, **1987**, *134*, 1977.



## 4

### Molecular Structure and Dynamics

*W. Robert Carper, Andreas Dölle, Christof G. Hanke, Chris Hardacre, Axel Leuchter, Ruth M. Lynden-Bell, Zhizhong Meng, Günter Palmer, and Joachim Richter*

#### 4.1

##### Order in the Liquid State and Structure

*Chris Hardacre*

The structure of liquids has been studied for many years. These investigations have, in general, been focussed on the arrangements in molecular solvents such as water, *t*-butanol, and simple chlorinated solvents. The field of molten salts and their structures is much less studied, and within this field the study of the structure of room-temperature ionic liquids is in its infancy. A variety of techniques have been used to investigate liquid structure, including neutron diffraction, X-ray scattering, and extended X-ray absorption fine structure. This chapter summarizes some of the techniques used, including practical details, and shows examples of where they have been employed previously. The examples given are not meant to be exhaustive and are provided for illustration only. Where possible, examples relating to the more recent air- and moisture-stable ionic liquids have been included.

##### 4.1.1

###### Neutron Diffraction

Neutron diffraction is one of the most widely used techniques for the study of liquid structure. In the experiment, neutrons are elastically scattered off the nuclei in the sample and are detected at different scattering angles, typically 3° to 40°, for the purpose of measuring intermolecular structure whilst minimizing inelasticity corrections. The resultant scattering profile is then analyzed to provide structural information.

The data taken is normally presented as the total structure factor,  $F(Q)$ . This is related to the neutron scattering lengths  $b_i$ , the concentrations  $c_i$ , and the partial structure factor  $S_{ij}(Q)$  for each pair of atoms  $i$  and  $j$  in the sample, by Equation 4.1-1:

$$F(Q) = \sum_{i,j} c_i c_j b_i b_j (S_{ij}(Q) - 1) \quad (4.1-1)$$

where  $Q$  is the scattering vector and is dependent on the scattering angle  $\theta$ , and the wavelength  $\lambda$  of the neutrons used.

$$Q = \frac{4\pi \sin\theta}{\lambda} \quad (4.1-2)$$

The real space pair distributions  $g_{ij}(r)$  is the inverse Fourier transform of  $(S_{ij}(Q)-1)$ , that is:

$$g_{ij}(r) = 1 + \frac{1}{2\pi^2 \rho_0} \int_0^\infty Q^2 \frac{\sin(Qr)}{Qr} (S_{ij}(Q) - 1) dQ \quad (4.1-3)$$

normalized to the atomic density  $\rho$ .

In a neutron diffraction experiment, the quantity measured as a function of angle is the total scattering cross section, which consists of two components: (i) neutrons that scatter coherently (that is, where phase is conserved and the signal of which contains structural information) and (ii) incoherently scattered neutrons that result in a background signal. The scattering amplitude is then determined by the concentration, atomic arrangement, and neutron scattering lengths of the atoms involved. Since different isotopes have different neutron scattering lengths, it is possible to simplify the analysis of the neutron data simply by isotopic exchange experiments and by taking first and second order difference spectra to separate out the partial pair distribution functions. This is clearly set out by Bowron et al. [1] for a mixture of *t*-butanol/water and illustrates how isotopic substitution neutron scattering experiments can assist in distinguishing between intermolecular and intramolecular distributions within a sample, both of which would otherwise contribute to a measured diffraction pattern in a complex and often difficult to interpret combination.

#### 4.1.2

##### Formation of Deuteriated Samples

In general, isotopic exchange is both expensive and difficult. In the case of many room-temperature ionic liquids, however, the manufacture of deuterated ionic liquids is relatively easily achievable. For example, the general synthesis of 1-alkyl-3-methylimidazolium salts is shown in Scheme 4.1-1 [2]. This methodology allows maximum flexibility in the deuteration on the imidazolium cation; that is, it can be either ring or side chain deuteration or both.

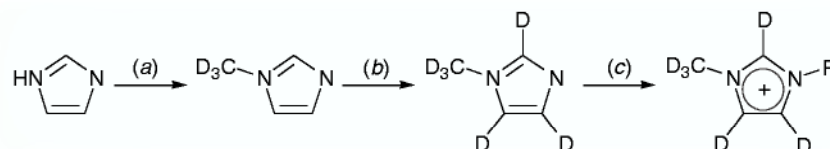

**Scheme 4.1-1:** Reaction scheme showing a method for deuteration of 1-alkyl-3-methylimidazolium salts: (a)  $\text{CD}_3\text{OD}$ ,  $\text{RuCl}_3/(n\text{-BuO})_3\text{P}$ , (b)  $\text{D}_2\text{O}$ , 10 % Pd/C, and (c) RX ( $\text{CD}_3\text{Cl}$ ,  $\text{C}_2\text{D}_5\text{I}$ ).

## 4.1.3

**Neutron Sources**

The following sources and instruments dominate studies in the area of liquids and amorphous materials. Although there are a number of sources available, each is optimized for a particular class of experiment. The sources can be split into two types: pulsed neutron sources and reactor sources

4.1.3.1 **Pulsed (spallation) neutron sources**

One example of a pulsed neutron source is to be found at ISIS, at the Rutherford Appleton Laboratory, UK. This source has the highest flux of any pulsed source in the world at present, and is therefore one of the most suitable for isotopic substitution work, as this class of experiment tends to be flux-limited. At ISIS, two stations are particularly well set up for the examination of liquids.

**SANDALS station (Small Angle Neutron Diffractometer for Amorphous and Liquid Samples)** This station is optimized for making measurements on liquids and glasses that contain light elements such as H, Li, B, C, N, and O. This set-up relies on collection of data at small scattering angles and the use of high-energy neutrons. This combination of characteristics has the effect of reducing the corrections necessary for the inelastic scattering that otherwise dominates the measured signal and hence complicates the extraction of structural signal information. This instrument is singularly specifically optimized for H-D isotopic substitution experiments.

**GEM (GEneral Materials diffractometer)** GEM is designed with extremely stable detectors, covering a very large solid angle, and is optimized for collection of data at a very high rate. It is a hybrid instrument that can perform both medium/high-resolution powder diffraction studies on crystalline systems and very accurate total scattering measurements for liquids and glasses. Because of the high stability of the detectors and data acquisition electronics, it is suitable for isotopic substitution work on systems containing elements with only small differences in the isotope neutron scattering lengths, such as  $^{12}\text{C}$  and  $^{13}\text{C}$ .

ISIS is only one pulsed source available for the study of liquids. Both the USA and Japan have facilities similar to SANDALS and GEM for studying liquids, but with slightly lower neutron intensity: in the forms of the IPNS (Intense Pulsed Neutron Source) at the Argonne National Lab. on the instrument GLAD, and the KEK Neutron Scattering Facility (KENS) on the instrument Hit II, respectively.

4.1.3.2 **Reactor sources**

The Institute Laue-Langevin (ILL, Grenoble, France) has arguably the premier neutron scattering instrument for total scattering studies of liquid and amorphous materials, in instrument D4C. The neutrons are provided by a reactor source that is very stable and delivers a very high flux. This makes the ILL ideal for isotopic substitution work for elements with atomic numbers greater than that of oxygen. For

light elements, the inelasticity corrections are a major problem, as the instrument collects data over a large angular range and with relatively low-energy neutrons. Typically the wavelength of the neutrons used on D4 is 0.7 Å, which is quite long when compared with a source such as ISIS where wavelengths ranging from 0.05 Å to 5.0 Å can be used on an instrument like SANDALS.

Other reactor sources with instruments like D4C but with much lower flux, and hence longer data collection times, are the Laboratoire Leon Brillouin (LLB, Saclay, France), on the instrument 7C2, and the NFL (Studsvik, Sweden), on the instrument SLAD

The following website provides links to all the neutron sites in the world: <http://www.isis.rl.ac.uk/neutronSites/>.

#### 4.1.4

#### Neutron Cells for Liquid Samples

As in any scattering experiment, the ideal sample holder is one that does not contribute to the signal observed. In neutron scattering experiments, the typical cells used are either vanadium, which scatters neutrons almost completely incoherently (that is, with almost no structural components in the measured signal), or a null scattering alloy of TiZr alloy. Vanadium cells react with water and are not ideal for studies of hydrated systems, whereas TiZr is more chemically inert; TiZr cells have been used, for example, to study supercritical water and alkali metals in liquid ammonia. In addition, TiZr cells capable of performing measurements at high pressure have been constructed. Figure 4.1-1 shows typical sample cells made from Vanadium and TiZr alloy.

Cells used for high-temperature measurements in furnaces often consist of silica sample tubes, supported by thin vanadium sleeves. The key to the analysis is whether it is possible to have a container that scatters in a sufficiently predictable way, so that its background contribution can be subtracted. With the current neutron flux available from both pulsed and reactor sources, sample volumes of

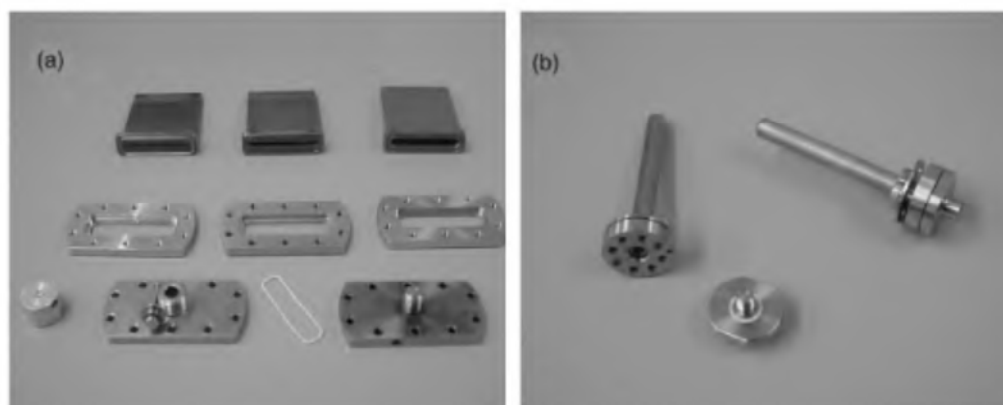

Figure 4.1-1: Liquid sample cells made from (a) TiZr alloy and (b) vanadium.

between 1 and 5 cm<sup>3</sup> are required. Obviously, with increasing flux at the new neutron sources being built in the USA and Japan, the sample sizes will decrease.

#### 4.1.5

##### Examples

Neutron diffraction has been used extensively to study a range of ionic liquid systems; however, many of these investigations have focussed on high-temperature materials such as NaCl, studied by Enderby and co-workers [3]. A number of liquid systems with relatively low melting points have been reported, and this section summarizes some of the findings of these studies. Many of the salts studied melt above 100 °C, and so are not room-temperature ionic liquids, but the same principles apply to the study of these materials as to the lower melting point salts.

##### 4.1.5.1 Binary mixtures

A number of investigations have focussed on alkali haloaluminates: that is,  $(MX)_\gamma(AlX_3)_{1-\gamma}$  mixtures in which M is an alkali metal and X is a halogen (Cl or Br). Blander et al. [4] have used neutron diffraction combined with quantum chemical calculations to investigate the salts formed from KBr and KCl where  $\gamma = 0.25$  and 0.33. The authors showed that, for both bromide and chloride salts,  $[Al_2X_7]^-$  was the dominant species present, as expected, in full agreement with other spectroscopic techniques such as Raman and infra-red [5]. In the case of chloride, however, as the acidity of the melt increased (that is, as  $\gamma$  decreased), although the proportion of  $[Al_3X_{10}]^-$  ions did increase, the change was unexpectedly smaller than that predicted by the stoichiometry. A closer relationship with the stoichiometry was found for bromide. The neutron scattering data showed a strong correlation between the liquid structure and that found in, for example, the crystal structure of  $K[Al_2Br_7]$ . In both the liquid and crystal, the angle of the Al–Br–Al bridge within the  $[Al_2Br_7]^-$  anion is found to be approximately 109 ° and both also show that the neighboring structural units pack parallel to each other.

The structures of binary mixtures of  $AlCl_3$  with NaCl and LiCl were studied from pure  $AlCl_3$  to a 1:1 mixture by Badyal et al. [6]. In the pure  $AlCl_3$  liquid, the neutron data indicates that the long held view that isolated  $Al_2Cl_6$  dimers make up the structure may not be the true scenario. The structure is reported to be a sparse liquid network made up of polymeric species containing corner-shared tetrahedra. On addition of the alkali halides, the presence of Al–Cl–Al linkages gradually decreases in proportion to the concentration of the halide added. This coincides with the formation of  $[AlCl_4]^-$  species. The neutron scattering also shows that the long-range order within the liquid decreases as the binary salt mixture is formed, consistently with the gradual breakdown of the polymeric aluminium trichloride structure. Of significance in the 1:1 binary mixture is the high level of charge ordering in the system. For example, in the case of LiCl, features at  $r = 6.65, 9.85,$  and  $12.9$  Å in the radial distribution function are clearly evident but do not correspond to distances in either of the pure components and therefore are probably associated with spacings between  $[AlCl_4]^-$  units.

Ion pairs	$b_{6\text{Li}}b_i$	$b_{7\text{Li}}b_i$
Li-S	0.004	-0.005
Li-C	0.009	-0.012
Li-N	0.013	-0.017
Li-Al	0.005	-0.006
Li-Cl	0.041	-0.054

**Table 4.1-1:** Comparison of the neutron scattering cross-sections for  $^6\text{Li}$  and  $^7\text{Li}$  with all the other atoms present in a binary mixture of LiSCN with  $\text{AlCl}_3$ .

Binary mixtures of LiSCN with  $\text{AlCl}_3$  have also been studied [7]. In this case, the 1:1 mixture is liquid at ambient temperature and therefore provides a system analogous to room-temperature ionic liquids. Lee et al. used Li isotope substitution to enable the correlations between Li-X to be isolated. The weighting factors between  $^6\text{Li}$  and  $^7\text{Li}$  are positive and negative, respectively, and can be used to distinguish features in the partial radial distribution function. Table 4.1-1 compares the combined neutron scattering cross-sections  $b_{Li}b_i$  for both isotopes with each other atom  $i$  in the liquid. Figure 4.1-2 shows the equivalent total correlation functions for the 1:1 mixture. Clearly the amplitude of the  $^7\text{Li}$  systems shows negative and reduced features compared with the  $^6\text{Li}$  sample, and these must therefore be associated with Li-X features.

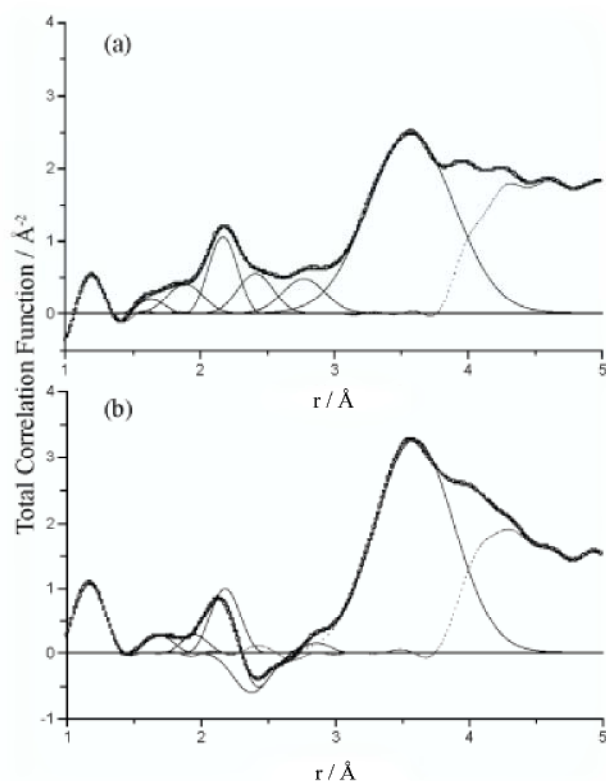

**Figure 4.1-2:** Total correlation functions for (a)  $^6\text{LiSCN}/\text{AlCl}_3$  and (b)  $^7\text{LiSCN}/\text{AlCl}_3$ . The bold lines are the experimental neutron data ( $\bullet$ ), the fit ( $-$ ), the Gaussian functions for each of the atomic pairs used to fit the data ( $-$ ) and the deviation ( $\cdots$ ) used. Reproduced from reference 7 with permission.



From the data, the liquid is shown to have tetrahedrally coordinated aluminium with three chlorines and the isocyanate group attached. The neutron data clearly shows nitrogen, as opposed to sulfur, coordination to the aluminium center, forming an  $\text{AlCl}_3\text{NCS}^-$  species, which is consistent with a hard base/hard acid interaction as compared with the softer sulfur donation. It was also possible to show that a tetrahedral chloride environment is present around the lithium.

Takahashi et al. have studied the structures of  $\text{AlCl}_3/[\text{EMIM}]\text{Cl}$  mixtures over a range of concentrations from 46 to 67 mol%  $\text{AlCl}_3$  [8]. Below 50 mol%  $\text{AlCl}_3$ , the neutron data could be simulated simply by using the isolated ions: that is,  $[\text{EMIM}]^+$  and  $[\text{AlCl}_4]^-$ . Above 50 mol%  $\text{AlCl}_3$ ,  $[\text{Al}_2\text{Cl}_7]^-$  is also known to exist, and at 67 mol%  $\text{AlCl}_3$  becomes the major anion present. Unlike that of  $[\text{AlCl}_4]^-$ , the geometry of  $[\text{Al}_2\text{Cl}_7]^-$  is changed substantially in the liquid compared with the isolated ions, implying a direct interaction between the imidazolium cation and the anionic species. This is manifested as a decrease in the torsion angle around the central Al–Cl–Al axis, from  $57.5^\circ$  to  $26.2^\circ$ , and hence as a decrease in the Cl–Cl distance across the anion.

Mixtures of HCl and  $[\text{EMIM}]\text{Cl}$  have also been studied [9, 10]. By analysis of the first order differences by hydrogen/deuterium substitution both on the imidazolium ring and the HCl, two intramolecular peaks were observed. These indicated the presence of  $[\text{HCl}_2]^-$  as an asymmetric species, which, coupled with analysis of the second order differences, allowed the structure in Figure 4.1-3 to be proposed.

#### 4.1.5.2 Simple salts

Bowron et al. [11] have performed neutron diffraction experiments on 1,3-dimethylimidazolium chloride ( $[\text{MMIM}]\text{Cl}$ ) in order to model the imidazolium room-temperature ionic liquids. The total structure factors,  $F(Q)$ , for five 1,3-dimethylimidazolium chloride melts – fully protiated, fully deuterated, a 1:1 fully deuterated/fully protiated mixture, ring deuterated only, and side chain deuterated only – were measured. Figure 4.1-4 shows the probability distribution of chloride around a central imidazolium cation as determined by modeling of the neutron data.

As well as charge-ordering in the system, out to two chloride shells, the specific local structure shows strong interactions between the chloride and the ring hydrogens, as well as some interaction between the methyl groups of adjacent imidazolium cations. This is consistent with the crystal structure and implies that the molecular packing and interactions in the first two or three coordination shells are similar in both the crystal and the liquid.

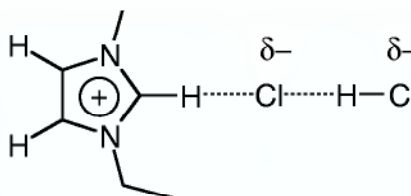

**Figure 4.1-3:** Proposed structure of the asymmetric  $[\text{HCl}_2]^-$  ion bound to the  $[\text{EMIM}]^+$  cation in a binary mixture of  $\text{HCl}/[\text{EMIM}]\text{Cl}$ . The figure has been redrawn from reference 10 with permission.

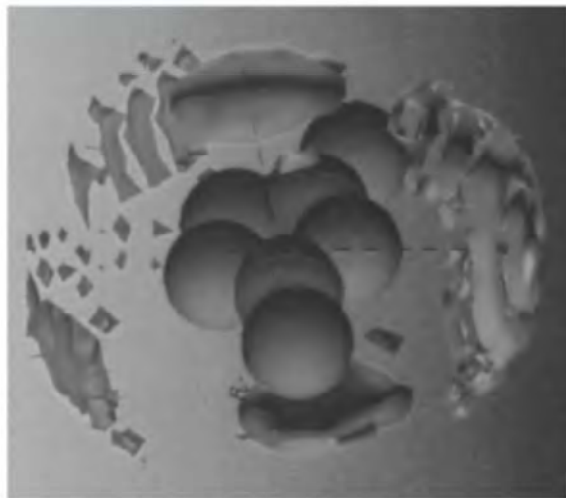

Figure 4.1-4: Chloride probability distribution around a central imidazolium cation as determined by the EPSR model of the neutron data from liquid [MMIM]Cl at 150 °C.

In all these examples, the importance of good simulation and modeling cannot be stressed enough. A variety of methods have been used in this field to simulate the data in the cases studies described above. Blander et al. [4], for example, used a semi-empirical molecular orbital method, MNDO, to calculate the geometries of the free haloaluminate ions and used these as a basis for the modeling of the data by the RPSU model [12]. Badyal et al. [6] used reverse Monte Carlo simulations, whereas Bowron et al. [11] simulated the neutron data from [MMIM]Cl with the Empirical Potential Structure Refinement (EPSR) model [13].

#### 4.1.6

##### X-ray Diffraction

X-ray diffraction has been used for the study both of simple molten salts and of binary mixtures thereof, as well as for liquid crystalline materials. The scattering process is similar to that described above for neutron diffraction, with the exception that the scattering of the photons arises from the electron density and not the nuclei. The X-ray scattering factor therefore increases with atomic number and the scattering pattern is dominated by the heavy atoms in the sample. Unlike in neutron diffraction, hydrogen (for example) scatters very weakly and its position cannot be determined with any great accuracy.

In contrast with the study of the structure of the molten salts, full analysis of the scattering profile is not generally performed for liquid crystalline materials. In the latter, only the Bragg features are analyzed (that is, for a wavelength  $\lambda$ , incident on the sample at an angle  $\theta$  to its surface normal, the position of the diffraction peaks are determined by Bragg's law,  $n\lambda = 2d\sin\theta$ ). From the angle of diffraction, the periodicity length,  $d$ , may be determined.

In both cases, laboratory X-ray sources may be used and the X-ray measurements taken in  $\theta$ - $2\theta$  geometry. For weakly scattering systems synchrotron radiation is helpful.

#### 4.1.6.1 Cells for liquid samples

Sample cells include Lindemann/capillary tubes (normally < 1 mm in diameter) and aluminium holders. In the latter, thin aluminium windows sandwich the sample in a cylindrical aluminium sample holder. The diffraction from the aluminium is observed in this case, and may be used as a calibration standard. For low-temperature materials, the aluminium window can be replaced by the polymer Kapton. Beryllium may also be used [14]. Sample volumes of between 50 and 100  $\mu\text{L}$  are typically required.

#### 4.1.6.2 Examples

**Molten salts and binary mixtures** X-ray diffraction has been performed by Takahashi et al. [15] on 1:1 binary mixtures of  $\text{AlCl}_3$  with  $\text{LiCl}$  and  $\text{NaCl}$ . In agreement with the neutron data obtained by Badyal et al. [6] and discussed above, the liquid has a degree of charge ordering, with sets of four  $[\text{AlCl}_4]^-$  units surrounding a central  $[\text{AlCl}_4]^-$  unit at distances of 6.75 Å for  $\text{LiCl}$  and 6.98 Å for  $\text{NaCl}$ . Similarly, Igarashi et al. [16] have studied a molten  $\text{LiF}/\text{NaF}/\text{KF}$  eutectic mixture. For the ion-pairs  $\text{Li-F}$ ,  $\text{Na-F}$ , and  $\text{K-F}$ , the nearest-neighbor coordination and distances were almost identical to those found in the individual melts of the component salts.

Binary mixtures that melt close to room temperature, namely  $\text{AlCl}_3/\text{N-butylpyridinium chloride}$  mixtures, have also been investigated. Takahashi et al. [17] have also shown that for the 1:1 composition,  $[\text{AlCl}_4]^-$  predominates with a tetrahedral environment. At a ratio of 2:1,  $[\text{Al}_2\text{Cl}_7]^-$  becomes the main species. At high temperature (above 150 °C), some decomposition to  $[\text{AlCl}_4]^-$  and  $\text{Al}_2\text{Cl}_6$  was observed.

**Liquid crystals** A wide range of ionic liquids form liquid-crystalline phases. This is normally achieved by increasing the amphiphilic character of the cation through substitution with longer, linear alkyl groups. The salts have relatively low melting points, close to room temperature when the alkyl chain length ( $C_n$ ) is small ( $n < 10$ ), and display liquid crystal mesomorphism when  $n > 12$ . This section describes some of the results of studies in which X-ray diffraction has been used to examine the mesophase and liquid phase. There are also many examples of materials which form liquid-crystalline phases that have been studied by techniques such as NMR, DSC, single-crystal X-ray diffraction, and so on that have not been included (see, for example, [18–21]).

#### *Metal-containing systems*

Many of the systems studied are based on  $[\text{MCl}_4]^{2-}$  anion. Neve et al. have extensively studied the formation of liquid-crystalline phases of *N*-alkylpyridinium salts with alkyl chain lengths of  $n = 12$ –18 with tetrahalometalate anions based upon  $\text{Pd(II)}$  [22] and  $\text{Cu(II)}$  [23]. In general, the liquid-crystalline phases exhibit lamellar-

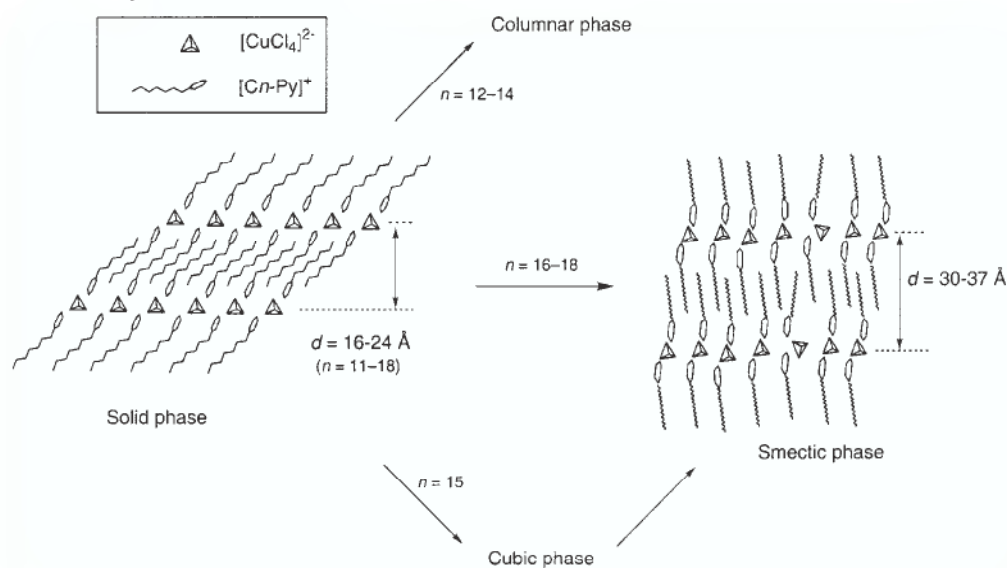

**Figure 4.1-5:** Schematic showing the changes in structure of *N*-alkylpyridinium tetrachlorocuprate salts with varying alkyl chain lengths. Reproduced from reference 23 with permission.

like structures based upon the smectic A structure. For  $n = 16, 18$ , in the cases of  $[\text{PdCl}_4]^{2-}$  and  $[\text{PdBr}_4]^{2-}$ , this is preceded by an ordered smectic E phase. Cuprate-based pyridinium ionic liquids exhibit a range of structures depending on the alkyl chain length. For  $\text{C}_{12}$ – $\text{C}_{18}$ , each solid-state structure has a layered periodicity. On melting, however,  $\text{C}_{12}$ – $\text{C}_{14}$  exhibit a columnar phase whereas  $\text{C}_{16}$ – $\text{C}_{18}$  simply form a smectic A phase. For  $n = 15$ , the solid melts into a cubic phase before transforming into the smectic A phase as seen for longer alkyl chains. Figure 4.1-5 illustrates the changes observed in the latter case.

Similar lamellar structures are formed for 1-alkyl-3-methylimidazolium cations with  $[\text{PdCl}_4]^{2-}$  when  $n > 12$ . As with the pyridinium systems, mesomorphic liquid crystal structures based on the smectic A structure are formed [24].

Martin [25] has also shown that ammonium salts display similar behavior.  $[\text{Cetyltrimethylammonium}]_2[\text{ZnCl}_4]$ , for example, first melts to an  $\text{S}_\text{C}$ -type liquid crystal at 70 °C and then to an  $\text{S}_\text{A}$ -type mesophase at 160 °C. The broad diffraction features observed in the liquid-crystalline phases are similar to those seen in the original crystal phase and show the retention on melting of some of the order originating from the initial crystal, as shown in Figure 4.1-6.

Needham et al. [26] also used X-ray diffraction to show that, in the case of Mn(II)-, Cd(II)-, and Cu(II)-based  $\text{C}_{12}$ - and  $\text{C}_{14}$ -ammonium tetrachlorometalate salts, two mechanistic pathways were present on melting to the mesophase. Each pathway was shown to have a minor and major structural transformation. The minor change was thought to be a torsional distortion of the alkyl chains and the major change the melting of the chains, forming a disordered layer. The order in which the structural changes occur was found to be dependent on the metal and on the alkyl chain length.

**Figure 4.1-6:** Small-angle X-ray diffraction data from [cetyltrimethylammonium]<sub>2</sub>[ZnCl<sub>4</sub>] at (a) room temperature (solid), (b) 90 °C (*S<sub>C</sub>* phase) and (c) 200 °C (*S<sub>A</sub>* phase). Reproduced from reference 25 with permission.

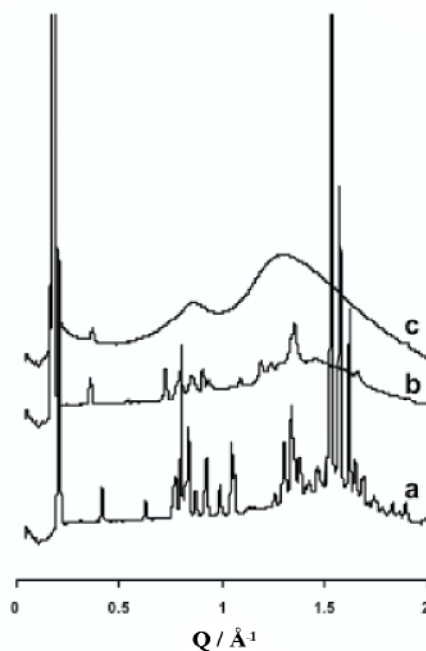

#### *Non-metal-containing systems*

Non-metal-containing salts have been studied extensively. Bradley et al. [27] examined a range of 1-alkyl-3-methylimidazolium-based salts containing chloride, bromide, trifluoromethanesulfonate ([OTf]<sup>-</sup>), bis(trifluoromethanesulfonyl)imide, and [BF<sub>4</sub>]<sup>-</sup> anions. In the mesophase, the X-ray data of these salts were consistent with smectic A phases with interlayer spacings of between 22–61 Å, increasing uniformly with increasing alkyl chain length *n*. For a given cation, the mesophase interlayer spacing decreases in the order Cl<sup>-</sup> > Br<sup>-</sup> > [BF<sub>4</sub>]<sup>-</sup> > [OTf]<sup>-</sup>, with the bis(trifluoromethanesulfonyl)imide salts not exhibiting any mesophase structure. The anion dependence of the mesophase interlayer spacing is largest for the anions with greatest ability to form a three-dimensional hydrogen-bonding lattice. On melting to the isotropic liquid, a broad peak is observed in the X-ray scattering data for each salt, as shown in Figure 4.1-7. This peak indicates that some short-range associative structural ordering is still retained even within the isotropic liquid phase.

Similarly, *N*-alkylammonium [28] and alkylphosphonium [29] salts form lamellar phases with smectic bilayer structures. In both cases, X-ray scattering also showed the isotropic liquid not to be completely disordered and still displaying similar features to the mesophase. Buscio et al. [28] showed that in *N*-alkylammonium chlorides the feature was not only much broader than that observed in the mesophase but increased in width with decreasing chain length.

Other examples include ditholium salts, shown in Figure 4.1-8 [30]. The scattering data show that a range of mesophase behavior is present, dependent – as with the metal-containing systems – on alkyl chain length.

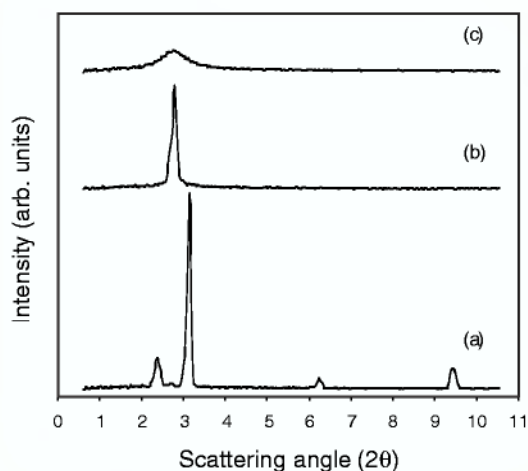

Figure 4.1-7: Small-angle X-ray diffraction data from  $[C_{16}MIM][OTf]$  at (a) 50 °C, (b) 70 °C, and (c) 90 °C, in the crystal,  $SmA_2$ , and isotropic phases, respectively, on cooling. Reproduced from reference 27 with permission.

For  $n = 12$ , for example, two transitions within the liquid crystalline region are observed: from a nematic columnar phase ( $N_{col}$ ) to a hexagonal columnar lattice ( $D_h$ ), and then finally to a rectangular lattice ( $D_r$ ). X-ray diffraction data for benzimidazolium salts have also been reported [31], and indicated a switch within the liquid crystalline region from a lamellar  $\beta$  phase to the  $\alpha$  phase, which in some examples is not shown by differential scanning calorimetry. Using X-ray diffraction, Bruce and co-workers have proposed a new structural model for  $N$ -alkylpyridinium alkylsulphates [32]. In these liquid-crystalline materials, the  $d$  spacings obtained are less than the molecular length, but are not associated with tilting of the alkyl chains. The new proposed model shows microdomains of interdigitated and non-interdigitated molecules.

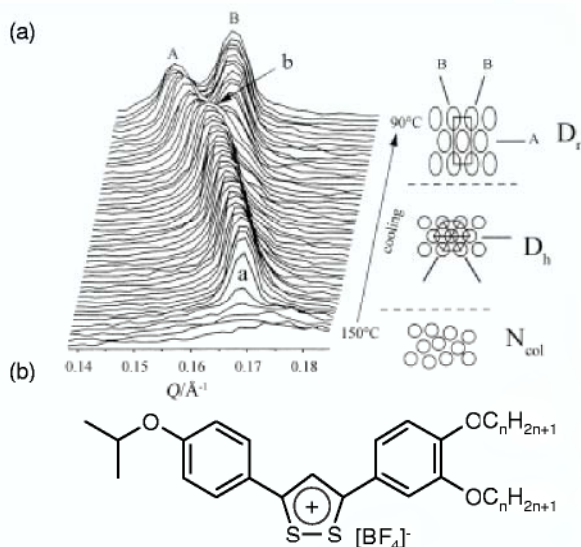

Figure 4.1-8: (a) Small-angle X-ray diffraction data relating to the ditholium salt shown in (b) for  $n = 12$ . **A** and **B** correspond to the rectangular lattice vectors shown in  $D_r$ , and **a** and **b** correspond to the  $N_{col}$  to  $D_h$  and  $D_h$  to  $D_r$  phase transitions. Reproduced from reference 30 with permission.



Other liquid-crystalline materials that have been investigated by X-ray scattering include single- and double-chained pyridinium [33] and *N*-substituted 4-(5-alkyl-1,3-dioxan-2-yl)pyridinium salts [34]. In the former case, diffraction analysis allowed an explanation for the differences in mono- and di-substituted salts to be proposed.

In general, X-ray data are used in conjunction with other techniques to obtain as full a picture as possible. For liquid-crystalline materials, differential scanning calorimetry (DSC) and polarizing optical microscopy (POM) are conventionally used.

#### 4.1.7

#### Extended X-ray Absorption Fine-structure Spectroscopy

Extended X-ray absorption fine-structure (EXAFS) spectroscopy measures X-ray absorption as a function of energy and allows local arrangements of atoms to be elucidated. The absorption results from the excitation of a core electron in an atom. Conventional EXAFS is usually associated with hard X-rays (that is, >3–4 keV), in order to allow measurements to be made outside a vacuum, and requires synchrotron radiation to provide the intensity at the energies involved. At these energies, the core electrons ejected correspond to the 1s (K-edge), 2s (L<sub>I</sub>-edge), 2p<sub>1/2</sub>(L<sub>II</sub>-edge), and 2p<sub>3/2</sub>(L<sub>III</sub>-edge) states. As the photon energy is increased past the absorption edge, an oscillatory structure is found, described as the X-ray fine structure. The X-ray fine structure starts at approximately 30 eV past the edge and extends to a range of 1000 eV.

EXAFS is observed as a modulating change in the absorption coefficient caused by the ejected electron wave back-scattering from the surrounding atoms, resulting in interference between ejected and back-scattered waves. It is defined as:

$$\chi(k) = \frac{\mu(k) - \mu_0(k)}{\Delta\mu_0} \quad (4.1-4)$$

where  $\chi(k)$  is the EXAFS as a function of the wavenumber of the photoelectron  $k$ ,  $\mu(k)$  is the measured absorption above the absorption edge,  $\mu_0(k)$  is the absorption spectrum without the EXAFS oscillations (that is, the background), and  $\Delta\mu_0$  is a normalization factor.

The wavenumber is defined at a photon energy  $E$  above the absorption edge energy  $E_0$ , with respect to the mass of the electron  $m_e$ .

$$k = \sqrt{\frac{2m_e}{h^2}(E - E_0)} \quad (4.1-5)$$

The EXAFS is related to the wavenumber by:

$$\chi(k) \approx \sum_i \frac{N_i f_i(k)}{k r_i^2} e^{-2\sigma_i^2 k^2} e^{-2r_i/\lambda} \sin[2k r_i + \alpha_i(k)] \quad (4.1-6)$$

Where,  $\chi(k)$  is the sum over  $N_i$  back-scattering atoms  $i$ , where  $f_i$  is the scattering amplitude term characteristic of the atom,  $\sigma_i$  is the Debye–Waller factor associated with the vibration of the atoms,  $r_i$  is the distance from the absorbing atom,  $\lambda$  is the mean free path of the photoelectron, and  $\alpha_i$  is the phase shift of the spherical wave as it scatters from the back-scattering atoms. By taking the Fourier transform of the amplitude of the fine structure (that is,  $\chi(k)$ ), a real-space radial distribution function of the back-scattering atoms around the absorbing atom is produced.

On analysis of the EXAFS data, the local environment around a given absorbing atom – that is, the type, number and distance of the back-scattering atoms – can be obtained. It should be noted that it is not necessary for the surrounding atoms to be formally bonded to the absorbing atom. Typically the distance has an uncertainty of  $\pm 1\%$  within a radius of approximately 6 Å; however, the error in the coordination number is strongly dependent on the system studied and can be high. In this regard, comparison with standard materials and the use of EXAFS in conjunction with other techniques to ensure a realistic interpretation of the data is vital.

Since the fine structure observed is only associated with the particular absorption edge being studied, and the energy of the absorption edge is dependent on the element and its oxidation state, EXAFS examines the local structure around one particular element, and in some cases, an element in a given oxidation state. A fuller picture can therefore be obtained by studying more than one absorbing element in the sample.

#### 4.1.7.1 Experimental

**Measuring EXAFS spectra** In general, transmission EXAFS can be used, provided that the concentration of the element to be investigated is sufficiently high. The sample is placed between two ionization chambers, the signals of which are proportional to the incident intensity  $I_0$  and the transmitted intensity through the sample  $I_t$ . The transmission of the sample is dependent on the thickness of the sample  $x$  and on the absorption coefficient,  $\mu$ , in a Beer–Lambert relationship:

$$I_t = I_0 e^{-\mu x} \quad (4.1-7)$$

For good spectra to be obtained, the difference between the  $\ln(I_t/I_0)$  before and after the absorption edge, the edge jump, should be between 0.1 and 1. This may be calculated from the mass absorption coefficient of a sample:

$$\left(\frac{\mu}{\rho}\right)_{\text{sample}} = \sum_i w_i \left(\frac{\mu}{\rho}\right)_i \quad (4.1-8)$$

where  $\rho$  is the sample density and the mass-weighted average of the mass absorption coefficients of each element in the sample, using weight fractions  $w_i$ .

If the edge jump is too large, the sample should be diluted or the path-length decreased. If the edge jump is too small, then addition of more sample is one possibility, although this is dependent on the matrix in which the sample is studied.

For low atomic weight matrices such as carbon-based materials, the path-length can be increased without the transmission of the X-rays being adversely affected. In matrices containing high atomic weight elements, such as chlorine, increasing path-length will result in a larger edge jump, but it will also decrease the overall transmission of the X-rays. For such samples, fluorescence EXAFS may be performed. In this geometry, the emitted X-rays are measured. Optimally, the sample is placed at  $45^\circ$  to the incident X-rays and the X-ray fluorescence is detected at  $90^\circ$  to the direction of the exciting X-rays by use of, for example, a solid-state detector. The X-ray fluorescence is proportional to the X-rays absorbed by the sample and therefore can be used to measure the EXAFS oscillations. In general, this technique has a poorer signal-to-noise ratio than transmission EXAFS and there are problems with self-absorption effects, requiring dilute or thin sample sizes.

Self-absorption occurs when the path-length is too large [35] and the X-rays emitted have a significant probability of being absorbed by the remainder of the sample before being detected. This has the consequence of reducing the amplitude of the EXAFS oscillations and producing erroneous results. As the sample becomes more dilute this probability decreases. All the atoms in the sample determine the amount of self-absorption: hence the need for thin samples.

**Liquid set-ups** There are two major methods by which liquid samples are studied; these are shown in Figure 4.1-9.

These consist either of supporting the liquid in an inert, low atomic weight matrix such as graphite or boron nitride, or of sandwiching thin films between low atomic weight plates. The choice of the matrix material used is a balance between its chemical inertness towards the liquid being studied whilst being thermally stable and its being transparent to the X-rays at the absorption energy. The latter becomes less problematic as the energy of the absorption edge increases. Figure 4.1-10 shows an experimental cell which has been used to measure the EXAFS of ionic liquid samples [36].

**Analysis** A number of commercial software packages to model EXAFS data are available, including the FEFF program developed by Rehr and co-workers [37], GNXAS, developed by Filipponi et al. [38], and EXCURV, developed by Binsted [39]. These analysis packages fit the data to curve wave theory and describe multiple scattering as well as single scattering events. Before analysis, the pre-edge and a smooth

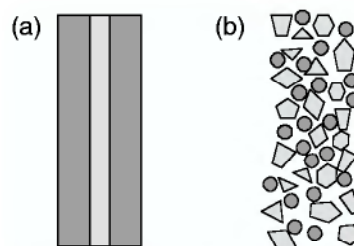

**Figure 4.1-9:** Schematic of the sample preparation methods used to study liquid EXAFS: (a) thin liquid film sandwich between low atomic weight plates, and (b) the liquid (circles) dispersed in a low atomic number matrix (polyhedrons). The figure has been redrawn from reference 40 with permission.

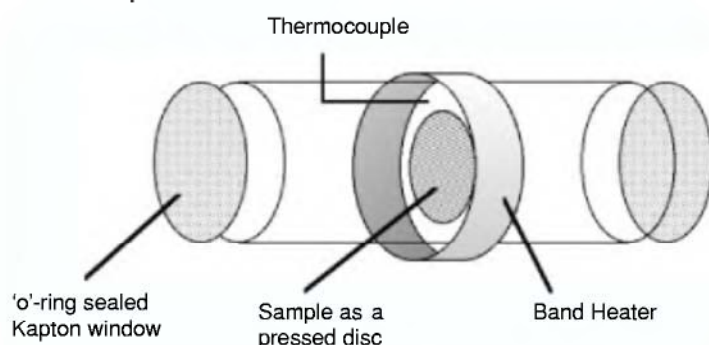

Figure 4.1-10: Schematic of transmission EXAFS cell. Reproduced from reference 36 with permission.

post-edge background function  $\mu_0(k)$  is subtracted from the measured spectra. This is one of the most important procedures and can, if performed poorly, result in loss of amplitude of the EXAFS oscillations or unphysical peaks in the Fourier transform.

Two review articles treating the theory more rigorously and summarizing much of the data on general liquid systems have recently been published [40, 41].

#### 4.1.7.2 Examples

**Ionic liquid structure** To date, EXAFS has only been used to examine the structure of high-temperature molten salts in detail.

Di Cicco and co-workers [42, 43] have examined the structure of molten CuBr with Cu and Br K-edge EXAFS. From the EXAFS data, the Cu–Br bond length distribution was found to be shorter than that derived from neutron data and theoretical models, indicating a more covalent character than previously thought. Similar EXAFS studies on KBr and RbBr are in good agreement with theory, showing high levels of ionicity [43].

Zn and Rb K-edge EXAFS have also been used to examine the melting of  $\text{Rb}_2\text{ZnCl}_4$  in comparison with the liquid structure of  $\text{ZnCl}_2$  and  $\text{RbCl}$  [44]. In molten  $\text{ZnCl}_2$ , the zinc is found to be tetrahedrally coordinated, with the tetrahedra linked by corner-sharing chlorines in a weak extended network. In  $\text{RbCl}$ , significant disorder is evident in the chloride shell around the rubidium and indicates significant movement of the  $\text{Rb}^+$  and  $\text{Cl}^-$  in the molten state. In the crystal structure of  $\text{Rb}_2\text{ZnCl}_4$ , the chlorine coordination number around the Rb is between 8 and 9, whilst the Zn is found in isolated  $\text{ZnCl}_4$  units. In the molten state, the EXAFS also indicates isolated  $\text{ZnCl}_4$  units with a chlorine coordination of 7.6 around the Rb. This may be compared with a chlorine coordination of 4.8 in liquid  $\text{RbCl}$ . The EXAFS clearly shows that the solid and liquid structures of  $\text{Rb}_2\text{ZnCl}_4$  are similar and that the melt does not rearrange into a simple combination of the component parts.

In the studies described above, the samples were supported in low atomic weight matrices, melted in situ, and measured in transmission mode. Similarly, second

generation ionic liquids have been studied. Carmichael et al. [45] showed that it was possible to support and melt  $[\text{EMIM}]_2[\text{NiCl}_4]$  and  $[\text{C}_{14}\text{MIM}]_2[\text{NiCl}_4]$  in inert matrices such as boron nitride, graphite, and lithium fluoride without the EXAFS being affected by the sample matrix used. In these samples, the Ni K-edge EXAFS was investigated between room temperature and 131 °C. Even in LiF, where halide exchange was possible, little difference was found in the Ni coordination on melting.

**Species dissolved in ionic liquids** A number of systems have been investigated in both chloroaluminate and second generation ionic liquids

Dent et al. [46] studied the dissolution of  $[\text{EMIM}][\text{MCl}_4]$  in  $[\text{EMIM}]\text{Cl}/\text{AlCl}_3$  binary mixtures, for  $\text{M} = \text{Mn}, \text{Co},$  and  $\text{Ni}$ , at  $\text{AlCl}_3$  mole fractions of 0.35 and 0.60 using the M K-edges. Because of problems associated with the high concentration of chloride it was not possible to perform transmission experiments, and so fluorescence measurements were used. In this case, self-absorption problems were overcome by use of a thin film of liquid pressed between two sheets of polythene sealed in a glove-box. The coordination of Ni, Co, and Mn was found to change from  $[\text{MCl}_4]^{2-}$  to  $[\text{M}(\text{AlCl}_3)_4]^-$  as the mole fraction of  $\text{AlCl}_3$  increased. Figure 4.1-11 shows the EXAFS and *pseudo*-radial distribution functions for  $\text{M} = \text{Co}$  in both the acidic and basic chloroaluminate ionic liquids.

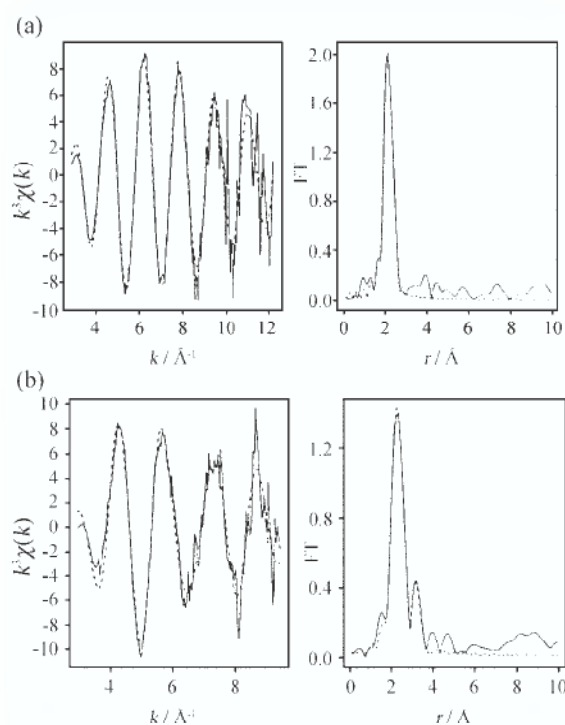

**Figure 4.1-11:** The EXAFS data and *pseudo*-radial distribution functions of Co(II) in (a) basic and (b) acidic chloroaluminate ionic liquid. Reproduced from reference 46 with permission.

Aluminium coordination was only observed in acidic mixtures (that is, at  $\text{AlCl}_3$  mole fractions greater than 0.5). The latter was surprising given that at 0.60  $\text{AlCl}_3$ , almost half the anion species are in the form  $[\text{Al}_2\text{Cl}_7]^-$ , yet no coordinating  $[\text{Al}_2\text{Cl}_7]^-$  was observed.

Dent et al. [47] also investigated the V K-edge EXAFS for the dissolution of  $[\text{EMIM}][\text{VOCl}_4]$  and  $[\text{NEt}_4][\text{VO}_2\text{Cl}_2]$  in basic  $[\text{EMIM}]\text{Cl}/\text{AlCl}_3$  and compared the data with those of solid samples. In both cases the dissolved and the solid samples showed similar EXAFS and no coordination of the chloroaluminate species to, for example, the vanadyl oxygen was found.

Thanks to the decrease in the average atomic weight of the medium compared with chloroaluminate systems, second generation ionic liquids may be studied in transmission. Carmichael et al. [45] have shown that solutions of  $[\text{EMIM}]_2[\text{NiCl}_4]$  in  $[\text{BMIM}][\text{PF}_6]$  may be studied by supporting the liquid between two boron nitride discs. The resulting Ni K-edge EXAFS showed a local structure similar to that of the molten  $[\text{EMIM}]_2[\text{NiCl}_4]$  described above.

Baston et al. [48] studied samples of ionic liquid after the anodization of uranium metal in  $[\text{EMIM}]\text{Cl}$ , using the U L<sub>III</sub>-edge EXAFS to establish both the oxidation state and the speciation of uranium in the ionic liquid. This was part of an ongoing study to replace high-temperature melts, such as  $\text{LiCl}/\text{KCl}$  [49], with ionic liquids. Although it was expected that, when anodized, the uranium would be in the +3 oxidation state, electrochemistry showed that the uranium was actually in a mixture of oxidation states. The EXAFS of the solution showed an edge jump at 17166.6 eV, indicating a mixture of uranium(IV) and uranium(VI). The EXAFS data and *pseudo*-radial distribution functions for the anodized uranium in  $[\text{EMIM}]\text{Cl}$  are shown in Figure 4.1-12.

Two peaks, corresponding to a 1:1 mixture of  $[\text{UCl}_6]^{2-}$  and  $[\text{UO}_2\text{Cl}_4]^{2-}$ , were fitted, in agreement with the position of the edge. Oxidation to uranium(VI) was surpris-

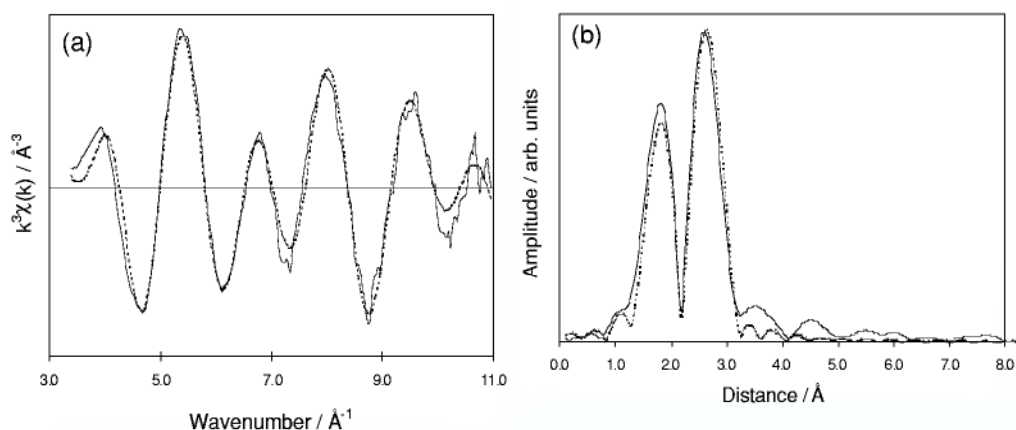

**Figure 4.1-12:** The experimental (solid line) and fitted (dashed line) U L<sub>III</sub>-edge (a) EXAFS data and (b) *pseudo*-radial distribution function after anodization of uranium in  $[\text{EMIM}]\text{Cl}$ . The figure has been redrawn from reference 48 with permission.



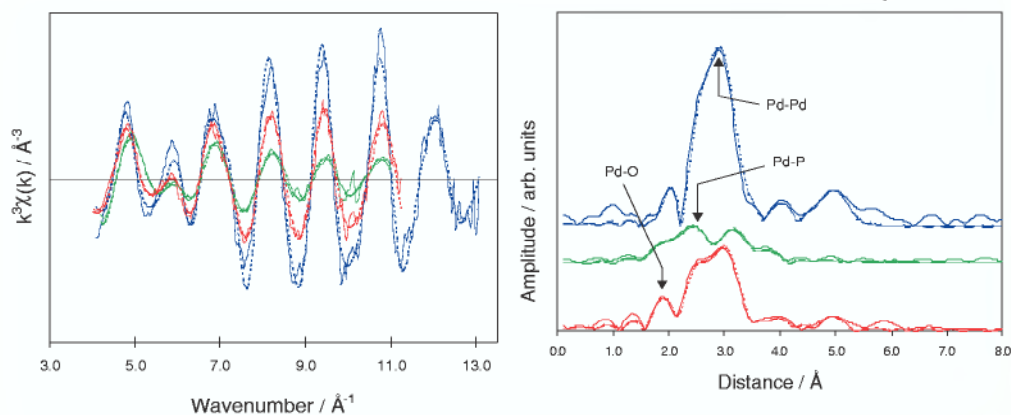

**Figure 4.1-13:** Comparison of the experimental (solid line) and fitted (dashed line) (a) EXAFS and (b) *pseudo*-radial distribution functions from palladium ethanoate in [BMIM][PF<sub>6</sub>] without (—) and with (---) triphenylphosphine at 80 °C and in the presence of triphenylphosphine and reagents at 50 °C for 20 min (—). Reproduced from reference 50 with permission.

ing in this system and may have arisen from the presence of water due to the highly hygroscopic nature of [EMIM]Cl.

In none of the above cases has a reaction been performed whilst taking the EXAFS data. Hamill et al. [50] have investigated catalysis of the Heck reaction by palladium salts and complexes in room-temperature ionic liquids. On dissolution of palladium ethanoate in [BMIM]<sup>+</sup> and *N*-butylpyridinium ([BP]<sup>+</sup>) hexafluorophosphate and tetrafluoroborate ionic liquids, and triethyl-hexyl ammonium bis(trifluoromethanesulfonyl)imide, a gradual change from ethanoate coordination to the formation of palladium metal was observed in the Pd K-edge EXAFS, as shown in Figure 4.1-13.

In pyridinium chloride ionic liquids and in 1,2-dimethyl-3-hexylimidazolium chloride ([HMMIM]Cl), where the C(2) position is protected by a methyl group, only [PdCl<sub>4</sub>]<sup>2-</sup> was observed, whereas in [HMIM]Cl, the EXAFS showed the formation of a bis-carbene complex. In the presence of triphenylphosphine, Pd–P coordination was observed in all ionic liquids except where the carbene complex was formed. During the Heck reaction, the formation of palladium was found to be quicker than in the absence of reagents. Overall, the EXAFS showed the presence of small palladium clusters of approximately 1 nm diameter formed in solution.

#### 4.1.8

##### X-ray Reflectivity

Reflectometry is a useful probe with which to investigate the structure of multilayers both in self-supporting films and adsorbed on surfaces [51]. Specular X-ray reflectivity probes the electron density contrast perpendicular to the film. The X-rays irradiate the substrate at a small angle (<5 °) to the plane of the sample, are reflected, and are detected at an equal angle. If a thin film is present on the surface

of the substrate, the X-rays may be reflected from the top and the bottom of the film, which gives rise to interference and an oscillatory pattern with changing angle of incidence, known as Kiessig fringes. The pattern obtained is a function of the difference in electron density and roughness at each interface present; rough films give rise to a reduction in the amplitude of the oscillation observed. Analysis of this variation gives information principally about the interfaces, but may also be used to investigate chain layering, in metal soaps, for example [52].

#### 4.1.8.1 Experimental set-up

X-ray reflectivity experiments for thin films of liquids and so on are commonly performed on silicon single-crystal wafers, the X-rays being reflected off the surface of the wafer [53]. To enable good adhesion, the wafers have to be cleaned (in concentrated nitric acid with subsequent UV-O<sub>3</sub> treatment, for example) to remove any trace organics. Deposition of the films can then be performed by spin coating from a solution of the salt in a volatile organic solvent. In general, the spin-coated films are too rough to give good reflectivity spectra and the films need to be pre-annealed. X-ray reflectivity measurements may be performed with a laboratory X-ray source as well as with synchrotron radiation. Figure 4.1-14 shows a typical cell used for reflectivity measurements.

#### 4.1.8.2 Examples

Carmichael et al. [54] have used this technique to compare the structures of thin films of [C<sub>18</sub>MIM][PF<sub>6</sub>], [C<sub>18</sub>MIM][BF<sub>4</sub>], [BMIM]<sub>2</sub>[PdCl<sub>4</sub>], [C<sub>12</sub>MIM]<sub>2</sub>[PdCl<sub>4</sub>], and [C<sub>12</sub>MIM][PF<sub>6</sub>] to bulk solutions as studied by small-angle X-ray scattering. Bragg features were clearly visible for all the salts studied; but in most cases the additional Kiessig fringes were not observed. Figure 4.1-15 shows an example of data collected on a thin film of [C<sub>18</sub>MIM][PF<sub>6</sub>].

The Bragg peaks indicated an ordered local structure within the sample film, and the interlayer spacings were reproduced compared with the bulk samples, with only

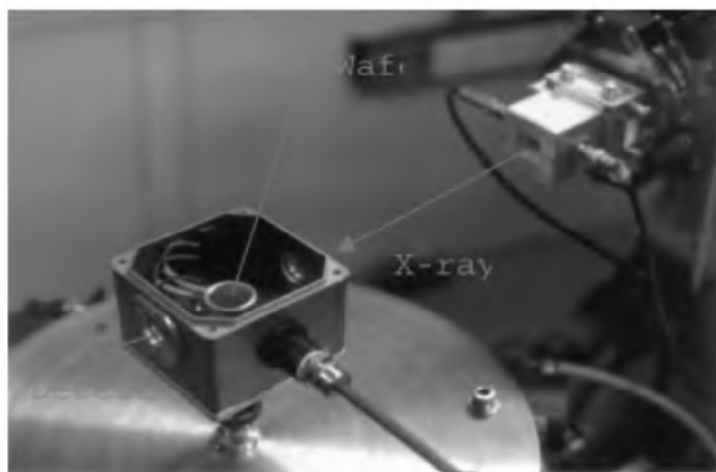
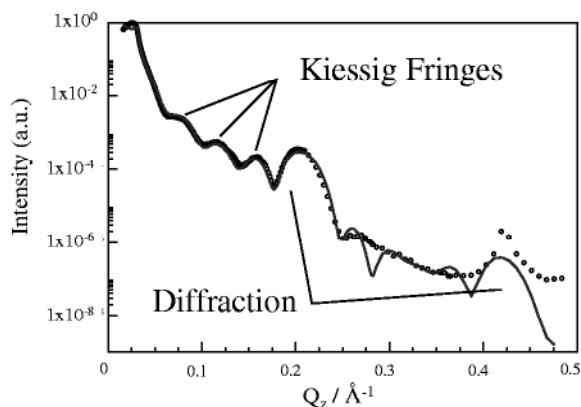

Figure 4.1-14: A typical cell used for X-ray reflectivity measurements.

**Figure 4.1-15:** Experimental reflectivity data (points) compared with a five-bilayer model (solid line) for a 156 Å thick  $[\text{C}_{18}\text{MIM}][\text{PF}_6]$  films at 298 K. Reproduced from reference 54 with permission.



minor shifts in layer spacing. The small changes in layer spacing would be expected, since the thin film structure is not constrained by long-range order effects and hence adopts a slightly different, lower-energy form. The similarity between the bulk samples and the thin film was further demonstrated in the case of  $[\text{C}_{18}\text{MIM}][\text{PF}_6]$  by modeling of the Kiessig fringes. This model was comprised of layers of associated 1-ethyl-3-methylimidazolium cation head-groups and hexafluorophosphate anions, denoted as the charged region, separated by hydrocarbon chains. Reasonable fits were only obtained with the charged region at the salt–silicon and the salt–air interfaces.

Although this technique has not been used extensively, it does allow structures of adsorbed layers on solid substrates to be studied. Liquid reflectivity may also be performed with a similar set-up, which relies on a liquid–liquid interface acting as the reflective surface and measures the reflectivity of a thin supported liquid film. This technique has recently been used to investigate water–alkane interfaces [55] and is potentially useful in understanding the interaction of ionic liquids with molecular solvents in which they are immiscible.

#### 4.1.9

##### Direct Recoil Spectrometry (DRS)

The surface structures of ionic liquids have been studied by direct recoil spectrometry. In this experiment, a pulsed beam of 2–3 keV inert gas ions is scattered from a liquid surface, and the energies and intensities of the scattered and sputtered (recoiled) ions are measured as a function of the incident angle,  $\alpha$ , of the ions. Figure 4.1-16 shows a scheme of the process for both the scattered and sputtered ions.

The incident ions cause recoil in the surface atoms. In studies of ionic liquids, only direct recoil – that is, motion in the forward direction – was measured. Watson and co-workers [56, 57] used time-of-flight analysis with a pulsed ion beam to measure the kinetic energies of the scattered and sputtered ions and therefore determine the masses of the recoiled surface atoms. By relating the measured intensities of the

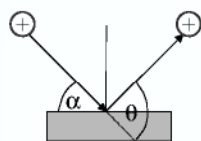

Scattered ions

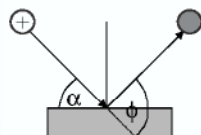

Sputtered(recoiled) ions

Figure 4.1-16: Schematic of the scattering process, showing the scattered ions and the recoiled ions. The figure has been redrawn from reference 57 with permission.

sputtered atoms to the scattering cross section, the surface concentration may be found. The variation of intensity with incident angle also allowed the orientation of the atoms on the surface to be elucidated. The scattered and sputtered ions are detected at angles of  $\theta$  and  $\phi$ , respectively, measured with respect to the incident ion beam. For all experiments so far reported on ionic liquids,  $\theta$  and  $\phi$  have been equal.

#### 4.1.9.1 Experimental set-up

Direct recoil spectrometry requires high and ultra-high vacuum conditions for the transport of ions to the sample and to the detector. In this regard, the use of ionic liquids, with their corresponding low vapor pressures, is ideal. To prevent contamination of the surface and any surface charging effects, Watson and co-workers used a rotating stainless steel wheel partially submerged in a reservoir holding the liquid sample, to create a fresh liquid surface continually. Before analysis, the liquid film passed by a blade, leaving a fresh surface approximately 0.1–0.2 mm thick. Figure 4.1-17 shows the typical sample set-up [58].

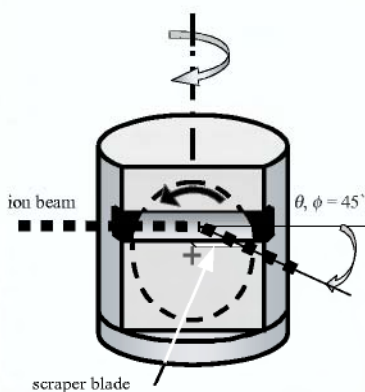

Figure 4.1-17: The experimental set-up used to generate thin films of ionic liquid for analysis by direct recoil spectrometry. Reproduced from reference 58 with permission.

#### 4.1.9.2 Examples

A number of ionic liquids – namely [OMIM][PF<sub>6</sub>], [BF<sub>4</sub>]<sup>-</sup>, Br<sup>-</sup>, Cl<sup>-</sup>; [BMIM][PF<sub>6</sub>], [BF<sub>4</sub>]<sup>-</sup>, and [C<sub>12</sub>MIM][BF<sub>4</sub>]<sup>-</sup> – have been studied by DRS. The scattering profile as a function of the incident angle for [OMIM][PF<sub>6</sub>] is shown in Figure 4.1-18.

The charged species were in all cases found to concentrate at the surface of the liquid under vacuum conditions. Little surface separation of the anions and cations was observed. For the [PF<sub>6</sub>]<sup>-</sup> and [BF<sub>4</sub>]<sup>-</sup> ions, the cation ring was found to prefer a perpendicular orientation to the surface, with the nitrogen atoms closest to the surface. An increase in the alkyl chain length caused the cation to rotate so that the alkyl chain moved into the bulk liquid, away from the surface, forcing the methyl group closer to the surface. For halide ionic liquids, the data were less clear and the cation could be fitted to a number of orientations.

#### 4.1.10

#### Conclusions

A wide range of structural techniques may be utilized for the study of ionic liquids and dissolved species. Overall, in both high-temperature and low-temperature ionic

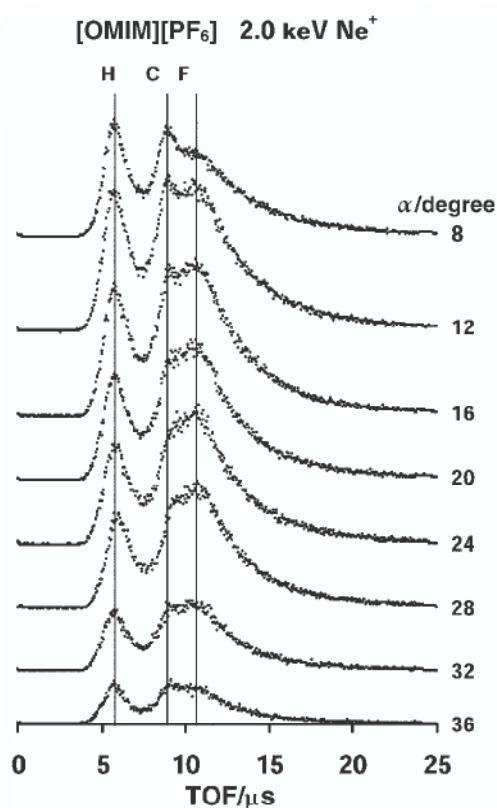

**Figure 4.1-18:** Ion intensity as a function of incident angle measured using time of flight direct recoil spectrometry on [OMIM][PF<sub>6</sub>]. Reproduced from reference 57 with permission.

liquids, as well as for mixtures, a close correlation between the solid structure and liquid is found. In many cases, significant intermediate order is observed, for example in the form of charge ordering.

### Acknowledgements

CH would like to thank Daniel Bowron (CLRC, Rutherford Appleton Laboratory), Fred Mosselmanns (CLRC, Daresbury Laboratory), Will Pitner (The Queen's University of Belfast), Nick Terrill (CLRC, Daresbury Laboratory), and Philip Watson (University of Oregon) for contributing figures, as well as for useful discussions and comments in the preparation of this manuscript.

### References

- 1 D.T. Bowron, J.L. Finney, A.K. Soper, *J. Phys. Chem.* **1998**, B102, 3551–3563.
- 2 C. Hardacre, J.D. Holbrey, S.E.J. McMath, *J. Chem. Soc. Chem. Commun.* **2001**, 367–368.
- 3 F.G. Edwards, J.E. Enderby, R.A. Howe, D.I. Page, *J. Phys. C* **1975**, 8, 3483–3490; S. Biggin, J.E. Enderby, *J. Phys. C* **1982**, 15, L305–309.
- 4 M. Blander, E. Bierwagen, K.G. Calkins, L.A. Curtiss, D.L. Price, M.-L. Saboungi, *J. Chem. Phys.* **1992**, 97, 2733–2741.
- 5 S.J. Cyvin, P. Klæboe, E. Rytter, H.A. Øye, *J. Chem. Phys.* **1970**, 52, 2776; J. Hvistendahl, P. Klæboe, E. Rytter, H.A. Øye, *Inorg. Chem.* **1984**, 23, 706–715.
- 6 Y.S. Badyal, D.A. Allen, R.A. Howe, *J. Phys.: Condens. Matter* **1994**, 6, 10,193–10,220.
- 7 Y.-C. Lee, D.L. Price, L.A. Curtiss, M.A. Ratner, D.F. Shriver, *J. Chem. Phys.* **2001**, 114, 4591–4594.
- 8 S. Takahashi, K. Suzuya, S. Kohara, N. Koura, L.A. Curtiss, M.-L. Saboungi, *Z. Phys. Chem.* **1999**, 209, 209–221.
- 9 P.C. Truelove, D. Haworth, R.T. Carlin, A.K. Soper, A.J.G. Ellison, D.L. Price, *Proc. 9th Int. Symp. Molten Salts, San Francisco 1994*, 3, 50–57, (Pennington, NJ: Electrochem. Soc.).
- 10 F.R. Trouw, D.L. Price, *Ann. Rev. Phys. Chem.* **1999**, 50, 571–601.
- 11 D.T. Bowron, C. Hardacre, J.D. Holbrey, S.E.J. McMath, A.K. Soper, *J. Chem. Phys.* *Submitted*.
- 12 P.A. Egelstaff, D.I. Page, J.G. Powles, *Mol. Phys.* **1971**, 20, 881 and *Mol. Phys.* **1971**, 22, 994.
- 13 A.K. Soper, *Chem. Phys.* **1996**, 202, 295–306; A.K. Soper, *Chem. Phys.* **2000**, 258, 121–137.
- 14 F. Vaslow, A.H. Narten, *J. Chem. Phys.* **1973**, 59, 4949–4954.
- 15 S. Takahashi, K. Maruoka, N. Koura, H. Ohno, *J. Chem. Phys.* **1986**, 84, 408–415; S. Takahashi, T.N. Muneta, N. Koura, H. Ohno, *J. Chem. Soc. Faraday Trans. II* **1985**, 81, 1107–1115.
- 16 K. Igarashi, Y. Okamoto, J. Mochinaga, H. Ohno, *J. Chem. Soc. Faraday Trans. I* **1988**, 84, 4407–4415.
- 17 S. Takahashi, N. Koura, M. Murase, H. Ohno, *J. Chem. Soc. Faraday Trans. II* **1986**, 82, 49–60.
- 18 C.J. Bowles, D.W. Bruce, K.R. Seddon, *J. Chem. Soc. Chem. Commun.* **1996**, 1625–1626.
- 19 R. Kind, S. Plesko, H. Arend, R. Blinc, B. Zeks, J. Seliger, B. Lozar, J. Slak, A. Levstik, C. Filipic, V. Zagar, G. Lahajnar, F. Milia, G. Chapuis, *J. Chem. Phys.* **1979**, 71, 2118–2130.



- 20 C.M. Gordon, J.D. Holbrey, A. Kennedy, K.R. Seddon, *J. Mater. Chem.* **1998**, *8*, 2627–2636. J.D. Holbrey, K.R. Seddon, *J. Chem. Soc., Dalton Trans.* **1999**, 2133–2139.
- 21 P.B. Hitchcock, K.R. Seddon, T. Welton, *J. Chem. Soc., Dalton Trans.* **1993**, 2639–2643.
- 22 F. Neve, A. Crispini, S. Armentano, O. Francescangeli, *Chem. Mater.* **1998**, *10*, 1904–1913.
- 23 F. Neve, O. Francescangeli, A. Crispini, J. Charmant, *Chem. Mater.* **2001**, *13*, 2032–2041.
- 24 C. Hardacre, J.D. Holbrey, P.B. McCormac, S.E.J. McMath, M. Nieuwenhuyzen, K.R. Seddon, *J. Mater. Chem.* **2001**, *11*, 346–350.
- 25 J.D. Martin, R. D. Rogers and K. R. Seddon (Eds) *ACS Symposium Series 818, ACS Washington DC, 2002*, p. 413–427.
- 26 G.F. Needham, R.D. Willett, H.F. Franzen, *J. Phys. Chem.* **1984**, *88*, 674–680.
- 27 A.E. Bradley, C. Hardacre, J. D. Holbrey, S. Johnston, S. E. J. McMath, M. Nieuwenhuyzen, *Chem. Mater.* **2002**, *14*, 629–635.
- 28 V. Busico, P. Corradini, M. Vacatello, *J. Phys. Chem.* **1982**, *86*, 1033–1034. V. Busico, P. Cernicchlaro, P. Corradini, M. Vacatello, *J. Phys. Chem.* **1983**, *87*, 1631–1635.
- 29 D.J. Abdallah, A. Robertson, H.–F. Hsu, R.G. Weiss, G., *J. Am. Chem. Soc.* **2000**, *122*, 3053–3062.
- 30 F. Artzner, M. Veber, M. Clerc, A.-M. Levelut, *Liq. Cryst.* **1997**, *23*, 27–33.
- 31 K.M. Lee, C.K. Lee, I.J.B. Lin, *J. Chem. Soc., Chem. Commun.* **1997**, 899–900.
- 32 C. Cruz, B. Heinrich, A.C. Ribeiro, D.W. Bruce, D. Guillon, *Liq. Cryst.* **2000** *27*, 1625–1631; D.W. Bruce, S. Estdale, D. Guillon, B. Heinrich, *Liq. Cryst.* **1995**, *19*, 301–305.
- 33 E.J.R. Sudhölter, J.B.F.N. Engberts, W.H. de Jeu, *J. Phys. Chem.* **1982**, *86*, 1908–1913.
- 34 Y. Haramoto, S. Ujiie, M. Nanasawa, *Liq. Cryst.* **1996**, *21*, 923–925, Y. Haramoto, M. Nanasawa, S. Ujiie, *Liq. Cryst.* **2001**, *28*, 557–560.
- 35 J. Jaklevic, J.A. Kirby, M.P. Klein, A.S. Robertson, G.S. Brown, P. Eisenberger, *Solid State Commun.* **1977**, *23*, 1679.
- 36 J.C. Mikkelsen, J.B. Boyce, R. Allen, *Rev. Sci. Instr.* **1980**, *51*, 388–389.
- 37 A.L. Ankudinov, B. Ravel, J.J. Rehr, S.D. Conradson, *Phys. Rev. B* **1998**, *58*, 7565–7576. J.J. Rehr, R.C. Albers, *Phys. Rev. B* **1990**, *41*, 8139–8149.
- 38 A. Filippini, A. Di Cicco, C.R. Natoli, *Phys. Rev. B* **1995**, *52*, 15,122–15,134.
- 39 N. Binsted, EXCURV98: CCLRC Daresbury Laboratory computer program, **1998**.
- 40 A. Filippini, *J. Phys.: Condensed Matter* **2001**, *13*, R23–60.
- 41 J.J. Rehr, R.C. Albers, *Rev. Mod. Phys.* **2000**, *72*, 621–654.
- 42 A. Di Cicco, M. Minicucci, A. Filippini, *Phys. Rev. Lett.* **1997**, *78*, 460–463; M. Minicucci, A. Di Cicco, *Phys. Rev. B* **1997**, *56*, 11,456–11,464.
- 43 A. Di Cicco, *J. Phys.: Condensed Matter* **1996**, *8*, 9341–9345.
- 44 L. Hefeng, L. Kunquan, W. Zhonghua, D. Jun, *J. Phys.: Condensed Matter* **1994**, *6*, 3629–3640.
- 45 A.J. Carmichael, C. Hardacre, J.D. Holbrey, M. Nieuwenhuyzen, K.R. Seddon, *Anal. Chem.* **1999**, *71*, 4572–4574.
- 46 A.J. Dent, K.R. Seddon, T. Welton, *J. Chem. Soc. Chem. Commun.* **1990**, 315–316.
- 47 A.J. Dent, A. Leas, R.J. Lewis, T. Welton, *J. Chem. Soc. Dalton Trans.* **1996**, 2787–2792.
- 48 G.M.N. Baston, A.E. Bradley, T. Gorman, I. Hamblett, C. Hardacre, J.E. Hatter, M.J.F. Healy, B. Hodgson, R. Lewin, K.V. Lovell, G.W.A. Newton, M. Nieuwenhuyzen, W.R. Pitner, D.W. Rooney, D. Sanders, K.R. Seddon, H.E. Simms, R.C. Thied, R. D. Rogers and K. R. Seddon (Eds) *ACS Symposium Series 818, ACS Washington DC, 2002*, p. 162–177. *Industrial Applications of Ionic Liquids*.
- 49 J.J. Laidler, J.E. Battles, W.E. Miller, J.P. Ackerman, E.L. Carls, *Progress in Nuclear Energy* **1997**, *31*, 131.

- 50 N.A. Hamill, C. Hardacre, S.E.J. McMath, *Green Chemistry*, **2002**, *4*, 143–146.
- 51 X.-L. Zhou, S.-H. Chen, *Phys. Rep.* **1995**, *257*, 223–348.
- 52 U. Englisch, F. Peñacorada, L. Brehmer, U. Pietsch, *Langmuir* **1999**, *15*, 1833–1841.
- 53 M.F. Toney, C.M. Mate, K.A. Leach, D. Pocker, *J. Coll. Int. Sci.* **2000**, *225*, 219–226.
- 54 A.J. Carmichael, C. Hardacre, J.D. Hollbrey, M. Nieuwenhuyzen, K.R. Seddon, *Mol. Phys.* **2001**, *99*, 795–800.
- 55 D.M. Mitrinovic, Z. Zhang, S.M. Williams, Z. Huang, M.L. Schlossman, *J. Phys. Chem.* **1999**, *103*, 1779–1782.
- 56 T.J. Gannon, G. Law, P.R. Watson, A.J. Carmichael, K.R. Seddon, *Langmuir* **1999**, *15*, 8429–8434; G. Law, P.R. Watson, *Chem. Phys. Lett.* **2001**, *345*, 1–4.
- 57 G. Law, P.R. Watson, A.J. Carmichael, K.R. Seddon, *Phys. Chem. Chem. Phys.* **2001**, *3*, 2879–2885.
- 58 M Tassotto, PhD Thesis, Dept. of Physics, Oregon State University, **2000**.

## 4.2

### Quantum Mechanical Methods for Structure Elucidation

W. Robert Carper, Zhizhong Meng, and Andreas Dölle

#### 4.2.1

##### Introduction

The description of electronic distribution and molecular structure requires quantum mechanics, for which there is no substitute. Solution of the time-independent Schrödinger equation,  $H\psi = E\psi$ , is a prerequisite for the description of the electronic distribution within a molecule or ion. In modern computational chemistry, there are numerous approaches that lend themselves to a reasonable description of ionic liquids. An outline of these approaches is given in Scheme 4.2-1 [1]:

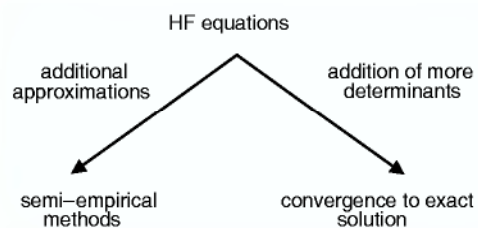

**Scheme 4.2-1:** Approaches used to describe ionic liquids in computational chemistry.

#### 4.2.2

##### Choice of Quantum Mechanical Methods

The choices of quantum mechanical method typically include the semi-empirical methods AM1, PM3, and MNDO/d [2–4]. These three methods (and some of their variations) are those most commonly used in the current literature. Of these semi-empirical methods, only MNDO/d includes the effects of d-orbitals. Some of the problems associated with these semiempirical methods include:

- (a) rotational barriers for bonds with partial double bond character are too low,
- (b) non-bonding interactions, such as in van der Waals complexes or hydrogen bonds, are poorly reproduced with AM1 and
- (c) nitrogen-containing groups often give pyramidal structures with PM3, when this is incorrect.

Despite these inconsistencies, the semi-empirical methods produce bond angles, bond lengths and heats of formation that are in reasonable agreement with experimental results. A new version, PM5, will soon be available and is four times more accurate than AM1 or PM3. The advantage of PM5 over the other semi-empirical methods is that d-orbitals are being introduced [5].

The ab initio methods used by most investigators include Hartree–Fock (HF) and Density Functional Theory (DFT) [6, 7]. An ab initio method typically uses one of many basis sets for the solution of a particular problem. These basis sets are discussed in considerable detail in references [1] and [8]. DFT is based on the proof that the ground state electronic energy is determined completely by the electron density [9]. Thus, there is a direct relationship between electron density and the energy of a system. DFT calculations are extremely popular, as they provide reliable molecular structures and are considerably faster than HF methods where correlation corrections (MP2) are included. Although intermolecular interactions in ion-pairs are dominated by dispersion interactions, DFT (B3LYP) theory lacks this term [10–14]. However, DFT theory is quite successful in representing molecular structure, which is usually a primary concern.

The investigator's choice of method (semi-empirical or ab initio) hinges on a number of factors, one of which is simple practicality concerning both time and expense. Semi-empirical methods usually give reasonable molecular structures and thermodynamic values at a fraction of the cost of ab initio calculations. Furthermore, molecular structures calculated by semi-empirical methods are the starting point for more complex ab initio calculations.

The advantages of ab initio calculations are considerable, but they come at a high cost. One of the many factors that affect the cost of computation is the choice of basis set. Often (not always!) one discovers that accuracy of physical parameters (and molecular structure) increases with the size of the basis set. Unfortunately, the formal scaling of HF methods is approximately  $N^4$  ( $N^3$  or less for semiempirical methods), where  $N$  is the number of basis functions. Hence, one quickly discovers that the solution of a problem requiring a few hours with a low-order basis set (3-21G<sup>\*</sup>) may end up taking several days with a higher-order basis set such as 6-31G(d,p) or 6-31G(dp,p) [1, 8]. Fortunately, many investigators now have access to high-speed parallel processor computers that can handle such large calculations.

#### 4.2.3

##### **Ion-pair Models and Possible Corrections**

Typically, the ionic liquid is best considered as an ion-pair (or ion, on an individual basis). The main forces of attraction between the ions are the electrostatic forces and dispersion (van der Waals) forces. At intermediate distances, there is a slight

attraction between the electron clouds of the ions. This is due to the phenomenon known as electron correlation, which is important in Hartree–Fock calculations. This correction is not necessary in completely parameterized semi-empirical methods.

The size of the ion-pair may dictate the method of calculation, although the increasing speed of computers, coupled with improved programming, encourage many to begin at the ab initio level of calculation. There are two types of corrections that should be considered with ab initio calculations. If one is working with neutral molecules, then BSSE (basis set superposition error) correction [15, 16] is necessary if one is accurately to determine values of hydrogen bonds in molecular complexes. With ion-pairs, however, the 4 to 8 kJ correction factor with BSSE is minimal compared with the correlation energy correction typically introduced with the use of Møller–Plesset perturbation theory [17]. The use of MP corrections at the 2<sup>nd</sup> level (MP2) is a computer-intensive correction and limits many calculations to very small molecular systems. This fact, coupled with the speed of density functional (DFT) calculations, has encouraged many investigators to use DFT when computer time is either expensive or in short supply [1, 8, 16]. The main advantage of DFT ab initio calculations is that the resulting molecular structure is usually accurate, although energies may be in doubt.

#### 4.2.4

##### Ab Initio Structures of Ionic Liquids

Figure 4.2-1 shows the calculated ab initio molecular structure of the ionic liquid [BMIM][PF<sub>6</sub>] (1-butyl-3-methylimidazolium hexafluorophosphate).

The basis set is 6-31G(d,p), and electron correlation at the MP2 level is included. A similar structure is obtained with the AM1 and PM3 semi-empirical methods. Density functional theory at the B3LYP/6-31G(dp,p) level also produced the same structure for this ion-pair. The only observed differences between the semi-empirical and the ab initio structures were slightly shorter hydrogen bonds (PM3 and AM1) between F1, F2, and F5 and the C2-H (H18) on the imidazolium ring.

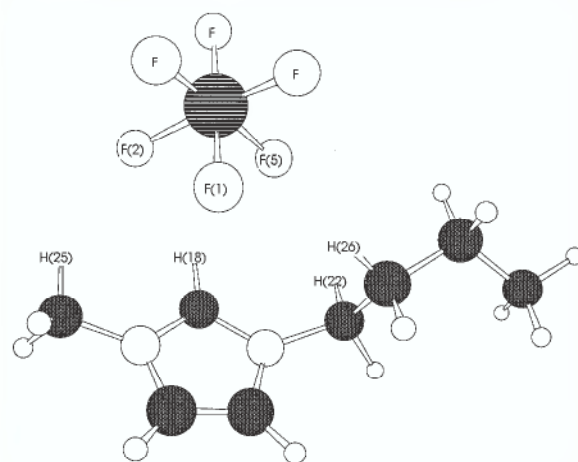

**Figure 4.2-1:** Molecular structure of [BMIM][PF<sub>6</sub>] (MP2/6-31G(d,p)). C–H–F distances are: 2.319 Å (H25–F2), 2.165 Å (H18–F2), 2.655 Å (H18–F1), 2.173 Å (H18–F5), 2.408 Å (H22–F5), 2.467 Å (H26–F1), and 2.671 Å (H26–F5). All H–F distances are less than the H–F van der Waals distance of 2.67 Å (see ref. [18]).

**Figure 4.2-2:** Molecular structure of [NMIM][PF<sub>6</sub>] (MP2/6-31G(d,p)). C-H-F distances are: 2.355 Å (H9-F1), 2.198 Å (H8-F41), 2.636 Å (H8-F46), 2.164 Å (H8-F44), 2.439 Å (H15-F44), 2.403 Å (H19-F46), and 2.582 Å (H19-F44). All H-F distances are less than the H-F van der Waals distance of 2.67 Å (see ref. [18]).

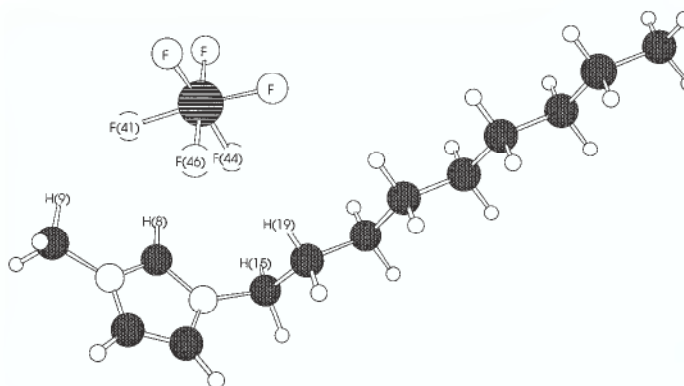

Another ionic liquid, containing a nonyl-rather than a butyl-side chain, is shown in Figure 4.2-2. There is little difference between the basic structures of these two ion-pairs (Figures 4.2-1 and 4.2-2) with respect to the non-bonded interactions (hydrogen bonds) occurring between the F atoms on the anion and the C-H moieties on the imidazolium cation.

#### 4.2.5

#### DFT Structure of 1-Methyl-3-nonylimidazolium Hexafluorophosphate

Figure 4.2-3 contains the DFT (B3LYP) structure of [NMIM][PF<sub>6</sub>] obtained with a 6-31G(d,p) basis set. Here one observes C-H-F hydrogen bonds shorter than those obtained from the MP2/6-31G(d,p) calculation shown in Figure 4.2-2.

Note that DFT structures are as reliable as or more reliable than HF structures obtained with similar or less complex basis sets.

**Figure 4.2-3:** Molecular structure of [NMIM][PF<sub>6</sub>] (B3LYP/6-31G(d,p)). C-H-F distances are: 2.293 Å (H38-F41), 2.094 Å (H18-F41), 2.441 Å (H18-F46), 2.051 Å (H18-F43), 2.482 Å (H19-F43), 2.296 Å (H22-F46), and 2.568 Å (H22-F43). All H-F distances are less than the H-F van der Waals distance of 2.67 Å (see ref. [18]).

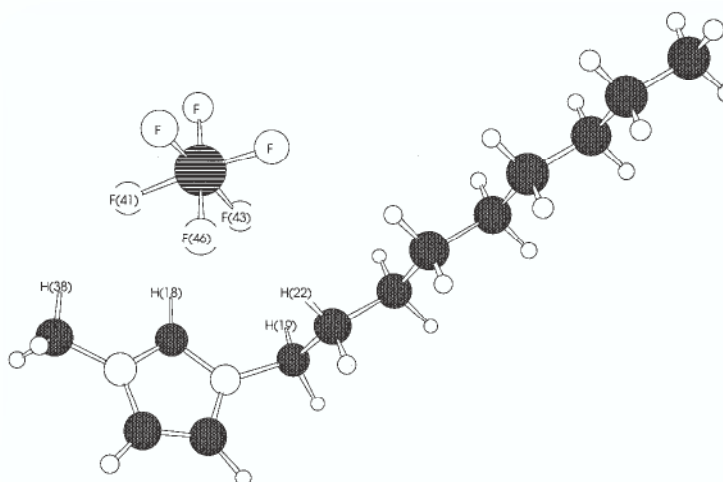

## 4.2.6

**Additional Information Obtained from Semi-empirical and Ab Initio Calculations**

In addition to the obvious structural information, vibrational spectra can also be obtained from both semi-empirical and ab initio calculations. Computer-generated IR and Raman spectra from ab initio calculations have already proved useful in the analysis of chloroaluminate ionic liquids [19]. Other useful information derived from quantum mechanical calculations include  $^1\text{H}$  and  $^{13}\text{C}$  chemical shifts, quadrupole coupling constants, thermochemical properties, electron densities, bond energies, ionization potentials and electron affinities. As semiempirical and ab initio methods are improved over time, it is likely that investigators will come to consider theoretical calculations to be a routine procedure.

**References**

- 1 F. Jensen, *Introduction to Computational Chemistry*, John Wiley & Sons, 1999, pp. 53–97.
- 2 M. J. S. Dewar, E. G. Zoebisch, E. F. Healy, J. J. P. Stewart, *J. Am. Chem. Soc.* **1985**, *107*, 3902.
- 3 J. J. P. Stewart, *J. Comput. Chem.* **1989**, *10*, 209.
- 4 W. Thiel, A. A. Voityuk, *J. Phys. Chem.* **1996**, *100*, 616.
- 5 J. J. P. Stewart, personal communication.
- 6 A. D. Becke, *J. Chem. Phys.* **1992**, *97*, 9173.
- 7 C. Lee, W. Yang, R. G. Parr, *Phys. Rev. B* **1988**, *37*, 785.
- 8 D. Young, *Computational Chemistry*, John Wiley & Sons, 2001, pp. 78–91.
- 9 P. Hohenberg, W. Kohn, *Phys. Rev. B* **1964**, *136*, 864.
- 10 J. Nagy, D. F. Weaver, V. H. Smith Jr., *Mol. Phys.* **1995**, *85*, 1179.
- 11 E. J. Meijer, M. Sprik, *J. Chem. Phys.* **1996**, *105*, 8684.
- 12 Y. Andersson, D. C. Langreth, B. I. Lundqvist, *Phys. Rev. Lett.* **1996**, *76*, 102.
- 13 W. Kohn, Y. Meir, D. E. Makarov, *Phys. Rev. Lett.* **1998**, *80*, 4153.
- 14 R. L. Rowley, T. Pakkanen, *J. Chem. Phys.* **1999**, *100*, 3368.
- 15 S. F. Boys, F. Bernardi, *Mol. Phys.* **1970**, *19*, 553.
- 16 F. B. Van Duijneveldt, *Molecular Interactions* (S. Scheiner ed.), John Wiley & Sons, 1997, pp. 81–104.
- 17 C. Møller, M. S. Plesset, *Phys. Rev.* **1934**, *46*, 618.
- 18 A. Bondi, *J. Phys. Chem.* **1964**, *68*, 441.
- 19 G. J. Mains, E. A. Nantsis, W. R. Carper, *J. Phys. Chem. A* **2001**, *105*, 4371.



### 4.3

#### Molecular Dynamics Simulation Studies

*Christof G. Hanke and Ruth M. Lynden-Bell*

##### 4.3.1

##### Performing Simulations

So far, there have been few published simulation studies of room-temperature ionic liquids, although a number of groups have started programs in this area. Simulations of molecular liquids have been common for thirty years and have proven important in clarifying our understanding of molecular motion, local structure and thermodynamics of neat liquids, solutions and more complex systems at the molecular level [1–4]. There have also been many simulations of molten salts with atomic ions [5]. Room-temperature ionic liquids have polyatomic ions and so combine properties of both molecular liquids and simple molten salts.

Atomistic simulations can be carried out at various levels of sophistication and the method of choice is a balance between computational cost and accuracy. The three main types of simulation are classical simulations, fully quantum simulations and hybrid methods. In classical simulations the molecules interact according to a force-field, which must be defined by the user. In quantum simulations the forces on the nuclei are calculated from quantum mechanical electronic energy at each step, which is found by solving approximations to the Schrödinger equation. In hybrid methods, part of the system is treated by quantum mechanics and the rest classically. For simulations of liquids one needs long runs to explore the many possible configurations corresponding to the liquid state. One also needs fairly large system sizes to remove the effects of periodic boundaries. Thus, while a crystalline solid can be simulated by the use of a few unit cells for a few picoseconds, a liquid needs ten to one hundred times as large a system and needs to be simulated for ten to one hundred times as long. This means that classical simulations are the most likely to be useful. The main limitation is that chemical bond formation or breaking cannot be described.

There are many molecular dynamics programs available for simulations, and the book by Allen and Tildesley [6] provides a very helpful introduction for anyone who wishes to perform simulations. The key points are:

- to use a reasonable potential,
- to treat the long-range electrostatics by an accurate method such as the Ewald summation,
- to use a large enough system (say 200 formula units or more) and
- to simulate for a sufficiently long time to sample a sufficient range of configurations typical of the liquid.

In a classical simulation a force-field has to be provided. Experience with molecular liquids shows that surprisingly good results can be obtained with intermolecular potentials based on site–site short-range interactions and a number of charged sites

on each molecule, and such models are used for the simulation of systems ranging from simple liquids to biomolecules [1–4]. The short-range interactions are repulsive at short distances, so that the distribution of sites determines the molecular shape in the model. A good description of the electrostatic interactions between different molecules is very important. It is also important to treat the long-range part of the electrostatics carefully. This is best done by the Ewald summation method [6]. Price et al. [7] have developed a model for methyl- and ethylimidazolium ions with charges on the atomic sites. The charges were taken from a distributed multipole analysis of a good quantum chemical calculation of isolated ions with a reasonable-sized basis set with correlations included at the MP2 level. Figure 4.3-1 shows the molecule and the contours of the electrostatic field due to the charges on the sites.

One can see that, while at large distances the contours approach the circular shape expected for an ion, there are considerable distortions near the molecule. The charge is distributed over the ring atoms, the ring protons, and the side chains, particularly on the methyl and methylene groups adjacent to the ring. The charge on the nitrogen atom is negative, while the other charges are all positive. This reflects the electronegativity of the nitrogen atom and is likely to be an important factor in determining the local structure in the liquid. This model was tested by comparison of the predicted and experimental crystal structures.

While this model provides a good description of the electrostatic potential around an isolated ion it does not include the effects of polarization due to the surrounding ions. One might anticipate that a molecule with an aromatic ring would be easily polarizable, and this lack of polarizability is a major shortcoming. The computational cost and problems of parametrizing a polarizable model do not seem worthwhile at this stage of the project. Some justification for this simplification can be taken from recent simulations of triazoles in our group [8]. Triazoles are neutral

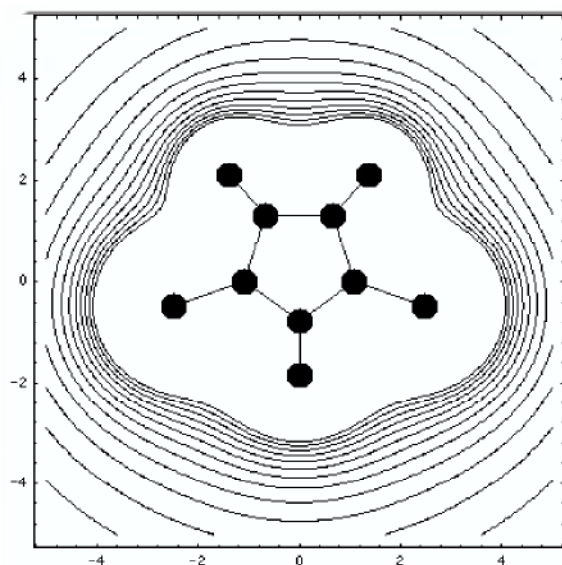

**Figure 4.3-1:** Contours of the electrostatic potential around the dimethylimidazolium ion.

molecules with five-membered rings containing nitrogen atoms, which have similarities to the imidazolium ions. Our recent work on simulations of a hybrid model of quantum triazoles dissolved in classical liquid water shows surprisingly small charge fluctuations (amplitude about 0.05 e or less). There is, however, a net polarization of the molecule in aqueous solution compared to in the gas phase. It may be useful in the future to try this type of calculation with imidazolium ions in the ionic liquid, although there are technical problems arising from the fact that the ions are charged. At this stage, simulations are being carried out with the fixed-charge model, which should describe the basic physics of the liquid although, given the comments above, we would not expect quantitative agreement. A further approximation frequently used in simulations of molecular liquids is to replace the methyl and methylene groups by single sites (united atoms). This saves between 35 % and 50 % of the computational effort for dimethylimidazolium salts.

#### 4.3.2

##### What can we Learn?

The simulation gives a sequence of configurations: that is, instantaneous positions and velocities of all the atoms in the system. In a molecular dynamics simulation these are a sequence in time, while Monte Carlo simulations give a sequence generated by random moves. These sequences can be analyzed to give structural information, average energies and pressures, and dynamics. Some of this analysis is normally carried out during the simulation (average energies, for example), while other analyses can be carried out later. The problem is to reduce the data to a manageable and comprehensible form. Structural information for liquids is often presented as radial distribution functions  $g_{AB}(r)$ . These functions show the ratio of the probability density for finding an atom of type A at distance  $r$  from an atom of type B relative to the average density of A atoms. Thus, regions where  $g$  is greater than unity

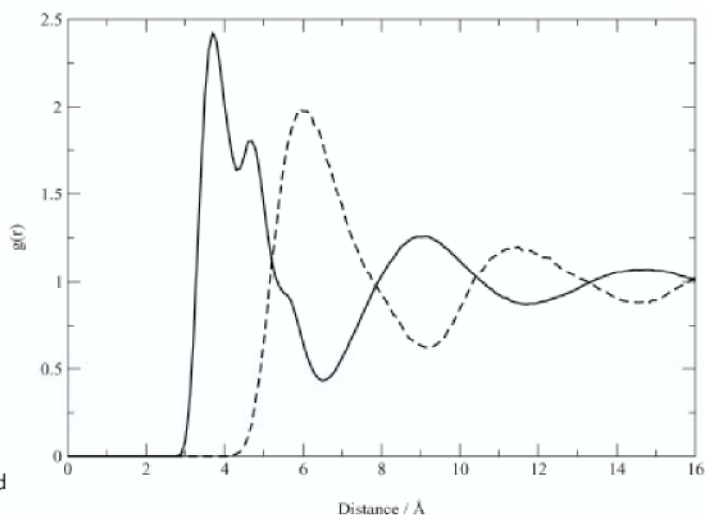

**Figure 4.3-2:** Radial distribution function for dimethylimidazolium and chloride ions relative to chloride. Full line: cation–anion; dashed line: anion–anion.

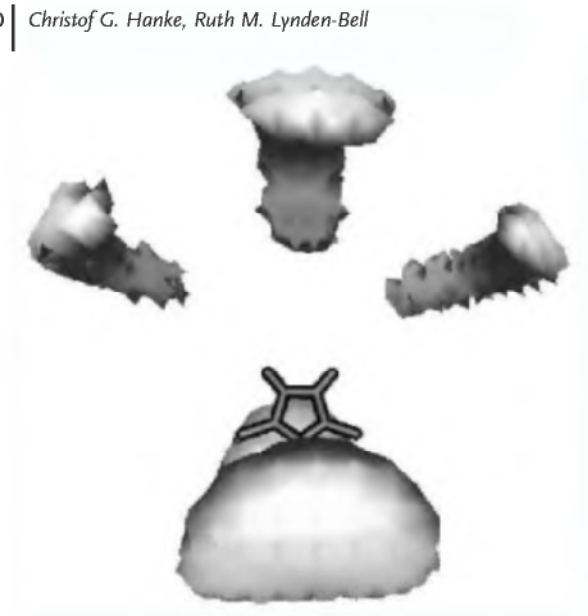

**Figure 4.3-3:** Three-dimensional distribution function of chloride ions relative to dimethylimidazolium ions.

have an enhanced probability of finding atoms of type B, while regions with  $g$  less than unity have a reduced probability. Figure 4.3-2 shows  $g(r)$  for chloride ions relative to the center of a dimethylimidazolium ion (or vice versa) and chloride ions relative to a chloride ion. The successive peaks and troughs are out of phase, showing the charge oscillations, which are quite long-ranged.

These are typical of ionic liquids and are familiar in simulations and theories of molten salts. The indications of structure in the first peak show that the local packing is complex. There are 5 to 6 nearest neighbors contributing to this peak. More details can be seen in Figure 4.3-3, which shows a contour surface of the three-dimensional probability distribution of chloride ions seen from above the plane of the molecular ion. The shaded regions are places at which there is a high probability of finding the chloride ions relative to any imidazolium ion.

Dynamic information such as reorientational correlation functions and diffusion constants for the ions can readily be obtained. Collective properties such as viscosity can also be calculated in principle, but it is difficult to obtain accurate results in reasonable simulation times. Single-particle properties such as diffusion constants can be determined more easily from simulations. Figure 4.3-4 shows the mean square displacements of cations and anions in dimethylimidazolium chloride at 400 K. The rapid rise at short times is due to rattling of the ions in the cages of neighbors. The amplitude of this motion is about 0.5 Å. After a few picoseconds the mean square displacement in all three directions is a linear function of time and the slope of this portion of the curve gives the diffusion constant. These diffusion constants are about a factor of 10 lower than those in normal molecular liquids at room temperature.

Figure 4.3-4: Mean square displacements of cations (full lines) and anions (dashed lines) in x, y, and z directions as a function of time.

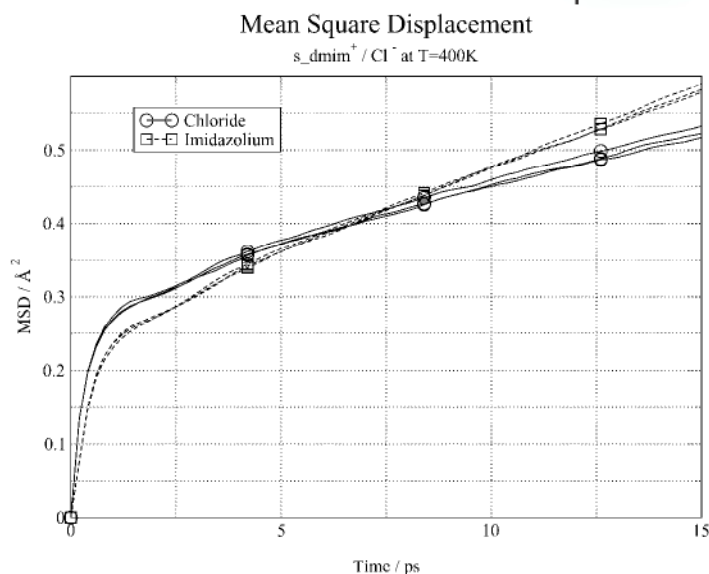

Thermodynamic information can also be obtained from simulations. Currently we are measuring the differences in chemical potential of various small molecules in dimethylimidazolium chloride. This involves gradually transforming one molecule into another and is a computationally intensive process. One preliminary result is that the difference in chemical potential of propane and dimethyl ether is about 17.5 kJ/mol. These molecules are similar in size, but differ in their polarity. Not surprisingly, the polar ether is stabilized relative to the non-polar propane in the presence of the ionic liquid. One can also investigate the local arrangement of the ions around the solute and the contribution of different parts of the interaction to the energy. Thus, while both molecules have a favorable Lennard-Jones interaction with the cation, the main electrostatic interaction is that between the chloride ion and the ether molecule.

## References

- 1 J. E. Shea, C. L. Brooks, *Annu. Rev. Phys. Chem.* **2001**, *52*, 499.
- 2 P. La Rocca, P. C. Biggin, D. P. Tieleman, M. S. P. Sansom, *Biochim. Biophys. Acta (Biomembranes)* **1999**, *1462*, 185.
- 3 P. C. Biggin, M. S. P. Sansom, *Biophys. Chem.* **1999**, *76*, 161.
- 4 P. A. Bopp, A. Kohlmeyer, E. Spohr, *Electrochim. Acta* **1998**, *43*, 2911.
- 5 P. A. Madden, M. Wilson, *J. Phys., Condens. Matter* **2000**, *12*, A95.
- 6 M. P. Allen and D. J. Tildesley, *Computer Simulation of Liquids*, Oxford University Press, Oxford **1987**.
- 7 C. G. Hanke, S. L. Price, R. M. Lynden-Bell, *Mol. Phys.* **2001**, *99*, 801.
- 8 S. Murdock, G. Sexton, R. M. Lynden-Bell, in preparation.

## 4.4

## Translational Diffusion

Joachim Richter, Axel Leuchter, and Günter Palmer

## 4.4.1

## Main Aspects and Terms of Translational Diffusion

Looking at translational diffusion in liquid systems, at least two elementary categories have to be taken into consideration: self-diffusion and mutual diffusion [1, 2].

In a liquid that is in thermodynamic equilibrium and which contains only one chemical species,<sup>a</sup> the particles are in translational motion due to thermal agitation. The term for this motion, which can be characterized as a random walk of the particles, is *self-diffusion*. It can be quantified by observing the molecular displacements of the single particles. The self-diffusion coefficient  $D_s$  is introduced by the Einstein relationship

$$D_s = \lim_{t \rightarrow \infty} \frac{1}{6t} \langle |\bar{r}(t) - \bar{r}(0)|^2 \rangle \quad (4.4-1)$$

where  $\bar{r}(t)$  and  $\bar{r}(0)$  denote the locations of a particle at time  $t$  and 0, respectively. The brackets indicate that the ensemble average is used.

However, self-diffusion is not limited to one-component systems. As illustrated in Figure 4.4-1, the random walk of particles of each component in any composition of a multicomponent mixture can be observed.

If a liquid system containing at least two components is not in thermodynamic equilibrium due to concentration inhomogeneities, transport of matter occurs. This process is called *mutual diffusion*. Other synonyms are chemical diffusion, interdiffusion, transport diffusion, and, in the case of systems with two components, binary diffusion.

The description of mass transfer requires a separation of the contributions of *convection* and mutual diffusion. While convection means macroscopic motion of complete volume elements, mutual diffusion denotes the macroscopically perceptible relative motion of the individual particles due to concentration gradients. Hence, when measuring mutual diffusion coefficients, one has to avoid convection in the system or, at least has to take it into consideration.

Mutual diffusion is usually described by Fick's first law, written here for a system with two components and one-dimensional diffusion in the  $z$ -direction:

$$\bar{J}_i = -D_i \frac{\partial c_i}{\partial z} \quad (i = 1, 2). \quad (4.4-2)$$

<sup>a</sup> Components are those substances, the amounts of which can be changed independently from others, while chemical species

mean any particles in the sense of chemistry (atoms, molecules, radicals, ions, electrons) which appear at all in the system [3].



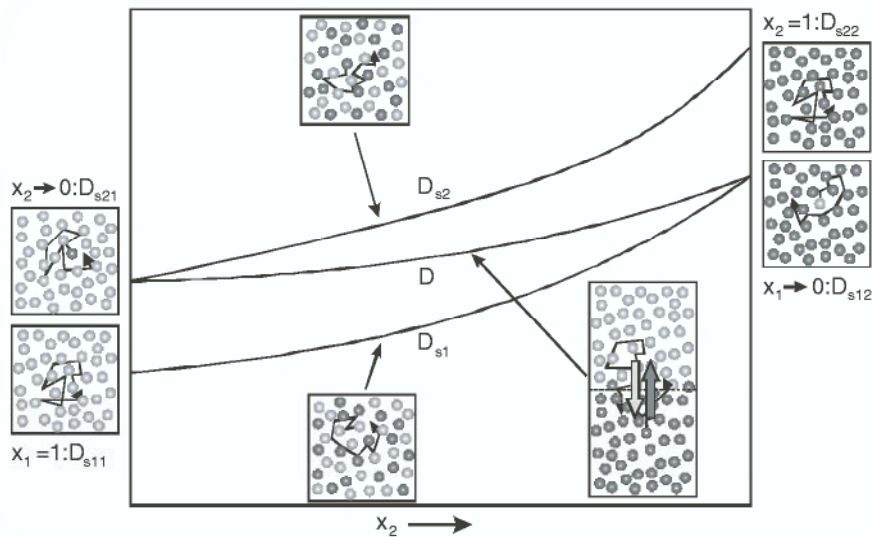

**Figure 4.4-1:** Self-diffusion and mutual diffusion in a binary mixture. The self-diffusion coefficients are denoted with  $D_{s1}$  and  $D_{s2}$ , the mutual diffusion coefficient with  $D$ . The self-diffusion coefficients of the pure liquids  $D_{s11}$  and  $D_{s22}$ , respectively, are marked at  $x_1 = 1$  and  $x_2 = 1$ . Extrapolations  $x_1 \rightarrow 0$  and  $x_2 \rightarrow 0$  give the self-diffusion coefficients  $D_{s12}$  and  $D_{s21}$ .

Equation 4.4-2 describes the flux density  $\vec{J}_i$  (in  $\text{mol m}^{-2} \text{s}^{-1}$ ) of component  $i$  through a reference plane, caused by the concentration gradient  $\partial c_i / \partial z$  (in  $\text{mol m}^{-4}$ ). The factor  $D_i$  (in  $\text{m}^2 \text{s}^{-1}$ ) is called the diffusion coefficient.

Most mutual diffusion experiments use Fick's second law, which permits the determination of  $D_i$  from measurements of the concentration distribution as a function of position and time:

$$\frac{\partial c_i}{\partial t} = D_i \frac{\partial^2 c_i}{\partial z^2} \quad (4.4-3)$$

Solutions for this second-order differential equation are known for a number of initial and boundary conditions [4].

In a system with two components, one finds experimentally the same values for  $D_1$  and  $D_2$  because  $\vec{J}_1$  is not independent from  $\vec{J}_2$ . It follows that the system can be described with only one mutual diffusion coefficient  $D = D_1 = D_2$ .

In the case of systems containing ionic liquids, components and chemical species have to be differentiated. The methanol/[BMIM][PF<sub>6</sub>] system, for example, consists of two components (methanol and [BMIM][PF<sub>6</sub>]) but – on the assumption that [BMIM][PF<sub>6</sub>] is completely dissociated – three chemical species (methanol, [BMIM]<sup>+</sup> and [PF<sub>6</sub>]<sup>-</sup>). If [BMIM][PF<sub>6</sub>] is not completely dissociated, one has a fourth species, the undissociated [BMIM][PF<sub>6</sub>]. From this it follows that the diffusive transport can be described with three and four flux equations, respectively. The fluxes of [BMIM]<sup>+</sup>

and  $[\text{PF}_6]^-$  are not independent, however, because of electroneutrality in each volume of the system. Furthermore, the flux of  $[\text{BMIM}][\text{PF}_6]$  is not independent of the flux of the ions because of the dissociation equilibrium. Thus, the number of independent fluxes is reduced to one, and the system can be described with only one mutual diffusion coefficient. In addition, one has four self-diffusion coefficients –  $D_s(\text{methanol})$ ,  $D_s([\text{BMIM}]^+)$ ,  $D_s([\text{PF}_6]^-)$ , and  $D_s([\text{BMIM}][\text{PF}_6])$  – so that five diffusion coefficients are necessary to describe the system completely.

#### 4.4.2

##### Use of Translational Diffusion Coefficients

Following the general trend of looking for a molecular description of the properties of matter, self-diffusion in liquids has become a key quantity for interpretation and modeling of transport in liquids [5]. Self-diffusion coefficients can be combined with other data, such as viscosities, electrical conductivities, densities, etc., in order to evaluate and improve solvodynamic models such as the Stokes–Einstein type [6–9]. From temperature-dependent measurements, activation energies can be calculated by the Arrhenius or the Vogel–Tamman–Fulcher equation (VTF), in order to evaluate models that treat the diffusion process similarly to diffusion in the solid state with jump or hole models [1, 2, 7].

From the molecular point of view, the self-diffusion coefficient is more important than the mutual diffusion coefficient, because the different self-diffusion coefficients give a more detailed description of the single chemical species than the mutual diffusion coefficient, which characterizes the system with only one coefficient. Owing to its cooperative nature, a theoretical description of mutual diffusion is expected to be more complex than one of self-diffusion [5]. Besides that, self-diffusion measurements are determinable in pure ionic liquids, while mutual diffusion measurements require mixtures of liquids.

From the applications point of view, mutual diffusion is far more important than self-diffusion, because the transport of matter plays a major role in many physical and chemical processes, such as crystallization, distillation or extraction. Knowledge of mutual diffusion coefficients is hence valuable for modeling and scaling-up of these processes.

The need to predict mutual diffusion coefficients from self-diffusion coefficients often arises, and many efforts have been made to understand and predict mutual diffusion data, through approaches such as, for example, the following extension of the Darken equation [5]:

$$D = (x_2 D_{21} + x_1 D_{12}) \Gamma, \text{ with } \Gamma = \frac{d \ln a_1}{d \ln x_1} = \frac{d \ln a_2}{d \ln x_2} \quad (4.4-4)$$

where  $a_i$  is the activity of component  $i$ .  $\Gamma$  is denoted as the thermodynamic factor.

Systems that are near to ideality can be described satisfactorily with Equation 4.4-4, but the equation does not work very well in systems that are far from thermodynamic ideality, even if the self-diffusion coefficients and activities are known. Since systems with ionic liquids show strong intermolecular forces, there is a need

to find better predictions of the mutual diffusion coefficients from self-diffusion coefficients.

Since the prediction of mutual diffusion coefficients from self-diffusion coefficients is not accurate enough to be used for modeling of chemical processes, complete data sets of mutual and self-diffusion coefficients are necessary and valuable.

#### 4.4.3

##### Experimental Methods

Nowadays, self-diffusion coefficients are almost exclusively measured by NMR methods, through the use of methods such as the  $90^\circ\text{-}\delta\text{-}180^\circ\text{-}\delta$ -echo technique (Stejskal and Tanner sequence) [10–12]. The pulse-echo sequence, illustrated in Figure 4.4-2, can be divided into two periods of time  $\tau$ . After a  $90^\circ$  radio-frequency (RF) pulse the macroscopic magnetization is rotated from the  $z$ -axis into the  $x$ - $y$ -plane. A gradient pulse of duration  $\delta$  and magnitude  $g$  is applied, so that the spins dephase. After a time  $\tau$ , a  $180^\circ$  RF pulse reverses the spin precession. A second gradient pulse of equal duration  $\delta$  and magnitude  $g$  follows to tag the spins in the same way. If the spins have not changed their position in the sample, the effects of the two applied gradient pulses compensate each other, and all spins refocus. If the spins have moved due to self-diffusion, the effects of the gradient pulses do not compensate and the echo-amplitude is reduced. The decrease of the amplitude  $A$  with the applied gradient is proportional to the movement of the spins and is used to calculate the self-diffusion coefficient.

Popular methods for mutual diffusion measurements in fluid systems are the Taylor dispersion method and interferometric methods, such as Digital Image Holography [13, 14].

With digital image holography it is possible to measure mutual diffusion coefficients in systems that are fairly transparent to laser light and the components of which have a significant difference in their refractive indexes. The main idea of this method is to initiate a diffusion process by creating a so-called step-profile between two mixtures of a binary system with slightly different concentrations. The change

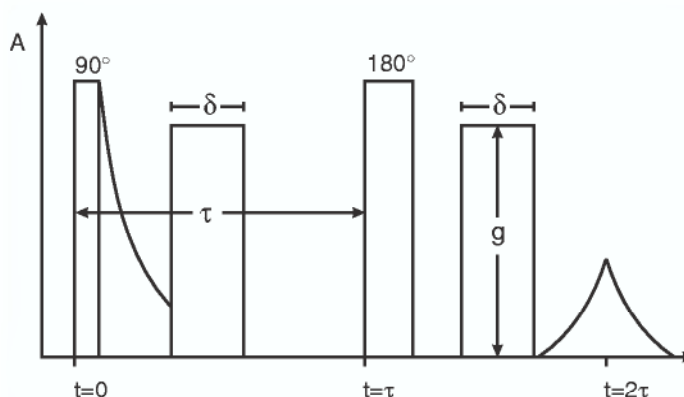

Figure 4.4-2: Pulse-echo sequence in an NMR experiment for the measurement of self-diffusion coefficients.

in the step-profile is associated with the change of the optical phase profile, which can be scanned by a coherent laser beam passing perpendicular to the diffusion axis  $z$  through the diffusion cell. The state of the diffusion cell at a certain time is stored as a hologram on a CCD camera. The hologram is processed with holograms taken at different times to produce interference patterns, which indicate the change in the diffusion cell with time. By use of Fick's second law, the diffusion coefficient can be calculated from a single interference pattern. Mutual diffusion coefficients are accessible over the whole composition range of binary mixtures [15].

With electrochemical methods such as chronoamperometry, cyclic voltammetry (CV), or conductivity measurements, the diffusion coefficients of charged chemical species can be estimated in highly dilute solutions [16, 17].

#### 4.4.4

#### Results for Ionic Liquids

Typical values of self-diffusion coefficients and mutual diffusion coefficients in aqueous solutions and in molten salt systems such as  $(K,Ag)NO_3$  are of the order of  $10^{-9} \text{ m}^2\text{s}^{-1}$ , and the coefficients do not usually vary by more than a factor of 10 over the whole composition range [1, 2, 15]. From measurements in pure ionic liquids we have learned that their self-diffusion coefficients are only of the order of  $10^{-11} \text{ m}^2\text{s}^{-1}$ . From this point of view it is interesting to investigate systems of "ordinary" and ionic liquids. Figure 4.4-3 shows the results of first measurements in the methanol/[BMIM][PF<sub>6</sub>] system, which can be seen as a prototype for a system in which an organic and an ionic liquid are mixed.

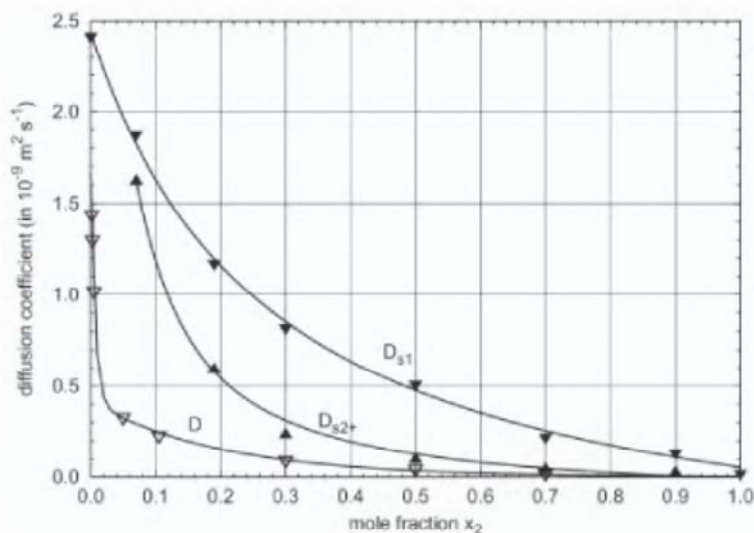

**Figure 4.4-3:** Self-diffusion and mutual diffusion coefficients in the methanol/[BMIM][PF<sub>6</sub>] system.  $x_2$ : mole fraction of [BMIM][PF<sub>6</sub>],  $D$ : mutual diffusion coefficient,  $D_{s1}$ : self-diffusion coefficient of methanol,  $D_{s2+}$ : self-diffusion coefficient of [BMIM]<sup>+</sup>.

Self-diffusion coefficients were measured with the NMR spin-echo method and mutual diffusion coefficients by digital image holography. As can be seen from Figure 4.4-3, the diffusion coefficients show the whole bandwidth of diffusion coefficient values, from  $10^{-9} \text{ m}^2\text{s}^{-1}$  on the methanol-rich side, down to  $10^{-11} \text{ m}^2\text{s}^{-1}$  on the [BMIM][PF<sub>6</sub>]-rich side. The concentration dependence of the diffusion coefficients on the methanol-rich side is extreme, and shows that special care and attention should be paid in the dimensioning of chemical processes with ionic liquids.

Since this is just the beginning of investigations into the diffusion behavior and intermolecular forces in ionic liquid systems, further experimental work needs to be done both with pure ionic liquids and with systems of mixtures of ionic and organic liquids.

## References

- 1 H.J.V. Tyrrell and K.R. Harris, *Diffusion in Liquids*, Butterworths, London, 1984.
- 2 E.L. Cussler, *Diffusion - Mass Transfer in Fluid Systems*, Cambridge University Press, Cambridge, 1984.
- 3 R. Haase, *Thermodynamics of irreversible processes*, Dover Publications, Mineola (NY), 1990.
- 4 J. Crank, *The Mathematics of Diffusion*, 2nd ed., Clarendon Press, Oxford, 1975.
- 5 H. Weingärtner, in: *Diffusion in Condensed Matter* (J. Kärgler, P. Heitjans, and R. Haberlandt eds.), Vieweg, Wiesbaden, 1998.
- 6 W.R. Carper, G.J. Mains, B.J. Piersma, S.L. Mansfield, and C.K. Larive, *J. Phys. Chem.* 1996, 100, 4724.
- 7 N. Weiden, B. Wittekopf, and K.G. Weil, *Ber. Bunsenges. Phys. Chem.* 1990, 94, 353.
- 8 J.-F. Huang, P.-Y. Chen, I.W. Sun, and S.P. Wang, *Inorganica Chimica Acta* 2001, 320, 7.
- 9 C.K. Larive, M. Lin, B.J. Piersma, and W.R. Carper, *J. Phys. Chem.* 1995, 99, 12,409.
- 10 W.S. Price, *Concepts Magn. Reson.* 1997, 9, 299.
- 11 W.S. Price, *Concepts Magn. Reson.* 1998, 10, 197.
- 12 U. Matenaar, J. Richter, and M.D. Zeidler, *J. Magn. Reson. A* 1996, 122, 72.
- 13 E. Marquardt and J. Richter, *Opt. Eng.* 1998, 37, 1514.
- 14 E. Marquardt, N. Großer, and J. Richter, *Opt. Eng.* 1997, 36, 2857.
- 15 A. Leuchter and J. Richter, *High Temp. Material Processes* 1998, 2, 521.
- 16 C.L. Hussey, I.-W. Sun, S.K.D. Strubinger, and P.A. Barnard, *J. Electrochem. Soc.* 1990, 137, 2515.
- 17 R.A. Osteryoung and M. Lipsztajn, *J. Electrochem. Soc.* 1985, 132, 1126.

## 4.5

**Molecular Reorientational Dynamics***Andreas Dölle and W. Robert Carper*

## 4.5.1

**Introduction**

Models for description of liquids should provide us with an understanding of the dynamic behavior of the molecules, and thus of the routes of chemical reactions in the liquids. While it is often relatively easy to describe the molecular structure and dynamics of the gaseous or the solid state, this is not true for the liquid state. Molecules in liquids can perform vibrations, rotations, and translations. A successful model often used for the description of molecular rotational processes in liquids is the rotational diffusion model, in which it is assumed that the molecules rotate by small angular steps about the molecular rotation axes. One quantity to describe the rotational speed of molecules is the reorientational correlation time  $\tau$ , which is a measure for the average time elapsed when a molecule has rotated through an angle of the order of 1 radian, or approximately  $60^\circ$ . It is indirectly proportional to the velocity of rotational motion.

## 4.5.2

**Experimental Methods**

A particularly important and convenient experimental method with which to obtain information on the reorientational dynamics of molecules is the measurement of longitudinal or spin–lattice relaxation times  $T_1$  of peaks in nuclear magnetic resonance (NMR) spectra [1, 2]. These relaxation times describe how quickly a nuclear spin system reaches thermal equilibrium after disturbance of the system. Longitudinal relaxation is the relaxation process for the magnetization along the  $z$  axis, being parallel to the static magnetic field used in NMR spectroscopy. During this relaxation process, energy is exchanged between the spin system and its environment—the lattice. The measurement of  $^{13}\text{C}$  relaxation data [3] has great advantages for the study of the reorientational behavior of organic molecules; only one signal is usually obtained for each carbon atom in the molecule, so that the mobility or flexibility of different molecular segments can be studied. Spin diffusion processes, dipolar  $^{13}\text{C}$ – $^{13}\text{C}$  interactions, and – for  $^{13}\text{C}$  nuclei with directly bonded protons – intermolecular interactions can be neglected. The dipolar  $^{13}\text{C}$  spin–lattice relaxation rates  $1/T_1^{\text{DD}}$ , which are related to the velocity of the molecular rotational motions (see below), are obtained by measurement of  $^{13}\text{C}$  spin–lattice relaxation rates  $1/T_1$  and the nuclear Overhauser enhancement (NOE) factors  $\eta$  of the corresponding carbon atoms:

$$\frac{1}{T_1^{\text{DD}}} = \frac{\eta}{1.988} \frac{1}{T_1}. \quad (4.5-1)$$



A simple, but accurate way to determine spin–lattice relaxation rates is the inversion–recovery method [4]. In this experiment, the magnetization is inverted by a 180° radio frequency pulse and relaxes back to thermal equilibrium during a variable delay. The extent to which relaxation is gained by the spin system is observed after a 90° pulse, which converts the longitudinal magnetization into detectable transversal magnetization. The relaxation times for the different peaks in the NMR spectrum can be obtained by means of a routine for determination of the spin–lattice relaxation time, which is usually implemented in the spectrometer software. When the inversion–recovery pulse sequence is applied under <sup>1</sup>H broadband decoupling conditions, only one signal is observed for each <sup>13</sup>C nucleus and the relaxation is governed by only one time constant 1/*T*<sub>1</sub>. The NOE factors are obtained by comparing signal intensities *I*<sub>dec</sub> from <sup>1</sup>H broadband decoupled <sup>13</sup>C NMR spectra with those from inverse gated decoupled spectra *I*<sub>igdec</sub> with the relationship

$$\eta = \frac{I_{\text{dec}}}{I_{\text{igdec}}} - 1. \quad (4.5-2)$$

#### 4.5.3

##### Theoretical Background

Usually, nuclear relaxation data for the study of reorientational motions of molecules and molecular segments are obtained for non-viscous liquids in the extreme narrowing region where the product of the resonance frequency and the reorientational correlation time is much less than unity [1, 3, 5]. The dipolar <sup>13</sup>C spin–lattice relaxation rate of <sup>13</sup>C nucleus *i* is then directly proportional to the reorientational correlation time  $\tau_i$

$$\left(\frac{1}{T_1^{\text{DD}}}\right)_i = n_{\text{H}} (2\pi D_{ij})^2 \tau_p \quad (4.5-3)$$

with the dipolar coupling constant

$$D_{ij} = \frac{\mu_0}{4\pi} \gamma_{\text{C}} \gamma_{\text{H}} \frac{\hbar}{2\pi} r_{ij}^{-3}, \quad (4.5-4)$$

where  $\mu_0$  is the magnetic permeability of the vacuum,  $\gamma_{\text{C}}$  and  $\gamma_{\text{H}}$  are the magnetogyric ratios of the <sup>13</sup>C and <sup>1</sup>H nuclei, respectively,  $\hbar = h/2\pi$ , with the Planck constant  $h$ , and  $r_{ij}$  is the length of the internuclear vector between <sup>13</sup>C nucleus *i* and interacting proton *j*. For the relaxation of <sup>13</sup>C nuclei with  $n_{\text{H}}$  directly bonded protons, only interaction with these protons has to be taken into account.

Ionic liquids, however, are often quite viscous, and the measurements are thus beyond the extreme narrowing region. The relaxation rates hence become frequency-dependent. Under these conditions, the equation for the spin–lattice relaxation rate becomes more complex:

$$\left(\frac{1}{T_1^{\text{DD}}}\right)_i = \frac{1}{20} (2\pi D_{ij})^2 [J_i(\omega_{\text{C}} - \omega_{\text{H}}) + 3J_i(\omega_{\text{C}}) + 6J_i(\omega_{\text{C}} + \omega_{\text{H}})]. \quad (4.5-5)$$

Here, the  $J_i$  terms are the spectral densities with the resonance frequencies  $\omega$  of the  $^{13}\text{C}$  and  $^1\text{H}$  nuclei, respectively. It is now necessary to find an appropriate spectral density to describe the reorientational motions properly (cf. [6, 7]). The simplest spectral density commonly used for interpretation of NMR relaxation data is the one introduced by Bloembergen, Purcell, and Pound [8].

$$J_{\text{BPP},i}(\omega) = \frac{2\tau_{\text{BPP},i}}{1 + (\omega\tau_{\text{BPP},i})^2} \quad (4.5-6)$$

Cole and Davidson's continuous distribution of correlation times [9] has found broad application in the interpretation of relaxation data of viscous liquids and glassy solids. The corresponding spectral density is:

$$J_{\text{CD},i}(\omega, \tau_{\text{CD},i}, \beta_i) = \frac{2}{\omega} \frac{\sin(\beta_i \arctan(\omega\tau_{\text{CD},i}))}{(1 + (\omega\tau_{\text{CD},i})^2)^{\beta_i/2}}. \quad (4.5-7)$$

Another way to describe deviations from the simple BPP spectral density is the so-called model-free approach of Lipari and Szabo [10]. This takes account of the reduction of the spectral density usually observed in NMR relaxation experiments. Although the model-free approach was first applied mainly to the interpretation of relaxation data of macromolecules, it is now also used for fast internal dynamics of small and middle-sized molecules. For very fast internal motions the spectral density is given by:

$$J_{\text{LS},i}(\omega) = S_i^2 J_i, \quad (4.5-8)$$

which simply means a reduction of the BPP or CD spectral density  $J_i$  by the generalized order parameter  $S^2$ .

The resonance frequencies of the nuclei are given by the accessible magnetic field strengths through the resonance condition. Since the magnets used for NMR spectroscopy usually have fixed field strengths, the correlation times (that is, the rotational dynamics) have to be varied to leave the extreme narrowing regime. One way to vary the correlation times, and thus the spectral densities and relaxation data, is to change the temperature. The temperature dependence of the correlation times is often given by an Arrhenius equation:

$$\tau_i = \tau_{A,i} \exp(E_{A,i} / RT), \quad (4.5-9)$$

with the gas constant  $R$  and the activation energy  $E_A$ , interpreted below as a fit parameter representing a measure of the hindrance of the corresponding reorientational process.

## 4.5.4

## Results for Ionic Liquids

The measurement of correlation times in molten salts and ionic liquids has recently been reviewed [11] (for more recent references refer to Carper et al. [12]). We have measured the  $^{13}\text{C}$  spin–lattice relaxation rates  $1/T_1$  and nuclear Overhauser factors  $\eta$  in temperature ranges in and outside the extreme narrowing region for the neat ionic liquid [BMIM][PF<sub>6</sub>], in order to observe the temperature dependence of the spectral density. Subsequently, the models for the description of the reorientational dynamics introduced in the theoretical section (Section 4.5.3) were fitted to the experimental relaxation data. The  $^{13}\text{C}$  nuclei of the aliphatic chains can be assumed to relax only through the dipolar mechanism. This is in contrast to the aromatic  $^{13}\text{C}$  nuclei, which can also relax to some extent through the chemical-shift anisotropy mechanism. The latter mechanism has to be taken into account to fit the models to the experimental relaxation data (cf. [1] or [3] for more details). Preliminary results are shown in Figures 4.5-1 and 4.5-2, together with the curves for the fitted functions.

Table 4.5-1 gives values for the fit parameters and the reorientational correlation times calculated from the dipolar relaxation rates.

The largest correlation times, and thus the slowest reorientational motion, were shown by the three  $^{13}\text{C}$ - $^1\text{H}$  vectors of the aromatic ring, with values of between approximately 60 and 70 ps at 357 K, values expected for viscous liquids like ionic liquids. The activation energies are also in the typical range for viscous liquids. As can be seen from Table 4.5-1, the best fit was obtained for a combination of the Cole–Davidson with the Lipari–Szabo spectral density, with a distribution parame-

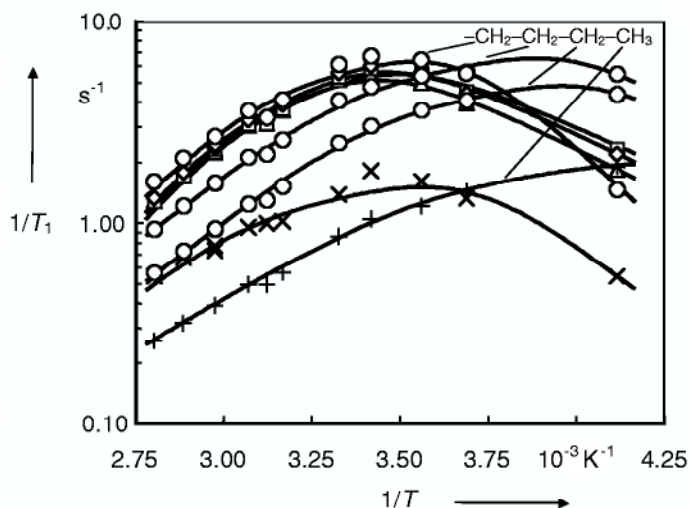

Figure 4.5-1:  $^{13}\text{C}$  relaxation rates  $1/T_1$  of [BMIM][PF<sub>6</sub>] in the neat liquid as a function of reciprocal temperature  $T$  ( $\Delta$ : C2,  $\square$  and  $\diamond$ : C4 and C5,  $\times$ : CH<sub>3</sub>(ring),  $+$ : CH<sub>3</sub>(butyl group),  $\circ$ : CH<sub>2</sub>, lines: functions calculated with the fitted parameters).

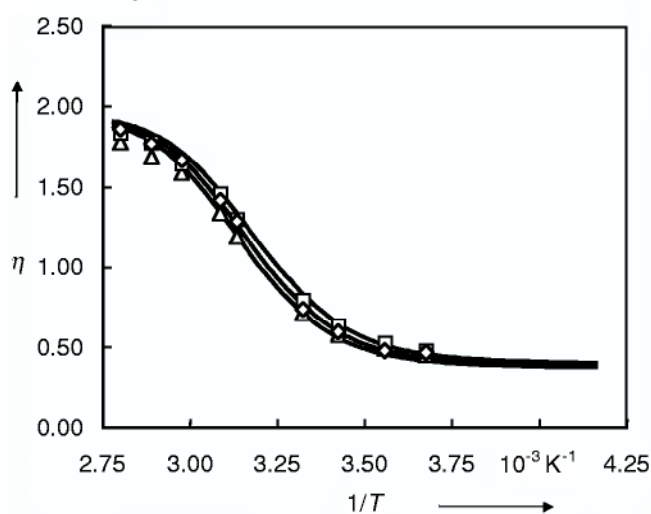

Figure 4.5-2:  $\{^1\text{H}\}\text{-}^{13}\text{C}$  NOE factors  $\eta$  for [BMIM][PF<sub>6</sub>] in the neat liquid as a function of reciprocal temperature  $T$  ( $\Delta$ : C2,  $\square$  and  $\diamond$ : C4 and C5, lines: functions calculated with the fitted parameters).

ter  $\beta$  of about 0.45. Cole–Davidson spectral densities are often found for glass-forming liquids. The ring can be taken as the rigid part of the molecule without internal flexibility, although a generalized order parameter  $S^2$  of less than unity was observed. The value of approximately 0.70 for  $S^2$  is explained by very fast motions such as librations in the cage of the surrounding molecules and vibrations. The reorientational correlation times of the aliphatic  $^{13}\text{C}$  nuclei are smaller than those of their aromatic ring counterparts, indicating the internal motion of the corresponding molecular segments. The flexibility in the butyl chain increases from the methylene group bound to the rigid and slowly moving imidazolium ring to the methyl group at the end. The other methyl group also exhibits fast motion compared to the rigid aromatic ring. The correlation times of the aliphatic carbons relative to those of the ring and their graduation in the chain are similar to those of alkyl chains in hydrocarbons of comparable size [13]. The experimental  $^{13}\text{C}$  spin–lattice relaxation rates for the aliphatic carbons could be fitted by a combination of the Lipari–Szabo with the BPP spectral density. The activation energies and the generalized order parameters decrease from the methylene group bound at the ring to the

Table 4.5-1: Reorientational correlation times  $\tau$  at 357 K and fit parameters activation energy  $E_A$ , Cole–Davidson distribution parameter  $\beta$ , and generalized order parameter  $S^2$ .

	C2	C4/C5	CH <sub>3</sub> (ring)	CH <sub>2</sub> (ring)	CH <sub>2</sub> –CH <sub>2</sub> –CH <sub>2</sub>	CH <sub>2</sub> –CH <sub>3</sub>	CH <sub>2</sub> –CH <sub>3</sub>	
$\tau_i(357\text{ K})$ (ps)	63	65	68	1.0	46	26	16	4.7
$E_{A,i}$ (kJ·mol <sup>-1</sup> )	38	37	38	27	32	26	26	20
$\beta_i$	0.46	0.43	0.44					
$S_i^2$	0.65	0.73	0.73	0.059	0.37	0.38	0.28	0.075

methyl group at the end of the chain, this again being an indication of the increasing flexibility. The methyl groups had the smallest  $S^2$  value, approximately one tenth of the value for the rigid part of the molecule, which is the typical value for fast methyl group rotation.

The highly detailed results obtained for the neat ionic liquid [BMIM][PF<sub>6</sub>] clearly demonstrate the potential of this method for determination of molecular reorientational dynamics in ionic liquids. Further studies should combine the results for the reorientational dynamics with viscosity data in order to compare experimental correlation times with correlation times calculated from hydrodynamic models (cf. [14]). It should thus be possible to draw conclusions about the intermolecular structure and interactions in ionic liquids and about the molecular basis of specific properties of ionic liquids.

## References

- 1 T. C. Farrar, E. D. Becker, *Pulse and Fourier Transform NMR. Introduction to Theory and Methods*, Academic Press, New York, 1971.
- 2 M. L. Martin, J.-J. Delpuech, G. J. Martin, *Practical NMR Spectroscopy*, Heyden, London, 1980.
- 3 J. R. Lyerla, G. C. Levy, *Top. Carbon-13 NMR Spectrosc.* 1972, 1, 79.
- 4 R. L. Vold, J. S. Waugh, M. P. Klein, D. E. Phelps, *J. Chem. Phys.* 1968, 48, 3831.
- 5 A. Abragam: *The Principles of Nuclear Magnetism*. Oxford University Press, Oxford 1989.
- 6 P. A. Beckmann. *Phys. Rep.* 1988, 171, 85.
- 7 A. Dölle, to be published.
- 8 N. Bloembergen, E. M. Purcell, R. V. Pound, *Phys. Rev.* 1948, 73, 679.
- 9 D. W. Davidson, R. H. Colc, *J. Chem. Phys.* 1951, 19, 1484.
- 10 G. Lipari, A. Szabo, *J. Am. Chem. Soc.* 1982, 104, 4546.
- 11 W. R. Carper, *Molten Salts*, in *Encyclopedia of Nuclear Magnetic Resonance* (D. M. Grant, R. K. Harris eds.), John Wiley & Sons, New York, 1995.
- 12 C. E. Keller, B. J. Piersma, G. J. Mains, W. R. Carper, *Inorg. Chem.* 1994, 33, 5601; C. E. Keller, W. R. Carper, *J. Phys. Chem.* 1994, 98, 6865; C. E. Keller, B. J. Piersma, G. J. Mains, W. R. Carper, *Inorg. Chim. Acta* 1995, 230, 185; C. E. Keller, B. J. Piersma, W. R. Carper, *J. Phys. Chem.* 1995, 99, 12998; C. E. Keller, W. R. Carper, *Inorg. Chim. Acta*, 1995, 238, 115; C. K. Larive, M. Lin, B. J. Piersma, W. R. Carper, *J. Phys. Chem.* 1995, 99, 12409; W. R. Carper, G. J. Mains, B. J. Piersma, S. L. Mansfield, C. K. Larive, *J. Phys. Chem.* 1996, 100, 4724; C. K. Larive, M. Lin, B. S. Kinnear, B. J. Piersma, C. E. Keller, W. R. Carper, *J. Phys. Chem. B* 1998, 102, 1717.
- 13 P. Grühlke, A. Dölle, *J. Chem. Soc., Perkin Trans. 2* 1998, 2159.
- 14 R. P. Klüner, A. Dölle, *J. Phys. Chem. A* 1997, 101, 1657.

## 5 Organic Synthesis

*Martyn Earle, Alain Forestière, Hélène Olivier-Bourbigou, and Peter Wasserscheid*

### 5.1 Stoichiometric Organic Reactions and Acid-Catalyzed Reactions in Ionic Liquids

*Martyn Earle*

The field of reaction chemistry in ionic liquids was initially confined to the use of chloroaluminate(III) ionic liquids. With the development of “neutral” ionic liquids in the mid-1990s, the range of reactions that can be performed has expanded rapidly. In this chapter, reactions in both chloroaluminate(III) ionic liquids and in similar Lewis acidic media are described. In addition, stoichiometric reactions, mostly in neutral ionic liquids, are discussed. Review articles by several authors are available, including: Welton [1] (reaction chemistry in ionic liquids), Holbrey [2] (properties and phase behavior), Earle [3] (reaction chemistry in ionic liquids), Pagni [4] (reaction chemistry in molten salts), Rooney [5] (physical properties of ionic liquids), Seddon [6, 7] (chloroaluminate(III) ionic liquids and industrial applications), Wasserscheid [8] (catalysis in ionic liquids), Dupont [9] (catalysis in ionic liquids) and Sheldon [10] (catalysis in ionic liquids).

Ionic liquids have been described as “designer solvents” [11]. Properties such as solubility, density, refractive index, and viscosity can be adjusted to suit requirements simply by making changes to the structure of either the anion, or the cation, or both [12, 13]. This degree of control can be of substantial benefit when carrying out solvent extractions or product separations, as the relative solubilities of the ionic and extraction phases can be adjusted to assist with the separation [14]. Also, separation of the products can be achieved by other means such as, distillation (usually under vacuum), steam distillation, and supercritical fluid extraction (CO<sub>2</sub>).

To many chemists it may seem daunting to perform reactions in ionic liquids, and the range of ionic liquids or potential ionic liquids available is very large. However, many scientists have found that performing reactions in ionic liquids is straightforward and practical when compared with similar reactions in conventional organic solvents. This is particularly the case when considering reactions nor-



mally carried out in noxious and difficult to remove solvents such as dipolar aprotic solvents like dimethyl sulfoxide.

With the growing interest in ionic liquids, reactions were initially performed in various chloroaluminate(III) ionic liquids. Their strong solvating ability was an advantage, but their sensitivity to moisture and strong interactions with certain commonly occurring functional groups limited the scope of reactions in these media. With the discovery of water-stable “neutral” ionic liquids, the range and scope of reactions that can be performed has grown to include most classes of reactions covered in organic chemistry textbooks [15], and the vast majority of reactions in ionic liquids are now carried out in these water-stable variants.

### 5.1.1

#### Stoichiometric Organic Reactions

Stoichiometric – or, more simply, non-catalytic – reactions are an important and rapidly expanding area of research in ionic liquids. This section deals with reactions that consume the ionic liquid (or molten salt) or use the ionic liquid as a solvent.

##### 5.1.1.1 Molten salts as reagents

Molten salts have been used for many years, in the form of reagents such as fused KOH, pyridinium chloride, and tetrabutylammonium fluoride (TBAF) [4]. One of the earliest molten salts to be used in synthesis is KOH, with examples dating from 1840 [16]. One common use is in the reaction of fused KOH with arenesulfonic acids to produce phenols. Although KOH has a high melting point (410 °C), impurities such as traces of water or carbonates bring the melting point down. An example is given in Scheme 5.1-1 [17, 18].

A number of examples of the use of molten pyridinium chloride (mp 144 °C) in chemical synthesis are known, dating back to the 1940's. Pyridinium chloride can act both as an acid and as a nucleophilic source of chloride. These properties are exploited in the dealkylation reactions of aromatic ethers [4]. An example involving the reaction of 2-methoxynaphthalene is given in Scheme 5.1-2 [16, 18], and a mechanistic explanation in Scheme 5.1-3 [18].

Pyridinium chloride ([PyH]Cl) has also been used in a number of cyclization reactions of aryl ethers (Scheme 5.1-4) [4, 18]. Presumably the reaction initially proceeds by dealkylation of the methyl ether groups to produce the corresponding phenol. The mechanism of the cyclization is not well understood, but Pagni and Smith have suggested that it proceeds by nucleophilic attack of an Ar-OH or Ar-O<sup>-</sup> group on the second aromatic ring (in a protonated form) [4].

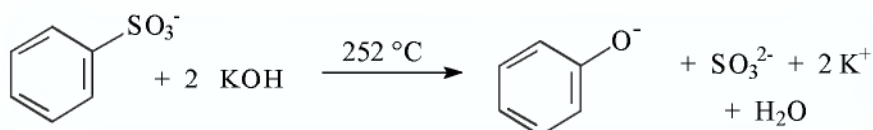

Scheme 5.1-1: The reaction of benzenesulfonates with fused KOH.

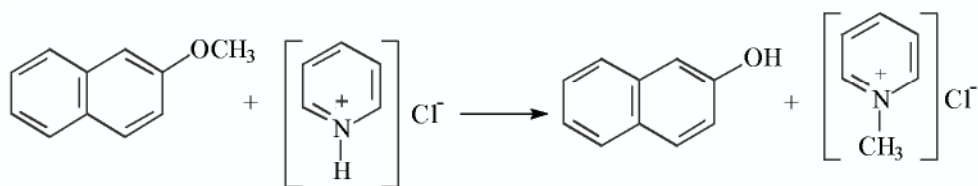

**Scheme 5.1-2:** The demethylation of 2-methoxynaphthalene to 2-naphthol with pyridinium chloride.

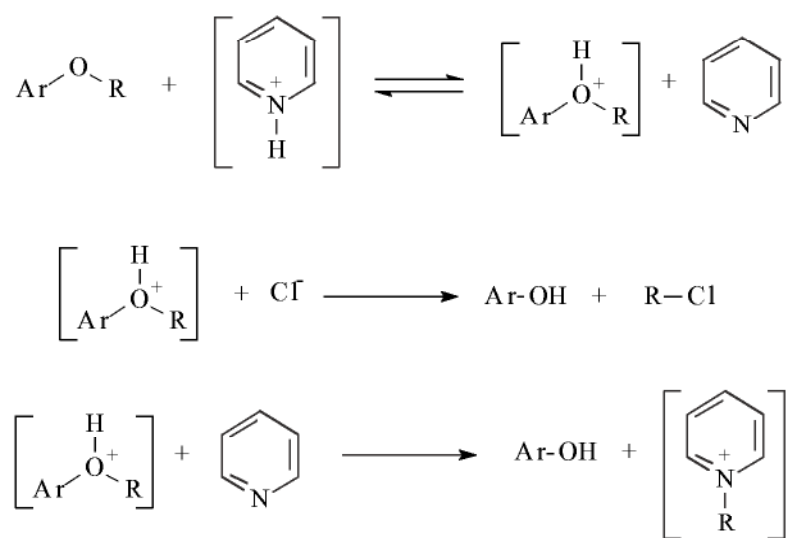

**Scheme 5.1-3:** A mechanism for the dealkylation of aryl ethers with pyridinium chloride.

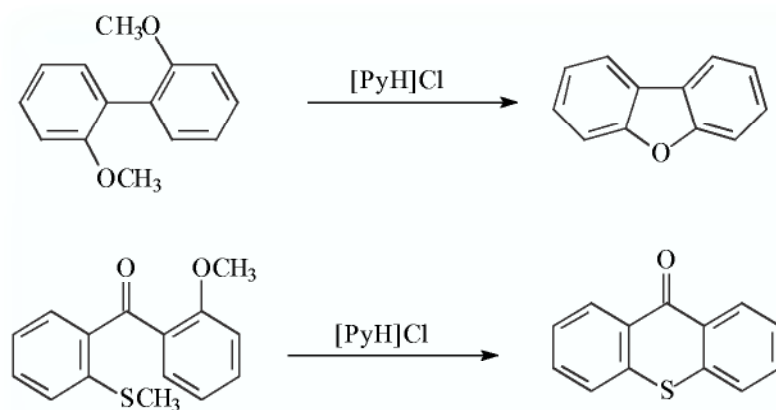

**Scheme 5.1-4:** Two examples of aryl demethylation reactions followed by cyclization.

Tetrabutylammonium fluoride (TBAF) is usually used in the form of the trihydrate or as a solution in tetrahydrofuran (THF). The pure form is difficult to isolate, owing to decomposition to HF, tributylamine, and but-1-ene [18, 19] on dehydration. It has been used for a variety of reactions, including as a catalyst for various reactions with silicon compounds [20, 21]. One of its main uses is in the cleavage of silyl ether protecting groups [22].

TBAF has been used as a source of fluoride ions in a number of substitution reactions studied by Cox et al. [23]. Alkyl and acyl halides react with TBAF to give the corresponding alkyl or acyl fluoride in good yield. In the reaction between (*R*)-2-tosyloctane and TBAF, the product was (*S*)-2-fluorooctane, confirming an  $S_N2$  mechanism for the reaction (Scheme 5.1-5) [18, 23].

TBAF has also been used in the preparation of various fluorocarbenes. This involved the photolysis of phenyl- or phenoxyfluorodiazirine, which was in turn synthesized from the reaction between TBAF and phenyl or phenoxy halodiazirine, as shown in Scheme 5.1-6 [24, 25].

#### 5.1.1.2 Reactions in chloroaluminate(III) and related ionic liquids\*

Reactions in chloroaluminate(III) salts and other related binary salts often proceed smoothly to give products. However, it should be noted that these salts are water-sensitive and must be handled under dry conditions. They react with water to give hydrated aluminium(III) ionic species and HCl. When a reactant or product contains a heteroatomic functional group, such as a ketone, a strong ketone/aluminium(III) chloride adduct is formed. In these cases, this adduct can be difficult to separate from the ionic liquid at the end of a reaction. The isolation of the product often

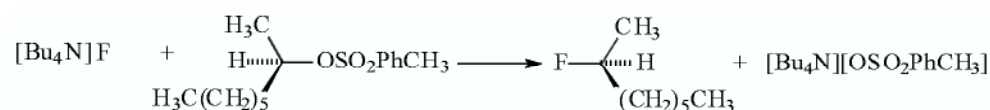

Scheme 5.1-5: The use of TBAF in an  $S_N2$  reaction.

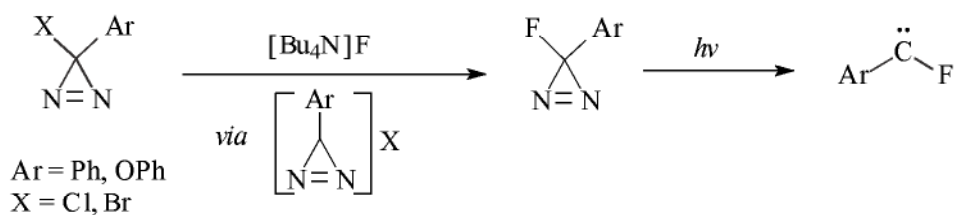

Scheme 5.1-6: The use of TBAF in the preparation of a fluorodiazirine.

\* Chloroaluminate(III) salts are described in more detail in Chapter 2. The composition of a tetrachloroaluminate(III) ionic liquid is best described in this chapter by the apparent mole fraction of AlCl<sub>3</sub> {X(AlCl<sub>3</sub>)} present. Ionic liquids with X(AlCl<sub>3</sub>) < 0.5 contain an excess of Cl<sup>-</sup> ions over [Al<sub>2</sub>Cl<sub>7</sub>]<sup>-</sup> ions, and are

termed "basic"; those with X(AlCl<sub>3</sub>) > 0.5 contain an excess of [Al<sub>2</sub>Cl<sub>7</sub>]<sup>-</sup> ions over Cl<sup>-</sup>, and are termed "acidic"; melts with X(AlCl<sub>3</sub>) = 0.5 are termed "neutral". For example, the binary salt NaCl/AlCl<sub>3</sub> (X(AlCl<sub>3</sub>) = 0.67) refers to a 1 part NaCl to 2 parts AlCl<sub>3</sub> mixture of salts and is described as "acidic".

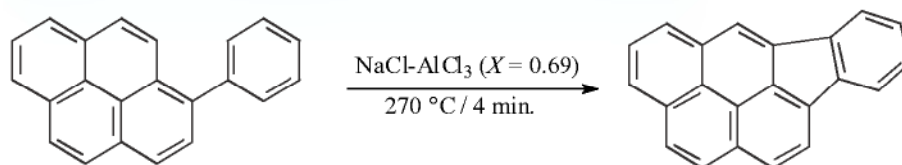

**Scheme 5.1-7:** The Scholl reaction of 1-phenylpyrene.

involves destruction of the ionic liquid with water. For products that do not have polar electron-donating functional groups, isolation of the products is straightforward and the ionic liquid can be reused.

One of the first reactions to be carried out in a molten salt (albeit at 270 °C) was the Scholl reaction. This involves the inter- or intramolecular coupling of two aromatic rings. An example of this reaction, in which 1-phenylpyrene was cyclized to indeno[1,2,3-cd]pyrene [26] is given in Scheme 5.1-7. A more elaborate version of the Scholl reaction is shown in Scheme 5.1-8 and involves bicyclization of an aromatic cumulene [27].

Wynberg et al. found that the yields in the cyclization of helicenes could be improved from 10 % in an aluminium(III) chloride solution in benzene system to 95 % in a NaCl/AlCl<sub>3</sub> (X(AlCl<sub>3</sub>) = 0.69) molten salt [28]. An example is given in Scheme 5.1-9.

The Scholl reaction involves an overall oxidation of the coupled aromatic rings, yet there is no obvious oxidizing agent. This poses the question of what happens to the two hydrogen atoms that are produced in this reaction. It has been suggested that oxygen (air) may act as the oxidant, but this currently lacks confirmation [18].

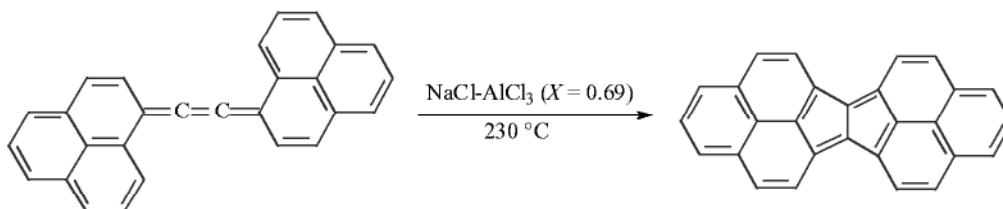

**Scheme 5.1-8:** The cyclisation of an aromatic cumulene in a molten salt.

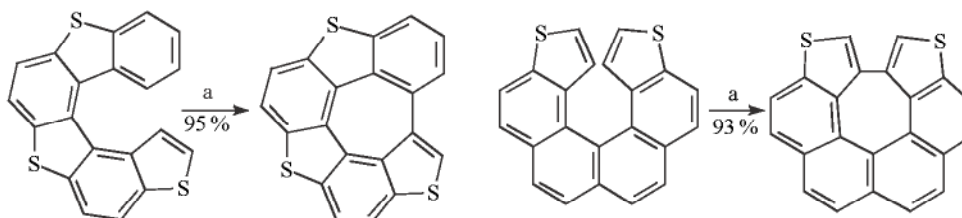

**Scheme 5.1-9:** The Scholl reactions of two helicenes. (a = NaCl/AlCl<sub>3</sub> (X(AlCl<sub>3</sub>) = 0.69) at 140 °C).

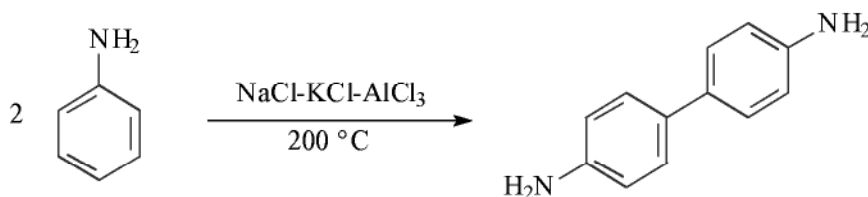

**Scheme 5.1-10:** The dimerization of aniline to benzidine in a molten salt.

The molten salt NaCl/KCl/AlCl<sub>3</sub> (20:20:60) was used in the dimerization of aniline to form benzidine (Scheme 5.1-10) [29].

Buchanan and co-workers studied the behavior of various aromatic compounds in antimony(III) molten salts [30]. These salts can act both as mild Lewis acids and allow redox reactions to take place. The Lewis acidity of the melt can be tuned by controlling the concentration of [SbCl<sub>2</sub>]<sup>+</sup>. Basic melts are formed by addition of a few mol % of a chloride donor such as KCl, whereas acidic melts are formed by addition of chloride acceptors such as AlCl<sub>3</sub> (Scheme 5.1-11).

Examples of reactions that have been carried out in these antimony(III) ionic liquids include the cyclizations of 1,2-bis-(9-anthryl)-ethane (Scheme 5.1-12) and 1,2-bis-(1-naphthyl)-ethane (Scheme 5.1-13). A more detailed review of antimony(III) chloride molten salt chemistry has been published by Pagni [4].

Polycyclic aromatic hydrocarbons dissolve in chloroaluminate(III) ionic liquids to give brightly colored solutions (due to the protonated aromatic compound [31]). The

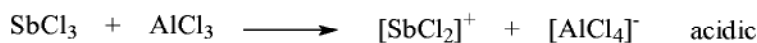
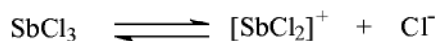

**Scheme 5.1-11:** The effect of the addition of aluminium(III) chloride to antimony(III) chloride.

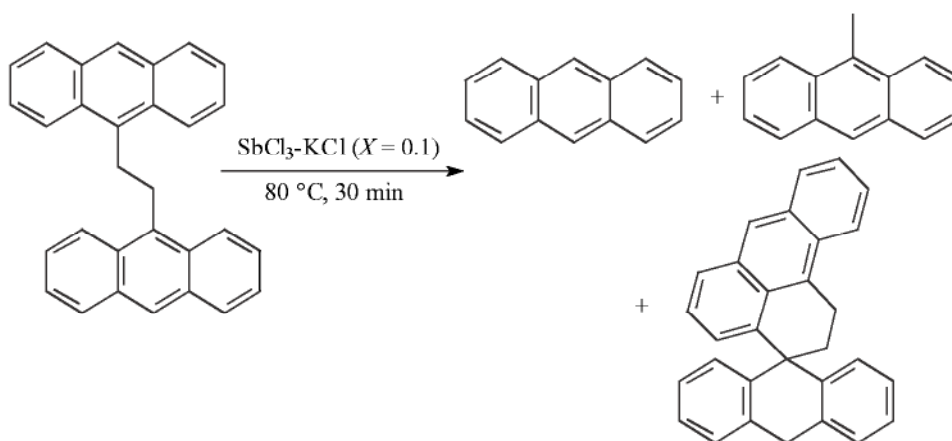

**Scheme 5.1-12:** The cyclisation of 1,2-bis-(9-anthryl)-ethane in antimony(III) ionic liquids.

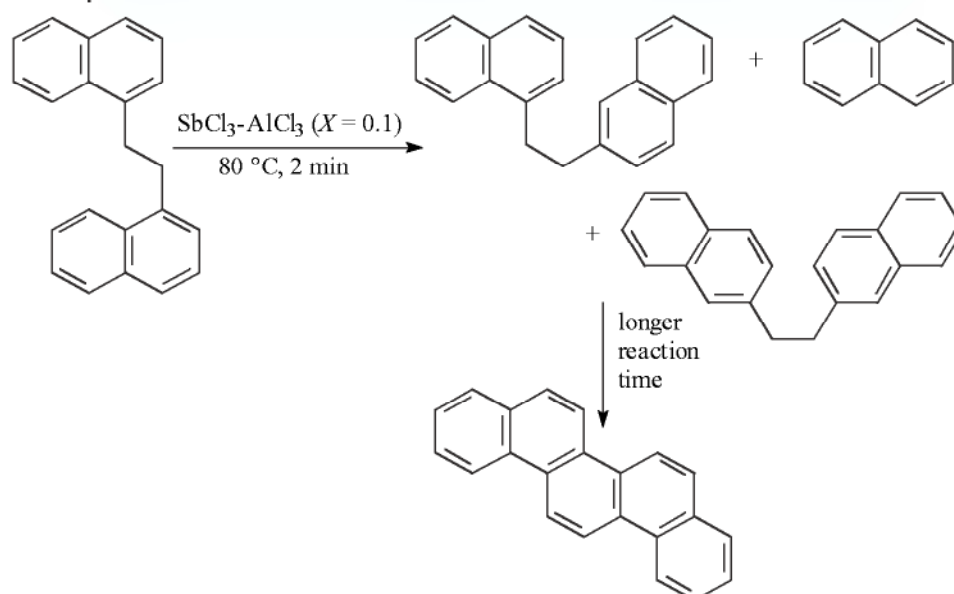

Scheme 5.1-13: Reactions of bisnaphthylethane in antimony(III) ionic liquids.

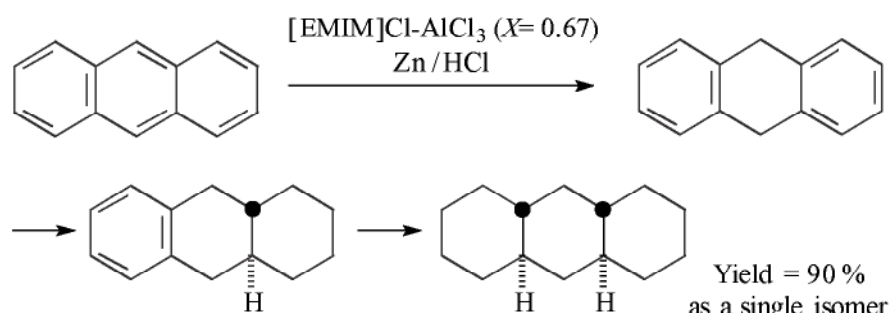

Scheme 5.1-14: The reduction of anthracene to perhydroanthracene.

addition of a reducing agent (such as an electropositive metal and a proton source) results in the selective hydrogenation of the aromatic compound. For example, pyrene and anthracene can be reduced to perhydropyrene and perhydroanthracene at ambient temperatures and pressures (Scheme 5.1-14). Interestingly, only the thermodynamically most stable isomer of the product is obtained [32]. This contrasts with catalytic hydrogenation reactions, which require high temperatures and pressures and expensive platinum oxide catalysts and give rise to isomeric mixtures of products.

Singer and co-workers have shown that benzoyl chloride reacts with ethers to give alkyl benzoates [33] in chloroaluminate(III) ionic liquids. This reaction results in



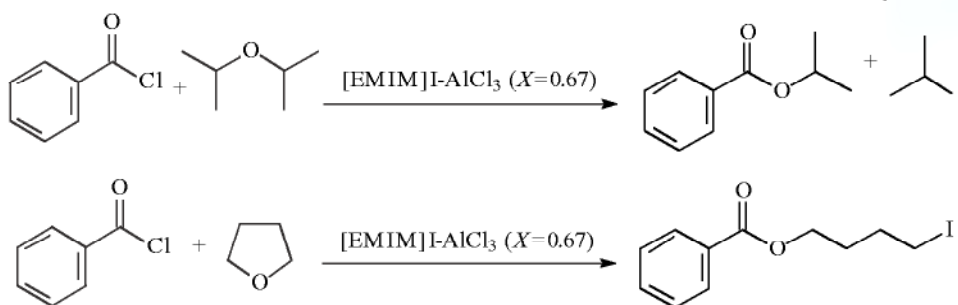

**Scheme 5.1-15:** The acylative cleavage of ethers in an ionic liquid.

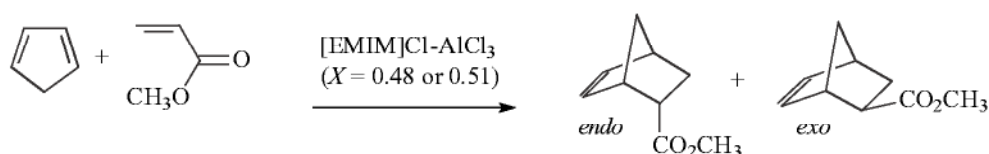

**Scheme 5.1-16:** The Diels-Alder reaction in a chloroaluminate(III) ionic liquid.

the acylative cleavage of ethers, and a number of reactions with cyclic and acyclic ethers have been investigated in the ionic liquid [EMIM]I/AlCl<sub>3</sub> ( $X(\text{AlCl}_3) = 0.67$ ). Two examples are shown in Scheme 5.1-15.

Esterification reactions can be catalyzed by the ionic liquid 1-butylpyridinium chloride-aluminium chloride ([BP]Cl/AlCl<sub>3</sub> ( $X(\text{AlCl}_3) = 0.33$ )) [34, 35]. Deng and co-workers found that higher yields were obtained than in similar reactions with a sulfuric acid catalyst.

Lee has used chloroaluminate(III) ionic liquids in the Diels-Alder reaction [36]. The *endo:exo* ratio rose from 5.25 to 19 on changing the composition of the ionic liquid from  $X(\text{AlCl}_3) = 0.48$  to  $X(\text{AlCl}_3) = 0.51$  (Scheme 5.1-16). The reaction works well, giving up to 95 % yield, but the moisture-sensitivity of these systems is a major disadvantage, the products being recovered by quenching the ionic liquid in water.

### 5.1.1.3 Reactions in neutral ionic liquids

Chloroaluminate(III) ionic liquids are excellent media in many processes, but suffer from several disadvantages, such as their moisture-sensitivity and the difficulties in separation of products containing heteroatoms. Furthermore, these ionic liquids often have to be quenched (usually in water) at the end of a chemical reaction, and are lost in the form of acidic aqueous waste. Research is, therefore, shifting to the investigation of ionic liquids that are more stable to water. This allows for straightforward product separation and ease of handling. In particular, a number of ionic liquids have been found to be hydrophobic (immiscible with water), but readily dissolve many organic molecules (with the exception of alkanes, some ethers, and alkylated aromatic compounds such as toluene). An example of this is the ionic liquid [BMIM][PF<sub>6</sub>] [37], which forms triphasic solutions with alkanes and water [38]. This multiphase behavior has important implications for clean synthesis and is analogous to the use of fluoruous phases in some chemical processes [39]. For

example, a reaction can be performed in the ionic liquid, the products separated by distillation or steam stripping, and a by-product extracted with water or an organic solvent.

**Diels–Alder reactions** Neutral ionic liquids have been found to be excellent solvents for the Diels–Alder reaction. The first example of a Diels–Alder reaction in an ionic liquid was the reaction of methyl acrylate with cyclopentadiene in [EtNH<sub>3</sub>][NO<sub>3</sub>] [40], in which significant rate enhancement was observed. Howarth et al. investigated the role of chiral imidazolium chloride and trifluoroacetate salts (dissolved in dichloromethane) in the Diels–Alder reactions between cyclopentadiene and either crotonaldehyde or methacrolein [41]. It should be noted that this paper describes one of the first examples of a chiral cationic ionic liquid being used in synthesis (Scheme 5.1-17). The enantioselectivity was found to be < 5 % in this reaction for both the *endo* (10 %) and the *exo* (90 %) isomers.

A study of the Diels–Alder reaction was carried out by Earle et al. [42]. The rates and selectivities of reactions between ethyl acrylate (EA) and cyclopentadiene (CP) in water, 5 M lithium perchlorate in diethyl ether (5 M LPDE), and [BMIM][PF<sub>6</sub>] were compared. The reactions in the ionic liquid [BMIM][PF<sub>6</sub>] were marginally faster than in water, but both were slower than in 5 M LPDE [42, 43] (see Table 5.1-1 and Scheme 5.1-18). It should be noted that these three reactions give up to 98 % yields if left for 24 hours. The *endo:exo* selectivity in [BMIM][PF<sub>6</sub>] was similar to that in 5 M LPDE, and considerably greater than that in water (Table 5.1-1).

In the reaction between isoprene (IP) and methyl vinyl ketone (MVK), the selectivities between the two isomers produced in this reaction can be improved from 4:1 to 20:1 by the addition of a mild Lewis acid such as zinc(II) iodide (5 mol %) to the ionic liquid [BMIM][PF<sub>6</sub>] (Scheme 5.1-18). One of the key benefits of this is that the

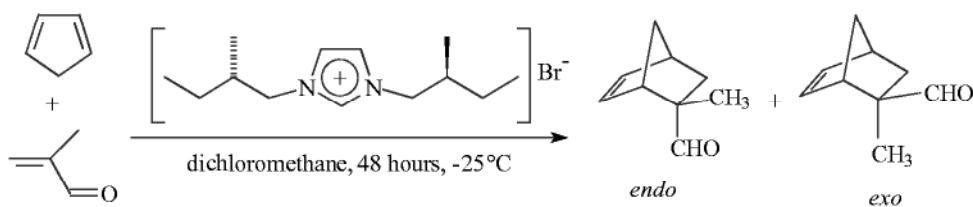

Scheme 5.1-17: Use of a chiral ionic liquid in a Diels–Alder reaction.

Table 5.1-1: Diels–Alder reactions in various solvents.

Solvent	Diene	Dienophile	Product	Time	Yield	a:b ratio
[BMIM][PF <sub>6</sub> ]	CP	EA	1a + 1b	1	36	8.0
5 M LPDE	CP	EA	1a + 1b	1	61	8.0
Water	CP	EA	1a + 1b	1	30	3.5
[BMIM][PF <sub>6</sub> ] <sup>a</sup>	IP	MVK	2a + 2b	6	98	20
[BMIM][PF <sub>6</sub> ]	IP	MVK	2a + 2b	18	11	4

<sup>a</sup> 5 mol % ZnI<sub>2</sub> added, IP = isoprene.

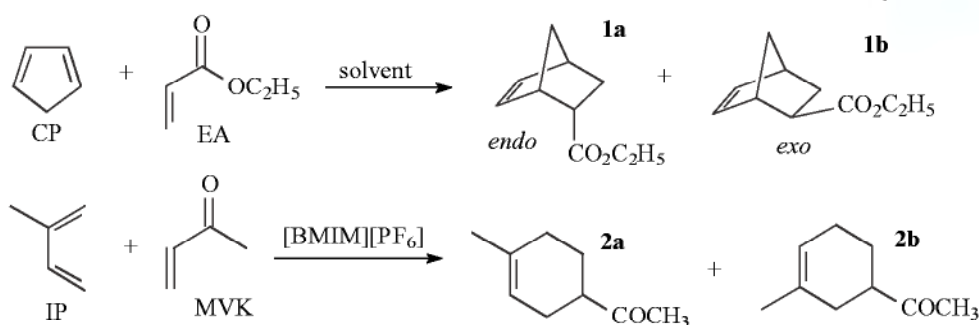

**Scheme 5.1-18:** The Diels-Alder reaction in different solvents (results are given in Table 5.1-1).

ionic liquid and catalyst can be recycled and reused after solvent extraction or direct distillation of the product from the ionic liquid. The reaction was also carried out in the chiral ionic liquid [BMIM][lactate] (Figure 5.1-1). This was found to give the fastest reaction rates of all the ionic liquids tested, and also the lowest *endo:exo* selectivity. The products of the Diels-Alder reaction were found to be racemic and no chiral induction was observed [42].

A similar study performed by Welton and co-workers studied the rate and selectivities of the Diels-Alder reaction between cyclopentadiene and methyl acrylate in a number of neutral ionic liquids [44]. It was found that *endo:exo* ratios decreased slightly as the reaction proceeded, and were dependent on reagent concentration and ionic liquid type. Subsequently, they went on to demonstrate that the ionic liquids controlled the *endo:exo* ratios through a hydrogen bond (Lewis acid) interaction with the electron-withdrawing group of the dienophile.

The use of molten salts based on phosphonium tosylates has also been reported for Diels-Alder reactions [45]. These salts have higher melting points than most ionic liquids in common use, and so the reactions were performed in a sealed tube. The authors claim very high selectivities in the reactions between isoprene and MVK or methyl acrylate. A new class of room-temperature ionic liquids based on phosphonium salts has been described, and has also been used for a number of Diels-Alder reactions [5]. Kitazume and Zulficar have investigated the aza-Diels-Alder reaction in 1-ethyl-1,8-diazabicyclo[5,4,0]undec-7-enium trifluoromethanesulfonate [EDBU][OTf] [46] (Figure 5.1-2). This reaction involved the scandium(III) trifluoromethanesulfonate-catalyzed reaction between an imine (usually generated in situ from an aldehyde and an amine) and a diene. An example of this reaction is given in Scheme 5.1-19. The yields in this reaction were high (80–99 %) and it was found that the ionic liquid could be recycled and reused.

**Figure 5.1-1:** An example of a chiral ionic liquid used in the Diels-Alder reaction.

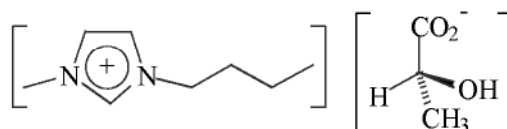

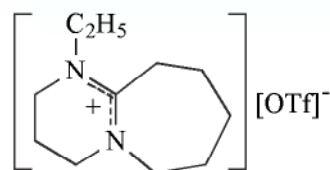
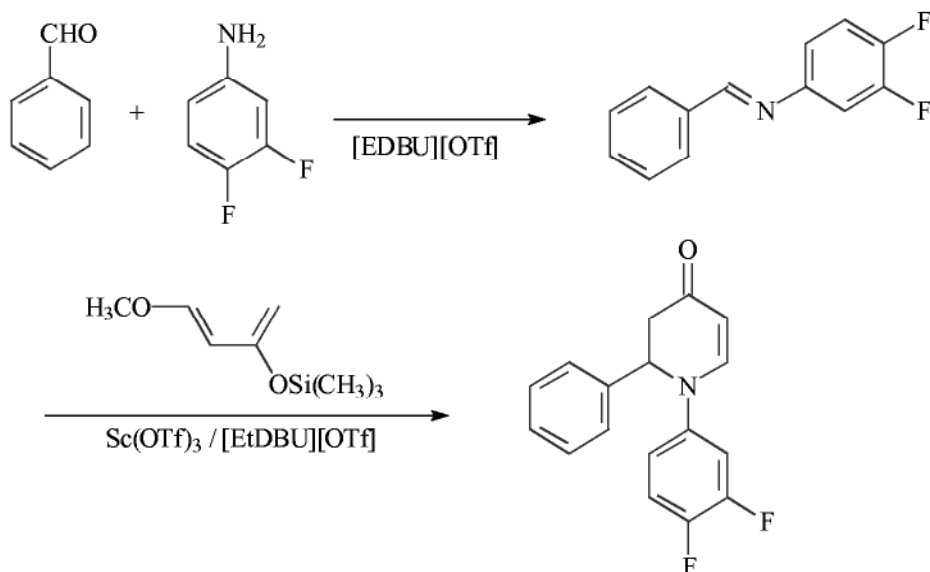
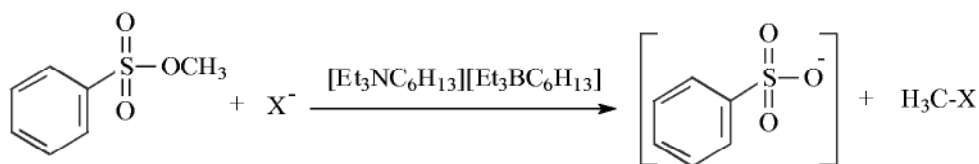

Figure 5.1-2: The structure of 1-ethyl-1,8-diazabicyclo[5,4,0]undec-7-enium trifluoromethanesulfonate [EDBU][OTf].



Scheme 5.1-19: The aza-Diels-Alder reaction in an ionic liquid.

**Nucleophilic displacement reactions** One of the most common reactions in organic synthesis is the nucleophilic displacement reaction. The first attempt at a nucleophilic substitution reaction in a molten salt was carried out by Ford and co-workers [47, 48, 49]. Here, the rates of reaction between halide ion (in the form of its triethylammonium salt) and methyl tosylate in the molten salt triethylhexylammonium triethylhexylborate were studied (Scheme 5.1-20) and compared with similar reactions in dimethylformamide (DMF) and methanol. The reaction rates in the molten salt appeared to be intermediate in rate between methanol and DMF (a dipolar aprotic solvent known to accelerate  $S_N2$  substitution reactions).



Scheme 5.1-20: The reaction between halide and methyl tosylate in triethylhexylammonium triethylhexylborate.

The alkylation of sodium 2-naphthoxide with benzyl bromide in tetrabutylammonium and tetrabutylphosphonium halide salts was investigated by Brunet and Badri [50] (Scheme 5.1-21). The yields in this reaction were quantitative, and alkylation occurred predominantly on the oxygen atom of the naphthoxide ion (typically 93–97%). The rate of the reaction was slower in the chloride salts, due to the benzyl bromide reacting with chloride ion to give the less reactive benzyl chloride.

Indole and 2-naphthol undergo alkylation on the nitrogen and oxygen atoms, respectively (Scheme 5.1-22), when treated with an alkyl halide and base (usually NaOH or KOH) in [BMIM][PF<sub>6</sub>] [51].

These reactions occur with similar rates to those carried out in dipolar aprotic solvents such as DMF or DMSO. An advantage of using the room-temperature ionic liquid for this reaction is that the lower reaction temperatures result in higher selectivities for substitution on the oxygen or nitrogen atoms. The by-product (sodium or potassium halide) of the reaction can be extracted with water and the ionic liquid recycled.

A quantitative study of the nucleophilic displacement reaction of benzoyl chloride with cyanide ion in [BMIM][PF<sub>6</sub>] was investigated by Eckert and co-workers [52]. The separation of the product, 1-phenylacetonitrile, from the ionic liquid was achieved by distillation or by extraction with supercritical CO<sub>2</sub>. The 1-phenylacetonitrile was then treated with KOH in [BMIM][PF<sub>6</sub>] to generate an anion, which reacted with 1,4-dibromobutane to give 1-cyano-1-phenylcyclopentane (Scheme 5.1-23). This was in turn extracted from the ionic liquid with supercritical CO<sub>2</sub>. These

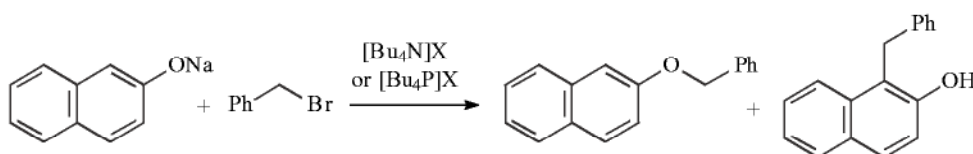

**Scheme 5.1-21:** The benzylation of sodium 2-naphthoxide with benzyl bromide in ammonium or phosphonium halide salts (X = Cl, Br).

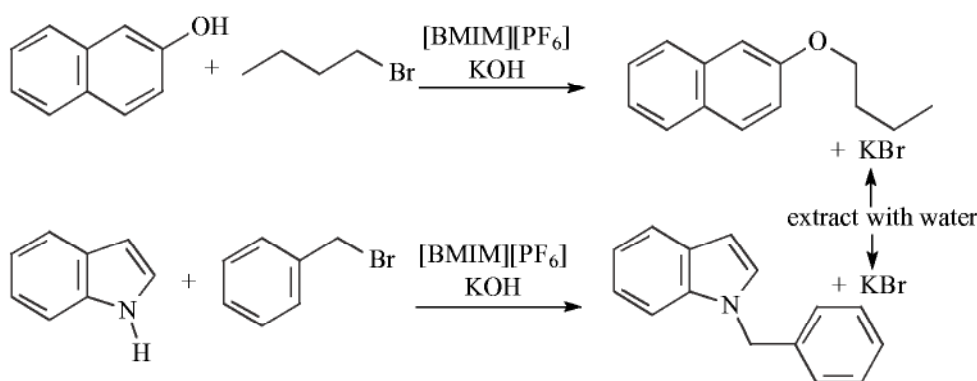

**Scheme 5.1-22:** Alkylation reactions in [BMIM][PF<sub>6</sub>].

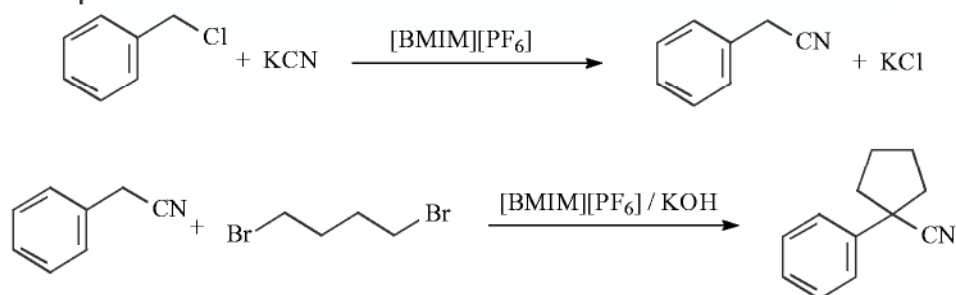

**Scheme 5.1-23.** The reaction of cyanide with benzyl chloride to produce 1-phenylacetonitrile, and subsequent treatment with 1,4-dibromobutane.

reactions resulted in a build-up of KCl or KBr in the ionic liquid, which was removed by washing the ionic liquid with water.

As a demonstration of the complete synthesis of a pharmaceutical in an ionic liquid, Pravadoline was selected, as the synthesis combines a Friedel–Crafts reaction and a nucleophilic displacement reaction (Scheme 5.1-24) [53]. The alkylation of 2-methylindole with 1-(*N*-morpholino)-2-chloroethane occurs readily in [BMIM][PF<sub>6</sub>] and [BMMIM][PF<sub>6</sub>] (BMMIM = 1-butyl-2,3-dimethylimidazolium), in 95–99 % yields, with potassium hydroxide as the base. The Friedel–Crafts acylation step in [BMIM][PF<sub>6</sub>] at 150 °C occurs in 95 % yield and requires no catalyst.

**Reactions involving organometallic reagents in neutral ionic liquid** The addition of organometallic reagents to carbonyl compounds is an important reaction in organic chemistry, the Grignard reaction being one example of this. Procedures that

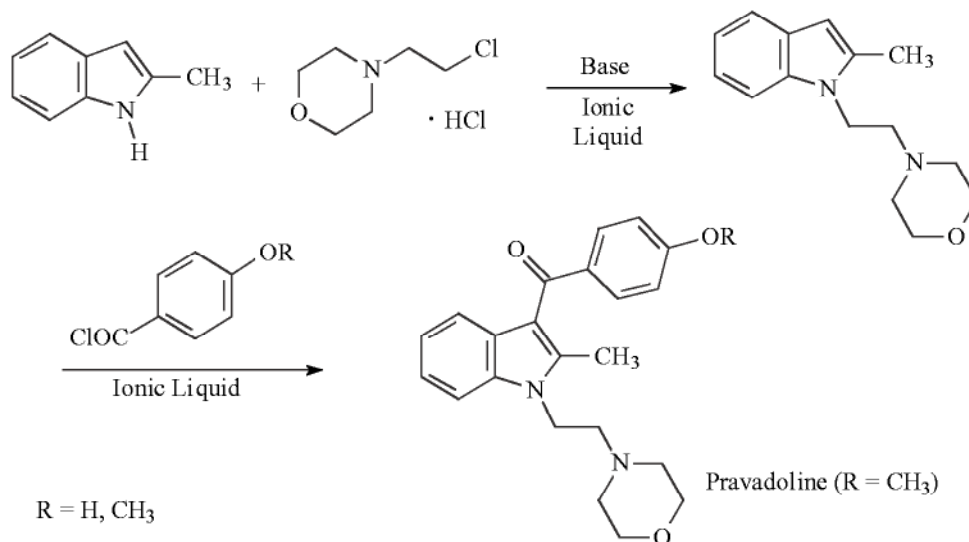

**Scheme 5.1-24:** The complete synthesis of Pravadoline in [BMIM][PF<sub>6</sub>].



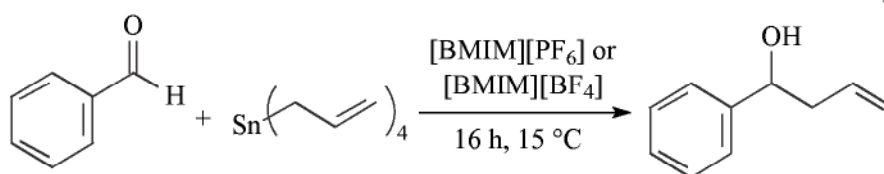

Scheme 5.1-25: Allylation of aldehydes in [BMIM][PF<sub>6</sub>] or [BMIM][BF<sub>4</sub>].

achieve similar results in ionic liquids are hence desirable. Gordon and McClusky [54] have reported the formation of homoallylic alcohols through the addition of allyl stannanes to aldehydes in the ionic liquids [BMIM][BF<sub>4</sub>] and [BMIM][PF<sub>6</sub>] (Scheme 5.1-25). It was found that the ionic liquid could be recycled and reused over several reaction cycles.

Kitazume and Kasai [55] have investigated the Reformatsky reaction in three ionic liquids. This reaction involves treatment of an  $\alpha$ -bromo ester with zinc to give an  $\alpha$ -zinc bromide ester, which in turn reacts with an aldehyde to give an addition product. An example is given in Scheme 5.1-26. Moderate to good yields (45–95 %) were obtained in ionic liquids such as [EDBU][OTf] for the reactions between ethyl bromoacetate or ethyl bromodifluoroacetate and benzaldehyde [55].

Reactions between aldehydes and alkynes to give propargyl alcohols are also described in Kitazume and Kasai's paper [55]. Here, various aldehydes such as benzaldehyde or 4-fluorobenzaldehyde were treated with alkynes such as phenylethyne or pent-1-yne in three ionic liquids: [EDBU][OTf], [BMIM][PF<sub>6</sub>], and [BMIM][BF<sub>4</sub>] (Scheme 5.1-27). A base (DBU) and Zn(OTf)<sub>2</sub> were required for the reaction to be effective; the yields were in the 50–70 % range. The best ionic liquid for this reaction depended on the individual reaction.

McCluskey et al. have also used [BMIM][BF<sub>4</sub>] as a solvent for the allylation of aldehydes and Weinreb amides [56]. Similar diastereoselectivities and similar or slightly lower yields were obtained in this ionic liquid, compared with reactions carried

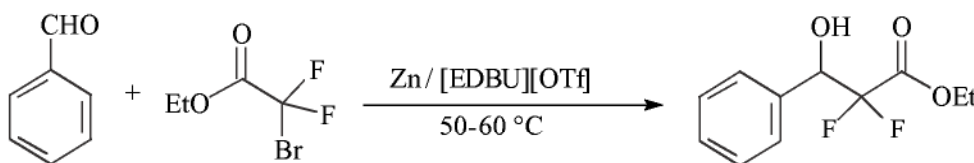

Scheme 5.1-26: The Reformatsky reaction in ionic liquids.

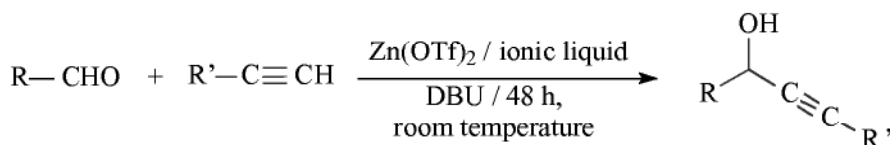

Scheme 5.1-27: The zinc triflate-catalyzed coupling of alkynes with aldehydes to give propargyl alcohols in an ionic liquid.

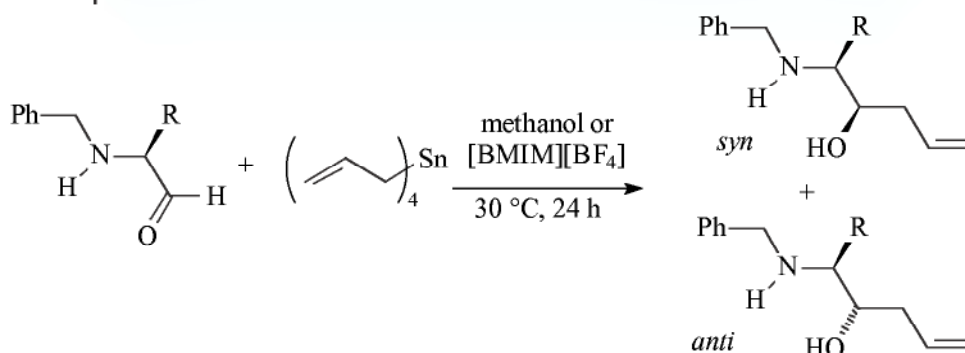

**Scheme 5.1-28:** The reaction between tetraallylstannane and an aldehyde in methanol or [BMIM][BF<sub>4</sub>].

**Table 5.1-2:** The yields and selectivities for the reaction shown in Scheme 5.1-28.

R	<i>syn</i> : <i>anti</i>	% Yield [BMIM][BF <sub>4</sub> ]	% Yield methanol	d.e. (%)
CH <sub>3</sub>	82:18	72	87	64
CH(CH <sub>3</sub> ) <sub>2</sub>	93:7	70	74	86
PhCH <sub>2</sub>	93:7	73	82	86

out in methanol (Scheme 5.1-28). The lower yield assigned to the reaction in the ionic liquid (see Table 5.1-2) is thought to be due to difficulty in extracting the product from the ionic liquid.

Ionic liquids such as [BMIM][BF<sub>4</sub>] and [EMIM][PF<sub>6</sub>] have been used in the trialkylborane reduction of aldehydes to alcohols (Scheme 5.1-29) [57]. In the reduction of benzaldehyde with tributylborane, similar yields (90–96 %) were obtained for the ionic liquids [EMIM][BF<sub>4</sub>], [EMIM][PF<sub>6</sub>], [BMIM][BF<sub>4</sub>], and [BMIM][PF<sub>6</sub>]. The effect of electron-releasing and electron-withdrawing groups on the aromatic aldehyde were investigated. In general, electron-withdrawing groups such as halogen give near quantitative yields, but electron-releasing groups such as methoxy reduced the reaction rate and yield.

**Miscellaneous reactions in neutral ionic liquids** Kitazume et al. have also investigated the use of [EDBU][OTf] as a medium in the formation of heterocyclic compounds [58]. Compounds such as 2-hydroxymethylaniline readily condense with

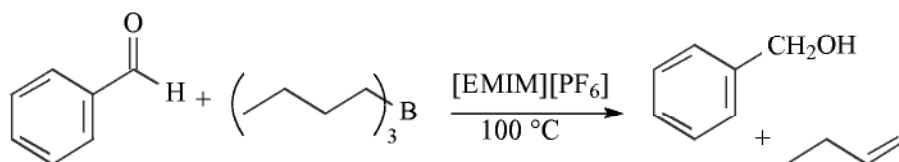

**Scheme 5.1-29:** The reduction of benzaldehyde in [EMIM][PF<sub>6</sub>].

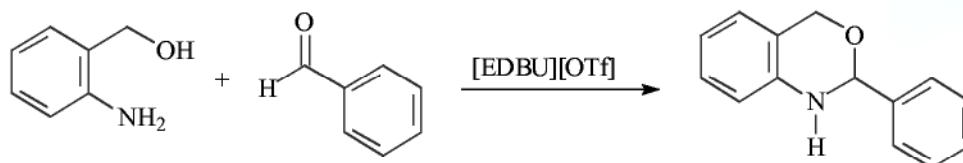

**Scheme 5.1-30:** The formation of 2-phenylbenzoxazine in [EDBU][OTf].

benzaldehyde to give the corresponding benzoxazine (Scheme 5.1-30). The product of the reaction is readily extracted with solvents such as diethyl ether, and the ionic liquid can be recycled and reused.

Beckmann rearrangements of several ketoximes were performed in room-temperature ionic liquids based on 1,3-dialkylimidazolium or alkylpyridinium salts containing phosphorus compounds (such as  $\text{PCl}_5$ ) by Deng and Peng [59] (Scheme 5.1-31, BP = 1-butylpyridinium). Turnover numbers of up to 6.6 were observed, but the authors did not mention whether the ionic liquid could be reused.

The first examples of Horner–Wadsworth–Emmons reactions have been reported by Kitazume and Tanaka [60]. Here the ionic liquid [EDBU][OTf] was used in the synthesis of  $\alpha$ -fluoro- $\alpha,\beta$ -unsaturated esters (Scheme 5.1-32). It was found that when  $\text{K}_2\text{CO}_3$  was used as a base, the *E* isomer was the major product and that when DBU was used as a base, the *Z* isomer was the major product. The reaction was also performed in [EMIM][ $\text{BF}_4$ ] and [EMIM][ $\text{PF}_6$ ], but gave lower yields than with [EDBU][OTf] [60].

Davis and co-workers have carried out the first examples of the Knoevenagel condensation and Robinson annulation reactions [61] in the ionic liquid [HMIM][ $\text{PF}_6$ ] (HMIM = 1-hexyl-3-methylimidazolium) (Scheme 5.1-33). The Knoevenagel condensation involved the treatment of propane-1,3-dinitrile with a base (glycine) to generate an anion. This anion added to benzaldehyde and, after loss of a water molecule, gave 1,1-dicyano-2-phenylethene. The product was separated from the ionic liquid by extraction with toluene.

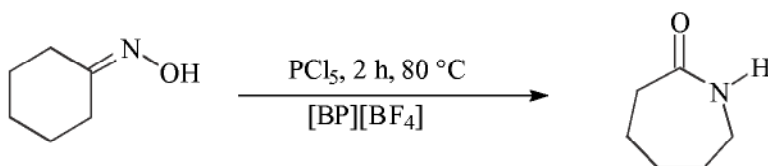

**Scheme 5.1-31:** The Beckmann rearrangement in ionic liquids.

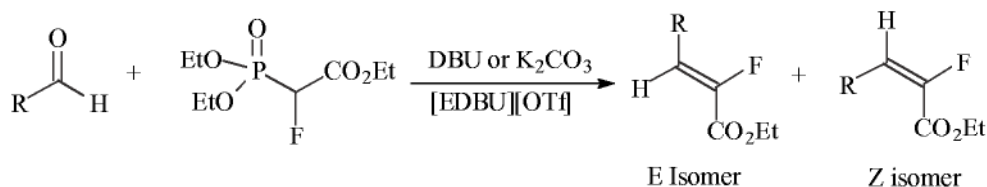

**Scheme 5.1-32:** The Horner-Wadsworth-Emmons reaction in an ionic liquid.

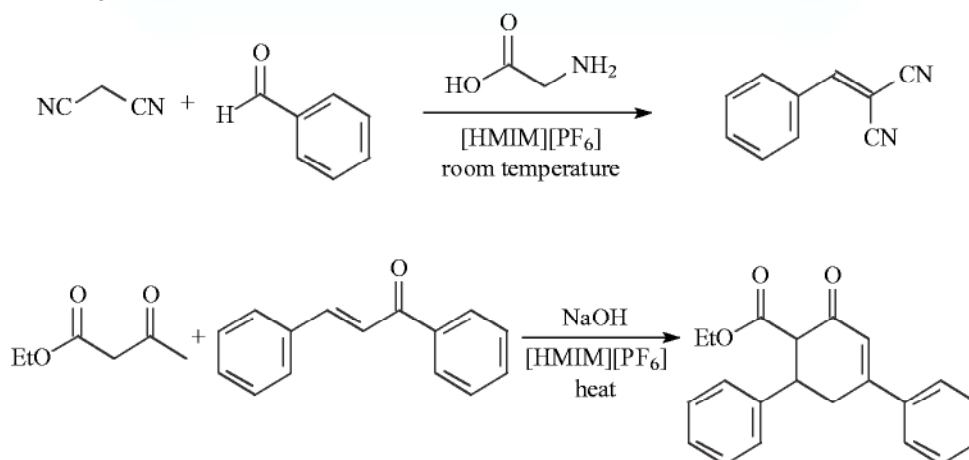

**Scheme 5.1-33:** The Knoevenagel condensation and the Robinson annulation in [HMIM][PF<sub>6</sub>].

The Robinson annulation of ethyl acetoacetate and *trans*-chalcone proceeded smoothly to give 6-ethoxycarbonyl-3,5-diphenyl-2-cyclohexenone in 48 % yield. The product was separated from the ionic liquid by solvent extraction with toluene. In both these reactions, the ionic liquid [HMIM][PF<sub>6</sub>] was recycled and reused with no reduction in the product yield.

Deng and Peng have found that certain ionic liquids catalyze the Biginelli reaction [62]. Usually, this reaction is catalyzed by Lewis acids such as InCl<sub>3</sub>, [Fe(H<sub>2</sub>O)<sub>6</sub>]Cl<sub>3</sub>, or BF<sub>3</sub>·O(C<sub>2</sub>H<sub>5</sub>)<sub>2</sub>, or by acid catalysts such as Nafion-H. The reaction was found to give yields in the 77–99 % range in the ionic liquids [BMIM][PF<sub>6</sub>] or [BMIM][BF<sub>4</sub>] for the examples in Scheme 5.1-34. The reaction fails if there is no ionic liquid present or in the presence of tetrabutylammonium chloride.

Singer and Scammells have investigated the  $\gamma$ -MnO<sub>2</sub> oxidation of codeine methyl ether (CME) to thebaine in the ionic liquid [BMIM][BF<sub>4</sub>] [63]. The ionic liquid was used in different ways and with mixed results (Scheme 5.1-35). For example, the oxidation of CME in the ionic liquid gave 38 % yield after 120 hours. A similar reaction under biphasic conditions (with diethyl ether) gave a 36 % yield of thebaine. This reaction gave a 25 % yield of thebaine when carried out in tetrahydrofuran

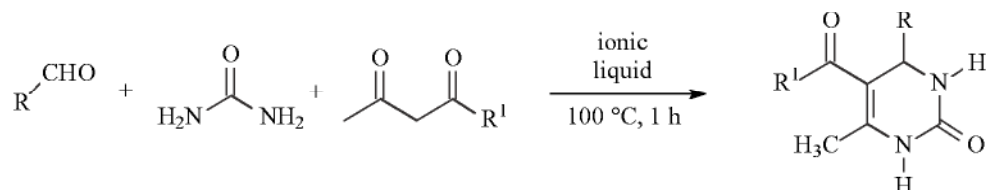

**Scheme 5.1-34:** The Biginelli reaction in an ionic liquid. R = C<sub>6</sub>H<sub>5</sub>, 4-(H<sub>3</sub>CO)-C<sub>6</sub>H<sub>4</sub>, 4-Cl-C<sub>6</sub>H<sub>4</sub>, 4-(O<sub>2</sub>N)-C<sub>6</sub>H<sub>4</sub>, C<sub>5</sub>H<sub>11</sub>. R<sup>1</sup> = OC<sub>2</sub>H<sub>5</sub>, CH<sub>3</sub>.

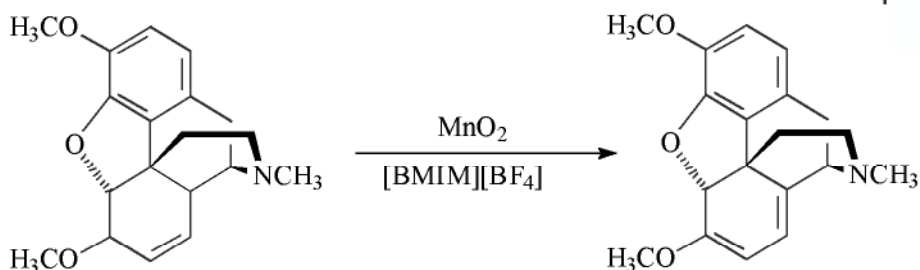

Scheme 5.1-35: The oxidation of CME to thebaine in [BMIM][BF<sub>4</sub>].

(THF). The authors found that the yield could be increased to 95 % by sonication of the reaction vessel, for the reaction in THF. The ionic liquid was then used to extract the manganese by-products and impurities from an ethyl acetate solution of the product [63].

A novel use of the salt [BMIM][PF<sub>6</sub>] is to enhance microwave absorption and hence accelerate the rate of a reaction. Ley found that [BMIM][PF<sub>6</sub>] enhanced the rate of the microwave-promoted thionation of amides by a polymer-supported thionating agent [64].

Hardacre et al. have developed a procedure for the synthesis of deuterated imidazoles and imidazolium salts [65]. The procedure involves the platinum- or palladium-catalyzed deuterium exchange of 1-methyl-d<sup>3</sup>-imidazole with D<sub>2</sub>O to give 1-methylimidazole-d<sup>6</sup>, followed by treatment with a deuterated alkyl halide.

## 5.1.2

### Acid-Catalyzed Reactions

#### 5.1.2.1 Electrophilic substitutions and additions

This section deals with Brønsted acid and Lewis acid catalyzed reactions, excluding Friedel–Crafts reactions, but including reactions such as nitrations, halogenations, and Claisen rearrangements. Friedel–Crafts reactions are discussed in the subsequent Sections 5.1.2.2 and 5.1.2.3.

The first example of an electrophilic nitration in an ionic liquid was performed by Wilkes and co-workers [66]. A number of aromatic compounds were nitrated with KNO<sub>3</sub> dissolved in chloroaluminate(III) ionic liquids. A number of nitration reactions have also been carried out by Laali et al. [67]. The reactions of nitrates, preformed nitronium salts, and alkyl nitrates with aromatic compounds have been performed in a wide range of ionic liquids. Reactions between toluene and [NO<sub>2</sub>][BF<sub>4</sub>], for example, have been performed with varying degrees of success in [EMIM]Cl, [EMIM][AlCl<sub>4</sub>], [EMIM][Al<sub>2</sub>Cl<sub>7</sub>], [EMIM][BF<sub>4</sub>], [EMIM][PF<sub>6</sub>], and [EMIM][OTf]. Of these, the reaction in [EMIM][BF<sub>4</sub>] (Scheme 5.1-36) gave the best yield (71 %, *o*:*p* ratio = 1.17:1), but only after the imidazolium ring had undergone nitration (Figure 5.1-3).

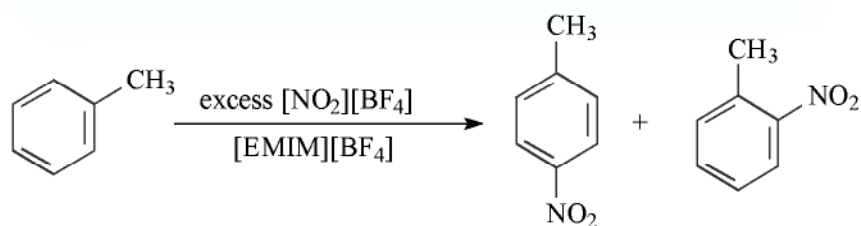

Scheme 5.1-36: The nitration of toluene with  $[\text{NO}_2][\text{BF}_4]$  in  $[\text{EMIM}][\text{BF}_4]$ .

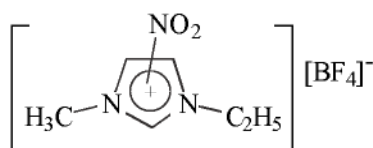
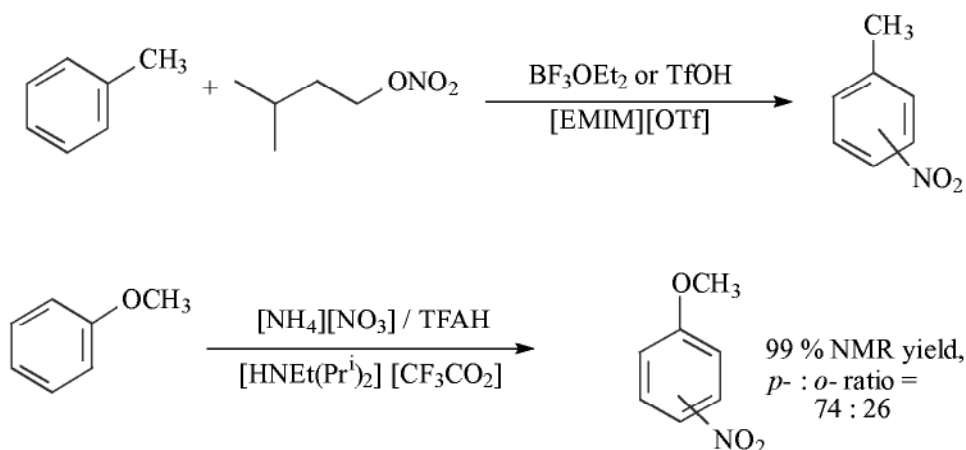

Figure 5.1-3: The nitroimidazolium ionic liquid.

Other methods of nitration that Laali investigated were with isoamyl nitrate in combination with a Brønsted or Lewis acid in several ionic liquids, with  $[\text{EMIM}][\text{OTf}]$  giving the best yields (69 %, 1.0:1.0 *o:p* ratio). In the ionic liquid  $[\text{HNEt}(\text{Pr})_2][\text{CF}_3\text{CO}_2]$  (m.p. = 92–93 °C), toluene was nitrated with a mixture of  $[\text{NH}_4][\text{NO}_3]$  and trifluoroacetic acid (TFAH) (Scheme 5.1-37). This gave ammonium trifluoroacetate  $[\text{NH}_4][\text{TFA}]$  as a by-product, which could be removed from the reaction vessel by distillation (sublimation).

Wilkes and co-workers have investigated the chlorination of benzene in both acidic and basic chloroaluminate(III) ionic liquids [66]. In the acidic ionic liquid  $[\text{EMIM}]\text{Cl}/\text{AlCl}_3$  ( $X(\text{AlCl}_3) > 0.5$ ), the chlorination reaction initially gave chlorobenzene, which in turn reacted with a second molecule of chlorine to give dichlorobenzenes. In the basic ionic liquid, the reaction was more complex. In addition to the



Scheme 5.1-37: Aromatic nitration reactions in ionic liquids.



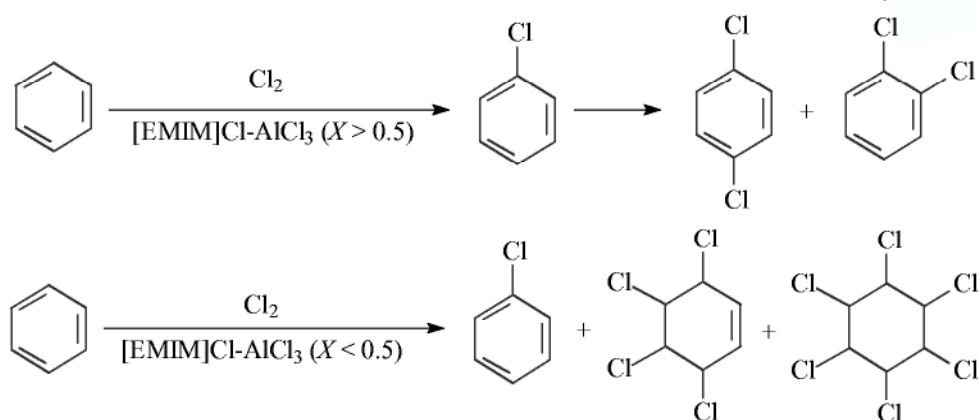

**Scheme 5.1-38:** The chlorination of benzene in acidic and basic chloroaluminate ionic liquids.

formation of chlorobenzene, addition products of chlorine and benzene were observed. These addition products included various isomers of tetrachlorocyclohexene and hexachlorocyclohexane (Scheme 5.1-38).

Another common reaction is the chlorination of alkenes to give 1,2-dihaloalkanes. Patell et al. reported that the addition of chlorine to ethene in acidic chloroaluminate(III) ionic liquids gave 1,2-dichloroethane [68]. Under these conditions, the imidazole ring of imidazolium ionic liquid is chlorinated. Initially, the chlorination occurs at the 4- and 5-positions of the imidazole ring, and is followed by much slower chlorination at the 2-position. This does not affect the outcome of the alkene chlorination reaction and it was found that the chlorinated imidazolium ionic liquids are excellent catalysts for the reaction (Scheme 5.1-39).

In an attempt to study the behavior and chemistry of coal in ionic liquids, 1,2-diphenylethane was chosen as a model compound and its reaction in acidic pyridinium chloroaluminate(III) melts ([PyH]Cl/AlCl<sub>3</sub>) was investigated [69]. At 40 °C, 1,2-diphenylethane undergoes a series of alkylation and dealkylation reactions to give a mixture of products. Some of the products are shown in Scheme 5.1-40. Newman also investigated the reactions of 1,2-diphenylethane with acylating agents such as acetyl chloride or acetic anhydride in the pyridinium ionic liquid [70] and with alcohols such as isopropanol [71].

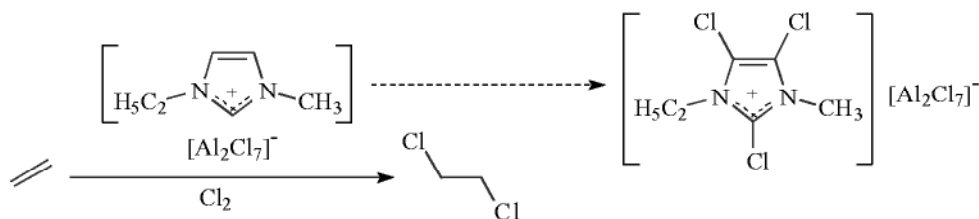

**Scheme 5.1-39:** The chlorination of ethene to give 1,2-dichloroethane.

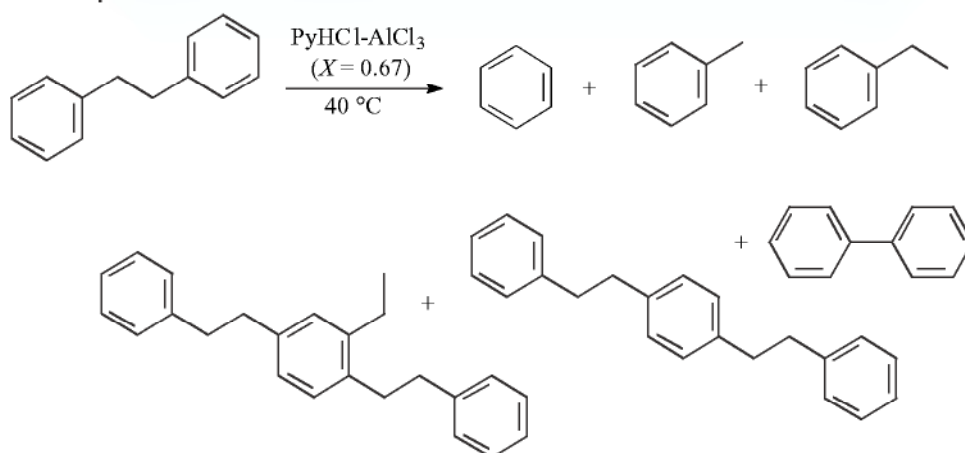

**Scheme 5.1-40:** The reaction of 1,2-diphenylethane with  $\text{PyHCl/AlCl}_3$  ( $X(\text{AlCl}_3) = 0.67$ ).

Kitazume and Zulfiqar have investigated the Claisen rearrangement of several aromatic allyl ethers in ionic liquids, catalyzed by scandium(III) trifluoromethanesulfonate [72]. The reaction initially gave the 2-allylphenol but this reacted further to give 2-methyl-2,3-dihydrobenzo[*b*]furan (Scheme 5.1-41). The yields in this reaction were highly dependant on the ionic liquid chosen, with [EDBU][OTf] giving the best yields (e.g., 91 % for  $\text{R} = 6\text{-CH}_3$ ). Reactions in [BMIM][ $\text{BF}_4$ ] and [BMIM][ $\text{PF}_6$ ] gave low yields (9–12 %).

In order to confirm that 2-allylphenol was an intermediate in the reaction, the authors subjected 2-allylphenol to the same reaction conditions and found that it rearranged to give 2-methyl-2,3-dihydrobenzo[*b*]furan. On treatment of 2-methyl-2-propenyl phenyl ether (Scheme 5.41) under similar conditions, 2,3-diisopropylbenzo[*b*]furan was isolated in 15 % yield. A mechanistic scheme is given by the authors (Scheme 5.1-42). It involves the Claisen rearrangement of 2-methyl-2-propenyl phenyl ether to 2-(2-methyl-2-propenyl)-phenol, followed by a transalkylation of a 2-methylpropenyl group to the phenyl OH group. This undergoes further rearrangements and cyclization to give the 2,3-diisopropylbenzo[*b*]furan [72].

Lee et al. have investigated the Lewis acid-catalyzed three-component synthesis of  $\alpha$ -amino phosphonates [73]. This was carried out in the ionic liquids [BMIM][ $\text{PF}_6$ ],

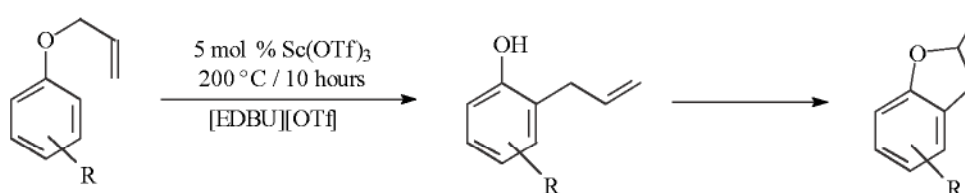

**Scheme 5.1-41:** Claisen rearrangements of several phenyl allyl ethers ( $\text{R} = \text{H}, 4\text{-CH}_3, 6\text{-CH}_3$ ).

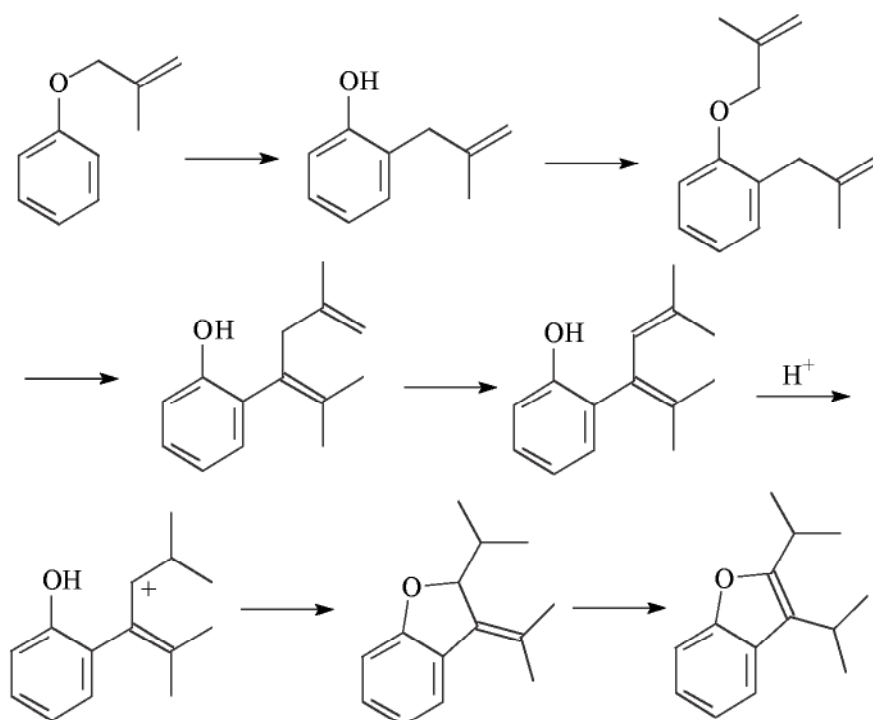

Scheme 5.1-42: Proposed mechanism for the formation of 2,3-diisopropylbenzo[*b*]furan.

[BMIM][OTf], [BMIM][BF<sub>4</sub>], and [BMIM][SbF<sub>6</sub>], and the results were compared with a similar reaction carried out in dichloromethane (Scheme 5.1-43).

Lee found that the reaction gave good yields (70–99 %) in the ionic liquids [BMIM][PF<sub>6</sub>], [BMIM][OTf], and [BMIM][SbF<sub>6</sub>] with Lewis acids such as Yb(OTf)<sub>3</sub>, Sc(OTf)<sub>3</sub>, Dy(OTf)<sub>3</sub>, Sm(OTf)<sub>3</sub>, and InCl<sub>3</sub>. The reaction was also performed in [BMIM][PF<sub>6</sub>] or dichloromethane with Sm(OTf)<sub>3</sub> as the catalyst. The ionic liquid reaction gave a yield of 99 %, compared with 70 % for the reaction in dichloromethane [73].

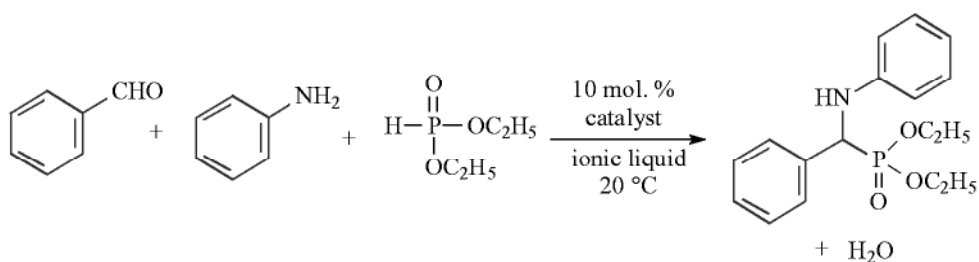

Scheme 5.1-43: Three-component reaction of benzaldehyde, aniline, and diethyl phosphonate in ionic liquids, catalyzed by lanthanide triflates and indium(III) chloride.

### 5.1.2.2 Friedel–Crafts alkylation reactions

Friedel–Crafts reactions have been studied in detail by Olah [74, 75]. These reactions result in the formation of carbon–carbon bonds and are catalyzed by strong Brønsted or Lewis acids.

The Friedel–Crafts alkylation reaction usually involves the interaction of an alkylation agent such as an alkyl halide, alcohol, or alkene with an aromatic compound, to form an alkylated aromatic compound (Scheme 5.1-44).

It should be noted that Scheme 5.1-44 shows idealized Friedel–Crafts alkylation reactions. In practice, there are a number of problems associated with the reaction. These include polyalkylation reactions, since the products of a Friedel–Crafts alkylation reaction are often more reactive than the starting material. Also, isomerization and rearrangement reactions can occur, and can result in a large number of products [74, 75]. The mechanism of Friedel–Crafts reactions is not straightforward, and it is possible to propose two or more different mechanisms for a given reaction. Examples of the typical processes occurring in a Friedel–Crafts alkylation reaction are given in Scheme 5.1-45 for the reaction between 1-chloropropane and benzene.

The chemical behavior of Franklin acidic chloroaluminate(III) ionic liquids (where  $X(\text{AlCl}_3) > 0.50$ ) [6] is that of a powerful Lewis acid. As might be expected, it catalyzes reactions that are conventionally catalyzed by aluminium(III) chloride, without suffering the disadvantage of the low solubility of aluminium(III) chloride in many solvents.

The first examples of alkylation reactions in molten salts were reported in the 1950's. Baddeley and Williamson performed a number of intramolecular cyclization reactions [76] (Scheme 5.1-46), carried out in mixtures of sodium chloride and aluminium chloride. The reactions were run at below the melting point of the pure salt, and it is presumed that the mixture of reagents acts to lower the melting point.

Baddeley also investigated the cyclization of alkenes in the  $\text{NaCl}/\text{AlCl}_3$  molten salt. An example is given in Scheme 5.1-47 [77].

Mendelson et al. [78] also investigated a number of cyclization reactions. One of these involved the cyclodehydration of *N*-benzylethanolamine chloride in a molten salt derived from  $\text{AlCl}_3$  and  $\text{NH}_4\text{Cl}$  ( $X(\text{AlCl}_3) = 0.73$ ). This gave rise to the corresponding tetrahydroisoquinoline in 41–80 % yield, as shown in Scheme 5.1-48.

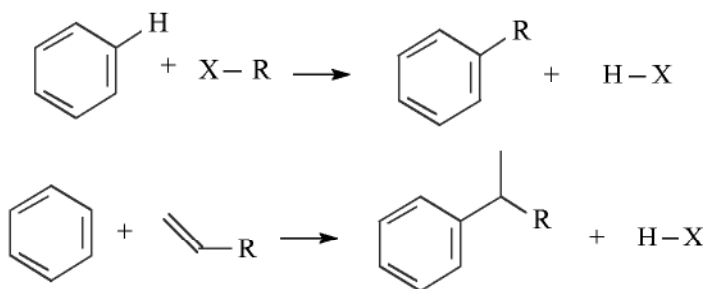

Scheme 5.1-44: The Friedel–Crafts alkylation reaction (R = alkyl, X = leaving group).

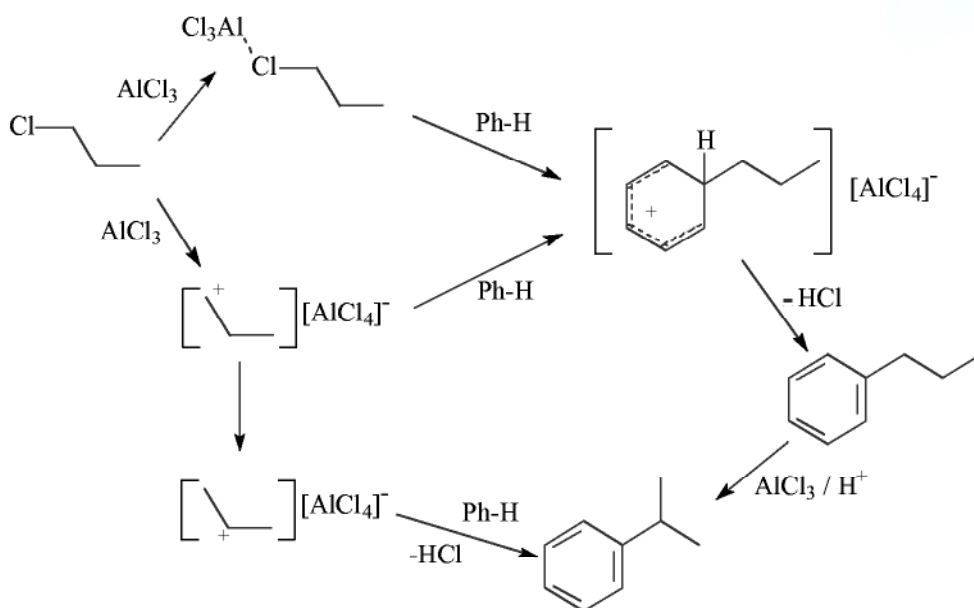

**Scheme 5.1-45:** The reaction between 1-chloropropane and benzene under Friedel-Crafts conditions.

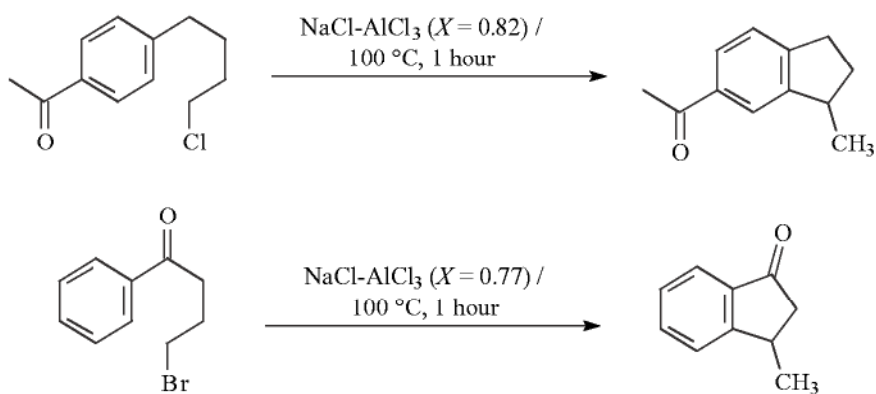

**Scheme 5.1-46:** The intramolecular cyclization of alkyl chlorides and bromides.

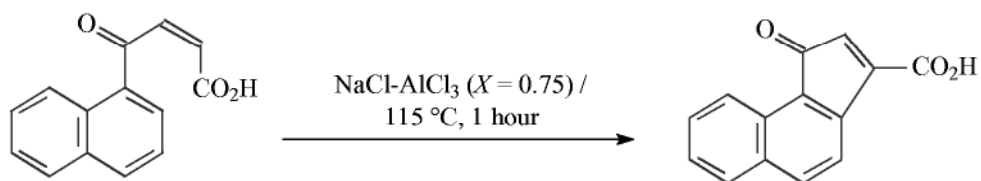

**Scheme 5.1-47:** The intramolecular cyclization of an alkene.

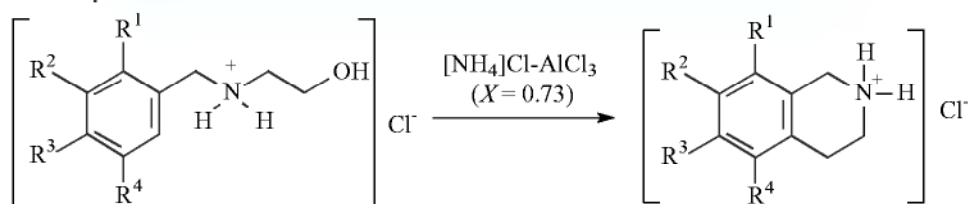

**Scheme 5.1-48:** The cyclodehydration of *N*-benzylethanolamine chloride.

Boon et al. investigated the reactions of benzene and toluene in room-temperature ionic liquids based on [EMIM]Cl/AlCl<sub>3</sub> mixtures [79]. The reactions of various alkyl chlorides with benzene in the ionic liquid [EMIM]Cl/AlCl<sub>3</sub> ( $X(\text{AlCl}_3) = 0.60$  or  $0.67$ ) were carried out, and the product distributions are given in Table 5.1-3 and Scheme 5.1-49. The methylation of benzene with methyl chloride proceeds to give predominantly dimethylbenzene (xylenes) and tetramethylbenzene, with about 10 % hexamethylbenzene. In the propylation of benzene with 1-chloropropane, not only does polyalkylation occur, but there is a considerable degree of isomerization of the *n*-propyl group to the isopropyl isomer (Scheme 5.1-49). In the butylation, complete isomerization of the butyl side chain occurs, to give only *sec*-butyl benzenes.

Piersma and Merchant have studied the alkylation of benzene with various chloropentanes in [EMIM]Cl/AlCl<sub>3</sub> ( $X(\text{AlCl}_3) = 0.55$ ) [80]. Treatment of 1-chloropentane with benzene gave a mixture of products, with only a 1 % yield of the unisomerized *n*-pentylbenzene. The major products of the reaction had all undergone isomerization (Scheme 5.1-50).

Details of two related patents for the alkylation of aromatic compounds with chloroaluminate(III) ionic or chlorogallate(III) ionic liquid catalysts have become available. The first, by Seddon and co-workers [81], describes the reaction between ethene and benzene to give ethylbenzene (Scheme 5.1-51). This is carried out in an

**Table 5.1-3:** The products from the reactions between alkyl chlorides and benzene in [EMIM]Cl/AlCl<sub>3</sub> ( $X(\text{AlCl}_3) = 0.60$  or  $0.67$ ).

<i>R</i> -Cl	<i>X</i>	<i>R</i> -Cl : C <sub>6</sub> H <sub>6</sub> :	Mono-	Di-	Tri-	Tetra-	Penta-	Hexa-
		<i>IL</i>						
Methyl <sup>a</sup>	0.67	xs : 1 : 1	1.5	58.5	1.5	26.8	1.4	10.2
Ethyl <sup>a</sup>	0.67	xs : 1 : 1	11.5	10.8	33.4	24.4		1.5
<i>n</i> -Propyl <sup>b</sup>	0.60	1.25 : 1.25 : 1	24.8	19.9	55.3			
<i>n</i> -Butyl <sup>b,c</sup>	0.60	1.33 : 1.33 : 1	25.0	26.3	48.7			
Cyclohexyl	0.60	10 : 10 : 1	35.0	30.0	34.4			
Benzyl <sup>d</sup>	0.60	0.78 : 1.17 : 1	50.0	34.5	15.6			

<sup>a</sup> At reflux temperature of alkyl halide. <sup>b</sup> Room temperature in dry-box. <sup>c</sup> Only *sec*-butyl products formed. <sup>d</sup> Tar formed, only a small amount of alkylated product isolated.



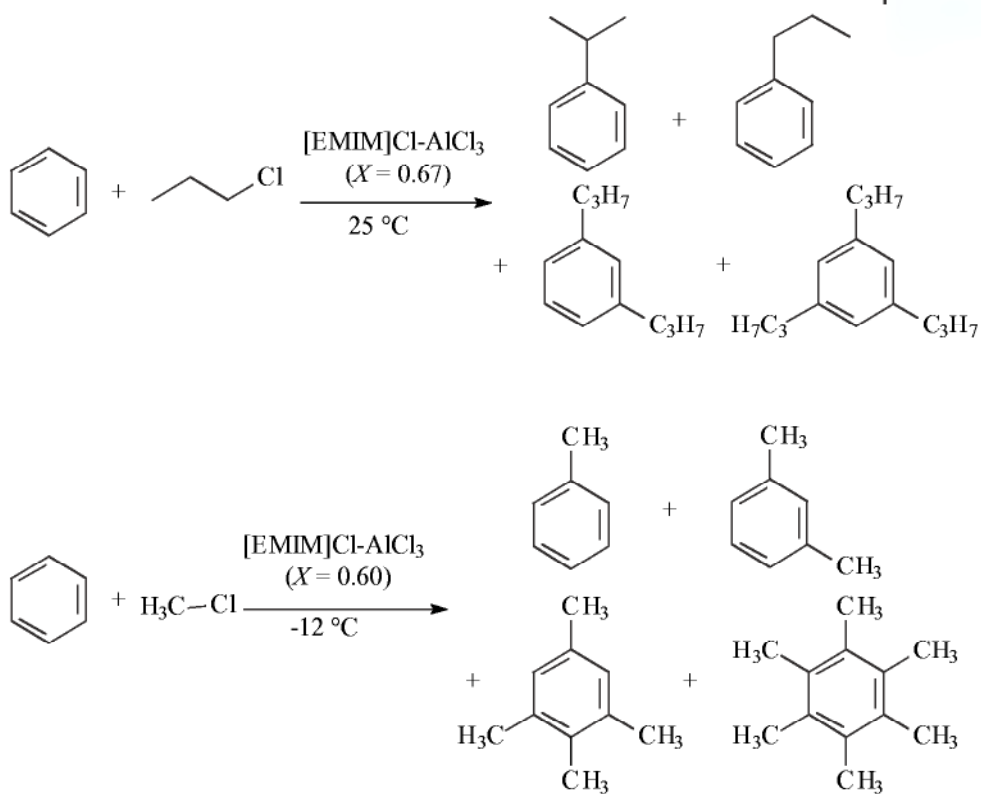

**Scheme 5.1-49:** The alkylation of benzene with methyl chloride or *n*-propyl chloride in an ionic liquid.

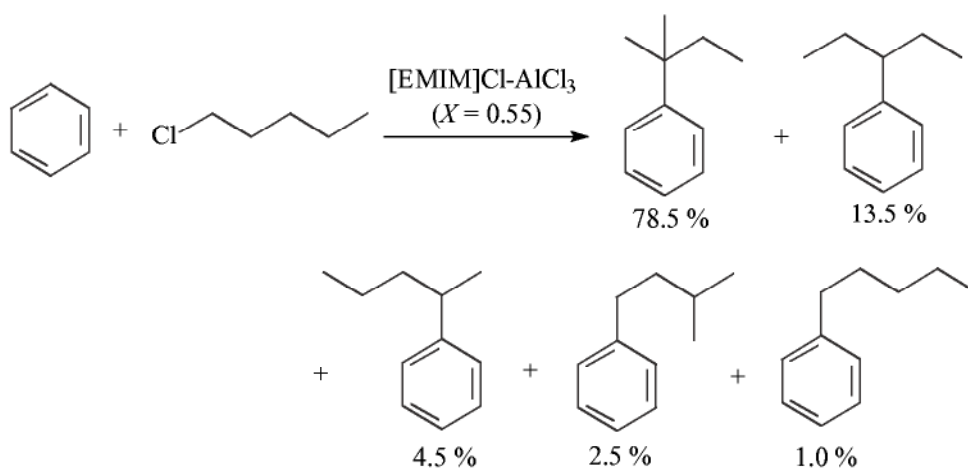

**Scheme 5.1-50:** The reaction between 1-chloropentane and benzene in  $[\text{EMIM}]\text{Cl}/\text{AlCl}_3$  ( $X(\text{AlCl}_3) = 0.55$ ).

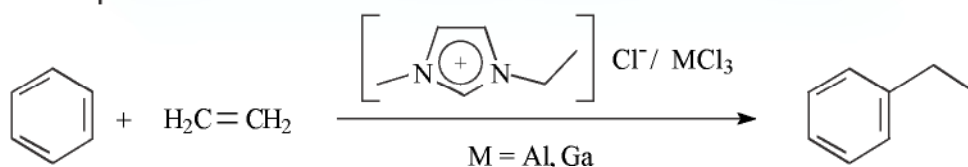

**Scheme 5.1-51:** The alkylation of aromatic compounds in chloroaluminate(III) or chlorogallate(III) ionic liquids.

acidic ionic liquid based on an imidazolium cation, and is claimed for ammonium, phosphonium, and pyridinium cations. The anion exemplified in the patent is a chloroaluminate(III) and a claim is made for chlorogallate(III) anions and various mixtures of anions.

The second patent, by Wasserscheid and co-workers [82], also describes the reaction of benzene with ethene in ionic liquids, but exemplifies a different ionic liquid suitable for this reaction (Scheme 5.1-52).

The production of linear alkyl benzenes (LABs) is carried out on a large scale for the production of surfactants. The reaction involves the reaction between benzene and a long-chain alkene such as dodec-1-ene and often gives a mixture of isomers. Greco et al. have used a chloroaluminate(III) ionic liquid as a catalyst in the preparation of LABs [83] (Scheme 5.1-53).

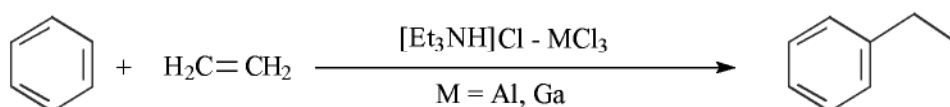

**Scheme 5.1-52:** The reaction between benzene and ethene in a triethylammonium ionic liquid.

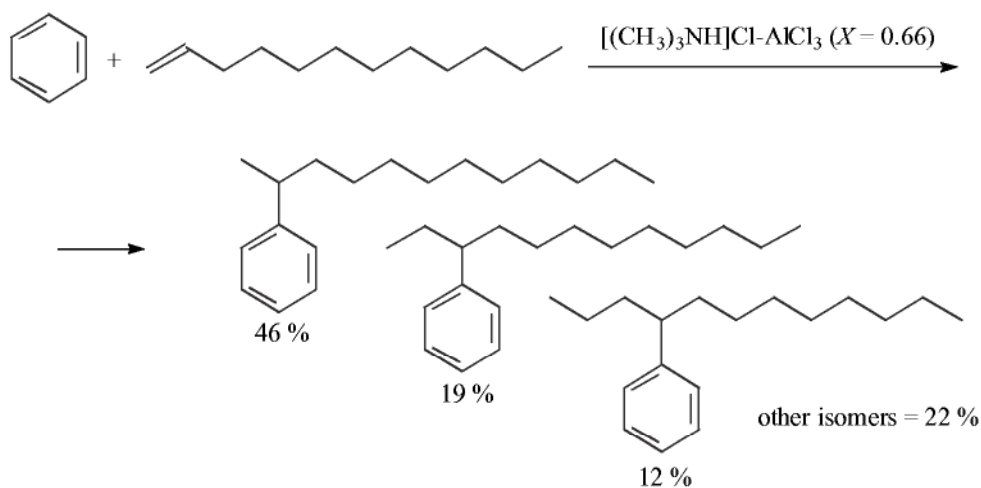

**Scheme 5.1-53:** The reaction between dodec-1-ene and benzene with an ionic liquid as a catalyst.

Keim and co-workers have carried out various alkylation reactions of aromatic compounds in ionic liquids substantially free of Lewis acidity [84]. An example is the reaction between benzene and decene in [BMIM][HSO<sub>4</sub>], which was used together with sulfuric acid as the catalyst (Scheme 5.1-54). These authors have also claimed that these acid-ionic liquids systems can be used for esterification reactions.

The methodology of a Lewis acid dissolved in an ionic liquid has been used for Friedel–Crafts alkylation reactions. Song [85] has reported that scandium(III) triflate in [BMIM][PF<sub>6</sub>] acts as an alkylation catalyst in the reaction between benzene and hex-1-ene (Scheme 5.1-55).

The ionic liquids that were found to give the expected hexylbenzenes were [BMIM][PF<sub>6</sub>], 1-pentyl-3-methylimidazolium hexafluorophosphate, [HMIM][PF<sub>6</sub>], [EMIM][SbF<sub>6</sub>], and [BMIM][SbF<sub>6</sub>]. The reaction did not succeed in the corresponding tetrafluoroborate or trifluoromethanesulfonate ionic liquids. For the successful reactions, conversions of 99 % of the hexene into products occurred, with 93–96 % of the products being the monoalkylated product (Scheme 5.1-55). The authors noted that the successful reactions all took place in the hydrophobic ionic liquids. It should be noted that the [PF<sub>6</sub>]<sup>−</sup> and [SbF<sub>6</sub>]<sup>−</sup> ions are less stable to hydrolysis reactions, resulting in the formation of HF, than the [BF<sub>4</sub>]<sup>−</sup> or [OTf]<sup>−</sup> ions, and so the possibility of these reactions being catalyzed by traces of HF cannot be excluded [86].

The alkylation of a number of aromatic compounds through the use of a chloroaluminate(III) ionic liquid on a solid support has been investigated by Hölderich and co-workers [87, 88]. Here the alkylation of aromatic compounds such as benzene, toluene, naphthalene, and phenol with dodecene was performed using the ionic liquid [BMIM]Cl/AlCl<sub>3</sub> supported on silica, alumina, and zirconia. With benzene, monoalkylated dodecylbenzenes were obtained (Scheme 5.1-56).

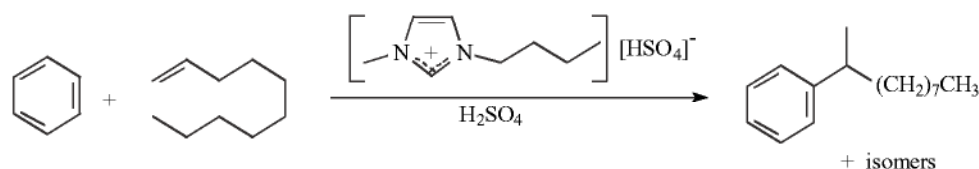

**Scheme 5.1-54:** The sulfuric acid-catalyzed alkylation of benzene in a hydrogensulfate ionic liquid.

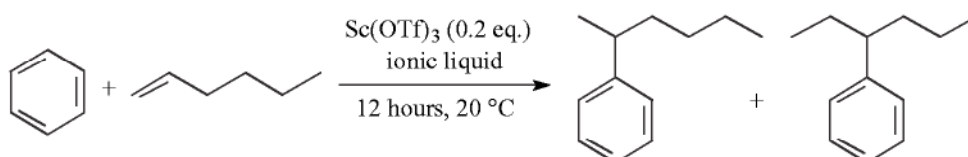

**Scheme 5.1-55:** The alkylation of benzene with hex-1-ene, catalyzed by scandium(III) triflate in ionic liquids.

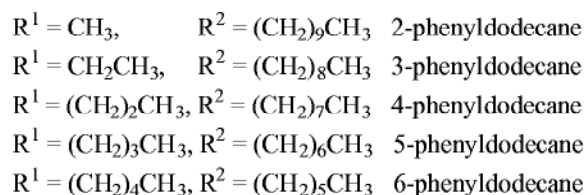
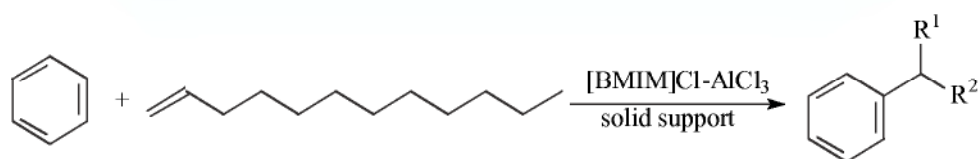

**Scheme 5.1-56:** The alkylation of benzene with dodecene with an ionic liquid on a solid support.

The product distribution in the reaction of benzene with dodecene was determined for a number of catalysts (Table 5.1-4). As can be seen, the reaction with the zeolite H-Beta gave predominantly the 2-phenyldodecane, whereas the reaction in the pure ionic liquid gave a mixture of isomers, with selectivity similar to that of aluminium chloride. The two supported ionic liquid reactions (H-Beta / IL and T 350 / IL) again gave product distributions similar to aluminium(III) chloride (T350 is a silica support made by Degussa).

Raston has reported an acid-catalyzed Friedel–Crafts reaction [89] in which compounds such as 3,4-dimethoxyphenylmethanol were cyclized to cyclotrimeratrylene (Scheme 5.1-57). The reactions were carried out in tributylhexylammonium bis(trifluoromethanesulfonyl)amide  $[\text{NBu}_3(\text{C}_6\text{H}_{13})][(\text{CF}_3\text{SO}_2)_2\text{N}]$  with phosphoric or *p*-toluenesulfonic acid catalysts. The product was isolated by dissolving the ionic liquid/catalyst in methanol and filtering off the cyclotrimeratrylene product as white crystals. Evaporation of the methanol allowed the ionic liquid and catalyst to be regenerated.

**Table 5.1-4:** The product distribution dependency on the catalyst used for the reaction of benzene with dodecene. IL = [BMIM]Cl/AlCl<sub>3</sub> ( $X(\text{AlCl}_3) = 0.6$ ), Temperature = 80 °C, with 6 mol% catalyst and benzene to dodecene ratio = 10:1.

Catalyst	2-Phenyl dodecane	3-Phenyl dodecane	4-Phenyl dodecane	5-Phenyl dodecane	6-Phenyl dodecane
AlCl <sub>3</sub>	46.4	19.4	12.7	12.1	9.5
IL ( $X(\text{AlCl}_3) = 0.6$ )	36.7	19.0	15.0	15.5	13.8
T 350 / IL	42.9	22.8	13.0	11.8	9.4
H-Beta	75.7	19.0	3.8	1.1	0.4
H-Beta / IL	43.9	21.2	12.4	12.0	10.5

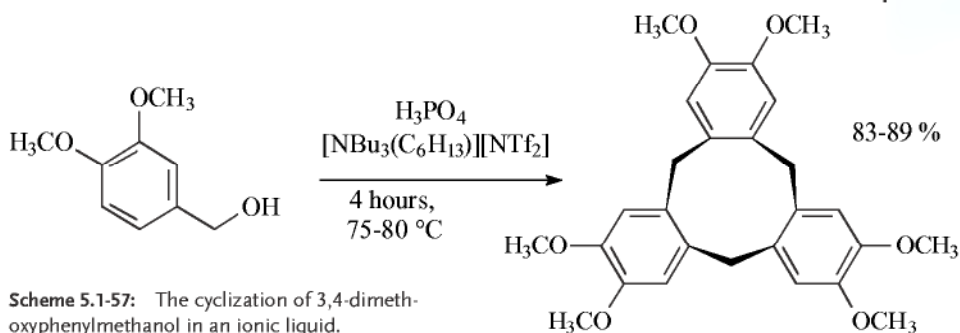

**Scheme 5.1-57:** The cyclization of 3,4-dimethoxyphenylmethanol in an ionic liquid.

### 5.1.2.3 Friedel–Crafts acylation reactions

Friedel–Crafts acylation reactions usually involve the interaction of an aromatic compound with an acyl halide or anhydride in the presence of a catalyst, to form a carbon–carbon bond [74, 75]. As the product of an acylation reaction is less reactive than its starting material, monoacylation usually occurs. The “catalyst” in the reaction is not a true catalyst, as it is often (but not always) required in stoichiometric quantities. For Friedel–Crafts acylation reactions in chloroaluminate(III) ionic liquids or molten salts, the ketone product of an acylation reaction forms a strong complex with the ionic liquid, and separation of the product from the ionic liquid can be extremely difficult. The products are usually isolated by quenching the ionic liquid in water. Current research is moving towards finding genuine catalysts for this reaction, some of which are described in this section.

The first example of a Friedel–Crafts acylation reaction in a molten salt was carried out by Raudnitz and Laube [90]. It involved the reaction between phthalic anhydride and hydroquinone at  $200\text{ }^\circ\text{C}$  in  $\text{NaCl}/\text{AlCl}_3$  ( $X(\text{AlCl}_3) = 0.69$ ) (Scheme 5.1-58).

Scholl and co-workers [91] performed the acylation of 1-benzoylpyrene with 4-methylbenzoyl chloride in a  $\text{NaCl}/\text{AlCl}_3$  ( $X(\text{AlCl}_3) = 0.69$ ) molten salt ( $110\text{--}120\text{ }^\circ\text{C}$ ). This gave 1-benzoyl-6-(4-methylbenzoyl)-pyrene as the major product (Scheme 5.1-59).

Bruce et al. carried out the cyclization of 4-phenylbutyric acid to tetralone in  $\text{NaCl}/\text{AlCl}_3$  ( $X(\text{AlCl}_3) = 0.68$ ) at  $180\text{--}200\text{ }^\circ\text{C}$  [92]. The reaction between valerolactone and hydroquinone to give 3-methyl-4,7-dihydroxyindanone was also performed by Bruce, using the same ionic liquid and reaction conditions. These are shown in Scheme 5.1-60.

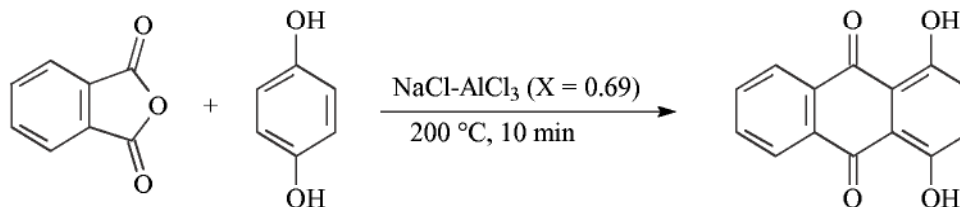

**Scheme 5.1-58:** The reaction between phthalic anhydride and hydroquinone in  $\text{NaCl}/\text{AlCl}_3$  ( $X(\text{AlCl}_3) = 0.69$ ).

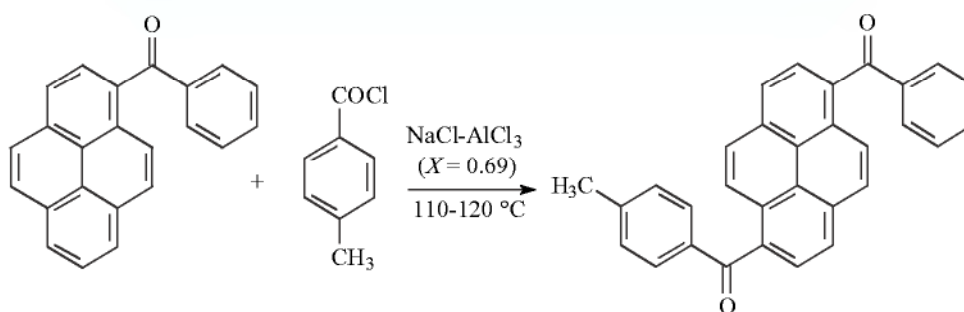

Scheme 5.1-59: The acylation of 1-benzoylpyrene in NaCl/AlCl<sub>3</sub> ( $X(\text{AlCl}_3) = 0.69$ ).

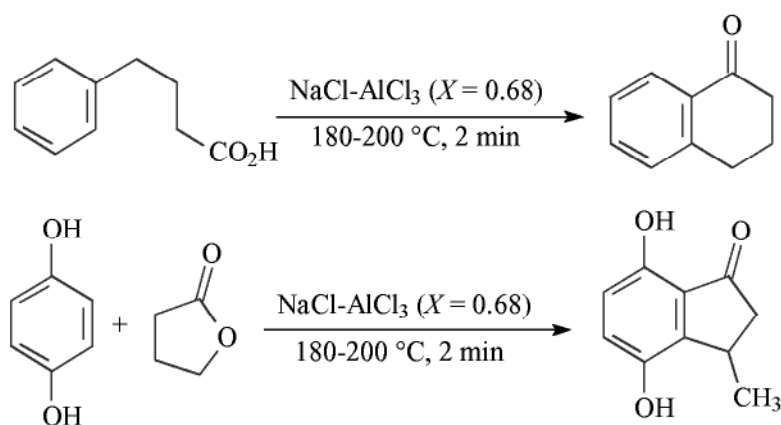

Scheme 5.1-60: The use of NaCl/AlCl<sub>3</sub> ( $X(\text{AlCl}_3) = 0.68$ ) in the formation of cyclic ketones.

The Fries rearrangement can be viewed as a type of Friedel–Crafts acylation reaction. Two examples of this reaction are given in Scheme 5.1-61. The first is the rearrangement of 4,4'-diacetoxybiphenyl to 4,4'-dihydroxy-3,3'-diacetoxybiphenyl in a NaCl/AlCl<sub>3</sub> ( $X(\text{AlCl}_3) = 0.69$ ) molten salt [93]. The second example is the rearrangement of phenyl 3-chloropropionate to 2'-hydroxy-3-chloropropiophenone, followed by cyclization to an indanone [94].

One of the problems with the NaCl/AlCl<sub>3</sub> molten salts is their high melting points and corresponding high reaction temperatures. The high reaction temperatures tend to cause side reactions and decomposition of the products of the reaction. Hence, a number of reactions have been carried out under milder conditions, in room-temperature ionic liquids. The first example of a Friedel–Crafts acylation in such an ionic liquid was performed by Wilkes and co-workers [66, 79] (Scheme 5.1-62). The rate of the acetylation reaction was found to be dependent on the concentration of the [Al<sub>2</sub>Cl<sub>7</sub>]<sup>-</sup> ion, suggesting that this ion was acting as the Lewis acid in the reaction. Wilkes went on to provide evidence that the acylating agent is the acetylum ion [H<sub>3</sub>CCO]<sup>+</sup> [66, 79].



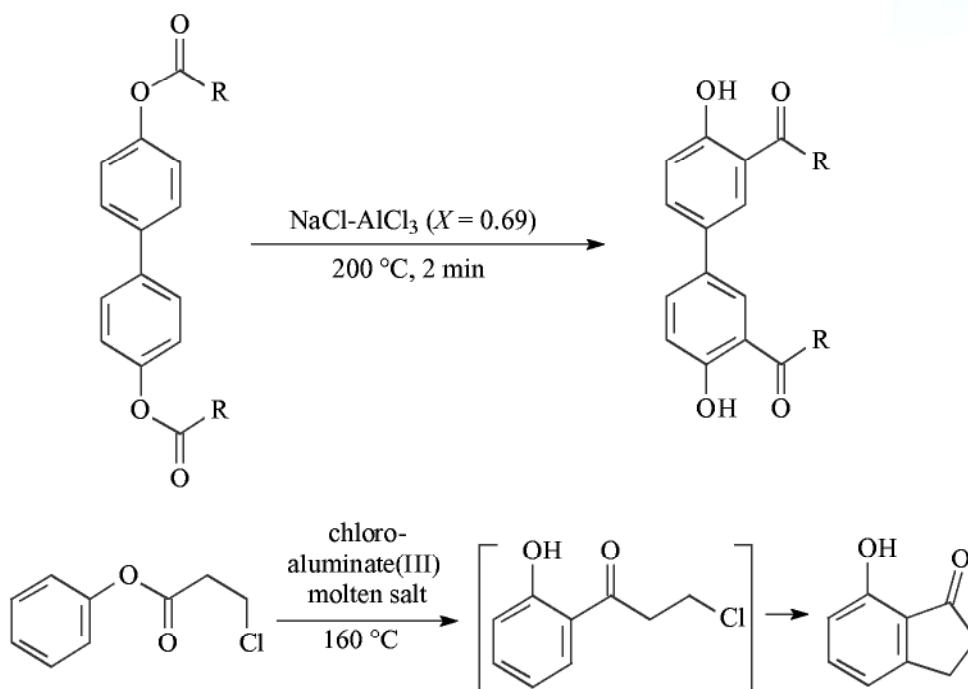

Scheme 5.1-61: The Fries rearrangement in chloroaluminate(III) molten salts.



Scheme 5.1-62: The acetylation of benzene in a room-temperature ionic liquid.

A number of commercially important fragrance molecules have been synthesized by Friedel–Crafts acylation reactions in these ionic liquids. Traseolide<sup>®</sup> (5-acetyl-1,1,2,6-tetramethyl-3-isopropylindane) (Scheme 5.1-63) has been made in high yield in the ionic liquid  $[\text{EMIM}]\text{Cl}/\text{AlCl}_3$  ( $X(\text{AlCl}_3) = 0.67$ ) [95].

For the acylation of naphthalene, the ionic liquid gives the highest reported selectivity for the 1-position [95]. The acetylation of anthracene at  $0\text{ }^\circ\text{C}$  was found to be a reversible reaction. The initial product of the reaction between acetyl chloride (1.1 equivalents) and anthracene is 9-acetylanthracene, formed in 70 % yield in less than 5 minutes. The 9-acetylanthracene was then found to undergo diacetylation reactions, giving the 1,5- and 1,8-diacetylanthracenes and anthracene after 24 hours (Scheme 5.1-64).

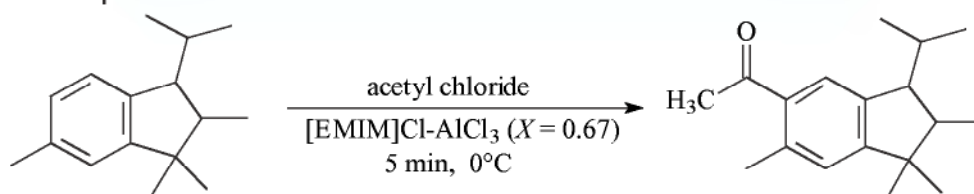

**Scheme 5.1-63:** The acetylation of 1,1,2,6-tetramethyl-3-isopropylindane in [EMIM]Cl/AlCl<sub>3</sub> ( $X(\text{AlCl}_3) = 0.67$ ).

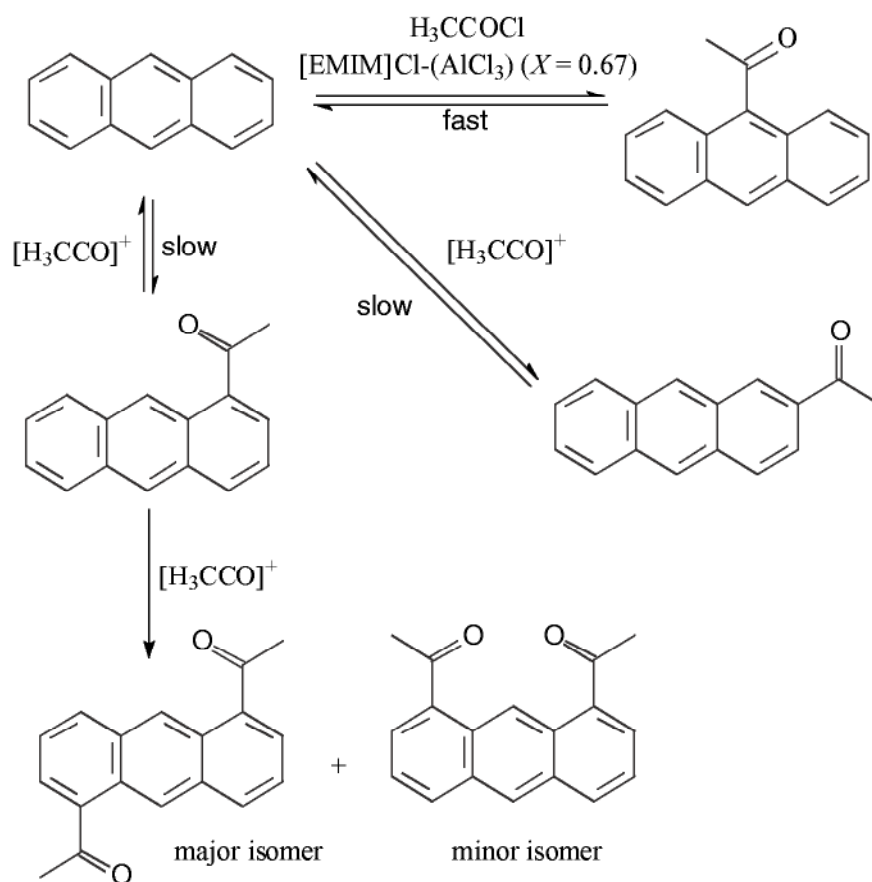

**Scheme 5.1-64:** The acetylation of anthracene in [EMIM]Cl/AlCl<sub>3</sub> ( $X(\text{AlCl}_3) = 0.67$ ).

This was confirmed by taking a sample of 9-acetylanthracene and allowing it to isomerize in the ionic liquid. This gave a mixture of anthracene, 1,5-diacetylanthracene and 1,8-diacetylanthracene. It should be noted that a proton source was needed for this reaction to occur, implying an acid-catalyzed mechanism (Scheme 5.1-65) [95].

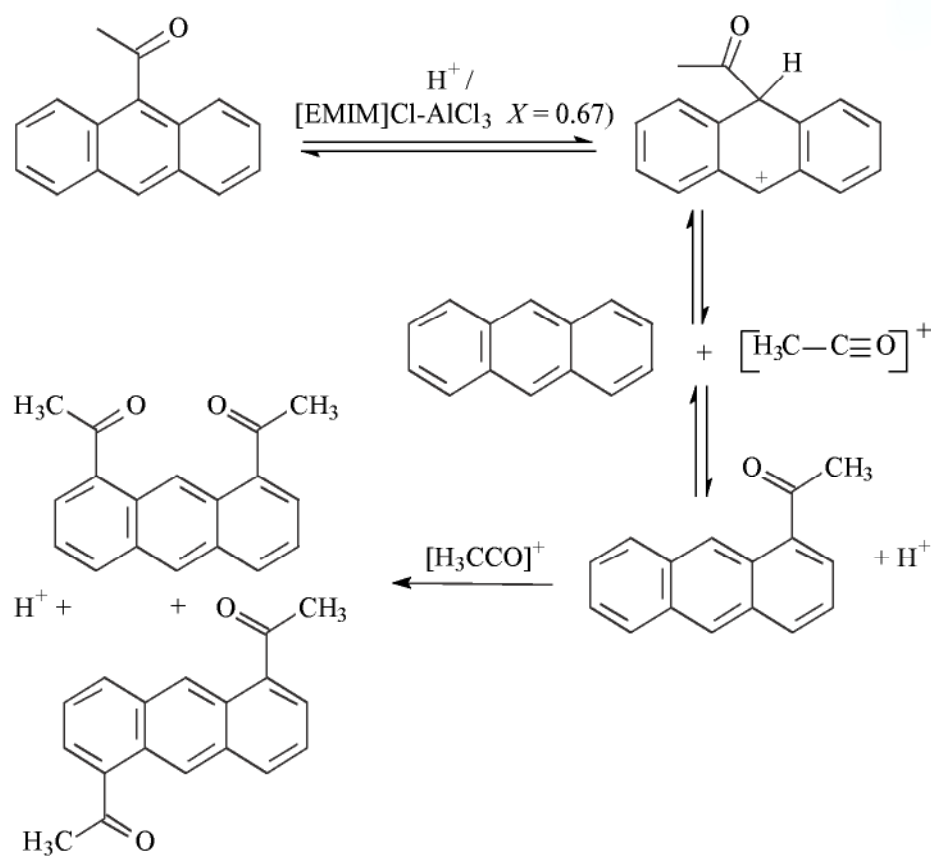

**Scheme 5.1-65:** Proposed mechanism for the isomerization of 9-acetylanthracene in  $[\text{EMIM}]\text{Cl}/\text{AlCl}_3$  ( $X(\text{AlCl}_3) = 0.67$ ).

The Friedel–Crafts acylation reaction has also been performed in iron(III) chloride ionic liquids, by Seddon and co-workers [96]. An example is the acetylation of benzene (Scheme 5.1-66). Ionic liquids of the type  $[\text{EMIM}]\text{Cl}/\text{FeCl}_3$  ( $0.50 < X(\text{FeCl}_3) < 0.62$ ) are good acylation catalysts, with the added benefit that the ketone product of the reaction can be separated from the ionic liquid by solvent extraction, provided that  $X(\text{FeCl}_3)$  is in the range 0.51–0.55.

The ability of iron(III) chloride genuinely to catalyze Friedel–Crafts acylation reactions has also been recognized by Hölderich and co-workers [97]. By immobilizing the ionic liquid  $[\text{BMIM}]\text{Cl}/\text{FeCl}_3$  on a solid support, Hölderich was able to acetylate mesitylene, anisole, and *m*-xylene with acetyl chloride in excellent yield. The performance of the iron-based ionic liquid was then compared with that of the corresponding chlorostannate(II) and chloroaluminate(III) ionic liquids. The results are given in Scheme 5.1-67 and Table 5.1-5. As can be seen, the iron catalyst gave superior results to the aluminium- or tin-based catalysts. The reactions were also carried out in the gas phase at between 200 and 300 °C. The acetylation reac-

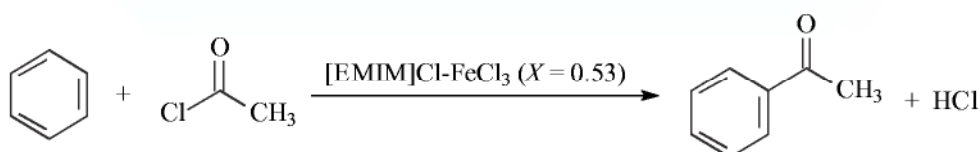

**Scheme 5.1-66:** The acetylation of benzene in an iron(III) chloride-based ionic liquid.

tion was complicated by two side reactions. In the reaction between acetyl chloride and *m*-xylene, for example, the decomposition of acetyl chloride to ketene and the formation of 1-(1-chlorovinyl)-2,4-dimethylbenzene were also found to occur [97].

Rebeiro and Khadilkar have investigated the reactions between trichloroalkanes and aromatic compounds. For example, the benzylation of aromatic compounds in ionic liquids was performed with benzotrichloride, giving ketones on aqueous workup [98].

#### 5.1.2.4 Cracking and isomerization reactions

Cracking and isomerization reactions occur readily in acidic chloroaluminate(III) ionic liquids. A remarkable example of this is the reaction of poly(ethene), which is converted into a mixture of gaseous alkanes of formula  $(C_nH_{2n+2})$ , where  $n = 3-5$  and cyclic alkanes with a hydrogen to carbon ratio of less than two (Figure 5.1-4, Scheme 5.1-68) [99].

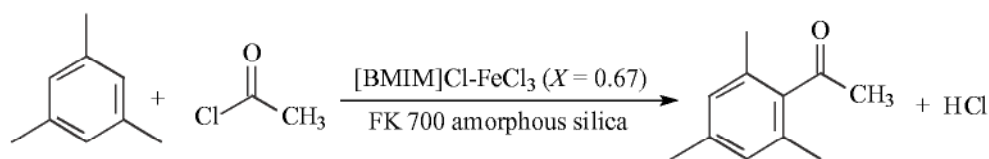

**Scheme 5.1-67:** The acetylation of aromatics with supported ionic liquids (FK 700 is a type of amorphous silica made by Degussa).

**Table 5.1-5:** The acylation of aromatics in batch reactions at 100 °C, for 1 hour. Ratio of aromatic compound to acetylating agent = 5:1, mes. = mesitylene.

<i>Ionic liquid</i>	<i>Reaction</i>	<i>Molar ratio IL : Ar-H</i>	<i>% Conversion</i>	<i>% Selectivity</i>
[BMIM]Cl/AlCl <sub>3</sub>	mes. + AcCl	1:205	68.1	98
[BMIM]Cl/AlCl <sub>3</sub>	anisole + Ac <sub>2</sub> O	1:45	8.3	96
[BMIM]Cl/AlCl <sub>3</sub>	<i>m</i> -xylene + AcCl	1:205	3.5	96
[BMIM]Cl/FeCl <sub>3</sub>	mes. + AcCl	1:205	94.7	95
[BMIM]Cl/FeCl <sub>3</sub>	anisole + Ac <sub>2</sub> O	1:45	100	98
[BMIM]Cl/FeCl <sub>3</sub>	<i>m</i> -xylene + AcCl	1:205	33.8	79
[BMIM]Cl/SnCl <sub>2</sub>	anisole + Ac <sub>2</sub> O	1:45	19.7	94
[BMIM]Cl/SnCl <sub>2</sub>	<i>m</i> -xylene + AcCl	1:205	3.6	95

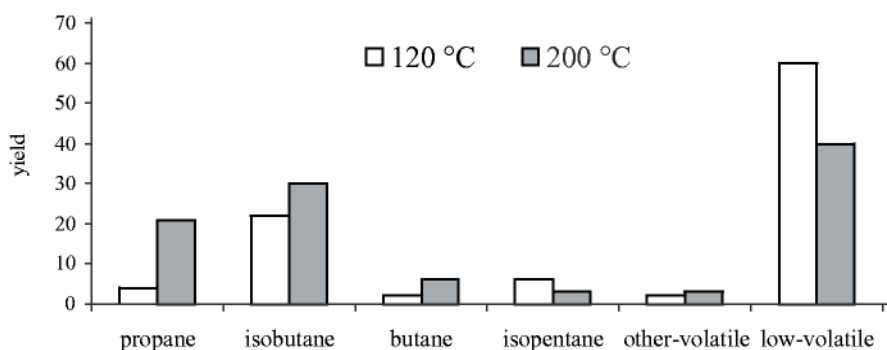
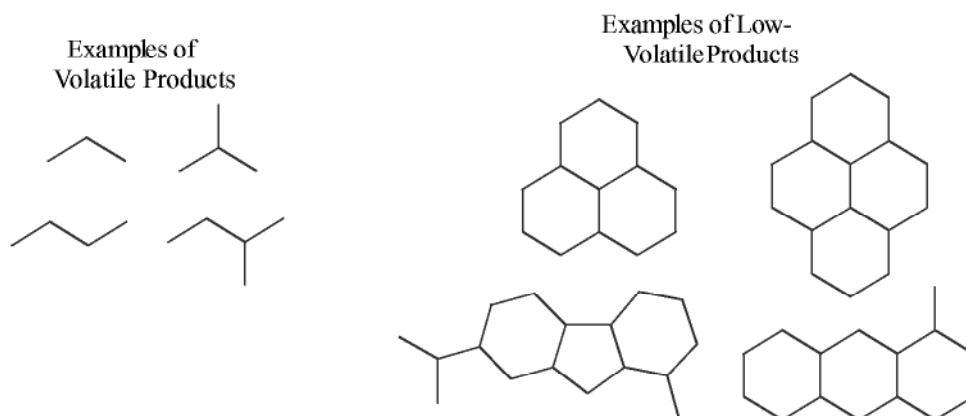
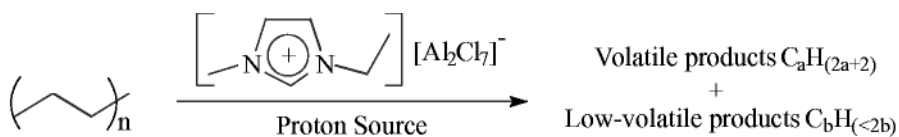
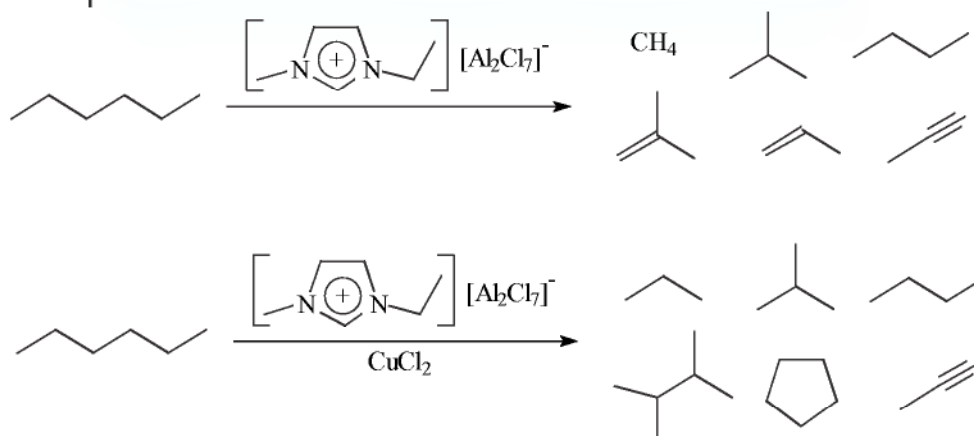

Figure 5.1-4: The products from the ionic liquid cracking of high-density polyethylene at 120 °C and at 200 °C.



Scheme 5.1-68: The cracking of poly(ethene) in an ionic liquid.

The distribution of the products obtained from this reaction depends upon the reaction temperature (Figure 5.1-4) and differs from those of other poly(ethene) recycling reactions in that aromatics and alkenes are not formed in significant concentrations. Another significant difference is that this ionic liquid reaction occurs at temperatures as low as 90 °C, whereas conventional catalytic reactions require much higher temperatures, typically 300–1000 °C [100]. A patent filed for the Secretary of State for Defence (UK) has reported a similar cracking reaction for lower molecular weight hydrocarbons in chloroaluminate(III) ionic liquids [101]. An



**Scheme 5.1-69:** The cracking of hexane in [EMIM]Cl/AlCl<sub>3</sub> ( $X(\text{AlCl}_3) = 0.67$ ) with and without added copper(II) chloride.

example is the cracking of hexane to products such as propene and isobutene (Scheme 5.1-69). The reaction was also performed with added copper(II) chloride, which gave a significantly different product distribution.

A similar reaction occurs with fatty acids (such as stearic acid) or methyl stearate, which undergo isomerization, cracking, dimerization, and oligomerization reactions. This has been used to convert solid stearic acid into the more valuable liquid isostearic acid [102] (Scheme 5.1-70). The isomerization and dimerization of oleic acid and methyl oleate have also been found to occur in chloroaluminate(III) ionic liquids [103].

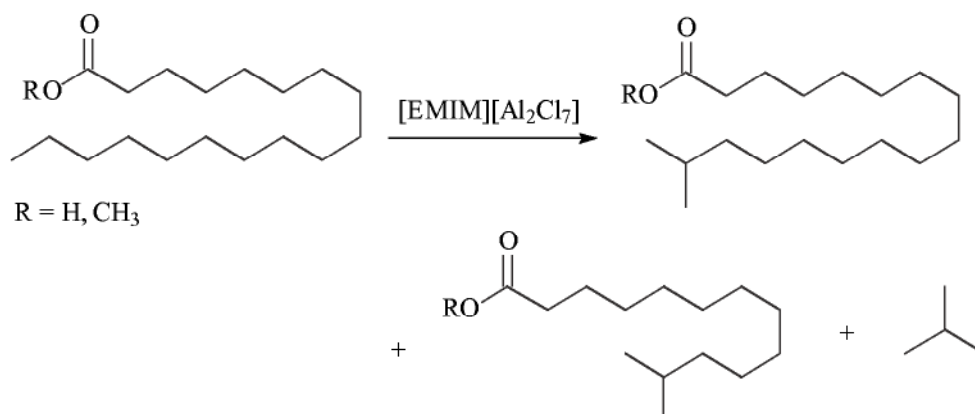

**Scheme 5.1-70:** Cracking and isomerization of fatty acids and fatty acid methyl esters in chloroaluminate(III) ionic liquids.



## References

- 1 T. Welton, *Chem. Rev.* **1999**, *99*, 2071–2083.
- 2 J. D. Holbrey, K. R. Seddon, *Clean Prod. Proc.* **1999**, *1*, 223–236.
- 3 M. J. Earle, K. R. Seddon, *Pure Appl. Chem.* **2000**, *72*, 1391–1398.
- 4 R. M. Pagni, in *Advances in Molten Salt Chemistry*, Vol. 6 (G. Mamantov, J. Braunstein eds.), Elsevier, Oxford, **1987**, 211–346.
- 5 D. W. Rooney, K. R. Seddon, in *The Handbook of Solvents* (G. Wypych ed.), ChemTech Publishing, New York, **2001**, 1459–1484.
- 6 K. R. Seddon, *J. Chem. Tech. Biotech.* **1997**, *68*, 351–356.
- 7 K. R. Seddon, *Green Chem.* **2002**, *4*, 147–151.
- 8 P. Wasserscheid, W. Keim, *Angew. Chem. Int. Ed.* **2000**, *39*, 3773–3789.
- 9 J. Dupont, C. S. Consorti, J. Spencer, *J. Braz. Chem. Soc.* **2000**, *11*, 337–344.
- 10 R. A. Sheldon, *Chem. Commun.* **2001**, 2399–2407.
- 11 M. Fremantle, *Chem. Eng. News* **1998** (30<sup>th</sup> March), *76*, 32–37.
- 12 C. M. Gordon, J. D. Holbrey, A. R. Kennedy, K. R. Seddon, *J. Mater. Chem.* **1998**, *8*, 2627–2636.
- 13 K. R. Seddon, A. Stark, M. J. Torres, *Pure App. Chem.* **2000**, *72*, 2275–2287.
- 14 A. E. Visser, R. P. Swatloski, R. D. Rogers, *Green Chem.* **2000**, *2*, 1–4.
- 15 J. March, *Advanced Organic Chemistry*, 4<sup>th</sup> ed., Wiley, Chichester, **1992**.
- 16 M. Fieser, L. Fieser, *Reagents for Organic Synthesis*, Vol. 1, Wiley-Interscience, New York, **1967**, 936, and references therein.
- 17 C. M. Suter, *The Organic Chemistry of Sulfur, Tetravalent Sulfur Compounds*, Wiley-Interscience, New York, **1944**, 420.
- 18 G. P. Smith, R. M. Pagni in *Molten Salt Chemistry, An introduction to selected Applications* (G. Mamantov, R. Marassi eds.), D. Reidel Publishing Co., Dordrecht, **1987**, 383–416.
- 19 R. K. Sharma, J. L. Fry, *J. Org. Chem.* **1983**, *48*, 2112–2114.
- 20 E. Nakamura, M. Shimizu, I. Kuwajima, J. Sakata, K. Yokoyama, R. Noyori, *J. Org. Chem.* **1983**, *48*, 932–945.
- 21 G. Majetich, A. Casares, D. Chapman, M. Behnke, *J. Org. Chem.* **1986**, *51*, 1745–1753.
- 22 T. W. Green, P. G. M. Wuts, *Protective Groups in Organic Synthesis*, Wiley, New York, **1991**.
- 23 D. P. Cox, J. Terpinski, W. Lawrynowicz, *J. Org. Chem.* **1984**, *49*, 3216–3219.
- 24 R. A. Moss, W. Lawrynowicz, *J. Org. Chem.* **1984**, *49*, 3828–3830.
- 25 D. P. Cox, R. A. Moss, J. Terpinski, *J. Am. Chem. Soc.* **1983**, *105*, 6513–6514.
- 26 P. Studt, *Lebigs Ann. Chem.* **1978**, 528–529.
- 27 K. Nakasuji, K. Yoshida and I. Murata, *J. Am. Chem. Soc.* **1983**, *105*, 5136–5137.
- 28 M. B. Groen, H. Schadenberg, H. Wynberg, *J. Org. Chem.* **1971**, *36*, 2797–2809.
- 29 H. Imaizumi, S. Sekiguchi, K. Matsui, *Bull. Chem. Soc. Jpn.* **1977**, *50*, 948–952.
- 30 A. C. Buchanan III, D. M. Chapman, G. P. Smith, *J. Org. Chem.* **1985**, *50*, 1702–1711.
- 31 G. P. Smith, A. S. Dworkin, R. M. Pagni, S. P. Zingg, *J. Am. Chem. Soc.* **1989**, *111*, 525–530.
- 32 C. J. Adams, M. J. Earle, K. R. Seddon, *Chem. Commun.* **1999**, 1043–1044.
- 33 L. Green, I. Hemeon, R. D. Singer, *Tetrahedron Lett.* **2000**, *41*, 1343–1345.
- 34 Z. Ma, Y. Q. Deng, F. Shi, Can. Patent CN 1247856, **2000**.
- 35 Y. Q. Deng, F. Shi, J. J. Beng, K. Qiao, *J. Mol. Cat. A* **2001**, *165*, 33–36.
- 36 C. W. Lee, *Tetrahedron Lett.* **1999**, *40*, 2461–2462.
- 37 J. D. Huddleston, H. D. Willauer, R. P. Swatloski, A. E. Visser, R. D. Rogers, *Chem. Commun.* **1998**, 1765–1766.
- 38 A. J. Carmichael, M. J. Earle, J. D. Holbrey, P. B. McCormac, K. R. Seddon, *Org. Lett.* **1999**, *1*, 997–1000.

- 39 L. P. Barthel-Rosa, J. A. Gladysz, *Coord. Chem. Rev.* **1999**, *192*, 587–605.
- 40 D. A. Jaeger, C. E. Trucker, *Tetrahedron Lett.* **1989**, *30*, 1785–1788.
- 41 J. Howarth, K. Hanlon, D. Fayne, P. B. McCormac, *Tetrahedron Lett.* **1997**, *38*, 3097–3099.
- 42 M. J. Earle, P. B. McCormac, K. R. Seddon, *Green Chem.* **1999**, *1*, 23–25.
- 43 M. J. Earle, in *Ioniy Liquids*, R. D. Rogers, K. R. Seddon eds., *ACS Symposium Series*, **2002**, *818*, 90–105.
- 44 T. Fisher, A. Sethi, T. Welton, J. Woolf, *Tetrahedron Lett.* **1999**, *40*, 793–795.
- 45 P. Ludley, N. Karodia, *Tetrahedron Lett.* **2001**, *42*, 2011–2014.
- 46 F. Zulfiqar, T. Kitazume, *Green Chem.* **2000**, *2*, 137–139.
- 47 W. T. Ford, R. J. Hauri, D. J. Hart, *J. Org. Chem.* **1973**, *38*, 3916–3918.
- 48 W. T. Ford, R. J. Hauri, *J. Am. Chem. Soc.* **1973**, *95*, 7381–7391.
- 49 W. T. Ford, *J. Org. Chem.* **1973**, *38*, 3614–3615.
- 50 M. Badri, J.-J. Brunet, *Tetrahedron Lett.* **1992**, *33*, 4435–4438.
- 51 M. J. Earle, P. B. McCormac, K. R. Seddon, *Chem. Commun.* **1998**, 2245–2246.
- 52 C. Wheeler, K. N. West, C. L. Liotta, C. A. Eckert, *Chem. Commun.* **2001**, 887–888.
- 53 M. J. Earle, P. B. McCormac, K. R. Seddon, *Green Chem.* **2000**, *2*, 261–262.
- 54 C. M. Gordon, A. McClusky, *Chem. Commun.* **1999**, 143–144.
- 55 T. Kitazume, K. Kasai, *Green Chem.* **2001**, *3*, 30–32.
- 56 A. McCluskey, J. Garner, D. J. Young, S. Caballero, *Tetrahedron Lett.* **2000**, *41*, 8147–8151.
- 57 G. W. Kabalka, R. R. Malladi, *Chem. Commun.* **2000**, 2191.
- 58 T. Kitazume, F. Zulfiqar, G. Tanaka, *Green Chem.*, **2000**, *2*, 133–136.
- 59 P. P. Peng, Y. Q. Deng, *Tetrahedron Lett.* **2001**, *42*, 403–405.
- 60 T. Kitazume, G. Tanaka, *J. Fluorine Chem.* **2000**, *106*, 211–215.
- 61 D. W. Morrison, D. C. Forbes, J. H. Davis Jr., *Tetrahedron Lett.* **2001**, *42*, 6053–6055.
- 62 J. Peng, Y. Deng, *Tetrahedron Lett.* **2001**, *42*, 5917–5919.
- 63 R. D. Singer, P. J. Scammells, *Tetrahedron Lett.* **2001**, *42*, 6831–6833.
- 64 S. V. Ley, A. G. Leach, R. I. Storer, *J. Chem. Soc., Perkin Trans. 1* **2001**, 358–361.
- 65 C. Hardacre, J. D. Holbrey, S. E. McMath, *Chem. Commun.* **2001**, 367–368.
- 66 J. A. Boon, S. W. Lander Jr., J. A. Levisky, J. L. Pflug, L. M. Skrzniecki-Cooke, J. S. Wilkes, *Proceedings of the Joint International Symposium on Molten Salts*, 6th ed., **1987**, 979–990.
- 67 K. K. Laali, V. J. Gettwert, *J. Org. Chem.* **2001**, *66*, 35–40.
- 68 Y. Patell, N. Winterton, K. R. Seddon, World Patent WO 0037400, **2000**.
- 69 D. S. Newman, T. H. Kinstle, G. Thambo, *Proceedings of the Joint International Symposium on Molten Salts*, 6th ed., **1987**, 991–1001.
- 70 D. S. Newman, T. H. Kinstle, G. Thambo, *J. Electrochem. Soc.* **1987**, *134*, C512.
- 71 D. S. Newman, R. E. Winans, R. L. McBeth, *J. Electrochem. Soc.* **1984**, *131*, 1079–1083.
- 72 F. Zulfiqar, T. Kitazume, *Green Chem.* **2000**, *2*, 296–298.
- 73 S.-gi Lee, J. H. Park, J. Kang, J. K. Lee, *Chem. Commun.* **2001**, 1698–1699.
- 74 G. A. Olah, *Friedel-Crafts and Related Reactions*, Interscience, New York, **1963**.
- 75 G. A. Olah, *Friedel Crafts Chemistry*, Wiley-Interscience, New York, **1973**.
- 76 G. Baddeley, R. Williamson, *J. Chem. Soc.* **1953**, 2120–2123.
- 77 G. Baddeley, G. Holt, S. M. Makar, M. G. Ivinson, *J. Chem. Soc.* **1952**, 3605–3607.
- 78 W. L. Mendelson, C. B. Spainhour, S. S. Jones, B. L. Lamb, K. L. Wert, *Tetrahedron Lett.* **1980**, *21*, 1393–1396.
- 79 J. A. Boon, J. A. Levisky, J. L. Pflug, J. S. Wilkes, *J. Org. Chem.* **1986**, *51*, 480–483.
- 80 B. J. Piersma, M. Merchant in *Proceedings of the 7<sup>th</sup> International Symposium on Molten Salts* (C. L. Hussey, S. N. Flengas, J. S. Wilkes, Y. Ito eds.), The Electrochemical Society, Pennington, **1990**, 805–821.

- 81 P. K. G. Hodgson, M. L. M. Morgan, B. Ellis, A. A. K. Abdul-Sada, M. P. Atkins, K. R. Seddon, *US Patent*, US 5994602, 1999.
- 82 P. Wasserscheid, B. Ellis, H. Fabienne, *World Patent*, WO 0041809, 2000.
- 83 C. C. Greco, S. Fawzy, S. Lieh-Jiun, *US Patent*, US 5824832, 1998.
- 84 W. Keim, W. Korth, P. Wasserscheid, *World Patent*, WO 0016902, 2000.
- 85 C. E. Song, W. H. Shim, E. J. Roh, J. H. Choi, *Chem. Commun.* 2000, 1695–1696.
- 86 M. J. Earle, unpublished results, 1998.
- 87 C. P. DeCastro, E. Sauvage, M. H. Valkenberg, W. F. Hölderich, *World Patent*, WO 0132308, 2001.
- 88 C. P. DeCastro, E. Sauvage, M. H. Valkenberg, W. F. Hölderich, *J. Catal.* 2000, 196, 86–94.
- 89 J. L. Scott, D. R. MacFarlan, C. L. Raston, C. M. Teoh, *Green Chem.* 2000, 2, 123–126.
- 90 H. Raudnitz, G. Laube, *Ber.* 1929, 62, 509.
- 91 R. Scholl, K. Meyer, J. Donat, *Chem. Ber.* 1937, 70, 2180–2189.
- 92 D. B. Bruce, A. J. S. Sorrie, R. H. Thomson, *J. Chem. Soc.* 1953, 2403–2408.
- 93 G. C. Misra, L. M. Pande, G. C. Joshi, A. K. Misra, *Aust. J. Chem.* 1972, 25, 1579–1581.
- 94 S. Wagatsuma, H. Higuchi, T. Ito, T. Nakano, Y. Naoi, K. Sakai, T. Matsui, Y. Takahashi, A. Nishi, S. Sano, *Org. Prep. Proced. Int.* 1973, 5, 65–70.
- 95 C. J. Adams, M. J. Earle, G. Roberts, K. R. Seddon, *Chem. Commun.* 1998, 2097–2098.
- 96 P. N. Davey, M. J. Earle, C. P. Newman, K. R. Seddon, *World Patent* WO 99 19288, 1999.
- 97 M. H. Valkenberg, C. deCastro, W. F. Hölderich, *App. Catal. A* 2001, 215, 185–190.
- 98 G. L. Rebeiro, B. M. Khadilkar, *Syn. Commun.* 2000, 30, 1605–1608.
- 99 C. J. Adams, M. J. Earle, K. R. Seddon, *Green Chem.* 2000, 2, 21–24.
- 100 R. W. J. Westerhout, J. A. M. Kuipers, W. P. M. van Swaaij, *Ind. Eng. Chem. Res.* 1998, 37, 841–847.
- 101 P. N. Barnes, K. A. Grant, K. J. Green, N. D. Lever, *World Patent* WO 0040673, 2000.
- 102 C. J. Adams, M. J. Earle, J. Hamill, C. M. Lok, G. Roberts, K. R. Seddon, *World Patent* WO 9807680, 1998.
- 103 C. J. Adams, M. J. Earle, J. Hamill, C. M. Lok, G. Roberts, K. R. Seddon, *World Patent* WO 9807679, 1998.

## 5.2

### Transition Metal Catalysis in Ionic Liquids

*Peter Wasserscheid*

Many transition metal complexes dissolve readily in ionic liquids, which enables their use as solvents for transition metal catalysis. Sufficient solubility for a wide range of catalyst complexes is an obvious, but not trivial, prerequisite for a versatile solvent for homogenous catalysis. Some of the other approaches to the replacement of traditional volatile organic solvents by “greener” alternatives in transition metal catalysis, namely the use of supercritical CO<sub>2</sub> or perfluorinated solvents, very often suffer from low catalyst solubility. This limitation is usually overcome by use of special ligand systems, which have to be synthesized prior to the catalytic reaction.

In the case of ionic liquids, special ligand design is usually not necessary to obtain catalyst complexes dissolved in the ionic liquid in sufficiently high concentrations.

However, it should be mentioned that the dissolution process of a solid, crystalline complex in an (often relatively viscous) ionic liquid can sometimes be slow. This is due to restricted mass transfer and can be speeded up either by increasing the exchange surface (ultrasonic bath) or by reducing the ionic liquid's viscosity. The latter is easily achieved by addition of small amounts of a volatile organic solvent that dissolves both the catalyst complex and the ionic liquid. As soon as the solution is homogeneous, the volatile solvent is then removed *in vacuo*.

Since no special ligand design is usually required to dissolve transition metal complexes in ionic liquids, the application of ionic ligands can be an extremely useful tool with which to immobilize the catalyst in the ionic medium. In applications in which the ionic catalyst layer is intensively extracted with a non-miscible solvent (i.e., under the conditions of biphasic catalysis or during product recovery by extraction) it is important to ensure that the amount of catalyst washed from the ionic liquid is extremely low. Full immobilization of the (often quite expensive) transition metal catalyst, combined with the possibility of recycling it, is usually a crucial criterion for the large-scale use of homogeneous catalysis (for more details see Section 5.3.5).

The first example of homogeneous transition metal catalysis in an ionic liquid was the platinum-catalyzed hydroformylation of ethene in tetraethylammonium trichlorostannate (mp. 78 °C), described by Parshall in 1972 (Scheme 5.2-1, a) [1]. In 1987, Knifton reported the ruthenium- and cobalt-catalyzed hydroformylation of internal and terminal alkenes in molten  $[\text{Bu}_4\text{P}]\text{Br}$ , a salt that falls under the now accepted definition for an ionic liquid (see Scheme 5.2-1, b) [2]. The first applications of room-temperature ionic liquids in homogeneous transition metal catalysis were described in 1990 by Chauvin et al. and by Wilkes et al. Wilkes et al. used weakly acidic chloroaluminate melts and studied ethylene polymerization in them with Ziegler–Natta catalysts (Scheme 5.2-1, c) [3]. Chauvin's group dissolved nickel catalysts in weakly acidic chloroaluminate melts and investigated the resulting ionic catalyst solutions for the dimerization of propene (Scheme 5.2-1, d) [4].

The potential of ionic liquids as novel media for transition metal catalysis received a substantial boost from the work of Wilkes' group, when in 1992 they described the synthesis of non-chloroaluminate, room-temperature liquid systems with significantly enhanced stability to hydrolysis, such as low-melting tetrafluoroborate melts [5]. In contrast to the chloroaluminate ionic liquids, these "second generation ionic liquids" offer high tolerance to functional groups, which opens up a much larger range of applications, especially for transition metal catalysis. The first successful catalytic reactions in tetrafluoroborate ion-based ionic liquids included the rhodium-catalyzed hydrogenation and hydroformylation of olefins [6]. Nowadays, the tetrafluoroborate and the (published slightly later [7]) hexafluorophosphate ionic liquids are among the "workhorses" for transition metal catalysis in ionic liquids. They – like some other ionic liquids with weakly coordinating anions – combine the properties of relatively polar yet non-coordinating solvents. This special combination makes them extremely suitable solvents for reactions involving electrophilic catalysts [8]. Moreover, these ionic liquids are now widely commercially available [9], so research groups and companies focussing on catalyt-

a) Parshall (1972):

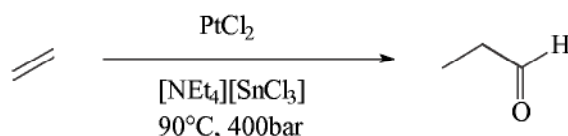

b) Knifton (1987):

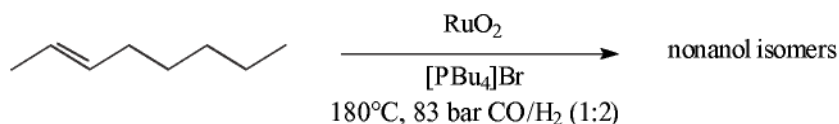

c) Wilkes et al. (1990):

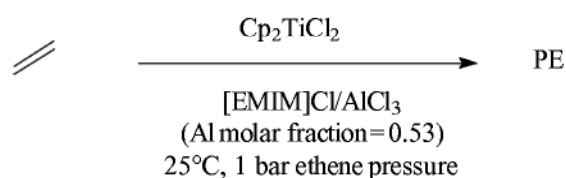

d) Chauvin et al. (1990):

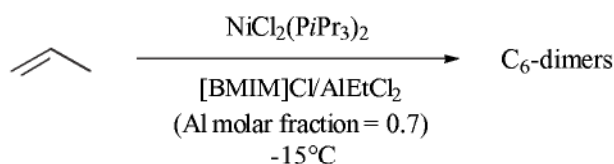

Scheme 5.2-1: Early examples of transition metal catalysis in ionic liquids.

ic applications do not necessarily have to go through all of the synthetic work themselves (for the synthesis of ionic liquids, and especially for the quality requirements related to their applications as solvents in homogeneous catalysis, see Chapter 2).

However, a number of limitations are still evident when tetrafluoroborate and hexafluorophosphate ionic liquids are used in homogeneous catalysis. The major aspect is that these anions are still relatively sensitive to hydrolysis. The tendency to anion hydrolysis is of course much less pronounced than that of the chloroaluminate melts, but it still occurs and this has major consequences for their use in transition metal catalysis. For example, the  $[\text{PF}_6]^-$  anion of 1-butyl-3-methylimidazolium ([BMIM]) hexafluorophosphate was found (in the author's laboratories) to hydrolyze completely after addition of excess water when the sample was kept for 8 h at 100 °C. Gaseous HF and phosphoric acid were formed. Under the same conditions, only small amounts of the tetrafluoroborate ion of [BMIM][BF<sub>4</sub>] was converted into HF and boric acid [10]. The hydrolytic formation of HF from the anion of the ionic liquid under the reaction conditions causes the following problems with



regard to their use as solvents for transition metal catalysis: a) loss or partial loss of the ionic liquid solvent, b) corrosion problems related to the HF formed, and c) deactivation of the transition metal catalyst through its irreversible complexation by  $F^-$  ions. Consequently, the application of tetrafluoroborate and hexafluorophosphate ionic liquids is effectively restricted – at least in technical applications – to those applications in which water-free conditions can be achieved at acceptable costs or – even more so – in which the catalyst or the substrates used are water-sensitive anyway, so that the reaction is traditionally carried out under inert conditions.

In 1996, Grätzel, Bonhôte and co-workers published syntheses and properties of ionic liquids with anions containing  $CF_3$  and other fluorinated alkyl groups [11]. These do not show the same sensitivity towards hydrolysis as  $[BF_4]^-$  and  $[PF_6]^-$ -containing systems. In fact, heating of  $[BMIM][[(CF_3SO_2)_2N]^-]$  with excess water to 100 °C for 24 h did not reveal any hint of anion hydrolysis [10]. Successful catalytic experiments with these ionic liquid systems have been reported in, for example, the hydrovinylation of styrene catalyzed by a cationic nickel complex in  $[EMIM][[(CF_3SO_2)_2N]^-]$  [12]. However, despite the very high stabilities of these salts to hydrolysis and a number of other very suitable properties (such as low viscosity, high thermal stability, easy preparation in halogen-free form due to the miscibility gap with water), the high price of  $[(CF_3SO_2)_2N]^-$  and of related anions may be a major problem for their practical application in larger quantities (the Li salt is commercially available from both Rhodia and 3M). Moreover, the presence of fluorine in the anion may still be problematic even if hydrolysis is not an issue. In addition to the elevated price of the anion (in itself related to the presence of fluorine), the disposal of spent ionic liquids of this type, by combustion, for example, is more complicated due to the presence of the fluorine.

In this context, the use of ionic liquids with halogen-free anions may become more and more popular. In 1998, Andersen et al. published a paper describing the use of some phosphonium tosylates (all with melting points  $>70$  °C) in the rhodium-catalyzed hydroformylation of 1-hexene [13]. More recently, in our laboratories, we found that ionic liquids with halogen-free anions and with much lower melting points could be synthesized and used as solvents in transition metal catalysis.  $[BMIM][n-C_8H_{17}SO_4]^-$  (mp = 35 °C), for example, could be used as catalyst solvent in the rhodium-catalyzed hydroformylation of 1-octene [14].

The author anticipates that the further development of transition metal catalysis in ionic liquids will, to a significant extent, be driven by the availability of new ionic liquids with different anion systems. In particular, cheap, halogen-free systems combining weak coordination to electrophilic metal centers and low viscosity with high stability to hydrolysis are highly desirable.

Very recently, Olivier-Bourbigou and Magna [15], Sheldon [16], and Gordon [17] have published three excellent reviews presenting a comprehensive overview of current work in transition metal catalysis involving ionic liquids, with slightly different emphases. All three update previously published reviews on the same topic, by Wasserscheid and Keim [18], Welton [19] and Seddon and Holbrey [20].

Without doubt, this extensive reviewing practice is a clear sign of the busy research activity in the field. However, there is clearly no need at present for another



er complete list of publications. Consequently, this section will aim to derive general principles from the work published so far, in order to provide a better understanding of the scope and limitations of the actual development of transition metal catalysis in ionic liquids. In this way, the author hopes to encourage scientists working in the field of transition metal catalysis to test and further develop ionic liquids as a “tool box” for their future research.

The section is divided into two major parts. Section 5.2.1 presents general motivation, successful concepts and current strategies, as well as those aspects that still represent limiting factors for transition metal catalysis in ionic liquids. In Section 5.2.2, selected applications are described in more detail, to demonstrate how the strategies explained earlier have already been used to produce new, superior catalytic systems. For the selection of these applications, the maturity of the research, the degree of understanding, the general significance, and the potential to transfer key results to future, new applications have been taken as criteria. The (obviously somewhat subjective) selection includes transition metal-catalyzed hydrogenation, oxidation, hydroformylation, Pd-catalyzed C-C-coupling and dimerization/oligomerization reactions that have been carried out using of ionic liquids.

### 5.2.1

#### **Why use Ionic Liquids as Solvents for Transition Metal Catalysis?**

##### **5.2.1.1 Their nonvolatile nature**

Probably the most prominent property of an ionic liquid is its lack of vapor pressure. Transition metal catalysis in ionic liquids can particularly benefit from this on economic, environmental, and safety grounds.

Obviously, the use of a nonvolatile ionic liquid simplifies the distillative workup of volatile products, especially in comparison with the use of low-boiling solvents, where it may save the distillation of the solvent during product isolation. Moreover, common problems related to the formation of azeotropic mixtures of the volatile solvents and the product/by-products formed are avoided by use of a nonvolatile ionic liquid. In the Rh-catalyzed hydroformylation of 3-pentenoic acid methyl ester it was even found that the addition of ionic liquid was able to stabilize the homogeneous catalyst during the thermal stress of product distillation (Figure 5.2-1) [21]. This option may be especially attractive technically, due to the fact that the stabilizing effects could already be observed even with quite small amounts of added ionic liquid.

As in stoichiometric organic reactions, the application of nonvolatile ionic liquids can contribute to the reduction of atmospheric pollution. This is of special relevance for non-continuous reactions, in which complete recovery of a volatile organic solvent is usually difficult to integrate into the process.

As well as this quite obvious environmental aspect, the switch from a volatile, flammable, organic solvent to an ionic liquid may significantly improve the safety of a given process. This will be especially true in oxidation reactions in which air or pure oxygen are used as oxidants; the use of common organic solvents is often restricted due to the potential formation of explosive mixtures between oxygen and

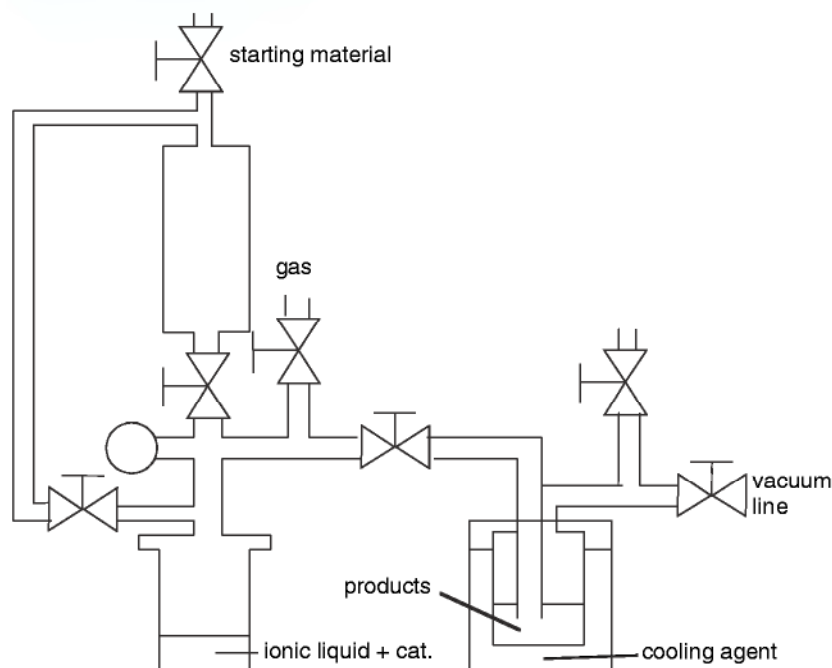

**Figure 5.2-1:** Stabilization of the active rhodium catalyst by addition of the ionic liquid [BMIM][PF<sub>6</sub>] as co-solvent during distillative product isolation - apparatus for distillative product isolation from the ionic catalyst layer.

the volatile organic solvent in the gas phase. Although no example of this issue being addressed by use of an ionic liquid has yet been published in the open literature, there is no doubt that the application of nonvolatile solvents should open up new ways to overcome these problems. It may therefore be anticipated that there will be some future technical applications for ionic liquids in which solely the advantage of their nonvolatile character is used, largely for safety reasons.

#### 5.2.1.2 New opportunities for biphasic catalysis

In comparison to heterogeneous catalyzed reactions, homogeneous catalysis offers several important advantages. The catalyst complex is usually well defined and can be rationally optimized by ligand modification. Every metal center can be active in the reaction. The reaction conditions are usually much milder ( $T$  usually  $< 200$  °C), and selectivities are often much higher than with heterogeneous catalysts.

These advantages notwithstanding, the proportion of homogeneous catalyzed reactions in industrial chemistry is still quite low. The main reason for this is the difficulty in separating the homogeneously dissolved catalyst from the products and by-products after the reaction. Since the transition metal complexes used in homogeneous catalysis are usually quite expensive, complete catalyst recovery is crucial in a commercial situation.

Biphasic catalysis in a liquid–liquid system is an ideal approach through which to combine the advantages of both homogeneous and heterogeneous catalysis. The reaction mixture consists of two immiscible solvents. Only one phase contains the catalyst, allowing easy product separation by simple decantation. The catalyst phase can be recycled without any further treatment. However, the right combination of catalyst, catalyst solvent, and product is crucial for the success of biphasic catalysis [22]. The catalyst solvent has to provide excellent solubility for the catalyst complex without competing with the reaction substrate for the free coordination sites at the catalytic center.

Even more attractive is the possibility of optimizing the reaction's activity and selectivity by means of a biphasic reaction mode. This can be achieved by *in situ* extraction of catalyst poisons or reaction intermediates from the catalytic layer. To benefit from this potential, however, even more stringent requirements have to be fulfilled by the catalyst solvent, since this now has to provide a specific, very low solubility for the substances that are to be extracted from the catalyst phase under the reaction conditions. Figure 5.2-2 demonstrates this concept, shown for an oligomerization reaction. The dimer selectivity of the oligomerization of compound A can be significantly enhanced if the reaction is carried out in biphasic mode with a catalyst solvent with a high preferential solubility for A. The produced A–A is readily extracted from the catalyst phase into the product layer, which reduces the chance of the formation of higher oligomers.

From all this, it becomes understandable why the use of traditional solvents (such as water or butanediol) for biphasic catalysis has only been able to fulfil this potential in a few specific examples [23], whereas this type of highly specialized liquid–liquid biphasic operation is an ideal field for the application of ionic liquids, mainly due to their exactly tunable physicochemical properties (see Chapter 3 for more details).

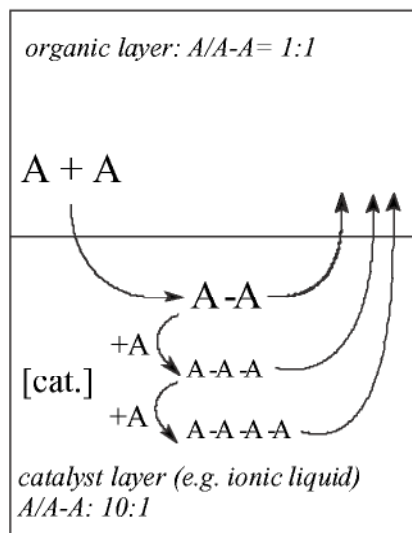

**Figure 5.2-2:** Enhanced dimer selectivity in the oligomerization of compound A due to a biphasic reaction mode with a catalyst solvent of high preferential solubility for A.

As well as the potential to enhance catalyst lifetime by recycling, or to improve a reaction's selectivity and a catalyst's activity by in situ extraction, biphasic catalysis also represents a very efficient way to reuse the (relatively expensive) ionic liquid itself. Thus – for a commercial application – the ionic liquid may be seen as an investment for the process (in an ideal case) or at least as a “working solution”, meaning that only a small amount has to be replaced after a certain time of application. Obviously, multiphasic catalysis is the most promising way to use ionic liquids in catalysis in general and in transition metal catalysis in particular. Therefore, most groups dealing with transition metal catalysis in ionic liquids explore their potential under multiphasic reaction conditions. Consequently, most of the examples given in Section 5.2.4 have been carried out under biphasic catalysis conditions.

Because of the great importance of liquid–liquid biphasic catalysis for ionic liquids, all of Section 5.3 is dedicated to specific aspects relating to this mode of reaction, with special emphasis on practical, technical, and engineering needs. Finally, Section 5.4 summarizes a very interesting recent development for biphasic catalysis with ionic liquids, in the form of the use of ionic liquid/compressed CO<sub>2</sub> biphasic mixtures in transition metal catalysis.

#### 5.2.1.3 Activation of a transition metal catalyst in ionic liquids

Apart from the activation of a biphasic reaction by extraction of catalyst poisons as described above, an ionic liquid solvent can activate homogeneously dissolved transition metal complexes by chemical interaction.

In general, it is possible for a chemical interaction between an ionic liquid solvent and a dissolved transition metal complex to be either activating or deactivating. It is therefore crucial to understand these chemical interactions in order to benefit from this potential and to avoid deactivation. Everything comes back to the rather obvious question of how much the presence of a specific ionic liquid influences the electronic and steric properties of the active catalyst complex and – perhaps even more importantly – to what extent the ionic liquid influences the availability of free coordination sites at the catalytic center for the substrates that are supposed to undergo the catalysis. Clearly, exact knowledge both of the catalytic mechanism in common organic solvents and of the chemical properties of the ionic liquid is very helpful in understanding these different effects.

In the following section, the nature of the chemical interactions between an ionic liquid and a transition metal catalyst is systematically developed according to the role of the ionic liquid in the different systems.

#### 5.2.2

##### The Role of the Ionic Liquid

Depending on the coordinative properties of the anion and on the degree of the cation's reactivity, the ionic liquid can be regarded as an “innocent” solvent, as a ligand (or ligand precursor), as a co-catalyst, or as the catalyst itself.

### 5.2.2.1 The ionic liquid as “innocent” solvent

Ionic liquids with weakly coordinating, inert anions (such as  $[(CF_3SO_2)_2N]^-$ ,  $[BF_4]^-$ , or  $[PF_6]^-$  under anhydrous conditions) and inert cations (cations that do not coordinate to the catalyst themselves, nor form species that coordinate to the catalyst under the reaction conditions used) can be looked on as “innocent” solvents in transition metal catalysis. In these cases, the role of the ionic liquid is solely to provide a more or less polar, more or less weakly coordinating medium for the transition metal catalyst, but which additionally offers special solubility for feedstock and products.

However, the chemical inertness of these “innocent” ionic liquids does not necessarily mean that the reactivity of a transition metal catalyst dissolved in the ionic liquid is equal to the reactivity observed in common organic solvents. This becomes understandable from the fact that many organic solvents applied in catalytic reactions do not behave as innocent solvents, but show significant coordination to the catalytic center. The reason why these solvents are nevertheless used in catalysis is that some polar or ionic catalyst complexes are not soluble enough in weakly coordinating organic solvents. For example, many cationic transition metal complexes are known to be excellent oligomerization catalysts [24]. However, their usually poor solubilities in non-polar solvents often require, if organic solvents are used, a compromise between the solvation and the coordination properties of the solvent. In order to achieve sufficient solubility of the metal complex a solvent of higher polarity is required, and this may compete with the substrate for the coordination sites at the catalytic center. Consequently, the use of an inert, weakly coordinating ionic liquid in these cases can result in a clear enhancement of catalytic activity, since some ionic liquids are known to combine high solvation power for polar catalyst complexes (polarity) with weak coordination (nucleophilicity) [25]. It is this combination of properties of the ionic liquids that cannot be attained with water or common organic solvents.

### 5.2.2.2 Ionic liquid as solvent and co-catalyst

Ionic liquids formed by treatment of a halide salt with a Lewis acid (such as chloroaluminate or chlorostannate melts) generally act both as solvent and as co-catalyst in transition metal catalysis. The reason for this is that the Lewis acidity or basicity, which is always present (at least latently), results in strong interactions with the catalyst complex. In many cases, the Lewis acidity of an ionic liquid is used to convert the neutral catalyst precursor into the corresponding cationic active form. The activation of  $Cp_2TiCl_2$  [26] and  $(ligand)_2NiCl_2$  [27] in acidic chloroaluminate melts and the activation of  $(PR_3)_2PtCl_2$  in chlorostannate melts [28] are examples of this kind of activation (Eqs. 5.2-1, 5.2-2, and 5.2-3).

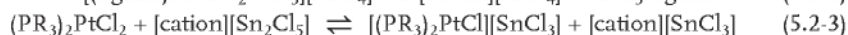
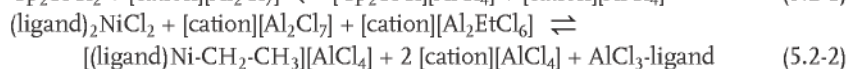



In cases in which the ionic liquid is not directly involved in creating the active catalytic species, a co-catalytic interaction between the ionic liquid solvent and the dissolved transition metal complex still often takes place and can result in significant catalyst activation. When a catalyst complex is, for example, dissolved in a slightly acidic ionic liquid, some electron-rich parts of the complex (e.g., lone pairs of electrons in the ligand) will interact with the solvent in a way that will usually result in a lower electron density at the catalytic center (for more details see Section 5.2.3).

If this higher electrophilicity of the catalytic center results in higher catalytic activity (as in oligomerization reactions of most olefins, for example), then there is a very good chance of activating the catalyst system in a slightly acidic ionic liquid. In fact, this is the reason why many Ni-catalyzed oligomerization reactions of propene and butene have been carried out in slightly acidic or buffered chloroaluminate ionic liquids.

This type of co-catalytic influence is well known in heterogeneous catalysis, in which for some reactions an acidic support will activate a metal catalyst more efficiently than a neutral support. In this respect, the acidic ionic liquid can be considered as a liquid acidic support for the transition metal catalysts dissolved in it.

As one would expect, in those cases in which the ionic liquid acts as a co-catalyst, the nature of the ionic liquid becomes very important for the reactivity of the transition metal complex. The opportunity to optimize the ionic medium used, by variation of the halide salt, the Lewis acid, and the ratio of the two components forming the ionic liquid, opens up enormous potential for optimization. However, the choice of these parameters may be restricted by some possible incompatibilities with the feedstock used. Undesired side reactions caused by the Lewis acidity of the ionic liquid or by strong interaction between the Lewis acidic ionic liquid and, for example, some oxygen functionalities in the substrate have to be considered.

### 5.2.2.3 Ionic liquid as solvent and ligand/ligand precursor

Both the cation and the anion of an ionic liquid can act as a ligand or ligand precursor for a transition metal complex dissolved in the ionic liquid.

Anions of the ionic liquid may, to some degree, act as ligands if the catalytic center is cationic, depending on their coordination strength. Indeed, it has been clearly demonstrated that the anion of a cationic transition metal complex is replaced to a large extent by the ionic liquid's anion if they are different [12]. While most ionic liquid anions used in catalysis are chosen so as to interact as weakly as possible with the catalytic center, this situation may change dramatically if the ionic liquid's anion undergoes decomposition reactions. If, for example, the hexafluorophosphate anion of an ionic liquid hydrolyses in contact with water, strongly coordinating fluoride ions are liberated, and will act as strong ligands and catalyst poisons to many transition metal complexes.

With respect to the ionic liquid's cation the situation is quite different, since catalytic reactions with anionic transition metal complexes are not yet very common in ionic liquids. However, an imidazolium moiety as an ionic liquid cation can act as a ligand precursor for the dissolved transition metal. Its transformation into a lig-



and under the reaction conditions has been observed in three different ways: a) formation of metal carbene complexes by deprotonation of the imidazolium cation, b) formation of metal–carbene complexes by oxidative addition of the imidazolium cation to the metal center, and c) dealkylation of the imidazolium cation and formation of a metal–imidazole complex. These different ways are shown in a general form in Scheme 5.2-2.

The first reaction pathway for the *in situ* formation of a metal–carbene complex in an imidazolium ionic liquid is based on the well known, relatively high acidity of the H atom in the 2-position of the imidazolium ion [29]. This can be removed (by basic ligands of the metal complex, for example) to form a metal–carbene complex (see Scheme 5.2-2, route a)). Xiao and co-workers demonstrated that a Pd imidazolylidene complex was formed when Pd(OAc)<sub>2</sub> was heated in the presence of [BMIM]Br [30]. The isolated Pd carbene complex was found to be active and stable in Heck coupling reactions (for more details see Section 5.2.4.4). Welton et al. were later able to characterize an isolated Pd–carbene complex obtained in this way by X-ray spectroscopy [31]. The reaction pathway to the complex is displayed in Scheme 5.2-3.

However, formation of the metal carbene complex was not observed in pure, halide-free [BMIM][BF<sub>4</sub>], indicating that the formation of carbene depends on the

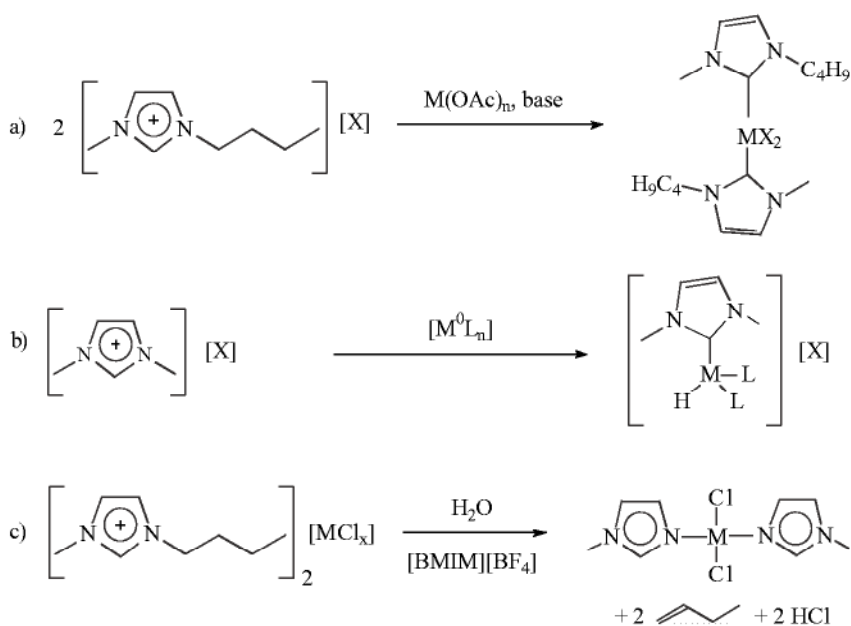

**Scheme 5.2-2:** Different potential routes for *in situ* ligand formation from an imidazolium cation of an ionic liquid.

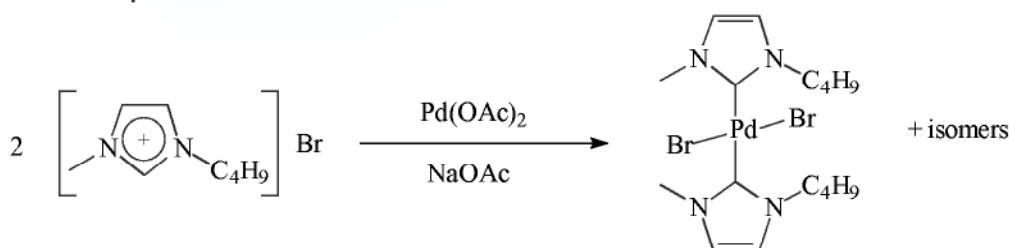

**Scheme 5.2-3:** Formation of a Pd-carbene complex by deprotonation of the imidazolium cation.

nucleophilicity of the ionic liquid's anion. To avoid the formation of metal carbene complexes by deprotonation of the imidazolium cation under basic conditions, the use of 2-methyl-substituted imidazolium is frequently suggested. However, it should be mentioned here that strong bases can also abstract a proton here, to form methyleneimidazolide species that may also act as a strong ligand to electrophilic metal centers.

Another means of *in situ* metal-carbene complex formation in an ionic liquid is the direct oxidative addition of the imidazolium cation to a metal center in a low oxidation state (see Scheme 5.2-2, route b)). Cavell and co-workers have observed oxidative addition on heating 1,3-dimethylimidazolium tetrafluoroborate with  $\text{Pt}(\text{PPh}_3)_4$  in refluxing THF [32]. The Pt-carbene complex formed can decompose by reductive elimination. Winterton et al. have also described the formation of a Pt-carbene complex by oxidative addition of the [EMIM] cation to  $\text{PtCl}_2$  in a basic [EMIM]Cl/ $\text{AlCl}_3$  system (free  $\text{Cl}^-$  ions present) under ethylene pressure [33]. The formation of a Pt-carbene complex by oxidative addition of the imidazolium cation is displayed in Scheme 5.2-4.

In the light of these results, it becomes important to question whether a particular catalytic result obtained in a transition metal-catalyzed reaction in an imidazolium ionic liquid is caused by a metal carbene complex formed *in situ*. The following simple experiments can help to verify this in more detail: a) variation of ligands in the catalytic system, b) application of independently prepared, defined metal carbene complexes, and c) investigation of the reaction in pyridinium-based ionic liquids. If the reaction shows significant sensitivity to the use of different ligands, if the application of the independently prepared, defined metal-carbene complex

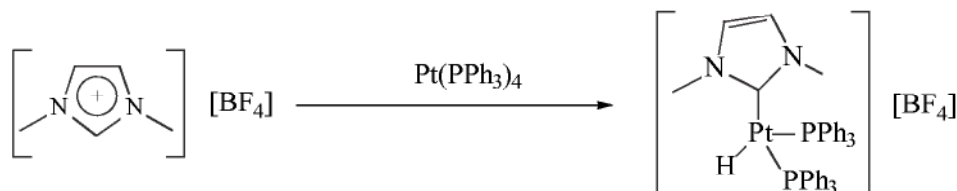

**Scheme 5.2-4:** Formation of a Pt-carbene complex by oxidative addition of the imidazolium cation.

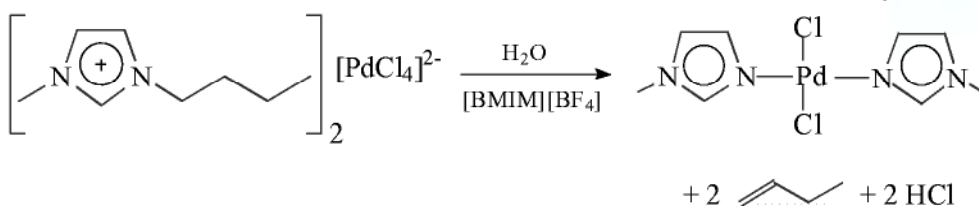

**Scheme 5.2-5:** Formation of the active Pd-catalyst from  $[\text{BMIM}]_2 \text{PdCl}_4$  for the hydrodimerization of 1,3-butadiene.

shows a different reactivity than the catalytic system under investigation, or if the catalytic result in the pyridinium ionic liquid is similar to that in the imidazolium system, then significant influence of a metal carbene complex formed *in situ* is unlikely. Of course, even then, *in situ* formation of a metal carbene complex cannot be totally excluded, but its lifetime may be very short so that significant influence on the catalysis does not take place.

Finally, a third means of ligand formation from an imidazolium cation, described by Dupont and co-workers, should be mentioned here [34]. They investigated the hydrodimerization/telomerization of 1,3-butadiene with palladium(II) compounds in  $[\text{BMIM}][\text{BF}_4]$  and described the activation of the catalyst precursor complex  $[\text{BMIM}]_2[\text{PdCl}_4]$  by a palladium(IV) compound formed by oxidative addition of the imidazolium nitrogen atom and the alkyl group with cleavage of the C–N bond of the  $[\text{BMIM}]^+$  ion, resulting in bis(methylimidazole) dichloropalladate (Scheme 5.2-5). However, this reaction was only observed in the presence of water.

#### 5.2.2.4 Ionic liquid as solvent and transition metal catalyst

Acidic chloroaluminate ionic liquids have already been described as both solvents and catalysts for reactions conventionally catalyzed by  $\text{AlCl}_3$ , such as catalytic Friedel–Crafts alkylation [35] or stoichiometric Friedel–Crafts acylation [36], in Section 5.1. In a very similar manner, Lewis-acidic transition metal complexes can form complex anions by reaction with organic halide salts. Seddon and co-workers, for example, patented a Friedel–Crafts acylation process based on an acidic chloroferrate ionic liquid catalyst [37].

However, ionic liquids acting as transition metal catalysts are not necessarily based on classical Lewis acids. Dyson et al. recently reported the ionic liquid  $[\text{BMIM}][\text{Co}(\text{CO})_4]$  [38]. The system was obtained as an intense blue-green colored liquid by metathesis between  $[\text{BMIM}]\text{Cl}$  and  $\text{Na}[\text{Co}(\text{CO})_4]$ . The liquid was used as a catalyst in the debromination of 2-bromoketones to their corresponding ketones.

In general, the incorporation of an active transition metal catalyst into the anion of an ionic liquid appears to be an attractive concept for applications in which a high catalyst concentration is needed.

## 5.2.3

**Methods of Analysis of Transition Metal Catalysts in Ionic Liquids**

Many transition metal-catalyzed reactions have already been studied in ionic liquids. In several cases, significant differences in activity and selectivity from their counterparts in conventional organic media have been observed (see Section 5.2.4). However, almost all attempts so far to explain the special reactivity of catalysts in ionic liquids have been based on product analysis. Even if it is correct to argue that a catalyst is more active because it produces more product, this is not the type of explanation that can help in the development of a more general understanding of what happens to a transition metal complex under catalytic conditions in a certain ionic liquid. Clearly, much more spectroscopic and analytical work is needed to provide better understanding of the nature of an active catalytic species in ionic liquids and to explain some of the observed “ionic liquid” effects on a rational, molecular level.

In general, most of the methods used to analyze the chemical nature of the ionic liquid itself, as described in Chapter 4, should also be applicable, in some more sophisticated form, to study the nature of a catalyst dissolved in the ionic liquid. For attempts to apply spectroscopic methods to the analysis of active catalysts in ionic liquids, however, it is important to consider three aspects: a) as with catalysis in conventional media, the lifetime of the catalytically active species will be very short, making it difficult to observe, b) in a realistic catalytic scenario the concentration of the catalyst in the ionic liquid will be very low, and c) the presence and concentration of the substrate will influence the catalyst/ionic liquid interaction. These three concerns alone clearly show that an ionic liquid/substrate/catalyst system is quite complex and may be not easy to study by spectroscopic methods.

One obvious approach involves the application of *in situ* NMR spectroscopy. However, this method often suffers from the relatively low concentration of the catalyst in the ionic liquid. Moreover,  $^1\text{H}$  and  $^{13}\text{C}$  NMR spectroscopic investigations are difficult, since the intense signals of the ionic liquid make clear detection of the dissolved catalyst difficult. Several approaches to overcome the latter problem have been suggested. Hardacre and co-workers have described the synthesis and application of fully deuterated ionic liquids [39]. Alternatively, deuterium can be selectively introduced into the ligand of the transition metal catalyst in order to study the complex dissolved in the ionic liquid by *in situ*  $^2\text{H}$  NMR spectroscopy [40]. The latter method has been used to investigate the activation of the square-planar Ni-complex ( $\eta$ -4-cycloocten-1-yl)(1,5-diphenyl-2,4-pentanedionato-O,O')nickel in slightly acidic chloroaluminate ionic liquids. The deuterated analogue of this complex was prepared according to Scheme 5.2-6, by treatment of 1,5-diphenyl-2,4-pentanedione with NaH, followed by hydrolysis with  $\text{D}_2\text{O}$ . The deuterated ligand was dried and treated with dicyclooctadienyl nickel  $\text{Ni}(\text{COD})_2$ .

$^2\text{H}$ NMR spectra of the deuterated complex obtained in  $\text{CH}_2\text{Cl}_2$  and in  $[\text{EMIM}]\text{Cl}/\text{AlCl}_3$  (1:1.2) are displayed in Figure 5.2-3.

While the deuterated complex shows the expected NMR signals in  $\text{CH}_2\text{Cl}_2$  (two signals from the complex and one signal from the solvent), the  $^2\text{H}$  NMR spectrum

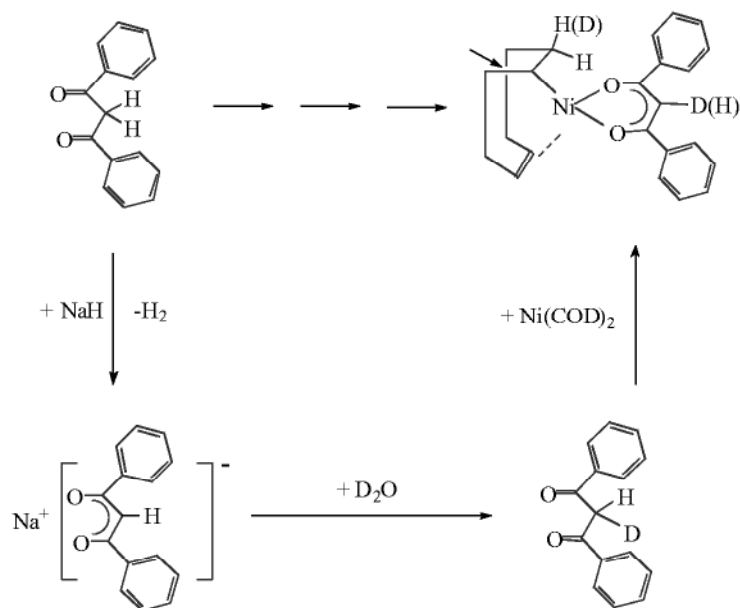

**Scheme 5.2-6:** Synthesis of a deuterated analogue of the square-planar Ni-complex ( $\eta$ -4-cycloocten-1-yl)(1,5-diphenyl-2,4-pentanedionato-O,O')nickel for  $^2\text{H}$  NMR investigations.

obtained from the complex in the slightly acidic chloroaluminate ionic liquid shows only one signal, indicating that the abstraction of COD is more efficient in the ionic liquid medium. Moreover, the deuterium signal of the acac ligand undergoes a significant downfield shift, suggesting intense electronic interaction between the ligand and the Lewis acidic centers of the melt. These interactions, which should result in an increased electrophilicity of the Ni-center, help to explain the activation of Ni-acac complexes in slightly acidic chloroaluminate ionic liquids.

This example should illustrate that *in situ* NMR spectroscopy can be a powerful tool with which to study catalysts dissolved in ionic liquids, if the signals of the metal complex can be detected in sufficient intensity independently from the signals of the ionic liquid.

If this is not possible for any reason, an alternative way to obtain some insight into interactions between the catalyst complex and the ionic liquid may be to record changes in the ionic liquid during the catalytic process in an indirect manner. This method has been successfully used by the author's group to understand the activation of  $(\text{PPh}_3)_2\text{PtCl}_2$  in chlorostannate ionic liquids in more detail. The change in color from yellow to red during the dissolution of the complex in the ionic liquid was attributed to the abstraction of chloride from the Pt-complex by the acidic  $[\text{Sn}_2\text{Cl}_5]^-$  species of the ionic liquid. It proved possible to support this assumption by recording the Lewis acidity of the chlorostannate ionic liquid by  $^{119}\text{Sn}$  NMR before and after the addition of  $(\text{PPh}_3)_2\text{PtCl}_2$  [28]. The results of this investigation corresponded very well to an acid–base reaction of both chloride atoms of the platinum complex with the acidic ionic liquid.

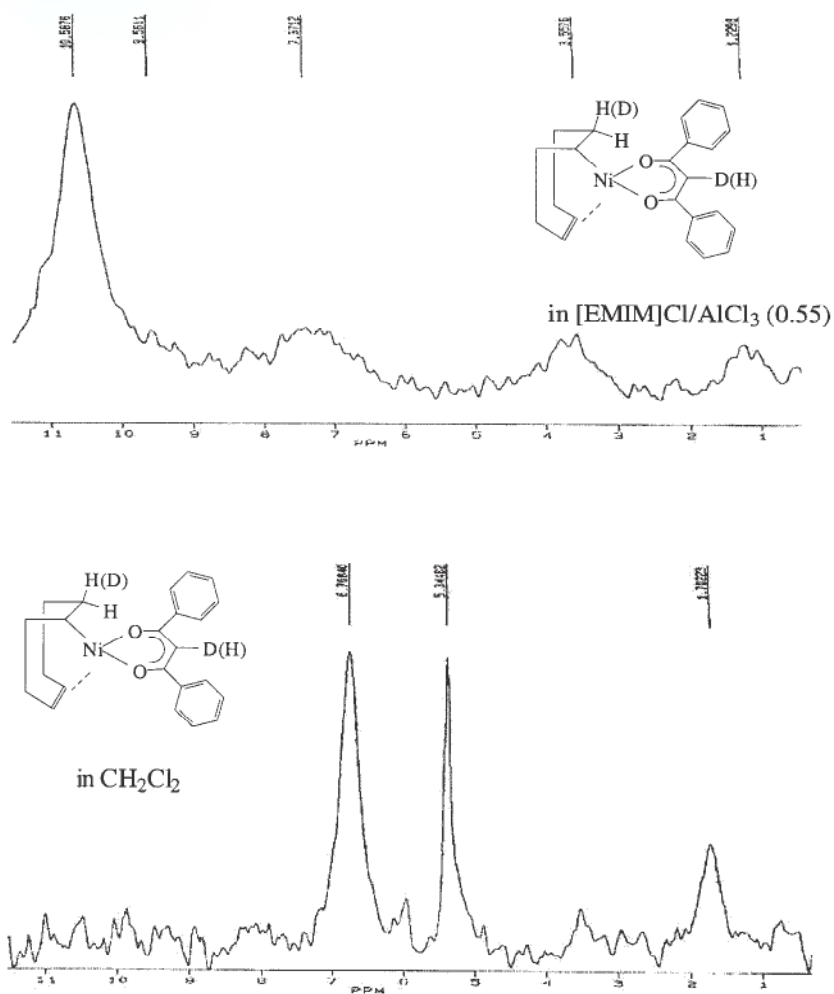

**Figure 5.2-3:**  $^2\text{H}$  NMR spectra of the deuterated analogue of the square planar Ni-complex ( $\eta$ -4-cycloocten-1-yl)(1,5-diphenyl-2,4-pentanedionato-O,O')nickel recorded  $[\text{EMIM}]\text{Cl}/\text{AlCl}_3$  [ $X(\text{AlCl}_3) = 0.55$ ] and in  $\text{CH}_2\text{Cl}_2$ .

In addition to *in situ* NMR spectroscopy, other methods such as *in situ* IR spectroscopy, EXAFS, and electrochemistry should be very useful for the investigation of active catalytic species in ionic liquids. However, far too little effort has been directed to this end in recent years.

This is surprising in view of the fact that a great deal of effort was made to study transition metal complexes in chloroaluminate ionic liquids in the 1980s and early 1990s (see Section 6.1 for some examples). The investigations at this time generally started with electrochemical studies [41], but also included spectroscopic and complex chemistry experiments [42].



Obviously, with the development of the first catalytic reactions in ionic liquids, the general research focus turned away from basic studies of metal complexes dissolved in ionic liquids. Today there is a clear lack of fundamental understanding of many catalytic processes in ionic liquids on a molecular level. Much more fundamental work is undoubtedly needed and should be encouraged in order to speed up the future development of transition metal catalysis in ionic liquids.

#### 5.2.4

#### Selected Examples of the Application of Ionic Liquids in Transition Metal Catalysis

##### 5.2.4.1 Hydrogenation

In general, transition metal-catalyzed hydrogenation reactions in ionic liquids are particularly promising. On the one hand, a large number of known, ionic hydrogenation catalysts are available [43]. On the other, the solubility of many alkenes and the availability of hydrogen in many ionic liquids appear to be sufficiently high for good reaction rates to be achieved. In this context it is noteworthy that the availability of hydrogen results not only from its solubility under equilibrium conditions, but also reflects the ease of its transfer from the gas phase into the melt. Since the diffusion of hydrogen into ionic liquids has been found to be relatively fast, the latter contribution is of special importance [44]. Finally, the miscibility gap between the saturated reaction products and the ionic liquid is often large, so that a biphasic procedure is possible in the majority of cases.

The first successful hydrogenation reactions in ionic liquids were studied by the groups of de Souza [45] and Chauvin [46] in 1995. De Souza et al. investigated the Rh-catalyzed hydrogenation of cyclohexene in 1-*n*-butyl-3-methylimidazolium ([BMIM]) tetrafluoroborate. Chauvin et al. dissolved the cationic "Osborn complex" [Rh(nbd)(PPh<sub>3</sub>)<sub>2</sub>][PF<sub>6</sub>] (nbd = norbornadiene) in ionic liquids with weakly coordinating anions (e.g., [PF<sub>6</sub>]<sup>-</sup>, [BF<sub>4</sub>]<sup>-</sup>, and [SbF<sub>6</sub>]<sup>-</sup>) and used the obtained ionic catalyst solutions for the biphasic hydrogenation of 1-pentene as seen in Scheme 5.2-7.

Although the reactants have only limited solubility in the catalyst phase, the rates of hydrogenation in [BMIM][SbF<sub>6</sub>] are almost five times faster than for the comparable reaction in acetone. All ionic catalyst solutions tested could be reused repeatedly. The loss of rhodium through leaching into the organic phase lay below the detection limit of 0.02 %. These results are of general importance for the field of

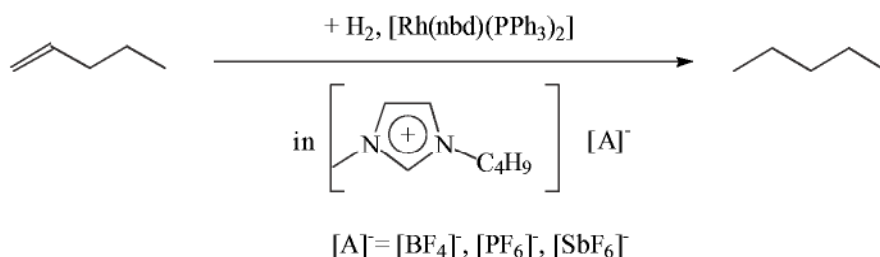

**Scheme 5.2-7:** Biphasic hydrogenation of 1-pentene with the cationic "Osborn complex" [Rh(nbd)(PPh<sub>3</sub>)<sub>2</sub>][PF<sub>6</sub>] (nbd = norbornadiene) in ionic liquids with weakly coordinating anions.

biphasic catalysis, since this was the first time that a rhodium catalyst was able to be “immobilized” in a polar solution without the use of specially designed ligands.

Chauvin’s group described the selective hydrogenation of cyclohexadiene to cyclohexene through making use of the biphasic reaction system [46]. Since the solubility of cyclohexadiene in [BMIM][SbF<sub>6</sub>] is about five times higher than the solubility of cyclohexene in the same ionic liquid, the latter was obtained in 98 % selectivity at 96 % conversion.

Rhodium- and cobalt-catalyzed hydrogenation of butadiene and 1-hexene [47, 48] and the Ru-catalyzed hydrogenation of aromatic compounds [49] and acrylonitrile–butadiene copolymers [50] have also been reported to be successful in ionic liquids.

An example of a stereoselective hydrogenation in ionic liquids was recently successfully demonstrated by Drießen-Hölscher et al. On the basis of investigations into the biphasic water/*n*-heptane system [51], the ruthenium-catalyzed hydrogenation of sorbic acid to *cis*-3-hexenoic acid in the [BMIM][PF<sub>6</sub>]/MTBE system was studied [52], as shown in Scheme 5.2-8.

In comparison with polar organic solvents (such as glycol) a more than threefold increase in activity with comparable selectivity for *cis*-3-hexenoic acid was observed in the ionic liquid. This is explained by partial deactivation (through complexation) of the active catalytic center in those polar organic solvents that are able to dissolve the cationic Ru catalyst. In contrast, the ionic liquid [BMIM][PF<sub>6</sub>] is known to combine high solvation power for ionic metal complexes with relatively weak coordination strength. In this way, the catalyst can be dissolved in a “more innocent” environment than is the case if polar organic solvents are used. After the biphasic hydrogenation of sorbic acid, the ionic catalyst solution could be recovered by phase separation and reused repeatedly. Other examples of selective hydrogenation of dienes by use of cobalt [47] and palladium [53] catalysts have been reported by Dupont and de Souza.

A number of enantioselective hydrogenation reactions in ionic liquids have also been described. In all cases reported so far, the role of the ionic liquid was mainly to open up a new, facile way to recycle the expensive chiral metal complex used as the hydrogenation catalyst.

Chauvin et al. hydrogenated  $\alpha$ -acetamidocinnamic acid to (*S*)-phenylalanine in the presence of a [Rh(cod)(–)-(diop)][PF<sub>6</sub>] catalyst in a [BMIM][SbF<sub>6</sub>] melt with 64 % *ee* [46].

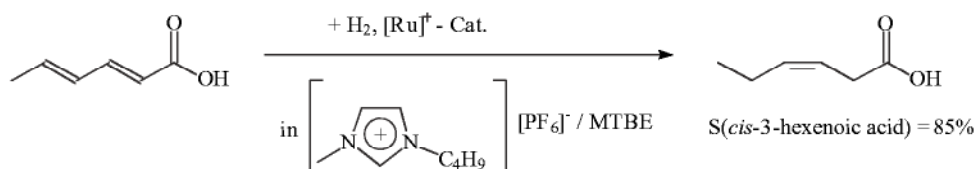

**Scheme 5.2-8:** Stereoselective hydrogenation of sorbic acid in the [BMIM][PF<sub>6</sub>]/MTBE biphasic system.

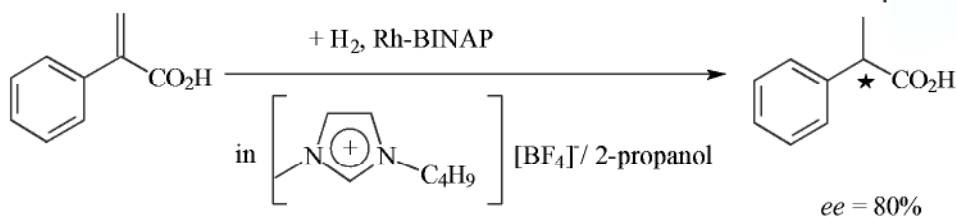

**Scheme 5.2-9:** Hydrogenation of 2-phenylacrylic acid to (*S*)-2-phenylpropionic acid with the chiral complex  $[\text{RuCl}_2(\text{S})\text{-BINAP}]_2\text{NEt}_3$  as catalyst in  $[\text{BMIM}][\text{BF}_4]$ .

Dupont et al. were able to obtain up to 80 % *ee* in the conversion of 2-phenylacrylic acid into (*S*)-2-phenylpropionic acid with the chiral  $[\text{RuCl}_2(\text{S})\text{-BINAP}]_2\text{NEt}_3$  complex as catalyst in  $[\text{BMIM}][\text{BF}_4]$  melts (Scheme 5.2-9) [54].

Both reactions were carried out under two-phase conditions with the help of an additional organic solvent (such as *i*PrOH). The catalyst could be reused with the same activity and enantioselectivity after decantation of the hydrogenation products. A more recent example, again by de Souza and Dupont, has been reported. They made a detailed study of the asymmetric hydrogenation of  $\alpha$ -acetamidocinnamic acid and the kinetic resolution of methyl ( $\pm$ )-3-hydroxy-2-methylenebutanoate with chiral Rh(I) and Ru(II) complexes in  $[\text{BMIM}][\text{BF}_4]$  and  $[\text{BMIM}][\text{PF}_6]$  [55]. The authors described the remarkable effects of the molecular hydrogen concentration in the ionic catalyst layer on the conversion and enantioselectivity of these reactions. The solubility of hydrogen in  $[\text{BMIM}][\text{BF}_4]$  was found to be almost four times higher than in  $[\text{BMIM}][\text{PF}_6]$ .

Hydrogenation reactions were among the first transformations to be successfully carried out in reaction systems consisting of an ionic liquid and compressed  $\text{CO}_2$  [56, 57]. While the conceptual aspects of this innovative, biphasic reaction mode are covered in more detail in Section 5.4, the specific applications reported by Tumas et al. [56] and Jessop et al. [57] once more demonstrate the great potential of transition metal-catalyzed hydrogenation in ionic liquids. Tumas and co-workers investigated the hydrogenation of olefins in the biphasic system  $[\text{BMIM}][\text{PF}_6]/s\text{CO}_2$ . After reaction, the ionic catalyst layer could be separated by simple decantation and could be reused up to four times [56].

Jessop and co-workers studied asymmetric hydrogenation reactions with the catalyst complex  $\text{Ru}(\text{OAc})_2(\text{tolBINAP})$  dissolved in  $[\text{BMIM}][\text{PF}_6]$ . In both reactions under investigation – the hydrogenation of tiglic acid (Scheme 5.2.10) and the hydrogenation of the precursor of the anti-inflammatory drug ibuprofen (Scheme 5.2.11) – no  $\text{CO}_2$  was present during the catalytic transformation. However,  $s\text{CO}_2$  was used in both cases to extract the reaction products from the reaction mixture when the reaction was complete.

Finally, a special example of transition metal-catalyzed hydrogenation in which the ionic liquid used does not provide a permanent biphasic reaction system should be mentioned. The hydrogenation of 2-butyne-1,4-diol, reported by Dyson et al., made use of an ionic liquid/water system that underwent a reversible two-

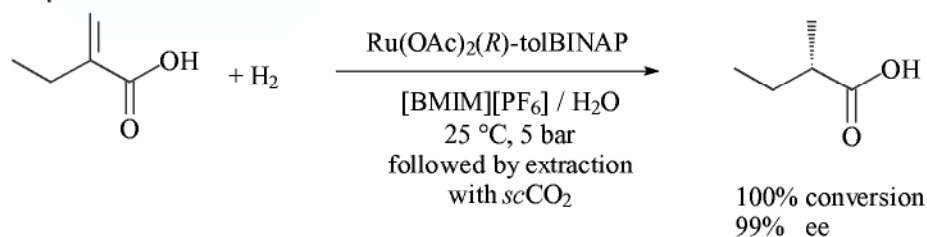

**Scheme 5.2-10:** Ru-catalyzed asymmetric hydrogenation of tiglic acid, followed by product extraction with *sc*CO<sub>2</sub>.

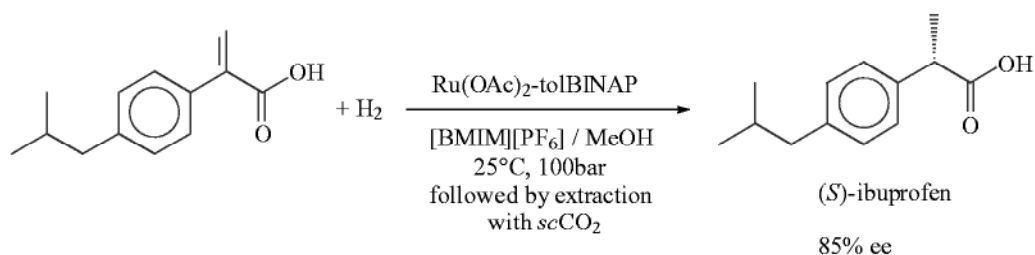

**Scheme 5.2-11:** Ru-catalyzed asymmetric hydrogenation of isobutylatropic acid, followed by extraction of the product ibuprofen with *sc*CO<sub>2</sub>.

phase/single-phase transformation upon a temperature switch [58]. At room temperature, the ionic liquid 1-methyl-3-*n*-octyl imidazolium ([OMIM]) tetrafluoroborate containing the cationic Rh catalyst formed a separate layer with water containing the substrate. At 80 °C however, a homogeneous single-phase reaction could be carried out.

Temperature-dependent phase behavior was first applied to separate products from an ionic liquid/catalyst solution by de Souza and Dupont in the telomerization of butadiene and water [34]. This concept is especially attractive if one of the substrates shows limited solubility in the ionic liquid solvent.

#### 5.2.4.2 Oxidation reactions

Catalytic oxidation reactions in ionic liquids have been investigated only very recently. This is somewhat surprising in view of the well known oxidation stability of ionic liquids, from electrochemical studies [11], and the great commercial importance of oxidation reactions. Moreover, for oxidation reactions with oxygen, the nonvolatile nature of the ionic liquid is of real advantage for the safety of the reaction. While the application of volatile organic solvents may be restricted by the formation of explosive mixtures in the gas phase, this problem does not arise if a nonvolatile ionic liquid is used as the solvent.

Howarth oxidized various aromatic aldehydes to the corresponding carboxylic acids with Ni(acac)<sub>2</sub> dissolved in [BMIM][PF<sub>6</sub>] as the catalyst and oxygen at atmospheric pressure as the oxidant [59]. However, this reaction cannot be considered a

real challenge. Moreover, the catalyst loading used for the described reaction was rather high (3 mol%).

Ley et al. reported oxidation of alcohols catalyzed by an ammonium perruthenate catalyst dissolved in  $[\text{NEt}_4]\text{Br}$  and  $[\text{EMIM}][\text{PF}_6]$  [60]. Oxygen or *N*-methylmorpholine *N*-oxide is used as the oxidant and the authors describe easy product recovery by solvent extraction and mention the possibility of reusing the ionic catalyst solution.

The oxidation of alkenes and allylic alcohols with the urea- $\text{H}_2\text{O}_2$  adduct (UHP) as oxidant and methyltrioxorhenium (MTO) dissolved in  $[\text{EMIM}][\text{BF}_4]$  as catalyst was described by Abu-Omar et al. [61]. Both MTO and UHP dissolved completely in the ionic liquid. Conversions were found to depend on the reactivity of the olefin and the solubility of the olefinic substrate in the reactive layer. In general, the reaction rates of the epoxidation reaction were found to be comparable to those obtained in classical solvents.

Song and Roh investigated the epoxidation of compounds such as 2,2-dimethylchromene with a chiral  $\text{Mn}^{\text{III}}(\text{salen})$  complex (Jacobsen catalyst) in a mixture of  $[\text{BMIM}][\text{PF}_6]$  and  $\text{CH}_2\text{Cl}_2$  (1:4 v/v), using  $\text{NaOCl}$  as the oxidant (Scheme 5.2-12) [62].

The authors describe a clear enhancement of the catalyst activity by the addition of the ionic liquid even if the reaction medium consisted mainly of  $\text{CH}_2\text{Cl}_2$ . In the presence of the ionic liquid, 86 % conversion of 2,2-dimethylchromene was observed after 2 h. Without the ionic liquid the same conversion was obtained only after 6 h. In both cases the enantiomeric excess was as high as 96 %. Moreover, the ionic catalyst solution could be reused several times after product extraction, although the conversion dropped from 83 % to 53 % after five recycles; this was explained, according to the authors, by a slow degradation process of the  $\text{Mn}^{\text{III}}$  complex.

A very exciting way to combine electrochemistry and transition metal catalysis in ionic liquids was reported by Gaillon and Bedioui [63], who investigated the electroassisted activation of molecular oxygen by Jacobsen's epoxidation catalysts dissolved in  $[\text{BMIM}][\text{PF}_6]$  and were able to provide evidence for the formation of the highly reactive oxomanganese(V) intermediate, which was not detectable in organic solvents. This may open new perspectives for clean, electroassisted oxidation reactions with molecular oxygen in ionic liquids.

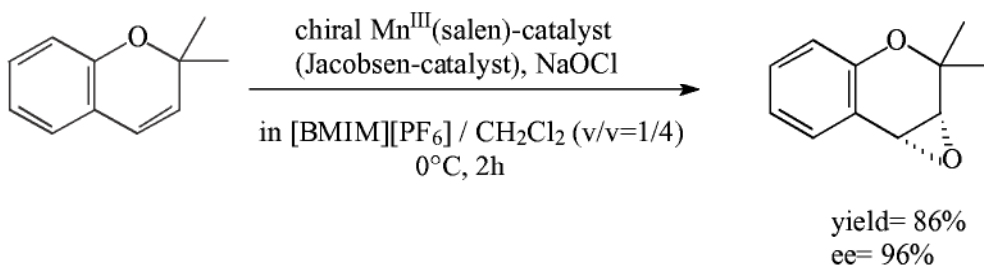

**Scheme 5.2-12:** Mn-catalyzed asymmetric epoxidation in a  $[\text{BMIM}][\text{PF}_6]/\text{CH}_2\text{Cl}_2$  (v/v = 1/4) solvent mixture.

Finally, it should be mentioned that ionic liquids have successfully been used in classical, stoichiometric oxidation reactions as well. Singer et al., for example, described the application of [BMIM][BF<sub>4</sub>] in the oxidation of codeine methyl ether to thebaine [64]. The ionic liquid was used here as a very convenient solvent to extract excess MnO<sub>2</sub> and associated impurities from the reaction mixture.

#### 5.2.4.3 Hydroformylation

In hydroformylation, biphasic catalysis is a well established method for effective catalyst separation and recycling. In the case of Rh-catalyzed hydroformylation reactions, this principle is implemented technically in the Ruhrchemie–Rhône–Poulenc process, in which water is used as the catalyst phase [65]. Unfortunately, this process is limited to C<sub>2</sub>–C<sub>5</sub>-olefins, due to the low water solubility of higher olefins. Nevertheless, the hydroformylation of many higher olefins is of commercial interest. One example is the hydroformylation of 1-octene for the selective synthesis of linear nonanal. This can be obtained highly selectively by application of special ligand systems around the catalytic center. However, the additional costs associated with the use of these ligands make it even more economically attractive to develop new methods for efficient catalyst separation and recycling. In this context, biphasic catalysis with an ionic liquid as catalyst layer is a highly promising approach.

As early as 1972 Parshall described the platinum-catalyzed hydroformylation of ethene in tetraethylammonium trichlorostannate melts [1]. [NEt<sub>4</sub>][SnCl<sub>3</sub>], the ionic liquid used for these investigations, has a melting point of 78 °C. Recently, platinum-catalyzed hydroformylation in the room-temperature chlorostannate ionic liquid [BMIM]Cl/SnCl<sub>2</sub> was studied in the author's group. The hydroformylation of 1-octene was carried out with remarkable *n/iso* selectivities (Scheme 5.2-13) [66].

Despite the limited solubility of 1-octene in the ionic catalyst phase, a remarkable activity of the platinum catalyst was achieved [turnover frequency (TOF) = 126 h<sup>-1</sup>]. However, the system has to be carefully optimized to avoid significant formation of hydrogenated by-product. Detailed studies to identify the best reaction conditions revealed that, in the chlorostannate ionic liquid [BMIM]Cl/SnCl<sub>2</sub> [X(SnCl<sub>2</sub>) = 0.55],

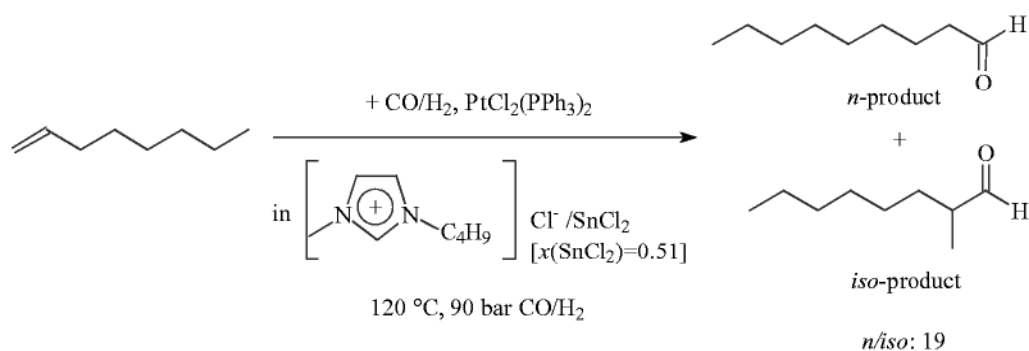

**Scheme 5.2-13:** Biphasic, Pt-catalyzed hydroformylation of 1-octene with a slightly acidic [BMIM]Cl/SnCl<sub>2</sub> ionic liquid as catalyst layer.



the highest ratio of hydroformylation to hydrogenation was found at high syn-gas pressure and low temperature. At 80 °C and 90 bar CO/H<sub>2</sub>-pressure, more than 90 % of all products were *n*-nonanal and *iso*-nonanal, the ratio between these two hydroformylation products being as high as 98.6:1.4 (*n/iso* = 72.4) [66].

Moreover, these experiments reveal some unique properties of the chlorostannate ionic liquids. In contrast to other known ionic liquids, the chlorostannate system combine a certain Lewis acidity with high compatibility to functional groups. The first resulted, in the hydroformylation of 1-octene, in the activation of (PPh<sub>3</sub>)<sub>2</sub>PtCl<sub>2</sub> by a Lewis acid–base reaction with the acidic ionic liquid medium. The high compatibility to functional groups was demonstrated by the catalytic reaction in the presence of CO and hydroformylation products.

Ruthenium- and cobalt-catalyzed hydroformylation of internal and terminal alkenes in molten [PBU<sub>4</sub>]Br was reported by Knifton as early as in 1987 [2]. The author described a stabilization of the active ruthenium-carbonyl complex by the ionic medium. An increased catalyst lifetime at low synthesis gas pressures and higher temperatures was observed.

The first investigations of rhodium-catalyzed hydroformylation in room-temperature liquid molten salts were published by Chauvin et al. in 1995 [6, 67]. The hydroformylation of 1-pentene with the neutral Rh(CO)<sub>2</sub>(acac)/triarylphosphine catalyst system was carried out as a biphasic reaction with [BMIM][PF<sub>6</sub>] as the ionic liquid. With none of the ligands tested, however, was it possible to combine high activity, complete retention of the catalyst in the ionic liquid, and high selectivity for the desired linear hydroformylation product at that time. The use of PPh<sub>3</sub> resulted in significant leaching of the Rh-catalyst out of the ionic liquid layer. In this case, the catalyst is active in both phases, which makes a clear interpretation of solvent effects on the reactivity difficult. The catalyst leaching could be suppressed by the application of sulfonated triaryl phosphine ligands, but a major decrease in catalytic activity was found with these ligands (TOF = 59 h<sup>-1</sup> with tppms, compared to 333 h<sup>-1</sup> with PPh<sub>3</sub>). Moreover, all of the ligands used in Chauvin's work showed poor selectivity to the desired linear hydroformylation product (*n/iso* ratio between 2 and 4). Obviously, the Rh-catalyzed, biphasic hydroformylation of higher olefins in ionic liquids requires the use of ligand systems specifically designed for this application. These early results thus stimulated research into other immobilizing, ionic ligand systems that would provide good catalyst immobilization without deactivation of the catalyst.

A pioneering ligand system specially designed for use in ionic liquids was described in 2000 by Salzer et al. [68]. Cationic ligands with a cobaltocenium backbone were successfully used in the biphasic, Rh-catalyzed hydroformylation of 1-octene. 1,1'-Bis(diphenylphosphino) cobaltocenium hexafluorophosphate (cdpp) proved to be an especially promising ligand. The compound can be synthesized as shown in Scheme 5.2-14, by mild oxidation of 1,1'-bis(diphenylphosphino)cobaltocene with C<sub>2</sub>Cl<sub>6</sub> and anion-exchange with [NH<sub>4</sub>][PF<sub>6</sub>] in acetone (for detailed ligand synthesis see [68]).

The results obtained in the biphasic hydroformylation of 1-octene are presented in Table 5.2-1. In order to evaluate the properties of the ionic diphosphine ligand

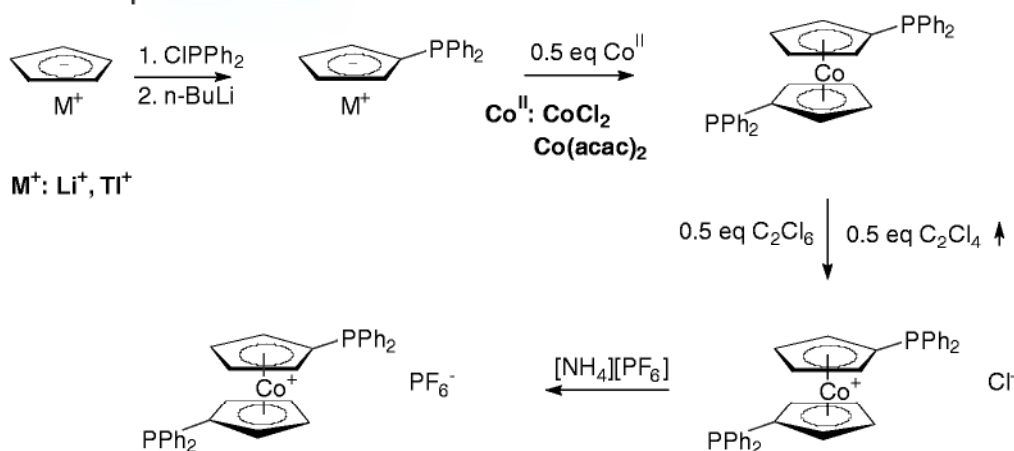

**Scheme 5.2-14:** Synthesis of 1,1'-bis(diphenylphosphino)cobaltocenium hexafluorophosphate.

with the cobaltocenium backbone, the results with the cdpp ligand are compared with those obtained with  $PPh_3$ , two common neutral bidentate ligands, and with Natppts as standard anionic ligand [68].

It is noteworthy that a clear enhancement of selectivity for the linear hydroformylation product is observed only with cdpp (Table 5.2-1, entry e). With all other ligands, the  $n/iso$  ratios are in the 2 to 4 range. While this is in accordance with known results in the case of  $PPh_3$  (entry a) and dppe (entry c) (in comparison to monophasic hydroformylation [69]) and also with reported results in the case of Natppts (entry b; in comparison to the biphasic hydroformylation of 1-pentene in  $[BMIM][PF_6]$  [46]), it is more remarkable for the bidentate metallocene ligand dppf.

Taking into account the high structural similarity of dppf and cdpp, their different influence on the reaction's selectivity has to be attributable to electronic effects. The electron density at the phosphorus atoms is significantly lower in the case of cdpp, due to the electron-withdrawing effect of the formal cobalt(III) central atom

Entry	Ligand	TOF ( $h^{-1}$ )	$n/iso$	$S$ ( $n$ -ald) (%) <sup>[a]</sup>
a	$PPh_3$	426	2.6	72
b	tppts	98	2.6	72
c	dppe	35	3.0	75
d	dppf	828	3.8	79
e	cdpp	810	16.2	94

Conditions: ligand/Rh: 2:1,  $CO/H_2 = 1:1$ ,  $t = 1$  h,  $T = 100$  °C,  $p = 10$  bar, 1-octene/Rh = 1000, 5 mL  $[BMIM][PF_6]$ ; dppe: bis(diphenylphosphinoethane); dppf: 1,1'-bis(diphenylphosphino)ferrocene; a)  $S$  ( $n$ -ald) = selectivity for  $n$ -nonanal in the product.

**Table 5.2-1:** Comparison of different phosphine ligands in the Rh-catalyzed hydroformylation of 1-octene in  $[BMIM][PF_6]$ .

in the ligand. This interpretation is supported by previous work by Casey et al. [70] and Duwell et al. [71], who described positive effects of ligands with electron-poor phosphorus atoms in selective hydroformylation reactions, which they attribute to their ability to allow back-bonding from the catalytically active metal atom. It has to be pointed out that with the phosphinocobaltocenium ligand *cdpp* the reaction takes place almost exclusively in the ionic liquid phase (almost clear and colorless organic layer, less than 0.5 % Rh in the organic layer). An easy catalyst separation by decantation was possible. Moreover, it was found that the recovered ionic catalyst solution could be reused at least one more time with the same activity and selectivity as in the original run [68].

Cationic phosphine ligands containing guanidiniumphenyl moieties were originally developed in order to make use of their pronounced solubility in water [72, 73]. They were shown to form active catalytic systems in Pd-mediated C–C coupling reactions between aryl iodides and alkynes (Castro–Stephens–Sonogashira reaction) [72, 74] and Rh-catalyzed hydroformylation of olefins in aqueous two-phase systems [75].

It was recently found that the modification of neutral phosphine ligands with cationic phenylguanidinium groups represents a very powerful tool with which to immobilize Rh-complexes in ionic liquids such as [BMIM][PF<sub>6</sub>] [76]. The guanidinium-modified triphenylphosphine ligand was prepared from the corresponding iodide salt by anion-exchange with [NH<sub>4</sub>][PF<sub>6</sub>] in aqueous solution, as shown in Scheme 5.2-15. The iodide can be prepared as previously described by Stelzer et al. [73].

In contrast to when PPh<sub>3</sub> is used as the ligand, the reaction takes place solely in the ionic liquid layer when the guanidinium-modified triphenylphosphine is applied. In the first catalytic run the hydroformylation activity was found to be somewhat lower than with PPh<sub>3</sub> (probably due to the fact that some of the activity observed with PPh<sub>3</sub> takes place in the organic layer). However, thanks to the excellent immobilization of the Rh-catalyst with the guanidinium-modified ligand [leaching is < 0.07 % per run according to ICP analysis (detection limit)], the cat-

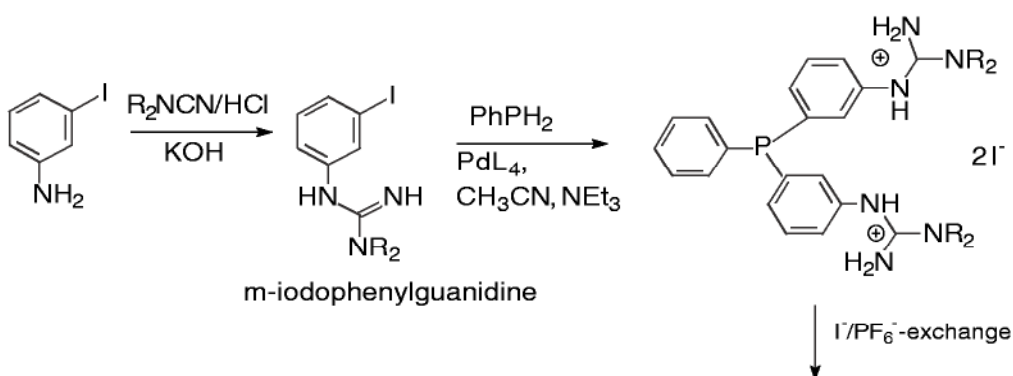

Scheme 5.2-15: Synthesis of a guanidinium-modified triphenylphosphine ligand.

alytic activity does not drop over the first ten recycling runs. For the recycling runs the organic layer was decanted after each run (under normal atmosphere) and the ionic catalyst layer was retained in the autoclave for the next hydroformylation experiment. Even after five recycling runs, the overall catalytic activity obtained with the ionic catalyst solution containing the guanidinium-modified ligand was higher than could be achieved with the simple  $\text{PPh}_3$  ligand. With both ligands the *n/iso* ratio of the hydroformylation products was in the expected range of 1.7–2.8.

Further development is directed towards the adaptation of this immobilization concept to a ligand structure that promises better regioselectivity in the hydroformylation reaction. It is well known that diphosphine ligands with large natural P-metal-P bite angles form highly regioselective hydroformylation catalysts [77]. Here, xanthene-type ligands (P-metal-P  $\sim 110^\circ$ ) developed by van Leeuwen's group proved to be especially suitable, allowing, for example, an overall selectivity of 98 % for the desired linear aldehyde in the hydroformylation of 1-octene [78, 79].

While unmodified xanthene ligands (compound a in Figure 5.2-4) show highly preferential solubility in the organic phase in the biphasic 1-octene/[BMIM][PF<sub>6</sub>] mixture even at room temperature, the application of the guanidinium-modified xanthene ligand (compound b in Figure 5.2-4) resulted in excellent immobilization of the Rh-catalyst in the ionic liquid.

The guanidinium-modified ligand is synthesized by treatment of the xanthenediphosphine [80] with iodophenylguanidine in a Pd(0)-catalyzed coupling reaction. The ligand was tested in Rh-catalyzed hydroformylation in ten consecutive recycling runs, the results of which are presented in Figure 5.2-5. It is noteworthy that the catalytic activity increases during the first runs, achieving a stable level only after the fourth recycling run. This behavior is attributable not only to a certain catalyst pre-forming but also to iodoaromate impurities in the ligand used. These are probably slowly washed out of the catalyst layer during the first catalytic runs.

After ten consecutive runs the overall turnover number reaches up to 3500 mol 1-octene converted per mol Rh-catalyst. In agreement with these recycling experiments, no Rh could be detected in the product layer by AAS or ICP, indicating leaching of less than 0.07 %. In all experiments, very good selectivities for the linear aldehyde were obtained, thus proving that the attachment of the guanidinium moiety onto the xanthene backbone had not influenced its known positive effect on

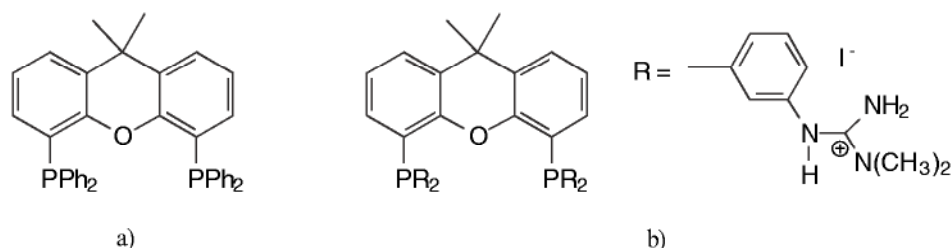

**Figure 5.2-4:** Unmodified (a) and guanidinium-modified (b) xanthene ligand as used in the biphasic, Rh-catalyzed hydroformylation of 1-octene.

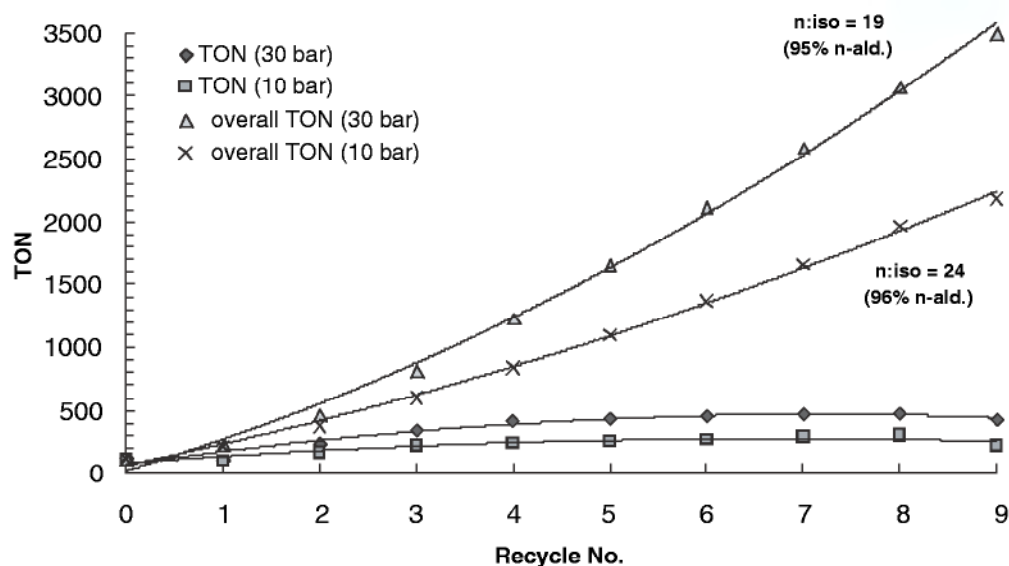

Figure 5.2-5: Recycling experiments - Rh-catalyzed, biphasic 1-octene hydroformylation in [BMIM][PF<sub>6</sub>] with a guanidinium-modified diphosphine ligand with xanthene backbone.

the regioselectivity of the reaction. Thus, these results demonstrate that the modification of known phosphine ligands with guanidinium groups is a simple and very efficient method by which to immobilize transition metal complexes fully in ionic liquids.

Alternatively, methods for the immobilization of phosphine ligands by attaching them to ionic groups with high similarity to the ionic liquid's cation have been reported. Both pyridinium-modified phosphine ligands [81] and imidazolium-modified phosphine ligands [82, 83] have been synthesized and applied in Rh-catalyzed hydroformylation (see Figure 5.2-6). While the presence of the ionic group resulted in better immobilization of the Rh-catalyst in the ionic liquid in all cases, no outstanding reactivity or selectivity were observed with these ligands. This is not really surprising, since all these ligands are electronically and sterically closely related to PPh<sub>3</sub>.

So far, research in the field of biphasic, Rh-catalyzed hydroformylation in ionic liquids has largely been dominated by attempts to improve the immobilization of the phosphine ligands in the ionic medium. Although the development of such ionic ligands is undoubtedly an important prerequisite for all future research in biphasic hydroformylation using ionic liquids, one should not forget other research activities with slightly different goals.

Olivier-Bourbigou's group, for example, has recently shown that phosphite ligands can be used in Rh-catalyzed hydroformylation in ionic liquids as well as the well known phosphine systems [81]. Since phosphite ligands are usually unstable in aqueous media, this adds (apart from the much better solubility of higher olefins in

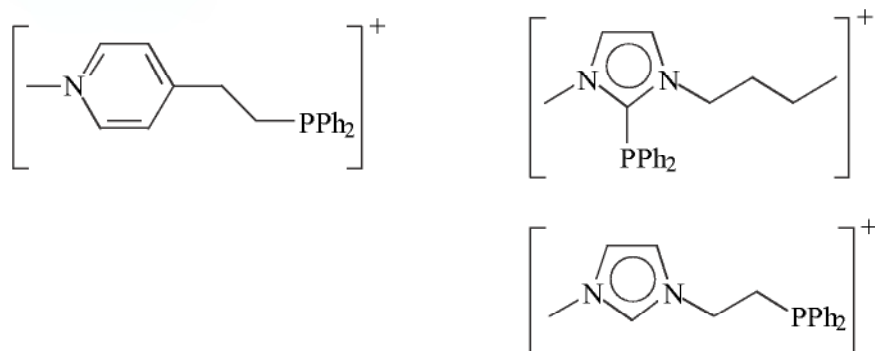

**Figure 5.2-6:** Cationic diphenylphosphine ligands as used in the biphasic, Rh-catalyzed hydroformylation of 1-octene in, for example, [BMIM][PF<sub>6</sub>].

ionic liquids) another important advantage to biphasic hydroformylation using ionic liquids in comparison to the well known biphasic reaction in water.

Another interesting recent development is the continuous, Rh-catalyzed hydroformylation of 1-octene in the unconventional biphasic system [BMIM][PF<sub>6</sub>]/scCO<sub>2</sub>, described by Cole-Hamilton et al. [84]. This specific example is described in more detail, together with other recent work in ionic liquid/scCO<sub>2</sub> systems, in Section 5.4.

Finally, research efforts to replace hexafluorophosphate (and other halogen-containing) ionic liquids by some cheap and halogen-free ionic liquids in Rh-catalyzed hydroformylation should be mentioned. The first attempts in this direction were made by Andersen et al. [13]. These authors investigated the hydroformylation of 1-hexene in high-melting phosphonium salts, such as butyltriphenylphosphonium tosylate (mp = 116–117 °C). Obviously, the high melting point of the salts used makes the processing of the reaction difficult, although the authors describe an easy product isolation by pouring the product off from the solid catalyst medium at room temperature.

In the author's group, much lower-melting benzenesulfonate, tosylate, or octylsulfate ionic liquids have recently been obtained in combination with imidazolium ions. These systems have been successfully applied as catalyst media for the biphasic, Rh-catalyzed hydroformylation of 1-octene [14]. The catalyst activities obtained with these systems were in all cases equal to or even higher than those found with the commonly used [BMIM][PF<sub>6</sub>]. Taking into account the much lower costs of the ionic medium, the better hydrolysis stability, and the wider disposal options relating to, for example, an octylsulfate ionic liquid in comparison to [BMIM][PF<sub>6</sub>], there is no real reason to center future hydroformylation research around hexafluorophosphate ionic liquids.



#### 5.2.4.4 Heck, Suzuki, Stille, and Negishi coupling reactions

The Heck reaction and other related transformations for selective C–C couplings are receiving a great deal of attention among synthetic chemists, due to their versatility for fine chemical synthesis. However, these reactions suffer in many cases from the instability of the Pd-catalysts used, resulting in high catalyst consumption and difficult processing.

The use of ionic liquids as reaction media for the palladium-catalyzed Heck reaction was first described by Kaufmann et al., in 1996 [85]. Treatment of bromobenzene with butyl acrylate to provide butyl *trans*-cinnamate succeeded in high yield in molten tetraalkylammonium and tetraalkylphosphonium bromide salts, without addition of phosphine ligands (Scheme 5.2-16).

The authors describe a stabilizing effect of the ionic liquid on the palladium catalyst. In almost all reactions no precipitation of elemental palladium was observed, even at complete conversion of the aromatic halide. The reaction products were isolated by distillation from the nonvolatile ionic liquid.

Extensive studies of the Heck reaction in low-melting salts have been presented by Hermann and Böhm [86]. Their results indicate that the application of ionic solvents offers clear advantages over that of commonly used organic solvents (e.g., DMF), especially for conversions of the commercially interesting chloroarenes. Additional activation and stabilization was observed with almost all catalyst systems tested. Among the ionic solvent systems investigated, molten  $[\text{NBu}_4]\text{Br}$  (mp = 103 °C) proved to be an especially suitable reaction medium. On treatment of bromobenzene with styrene, with diiodo-bis(1,3-dimethylimidazolin-2-ylidene)-palladium(II) as catalyst, the yield of stilbene could be increased from 20 % (DMF) to over 99 % ( $[\text{NBu}_4]\text{Br}$ ) under otherwise identical conditions. Again, distillative product separation from the nonvolatile ionic catalyst solution was possible. The latter could be reused up to thirteen times without any significant drop in activity. Additional advantages of the new solvent strategy lie in the excellent solubility of all reacting molecules in the ionic solvent and the possibility of using cheap inorganic bases.

This work was followed up by other research groups, using different substrates and other Pd-precursor/ligand combinations in molten  $[\text{NBu}_4]\text{Br}$  for Heck coupling.

Muzart et al. described the coupling of aryl iodides and bromides with allylic alcohols to give the corresponding  $\beta$ -arylated carbonyl compounds [87]. Calò et al.

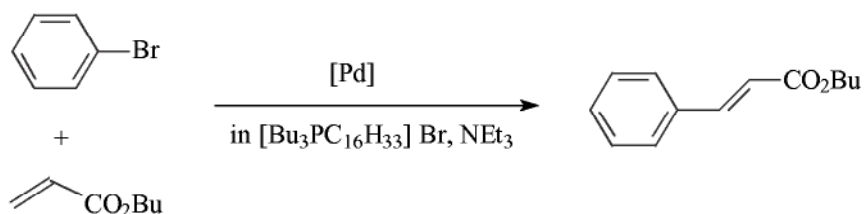

**Scheme 5.2-16:** Pd-catalyzed Heck reaction between butyl acrylate and bromobenzene, carried out in a phosphonium bromide salt.

described the Heck coupling of substituted acrylates with bromobenzene in molten  $[\text{NBu}_4]\text{Br}$ , catalyzed by Pd-benzothiazole carbene complexes [88]. The same solvent was found to be essential in investigations carried out by Buchmeiser et al. into the Pd-catalyzed Heck coupling of aryl chlorides and the amination of aryl bromides [89].

The use of imidazolium-based ionic liquids in Pd-catalyzed Heck reactions always carries with it the possibility of in situ formation of Pd-carbene complexes (for more details see Section 5.2.2.3). The formation of these under the conditions of the Heck reaction was confirmed by investigations by Xiao et al. [30], who described a significantly enhanced reactivity of the Heck reaction in  $[\text{BMIM}]\text{Br}$  in relation to the same reaction in  $[\text{BMIM}][\text{BF}_4]$  and explained this difference by the fact that formation of Pd-carbene complexes was observed only in the bromide melt.

The regioselective arylation of butyl vinyl ether was carried out by the same group, using  $\text{Pd}(\text{OAc})_2$  as catalyst precursor and 1,3-bis(diphenylphosphino)propane (dppp) as the ligand, dissolved in  $[\text{BMIM}][\text{BF}_4]$  (Scheme 5.2-17) [90].

The results in the ionic liquid were compared with those obtained in four conventional organic solvents. Interestingly, the reaction in the ionic liquid proceeded with very high selectivity to give the  $\alpha$ -arylated compound, whereas variable mixtures of the  $\alpha$ - and  $\beta$ -isomers were obtained in the organic solvents DMF, DMSO, toluene, and acetonitrile. Furthermore, no formation of palladium black was observed in the ionic liquid, while this was always the case with the organic solvents.

Seddon's group described the option of carrying out Heck reactions in ionic liquids that do not completely mix with water. These authors studied different Heck reactions in the triphasic  $[\text{BMIM}][\text{PF}_6]/\text{water}/\text{hexane}$  system [91]. While the  $[\text{BMIM}]_2[\text{PdCl}_4]$  catalyst used remains in the ionic liquid, the products dissolve in the organic layer, with the salt formed as a by-product of the reaction ( $[\text{H-base}]\text{X}$ ) being extracted into the aqueous phase.

Finally, some recently published Heck couplings of aryl iodides, including the use of Pd(0) nanoparticles formed in situ [92] and heterogeneous Pd on carbon [93] should be mentioned here.

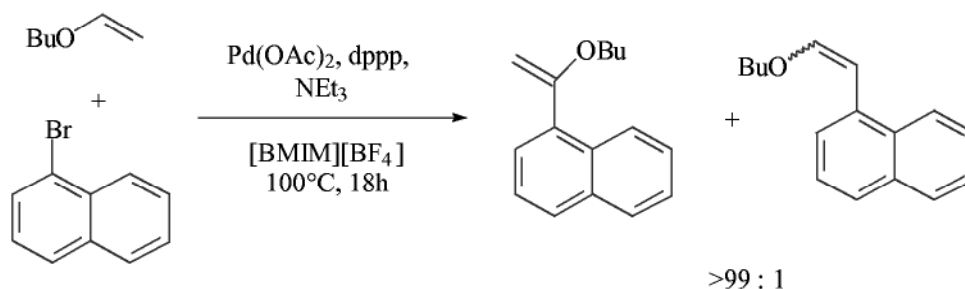

**Scheme 5.2-17:** Pd-catalyzed, regioselective arylation of butyl vinyl ether in a  $[\text{BMIM}][\text{BF}_4]$  ionic liquid.

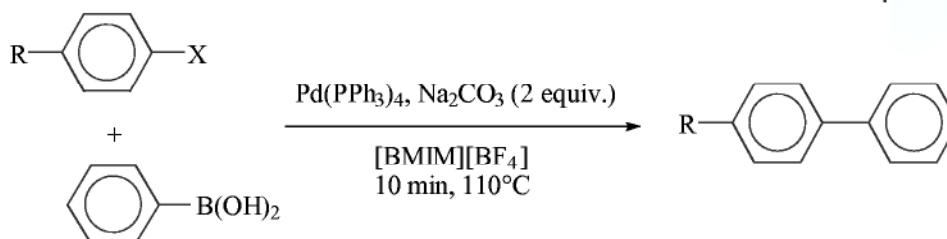

**Scheme 5.2-18:** Pd-catalyzed Suzuki cross-coupling reaction in a [BMIM][BF<sub>4</sub>] ionic liquid.

Suzuki cross-coupling reactions using Pd(PPh<sub>3</sub>)<sub>4</sub> as catalyst in [BMIM][BF<sub>4</sub>] have been reported by Welton et al. (Scheme 5.2-18) [94]. The best results were achieved by pre-heating the aryl halide to 110 °C in the ionic liquid with the Pd-complex. The arylboronic acid and Na<sub>2</sub>CO<sub>3</sub> were later added to start the reaction. Several advantages over the reaction as performed under the conventional Suzuki conditions were described. The reaction showed significantly enhanced activity in the ionic liquid (TOF = 455 h<sup>-1</sup> in [BMIM][BF<sub>4</sub>], in comparison to 5 h<sup>-1</sup> under conventional Suzuki conditions). The formation of the homo-coupling aryl by-product was suppressed. Moreover, the ionic catalyst layer could be reused after extraction of the products with ether and removal of the by-products (NaHCO<sub>3</sub> and NaXB(OH)<sub>2</sub>) with excess water. No deactivation was observed with this procedure over three further reaction cycles.

A number of Stille coupling reactions have been reported by Handy et al. [95]. With PdCl<sub>2</sub>(PhCN)<sub>2</sub>/Ph<sub>3</sub>As/CuI in [BMIM][BF<sub>4</sub>], good yields and good catalyst recyclability (up to five times) were reported for the reaction between α-iodoenones and vinyl and aryl stannanes (Scheme 5.2-19). However, the reported reaction rates were significantly lower than those obtained in NMP.

Knochel et al. described Pd-catalyzed Negishi cross-coupling reactions between zinc organometallics and aryl iodides in [BMMIM][BF<sub>4</sub>]. Scheme 5.2-20 illustrates the reaction for the formation of a 3-substituted cyclohexenone from 3-iodo-2-cyclohexen-1-one [82].

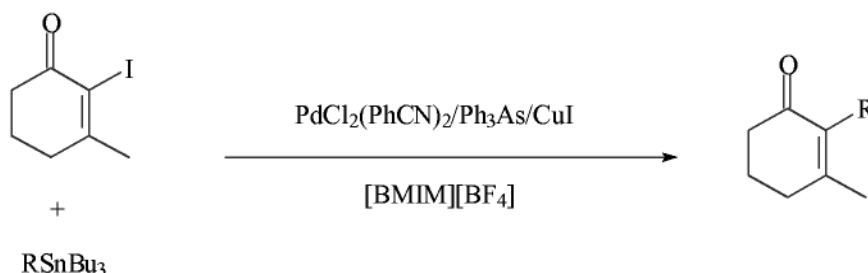

**Scheme 5.2-19:** Pd-catalyzed Stille coupling of α-iodoenones with vinyl and aryl stannanes in [BMIM][BF<sub>4</sub>].

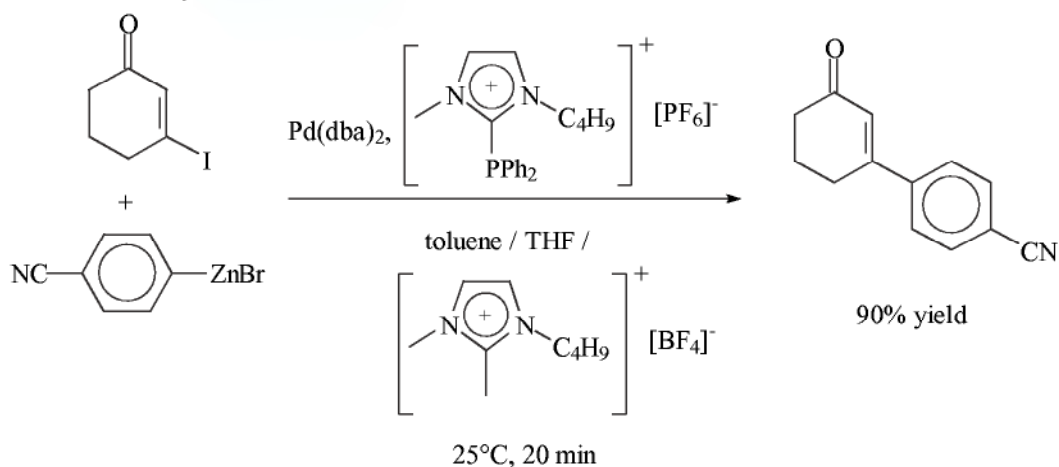

**Scheme 5.2-20:** Pd-catalyzed cross-coupling of organozinc compounds (Negishi cross-coupling) in  $[\text{BMMIM}][\text{BF}_4]$ .

The reaction was carried out in an ionic liquid/toluene biphasic system, which allowed easy product recovery from the catalyst by decantation. However, attempts to recycle the ionic catalyst phase resulted in significant catalyst deactivation after only the third recycle.

#### 5.2.4.5 Dimerization and oligomerization reactions

In dimerization and oligomerization reactions, ionic liquids have already proven to be a highly promising solvent class for the transfer of established catalytic systems into biphasic catalysis.

Biphasic catalysis is not a new concept for oligomerization chemistry. On the contrary, the oligomerization of ethylene was the first commercialized example of a biphasic, catalytic reaction. The process is known under the name “Shell Higher Olefins Process (SHOP)”, and the first patents originate from as early as the late 1960’s.

While the SHOP uses 1,4-butanediol as the catalyst phase, it turned out in subsequent years of research that many highly attractive catalyst systems for dimerization and oligomerization were not compatible with polar organic solvents or water. This was because the electrophilicity of the metal center is a key characteristic for its catalytic activity in oligomerization. The higher the electrophilicity of the metal center, the higher – usually – is its catalytic activity, but its compatibility with polar organic solvents or water is at the same time lower. Consequently, many cationic transition metal complexes may be excellent oligomerization catalysts [24], but none of these systems could be used in the biphasic reaction mode with water or polar organic solvents as the catalyst phase.

One technically important example of an oligomerization that could not be carried out in a liquid–liquid biphasic mode with polar organic solvents or water is the

Ni-catalyzed dimerization of propene and/or butenes, which was intensively studied in the 1960's [96] and later commercialized as the "Dimersol process" by the Institut Français du Pétrole (IFP). The active catalytic species is formed in situ through the reaction between a Ni(II) source and an alkylaluminium co-catalyst. The reaction takes place in a monophasic reaction mode in an organic solvent or – technically preferred – in the alkene feedstock. After the reaction, the catalyst is destroyed by addition of an aqueous solution of a base and the precipitated Ni salt is filtered off and has to be disposed of. Twenty-five Dimersol units are currently in operation, producing octane booster for gasoline with a total processing capacity of 3.4m tons per year. In view of the significant consumption of nickel and alkylaluminiums associated with the monophasic Dimersol process, it is not surprising that IFP research teams were looking for new solvent approaches to allow a biphasic version of the Dimersol chemistry. Chloroaluminate ionic liquids proved to be highly attractive in this respect.

As early as 1990, Chauvin and his co-workers from IFP published their first results on the biphasic, Ni-catalyzed dimerization of propene in ionic liquids of the [BMIM]Cl/AlCl<sub>3</sub>/AlEtCl<sub>2</sub> type [4]. In the following years the nickel-catalyzed oligomerization of short-chain alkenes in chloroaluminate melts became one of the most intensively investigated applications of transition metal catalysts in ionic liquids to date.

Because of its significance, some basic principles of the Ni-catalyzed dimerization of propene in chloroaluminate ionic liquids should be presented here. Table 5.2-2 displays some reported examples, selected to explain the most important aspects of oligomerization chemistry in chloroaluminate ionic liquids [97].

The Ni-catalyzed oligomerization of olefins in ionic liquids requires a careful choice of the ionic liquid's acidity. In basic melts (Table 5.2-2, entry (a)), no dimerization activity is observed. Here, the basic chloride ions prevent the formation of free coordination sites on the nickel catalyst. In acidic chloroaluminate melts, an oligomerization reaction takes place even in the absence of a nickel catalyst (entry (b)). However, no dimers are produced, but a mixture of different oligomers is

**Table 5.2-2:** Selected results from Ni-catalyzed propene dimerization in chloroaluminate ionic liquids.

<i>Ionic liquid</i>	<i>Composition of the ionic liquid (molar ratio)</i>	<i>Ni-complex</i>	<i>Activity (kg g(Ni)<sup>-1</sup> h<sup>-1</sup>)</i>	<i>Product DMB/M2P/nH<sup>(a)</sup></i>
a) [BMIM]Cl/AlCl <sub>3</sub>	1/0.8	NiBr <sub>2</sub> L <sub>2</sub> <sup>(b)</sup>	0	
b) [BMIM]Cl/AlCl <sub>3</sub>	1/1.5		[c]	
c) [BMIM]Cl/ AlEtCl <sub>2</sub>	1/1.2	NiCl <sub>2</sub>	2.5	5/74/21
d) [BMIM]Cl/ AlEtCl <sub>2</sub>	1/1.2	NiCl <sub>2</sub> (iPr <sub>3</sub> P) <sub>2</sub>	2.5	74/24/2
e) [BMIM]Cl/ AlCl <sub>3</sub> /AlEtCl <sub>2</sub>	1/1.2/0.1	NiCl <sub>2</sub> (iPr <sub>3</sub> P) <sub>2</sub>	12.5	83/15/2

T = -15 °C; (a) DMB = dimethylbutenes, M2P = methylpentenes, nH = n-hexenes,

(b) L = 2-methylallyl; (c) highly viscous oligomers from cationic oligomerization were obtained.

formed by cationic oligomerization. Superacidic protons and the reactivity of the acidic anions  $[\text{Al}_2\text{Cl}_7]^-$  and  $[\text{Al}_3\text{Cl}_{10}]^-$  may account for this reactivity.

The addition of alkylaluminium compounds is known to suppress this undesired cationic oligomerization activity. In the presence of  $\text{NiCl}_2$  as catalyst precursor, the ionic catalyst solution is formed and shows high activity for the dimerization (entry (c)). Without added phosphine ligands, a product distribution with no particular selectivity is obtained. In the presence of added phosphine ligand, the distribution of regioisomers in the C6-fraction is influenced by the steric and electronic properties of the ligand used in the same way as known from the catalytic system in organic solvents [96] (entry (d)). At longer reaction times, a decrease in the selectivity to highly branched products is observed. It has been postulated that a competing reaction of the basic phosphine ligand with the hard Lewis acid  $\text{AlCl}_3$  takes place. This assumption is supported by the observation that the addition of a soft competing base such as tetramethylbenzene can prevent the loss in selectivity.

Unfortunately, investigations with ionic liquids containing high amounts of  $\text{AlEtCl}_2$  showed several limitations, including the reductive effect of the alkylaluminium affecting the temperature stability of the nickel catalyst. At very high alkylaluminium concentrations, precipitation of black metallic nickel was observed even at room temperature.

From these results, the Institut Français du Pétrole (IFP) has developed a biphasic version of its established monophasic “Dimersol process”, which is offered for licensing under the name “Difasol process” [98]. The “Difasol process” uses slightly acidic chloroaluminate ionic liquids with small amounts of alkylaluminiums as the solvent for the catalytic nickel center. In comparison to the established “Dimersol process”, the new biphasic ionic liquid process drastically reduces the consumption of Ni-catalyst and alkylaluminiums. Additional advantages arise from the good performance obtained with highly diluted feedstocks and the significantly improved dimer selectivity of the “Difasol process” (for more detailed information see Section 5.3).

Closely related catalytic systems have also been used for the selective dimerization of ethene to butenes [99]. Dupont et al. dissolved  $[\text{Ni}(\text{MeCN})_6][\text{BF}_4]_2$  in the slightly acidic  $[\text{BMIM}]\text{Cl}/\text{AlCl}_3/\text{AlEtCl}_2$  chloroaluminate system (ratio = 1: 1.2: 0.25) and obtained 100 % butenes at  $-10\text{ }^\circ\text{C}$  and 18 bar ethylene pressure (TOF =  $1731\text{ h}^{-1}$ ). Unfortunately, the more valuable 1-butene was not produced selectively, with a mixture of all linear butene isomers (i.e., 1-butene, *cis*-2-butene, *trans*-2-butene) being obtained.

More recently, biphasic ethylene oligomerization reactions that make use of catalytic metals other than nickel have been described in chloroaluminate ionic liquids. Olivier-Bourbigou et al. dissolved the tungsten complex  $[\text{Cl}_2\text{W}=\text{NPh}(\text{PMe}_3)_3]$  in a slightly acidic  $[\text{BMIM}]\text{Cl}/\text{AlCl}_3$  ionic liquid and used this ionic catalyst solution in ethylene oligomerization without addition of a co-catalyst [100]. At  $60\text{ }^\circ\text{C}$  and 40 bar a product distribution of 81 % butenes, 18 % hexenes, and 1 % higher oligomers was obtained with good activity (TOF =  $1280\text{ h}^{-1}$ ). However, the selectivity for the more valuable 1-olefins was found to be relatively low (65 %). The selective, chromium-catalyzed trimerization of ethylene to 1-hexene in a biphasic reaction system using alkylchloroaluminate ionic liquids was reported in a patent by SASOL [101].



$[\text{Ni}(\text{MeCN})_6][\text{BF}_4]_2$  dissolved in the slightly acidic chloroaluminate system  $[\text{BMIM}]\text{Cl}/\text{AlCl}_3/\text{AlEtCl}_2$  (ratio = 1: 1.2: 0.25) has been used not only for the dimerization of ethene but also – at 10 °C and under atmospheric pressure – for the dimerization of butenes [102]. The reaction showed high activity under these conditions, with a turnover frequency of  $6840 \text{ h}^{-1}$  and a productivity of 6 kg oligomer per gram Ni per hour. The distribution of the butene dimers obtained (typically  $39 \pm 1 \%$  dimethylhexenes,  $56 \pm 2 \%$  monomethylheptenes, and  $6 \pm 1 \%$  *n*-octenes) was reported to be independent of the addition of phosphine ligands. Moreover, the product mix was independent of feedstock, with both 1-butene and 2-butenes yielding the same dimer distribution, with only 6 % of the linear product. This clearly indicates that the catalytic system used here is not only an active oligomerization catalyst but also highly active for isomerization.

The selective, Ni-catalyzed, biphasic dimerization of 1-butene to linear octenes has been studied in the author's group. A catalytic system well known for its ability to form linear dimers from 1-butene in conventional organic solvents – namely the square-planar Ni-complex  $(\eta\text{-}4\text{-cycloocten-}1\text{-yl})(1,1,1,5,5,5\text{-hexafluoro-}2,4\text{-pentanedionato-O,O'})\text{nickel} [(H\text{-COD})\text{Ni}(\text{hfacac})]$  [103] – was therefore used in chloroaluminate ionic liquids.

For this specific task, ionic liquids containing alkylaluminiums proved unsuitable, due to their strong isomerization activity [102]. Since, mechanistically, only the linkage of two 1-butene molecules can give rise to the formation of linear octenes, isomerization activity in the solvent inhibits the formation of the desired product. Therefore, slightly acidic chloroaluminate melts that would enable selective nickel catalysis without the addition of alkylaluminiums were developed [104]. It was found that an acidic chloroaluminate ionic liquid buffered with small amounts of weak organic bases provided a solvent that allowed a selective, biphasic reaction with  $[(H\text{-COD})\text{Ni}(\text{hfacac})]$ .

The function of the base is to trap any free acidic species, which might initiate cationic side reactions, in the melt. A suitable base has to fulfil a number of requirements. Its basicity has to be in the appropriate range to provide enough reactivity to eliminate all free acidic species in the melt. At the same time, it has to be non-coordinating with respect to the catalytically active Ni center. Another important feature is a very high solubility in the ionic liquid. During the reaction, the base has to remain in the ionic catalyst layer even under intensive extraction of the ionic liquid by the organic layer. Finally, the base has to be inert to the 1-butene feedstock and to the oligomerization products.

The use of pyrrole and *N*-methylpyrrole was found to be preferable. Through the addition of *N*-methylpyrrole, all cationic side reactions could be effectively suppressed, and only dimerization products produced by Ni-catalysis were obtained. In this case the dimer selectivity was as high as 98 %. Scheme 5.2-21 shows the catalytic system that allowed the first successful application of  $[(H\text{-COD})\text{Ni}(\text{hfacac})]$  in the biphasic linear dimerization of 1-butene.

Comparison of the dimerization of 1-butene with  $[(H\text{-COD})\text{Ni}(\text{hfacac})]$  in chloroaluminate ionic liquids with the identical reaction in toluene is quite instructive. First of all, the reaction in the ionic liquid solvent is biphasic with no detectable

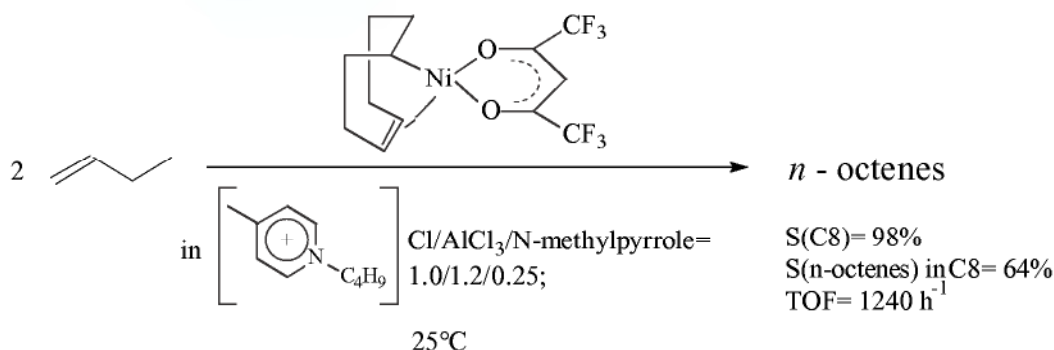

**Scheme 5.2-21:** Ni-catalyzed, biphasic, linear dimerization in a slightly acidic, buffered chloroaluminate ionic liquid.

catalyst leaching, enabling easy catalyst separation and recycling. While [(H-COD)Ni(hfacac)] in toluene requires an activation temperature of 50 °C, the reaction proceeds in the ionic liquid even at -10 °C. This indicates that the catalyst activation, believed to be the formation of the active Ni-hydride complex, proceeds much more efficiently in the chloroaluminate solvent (for more details on mechanistic studies see Section 5.2.3). Furthermore, the product selectivities obtained in both solvents show significantly higher dimer selectivities in the biphasic case. This can be understood by considering the fact that the C8-product is much less soluble than the butene feedstock in the ionic liquid (by about a factor of 4). During the reaction, rapid extraction of the C8-product into the organic layer takes place, thus preventing subsequent C12-formation. The linear selectivity is high in both solvents, although somewhat lower in the ionic liquid solvent.

To produce reliable data on the lifetime and overall activity of the ionic catalyst system, a loop reactor was constructed and the reaction was carried out in continuous mode [105]. Some results of these studies are presented in Section 5.3, together with much more detailed information about the processing of biphasic reactions with an ionic liquid catalyst phase.

Biphasic oligomerization with ionic liquids is not restricted to chloroaluminate systems. Especially in those cases where the – at least – latent acidity or basicity of the chloroaluminate causes problems, neutral ionic liquids with weakly coordinating anions can be used with great success.

As already mentioned above, the Ni-catalyzed oligomerization of ethylene in chloroaluminate ionic liquids was found to be characterized by high oligomerization and high isomerization activity. The latter results in a rapid consecutive transformation of the  $\alpha$ -olefins formed into mixtures of far less valuable internal olefins. Higher  $\alpha$ -olefins (HAOs) are an important group of industrial chemicals that find a variety of end uses. Depending on their chain length, they are components of plastics (C4-C6 HAOs in copolymerization), plasticizers (C6-C10 HAOs through hydroformylation/hydrogenation, lubricants (C10-C12 HAOs through oligomerization), and surfactants (C12-C16 HAOs through arylation/sulfonation).

**Figure 5.2-7:** The cationic Ni-complex  $[(\text{mall})\text{Ni}(\text{dppmo})][\text{SbF}_6]$  as used for the biphasic oligomerization of ethylene to  $\alpha$ -olefins in, for example,  $[\text{BMIM}][\text{PF}_6]$ .

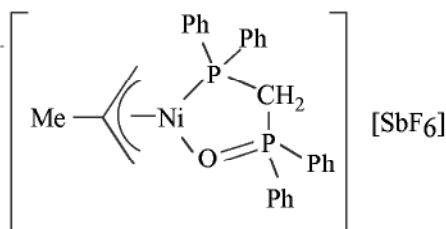

In addition to the neutral nickel/phosphine complexes used in the Shell Higher Olefins Process (SHOP), cationic Ni-complexes such as  $[(\text{mall})\text{Ni}(\text{dppmo})][\text{SbF}_6]$  (see Figure 5.2-7) have attracted some attention as highly selective and highly active catalysts for ethylene oligomerization to HAOs [106].

However, all attempts to carry out biphasic ethylene oligomerization with this cationic catalyst in traditional organic solvents, such as 1,4-butanediol (as used in the SHOP) resulted in almost complete catalyst deactivation by the solvent. This reflects the much higher electrophilicity of the cationic complex  $[(\text{mall})\text{Ni}(\text{dppmo})][\text{SbF}_6]$  in relation to the neutral Ni-complexes used in the SHOP.

It was recently demonstrated in the author's group that the use of hexafluorophosphate ionic liquids allows, for the first time, selective, biphasic oligomerization of ethylene to 1-olefins with the aid of the cationic Ni-complex  $[(\text{mall})\text{Ni}(\text{dppmo})][\text{SbF}_6]$  (Scheme 5.2-22) [25, 107].

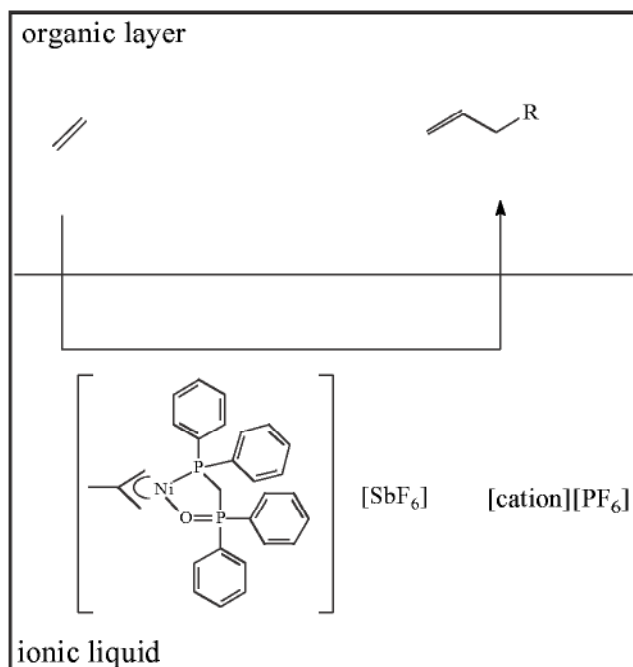

**Scheme 5.2-22:** Biphasic ethylene oligomerization with cationic Ni-complexes in a  $[\text{BMIM}][\text{PF}_6]$  ionic liquid.

Obviously, the ionic liquid's ability to dissolve the ionic catalyst complex, in combination with low solvent nucleophilicity, opens up the possibility for biphasic processing. Furthermore it was found that the biphasic reaction mode in this specific reaction resulted in improved catalytic activity and selectivity and in enhanced catalyst lifetime.

The higher activity of the catalyst [(mall)Ni(dppmo)][SbF<sub>6</sub>] in [BMIM][PF<sub>6</sub>] (TOF = 25,425 h<sup>-1</sup>) relative to the reaction under identical conditions in CH<sub>2</sub>Cl<sub>2</sub> (TOF = 7591 h<sup>-1</sup>) can be explained by the fast extraction of products and side products out of the catalyst layer and into the organic phase. A high concentration of internal olefins (from oligomerization and consecutive isomerization) at the catalyst is known to reduce catalytic activity, due to the formation of fairly stable Ni-olefin complexes.

The selectivity of the ethylene oligomerization reaction is clearly influenced by the biphasic reaction mode. The oligomers were found to be much shorter in the biphasic system, due to restricted ethylene availability at the catalytic center when dissolved in the ionic liquid. This behavior correlates with the ethylene solubility in the different solvents under the reaction conditions. Ethylene solubility in 10 ml CH<sub>2</sub>Cl<sub>2</sub> was determined to be 6.51 g at 25 °C/50 bar, in comparison with only 1.1 g ethylene dissolved in [BMIM][PF<sub>6</sub>] under identical conditions. Since the rate of ethylene insertion is dependent on the ethylene concentration at the catalyst, but the rate of β-H-elimination is not, it becomes understandable that a low ethylene availability at the catalytic active center would favor the formation of shorter oligomers. In good agreement with this, a shift of the oligomer distribution was observed if the ionic liquid's cation was modified with longer alkyl chains. With increasing alkyl chain length, the obtained oligomer distribution gradually became broader, following the higher ethylene solubility in these ionic liquids. However, all biphasic oligomerization experiments still showed much narrower oligomer distributions than found in the case of the monophasic reaction in CH<sub>2</sub>Cl<sub>2</sub> (under identical conditions).

As well as the oligomer distribution, the selectivity for 1-olefins is of great technical relevance. Despite the much higher catalytic activity, this selectivity was even slightly higher in [BMIM][PF<sub>6</sub>] than in CH<sub>2</sub>Cl<sub>2</sub>. The overall 1-hexene selectivity in C<sub>6</sub>-products is 88.5 % in [BMIM][PF<sub>6</sub>], against 85.0 % in CH<sub>2</sub>Cl<sub>2</sub>. Interestingly, smaller quantities of the internal hexenes (formed by subsequent isomerization of 1-olefins) are obtained in the case of biphasic oligomerization with the ionic liquid solvent. This is explained by the much lower solubility of the higher oligomerization products in the catalyst solvent [BMIM][PF<sub>6</sub>]. Since the 1-olefins formed are quickly extracted into the organic layer, consecutive isomerization of these products at the Ni-center is suppressed relative to the monophasic reaction in CH<sub>2</sub>Cl<sub>2</sub>.

It is noteworthy that the best results could be obtained only with very pure ionic liquids and by use of an optimized reactor set-up. The contents of halide ions and water in the ionic liquid were found to be crucial parameters, since both impurities poisoned the cationic catalyst. Furthermore, the catalytic results proved to be highly dependent on all modifications influencing mass transfer of ethylene into the ionic catalyst layer. A 150 ml autoclave stirred from the top with a special stirrer

**Figure 5.2-8:** A 150 ml autoclave with special stirrer design to maximize ethylene intake into an ionic liquid catalyst layer.

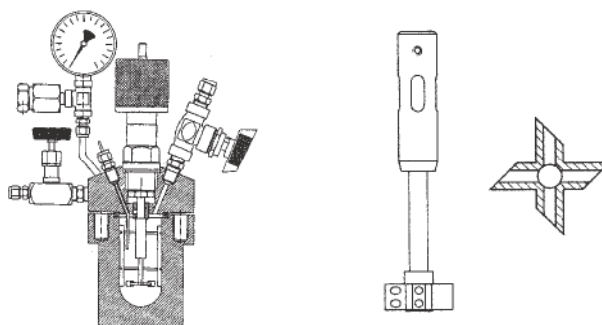

designed to maximize ethylene intake into the ionic liquid and also equipped with baffles to improve the liquid–liquid mixing (see Figure 5.2-8) gave far better results than a standard autoclave stirred with a magnetic stirrer bar.

Finally, it was possible to demonstrate that the ionic catalyst solution can, in principle, be recycled. By repetitive use of the ionic catalyst solution, an overall activity of 61,106 mol ethylene converted per mol catalyst could be achieved after two recycle runs.

An example of a biphasic, Ni-catalyzed co-dimerization in ionic liquids with weakly coordinating anions has been described by the author's group in collaboration with Leitner et al. [12]. The hydrovinylation of styrene in the biphasic ionic liquid/compressed CO<sub>2</sub> system with a chiral Ni-catalyst was investigated. Since it was found that this reaction benefits particularly from this unusual biphasic solvent system, more details about this specific application are given in Section 5.4.

Dupont and co-workers studied the Pd-catalyzed dimerization [108] and cyclodimerization [109] of butadiene in non-chloroaluminate ionic liquids. The biphasic dimerization of butadiene is an attractive research goal since the products formed, 1,3,5-octatriene and 1,3,6-octatriene, are sensitive towards undesired polymerization, so that separation by distillation is usually not possible. These octatrienes are of some commercial relevance as intermediates for the synthesis of fragrances, plasticizers, and adhesives. Through the use of PdCl<sub>2</sub> with two equivalents of the ligand PPh<sub>3</sub> dissolved in [BMIM][PF<sub>6</sub>], [BMIM][BF<sub>4</sub>], or [BMIM][CF<sub>3</sub>SO<sub>3</sub>], it was possible to obtain the octatrienes with 100 % selectivity (after 13 % conversion) (Scheme 5.2-23) [108]. The turnover frequency (TOF) was in the range of 50 butadiene converted per mol catalyst per hour, which represents a substantial increase in catalyst activity in comparison to the same reaction under otherwise identical conditions (70 °C, 3 h, butadiene/Pd = 1250) in THF (TOF = 6 h<sup>-1</sup>).

The cyclodimerization of 1,3-butadiene was carried out in [BMIM][BF<sub>4</sub>] and [BMIM][PF<sub>6</sub>] with an *in situ* iron catalyst system. The catalyst was prepared by reduction of [Fe<sub>2</sub>(NO)<sub>4</sub>Cl<sub>2</sub>] with metallic zinc in the ionic liquid. At 50 °C, the reaction proceeded in [BMIM][BF<sub>4</sub>] to give full conversion of 1,3-butadiene, and 4-vinylcyclohexene was formed with 100 % selectivity. The observed catalytic activity corresponded to a turnover frequency of at least 1440 h<sup>-1</sup> (Scheme 5.2-24).



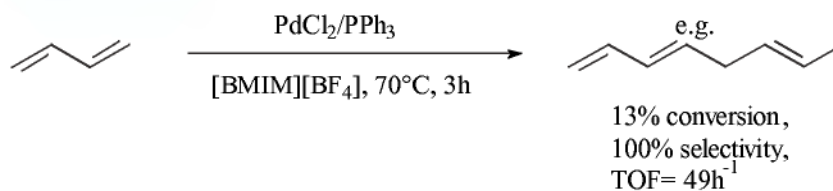

**Scheme 5.2-23:** Biphasic, Pd-catalyzed dimerization of butadiene in [BMIM][BF<sub>4</sub>].

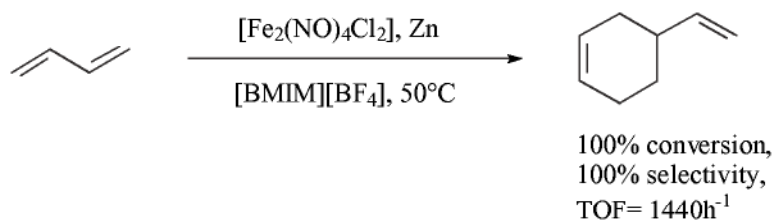

**Scheme 5.2-24:** Biphasic, Fe-catalyzed cyclotrimerization of butadiene in [BMIM][BF<sub>4</sub>].

The authors correlate the observed catalytic activity with the solubility of the 1,3-butadiene feedstock in the ionic liquid, which was found to be twice as high in the tetrafluoroborate ionic liquid as in the corresponding hexafluorophosphate system. It is noteworthy that the same reaction in a monophasic system with toluene as the solvent was found to be significantly less active (TOF = 240 h<sup>-1</sup>).

### 5.2.5

#### Concluding Remarks

Obviously, there are many good reasons to study ionic liquids as alternative solvents in transition metal-catalyzed reactions. Besides the engineering advantage of their nonvolatile natures, the investigation of new biphasic reactions with an ionic catalyst phase is of special interest. The possibility of adjusting solubility properties by different cation/anion combinations permits systematic optimization of the biphasic reaction (with regard, for example, to product selectivity). Attractive options to improve selectivity in multiphase reactions derive from the preferential solubility of only one reactant in the catalyst solvent or from the *in situ* extraction of reaction intermediates from the catalyst layer. Moreover, the application of an ionic liquid catalyst layer permits a biphasic reaction mode in many cases where this would not be possible with water or polar organic solvents (due to incompatibility with the catalyst or problems with substrate solubility, for example).

In addition to the applications reported in detail above, a number of other transition metal-catalyzed reactions in ionic liquids have been carried out with some success in recent years, illustrating the broad versatility of the methodology. Butadiene telomerization [34], olefin metathesis [110], carbonylation [111], allylic alkylation [112] and substitution [113], and Trost–Tsuji-coupling [114] are other examples of high value for synthetic chemists.



However, research into transition metal catalysis in ionic liquids should not focus only on the question of how to make some specific products more economical or ecological by use of a new solvent and, presumably, a new multiphasic process. Since it bridges the gap between homogeneous and heterogeneous catalysis, in a novel and highly attractive manner, the application of ionic liquids in transition metal catalysis gives access to some much more fundamental and conceptual questions for basic research.

In many respects, transition metal catalysis in ionic liquids is in fact better regarded as heterogeneous catalysis on a liquid support than as conventional homogeneous catalysis in an organic solvent. As in heterogeneous catalysis, support–catalyst interactions are known in ionic liquids and can give rise to catalyst activation. Product separation from an ionic catalyst layer is often easy (at least if the products are not too polar and have low boiling points), as in classical heterogeneous catalysis. However, mass transfer limitation problems (when the chemical kinetics are fast) and some uncertainty concerning the exact microenvironment around the catalytically active center represent common limitations for transition metal catalysis both in ionic liquids and in heterogeneous catalysis.

Of course, the use of a liquid catalyst immobilization phase still produces some very important differences in comparison to classical heterogeneous supports. Obviously, by use of a liquid, ionic catalyst support it is possible to integrate some classical features of traditional homogeneous catalysis into this type of “heterogeneous” catalysis. For example, a defined transition metal complex can be introduced and immobilized in an ionic liquid to provide opportunities to optimize the selectivity of a reaction by ligand variation, which is a typical approach in homogeneous catalysis. Reaction conditions in ionic liquid catalysis are still mild, as typically used in homogeneous catalysis. Analysis of the active catalyst in an ionic liquid immobilization phase is, in principle, possible by the same methods as developed for homogeneous catalysis, which should enable more rational catalyst design in the future.

In comparison with traditional biphasic catalysis using water, fluorous phases, or polar organic solvents, transition metal catalysis in ionic liquids represents a new and advanced way to combine the specific advantages of homogeneous and heterogeneous catalysis. In many applications, the use of a defined transition metal complex immobilized on a ionic liquid “support” has already shown its unique potential. Many more successful examples – mainly in fine chemical synthesis – can be expected in the future as our knowledge of ionic liquids and their interactions with transition metal complexes increases.

## References

- 1 G. W. Parshall, *J. Am. Chem. Soc.* **1972**, *94*, 8716–8719.
- 2 J. F. Knifton, *J. Mol. Catal.* **1987**, *43*, 65–78.
- 3 R. T. Carlin, R. A. Osteryoung, *J. Mol. Catal.* **1990**, *63*, 125–129.
- 4 Y. Chauvin, B. Gilbert, I. Guibard, *J. Chem. Soc. Chem. Commun.* **1990**, 1715–1716.
- 5 J. S. Wilkes, M. J. Zaworotko, *J. Chem. Soc. Chem. Commun.* **1992**, 965–967.
- 6 a) P. A. Z. Suarez, J. E. L. Dullius, S. Einloft, R. F. de Souza, J. Dupont, *Polyhedron* **1996**, *15*, 1217–1219; b) Y. Chauvin, L. Mußmann, H. Olivier, *Angew. Chem.* **1995**, *107*, 2941–2943, *Angew. Chem. Int. Ed. Engl.* **1995**, *34*, 1149–1155.
- 7 J. Fuller, R. T. Carlin, H. C. de Long, D. Haworth, *J. Chem. Soc. Chem. Commun.* **1994**, 299–300.
- 8 P. Wasserscheid, C. M. Gordon, C. Hilgers, M. J. Maldoon, I. R. Dunkin, *Chem. Commun.* **2001**, 1186–1187.
- 9 A list of current commercial suppliers of tetrafluoroborate and hexafluorophosphate salts includes (with no guarantee of completeness): Solvent Innovation GmbH, Köln ([www.solvent-innovation.com](http://www.solvent-innovation.com)), SACHEM Inc. ([www.sacheminc.com](http://www.sacheminc.com)), Fluka ([www.fluka.com](http://www.fluka.com)), Acros Organics ([www.acros.bc](http://www.acros.bc)), and Wako ([www.wako-chem.co.jp](http://www.wako-chem.co.jp)).
- 10 A. Bösmann, P. Wasserscheid, unpublished results.
- 11 P. Bonhôte, A.-P. Dias, N. Papageorgiou, K. Kalyanasundaram, M. Grätzel, *Inorg. Chem.* **1996**, *35*, 1168–1178.
- 12 A. Bösmann, G. Francio, E. Janssen, M. Solinas, W. Leitner, P. Wasserscheid, *Angew. Chem. Int. Ed. Engl.* **2001**, *40*, 2697–2699.
- 13 N. Karodia, S. Guise, C. Newlands, J.-A. Andersen, *Chem. Commun.* **1998**, 2341–2342.
- 14 P. Wasserscheid, R. van Hal, A. Bösmann, *Green Chem.* **2002**, *4*, 400–404.
- 15 H. Olivier-Bourbigou, L. Magna, *J. Mol. Catal. A: Chemical* **2002**, *2484*, 1–19.
- 16 R. Sheldon, *Chem. Commun.* **2001**, 2399–2407.
- 17 C. M. Gordon, *Applied Catalysis A: General* **2001**, *222*, 101–117.
- 18 P. Wasserscheid, W. Keim, *Angew. Chem., Int. Ed.* **2000**, *39*, 3772–3789.
- 19 T. Welton, *Chem. Rev.* **1999**, *99*, 2071–2083.
- 20 J. D. Holbrey, K. R. Seddon, *Clean Products and Processes* **1999**, *1*, 223–226.
- 21 W. Keim, D. Vogt, H. Waffenschmidt, P. Wasserscheid, *J. Catal.* **1999**, *186*, 481–486.
- 22 B. Driessen-Hölscher, P. Wasserscheid, W. Keim, *CATTECH*, **1998**, June, 47–52.
- 23 a) T. Prinz, W. Keim, B. Driessen-Hölscher, *Angew. Chem., Int. Ed. Engl.* **1996**, *35*, 1708–1710; b) C. Dobler, G. Mehlretter, M. Beller, *Angew. Chem., Int. Ed.* **1999**, *38*, 3026–3028.
- 24 a) R. B. A. Pardy, I. Tkatschenko, *J. Chem. Soc., Chem. Commun.* **1981**, 49–50; b) J. R. Ascenso, M. A. A. F. De, C. T. Carrando, A. R. Dias, P. T. Gomes, M. F. M. Piadade, C. C. Romao, A. Revillon, I. Tkatschenko, *Polyhedron* **1989**, *8*, 2449–2457; c) P. Grenouillet, D. Neibecker, I. Tkatschenko, *J. Organomet. Chem.* **1983**, *243*, 213–22; d) J.-P. Gehrke, R. Taube, E. Balbolov, K. Kurtev, *J. Organomet. Chem.* **1986**, *304*, C4–C6.
- 25 P. Wasserscheid, C. M. Gordon, C. Hilgers, M. J. Maldoon, I. R. Dunkin, *Chem. Commun.* **2001**, 1186–1187.
- 26 R. T. Carlin, R. A. Osteryoung, *J. Mol. Catal.* **1990**, *63*, 125–129.
- 27 Y. Chauvin, S. Einloft, H. Olivier, *Ind. Eng. Chem. Res.* **1995**, *34*, 1149–1155.
- 28 H. Waffenschmidt, P. Wasserscheid, *J. Mol. Catal.*, **2001**, *164*, 61–67.
- 29 a) A. J. Arduengo, R. L. Harlow, M. Kline, *J. Am. Chem. Soc.* **1991**, *113*, 361–363; b) A. J. Arduengo, H. V. R. Dias, R. L. Harlow, *J. Am. Chem. Soc.* **1992**, *114*, 5530–5534 c) G. T. Cheek,

- J. A. Spencer, *9th Int. Symp. on Molten salts*, (C.L. Hussey, D.S. Newman, G. Mamantov, Y. Ito eds.), The Electrochem. Soc., Inc., New York, 1994, 426–432; d) W. A. Herrmann, M. Ellison, J. Fischer, C. Koecher, G. R. J. Artus, *Angew. Chem., Int. Ed. Engl.* 1995, 34, 2371–2374; e) D. Bourissou, O. Guerret, F. P. Gabbaï, G. Bertrand, *Chem. Rev.* 2000, 100, 39–91.
- 30 L. Xu, W. Chen, J. Xiao, *Organometallics* 2000, 19, 1123–1127.
- 31 C. J. Mathews, P. J. Smith; T. Welton, A. J. P. White, *Organometallics*, 2001, 20(18), 3848–3850.
- 32 D. S. McGuinness, K. J. Cavell, B. F. Yates, *Chem. Commun.* 2001, 355–356.
- 33 M. Hasan, I. V. Kozhevnikov, M. R. H. Siddiqui, C. Fermon, A. Steiner, N. Winterton, *Inorg. Chem.* 2001, 40(4), 795–800.
- 34 J. E. L. Dullius, P. A. Z. Suarez, S. Einloft, R. F. de Souza, J. Dupont, J. Fischer, A. D. Cian, *Organometallics* 1998, 17, 815–819.
- 35 J. A. Boon, J. A. Levisky, J. L. Pflug, J. S. Wilkes, *J. Org. Chem.* 1986, 480–486.
- 36 a) M. J. Earle, K. R. Seddon, C. J. Adams, G. Roberts, *Chem. Commun.* 1998, 2097–2098; b) A. Stark, B. L. MacLean, R. D. Singer, *J. Chem. Soc., Dalton. Trans.* 1999, 63–66.
- 37 P. N. Davey, C. P. Newman, K. R. Seddon, M. J. Earle, WO 9919288 (to Quest International B.V., Neth.), 1999 [Chem Abstr. 1999, 130, 281871].
- 38 R. J. C. Brown, P. J. Dyson, D. J. Ellis, T. Welton, *Chem. Commun.* 2001, 1862–1863.
- 39 C. Hardacre, S. E. J. McMath, J. D. Hollbrey, *Chem. Comm.* 2001, 367–368.
- 40 P. Wasserscheid, *Ph.D. thesis*, RWTH Aachen, Aachen, 1998.
- 41 a) T. B. Scheffler, C. L. Hussey, K. R. Seddon, C. M. Kear, P. D. Armitage, *Inorg. Chem.* 1983, 22, 2099–2100; b) T. M. Laher, C. L. Hussey, *Inorg. Chem.* 1983, 22, 3247–3251; c) T. B. Scheffler, C. L. Hussey, *Inorg. Chem.* 1984, 23, 1926–1932; d) P. B. Hitchcock, T. J. Mohammed, K. R. Seddon, J. A. Zora, C. L. Hussey, E. H. Ward, *Inorg. Chim. Acta* 1986, 113, L25–L26.
- 42 a) D. Appleby, C. L. Hussey, K. R. Seddon, J. E. Turp, *Nature* 1986, 323, 614–616; b) A. J. Dent, K. R. Seddon, T. Welton, *J. Chem. Soc. Chem. Commun.* 1990, 315–316.
- 43 P. A. Chaloner, M. A. Esteruelas, F. Joó, L. A. Oro, Homogeneous Hydrogenation, Kluwer Academic Publisher, Dordrecht, 1994.
- 44 M. Medved, P. Wasserscheid, T. Melin, *Chem.-Ing.-Technik* 2001, 73, 715.
- 45 P. A. Z. Suarez, J. E. L. Dullius, S. Einloft, R. F. de Souza, J. Dupont, *Polyhedron* 1996, 15, 1217–1219.
- 46 Y. Chauvin, L. Mußmann, H. Olivier, *Angew. Chem.* 1995, 107, 2941–2943.
- 47 P. A. Z. Suarez, J. E. L. Dullius, S. Einloft, R. F. de Souza, J. Dupont, *Inorg. Chim. Acta* 1997, 255, 207–209.
- 48 P. A. Z. Suarez, J. E. L. Dullius, S. Einloft, R. F. de Souza, J. Dupont, *Polyhedron* 1996, 15, 1217–1219.
- 49 P. J. Dyson, D. J. Ellis, D. G. Parker, T. Welton, *Chem. Commun.* 1999, 25–26.
- 50 L. A. Müller, J. Dupont, R. F. de Souza, *Macromol. Rapid. Commun.* 1998, 19, 409–411.
- 51 a) B. Driessen-Hölscher, J. Heinen, *J. Organomet. Chem.* 1998, 570, 141–146; b) J. Heinen, M. S. Tupayachi, B. Driessen-Hölscher, *Catalysis Today* 1999, 48, 273–278.
- 52 S. Steines, B. Driessen-Hölscher, P. Wasserscheid, *J. Prakt. Chem.* 2000, 342, 348–354.
- 53 J. Dupont, P. A. Z. Suarez, A. P. Umpierre, R. F. De Souza, *J. Braz. Chem. Soc.* 2000, 11(3), 293–297.
- 54 A. L. Monteiro, F. K. Zinn, R. F. de Souza, J. Dupont, *Tetrahedron Asym.* 1997, 2, 177–179.
- 55 A. Berger, R. F. De Souza, M. R. Delgado, J. Dupont, *Tetrahedron: Asymmetry* 2001, 12(13), 1825–1828.
- 56 F. Liu, M. B. Abrams, R. T. Baker, W. Tumas, *Chem. Commun.* 2001, 433–434.
- 57 R. A. Brown, P. Pollet, E. McKoon, C. A. Eckert, C. L. Liotta, P. G. Jessop, *J. Am Chem. Soc.* 2001, 123, 1254–1255.
- 58 P. J. Dyson, D. J. Ellis, T. Welton, *Can. J. Chem.* 2001, 79(5/6), 705–708.

- 59 J. Howarth, *Tetrahedron Lett.* **2000**, 41(34), 6627–6629.
- 60 S. V. Ley, C. Ramarao, M. D. Smith, *Chem. Commun.* **2001**, 2278–2279.
- 61 G. S. Owens, M. M. Abu-Omar, *Chem. Commun.* **2000**, 1165–1166.
- 62 C. E. Song, E. J. Roh, *Chem. Commun.* **2000**, 837–838.
- 63 L. Gaillon, F. Bedioui, *Chem. Commun.* **2001**, 1458–1459.
- 64 R. D. Singer, P. J. Scammells, *Tetrahedron Lett.* **2001**, 42(39), 6831–6833.
- 65 a) E. G. Kuntz, E. Kuntz, DE 2627354 (to Rhone-Poulenc S. A., Fr.), **1976**, [Chem. Abstr. **1977**, 87, 101944]; b) E. G. Kuntz, *CHEMTECH* **1987**, 17, 570–575; c) B. Cornils, W. A. Herrmann, "Aqueous-Phase Organometallic Catalysis", Wiley-VCH, Weinheim, **1998**.
- 66 P. Wasserscheid, H. Waffenschmidt, *J. Mol. Catal. A: Chem.* **2000**, 164(1–2), 61–67.
- 67 Y. Chauvin, H. Olivier, L. Mußmann, Y. Chauvin, EP 776880 (to Institut Français du Pétrole, Fr.), **1997** [Chem. Abstr. **1997**, 127, 65507].
- 68 C. C. Brasse, U. Englert, A. Salzer, H. Waffenschmidt, P. Wasserscheid, *Organometallics* **2000**, 19(19), 3818–3823.
- 69 J. D. Unruh, R. Christenson, *J. Mol. Catal.* **1982**, 14, 19–34.
- 70 C. P. Casey, E. L. Paulsen, E. W. Beutenmueller, B. R. Proft, L. M. Petrovich, B. A. Matter, D. R. Powell, *J. Am. Chem. Soc.* **1997**, 119, 11817–11825.
- 71 W. R. Moser, C. J. Papile, D. A. Brannon, R. A. Duwell, *J. Mol. Catal.* **1987**, 41, 271–292.
- 72 A. Heßler, O. Stelzer, H. Dibowski, K. Worm, F. P. Schmidtchen, *J. Org. Chem.* **1997**, 62, 2362–2369.
- 73 P. Machnitzki, M. Teppner, K. Wenz, O. Stelzer, E. J. Herdtweck, *Organomet. Chem.* **2000**, 602, 158–169.
- 74 H. Dibowski, F. P. Schmidtchen, *Angew. Chem., Int. Ed.* **1998**, 37, 476–478.
- 75 O. Stelzer, F. P. Schmidtchen, A. Heßler, M. Tepper, H. Dibowski, H. Bahrman, M. Riedel, DE 19701245 (to Celanese G.m.b.H., Germany), **1998** [Chem. Abstr. **1998**, 129, 149094].
- 76 P. Wasserscheid, H. Waffenschmidt, P. Machnitzki, K. Kottsieper, O. Stelzer, *Chem. Commun.* **2001**, 451–452.
- 77 C. P. Casey, G. T. Whiteker, M. G. Melville, L. M. Petrovich, L. J. A. Gavey, D. R. J. Powell, *J. Am. Chem. Soc.* **1992**, 114, 5535–5543.
- 78 M. Kranenburg, Y. E. M. van der Burgt, P. C. J. Kamer, P. W. N. M. van Leeuwen, K. Goubitz, J. Fraanje, *Organometallics* **1995**, 14, 3081–3089.
- 79 P. W. N. M. van Leeuwen, P. C. J. Kamer, J. N. H. Reek, P. Dierkes, *Chem. Rev.* **2000**, 100, 2741–2770.
- 80 P. Dierkes, S. Ramdeehul, L. Barloy, A. De Cian, J. Fischer, P. C. J. Kamer, P. W. N. M. van Leeuwen, *Angew. Chem., Int. Ed.* **1998**, 37, 3116–3118.
- 81 F. Favre, H. Olivier-Bourbigou, D. Commereuc, L. Saussine, *Chem. Commun.* **2001**, 1360–1361.
- 82 J. Sirieix, M. Ossberger, B. Betzemeier, P. Knochel, *Synletters* **2000**, 1613–1615.
- 83 a) K. W. Kottsieper, O. Stelzer, P. Wasserscheid, *J. Mol. Catal. A: Chem.* **2001**, 175(1–2), 285–288; b) D. J. Brauer, K. W. Kottsieper, C. Lick, O. Stelzer, H. Waffenschmidt, P. Wasserscheid, *J. Organomet. Chem.* **2001**, 630(2), 177–184.
- 84 M. F. Sellin, P. B. Webb, D. J. Cole-Hamilton, *Chem. Commun.* **2001**, 781–782.
- 85 D. E. Kaufmann, M. Nouroozian, H. Henze, *Synlett* **1996**, 1091–1092.
- 86 a) W. A. Herrmann, V. P. W. Böhm, *J. Organomet. Chem.* **1999**, 572, 141–145; b) V. P. W. Böhm, W. A. Hermann, *Chem. Eur. J.* **2000**, 6, 1017–1025.
- 87 S. Bouquillon, B. Ganchev, B. Estrine, F. Henin, J. Muzart, *J. Organomet. Chem.* **2001**, 634, 153–156.
- 88 a) V. Calò, A. Nacci, L. Lopez, A. Napola, *Tetrahedron Lett.* **2001**, 42, 4701–4703; b) V. Calò, A. Nacci, A. Monopoli, L. Lopez, A. di Cosmo, *Tetrahedron*, **2001**, 57, 6071–6077.
- 89 J. Silberg, T. Schareina, R. Kempe, K. Wurst, M. R. Buchmeiser, *J. Organomet. Chem.* **2001**, 622, 6–18.

- 90 L. Xu, W. Chen, J. Ross, J. Xiao, *Org. Lett.* **2001**, *3*(2), 295–297.
- 91 A. J. Carmichael, M. J. Earle, J. D. Hollbrey, P. B. McCormac, K. R. Seddon, *Org. Lett.* **1999**, *1*, 997–1000.
- 92 R. R. Deshmukh, R. Rajagopal, K. V. Srinivasan, *Chem. Comm.* **2001**, 1544–1545.
- 93 H. Hagiwara, Y. Shimizu, T. Hoshi, T. Suzuki, M. Ando, K. Ohkubo, C. Yokoyama, *Tetrahedron Lett.* **2001**, *42*(26), 4349–4351.
- 94 C. J. Mathews, P. J. Smith, T. Welton, *Chem. Comm.* **2000**, 1249–1250.
- 95 S. T. Handy, X. Zhang, *Org. Lett.* **2001**, *3*(2), 233–236.
- 96 G. Wilke, B. Bogdanovic, P. Hardt, P. Heimbach, W. Keim, M. Kröner, W. Oberkirch, K. Tanaka, E. Steinrück, D. Walter, H. Zimmermann, *Angew. Chem.* **1966**, *5*, 151–154.
- 97 a) Y. Chauvin, B. Gilbert, I. Guibard, *J. Chem. Soc. Chem. Commun.* **1990**, 1715–1716; b) Y. Chauvin, S. Einloft, H. Olivier, *Ind. Eng. Chem. Res.* **1995**, *34*, 1149–1155; c) Y. Chauvin, S. Einloft, H. Olivier, FR 93/11,381 (to Institut Français du Pétrole, Fr.), **1996** [Chem. Abstr. **1995**, 123, 144896c].
- 98 a) M. Freemantle, *Chem. Eng. News* **1998**, *76*(13), 32–37; b) E. Burridge, *ECN Chemscope* **1999**, *May*, 27–28; c) H. Olivier, *J. Mol. Catal. A: Chem.* **1999**, *146*(1–2), 285–289.
- 99 S. Einloft, F. K. Dietrich, R. F. de Souza, J. Dupont, *Polyhedron* **1996**, *19*, 3257–3259.
- 100 H. Olivier, P. Laurent-Gérot, *J. Mol. Catal. A: Chem.* **1999**, *148*, 43–48.
- 101 J. T. Dixon, J. J. C. Grove, A. Ranwell, WO 0138270 (to Sasol Technology (Pty) Ltd, S. Afr.), **2001** [Chem. Abstr. **2001**, *135*, 7150].
- 102 a) Y. Chauvin, H. Olivier, C. N. Wyrvalski, L. C. Simon, R. F. de Souza, *J. Catal.* **1997**, *165*, 275–278; b) L. C. Simon, J. Dupont, R. F. de Souza, *J. Mol. Catal.* **1998**, *175*, 215–220.
- 103 W. Keim, B. Hoffmann, R. Lodewick, M. Peukert, G. Schmitt, J. Fleischhauer, U. Meier, *J. Mol. Catal.* **1979**, *6*, 79–97.
- 104 a) B. Ellis, W. Keim, P. Wasserscheid, *Chem. Commun.* **1999**, 337–338; b) P. Wasserscheid, W. Keim, WO 9847616 (to BP Chemicals), **1997** [Chem. Abstr. **1998**, *129*, 332457].
- 105 a) M. Eichmann, *dissertation*, RWTH-Aachen, **1999**; b) P. Wasserscheid, M. Eichmann, *Catal. Today* **2001**, *66*(2–4), 309–316.
- 106 a) I. Brassat, *Ph.D. thesis*, RWTH Aachen, **1998**; b) I. Brassat, W. Keim, S. Killat, M. Möthraath, P. Mastroilli, C. Nobile, G. J. Suranna, *Mol. Catal. A: Chem.* **2000**, *43*, 41–58; I. Brassat, U. Englert, W. Keim, D. P. Keitel, S. Killat, G. P. Suranna, R. Wang, *Inorg. Chim. Acta* **1998**, *280*, 150–162.
- 107 P. Wasserscheid, C. Hilgers, submitted for publication.
- 108 S. M. Silva, P. A. Z. Suarez, R. F. de Souza, J. Dupont, *Polymer Bull.* **1998**, *41*, 401–405.
- 109 R. A. Ligabue, R. F. de Souza, J. Dupont, *J. Mol. Catal. A: Chem.* **2001**, *169*, 11–17.
- 110 a) C. Gurtler, M. Jautclat, EP 1035093 (to Bayer A.G., Germany), **2000** [Chem. Abstr. **2000**, *133*, 237853]; b) R. C. Buijsman, E. van Vuuren, J. G. Sterrenburg, *Org. Lett.* **2001**, *3*(23), 3785–3787; c) D. Semeril, H. Olivier-Bourbigou, C. Bruncau, P. H. Dixneuf, *Chem. Comm.* **2002**, 146–147.
- 111 E. Mizushima, T. Hayashi, M. Tanaka, *Green Chem.* **2001**, *2*, 76–79.
- 112 J. Ross, W. Chen, L. Xu, J. Xiao, *Organometallics* **2001**, *20*, 138–142.
- 113 S. Toma, B. Gotov, I. Kimentova, E. Solcaniova, *Green Chem.* **2000**, *2*, 149–151.
- 114 a) W. Chen, L. Xu, C. Chatterton, J. Xiao, *Chem. Commun.*, **1999**, 1247–1248; b) C. de Bellefon, E. Pollet, P. Grenouillet, *J. Mol. Catal.* **1999**, *145*, 121–126.



## 5.3

**Ionic Liquids in Multiphasic Reactions***Hélène Olivier-Bourbigou and Alain Forestière*

## 5.3.1

**Multiphasic Reactions: General Features, Scope, and Limitations**

While the solubility of organometallic complexes in common organic solvents appears to be an advantage in terms of site availability and tunability, reaction selectivity, and activity, it is a major drawback in terms of catalyst separation and recycling. The quest for new catalyst immobilization or recovery strategies to facilitate reuse is unceasing. Immobilization of the catalyst on a solid support has been widely studied. Except for Ziegler–Natta- and metallocene-type polymerization processes, in which the catalyst is not recycled due to its high activity, this technology has not yet been developed industrially, mainly because of problems of catalyst leaching and deactivation. One successful approach to close the advantage/disadvantage gap between homogeneous and heterogeneous catalysis is multiphasic catalysis [1]. In its simplest version, there are only two liquid phases (“biphasic” catalysis or “two-phase” catalysis). The catalyst is dissolved in one phase (generally a polar phase), while the products and the substrates are found in the other. The catalyst can be separated by decantation and recycled under mild conditions.

It is important to make the distinction between the multiphasic catalysis concept and transfer-assisted organometallic reactions or phase-transfer catalysis (PTC). In this latter approach, a catalytic amount of quaternary ammonium salt  $[Q]^+[X]^-$  is present in an aqueous phase. The catalyst’s lipophilic cation  $[Q]^+$  transports the reactant’s anion  $[Y]^-$  to the organic phase, as an ion-pair, and the chemical reaction occurs in the organic phase of the two-phase organic/aqueous mixture [2].

The use of multiphasic catalysis has proven its potential in important industrial processes. In 1977, the first large-scale commercial catalytic process to benefit from two-phase liquid/liquid technology was the Shell Higher Olefin Process (SHOP) for oligomerization of ethene into  $\alpha$ -olefins, catalyzed by nickel complexes dissolved in diols such as 1,4-butanediol. Subsequently, the advancement in two-phase homogeneous catalysis has been demonstrated by the introduction of biphasic aqueous hydroformylation as an economically competitive large-scale process. The first commercial oxo plant, developed by Ruhrchemie–Rhône–Poulenc for the production of butyraldehyde from propene, came on stream in 1984. This is an example of a gas-liquid-liquid multiphasic system in which the homogeneous rhodium-based catalyst is immobilized in a water phase thanks to its coordination to the hydrophilic trisulfonated triphenylphosphine ligand (TPPTS) [3]. The catalyst separation is more effective and simpler than in classical rhodium processes, but separation of by-products from the catalyst is also an important issue.

Since then, water has emerged as a useful solvent for organometallic catalysis. In addition to the hydroformylation reactions, several other industrial processes



employing homogeneous catalysis have been converted to aqueous-phase procedures [4].

### 5.3.2

#### **Multiphase Catalysis: Limitations and Challenges**

Multiphase (biphasic) catalysis relies on the transfer of organic substrates into the catalyst phase or on catalysis at the phase boundary. Most organic substrates do not have sufficient solubility in the catalyst phase (particularly in water) to give practical reaction rates in catalytic applications. Therefore, although the use of aqueous-biphasic catalysis has proven its potential in important industrial processes, the current applications of this technique remain limited: firstly to catalysts that are stable in the presence of water, and secondly to substrates that have significant water solubility. Many studies have focused on improving the affinities between the two liquid aqueous/organic phases, either through increasing the lipophilic character of the catalyst phase or even by immobilizing the catalyst on a support. For example, rapid stirring, emulsification, and sonication have all been used to increase the interfacial area. The addition of co-solvents to the aqueous phase has been investigated extensively as a means to improving the solubility of higher olefinic substrates in the catalyst-containing phase. Application of detergents or micellar processes to promote substrate transfer to the interface, or the addition of co-ligands such as  $\text{PPh}_3$  – or even of ligands with an amphiphilic character or modified cyclodextrins – also play rate-enhancing roles. The development of supported aqueous-phase catalysis (SAPC), which involves the dissolution of an aqueous-phase complex in a thin layer of water adhering to a silica surface, opens the way to the reactivity of hydrophobic substrates. Although all these techniques can change the solubility of organic substrates in the aqueous phase or favor the concentration of the active center at the interface, they can also cause the leaching of a proportion of the catalyst into the organic phase.

The major advantage of the use of two-phase catalysis is the easy separation of the catalyst and product phases. However, the co-miscibility of the product and catalyst phases can be problematic. An example is given by the biphasic aqueous hydroformylation of ethene to propanal. Firstly, the propanal formed contains water, which has to be removed by distillation. This is difficult, due to formation of azeotropic mixtures. Secondly, a significant proportion of the rhodium catalyst is extracted from the reactor with the products, which prevents its efficient recovery. Nevertheless, the reaction of ethene itself in the water-based Rh-TPPTS system is fast. It is the high solubility of water in the propanal that prevents the application of the aqueous biphasic process [5].

To overcome these limitations, there has been a great deal of investigation of novel methods, one of them focused on the search for alternative solvents [6, 7]. Table 5.3-1 gives different approaches to biphasic catalysis, with some of their respective advantages and limitations.

Although already well known, perfluorinated solvents have only quite recently proved their utility in many organic and catalyzed reactions. The main advantage of

**Table 5.3-1:** Advantages and limitations of different approaches for multiphasic “homogeneous” catalysis.

<i>Catalyst phase</i>	<i>Product phase</i>	<i>Advantages</i>	<i>Limitations</i>
Water (+co-solvent)	Organic liquid	<ul style="list-style-type: none"> <li>■ Easy product separation and catalyst recycling</li> <li>■ Lower cost of chemical processes</li> <li>■ Lack of toxicity of water</li> </ul>	<ul style="list-style-type: none"> <li>■ Low reaction rate for poorly water-miscible substrate</li> <li>■ Mass transfer limits rate of reaction</li> <li>■ Treatment of spent water</li> </ul>
Polar solvent	Organic liquid	<ul style="list-style-type: none"> <li>■ Solvent effect</li> </ul>	<ul style="list-style-type: none"> <li>■ Use of volatile organic solvent</li> <li>■ Co-miscibility of the two phases</li> </ul>
Fluorinated organic solvent	Organic liquid	<ul style="list-style-type: none"> <li>■ Temperature dependency of the miscibility of fluorinated phase with organic solvents</li> </ul>	<ul style="list-style-type: none"> <li>■ Solvent and ligand costs</li> <li>■ Product contamination</li> </ul>
Water	Supercritical fluids (e.g. CO <sub>2</sub> )	<ul style="list-style-type: none"> <li>■ Organic co-solvent not needed</li> <li>■ High miscibility of CO<sub>2</sub> with gas</li> </ul>	<ul style="list-style-type: none"> <li>■ Poor solvating ability of supercritical fluids</li> <li>■ High investment and operating costs</li> </ul>
Ionic liquid	Organic liquid	<ul style="list-style-type: none"> <li>■ Tunability of the solubility characteristics of the ionic liquids</li> <li>■ Solvent effect</li> </ul>	<ul style="list-style-type: none"> <li>■ Ionic liquid costs</li> <li>■ Disposal of spent ionic liquids</li> </ul>
Ionic liquid	Supercritical fluids (e.g. CO <sub>2</sub> )	<ul style="list-style-type: none"> <li>■ Organic co-solvent not needed</li> <li>■ Tunability of the solubility characteristics of the ionic liquids</li> <li>■ Presence of CO<sub>2</sub> reduces ionic liquid’s viscosity</li> </ul>	<ul style="list-style-type: none"> <li>■ Ionic liquid costs</li> <li>■ High pressure apparatus needed</li> </ul>

these solvents is that their miscibility with organic products can be tuned by variation of the temperature. Fluorous-phase catalysis makes possible the association of homogeneous phase catalysis (thus avoiding problems of mass-transfer limitations) and a biphasic separation of the catalyst and reaction mixture [8]. However, these solvents are still relatively expensive and require costly, specially designed ligands to keep the catalyst in the fluoruous phase during the separation. In addition, a significant amount of perfluorinated solvent can remain dissolved in the organic phase, and contamination of the products can occur. To date, there are no industrial developments of this technology, due to lack of competitiveness.

Supercritical carbon dioxide ( $scCO_2$ ) has also emerged as a highly promising reaction medium. In combination with homogeneous catalysis, its benefits could be the potential increase of reaction rates (absence of gas–liquid phase boundary, high diffusion rates) and selectivities, and also its lack of toxicity [9]. In combination with water, it has been used in a biphasic system to perform the hydrogenation of cinnamaldehyde. Gas-liquid-liquid mass transfer limitations were ruled out, due to the very high solubility of reactant gas in  $scCO_2$  [10]. Although elegant, this approach still appears relatively expensive, especially for the bulk chemical industry. Furthermore, the low solubility of interesting substrates might hamper the commercialization of  $scCO_2$  in the fine chemical industry. A very recent and highly interesting development is the combination of an ionic liquid catalyst phase and a product phase containing  $scCO_2$ . This approach is presented in more detail in Section 5.4.

Further progress in multiphase catalysis will rely on the development of alternative techniques that allow the reactivity of a broader range of substrates, the efficient separation of the products, and recovery of the catalyst, while remaining economically viable.

### 5.3.3

#### Why Ionic Liquids in Multiphase Catalysis?

Notwithstanding their very low vapor pressure, their good thermal stability (for thermal decomposition temperatures of several ionic liquids, see [11, 12]) and their wide operating range, the key property of ionic liquids is the potential to tune their physical and chemical properties by variation of the nature of the anions and cations. An illustration of their versatility is given by their exceptional solubility characteristics, which make them good candidates for multiphase reactions (see Section 5.3.4). Their miscibility with water, for example, depends not only on the hydrophobicity of the cation, but also on the nature of the anion and on the temperature.

*N,N'*-Dialkylimidazolium cations are of particular interest because they generally give low-melting salts, are more thermally stable than their tetraalkylammonium analogues, and have a wide spectrum of physicochemical properties available. For the same [BMIM]<sup>+</sup> cation, for example, the [BF<sub>4</sub>]<sup>-</sup>, [CF<sub>3</sub>SO<sub>3</sub>]<sup>-</sup>, [CF<sub>3</sub>CO<sub>2</sub>]<sup>-</sup>, [NO<sub>3</sub>]<sup>-</sup>, and halide salts all display complete miscibility with water at 25 °C. On cooling the [BMIM][BF<sub>4</sub>]/water solution to 4 °C, however, a water-rich phase separates. In a similar way, a change of the [BMIM]<sup>+</sup> cation for the longer-chain, more hydrophobic [HMIM]<sup>+</sup> (1-hexyl-3-methylimidazolium) cation affords a [BF<sub>4</sub>]<sup>-</sup> salt that shows low co-miscibility with water at room temperature. On the other hand, the [BMIM][PF<sub>6</sub>], [BMIM][SbF<sub>6</sub>], [BMIM][NTf<sub>2</sub>] (NTf<sub>2</sub> = N(CF<sub>3</sub>SO<sub>2</sub>)<sub>2</sub>), and [BMIM][BR<sub>4</sub>] ionic liquids show very low miscibility with water, but the shorter, symmetrically substituted [MMIM][PF<sub>6</sub>] salt becomes water-soluble. One might therefore expect that modification of the alkyl substituents on the imidazolium ring could produce different and very tunable ionic liquid properties.

The influence of the nature of cations and anions on the solubility characteristics of the resulting salts with organic substrates is also discussed in Section 5.3.4. It has

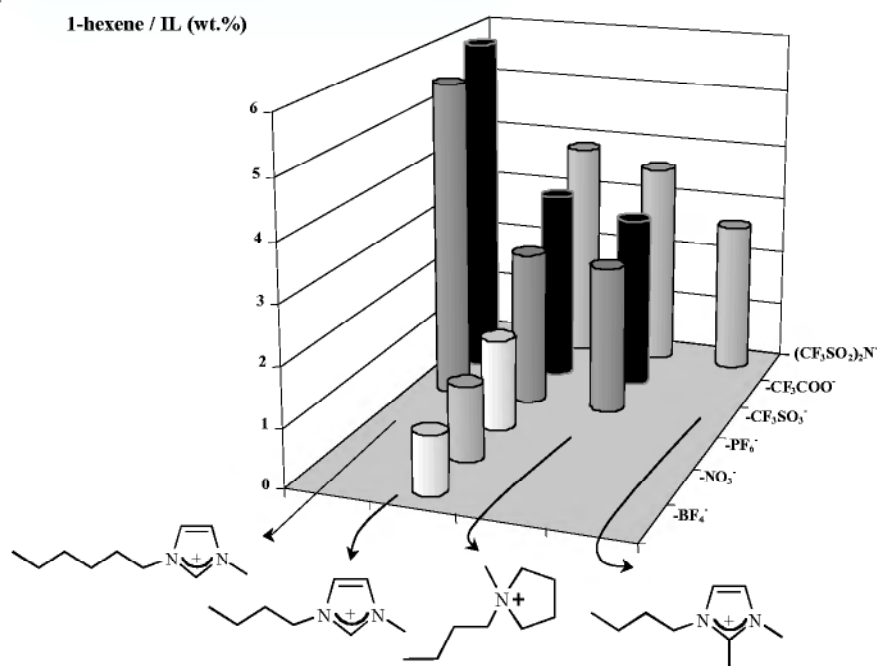

**Figure 5.3-1:** Solubility of 1-hexene in different ionic liquids as a function of the nature of anions and cations.

been shown (Figure 5.3-1) that increasing the length of the alkyl chain on the imidazolium cation can increase the solubility of 1-hexene, but so can tuning the nature of the anion.

A comparison of the solubility of  $\alpha$ -olefins with increasing numbers of carbon atoms in water and in [BMIM][BF<sub>4</sub>] (Figure 5.3-2), shows that olefins are at least 100 times more soluble in the ionic liquid than in water.

Addition of co-solvents can also change the co-miscibility characteristics of ionic liquids. As an example, the hydrophobic [BMIM][PF<sub>6</sub>] salt can be completely dissolved in an aqueous ethanol mixture containing between 0.5 and 0.9 mole fraction of ethanol, whereas the ionic liquid itself is only partially miscible with pure water or pure ethanol [13]. The mixing of different salts can also result in systems with modified properties (e.g., conductivity, melting point).

One of the key factors controlling the reaction rate in multiphase processes (for reactions taking place in the bulk catalyst phase) is the reactant solubility in the catalyst phase. Thanks to their tunable solubility characteristics, the use of ionic liquids as catalyst solvents can be a solution to the extension of aqueous two-phase catalysis to organic substrates presenting a lack of solubility in water, and also to moisture-sensitive reactants and catalysts. With the different examples presented below, we show how ionic liquids can have advantageous effects on reaction rate and on the selectivity of homogeneous catalyzed reactions.

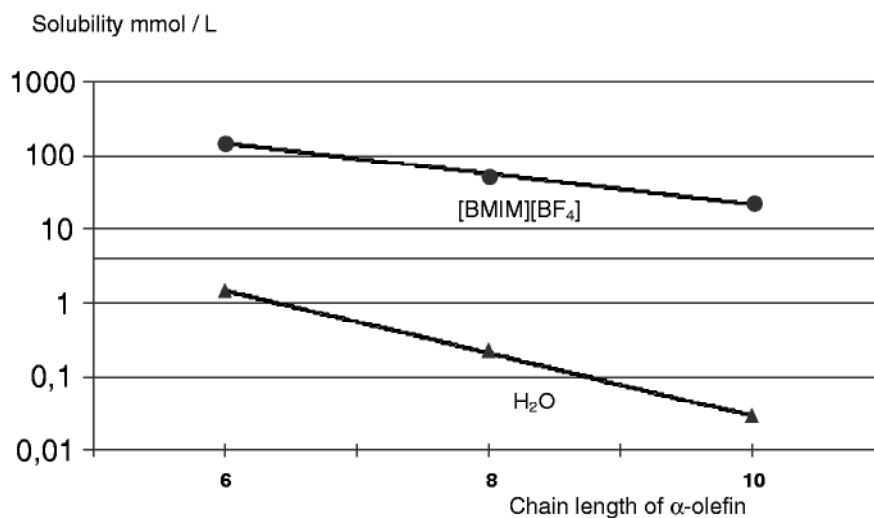

Figure 5.3-2: Comparison of the solubilities of  $\alpha$ -olefins with different numbers of carbon atoms in water and in [BMIM][BF<sub>4</sub>].

#### 5.3.4

##### Different Technical Solutions to Catalyst Separation through the Use of Ionic Liquids

In general, homogeneous catalysis suffers from complicated and expensive catalyst separation from the products. Homogeneous catalysts are very often unstable at the high temperatures necessary for the distillation of high-boiling products. Multiphase catalysis makes the separation of products under mild conditions possible. Different technologies to separate the products, and to recycle the catalytic system when using ionic liquids as one of these phases, have been proposed (Table 5.3-2).

The simplest case (Table 5.3-2, case a) is when the ionic liquid is able to dissolve the catalyst, and displays a partial solubility with the substrates and a poor solubility with the reaction products. Under these conditions, the product upper phase, also containing the unconverted reactants, is removed by simple phase decantation, and the ionic liquid containing the catalyst is recycled. This can be illustrated by transition metal-catalyzed olefin transformations into non-polar hydrocarbon products such as olefin oligomerization, hydrogenation, isomerization, metathesis, and acidic olefin alkylation with isobutane. Transition metal catalysts can also be immobilized in ionic liquids with melting points just above room temperature (Table 5.3-2, case b). The reaction occurs in a two-phase liquid–liquid system. By cooling the reaction mixture, the products can be separated by filtration from the “solid” catalyst medium, which can be recycled. The advantages of this technique have been demonstrated for the hydrogenation of 1-hexene catalyzed by ruthenium-phosphine complexes in [BMIM]Cl/ZnCl<sub>2</sub> [14] and for the hydroformylation of 1-hexene in the high-melting phosphonium tosylate ionic liquids [15].

Table 5.3-2: Different technologies for multiphasic reactions making use of ionic liquids.

<i>Lower phase (during the reaction)</i>	<i>Upper phase (during the reaction)</i>	<i>Mode of separation catalyst phase/products</i>	
Ionic liquid + catalyst	Organic liquid (products + unreacted substrates)	(a) Decantation (liquid-liquid)	48–50
		(b) Filtration of the ionic liquid on cooling	14, 15
Ionic liquid + catalyst + part of the products	Organic liquid (part of the products + unreacted substrates)	(c) Product extraction with an organic co-solvent immiscible with the ionic liquid	18
		(d) Distillation	16
or	or	(e) Separation after addition of a co-solvent miscible with the ionic liquid, immiscible with the products	
Ionic liquid + catalyst + products	No upper phase		
Ionic liquid + catalyst	Products + unreacted substrates + CO <sub>2</sub>	(f) Extraction with scCO <sub>2</sub>	19
Supported ionic liquid + catalyst	Organic liquid (products) or gas	(g) Phase separation	21

Thanks to the low vapor pressure of ionic liquids, product distillation without azeotrope formation can reasonably be anticipated if the products are not too high-boiling. One example is the hydroformylation of methyl-3-pentenoate in [BMIM][PF<sub>6</sub>] with catalysis by a homogeneous Rh-phosphite system. In the absence of ionic liquid, deactivation of the catalyst is observed. Through the use of the [BMIM][PF<sub>6</sub>] salt, the catalyst is stabilized and can be successfully reused after distillation of the products [16]. Nevertheless, this separation technique remains demanding in energy, and the eventual accumulation of high-boiling by-products in the nonvolatile ionic liquid phase can be a problem.

When the products are partially or totally miscible in the ionic phase, separation is much more complicated (Table 5.3-2, cases c–e). One advantageous option can be to perform the reaction in one single phase, thus avoiding diffusional limitation, and to separate the products in a further step by extraction. Such technology has already been demonstrated for aqueous biphasic systems. This is the case for the palladium-catalyzed telomerization of butadiene with water, developed by Kuraray, which uses a sulfolane/water mixture as the solvent [17]. The products are soluble in water, which is also the nucleophile. The high-boiling by-products are extracted with a solvent (such as hexane) that is immiscible in the polar phase. This method



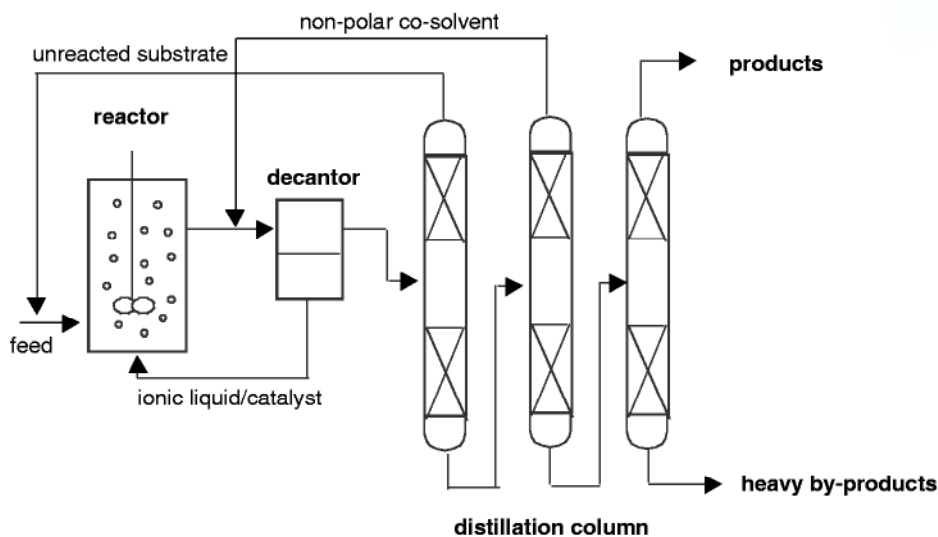

Figure 5.3-3: Example of an extraction method for product separation from ionic liquid/catalyst reaction mixtures.

has the advantage that (i) the catalyst and the products can be separated without heating them, so that thermal deactivation is avoided, and (ii) the extraction is achieved for all the compounds, so that the accumulation of catalyst poisons and high-boiling by-products is minimal. This technology can be applied when ionic liquids are used as the catalyst polar phase (Figure 5.3-3).

A co-solvent that is poorly miscible with ionic liquids but highly miscible with the products can be added in the separation step (after the reaction) to facilitate the product separation. The Pd-mediated Heck coupling of aryl halides or benzoic anhydride with alkenes, for example, can be performed in  $[\text{BMIM}][\text{PF}_6]$ , the products being extracted with cyclohexane. In this case, water can also be used as an extraction solvent, to remove the salt by-products formed in the reaction [18]. From a practical point of view, the addition of a co-solvent can result in cross-contamination, and it has to be separated from the products in a supplementary step (distillation). More interestingly, unreacted organic reactants themselves (if they have non-polar character) can be recycled to the separation step and can be used as the extractant co-solvent.

When water-miscible ionic liquids are used as solvents, and when the products are partly or totally soluble in these ionic liquids, the addition of polar solvents, such as water, in a separation step after the reaction can make the ionic liquid more hydrophilic and facilitate the separation of the products from the ionic liquid/water mixture (Table 5.3-2, case e). This concept has been developed by Union Carbide for the hydroformylation of higher alkenes catalyzed by Rh-sulfonated phosphine ligand in the N-methylpyrrolidone (NMP)/water system. Thanks to the presence of NMP, the reaction is performed in one homogeneous phase. After the reaction,

water is added in a mixer, followed by efficient phase separation in a settler. One advantage of this process is its flexibility and good performance with respect to the olefin carbon number.

The combination of ionic liquids with supercritical carbon dioxide is an attractive approach, as these solvents present complementary properties (volatility, polarity scale...). Compressed CO<sub>2</sub> dissolves quite well in ionic liquid, but ionic liquids do not dissolve in CO<sub>2</sub>. It decreases the viscosity of ionic liquids, thus facilitating mass transfer during catalysis. The separation of the products in solvent-free form can be effective and the CO<sub>2</sub> can be recycled by recompressing it back into the reactor. Continuous flow catalytic systems based on the combination of these two solvents have been reported [19]. This concept is developed in more detail in Section 5.4.

Membrane techniques have already been combined with two-phase liquid catalysis. The main function of this method is to perform fine separation of undesirable constituents from the catalytic system after phase decantation has already performed the coarse separation of the catalyst from the products. This technique can be applied to ionic liquid systems as a promising approach for the selective removal of volatile solutes from ionic liquids [20].

Ionic liquids have already been demonstrated to be effective membrane materials for gas separation when supported within a porous polymer support. However, supported ionic liquid membranes offer another versatile approach by which to perform two-phase catalysis. This technology combines some of the advantages of the ionic liquid as a catalyst solvent with the ruggedness of the ionic liquid-polymer gels. Transition metal complexes based on palladium or rhodium have been incorporated into gas-permeable polymer gels composed of [BMIM][PF<sub>6</sub>] and poly(vinylidene fluoride)-hexafluoropropylene copolymer and have been used to investigate the hydrogenation of propene [21].

### 5.3.5

#### **Immobilization of Catalysts in Ionic Liquids**

For the use of ionic liquids in catalytic or organic reactions, two main methodologies have been developed. In the first one, the ionic liquid is both the catalyst and the reaction solvent. This is the case in acid-catalyzed reactions in which Lewis acidic ionic liquids such as acidic chloroaluminates are both active catalytic species and solvents for carbenium ions. In this case, the dissolution of the inorganic Lewis acid (e.g., AlCl<sub>3</sub>) in the organic phase is not observed. The second approach, discussed in Section 5.2, is when the ionic liquid acts as a “liquid support” for the homogeneous catalyst. In this technology, the catalyst (in general a transition metal complex) is immobilized in the ionic phase and the products form the upper phase, as described in Section 5.3.4. To achieve the development of such an approach in a continuous process, the key point is to immobilize and stabilize the catalyst in the ionic liquid in the presence of an organic second phase with minimum loss of metal. Two approaches have been investigated:

- 1) the active species is known to be ionic in conventional organic solvents,
- 2) the active species is characterized as a non-charged complex.

In the first case, one may expect that the catalyst should remain ionic and be retained without modification in the ionic liquid. Different successful examples have been reported, such as olefin and diolefin hydrogenation reactions catalyzed by the cationic  $[\text{HRh}(\text{PPh}_3)_2(\text{diene})][\text{PF}_6]$  complexes [22], and aromatic hydrocarbon hydrogenation catalyzed by the  $[\text{H}_4\text{Ru}_4(\text{C}_6\text{H}_6)_4][\text{BF}_4]_2$  cluster [23]. In the presence of hydrogen, this latter complex probably forms the  $[\text{H}_6\text{Ru}_4(\text{C}_6\text{H}_6)_4][\text{BF}_4]_2$  complex, which acts as the effective arene hydrogenation catalyst. Another example is olefin dimerization catalyzed by the cationic  $[\text{HNi}(\text{olefin})][\text{A}]$  (A is a chloroaluminate anion) complexes. These species can be formed by *in situ* alkylation of a nickel(II) salt with an acidic alkylchloroaluminate ionic liquid acting both as the solvent and as the co-catalyst [24]. The cationic  $[(\text{methallyl})\text{Ni}(\text{Ph}_2\text{PCH}_2\text{PPh}_2(\text{O}))][\text{SbF}_6]$  complex proved to be stable and active for ethene oligomerization in  $[\text{PF}_6]^-$ -based ionic liquids without the addition of Lewis acid. The high electrophilicity of the Ni center, which is responsible for the activity of the catalyst, is probably not altered by the ionic solvent [25]. In the Suzuki reaction, the active species in  $[\text{BMIM}][\text{BF}_4]$  is believed to be the tricoordinated  $[\text{Pd}(\text{PPh}_3)_2(\text{Ar})][\text{X}]$  complex that forms after oxidative addition of the aryl halide to  $[\text{Pd}(\text{PPh}_3)_4]$  [26]. Thanks, therefore, to their low nucleophilicity, ionic liquids do not compete with the unsaturated organic substrate for coordination to the electrophilic active metal center. The different recycling experiments demonstrate the stability of these organometallic complexes in ionic liquids.

Not only cationic, but also anionic, species can be retained without addition of specially designed ligands. The anionic active  $[\text{HPt}(\text{SnCl}_3)_4]^{3-}$  complex has been isolated from the  $[\text{NEt}_4][\text{SnCl}_3]$  solvent after hydrogenation of ethylene [27]. The  $\text{PtCl}_2$  precursor used in this reaction is stabilized by the ionic salt (liquid at the reaction temperature) since no metal deposition occurs at 160 °C and 100 bar. The catalytic solution can be used repeatedly without apparent loss of catalytic activity.

In the second case, in which the active catalytic species is assumed to be uncharged, leaching of the transition metal in the organic phase can be limited by the use of functionalized ligands. As the triumph of aqueous biphasic catalysis follows the laborious work involved in the development of water-soluble ligands, recent investigations have focused on the synthesis of new ligands with “tailor made” structures for highly active and selective two-phase catalysts and for good solubility in the ionic liquid phase. These ligands are mainly phosphorus ligands with appropriate modifications (Scheme 5.3.1).

Polar groups such as the cationic phenylguanidinium groups 1–3 [28, 29], the imidazolium and pyridinium groups 4 and 5 [30], and the 2-imidazolyl groups 6 and 7 [31] have been reported. A cobaltocinium salt bearing phosphine donors (8) has also been described [32]. Phosphites are well known ligands in homogeneous Rh-catalyzed hydroformylation, affording enhanced reaction rates and regioselectivities. Since they are unstable towards hydrolysis, examples of their use in aqueous biphasic catalysis are rare. Ionic liquids offer suitable alternative solvents compatible with phosphites 9 [28].

To date, these functionalized ligands have been investigated on the laboratory scale, in batch operations to immobilize rhodium catalyst in hydroformylation.

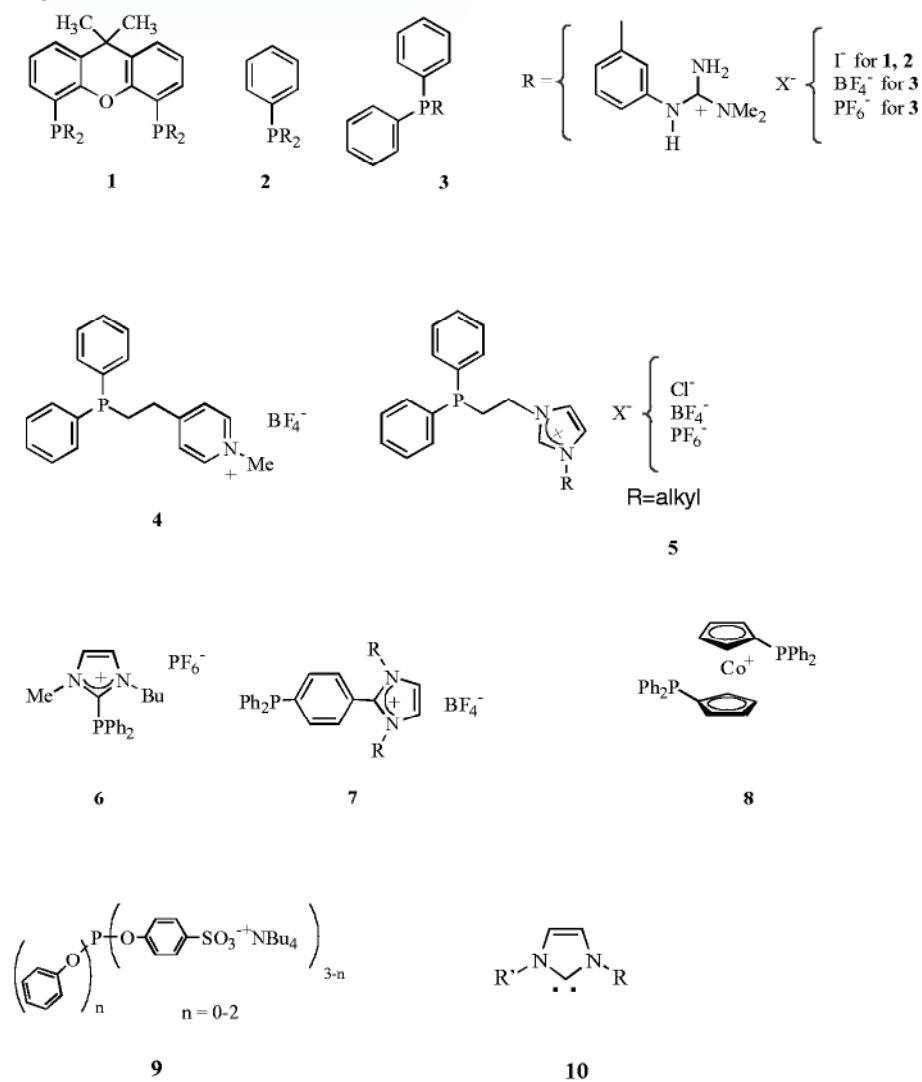

Scheme 5.3-1: Ligands 1-10.

Good rhodium retention results were obtained after several recycles. However, optimized ligand/metal ratios and leaching and decomposition rates, which can result in the formation of inactive catalyst, are not known for these ligands and require testing in continuous mode. As a reference, in the Ruhrchemie–Rhône–Poulenc process, the losses of rhodium are  $<10^{-9}$  g Rh per kg *n*-butyraldehyde.

Certain amines, when linked to TPPTS, form ionic solvents liquid at quite low temperatures. Bahrman [33] used these ionic liquids as both ligands and solvents for the Rh catalyst for the hydroformylation of alkenes. In this otherwise interesting

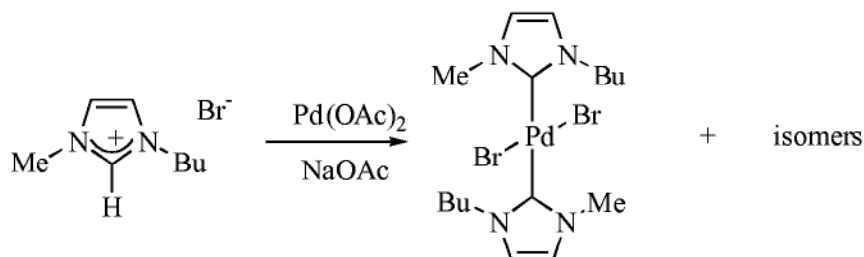

**Scheme 5.3-2:** Formation of carbene complexes by dialkylimidazolium salt deprotonation.

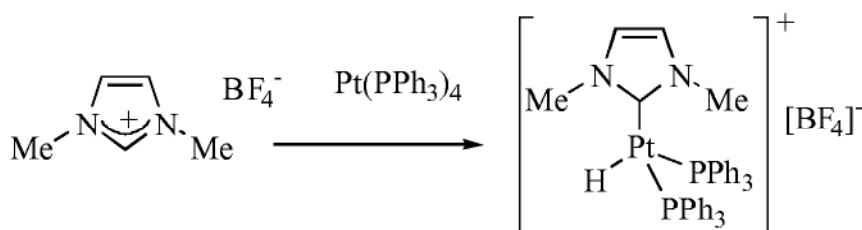

**Scheme 5.3-3:** Formation of carbene complexes by oxidative addition to Pt(0).

approach, however, the ligand/rhodium ratio, which influences the selectivity of the reaction, is difficult to control.

As well as phosphorus ligands, heterocyclic carbenes ligands **10** have proven to be interesting donor ligands for stabilization of transition metal complexes (especially palladium) in ionic liquids. The imidazolium cation is usually presumed to be a simple inert component of the solvent system. However, the proton on the carbon atom at position 2 in the imidazolium is acidic and this carbon atom can be deprotonated by, for example, basic ligands of the metal complex, to form carbenes (Scheme 5.3-2).

The ease of formation of the carbene depends on the nucleophilicity of the anion associated with the imidazolium. For example, when Pd(OAc)<sub>2</sub> is heated in the presence of [BMIM][Br], the formation of a mixture of Pd imidazolylidene complexes occurs. Palladium complexes have been shown to be active and stable catalysts for Heck and other C–C coupling reactions [34]. The highest activity and stability of palladium is observed in the ionic liquid [BMIM][Br]. Carbene complexes can be formed not only by deprotonation of the imidazolium cation but also by direct oxidative addition to metal(0) (Scheme 5.3-3). These heterocyclic carbene ligands can be functionalized with polar groups in order to increase their affinity for ionic liquids. While their donor properties can be compared to those of donor phosphines, they have the advantage over phosphines of being stable toward oxidation.

## 5.3.6

**Scaling up Ionic Liquid Technology from Laboratory to Continuous Pilot Plant Operation**

The increasing number of applications that make use of ionic liquids as solvents or catalysts for organic and catalytic reactions emphasizes their key advantages over organic solvents and their complementarity with respect to water or other “green” solvents. For scaling up to large-scale production, however, kinetic models are very often required and have to be developed for an optimum reactor design. In this type of multiphasic (biphasic) catalysis, one important parameter is the location of the reaction: does the reaction take place in the bulk of the liquid, at the interface, or simultaneously at both sites? For a reaction in the bulk of the liquid (e.g., in the ionic liquid), the liquid (and/or gaseous) reactants would first have to dissolve in the catalyst solution phase before the start of the chemical reaction. The reaction rate would therefore be determined by the concentration of the reactants in the catalyst phase. It is important to be able to identify mass transfer limitations that occur when the reaction rate is higher than the mass transfer velocity. In some cases the existence of mass transfer limitations can be used advantageously to control the exothermicity of reactions. For example, a reduction in stirring can be a means to decrease the reaction rate without having to destroy the catalyst. In single-phase homogeneous reactions, catalyst poisons (such as CO or CO<sub>2</sub>) are sometimes deliberately injected into the reactor to stop the reaction.

In the aqueous biphasic hydroformylation reaction, the site of the reaction has been much discussed (and contested) and is dependent on reaction conditions (temperature, partial pressure of gas, stirring, use of additives) and reaction partners (type of alkene) [35, 36]. It has been suggested that the positive effects of co-solvents indicate that the bulk of the aqueous liquid phase is the reaction site. By contrast, the addition of surfactants or other surface- or micelle-active compounds accelerates the reaction, which apparently indicates that the reaction occurs at the interfacial layer.

Therefore, important parameters such as phase transfer phenomena (i.e., the solubility of the reactants in the ionic liquid phase), volume ratio of the different phases, and efficiency of mixing so as to provide maximum liquid–liquid interfacial area are key factors in determining and controlling reaction rates and kinetics. Kinetic models have been developed for aqueous biphasic systems and are continuously refined to improve agreements with experimental results. These models might be transferable to biphasic catalysis with ionic liquids, but data concerning the solubilities of liquids (and gases) in these new solvents and the existence of phase equilibria in the presence of organic upper phases have still to be accumulated (see Section 3.4). Very few publications on these topics with respect to ionic liquids are available.

The influence of the concentration of hydrogen in [BMIM][PF<sub>6</sub>] and [BMIM][BF<sub>4</sub>] on the asymmetric hydrogenation of  $\alpha$ -acetamidocinnamic acid catalyzed by rhodium complexes bearing a chiral ligand has been investigated. Hydrogen was found to be four times more soluble in the [BF<sub>4</sub>]<sup>-</sup>-based salt than in the [PF<sub>6</sub>]<sup>-</sup>-based one,



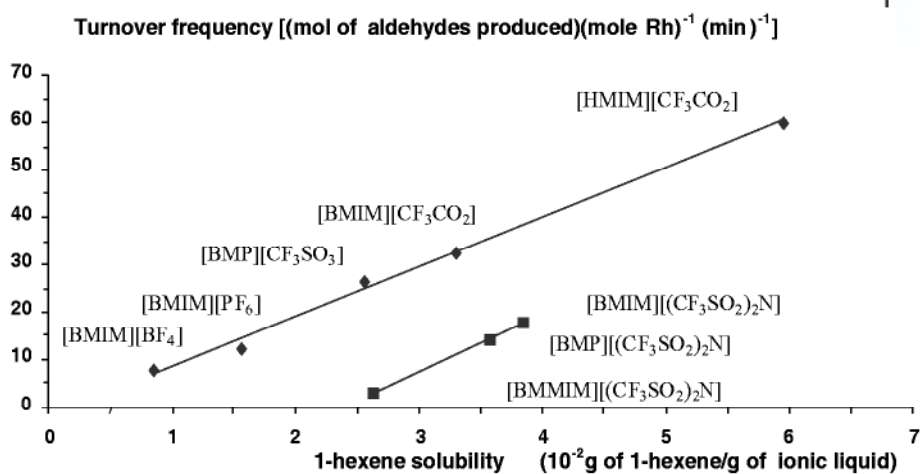

**Figure 5.3-4:** Turnover frequency of Rh-catalyzed hydroformylation as a function of 1-hexene solubility in ionic liquids. Reactions conditions: Rh(CO)<sub>2</sub>(acac) 0.075 mmol, 1-hexene/Rh = 800, TPPTS/Rh = 4, heptane as internal standard, CO/H<sub>2</sub> = 1 (molar ratio), P = 2 MPa, T = 80 °C, TOF determined at 25 % conversion of 1-hexene ([BMP] = *N,N*-butylmethylpyrrolidinium; [BMMIM] = 1-butyl-2,3-dimethylimidazolium)

at the same pressure. This difference in molecular hydrogen concentration in the ionic phase (rather than pressure in the gas phase) has been correlated with the remarkable effect on the conversion and enantioselectivity of the reaction [37].

In the rhodium-catalyzed hydroformylation of 1-hexene, it has been demonstrated that there is a correlation between the solubility of 1-hexene in ionic liquids and reaction rates (Figure 5.3-4) [28].

However, information concerning the characteristics of these systems under the conditions of a continuous process is still very limited. From a practical point of view, the concept of ionic liquid multiphase catalysis can be applicable only if the resultant catalytic lifetimes and the elution losses of catalytic components into the organic or extractant layer containing products are within commercially acceptable ranges. To illustrate these points, two examples of applications run on continuous pilot operation are described: (i) biphasic dimerization of olefins catalyzed by nickel complexes in chloroaluminates, and (ii) biphasic alkylation of aromatic hydrocarbons with olefins and light olefin alkylation with isobutane, catalyzed by acidic chloroaluminates.

#### 5.3.6.1 Dimerization of alkenes catalyzed by Ni complexes

The Institut Français du Pétrole has developed and commercialized a process, named Dimersol X, based on a homogeneous catalyst, which selectively produces dimers from butenes. The low-branching octenes produced are good starting materials for isononanol production. This process is catalyzed by a system based on a nickel(II) salt, soluble in a paraffinic hydrocarbon, activated with an alkylaluminum chloride derivative directly inside the dimerization reactor. The reaction is sec-

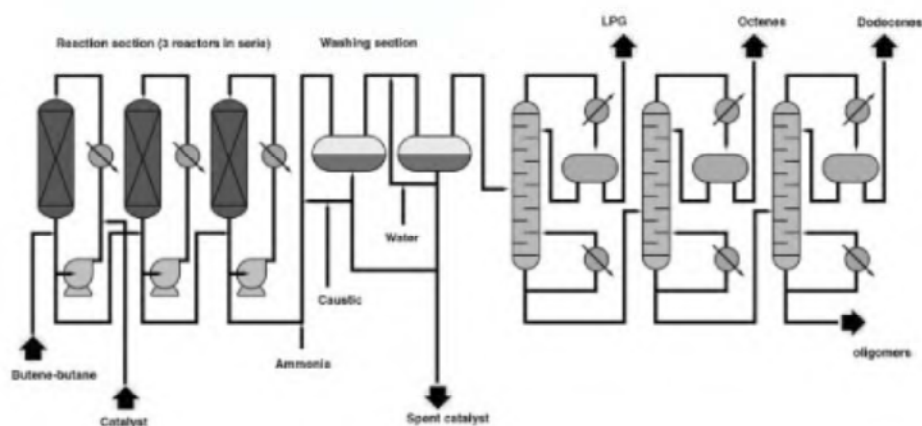

Figure 5.3-5: Dimersol process.

ond order in monomer concentration and first order in catalyst concentration. The butene conversion level is highly dependent on its initial concentration. In its present commercial form, Dimersol X can achieve 80 % conversion of butenes (for 70–75 % butene concentration in the feed) with 85 % octene selectivity. A process flow diagram is shown in Figure 5.3-5.

The reaction takes place at low temperature (40–60 °C), without any solvent, in two (or more, up to four) well-mixed reactors in series. The pressure is sufficient to maintain the reactants in the liquid phase (no gas phase). Mixing and heat removal are ensured by an external circulation loop. The two components of the catalytic system are injected separately into this reaction loop with precise flow control. The residence time could be between 5 and 10 hours. At the output of the reaction section, the effluent containing the catalyst is chemically neutralized and the catalyst residue is separated from the products by aqueous washing. The catalyst components are not recycled. Unconverted olefin and inert hydrocarbons are separated from the octenes by distillation columns. The catalytic system is sensitive to impurities that can coordinate strongly to the nickel metal center or can react with the alkylaluminium derivative (polyunsaturated hydrocarbons and polar compounds such as water).

Despite all the advantages of this process, one main limitation is the continuous catalyst carry-over by the products, with the need to deactivate it and to dispose of wastes. One way to optimize catalyst consumption and waste disposal was to operate the reaction in a biphasic system. The first difficulty was to choose a “good” solvent. *N,N'*-Dialkylimidazolium chloroaluminate ionic liquids proved to be the best candidates. These can easily be prepared on an industrial scale, are liquid at the reaction temperature, and are very poorly miscible with the products. They play the roles both of the catalyst solvent and of the co-catalyst, and their Lewis acidities can be adjusted to obtain the best performances. The solubility of butene in these solvents is high enough to stabilize the active nickel species (Table 5.3-3), the nickel

**Table 5.3-3:** Solubilities of 1-butene and *n*-butane in the acidic mixture composed of 1-butyl-3-methylimidazolium ([BMIM]) chloride/aluminum chloride/ethylaluminum dichloride (1:1.22: 0.06 molar ratio) as a function of temperature under atmospheric pressure.

Temperature (°C)	Solubility of 1-butene (wt %)*	Solubility of butane (wt %)
10	4.5	2
20	2	1

\*Isomerization of 1-butene into 2-butene is observed

catalyst can be immobilized without the addition of special ligands, and the catalytically active nickel complex is generated directly in the ionic liquid by treatment of a commercialized nickel(II) salt, as used in the Dimersol process, with an alkylaluminum chloride derivative.

The performances of the biphasic system in terms of activity, selectivity, recyclability, and lifetime of the ionic liquid have been evaluated in a continuous flow pilot operation. A representative industrial feed (raffinate II), composed of 70 % butenes (27 % of which is 1-butene) and 1.5 % isobutene (the remaining being *n*-butane and isobutane), enters continuously into a well mixed reactor containing the ionic liquid and the nickel catalyst. Injection of fresh catalyst components can be made to compensate for the detrimental effects of random impurities present in the feed. The reactor is operated full of liquid. The effluent (a mixture of the two liquid phases) leaves the reactor through an overflow and is transferred to a phase separator. The separation of the ionic liquid (density around 1200 g L<sup>-1</sup>) and the oligomers occurs rapidly and completely (favored by the difference in densities). The ionic liquid and the catalyst are recycled to the reactor. A continuous run has been carried out over a period of 5500 hours. Butene conversion and selectivity were stable, and no addition of fresh ionic liquid was required, demonstrating its stability under the reaction conditions. Relative to the homogeneous Dimersol process, the nickel consumption was decreased by a factor of 10. The octene selectivity was five points higher (90–95 % of the total products). This can be ascribed to the higher solubility of butenes (relative to the octenes) in the ionic liquids, subsequent reactions between octenes and butenes to form trimers thus being disfavored.

Despite the utmost importance of physical limitations such as solubility and mixing efficiency of the two phases, an apparent first-order reaction rate relative to the olefin monomer was determined experimentally. It has also been observed that an increase of the nickel concentration in the ionic phase results in an increase in the olefin conversion.

In the homogeneous Dimersol process, the olefin conversion is highly dependent on the initial concentration of monomers in the feedstock, which limits the applicability of the process. The biphasic system is able to overcome this limitation and promotes the dimerization of feedstock poorly concentrated in olefinic monomer.

The mixing of the two phases proved to be an important parameter for the reaction rate. An increased efficiency of the mixing resulted in an increase in the reaction rate but did not change the dimer selectivity. Elsewhere, batch laboratory experiments showed that no reaction occurred in the organic phase. This could indicate the possibility of the participation of an interfacial reaction.

The ratio of the ionic liquid to the organic phase present in the reactor also plays an important role. A too high level of ionic liquid results in much longer decantation time and causes lower dimer selectivity. To combine efficient decantation and a reasonable size for the settler in the process design, it has been proposed that the separation of the two phases be performed in two distinct settling zones arranged in parallel [38].

A new biphasic process named Difasol has been developed (see Figure 5.3-6). Because of the solubility of the catalyst in the ionic phase and the poor miscibility of the products, the unit is essentially reduced to a continuously stirred tank reactor followed by a phase separator. The heat of the reaction is removed by the circulation of a proportion of the organic phase in a cooler, while the remainder is sent to the washing section. Difasol is ideally suited for use after a first homogeneous dimerization step. This first homogeneous step proved to be the best way to purify the feed of trace impurities. It can be used instead of conventional feedstock pretreatment technologies using adsorbents. Another interesting approach to removal of the impurities from the feed consists of the circulation of the feed to be treated and the ionic liquid already used in the dimerization section as a counter-current [39].

A proposed package consists of a first homogeneous dimerization step, which acts mainly as a pretreatment of the feedstock, and a biphasic component (Figure 5.3-7).

This arrangement ensures more efficient overall catalyst utilization and a significant increase in the yield of octenes. As an example, dimer selectivity in the 90–92 % range with butene conversion in the 80–85 % range can be obtained with a  $C_4$  feed containing 60 % butenes. Thanks to the biphasic technique, the dimerization

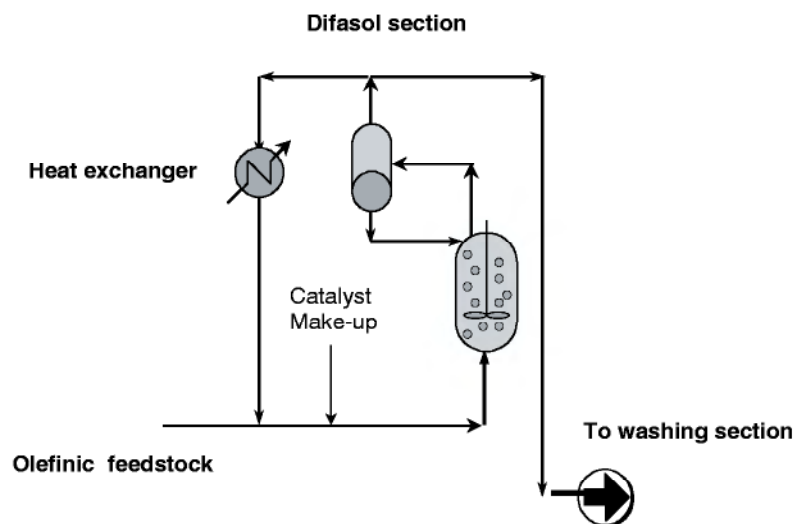

Figure 5.3-6: Difasol reaction section.

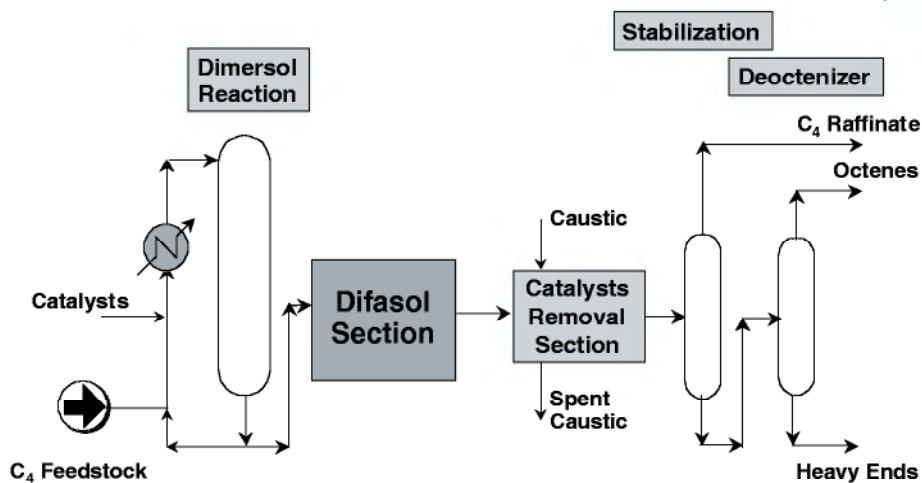

Figure 5.3-7: Process scheme integrating Dimersol and Difasol.

can also be extended to less reactive longer-chain olefins (C<sub>5</sub> feed), allowing the production of decenes and nonenes through co-dimerization of butenes and pentenes.

Since the catalyst is concentrated and operates in the ionic phase, and also probably at the phase boundary, reaction volumes in the biphasic technology are much lower than in the conventional single-phase Dimersol process, in which the catalyst concentration in the reactor is low. As an example, the Difasol reactor volume can be up to 40 times lower than that classically used in the homogeneous process.

A similar catalytic dimerization system has been investigated [40] in a continuous flow loop reactor in order to study the stability of the ionic liquid solution. The catalyst used is the organometallic nickel(II) complex (Hcod)Ni(hfacac) (Hcod = cyclooct-4-ene-1-yl and hfacac = 1,1,1,5,5,5-hexafluoro-2,4-pentanedionato-O,O'), and the ionic liquid is an acidic chloroaluminate based on the acidic mixture of 1-butyl-4-methylpyridinium chloride and aluminium chloride. No alkylaluminium is added, but an organic Lewis base is added to buffer the acidity of the medium. The ionic catalyst solution is introduced into the reactor loop at the beginning of the reaction and the loop is filled with the reactants (total volume 160 mL). The feed enters continuously into the loop and the products are continuously separated in a settler. The overall activity is 18,000 (TON). The selectivity to dimers is in the 98 % range and the selectivity to linear octenes is 52 %.

#### 5.3.6.2 Alkylation reactions

BP Chemicals studied the use of chloroaluminates as acidic catalysts and solvents for aromatic hydrocarbon alkylation [41]. At present, the existing AlCl<sub>3</sub> technology (based on "red oil" catalyst) is still used industrially, but continues to suffer from poor catalyst separation and recycling [42]. The aim of the work was to evaluate the AlCl<sub>3</sub>-based ionic liquids, with the emphasis placed on the development of a clean

and recyclable system for the production of ethylbenzene (benzene/ethene alkylation) and synthetic lubricants (alkylation of benzene with 1-decene). The production of linear alkyl benzene (LAB) has also been developed by Akzo [43].

The ethylbenzene experiments were run by BP in a pilot loop reactor similar to that described for the dimerization (Figure 5.3-8).

Ionic liquids operate in true biphasic mode. While the recovery and recyclability of ionic liquid was found to be more efficient than with the conventional  $\text{AlCl}_3$  catalyst (red oil), the selectivity for the monoalkylated aromatic hydrocarbon was lower. In this gas-liquid-liquid reaction, the solubility of the reactants in the ionic phase (e.g. the benzene/ethene ratio in the ionic phase) and the mixing of the phases were probably critical. This is an example in which the engineering aspects are of the utmost importance.

The use of acidic chloroaluminates as alternative liquid acid catalysts for the alkylation of light olefins with isobutane, for the production of high octane number gasoline blending components, is also a challenge. This reaction has been performed in a continuous flow pilot plant operation at IFP [44] in a reactor vessel similar to that used for dimerization. The feed, a mixture of olefin and isobutane, is pumped continuously into the well stirred reactor containing the ionic liquid catalyst. In the case of ethene, which is less reactive than butene, [pyridinium]Cl/ $\text{AlCl}_3$  (1:2 molar ratio) ionic liquid proved to be the best candidate (Table 5.3-4).

The reaction can be run at room temperature and provides good quality alkylate (dimethylbutanes are the major products) over a period of three hundred hours.

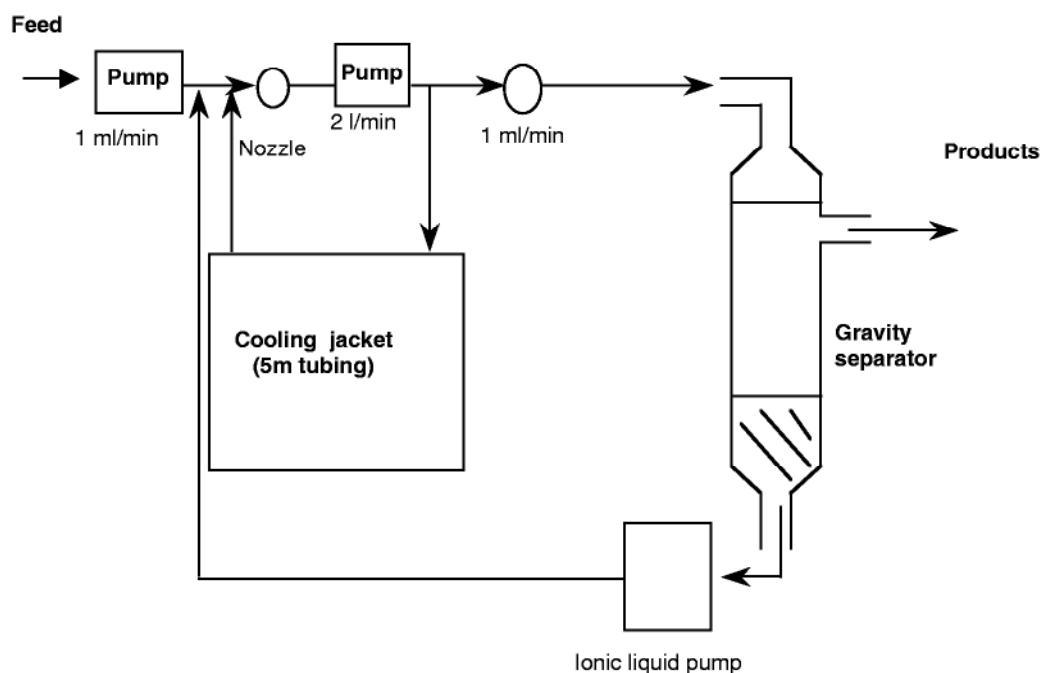

Figure 5.3-8: Loop reactor as used in aromatic hydrocarbon alkylation experiments.



**Table 5.3-4:** Alkylation of ethylene and 2-butene with isobutane. Semicontinuous pilot-plant results

<b>Operating conditions/ nature of the olefin</b>	<b>Ethene</b>	<b>2-Butene</b>
Nature of ionic liquid	[Pyridinium, HCl] /AlCl <sub>3</sub> (1:2 molar ratio)	[BMIM][Cl ]/AlCl <sub>3</sub>
Olefin content in the feed (wt%)	14–20	12–14
VVH <sup>a</sup> (h <sup>-1</sup> )	0.2	0.35–0.45
Temperature (°C)	25	5
Test duration (h)	354	520
Olefin conversion (wt%)	60–90	>98
Production (g products/g ionic liquid)	121	172
Product distribution (wt%)		
	i-C <sub>6</sub> <sup>b</sup> 75–90	Light ends <sup>e</sup> : 5–10
	i-C <sub>8</sub> <sup>c</sup> 10–17	i-C <sub>8</sub> <sup>c</sup> 80–90 (>90 % TMP)
	C <sub>8</sub> <sup>+d</sup> <5	C <sub>8</sub> <sup>+d</sup> 5–10
MON <sup>f</sup>	90–94	90–95
RON <sup>f</sup>	98–101	95–98

<sup>a</sup>Volume of olefin/(volume of ionic liquid.hour). <sup>b</sup>i-C<sub>6</sub> = 2,2- and 2,3-dimethylbutanes, <sup>c</sup>i-C<sub>8</sub> = isooctanes, TMP : trimethylpentanes, <sup>d</sup>C<sub>8</sub><sup>+</sup> = hydrocarbon products with more than eight carbon atoms, <sup>e</sup>Light ends = hydrocarbon products with fewer than eight carbon atoms, <sup>f</sup>RON = research octane number, MON = motor octane number

When butenes are used instead of ethene, lower temperature and fine-tuning of the acidity of the ionic liquid are required to avoid cracking reactions and heavy by-product formation. Continuous butene alkylation has been performed for more than five hundred hours with no loss of activity and stable selectivity. A high level of mixing is essential for a high selectivity and thus for a good quality alkylate. These applications are promising, but efforts are still needed to compete with the existing effective processes based on hydrofluoric and sulfuric acids.

### 5.3.6.3 Industrial use of ionic liquids

What can drive the switch from existing homogeneous processes to novel ionic liquids technology? One major point is probably a higher cost-effectiveness. This can result from improved reaction rates and selectivity, associated with more efficient catalyst recovery and better environmental compatibility.

The cost of ionic liquids can, of course, be a limiting factor in their development. However, this cost has to be weighed against that of current chemicals or catalysts.

If the ionic liquid can be recycled and if its lifetime is proven to be long enough, then its initial price is probably not the critical point. In Difasol technology, for example, ionic liquid cost, expressed with respect to the octene produced, is lower than that of the catalyst components.

The manufacture of ionic liquids on an industrial scale is also to be considered. Some ionic liquids have already been commercialized for electrochemical devices (such as capacitors) applications [45].

Chloroaluminate laboratory preparations proved to be easily extrapolated to large scale. These chloroaluminate salts are corrosive liquids in the presence of protons. When exposed to moisture, they produce hydrochloric acid, similarly to aluminium chloride. However, this can be avoided by the addition of some proton scavenger such as alkylaluminium derivatives. In Difasol technology, for example, carbon-steel reactors can be used with no corrosion problem.

The purity of ionic liquids is a key parameter, especially when they are used as solvents for transition metal complexes (see Section 5.2). The presence of impurities arising from their mode of preparation can change their physical and chemical properties. Even trace amounts of impurities (e.g., Lewis bases, water, chloride anion) can poison the active catalyst, due to its generally low concentration in the solvent. The control of ionic liquid quality is thus of utmost importance.

As new compounds, very limited research has been done to evaluate the biological effects of ionic liquids. The topical effect of [EMIM]Cl/AlCl<sub>3</sub> melts and [EMIM]Cl on the integument of laboratory rat has been investigated. The study reports that [EMIM]Cl is not in itself responsible for tissue damage. However, the chloroaluminate salt can induce tissue irritation, inflammation, and necrosis, due to the presence of aluminium chloride. However, treatments for aluminium chloride and hydrochloric acid are well documented. This study needs to be expanded to the other ionic liquids, and their toxicity need to be investigated [46].

Very few data [47] relating to the disposal of used ionic liquids are available. In Difasol technology, the used ionic liquid is taken out of the production system and the reactor is refilled with fresh catalyst solution.

### 5.3.7

#### **Concluding Remarks and Outlook**

In comparison with classical processes involving thermal separation, biphasic techniques offer simplified process schemes and no thermal stress for the organometallic catalyst. The concept requires that the catalyst and the product phases separate rapidly, to achieve a practical approach to the recovery and recycling of the catalyst. Thanks to their tunable solubility characteristics, ionic liquids have proven to be good candidates for multiphasic techniques. They extend the applications of aqueous biphasic systems to a broader range of organic hydrophobic substrates and water-sensitive catalysts [48–50].

To be applied industrially, performances must be superior to those of existing catalytic systems (activity, regioselectivity, and recyclability). The use of ionic liquid biphasic technology for nickel-catalyzed olefin dimerization proved to be successful,

and this system has been developed and is now proposed for commercialization. However, much effort remains if the concept is to be extended to non-chloroaluminate ionic liquids. In particular, the true potential of ionic liquids (and mixtures containing ionic liquids) could be achievable if a substantial body of thermophysical and thermodynamic properties were amassed in order that the best medium for a given reaction could be chosen.

As far as industrial applications are concerned, the easy scale-up of two-phase catalysis can be illustrated by the first oxo aqueous biphasic commercial unit with an initial annual capacity of 100,000 tons extrapolated by a factor of 1:24,000 (batch-wise laboratory development → production reactor) after a development period of 2 years [4].

## References

- 1 B. Cornils, W. A. Herrmann in *Applied Homogeneous Catalysis with Organometallic Compounds* (B. Cornils, A. W. Herrmann eds.) Wiley-VCH, Weinheim 2000, p. 575.
- 2 V. E. Dehmlow in *Aqueous-Phase Organometallic Catalysis: Concept and Applications* (B. Cornils, A. W. Herrmann eds.), Wiley-VCH, Weinheim 1998, p. 207.
- 3 B. Cornils, E. G. Kuntz, in *Aqueous-Phase Organometallic Catalysis: Concept and Applications* (B. Cornils, A. W. Herrmann eds.), Wiley-VCH, Weinheim 1998, p. 271.
- 4 B. Cornils, *Org. Process Res. Dev.* 1998, 2, 121.
- 5 J. Herwig, R. Fischer in *Rhodium-catalyzed Hydroformylation in Catalysis by Metal Complexes* (P. W. N. M. van Leewen, C. Claver eds.), Kluwer Academic Publisher, The Netherlands, Vol. 22, 2000, p. 189.
- 6 Modern Solvents in Organic Synthesis, in *Topics in current Chemistry*, (P. Knochel Ed), Springer, Berlin, Vol. 206, 1999.
- 7 J. N. Reek, P. C. J. Kamer, P. W. N. M. van Leeuwen, *Rhodium-catalyzed Hydroformylation in Catalysis by Metal Complexes* (P. W. N. M. van Leewen, C. Claver eds.), Kluwer Academic Publisher, The Netherlands, Vol. 22, 2000, p. 253.
- 8 I. T. Horvath, *Acc. Chem. Res.* 1998, 31, 641.
- 9 P. G. Jessop, T. Ikariya, R. Noyori, *Chem. Rev.* 1999, 99, 475.
- 10 B. M. Bhanage, M. Shirai, M. Arai, Y. Ikushima, *Chem. Commun.* 1999, 1277.
- 11 J. G. Huddleston, A. E. Visser, W. M. Reichert, H. D. Willauer, G. A. Broker, R. D. Rogers, *Green Chemistry* 2001, 3, 156.
- 12 H. L. Ngo, K. LeCompte, L. Hargens, A. B. McEwen, *Thermochim. Acta* 2000, 97, 357–358.
- 13 R. P. Sawtloski, A. E. Visser, M. W. Reichert, G. A. Broker, L. M. Farina, J. D. Holbrey, R. D. Rogers, *Chem. Commun.* 2001, 2070.
- 14 J. Dupont, P. A. Z. Suarez, A. P. Umpierre, R. F. de Souza, *Catal. Lett.* 2001, 73, 211.
- 15 N. Karodia, S. Guise, G. Newlands, J.-A. Andersen, *Chem. Commun.* 1998, 2341.
- 16 W. Keim, D. Vogt, H. Waffenschmidt, P. Wasserscheid, *J. Catal.* 1999, 186, 481.
- 17 N. Yoshimura in *Aqueous-Phase Organometallic Catalysis: Concept and Applications* (B. Cornils, A. W. Herrmann eds.), Wiley-VCH, Weinheim 1998, p. 408.
- 18 A. J. Carmichael, M. J. Earle, J. D. Holbrey, P. B. McCormac, K. R. Seddon, *Org. Lett.* 1999, 1, 997.
- 19 M. Freemantle, *Chem. Eng. News* 2001, 41.

- 20 T. Schäfer, C. A. Rodrigues, A. M. A. Carlos, J. G. Crespo, *Chem. Commun.* **2001**, 1622.
- 21 R. T. Carlin, J. Fuller, *Chem Commun.* **1997**, 1345.
- 22 Y. Chauvin, L. Mussmann, H. Olivier, *Angew. Chem. Int. Ed.* **1995**, *34*, 2698.
- 23 P. J. Dyson, D. J. Ellis, D. G. Parker, T. Welton, *Chem. Commun.* **1999**, 25.
- 24 Y. Chauvin, S. Einloft, H. Olivier, *Ind. Eng. Chem. Res.* **1995**, *34*, 1149.
- 25 P. Wasserscheid, C. M. Gordon, C. Hilgers, M. J. Muldoon, I. R. Dunkin, *Chem. Commun.* **2001**, 1186.
- 26 C. J. Mathews, P. J. Smith, T. Welton, *Chem. Commun.* **2000**, 1249.
- 27 G. W. Parshall, *J. Am. Chem. Soc.* **1972**, *94*, 8716.
- 28 F. Favre, H. Olivier-Bourbigou, D. Commereuc, L. Saussine, *Chem. Commun.* **2001**, 1360.
- 29 P. Wasserscheid, H. Waffenschmidt, P. Machnitzki, K. W. Kottsieper, O. Stelzer, *Chem. Commun.* **2001**, 451.
- 30 D. J. Brauer, K. W. Kottsieper, C. Liek, O. Stelzer, H. Waffenschmidt, P. Wasserscheid, *J. Organomet. Chem.* **2001**, *630*, 177.
- 31 K. W. Kottsieper, O. Stelzer, P. Wasserscheid, *J. Mol. Catal.* **2001**, *175*, 285.
- 32 C. C. Brasse, U. Englert, A. Salzer, H. Waffenschmidt, P. Wasserscheid, *Organometallics* **2000**, *19*, 3818.
- 33 Celanese Chemicals Europe (H. Bahrmann, H. Bohnen) Ger. Offen., DE 19919494 (2000).
- 34 (a) L. Xu, W. Chen, J. Xiao, *Organometallics* **2000**, *19*, 1123.  
(b) C. Mathews, P. J. Smith, T. Welton, A. J. P. White, D. J. Williams, *Organometallics*, **2001**, *20*, 3848.
- 35 O. Wachsen, K. Himmler, B. Cornils, *Catal. Today* **1998**, *42*, 373.
- 36 Y. Zhang, Z.-S. Mao, J. Chen, *Ind. Eng. Chem. Res.* **2001**, *40*, 4496.
- 37 A. Berger, R. F. de Souza, M. R. Delgado, J. Dupont, *Tetrahedron: Asymmetry* **2001**, *12*, 1825.
- 38 Institut Français du Pétrole (C. Bronner, A. Forestière, F. Hugues) US 6 203 712 B1 (2001).
- 39 Institut Français du Pétrole (H. Olivier, D. Commereuc, A. Forestière, F. Hugues) US 6 284 937 (2001).
- 40 P. Wasserscheid, M. Eichmann, *Catal. Today* **2001**, *66*, 309.
- 41 BP Chemicals Limited (B. Ellis, F. Hubert, P. Wasserscheid) PCT Int. WO 00/41809 (2000).
- 42 S. E. Knipling, *Petroleum Technology Quarterly* Autumn **2001**, 123.
- 43 Akzo Nobel (F. G. Sherif, L.-J. Shyu, C. Greco, A. G. Talma, C. P. M. Lacroix) WO 98/03454 (1998).
- 44 Y. Chauvin, A. Hirschauer, H. Olivier, *J. Mol. Catal.* **1994**, *92*, 155.
- 45 K. Xu, M. S. Ding, T. R. Jow, *J. Electrochem. Soc.* **2001**, *148*, A267.
- 46 W. Mehm, J. B. Nold, C. Randall, B. S. Zernzsch, *Aviation, Space, and Environmental Medicine* **1986**, 362.
- 47 British Nuclear Fuels (A. J. Jeapes, R. C. Thied, K. R. Seddon, W. R. Pitter, D. W. Rooney, J. E. Hatter, T. Welton) PCT Int. WO 01/15175 (2001).
- 48 H. Olivier-Bourbigou, L. Magna, *J. Mol. Catal. A: Chem.* **2002**, *419*, 182–183.
- 49 P. Wasserscheid, W. Keim, *Angew. Chem. Int. Ed.* **2000**, *39*, 3772.
- 50 R. Sheldon, *Chem. Commun.* **2001**, 2399.

## 5.4

### Multiphasic Catalysis with Ionic Liquids in Combination with Compressed CO<sub>2</sub>

*Peter Wasserscheid*

#### 5.4.1

##### Introduction

Ionic liquids are often viewed as promising solvents for “clean processes” and “green chemistry”, mainly due to their nonvolatile characters [1, 2]. These two catch-phrases encompass current efforts to reduce drastically the amounts of side and coupling products, and also solvent and catalyst consumption in chemical processes. As another “green solvent” concept for chemical reactions, the replacement of volatile organic solvents by supercritical CO<sub>2</sub> (*sc*CO<sub>2</sub>) is frequently discussed [3]. *sc*CO<sub>2</sub> combines environmentally benign characteristics (nontoxic, nonflammable) with favorable physicochemical properties for chemical synthesis. Catalyst separation schemes based on the tunable phase behavior of *sc*CO<sub>2</sub> (e.g. CESS process) have been developed [4].

However, ionic liquids and *sc*CO<sub>2</sub> are not competing concepts for the same applications. While ionic liquids can be considered as alternatives for polar organic solvents, the use of *sc*CO<sub>2</sub> can cover those applications in which non-polar solvents are usually used.

With regard to homogeneous transition metal-catalyzed reactions, the two media show complementary strengths and weaknesses. While ionic liquids are known to be excellent solvents for many transition metal catalysts (see Section 5.2), the solubilities of most transition metal complexes in *sc*CO<sub>2</sub> are poor. Usually, special ligand designs (such as phosphine ligands with fluorinated “ponytails” [3]) are required to allow sufficient catalyst concentration in the supercritical medium. However, the isolation of the product from the solvent is always very easy in the case of *sc*CO<sub>2</sub>, while product isolation from an ionic catalyst solution can become more and more complicated depending on the solubility of the product in the ionic liquid and on the product’s boiling point.

In cases in which product solubility in the ionic liquid and the product’s boiling point are high, the extraction of the product from the ionic liquid with an additional organic solvent is frequently proposed. This approach often suffers from some catalyst losses (due to some mutual solubility) and causes additional steps in the workup. Moreover, the use of an additional, volatile extraction solvent may nullify the “green solvent” motivation to use ionic liquids as nonvolatile solvents.

Beckman, Brennecke, and their research groups were the first to realize that the combination of *sc*CO<sub>2</sub> and an ionic liquid can offer special advantages. They observed that, although *sc*CO<sub>2</sub> is surprisingly soluble in some ionic liquids, the reverse is not the case, with no detectable ionic liquid solubilization in the CO<sub>2</sub> phase. On the basis of these results they described a method to remove naphthalene quantitatively from the ionic liquid [BMIM][PF<sub>6</sub>] by extraction with *sc*CO<sub>2</sub> [5]. Sub-

sequent work by Brennecke's team has applied the same procedure to the extraction of a large variety of different solutes from ionic liquids, without observation of any ionic liquid contamination in the isolated substances [6].

Research efforts aiming to quantify the solubility of CO<sub>2</sub> in ionic liquids revealed a significant influence of the ionic liquid's water content on the CO<sub>2</sub> solubility. While water-saturated [BMIM][PF<sub>6</sub>] (up to 2.3 wt% water) has a CO<sub>2</sub> solubility of only 0.13 mol fraction, 0.54 mol fraction CO<sub>2</sub> dissolves in dry [BMIM][PF<sub>6</sub>] (about 0.15 wt% water) at 57 bar and 40 °C [7]. Kazarian et al. used ATR-IR to determine the solubility of CO<sub>2</sub> in [BMIM][PF<sub>6</sub>] and [BMIM][BF<sub>4</sub>]. They reported a solubility of 0.6 mol fraction CO<sub>2</sub> in [BMIM][PF<sub>6</sub>] at 68 bar and 40 °C [8].

#### 5.4.2

##### Catalytic Reaction with Subsequent Product Extraction

The first application involving a catalytic reaction in an ionic liquid and a subsequent extraction step with *sc*CO<sub>2</sub> was reported by Jessop et al. in 2001 [9]. These authors described two different asymmetric hydrogenation reactions using [Ru(OAc)<sub>2</sub>(tolBINAP)] as catalyst dissolved in the ionic liquid [BMIM][PF<sub>6</sub>]. In the asymmetric hydrogenation of tiglic acid (Scheme 5.4-1), the reaction was carried out in a [BMIM][PF<sub>6</sub>]/water biphasic mixture with excellent yield and selectivity. When the reaction was complete, the product was isolated by *sc*CO<sub>2</sub> extraction without contamination either by catalyst or by ionic liquid.

In a similar manner, the asymmetric hydrogenation of isobutylatropic acid to afford the anti-inflammatory drug ibuprofen has been carried out (Scheme 5.4-2). Here, the reaction was carried out in a [BMIM][PF<sub>6</sub>]/MeOH mixture, again followed by product extraction with *sc*CO<sub>2</sub> (see Section 5.2.4.1 for more details on these hydrogenation reactions).

#### 5.4.3

##### Catalytic Reaction with Simultaneous Product Extraction

More recently, Baker, Tumas, and co-workers published catalytic hydrogenation reactions in a biphasic reaction mixture consisting of the ionic liquid [BMIM][PF<sub>6</sub>] and *sc*CO<sub>2</sub> [10]. In the hydrogenation of 1-decene with Wilkinson's catalyst [RhCl(PPh<sub>3</sub>)<sub>3</sub>] at 50 °C and 48 bar H<sub>2</sub> (total pressure 207 bar), conversion of 98 %

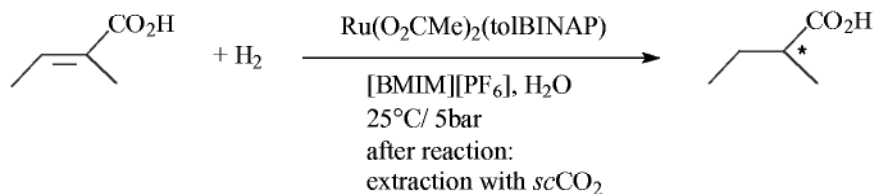

**Scheme 5.4-1:** Asymmetric, Ru-catalyzed hydrogenation of tiglic acid in [BMIM][PF<sub>6</sub>] followed by extraction with *sc*CO<sub>2</sub>.



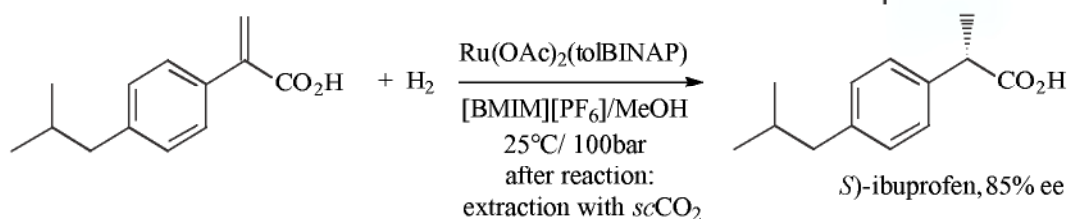

**Scheme 5.4-2:** Synthesis of ibuprofen by asymmetric, Ru-catalyzed hydrogenation in [BMIM][PF<sub>6</sub>] with product isolation by subsequent extraction with *s*cCO<sub>2</sub>.

after 1 h was reported, corresponding to a turnover frequency (TOF) of 410 h<sup>-1</sup>. Under identical conditions, the hydrogenation of cyclohexene proceeded with 82 % conversion after 2 h (TOF = 220 h<sup>-1</sup>). The isolated ionic catalyst solution could be recycled in consecutive batches up to four times. The fact that a biphasic hydrogenation of 1-decene can be successfully achieved is not, however, any special benefit of the unconventional [BMIM][PF<sub>6</sub>]/*s*cCO<sub>2</sub> biphasic system. In fact, no reactivity advantage with the use of *s*cCO<sub>2</sub> in place of a more common alkane solvent for such a biphasic system can be concluded from the reported results.

#### 5.4.4

##### Catalytic Conversion of CO<sub>2</sub> in an Ionic Liquid/*s*cCO<sub>2</sub> Biphasic Mixture

In the same paper [10], the authors described the [RuCl<sub>2</sub>(dppe)]-catalyzed (dppe = Ph<sub>2</sub>P-(CH<sub>2</sub>)<sub>2</sub>-PPh<sub>2</sub>) hydrogenation of CO<sub>2</sub> in the presence of dialkylamines to obtain *N,N*-dialkylformamides. The reaction of di-*n*-propylamine in the [BMIM][PF<sub>6</sub>]/*s*cCO<sub>2</sub> system resulted in complete amine conversion to provide the desired *N,N*-di-*n*-propylformamide with high selectivity. This compound showed very high solubility in the ionic liquid phase, and complete product isolation by extraction with *s*cCO<sub>2</sub> proved to be difficult. However, product extraction with *s*cCO<sub>2</sub> became possible once the ionic catalyst solution had become completely saturated with the product.

#### 5.4.5

##### Continuous Reactions in an Ionic Liquid/Compressed CO<sub>2</sub> System

Cole-Hamilton and co-workers demonstrated the first flow apparatus for a continuous catalytic reaction using the biphasic system [BMIM][PF<sub>6</sub>]/*s*cCO<sub>2</sub> [11]. They investigated the continuous Rh-catalyzed hydroformylation of 1-octene over periods of up to 33 h using the ionic phosphine ligand [PMIM]<sub>2</sub>[PhP(C<sub>6</sub>H<sub>4</sub>SO<sub>3</sub>)<sub>2</sub>] ([PMIM] = 1-methyl-3-propylimidazolium). No catalyst decomposition was observed during the period of the reaction, and Rh leaching into the *s*cCO<sub>2</sub>/product stream was less than 1 ppm. The selectivity for the linear hydroformylation product was found to be stable over the reaction time (*n*/*iso* = 3.1).

During the continuous reaction, alkene, CO, H<sub>2</sub>, and CO<sub>2</sub> were separately fed into the reactor containing the ionic liquid catalyst solution. The products and uncon-

verted feedstock were removed from the ionic liquid still dissolved in  $sc\text{CO}_2$ . After decompression the liquid product was collected and analyzed. A schematic view of the apparatus used by Cole-Hamilton et al. is given in Figure 5.4-1.

Obviously, the motivation to perform this hydroformylation reaction in a continuous flow reactor arose from some problems during the catalyst recycling when the same reaction was first carried out in repetitive batch mode. In the latter case, Cole-Hamilton et al. observed a continuous drop of the product's  $n/iso$  ratio from 3.7 to 2.5 over the first nine runs. Moreover, the isomerization activity of the system increased during the batch-wise recycling experiments, and Rh leaching became significant after the ninth run. The authors concluded from  $^{31}\text{P}$  NMR investigations that ligand oxidation due to contamination of the systems with air (during the opening of the reactor for recycling) had resulted in the formation of  $[\text{RhH}(\text{CO})_4]$  as the active catalytic species. This compound is known to show more isomerization activity and a lower  $n/iso$  ratio than the phosphine-modified catalyst system. Moreover,  $[\text{RhH}(\text{CO})_4]$  is also known to display some solubility in  $sc\text{CO}_2$ , which explains the observed leaching of rhodium into the organic layer.

All the problems associated with the batch-wise catalyst recycling could be convincingly overcome by application of the continuous operation mode described above. The authors concluded that continuous flow  $sc\text{CO}_2$ /ionic liquid biphasic systems provided a method for continuous flow homogeneous catalysis with integrated separation of the products from the catalyst and from the reaction solvent. Most interestingly, this unusual continuous biphasic reaction mode enabled the quantitative separation of relatively high boiling products from the ionic catalyst solution under mild temperature conditions and without use of an additional organic extraction solvent.

Slightly later, and independently of Cole-Hamilton's pioneering work, the author's group demonstrated in collaboration with Leitner et al. that the combination of a suitable ionic liquid with compressed  $\text{CO}_2$  can offer much more potential for homogeneous transition metal catalysis than only being a new procedure for easy product isolation and catalyst recycling. In the Ni-catalyzed hydrovinylation of

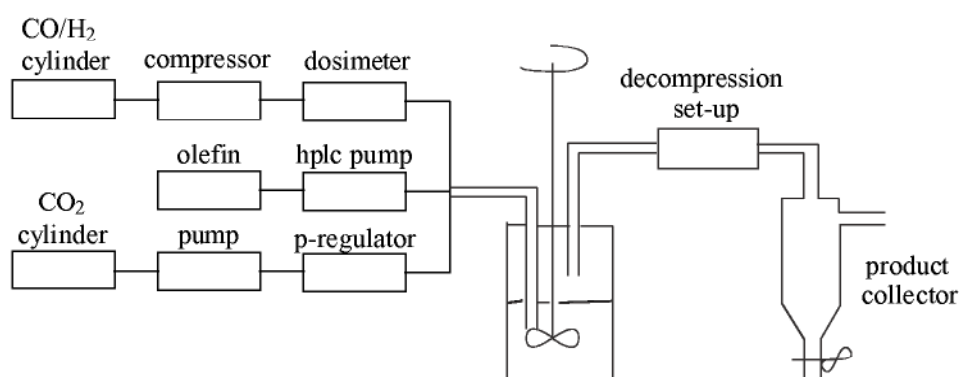

Figure 5.4-1: Continuous flow apparatus as used for the hydroformylation of 1-octene in the biphasic system  $[\text{BMIM}][\text{PF}_6]/sc\text{CO}_2$

styrene it was possible to activate, tune, and immobilize the well-known Wilke complex by use of this unusual biphasic system (Scheme 5.4-3). Obviously, this reaction benefits from this special solvent combination in a new and highly promising manner.

Hydrovinylation is the transition metal-catalyzed co-dimerization of alkenes with ethene yielding 3-substituted 1-butenes [12]. This powerful carbon–carbon bond-forming reaction can be achieved with high enantioselectivity by the use of Wilke's complex as a catalyst precursor [13]. In conventional solvents, this pre-catalyst needs to be activated with a chloride abstracting agent, such as Et<sub>3</sub>Al<sub>2</sub>Cl<sub>3</sub>. Leitner et al. reported the use of Wilke's complex in compressed CO<sub>2</sub> (under liquid and under supercritical conditions) after activation with alkali salts of weakly coordinating anions such as Na[BARF] ([BARF]<sup>−</sup> = [(3,5-(CF<sub>3</sub>)<sub>2</sub>C<sub>6</sub>H<sub>3</sub>)<sub>4</sub>B]<sup>−</sup>) [14].

At first, the reaction was investigated in batch mode, by use of different ionic liquids with weakly coordinating anions as the catalyst medium and compressed CO<sub>2</sub> as simultaneous extraction solvent. These experiments revealed that the activation of Wilke's catalyst by the ionic liquid medium was clearly highly dependent on the nature of the ionic liquid's anion. Comparison of the results in different ionic liquids with [EMIM]<sup>+</sup> as the common cation showed that the catalyst's activity drops in the order [BARF]<sup>−</sup> > [Al{OC(CF<sub>3</sub>)<sub>2</sub>Ph}<sub>4</sub>]<sup>−</sup> > [(CF<sub>3</sub>SO<sub>2</sub>)<sub>2</sub>N]<sup>−</sup> > [BF<sub>4</sub>]<sup>−</sup>. This trend is consistent with the estimated nucleophilicity/coordination strength of the anions.

Interestingly, the specific environment of the ionic solvent system appears to activate the chiral Ni-catalyst beyond a simple anion-exchange reaction. This becomes obvious from the fact that even the addition of a 100-fold excess of Li[(CF<sub>3</sub>SO<sub>2</sub>)<sub>2</sub>N] or Na[BF<sub>4</sub>] in pure, compressed CO<sub>2</sub> produced an at best moderate activation of Wilke's complex in comparison to the reaction in ionic liquids with the corresponding counter-ion (e.g., 24.4 % styrene conversion with 100-fold excess of Li[(CF<sub>3</sub>SO<sub>2</sub>)<sub>2</sub>N], in comparison to 69.9 % conversion in [EMIM][[(CF<sub>3</sub>SO<sub>2</sub>)<sub>2</sub>N] under otherwise identical conditions).

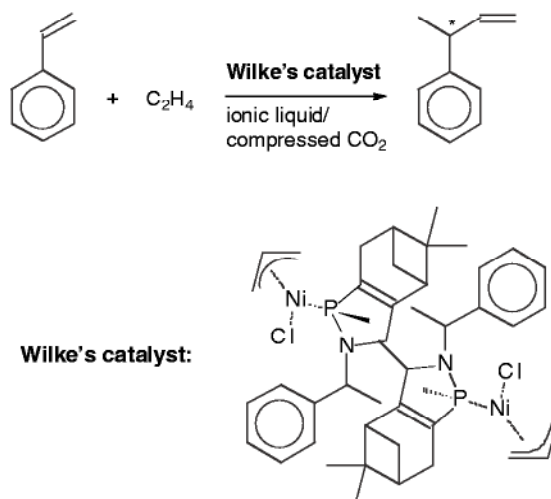

**Scheme 5.4-3:** The enantioselective hydrovinylation of styrene with Wilke's catalyst.

In the biphasic batch reaction the best reaction conditions were found for the system  $[\text{EMIM}][(\text{CF}_3\text{SO}_2)_2\text{N}]/\text{compressed CO}_2$ . It was found that increasing the partial pressure of ethylene and decreasing the temperature helped to suppress the concurrent side reactions (isomerization and oligomerization), 58 % conversion of styrene (styrene/Ni = 1000/1) being achieved after 1 h under 40 bar of ethylene at 0 °C with 3-phenyl-1-butene being detected as the only product and with a 71 % *ee* of the *R* isomer.

However, attempts to reuse the ionic catalyst solution in consecutive batches failed. While the products could readily be isolated after the reaction by extraction with *sc*CO<sub>2</sub>, the active nickel species deactivated rapidly within three to four batch-wise cycles. The fact that no such deactivation was observed in later experiments with the continuous flow apparatus described below (see Figure 5.4-2) clearly indicate the deactivation of the chiral Ni-catalyst being mainly related to the instability of the active species in the absence of substrate.

In the continuous hydrovinylation experiments, the ionic catalyst solution was placed in the reactor R, where it was in intimate contact with the continuous reaction phase entering from the bottom (no stirring was used in these experiments). The reaction phase was made up in the mixer M from a pulsed flow of ethylene and a continuous flow of styrene and compressed CO<sub>2</sub>.

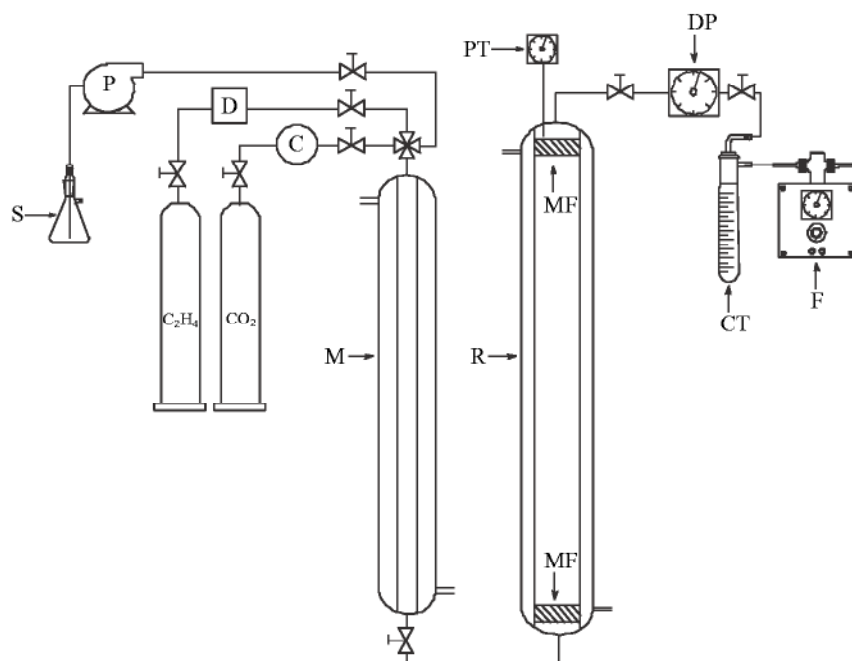

**Figure 5.4-2:** Schematic view of the continuous flow apparatus used for the enantioselective hydrovinylation of styrene in the biphasic  $[\text{EMIM}][(\text{CF}_3\text{SO}_2)_2\text{N}]$  system. The components are labeled (alphabetically) as follows: C: compressor, CT: cold trap, D: dosimeter, DP: depressurizer, F: flow-meter, M: mixer, MF: metal filter, P: HPLC pump, PT: pressure transducer and thermocouple, R: reactor, S: styrene.

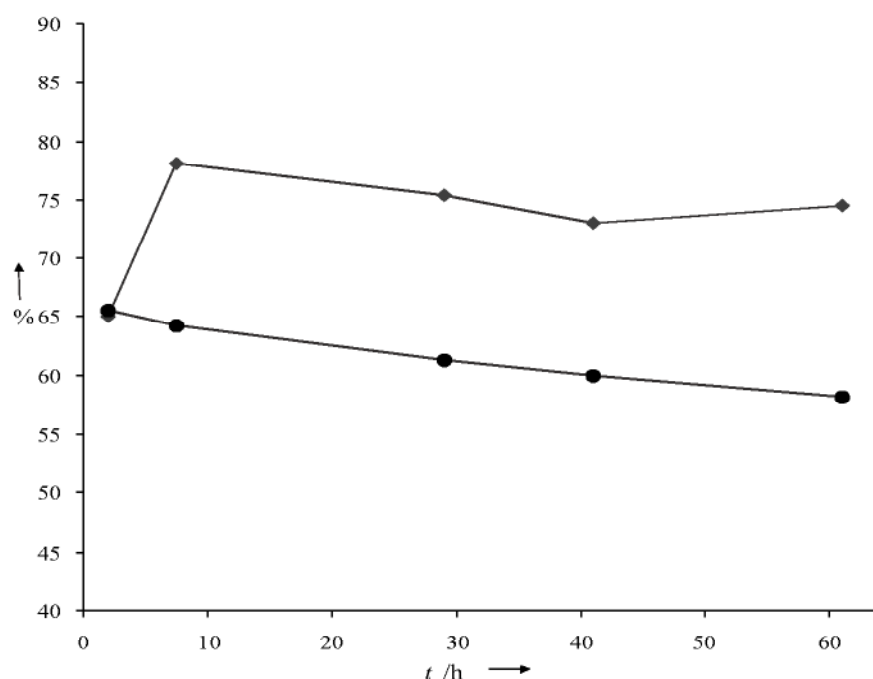

**Figure 5.4-3:** Lifetime study of Wilke's catalyst in the hydrovinylation of styrene, activated and immobilized in the [EMIM][[(CF<sub>3</sub>SO<sub>2</sub>)<sub>2</sub>N]/compressed CO<sub>2</sub> system (● ee; ◆ conversion).

Figure 5.4-3 shows the results of a lifetime study for Wilke's catalyst dissolved, activated, and immobilized in the [EMIM][[(CF<sub>3</sub>SO<sub>2</sub>)<sub>2</sub>N]/compressed CO<sub>2</sub> system. Over a period of more than 61 h, the active catalyst showed remarkably stable activity while the enantioselectivity dropped only slightly. These results clearly indicate – at least for the hydrovinylation of styrene with Wilke's catalyst – that an ionic liquid catalyst solution can show excellent catalytic performance in continuous product extraction with compressed CO<sub>2</sub>.

#### 5.4.6

#### Concluding Remarks and Outlook

The combination of ionic liquids and compressed CO<sub>2</sub> – at opposite extremes of the volatility and polarity scales – offers a new and intriguing immobilization technique for homogeneous catalysis.

In comparison with catalytic reactions in compressed CO<sub>2</sub> alone, many transition metal complexes are much more soluble in ionic liquids without the need for special ligands. Moreover, the ionic liquid catalyst phase provides the potential to activate and tune the organometallic catalyst. Furthermore, product separation from the catalyst is now possible without exposure of the catalyst to changes of temperature, pressure, or substrate concentration.

In contrast to the use of pure ionic liquid, the presence of compressed CO<sub>2</sub> greatly decreases the viscosity of the ionic catalyst solution, thus facilitating mass transfer during the catalytic reaction. Moreover, high-boiling products with some solubility in the ionic liquid phase can now be removed without use of an additional organic solvent. Finally, the use of compressed CO<sub>2</sub> as the mobile phase allows a reactor design very similar to a classical fixed bed reactor [15]. Thus, the combination of ionic liquids and compressed CO<sub>2</sub> provides a new and highly attractive approach, benefiting from the advantages of both homogeneous and heterogeneous catalysis. Moreover, this approach promises to overcome some of the well known limitations of conventional biphasic catalysis (catalyst immobilization, feedstock solubility in the catalytic phase, solvent cross-contamination, mass transfer limitation). In particular, the combination of nonvolatile ionic liquids with non-hazardous CO<sub>2</sub> offers fascinating new possibilities for the design of environmentally benign processes.

## References

- 1 M. Freemantle, *Chem. Eng. News* **1998**, *76*(13), 32.
- 2 a) M. Freemantle, *Chem. Eng. News* **1999**, *77*(1), 23; b) D. Bradley, *Chem. Ind.* **1999**, 86; c) M. Freemantle, *Chem. Eng. News* **2000**, *78*(20), 37.
- 3 a) P. G. Jessop, W. Leitner (eds.) *“Chemical Synthesis Using Supercritical Fluids”*, Wiley-VCH, Weinheim, **1999**; b) For recent reviews, see a) P. G. Jessop, T. Ikariya, R. Noyori, *Science*, **1995**, *269*, 1065–1069; c) P. G. Jessop, T. Ikariya, R. Noyori, *Chem. Rev.* **1999**, *99*, 475–493; d) M. Poliakoff, S. M. Howdle, S. G. Kazarian, *Angew. Chem. Int. Ed. Engl.* **1995**, *34*, 1275–1295.
- 4 a) G. Franciò, K. Wittmann, W. Leitner, *J. Organomet. Chem.* **2001**, *621*, 130–142; b) S. Kainz, A. Brinkmann, W. Leitner, A. Pfaltz, *J. Am. Chem. Soc.* **1999**, *121*, 6421–6429; c) D. Koch, W. Leitner, *J. Am. Chem. Soc.* **1998**, *120*, 13,398–13,404.
- 5 L. A. Blanchard, D. Hancu, E. J. Beckman, J. F. Brennecke, *Nature* **1999**, *299*, 28–29.
- 6 L. A. Blanchard, J. F. Brennecke, *Ind. Eng. Chem. Res.* **2001**, *40*, 287–292.
- 7 L. A. Blanchard, Z. Gu, J. F. Brennecke, *J. Phys. Chem. B* **2001**, *105*, 2437.
- 8 S. G. Kazarian, B. J. Biscoe, T. Welton, *Chem. Commun.* **2000**, 2047–2048.
- 9 R. A. Brown, P. Pollett, E. McKoon, C. A. Eckert, C. L. Liotta, P. G. Jessop, *J. Am. Chem. Soc.* **2001**, *123*, 1254–1255.
- 10 F. Liu, M. B. Abrams, R. T. Baker, W. Tumas, *Chem. Commun.* **2001**, 433–434.
- 11 a) M. F. Sellin, P. B. Webb, D. J. Cole-Hamilton, *Chem. Commun.* **2001**, 781–782; b) D. J. Cole-Hamilton, M. F. Sellin, P. B. Webb WO 0202218 (to the University of St. Andrews) 2002 [Chem. Abstr. **2002**, *136*, 104215].
- 12 For reviews, see a) P. W. Jolly, G. Wilke, *Applied Homogenous Catalysis with Organic Compounds 2*, (B. Cornils, W. A. Herrman eds.), Wiley-VCH, **1996**, 1024–1048; b) T. V. RajanBabu, N. Nomura, J. Jin, B. Radetich, H. Park, M. Nandi, *Chem. Eur. J.* **1999**, *5*, 1963–1968.
- 13 G. Wilke, J. Monkiewicz, H. Kuhn, DE 3618169 (to Studiengesellschaft Kohle m.b.H., Germany), **1987** [Chem. Abstr. **1988**, *109*, P6735].
- 14 A. Wegner, W. Leitner, *Chem. Commun.* **1999**, 1583–1584.
- 15 For the use of CO<sub>2</sub> as a mobile phase in classical heterogeneous catalysis, see: W. K. Gray, F. R. Smail, M. G. Hitzler, S. K. Ross, M. Poliakoff, *J. Am. Chem. Soc.* **1999**, *121*, 10,711–10,718.



## 6 Inorganic Synthesis

*Frank Endres and Tom Welton*

### 6.1 Directed Inorganic and Organometallic Synthesis

*Tom Welton*

Although a great deal of excitement has surrounded the use of ionic liquids as solvents for organic synthesis, the rational synthesis of inorganic and organometallic compounds in ionic liquids has remained largely unexplored.

#### 6.1.1 Coordination Compounds

Some halogenometalate species have been observed to have formed spontaneously during spectroelectrochemical studies in ionic liquids. For example,  $[\text{MoCl}_6]^{2-}$  (which is hydrolyzed in water, is coordinated by solvent in polar solvents, and has salts that are insoluble in non-polar solvents) can only be observed in basic  $\{X(\text{AlCl}_3) < 0.5\}$  chloroaluminate ionic liquids [1]. However, this work has been directed at the measurement of electrochemical data, rather than exploitation of the ionic liquids as solvents for synthesis [2]. It has been shown that the tetrachloroaluminate ion will act as a bidentate ligand in acidic  $\{X(\text{AlCl}_3) > 0.5\}$  chloroaluminate ionic liquids, forming  $[\text{M}(\text{AlCl}_4)_3]^-$  ions [3]. This was also the result of the spontaneous formation of the complexes, rather than a deliberate attempt to synthesize them.

The only reports of directed synthesis of coordination complexes in ionic liquids are from oxo-exchange chemistry. Exposure of chloroaluminate ionic liquids to water results in the formation of a variety of aluminium oxo- and hydroxo-containing species [4]. Dissolution of metals more oxophilic than aluminium will generate metal oxohalide species. Hussey et al. have used phosgene ( $\text{COCl}_2$ ) to deoxochlorinate  $[\text{NbOCl}_5]^{2-}$  (Scheme 6.1-1) [5].

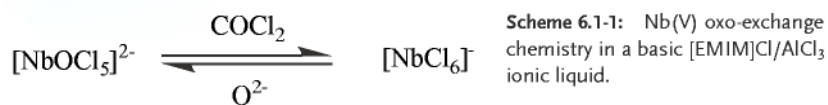

**Scheme 6.1-1:** Nb(V) oxo-exchange chemistry in a basic [EMIM]Cl/AlCl<sub>3</sub> ionic liquid.



**Scheme 6.1-2:** Vanadium oxo-exchange chemistry in a basic [EMIM]Cl/AlCl<sub>3</sub> ionic liquid

Triphosgene (bis(trichloromethyl)carbonate) has been used to deoxochlorinate [VOCl<sub>4</sub>]<sup>2-</sup> to [VCl<sub>6</sub>]<sup>3-</sup> and [VO<sub>2</sub>Cl<sub>2</sub>]<sup>-</sup> to [VOCl<sub>4</sub>]<sup>2-</sup> [6]. In both these cases the deoxochlorination was accompanied by spontaneous reduction of the initial products (Scheme 6.1-2).

### 6.1.2

#### Organometallic Compounds

With the enthusiasm currently being generated by the (so-called) stable carbenes (imidazolyidenes) [7], it is surprising that there are few reports of imidazolium-based ionic liquids being used to prepare metal imidazolylidene complexes. Xiao et al. have prepared bis(imidazolylidene)palladium(II) dibromide in [BMIM]Br [8]. All four possible conformers are formed, as shown in Scheme 6.1-3.

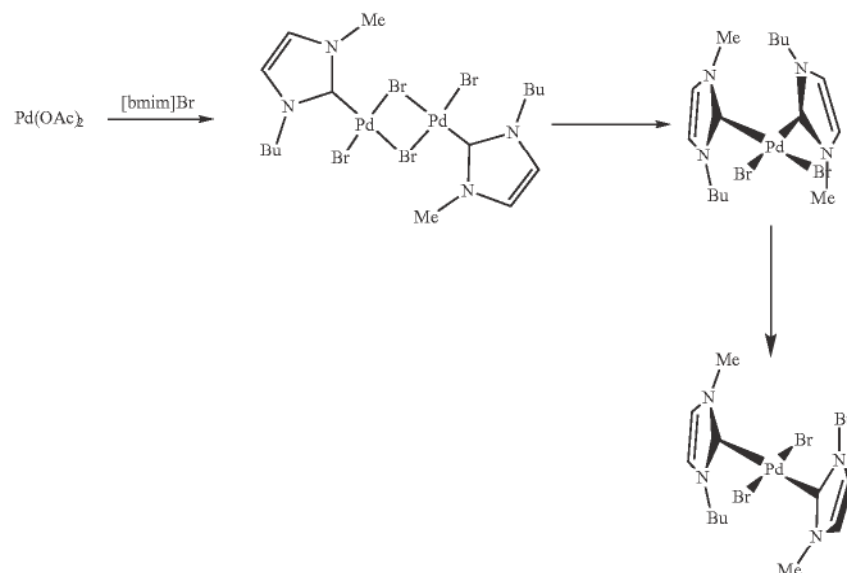

**Scheme 6.1-3:** The formation of bis(1-butyl-3-methylimidazolylidene)palladium(II) dibromide in [BMIM]Br

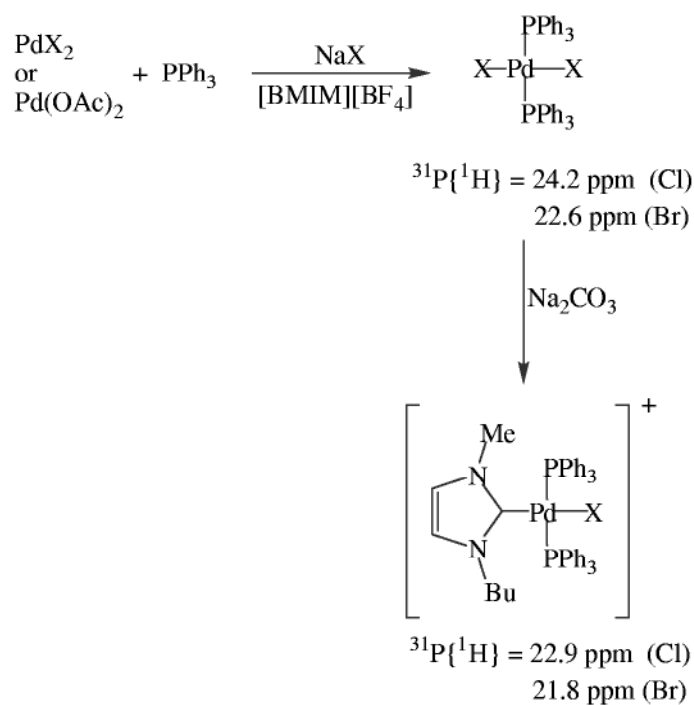

**Scheme 6.1-4:** The formation of (1-butyl-3-methylimidazolyidene)bis(triphenylphosphine)palladium(II) chloride in [BMIM][BF<sub>4</sub>].

In the presence of triphenylphosphine and four equivalents of chloride, (1-butyl-3-methylimidazolyidene)bis(triphenylphosphine)palladium(II) chloride is formed (Scheme 6.1-4).

Singer and co-workers have investigated the acylation reactions of ferrocene in ionic liquids made from mixtures of [EMIM]I and aluminium(III) chloride (Scheme 6.1-5) [9, 10]. The ionic liquid acts both as solvent and as source of the Friedel–Crafts catalyst. In mildly acidic  $\{X(\text{AlCl}_3) > 0.5\}$  [EMIM]I/AlCl<sub>3</sub>, the monoacetylated ferrocene was obtained as the major product. In strongly acidic [EMIM]I/AlCl<sub>3</sub>  $\{X(\text{AlCl}_3) = 0.67\}$  the diacetylated ferrocene was the major product. Also, when R = alkyl, the diacetylated product was usually the major product, but for R = Ph, the monoacetylated product was favored.

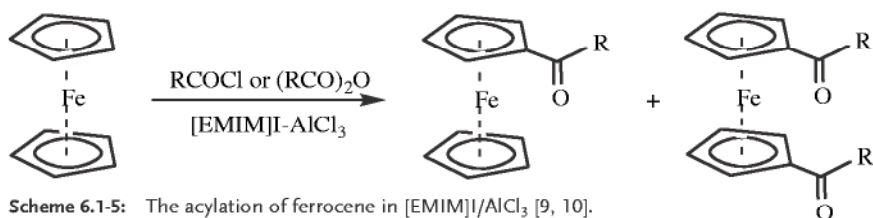

**Scheme 6.1-5:** The acylation of ferrocene in [EMIM]I/AlCl<sub>3</sub> [9, 10].

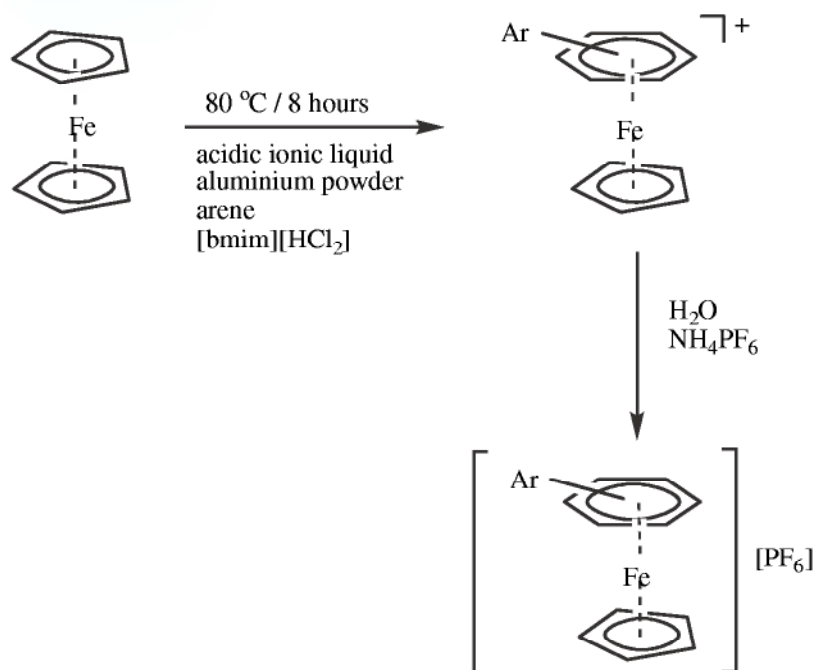

**Scheme 6.1-6:** Arene exchange reactions of ferrocene in [BMIM]Cl/AlCl<sub>3</sub>.

In another study relying on chloroaluminate chemistry, the Fisher–Hafner-type ligand-exchange reactions of ferrocene were investigated (Scheme 6.1-6) [11]. Again, the acidic ionic liquids acted as combinations of solvent and catalyst. In these reactions it was necessary to add [BMIM][HCl<sub>2</sub>] as a proton source, to generate the cyclopentadiene leaving group.

The strong halide-abstracting properties of acidic {X(AlCl<sub>3</sub>) = 0.67} [BMIM]Cl/AlCl<sub>3</sub> have been used for the synthesis of the “piano stool” complexes [Mn(CO)<sub>3</sub>(η<sup>6</sup>-arene)]<sup>+</sup> (Scheme 6.1-7) [12].

In all of the above cases the products were isolated by the destruction of the chloroaluminate ionic liquids by addition to water.

### 6.1.3

#### Other Reactions

The only other report of the use of an ionic liquid to prepare an inorganic material is that of the formation of a silica aerogel in [EMIM][(CF<sub>3</sub>SO<sub>2</sub>)<sub>2</sub>N] [13]. Formic acid was added to tetramethylorthosilicate in the ionic liquid, yielding a gel that cured over a period of three weeks (Scheme 6.1-8). Here, it was the nonvolatile nature of the ionic liquid, preventing the loss of solvent during the curing process, that was exploited. The ionic liquid was retrieved from the aerogel by extraction with acetonitrile.

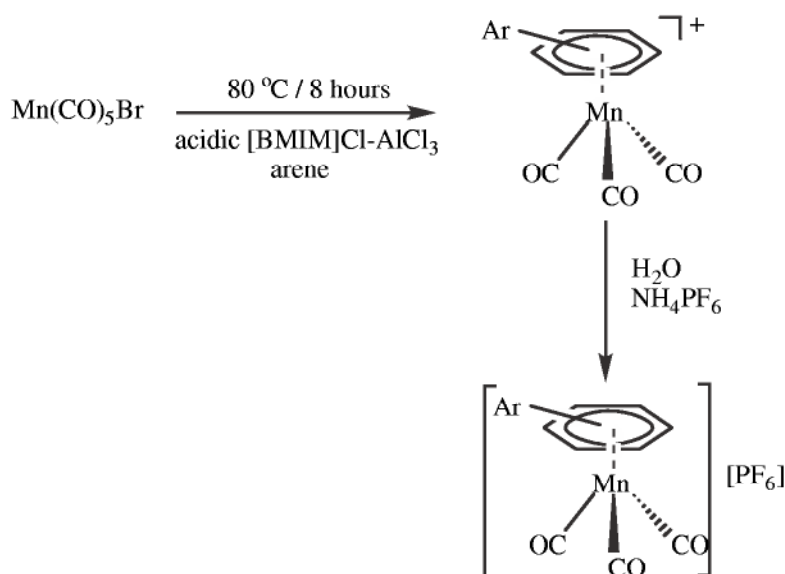

**Scheme 6.1-7:** The synthesis of  $[\text{Mn}(\text{CO})_3(\eta^6\text{-arene})]^+$  “piano stool” complexes in  $[\text{BMIM}]\text{Cl}/\text{AlCl}_3$ .

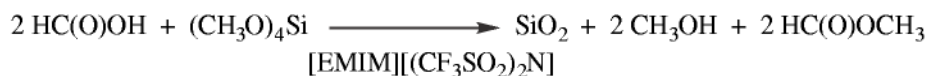

**Scheme 6.1-8:** The formation of a  $\text{SiO}_2$  aerogel in  $[\text{EMIM}][(\text{CF}_3\text{SO}_2)_2\text{N}]$ .

#### 6.1.4

##### Outlook

There is no doubt that inorganic and organometallic synthesis in ionic liquids is lagging behind organic synthesis. This is not due to any lack of importance. If, for instance, ionic liquids are to find use in biphasic catalysis, a point will arrive at which the ionic liquid layer can no longer be recycled. It will only be through an understanding of the chemistry of the dissolved catalysts, deliberately prepared to be difficult to remove, that they will be transformable into materials capable of being extracted from the ionic liquids.

Ionic liquids hold as much promise for inorganic and organometallic synthesis as they do for organic synthesis. Their lack of vapor pressure has already been exploited [13], as have their interesting solubility properties. The field can only be expected to accelerate from its slow beginnings.

## References

- 1 T. B. Scheffler, C. L. Hussey, K. R. Seddon, C. M. Kear and P. D. Armitage, *Inorg. Chem.* **1984**, *23*, 1926.
- 2 C. L. Hussey, *Pure Appl. Chem.* **1988**, *60*, 1763.
- 3 A. J. Dent, K. R. Seddon and T. Welton, *J. Chem. Soc., Chem. Commun.* **1990**, 315.
- 4 T. Welton, *Chem. Rev.* **1999**, *99*, 2071.
- 5 I. W. Sun, E. H. Ward and C. L. Hussey, *Inorg. Chem.* **1987**, *26*, 4309.
- 6 A. J. Dent, A. Lees, R. J. Lewis, and T. Welton, *J. Chem. Soc., Dalton Trans.* **1996**, 2787.
- 7 (a) W. A. Herrmann and C. Kocher, *Angew. Chem. Int. Ed.* **1997**, *36*, 2163; (b) D. Bourissou, O. Guerret, F. P. Gabbai and G. Bertrand, *Chem. Rev.* **2000**, *100*, 39.
- 8 L. Xu, W. Chen, and J. Xiao, *Organometallics* **2000**, *19*, 1123.
- 9 J. K. D. Surette, I. Green, and R. D. Singer, *Chem. Commun.* **1996**, 2753.
- 10 A. Stark, B. L. MacLean, and R. D. Singer, *J. Chem. Soc., Dalton Trans.* **1999**, 63.
- 11 Paul J. Dyson, Martin C. Grossel, N. Srinivasan, T. Vine, T. Welton, D. J. Williams, A. J. P. White, and T. Zigras, *J. Chem. Soc., Dalton Trans.* **1997**, 3465.
- 12 D. Crofts, P. J. Dyson, K. M. Sander-son, N. Srinivasan, and T. Welton, *J. Organomet. Chem.* **1999**, *573*, 292
- 13 S. Dai, Y. H. Ju, H. J. Gao, J. S. Lin, S. J. Pennycook, and C. E. Barnes, *Chem. Commun.* **2000**, 243.

## 6.2

### Making of Inorganic Materials by Electrochemical Methods

Frank Endres

#### 6.2.1

##### Electrodeposition of Metals and Semiconductors

###### 6.2.1.1 General considerations

Electrodeposition is one of the main fields in electrochemistry, both in industrial processes and in basic research. In principal, all metals and semiconductors can be obtained by electrolysis of the respective salts in aqueous or organic solutions and molten salts, respectively. As well as electrowinning of the elements, electrocoating of materials for corrosion protection is an important field in industry and in basic research. With the help of the Scanning Tunneling Microscope, a great deal of work on the nanometer scale has been done over the past 15 years. Insight into how the initial stages of metal deposition influence the bulk growth has been obtained. Furthermore, the role of brighteners, added to solutions to make shining deposits, can now be understood; they seem to adsorb at growing clusters and force the metal to grow layer-by-layer instead of in the form of clusters [1]. Aqueous solutions, however, are unsuitable for the electrodeposition of less noble elements because of their limited electrochemical windows. For light, refractory, and rare earth metals, water



fails as a solvent because hydrogen evolves long before deposition of the metal. Ionic liquids are ideal solvents for such purposes though, because they have – depending on their compositions – wide electrochemical windows combined with good solubilities of most metal salts and semiconductor compounds [2]. Many technical processes, such as the electrowinning of the rare earth and refractory metals Mg, Al, and several others, are performed in high-temperature molten salts. These systems are highly corrosive and sometimes make it difficult to find materials that will withstand chemical attack by the melts. The design of electrochemical cells for low-melting ionic liquids, in contrast, is much easier. These combine, more or less, the advantages of classical molten salts and those of aqueous media. Thanks to their wide electrochemical windows, several metals and alloys conventionally accessible from high-temperature molten salts – such as Al and its alloys, La, etc. – can also be deposited at room temperature. Furthermore, metals obtainable from aqueous media can in most cases also be deposited from ionic liquids, often with superior quality since hydrogen evolution does not occur. Pd is a good example, since deposits from aqueous solutions can contain varying amounts of hydrogen, which can make the deposits rather brittle. However, shining, even, nanosized Pd deposits can easily be obtained from ionic liquids. These features and their good ionic conductivities of between  $10^{-3}$  and  $10^{-2}$  ( $\Omega\text{cm}$ )<sup>-1</sup> make the ionic liquids interesting solvents for electrodeposition.

Section 6.2.1 offers literature data on the electrodeposition of metals and semiconductors from ionic liquids and briefly introduces basic considerations for electrochemical experiments. Section 6.2.2 describes new results from investigations of process at the electrode/ionic liquids interface. This part includes a short introduction to *in situ* Scanning Tunneling Microscopy.

#### 6.2.1.2 Electrochemical equipment

Any redox couple has a defined electrode potential on the electrochemical potential scale. In aqueous solutions, for example, a silver wire immersed into a solution containing  $\text{Ag}^+$  ions with the activity 1 has a value of +799 mV vs. the normal hydrogen electrode. At more positive potentials a Ag electrode will dissolve, at more negative values Ag will deposit from the ions. If one applies a certain voltage between two electrodes, an electrochemical reaction may occur, depending on the applied voltage. If one wants to know the processes involved, for example during electrodeposition, it is necessary to know the electrode potential relative to a reference electrode exactly. This can be measured by means of a third electrode immersed in the solution. This is the three-electrode setup, with the working electrode of interest (WE), the reference electrode (RE), and the counter-electrode (CE). However, any current  $I(\text{EC})$  that flows through the cell will influence the electrode potentials, so a stable value would be hard to obtain. A potentiostat allows precise control of the potential of the working electrode with respect to a reference electrode. It always applies the desired value  $U(\text{setpoint})$  to the working electrode, usually responding to changes within microseconds. A simplified setup based on an operational amplifier (OPA), where the working electrode is connected to ground, is presented in Figure 6.2-1.

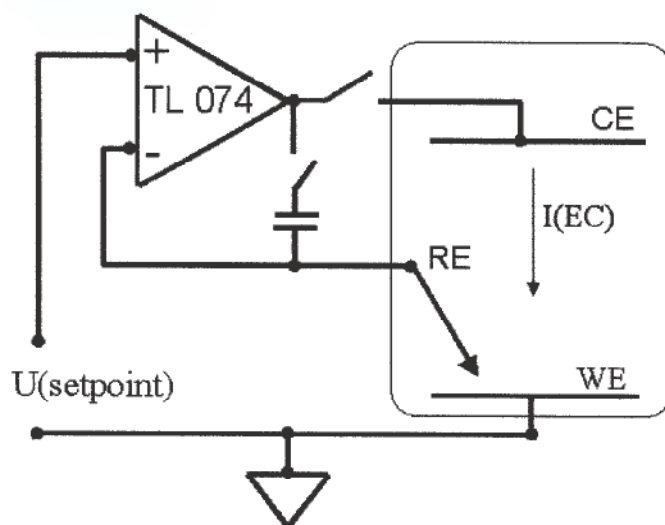

**Figure 6.2-1:** Simplified circuit of a potentiostat with working electrode (WE) on ground. Reference electrode (RE) and potentiostatic setpoint are fed to the inverting and noninverting input of an operational amplifier. The counter-electrode (CE) is connected to the output of the operational amplifier.  $I(EC)$ : electrochemical current.

The reference electrode (RE) is connected to the inverting input of an operational amplifier (for example: Texas Instruments TL 074), and the setpoint is applied between ground and the noninverting input of the operational amplifier. For electronic reasons Equation 6.2-1 applies.

$$U(CE) = F * [ U(RE) - U(setpoint) ] \quad (6.2-1)$$

F: amplification factor

As  $F$  has typical values from ca.  $10^6$ – $10^7$ , it follows  $U(RE) = U(setpoint)$ .

Good electrode contacts are required because of the high amplification factor, as any fluctuation would result in strong oscillations at the output of the OPA. To prevent such problems, a capacitor of roughly  $1 \mu F$  can be inserted between the reference electrode and the counter-electrode, thus damping such oscillations.  $U(setpoint)$  can be a constant voltage or any externally generated signal. In cyclic voltammetry, for example, a linearly varying potential is applied between an upper and a lower limit. If electrode reactions occur in the applied potential range, a current flows and can be plotted against the electrode potential, thus giving Cyclic Voltammograms (CVs). The currents are limited by kinetics or transport limitation, depending on the system, so that peak currents are observed, and these can be evaluated to provide insight into the electrochemical processes [3].

### 6.2.1.3 Electrodeposition of less noble elements

**Aluminium electrodeposition** Al electrodeposition from chloroaluminate ionic liquids has been investigated by several authors on different substrates by classical electrochemical methods, such as cyclic voltammetry, potential step experiments, and *ex situ* techniques [4–7]. In all cases, Al deposition was only observed in the acidic regime and the quality of the deposits was reported to be superior to those obtained from organic solutions. Deposition on substrates such as glassy carbon, tungsten, and platinum is preceded by a nucleation step and is electrochemically quasireversible (i.e., it is not solely diffusion-controlled; the charge-transfer reaction also plays an important role). On Pt, however, there are some hints from the published electrochemical data for underpotential phenomena. The bulk deposits of Al are rather granular and the current density has an influence on the size of the clusters, with a tendency to smaller crystals with higher current densities. If dry toluene [4] or benzene [8] are added to the liquid, mirror-bright deposits have been reported. It is likely that the organic molecules play the role of brighteners. Such effects have been known for a long time, and organic molecules such as crystal violet are widely used in aqueous electroplating processes to deposit shining layers of Cu, Ag, etc. [9]. The miscibility of the chloroaluminates with toluene, xylene, and other organic solvents has the further advantage that the liquid can easily be washed away from the samples after the electrodeposition had been performed, so that clean substrates can be prepared as easily as from aqueous solutions.

Although these chloroaluminate-based liquids will most probably not replace high-temperature molten salts for Al electrowinning purposes, they could become important in electroplating of Al and several Al alloys. We recently succeeded, with the aid of special electrochemical techniques and special bath compositions, in preparing high quality deposits of nanocrystalline metals such as Al with grain sizes down to only several nanometers [10]. Such nanocrystalline deposits are interesting as coatings for corrosion protection, for example.

**Electrodeposition of less noble elements and aluminium alloys** In technical processes, elements such as the alkali, the alkaline earth, the refractory, or the rare earth metals are obtained by high-temperature molten salt electrolysis [11, 12]. Eutectics of alkali halides are used as solvents in many cases, while in some cases – La and Ce, for example – the metal halides can be electrolyzed directly. The temperatures vary from about 450 °C to more than 1000 °C. On the one hand, these are pretty difficult experimental conditions: on the other hand, a high electronic conductivity is observed in many cases as soon as metal is deposited. Na dissolves easily in liquid NaCl, for example, and a nonmetal/metal transition is observed with rising Na content [13]. As a consequence, the current efficiency during electrolysis can reduce enormously due to a partial electronic short-circuit. Consequently, it would be interesting to apply low-melting ionic liquids for electrowinning or electroplating of these elements. To date, only a few examples have been deposited in elemental form from low-melting ionic liquids. In most cases the chloroaluminate systems

were employed, and some aluminium alloys with interesting properties have been reported in the literature.

#### *Sodium and Lithium*

Both sodium [14] and lithium [15] electrodeposition have been achieved in neutral chloroaluminate ionic liquids containing protons. These elements are interesting for Na- or Li-based secondary batteries in which the metals would serve directly as the anode material. The electrodeposition is not possible in basic or acidic chloroaluminate ionic liquids; only proton-rich NaCl- or LiCl-buffered neutral chloroaluminate liquids are feasible for the electrodeposition. The protons enlarge the electrochemical window towards the cathodic regime so that the alkali metal electrodeposition becomes possible. For Na, the proton source was dissolved HCl, introduced either in the gas phase or as [EMIM][HCl<sub>2</sub>]. For Li electrodeposition, triethanolamine hydrogen dichloride was also employed as proton source. Reversible deposition and stripping was reported for both alkali metals, on tungsten and stainless steel substrates, respectively.

#### *Gallium*

Elemental gallium can be electrodeposited both from chloroaluminate [16] and from chlorogallate [17] ionic liquids. In the latter case, [EMIM]Cl was mixed with GaCl<sub>3</sub>, thus giving an ionic liquid that was studied for GaAs thin film electrodeposition. In the chloroaluminates, Ga can be deposited from Lewis acidic systems. It was found that the electroreduction from Ga(III) first gives rise to Ga(I), and the elemental Ga then forms from Ga(I) upon further reduction. On glassy carbon the electrodeposition involves instantaneous three-dimensional nucleation with diffusion-controlled growth of the nuclei. No alloying with Al was reported if deposition of Ga was performed in the Ga(I) diffusion regime. Reproducible electrodeposition of Ga is a promising route for production of binary and ternary compound semiconductors. A controlled electrodeposition of GaX quantum dots (X = P, As, Sb) would be very attractive for nanotechnology.

#### *Iron*

The electrodeposition of iron was investigated in neutral and acidic chloroaluminates [18, 19]. Although iron can be deposited from certain aqueous solutions, ionic liquids offer the advantage of depositing it in high quality in elemental form without side reactions such as hydrogen evolution or oxidation by water if the potential control is switched off. This is an interesting feature, especially for nanotechnology, as iron is a magnetic material. It has been reported that elemental Fe can be reversibly deposited on several substrates, including tungsten or glassy carbon in acidic chloroaluminate liquids, although the electrode potential for its electrodeposition is very close to the Al deposition potential. The reduction can be performed, prior to the deposition of the element, either from FeCl<sub>3</sub> that is reduced to FeCl<sub>2</sub>, or directly from FeCl<sub>2</sub>. The fact that the electrode potentials for Al and Fe deposition are close together makes it possible to deposit Fe-Al alloys with interesting properties.

*Aluminium alloys with iron, cobalt, nickel, copper, and silver*

The bulk deposition of alloys from Al with Fe, Co, Ni, Cu, and Ag was recently investigated with electrochemical and *ex situ* analytical techniques [20]. The alloys were prepared under near steady-state, diffusion-controlled conditions. For  $\text{CoAl}_x$ ,  $\text{FeAl}_x$ , and  $\text{CuAl}_x$ , compositions with  $x \approx 1$  were obtained, while kinetic phenomena complicated a reliable analysis for  $\text{NiAl}_x$ . In the case of  $\text{AgAl}_x$ , the authors reported that analysis was precluded by a dendritic growth of the deposits. All of the alloy systems displayed complex electrodisolution, and the nature of the oxidation process was different for the alloys produced in specific potential regimes. However, one has to keep in mind that classical electrochemistry and *ex situ* analysis give mainly integral information on the deposits. Nanometer resolution in *ex situ* methods is not yet a straightforward procedure. Nevertheless, although the alloy deposition is obviously complicated, the results are quite interesting for the electrodeposition of thin alloy films, as alloys of Al with Fe, Ni, or Co could perhaps give magnetic nanostructures more stable than the respective elements.

*Aluminium alloys with niobium and tantalum*

Nb and Ta can be obtained in elemental form from high-temperature molten salts. Nb and Ta are widely used as coatings for corrosion protection, since they – like Al – form thin oxide layers that protect the underlying material from being attacked. In technical processes, several high-temperature molten salts are employed for electrocoating, and the morphology of the deposit is strongly influenced by the composition of the baths. Some attempts have been made to deposit Nb and Ta from ionic liquids [21, 22]. In [21] the authors focused on the electrodeposition of  $\text{AlNb}_x$  alloys from room-temperature ionic liquids containing both  $\text{AlCl}_3$  and chlorides of Nb. The authors reported that they obtained Nb contents of up to 29 wt-% in the deposits, at temperatures between 90 and 140 °C. In [22], chloroaluminate liquids were employed at room temperature and  $\text{AlNb}_x$  films could only be obtained if  $\text{NbCl}_5$  was prerduced in a chemical reaction. The authors reported that Nb powder is the most effective reducing agent for this purpose. Similar preliminary results have been obtained for Ta electrodeposition. Although it seems to be difficult to deposit pure Nb and Ta in low-melting ionic liquids, the alloys with Al could have quite interesting properties.

*Aluminium alloys with titanium*

Titanium is an interesting material for corrosion protection and lightweight construction. Hitherto it could only be deposited in high quality from high-temperature molten salts, although attempts have been made to deposit it from organic solutions and even aqueous media. In general, bulk electrodeposition of Ti is complicated because traces of water immediately form passivating oxide layers on Ti. Deposition of the element has also not yet been successful in ionic liquids. In a recent article [23], however, it was reported that  $\text{AlTi}_x$  alloys can be obtained from chloroaluminates. The corrosion resistance of the layers is reported to be superior to that of Al itself and seems to become even better with increasing Ti content. However, Ti was not deposited in elemental form without codeposition of Al. In chloroaluminates,



Al is more noble than Ti, and so at room temperature only codeposits and alloys can be obtained. Furthermore, kinetic factors also play a role in the electrodeposition of the element.

#### *Aluminium alloys with chromium*

The electrodeposition of Cr in acidic chloroaluminates was investigated in [24]. The authors report that the Cr content in the  $\text{AlCr}_x$  deposit can vary from 0 to 94 mol %, depending on the deposition parameters. The deposit consists both of Cr-rich and Al-rich solid solutions as well as intermetallic compounds. An interesting feature of these deposits is their high-temperature oxidation resistance, the layers seeming to withstand temperatures of up to 800 °C, so coatings with such an alloy could have interesting applications.

#### *Lanthanum and aluminium-lanthanum alloys*

It was quite recently reported that La can be electrodeposited from chloroaluminate ionic liquids [25]. Whereas only  $\text{AlLa}_x$  alloys can be obtained from the pure liquid, the addition of excess LiCl and small quantities of thionyl chloride ( $\text{SOCl}_2$ ) to a  $\text{LaCl}_3$ -saturated melt allows the deposition of elemental La, but the electrodisolution seems to be somewhat kinetically hindered. This result could perhaps be interesting for coating purposes, as elemental La can normally only be deposited in high-temperature molten salts, which require much more difficult experimental or technical conditions. Furthermore, La and Ce electrodeposition would be important, as their oxides have interesting catalytic activity as, for instance, oxidation catalysts. A controlled deposition of thin metal layers followed by selective oxidation could perhaps produce catalytically active thin layers interesting for fuel cells or waste gas treatment.

#### **6.2.1.4 Electrodeposition of metals that can also be obtained from water**

As already mentioned above, most of the metals that can be deposited from aqueous solutions can also be obtained from ionic liquids. One could reasonably raise the question of whether this makes sense, as aqueous solutions are much easier to handle. However, there are two properties of the ionic liquids that are superior to those of aqueous solutions. Firstly, their electrochemical windows are much wider, so that side reactions during electrodeposition can easily be prevented. Whereas palladium, for example, can give brittle deposits in aqueous media due to hydrogen evolution and dissolution of hydrogen in the metal, shining, nanosized deposits can be obtained in ionic liquids [10]. Secondly, the temperature can be varied over a wide range, in some cases more than 400 °C. In general, variation of the temperature has a strong effect on the kinetics of the deposition and on the surface, as well as on the interface mobility of the deposits. Although there are no systematic studies on temperature variation upon electrodeposition in ionic liquids, this is an attractive research field, as there would be a certain link to the classical high-temperature molten salts.

**Indium and antimony** The electrodeposition of In on glassy carbon, tungsten, and nickel has been reported [26]. In basic chloroaluminates, elemental indium is



formed in one three-electron reduction step from the  $[\text{InCl}_5]^{2-}$  complex, but  $\text{In(I)}$  species have also been reported [27]. The overpotential deposition involves progressive three-dimensional nucleation on a finite number of active sites on carbon and tungsten, while on nickel progressive three-dimensional nucleation is observed. Electrodeposition of  $\text{In}$  from acidic melts is reported not to occur, but liquids based on  $\text{InCl}_3$  and organic salts were successfully used to deposit  $\text{InSb}$  [27, 28].  $\text{Sb}$  electrodeposition on tungsten, platinum, and glassy carbon has been reported by Osteryoung et al. [29, 30]. The metal can be deposited from acidic melts, but partly irreversible behavior is observed. Unpublished data by C. Hussey [31] confirm this interesting behavior. Both passivation phenomena and reactions of the deposits with the metal substrates could play a role, and so *in situ* STM studies would be of great interest in order to elucidate the processes at the electrode surface. If the electrode processes were known in detail, definite  $\text{InSb}$  layers or nanosized  $\text{InSb}$  quantum dots could perhaps be made by simultaneous electrodeposition (see below).  $\text{InSb}$  is a direct semiconductor, and quantum dots of  $\text{InSb}$ , made under ultra-high vacuum conditions, have already been successfully studied for laser applications [32]. Quantum dots are widely under investigation nowadays and this is a rapidly growing research field. Definite electrodeposition from ionic liquids would be an important contribution.

**Tellurium and cadmium** Electrodeposition of  $\text{Te}$  has been reported [33]: in basic chloroaluminates the element is formed from the  $[\text{TeCl}_6]^{2-}$  complex in one four-electron reduction step. Furthermore, metallic  $\text{Te}$  can be reduced to  $\text{Te}^{2-}$  species. Electrodeposition of the element on glassy carbon involves three-dimensional nucleation. A systematic study of the electrodeposition in different ionic liquids would be of interest because – as with  $\text{InSb}$  – a defined codeposition with cadmium could produce the direct semiconductor  $\text{CdTe}$ . Although this semiconductor can be deposited from aqueous solutions in a layer-by-layer process [34], variation of the temperature over a wide range would be interesting since the grain sizes and the kinetics of the reaction would be influenced.

Electrodeposition of  $\text{Cd}$  has also been reported [35, 36]. In [35],  $\text{CdCl}_2$  was used to buffer neutral chloroaluminate liquids from which the element could be deposited. In an interesting recent work [36], a  $[\text{EMIM}][\text{BF}_4]$  ionic liquid with added  $[\text{EMIM}]\text{Cl}$  was successfully used to deposit  $\text{Cd}$ . It is formed on platinum, tungsten, and glassy carbon from  $\text{CdCl}_4^{2-}$  in a quasireversible two-electron reduction process. This result is promising, as  $\text{Te}$  might perhaps also be deposited from such an ionic liquid, thus possibly giving a system for direct  $\text{CdTe}$  electrodeposition.

**Copper and silver** Electrodeposition of  $\text{Cu}$  in the chloroaluminate liquids has been widely investigated. It has been reported to be deposited from acidic liquids only, and it also shows some interesting deviations from its behavior in aqueous solutions. If  $\text{CuCl}_2$  is added to an acidic liquid,  $\text{Cu(II)}$  undergoes two one-electron reduction steps on glassy carbon and on tungsten [37, 38]; in the first step  $\text{Cu(I)}$  is formed, in the second step the metal deposits. At high overvoltages for the deposi-

tion, an alloying with Al begins [39]. The electrodeposition of Cu from a  $[\text{BF}_4]^-$  liquid has been investigated [40] on polycrystalline tungsten, on platinum, and on glassy carbon. On Pt, UPD phenomena were reported, whereas on tungsten and glassy carbon only OPD was apparent. *Ex situ* analysis proved that the deposit was composed solely of copper.

The electrodeposition of Ag has also been intensively investigated [41–43]. In the chloroaluminates – as in the case of Cu – it is only deposited from acidic solutions. The deposition occurs in one step from Ag(I). On glassy carbon and tungsten, three-dimensional nucleation was reported [41]. Quite recently it was reported that Ag can also be deposited in a one-electron step from tetrafluoroborate ionic liquids [43]. However, the charge-transfer reaction seems to play an important role in this medium and the deposition is not as reversible as in the chloroaluminate systems.

**Nickel and cobalt** Nickel and cobalt have been intensively investigated in aqueous solutions. Both of these metals are interesting for nanotechnology, as magnetic nanostructures can be formed in aqueous solutions [44]. However, their bulk electrodeposition is accompanied by hydrogen evolution. Both elements can also be deposited from acidic chloroaluminate liquids [45, 46]. The main literature interest is devoted to alloys with aluminium, as such deposits also show magnetic behavior. Recent *in situ* STM studies have shown that on Au(111) in the underpotential regime, one Ni monolayer exhibiting an  $8 \times 8$  Moiré superstructure is formed. Furthermore, island growth along the steps starts in the UPD regime [47]. *In situ* scanning tunneling spectroscopy has shown that the tunneling barrier is significantly reduced on going from Ni to  $\text{Ni Al}_x$  clusters [48].

**Palladium and gold** Palladium electrodeposition is of special interest for catalysis and for nanotechnology. It has been reported [49] that it can be deposited from basic chloroaluminate liquids, while in the acidic regime the low solubility of  $\text{PdCl}_2$  and passivation phenomena complicate the deposition. In our experience, however, thick Pd layers are difficult to obtain from basic chloroaluminates. With different melt compositions and special electrochemical techniques at temperatures up to 100 °C we succeeded in depositing mirror-bright and thick nanocrystalline palladium coatings [10].

Gold electrodeposition has been reported [50, 51] from chloroaluminate-based liquids and from a liquid made of an organic salt and  $\text{AuCl}_3$ . Although high quality gold can be electrodeposited from aqueous solutions, the latter result is especially interesting with respect to the deposition of unusual alloys between gold and less noble elements.

**Zinc and tin** The electrodeposition of Zn [52] has been investigated in acidic chloroaluminate liquids on gold, platinum, tungsten, and glassy carbon. On glassy carbon only three-dimensional bulk deposition was observed, due to the metal's underpotential deposition behavior. At higher overvoltages, codeposition with Al

has been reported. As Zn is widely used in the automobile industry for corrosion protection, a codeposition with Al could also be interesting for selected applications. Tin has been electrodeposited from basic and acidic chloroaluminate liquids on platinum, gold, and glassy carbon [53]. On Au the deposition starts in the UPD regime and, from the electrochemical data, one monolayer was reported. Furthermore there seems to be some evidence for alloying between Sn and Au. On glassy carbon three-dimensional growth of Sn occurs.

#### 6.2.1.5 Electrodeposition of semiconductors

Many studies on semiconductor electrodeposition have in the past been performed in different solutions, such as aqueous media, organic solutions, molten salts, and also a few ionic liquids. A good overview on the topic in general is presented in ref. [54]. To date, however, industrial procedures have not yet been established. In addition to bulk deposits of semiconductors for photovoltaic applications, thin layers or quantum dots would be of great interest both in basic research and in nanotechnology. Hitherto, most basic studies on semiconductor formation and characterization have been performed under UHV conditions. Molecular Beam Epitaxy is a widely used method for such purposes. In technical processes, Chemical or Physical Vapor Deposition are still the methods of the greatest importance. Although high quality deposits can be obtained, such processes are cost-intensive and the layers are consequently expensive. A simple and cheaper electrodeposition would surely be of commercial interest. Work by Stickney [34] has shown that Electrochemical Atomic Layer Epitaxy (ECALE) in aqueous media is a suitable deposition method for compound semiconductors with qualities comparable to those made by vacuum techniques. In special electrochemical polarization routines the elements of a compound semiconductor are successively deposited one onto the other, layer-by-layer. Unfortunately, direct electrodeposition of CdTe, CdSe, and others is difficult for kinetic reasons, and in many cases the elements are codeposited together with the desired semiconductor in varying amounts at room temperature. Variation of the temperature can strongly affect the quality of the electrodeposits [55]. In general, direct deposition of a compound semiconductor would be interesting as it would be less time-consuming than the elegant ECALE process. Although there are only a few articles on semiconductor electrodeposition from ionic liquids, these media are interesting for such studies for several reasons: the acidity can be varied over wide ranges, they have low vapor pressures, and as a consequence – depending on the system – the temperature can be varied over several hundred degrees, so that kinetic barriers in compound formation can be overcome. Furthermore, because of the wide electrochemical windows, it is possible to obtain compounds that are inaccessible from aqueous solutions, one example being GaAs. For GaSb, InSb, InP, and ternary compound semiconductors, electrodeposition from ionic liquids could be interesting, especially if higher temperatures were applied. As well as the compound semiconductors, elemental semiconductors can also be obtained from ionic liquids. Si and Ge are widely used as wafer material for different electronic applications, and junctions of n- and p-doped Si are still interesting for photovoltaic applications. Controlled electrodeposition of both elements and their mixtures

would also surely be attractive for nanotechnology, as Ge quantum dots made under UHV conditions show interesting photoluminescence.

**GaAs** The direct electrodeposition of GaAs from ionic liquids has been studied mainly by two groups. Wicelinski et al. [56] used an acidic chloroaluminate liquid at 35–40 °C to codeposit Ga and As. However, it was reported that Al underpotential deposition on Ga occurs. Verbrugge and Carpenter employed an ionic liquid based on GaCl<sub>3</sub> to which AsCl<sub>3</sub> had been added [17, 57]. Unfortunately, the quality of the deposits in these studies was not convincing, and both pure arsenic and gallium could be found in the deposits. Nevertheless, this route is promising for the electrodeposition of Ga-based semiconductors, as thermal annealing could improve the quality of the deposits.

**InSb** The principal of InSb electrodeposition is the same as for GaAs. An ionic liquid based on InCl<sub>3</sub> is formed, to which SbCl<sub>3</sub> is added [27, 28]. At 45 °C, InSb can be directly electrodeposited, but elemental In and Sb are also reported to co-deposit. The In/Sb ratio depends strongly on the deposition potential. Despite some problems, the authors of these studies are optimistic that ionic liquids based on GaCl<sub>3</sub> and InCl<sub>3</sub> may also be useful for depositing ternary compound semiconductors such as AlGaAs and InGaSb.

**ZnTe** The electrodeposition of ZnTe was published quite recently [58]. The authors prepared a liquid that contained ZnCl<sub>2</sub> and [EMIM]Cl in a molar ratio of 40:60. Propylene carbonate was used as a co-solvent, to provide melting points near room temperature, and 8-quinolinol was added to shift the reduction potential for Te to more negative values. Under certain potentiostatic conditions, stoichiometric deposition could be obtained. After thermal annealing, the band gap was determined by absorption spectroscopy to be 2.3 eV, in excellent agreement with ZnTe made by other methods. This study convincingly demonstrated that wide band gap semiconductors can be made from ionic liquids.

**Germanium** In situ STM studies on Ge electrodeposition on gold from an ionic liquid have quite recently been started at our institute [59, 60]. In these studies we used dry [BMIM][PF<sub>6</sub>] as a solvent and dissolved GeI<sub>4</sub> at estimated concentrations of 0.1–1 mmol l<sup>-1</sup>, the substrate being Au(111). This ionic liquid has, in its dry state, an electrochemical window of a little more than 4 V on gold, and the bulk deposition of Ge started several hundreds of mV positive from the solvent decomposition. Furthermore, distinct underpotential phenomena were observed. Some insight into the nanoscale processes at the electrode surface is given in Section 6.2.2.3.

## 6.2.2

**Nanoscale Processes at the Electrode/Ionic Liquid Interface**6.2.2.1 **General considerations**

*In situ* STM studies on electrochemical phase formation from ionic liquids were started in the author's group five years ago. On the one hand there was no knowledge of the local processes of phase formation in ionic liquids and molten salts. On the other hand – thanks to their wide electrochemical windows – these systems offered access to elements that cannot be obtained from aqueous solutions. In the rapidly growing field of nanotechnology, in which semiconductor nanostructures will play an important role, we see great opportunity for electrodeposition of nanostructures from ionic liquids. It is known that germanium quantum dots on silicon made by Molecular Beam Epitaxy under UHV conditions display an interesting photoluminescence around 1 eV [61]. Furthermore, lasers based on compound semiconductor quantum dots such as InSb have been discussed in the literature [32]. Although UHV conditions are straightforward in basic research, a possible nanotechnological process would be relatively complicated and presumably expensive. An electrochemical routine would therefore be preferred if comparable results could be obtained. For this purpose, the electrochemical processes and other factors influencing the deposition and the stability of the structures have to be understood on the nanometer scale.

6.2.2.2 **The scanning tunneling microscope**

The main technique employed for *in situ* electrochemical studies on the nanometer scale is the Scanning Tunneling Microscope (STM), invented in 1982 by Binnig and Rohrer [62] and combined a little later with a potentiostat to allow electrochemical experiments [63]. The principle of its operation is remarkably simple, a typical simplified circuit being shown in Figure 6.2-2.

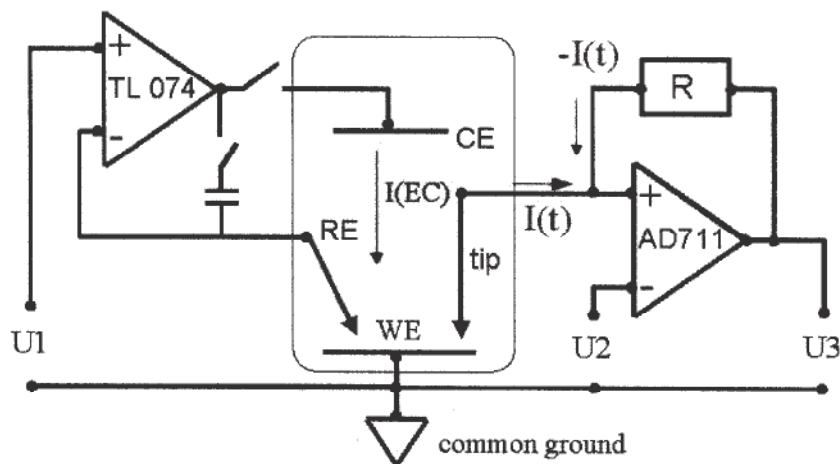

**Figure 6.2-2:** Simplified circuit of an electrochemical STM setup. In addition to the potentiostat (see Figure 6.2.1), an STM preamplifier is added, to which the tip is connected.  $U_1$ : potentiostatic setpoint,  $U_2$ : tunneling voltage,  $I(t)$ : tunneling current,  $U_3 = -R I(t)$ .



The left side is essentially identical to the potentiostat circuit presented in Section 6.2.1.2.. The right side is the preamplifier of the STM. The atomically sharp metal tip is located roughly 1 nm over an electronically conductive substrate, here the working electrode (WE) of interest. This is done by computer control, with the help of step motors and micrometer screws as well as piezoelectric elements, to which the tip is connected. If a potential  $U_2$  is applied between tip and sample (typically 5–500 mV) a tunneling current  $I(t)$  flows, with typical values between 0.1 and 10 nA, depending on the distance. This current is transformed into a voltage  $U_3 (= -R \cdot I(t))$  that can be further processed. The tunneling current is strongly dependent on the distance ( $d$ ) and is a function of the electronic density of states of tip  $D$  (tip) and sample  $D$  (sample). For a strongly simplified case one obtains to a first approximation Equation 6.2-2 [64]:

$$I(\text{tunnel}) = f(U \text{ bias}) * D(\text{tip}) * D(\text{sample}) * \exp[- \text{const.} * d] \quad (6.2-2)$$

Because of this strong distance dependence, local height changes can in principle be detected in the picometer range. There are two modes of operation. In the “Constant Height Mode” the tip is scanned over the surface at a constant height and the local changes of the tunneling current are acquired. In the “Constant Current Mode” the distance between the tip and the sample is kept constant by feedback electronics. It works such that  $U_3$  is amplified and finally fed back through an adding amplifier to the piezo control. It is also clear that the STM tip acts as an electrode in the electrochemical cell. As soon as a voltage is applied to the tip, a current can flow. Such Faradaic currents (the deposition of metal, or hydrogen or oxygen evolution, for example) can easily reach some hundreds of nanoamperes. Macroscopically this is negligible but, as the tunneling currents are only some nanoamperes, the tip has to be insulated – with the exception of its very end – by a paint or by glass. Hence, the Faradaic currents can be reduced down to the picoampere range, making stable tunneling conditions under electrochemical conditions possible.

### 6.2.2.3 Results

**Aluminium electrodeposition on Au(111)** The processes during electrodeposition of aluminium have been investigated on the nanometer scale [65]. As already pointed out in preceding sections, Al is an important metal for various applications in technical processes. In order to obtain insight into the growth of the metal and to understand the initial stages of the phase formation, *in situ* STM experiments were performed under electrochemical conditions during electroreduction of  $\text{AlCl}_3$  in an acidic  $[\text{BMIM}]\text{Cl}/\text{AlCl}_3$  ionic liquid. This liquid is extremely corrosive and we had to build our own STM heads to allow measurements under inert gas conditions. The cyclic voltammogram on Au(111) shows several UPD processes and one OPD process, as can be seen in Figure 6.2-3.

Gold oxidation starts at electrode potentials  $> +1200$  mV vs.  $\text{Al}/\text{AlCl}_3$ , first at the steps between different terraces. At higher potentials pits are formed, rapidly resulting in complete disintegration of the substrate.



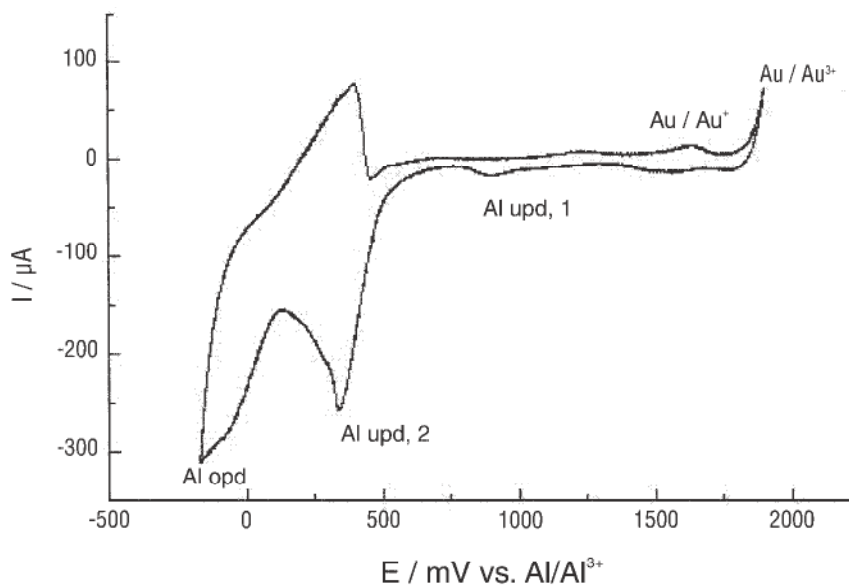

**Figure 6.2-3:** Cyclic voltammogram of acid  $[\text{BMIM}]^+\text{Cl}^-/\text{AlCl}_3$  on Au(111): Au oxidation begins at electrode potentials  $> +1.2$  V vs.  $\text{Al}/\text{AlCl}_3$ . UPD processes are observed at about +900 and +400 mV before bulk deposition of Al starts (see also [65]).

The following electrode processes at the surfaces have been identified during electrodeposition. Upon a potential step from  $E > +1000$  mV to  $E = +950$  mV vs.  $\text{Al}/\text{AlCl}_3$ , two-dimensional islands formed irreversibly on the surface. Their height was  $250 \pm 20$  pm, indicative of gold islands. We attributed this observation to the formation of Au–Al compounds followed by expulsion of surplus Au atoms to the surface. At an electrode potential of +400 mV, small Al islands with an averaged height of  $230 \pm 20$  pm started growing (Figure 6.2-4).

At +100 mV vs.  $\text{Al}/\text{AlCl}_3$ , clusters of up to 1 nm in height formed. When a potential step to +1100 mV vs.  $\text{Al}/\text{AlCl}_3$  was performed, the clusters dissolved immediately, but both holes and gold islands of up to two monolayers in height remained on the surface. It is likely that strong alloying between Au and Al took place both in the surface and in the deposited clusters (Figure 6.2-5).

In the overpotential deposition regime we observed that nanosized Al was deposited in the initial stages. Furthermore, a transfer of Al from the scanning tip to the Al covered substrate was observed. We accidentally succeeded in an indirect tip-induced nanostructuring of Al on growing Al (Figure 6.2-6).

These results are quite interesting. The initial stages of Al deposition result in nanosized deposits. Indeed, from the STM studies we recently succeeded in making bulk deposits of nanosized Al with special bath compositions and special electrochemical techniques [10]. Moreover, the preliminary results on tip-induced nanostructuring show that nanosized modifications of electrodes by less noble elements are possible in ionic liquids, thus opening access to new structures that cannot be made in aqueous media.

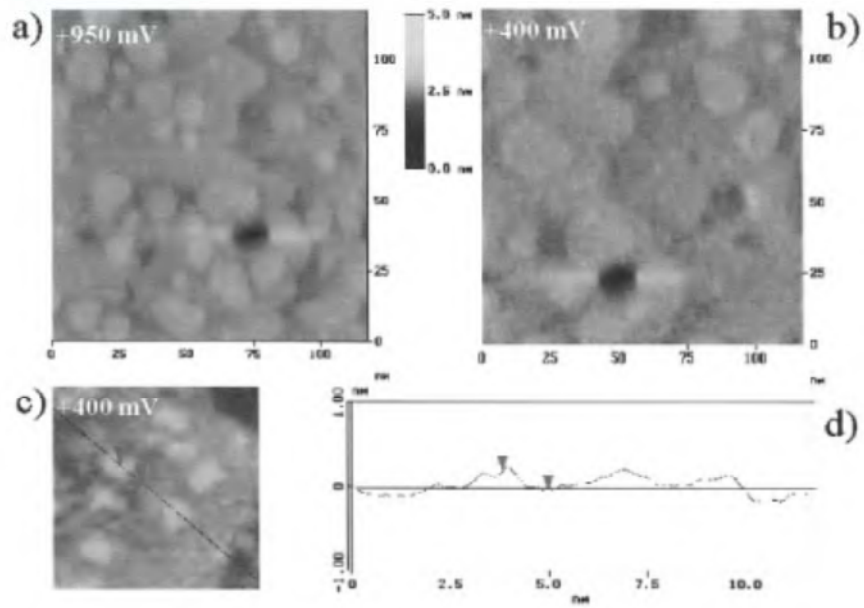

Figure 6.2-4

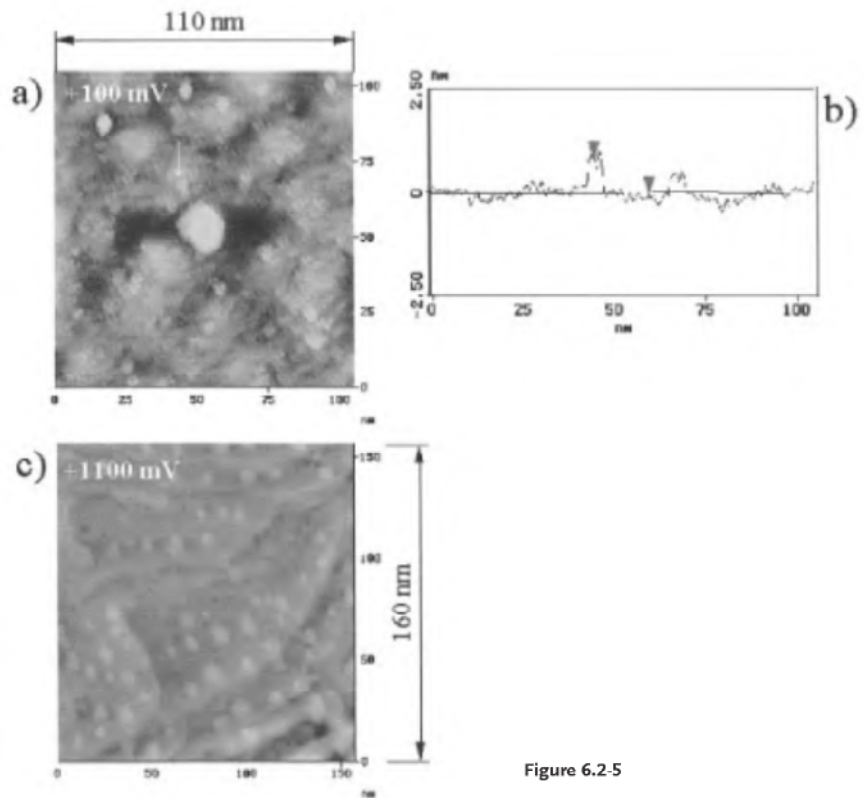

Figure 6.2-5

**Figure 6.2-4:** Underpotential phenomena during Al reduction in acidic [BMIM]<sup>+</sup>Cl<sup>-</sup>/AlCl<sub>3</sub> on Au(111). At +950 mV vs. Al/AlCl<sub>3</sub>, two-dimensional islands with a height of 250 ± 20 pm form (a). At +400 mV (b), two-dimensional Al islands with an averaged height of 230 ± 20 pm are reversibly deposited. In (c) the islands are shown with a higher resolution, while (d) shows a typical height profile.

**Figure 6.2-5:** Underpotential phenomena during Al reduction in acidic [BMIM]<sup>+</sup>Cl<sup>-</sup>/AlCl<sub>3</sub> on Au(111): nanoclusters with heights of up to 1 nm form at +100 mV vs. Al/AlCl<sub>3</sub> (a); a typical height profile is shown in (b). Upon a potential step to +1100 mV vs. Al/AlCl<sub>3</sub> the clusters dissolve immediately and leave holes in the surfaces as well as small Au islands (c): alloying between Al and Au is very likely.

**Copper electrodeposition on Au(111)** Copper is an interesting metal and has been widely investigated in electrodeposition studies from aqueous solutions. There are numerous publications in the literature on this topic. Furthermore, technical processes to produce Cu interconnects on microchips have been established in aqueous solutions. In general, the quality of the deposits is strongly influenced by the bath composition. On the nanometer scale, one finds different superstructures in the underpotential deposition regime if different counter-ions are used in the solutions. A co-adsorption between the metal atoms and the anions has been reported. In the underpotential regime, before the bulk deposition begins, one Cu monolayer forms on Au(111) [66].

*In situ* STM experiments in an acidic [BMIM]Cl/AlCl<sub>3</sub> ionic liquid with either CuCl or CuCl<sub>2</sub> as copper sources have recently been carried out in the author's group [67]. The motivation was based mainly on two facts: copper in chloroaluminates is deposited from Cu(I), and Cu<sup>+</sup> can furthermore be regarded as a naked cation because there is no distinct solvation shell, unlike in aqueous media. As a consequence, distinct deviations from the behavior in aqueous solutions were expected. The cyclic voltammogram on Au(111) displayed three UPD processes, followed by three-dimensional Cu growth in the OPD regime. At potentials > +1000 mV vs. Cu/Cu<sup>+</sup>, gold oxidation starts first at the steps, at higher electrode potentials bulk oxidation of gold begins (Figure 6.2-7).

The following two pictures (Figure 6.2-8a and b) were acquired at +500 mV and at +450 mV vs. Cu/Cu<sup>+</sup> and show that at +450 mV vs. Cu/Cu<sup>+</sup> monolayer high Cu clusters nucleate at the steps between different Au terraces. Thus, the pair of shoulders in the cyclic voltammogram is correlated with this surface process.

If the electrode potential is further reduced to +350 mV, a hexagonal superstructure with a periodicity of 2.4 ± 0.2 nm is observed. With respect to the interatomic distances in the Au(111) structure at the surface, this corresponds – within the error limits – to an 8 × 8 superstructure (Figure 6.2-9).

The integrated charge would correspond to 0.7 ± 0.1 Cu monolayers. Thus, either a less closely packed Cu layer or an anion co-adsorption that can both lead to a Moiré superstructure are probed; in the solution investigated [Al<sub>2</sub>Cl<sub>7</sub>]<sup>-</sup> is the predominant anion. At +200 mV vs. Cu/Cu<sup>+</sup> the superstructure disappears and a completely closed Cu monolayer is observed, with a charge corresponding to 1.0 ± 0.1 Cu monolayers.

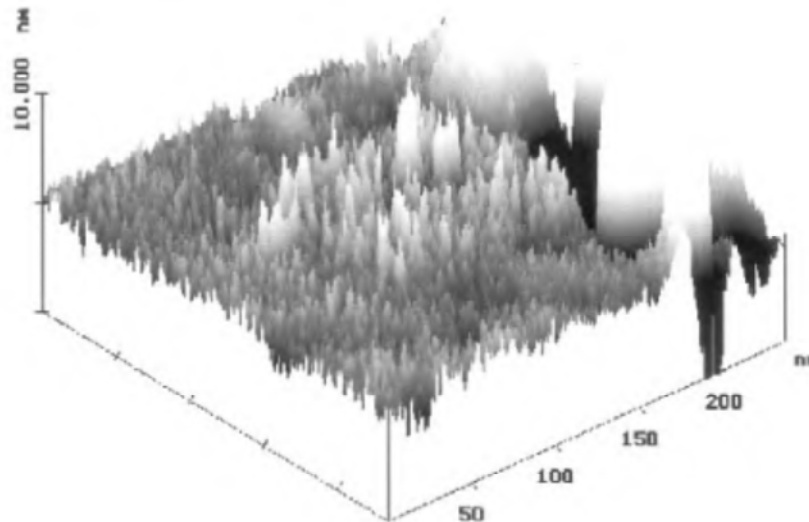

**Figure 6.2-6:** The initial stages of Al overpotential deposition result in nanosized deposits. A jump to contact transfer of Al from the scanning tip to the growing Al was observed (picture from [65] – with permission of the Pccp owner societies).

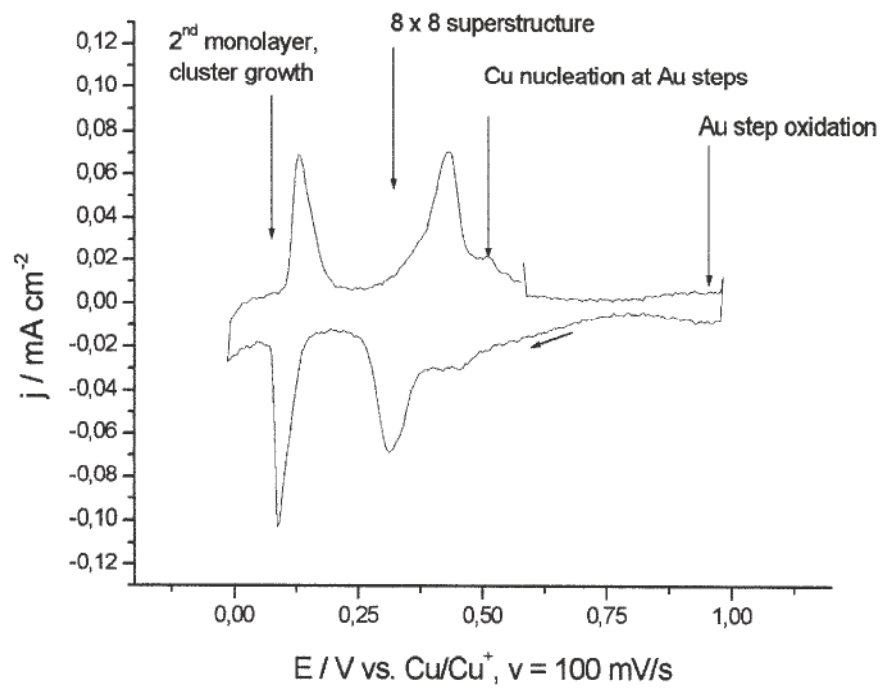

**Figure 6.2-7:** Cyclic voltammogram of CuCl in acidic  $[\text{BMIM}]^+\text{Cl}^-/\text{AlCl}_3$  on Au(111): three UPD processes are observed, correlated with decoration of Au steps by copper, formation of an  $8 \times 8$  superstructure followed by a Cu monolayer. Before the bulk deposition a second monolayer grows together with clusters

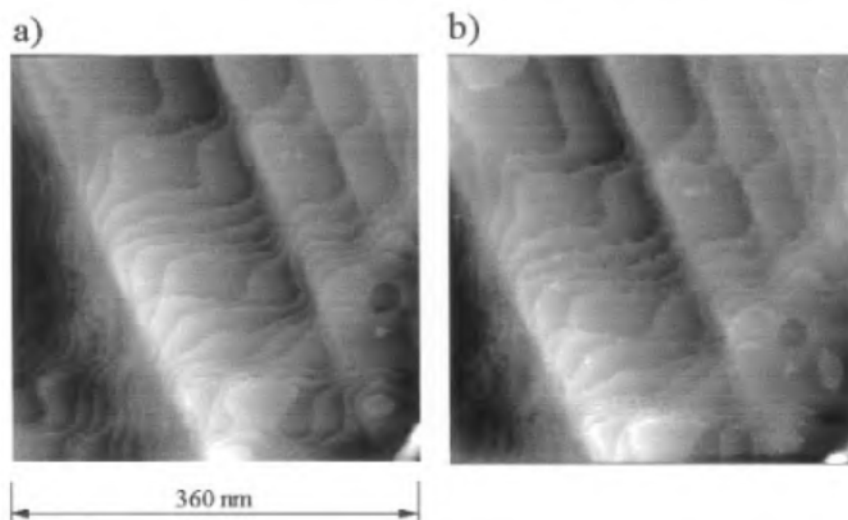

**Figure 6.2-8:** Underpotential phenomena during Cu reduction in acidic  $[\text{BMIM}]^+\text{Cl}^-/\text{AlCl}_3$  on Au(111): a potential step from +500 mV vs.  $\text{Cu}/\text{Cu}^+$  (a) to +450 mV results in the growth of small Cu islands at the steps of the gold terraces (b) (picture from [66] – with permission of the Pccp owner societies).

Unlike the case in aqueous solutions, the growth of a second  $200 \pm 20$  pm high monolayer at +50 mV was observed, together with clusters of heights up to 1 nm (Figure 6.2-10).

This result is quite surprising, as no second Cu monolayer has yet been reported in aqueous solutions, nor have clusters up to 1 nm in height in the UPD regime. It

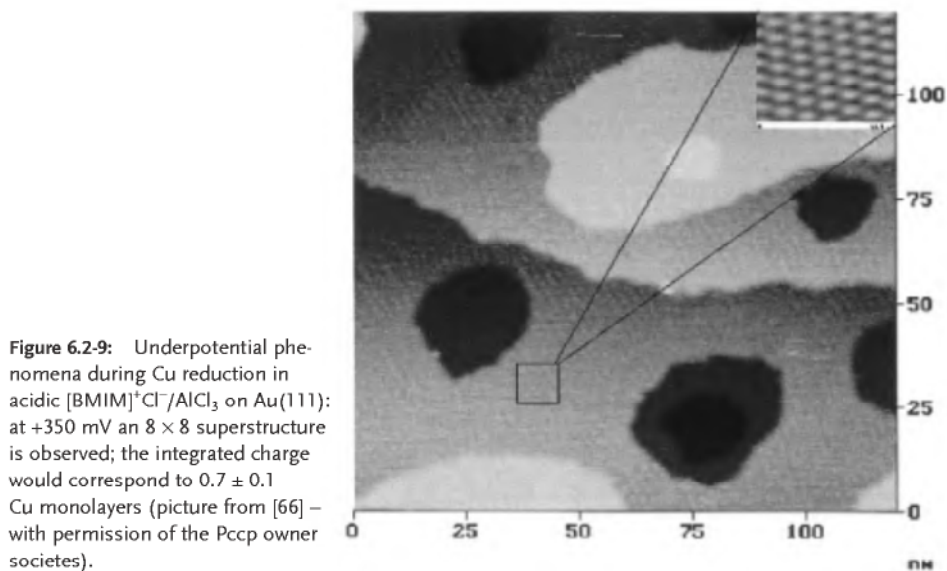

**Figure 6.2-9:** Underpotential phenomena during Cu reduction in acidic  $[\text{BMIM}]^+\text{Cl}^-/\text{AlCl}_3$  on Au(111): at +350 mV an  $8 \times 8$  superstructure is observed; the integrated charge would correspond to  $0.7 \pm 0.1$  Cu monolayers (picture from [66] – with permission of the Pccp owner societies).

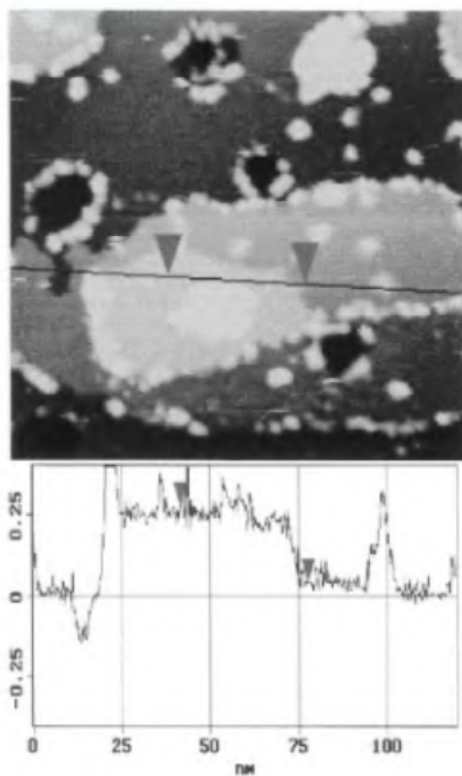

**Figure 6.2-10:** Underpotential phenomena during Cu reduction in acidic  $[\text{BMIM}]^+\text{Cl}^-/\text{AlCl}_3$  on Au(111): at +50 mV a second monolayer with a height of  $200 \pm 20$  pm grows, together with a pronounced deposition of clusters containing Cu and perhaps also a small amount of Al (picture from [66] – with permission of the Pccp owner societies).

cannot be excluded completely here that the clusters as well as the second monolayer could contain a small amount of Al. Such an underpotential alloying could stabilize the clusters enormously, especially as several stoichiometric Al-Cu compounds are known.

In the OPD regime, finally, the Cu bulk phase starts growing.

**Germanium electrodeposition on Au(111)** As a third example of *in situ* STM results, the electrodeposition of germanium should be mentioned here [59,60]. Germanium is an elemental semiconductor with a bandgap of 0.67 eV. In contrast to those of metals, furthermore, its crystal structure is determined by the tetrahedral symmetry of the Ge atoms, so that the diamond structure is thermodynamically the most stable. As the chemistry of Si and Ge are quite similar, such experiments could also give some insight into deposition process of the less noble Si. Germanium is hard to obtain in aqueous solutions, as its deposition potential is very close to that of hydrogen evolution. However, the ionic liquid  $[\text{BMIM}][\text{PF}_6]$  (and others) can easily be prepared with water levels below 20 ppm and is therefore ideally suited for such electrodeposition studies. The pure liquid shows only capacitive behavior on Au(111), as can be seen in the cyclic voltammogram (Figure 6.2-11), acquired with a scan rate of 1 mV/s under inert gas conditions.



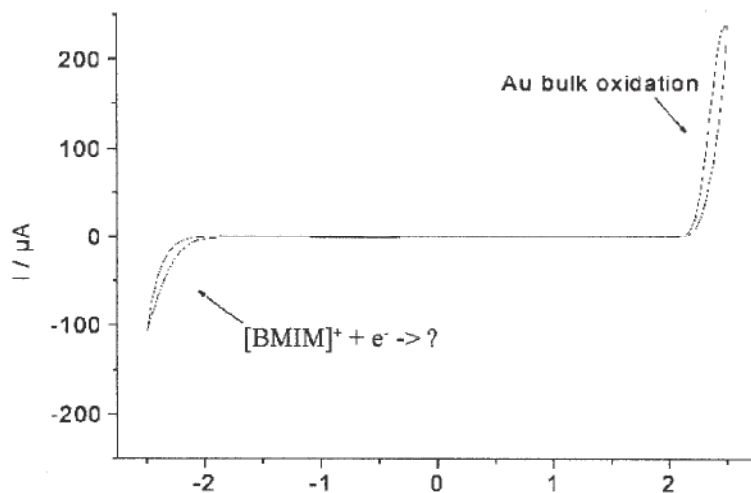

Figure 6.2-11: Cyclic voltammogram of dry  $[\text{BMIM}]^+ \text{PF}_6^-$  on Au(111): between the anodic and the cathodic limits only capacitive currents flow: an electrochemical window of a little more than 4 V is obtained (picture from [59] – with permission of the Pccp owner societies).

If  $\text{GeI}_4$  is added in an estimated concentration between  $0.1$  and  $1 \text{ mmol dm}^{-3}$ , several processes are observed in the cyclic voltammogram (Figure 6.2-12).

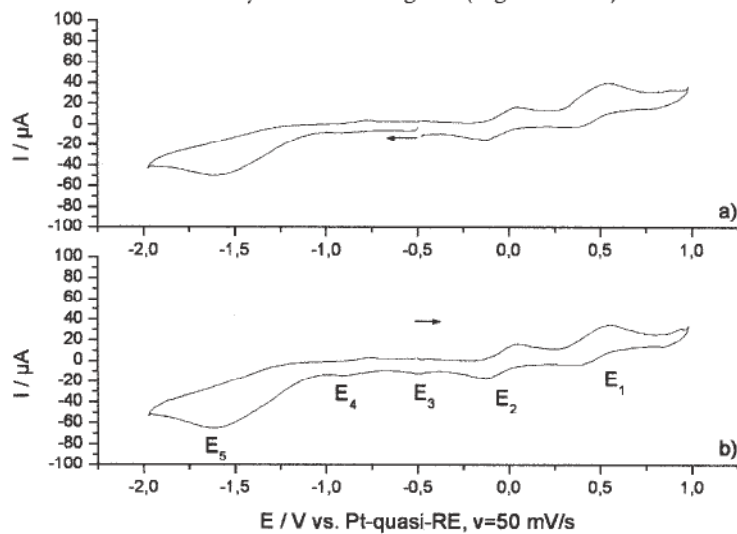
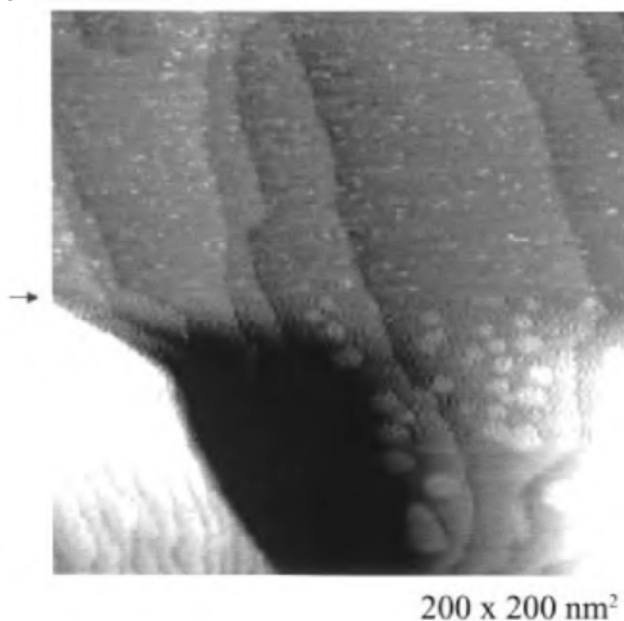

Figure 6.2-12: Cyclic voltammogram of  $0.1 - 1 \text{ mmol dm}^{-3} \text{GeI}_4$  on gold in dry  $[\text{BMIM}]^+ \text{PF}_6^-$ , starting at  $-500 \text{ mV}$  towards cathodic (a) and anodic (b) regime. Two quasireversible ( $E_1$  and  $E_2$ ) and two apparently irreversible ( $E_4$  and  $E_5$ ) diffusion-controlled processes are observed.  $E_3$  is correlated with the growth of two-dimensional islands on the surface,  $E_4$  and  $E_5$  with the electrodeposition of germanium,  $E_2$  with gold step oxidation, and  $E_1$  probably with the iodine/iodide couple. Surface area:  $0.5 \text{ cm}^2$  (picture from [59] – with permission of the Pccp owner societies).

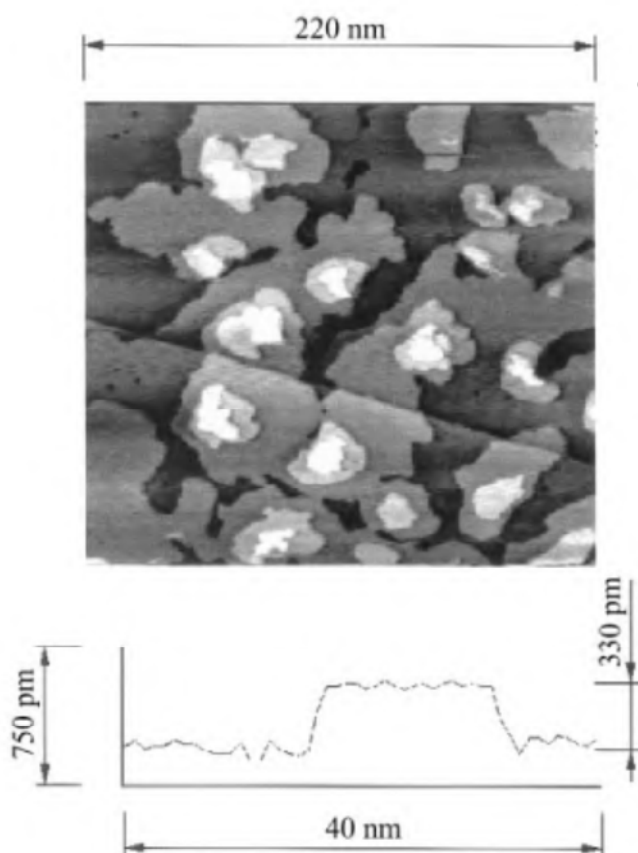

**Figure 6.2-13:** UPD phenomena of Ge on Au(111) in dry [BMIM]<sup>+</sup> PF<sub>6</sub><sup>-</sup>: two-dimensional islands with an average height of  $250 \pm 20$  pm start growing upon a potential step from the open circuit potential to  $-500$  mV vs. the Pt quasi reference electrode (picture from [59] – with permission of the Pccp owner societies).

The electrode process at  $-500$  mV on this potential scale is correlated to the growth of  $250 \pm 20$  pm high islands. They grow immediately upon a potential step from the open circuit potential to  $-500$  mV (arrow in Figure 6.2-13).

They form a monolayer that is rich in defects, but no second monolayer is observed. The interpretation of these results is not straightforward; from a chemical point of view both the electrodeposition of low-valent  $\text{Ge}_x\text{I}_y$  species and the formation of Au-Ge or even  $\text{Au}_x\text{Ge}_y\text{I}_z$  compounds are possible. A similar result is obtained if the electrodeposition is performed from  $\text{GeCl}_4$ . There,  $250 \pm 20$  pm high islands are also observed on the electrode surface. They can be oxidized reversibly and disappear completely from the surface. With  $\text{GeI}_4$  the oxidation is more complicated, because the electrode potential for the gold step oxidation is too close to that of the island electrodisolution, so that the two processes can hardly be distinguished. The gold step oxidation already occurs at  $+10$  mV vs. the former open circuit potential, at  $+485$  mV the oxidation of iodide to iodine starts.

In the reductive regime, a strong, apparently irreversible, reduction peak is observed, located at  $-1510$  mV vs. the quasi reference electrode used in this system. With *in situ* STM, a certain influence of the tip on the electrodeposition process was observed. The tip was therefore retracted, the electrode potential was set to  $-2000$  mV, and after two hours the tip was reapproached. The surface topography that we obtained is presented in Figure 6.2-14.



**Figure 6.2-14:** Bulk deposition of Ge on Au(111) in dry [BMIM]<sup>+</sup>PF<sub>6</sub><sup>-</sup> at -2000 mV terraces with an average height of  $330 \pm 30$  pm, indicative of Ge(111) bilayers, are obtained.

The surface consists of terraces of a height of  $330 \pm 30$  pm. Within error limits, this is the value that would be expected for Ge(111) bilayers. Furthermore, we were able to observe that the electrodeposition gave rise to a less ordered surface structure with nanoclusters, transforming over a timescale of about 1 hour into a layered structure. With GeBr<sub>4</sub> a transformation of clusters into such a layered surface was only partly seen; with GeCl<sub>4</sub> this transformation could not be observed.

The oxidation of the deposited germanium is also a complicated process; we found that mainly chemical oxidation by GeI<sub>4</sub> takes place, together with some electrooxidation. It is likely that kinetic factors play a dominant role.

If the germanium layers are partly oxidized by a short potential step to -1500 mV, random worm-like nanostructures form, healing in a complex process if the electrode potential is set back to more negative values (Figure 6.2-15).

As well as electrodisolution and electrodeposition, periphery and surface diffusion play important roles.

Unfortunately, only thin films of about 20 nanometers in thickness could be obtained with GeI<sub>4</sub>. An *ex situ* analysis was difficult, because of experimental limitations, but XPS clearly showed that elemental Ge was also obtained, besides

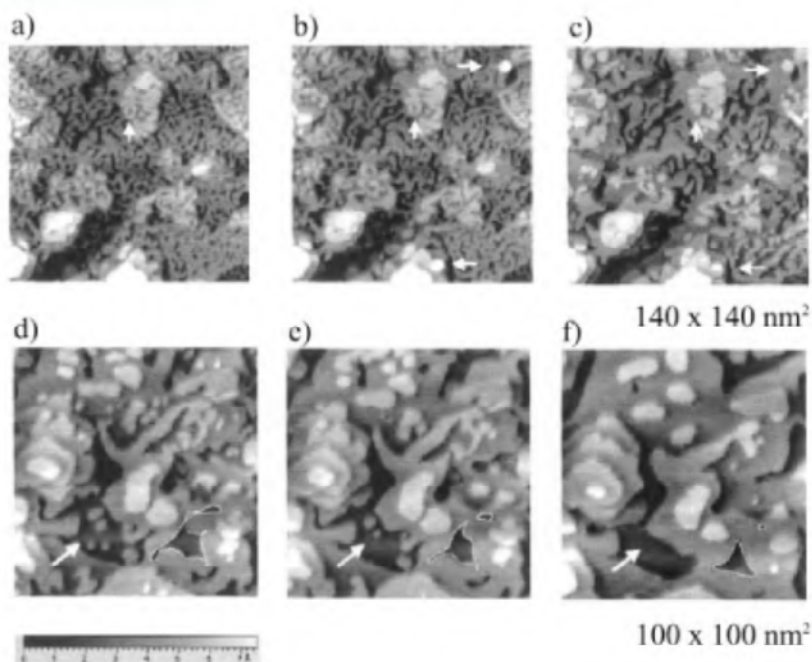

**Figure 6.2-15:** Wormlike nanostructures in Ge(111) can be obtained by partial oxidation; they heal in a complex process comprising electrodeposition/electrodissolution and periphery diffusion. Ring-like defects transform to points as predicted by Grayson's theorem (vertical arrow, a: 0 min, b: 8 min, c: 20 min – time with reference to a), electrodeposition of clusters occurs (horizontal arrows). Furthermore, the clusters can also dissolve (arrows in d–f) and pinch-off phenomena are observed (manually surrounded structures, d: 0 min, e: 12 min, f: 52 min – time with reference to d) (picture from [60] – with permission of the Pccp owner societies).

Ge(IV). The observation of Ge(IV) in the XPS analysis is most probably the result of chemical attack by ambient oxygen. Such an attack has also been reported for Ge on Au made by Physical Vapor Deposition [68].

### 6.2.3

#### Summary

This section presents an insight into the electrodeposition of metals, alloys, and semiconductors from ionic liquids. Besides environmental considerations, these media have the great advantage that they give access by electrodeposition to elements that cannot be obtained from aqueous solutions. Not only could technical procedures and devices profit, but interesting insights into the nanoscale processes during electrodeposition of elements such as germanium, silicon, etc. are also possible, especially for semiconductor nanostructures that will be important in nanotechnology. The ionic liquids give access to a great variety of elements and compounds. Therefore, electrodeposition in ionic liquids is an important contribution to nanotechnology. Perhaps it will be possible in future to establish nanoelectro-

chemical processes, for instance to make nanochips by this methodology. In any case, many more studies will be necessary if the deposition processes is to be understood on the nanometer scale.

## References

- 1 Nanoscale probes of the solid/liquid interface, NATO ASI series E 288 (A.A. Gewirth and H. Siegenthaler eds.), Kluwer Academic Publishers, Dordrecht 1995.
- 2 Chemistry of nonaqueous solutions: current progress (G. Mamantov and A.I. Popov eds.), VCH, Weinheim, 1994.
- 3 A.J. Bard and L.R. Faulkner, "Electrochemical Methods: Fundamentals and Applications", 2<sup>nd</sup> edition, John Wiley & Sons, Inc., 2001, ISBN: 0-471-04372-9.
- 4 S. Takahashi, K. Akimoto, I. Saeki, *Hyomen Gijutsu* 1989, 40, 134.
- 5 P.K. Lai, M. Skyllas-Kazacos, *J. Electroan. Chem.* 1988, 248, 431.
- 6 Y. Zhao, T.J. VanderNoot, *Electrochim. Acta* 1997, 42, 1639.
- 7 M.R. Ali, A. Nishikata, T. Tsuru, *Indian J. Chem. Technol.* 1999, 6, 317.
- 8 Q. Liao, W.R. Pitner, G. Stewart, C.L. Hussey, *J. Electrochem. Soc.* 1997, 144, 936
- 9 J. Fischer, US patent 2828252 (1958).
- 10 M. Bukowski, F. Endres, H. Natter, and R. Hempelmann, patent pending DE-101 08 893.0-24 (08.29.2002)
- 11 D. Wei, M. Okido, *Curr. Top. Electrochem.* 1997, 5, 21.
- 12 I. Galasiu, R. Galasiu, J. Thonstad, *Nonaqueous Electrochem.* 1999, 461.
- 13 W. Freyland, *Zeitschrift für Physikalische Chemie* 1994, 184, 139.
- 14 G.E. Gray, P.A. Kohl, J. Winnick, *J. Electrochem. Soc.* 1995, 142, 3636.
- 15 B.J. Piersma, *Proc. Electrochem. Soc.*, 1994, 94, 415.
- 16 P.-Y. Chen, Y.-F. Lin, I.-W. Sun, *J. Electrochem. Soc.* 1999, 146, 3290.
- 17 M.W. Verbrugge, M.K. Carpenter, *AIChE J.* 1990, 36, 1097.
- 18 C. Nanjundiah, K. Shimizu, R.A. Osteryoung, *J. Electrochem. Soc.* 1982, 11, 2474.
- 19 M. Lipsztajn, R.A. Osteryoung, *Inorg. Chem.* 1985, 24, 716.
- 20 R.T. Carlin, H.C. De Long, J. Fuller, P.C. Trulove, *J. Electrochem. Soc.* 1998, 145, 1598.
- 21 N. Koura, T. Kato, E. Yumoto, *Hyomen Gijutsu*, 1994, 45, 805.
- 22 G.T. Cheek, H.C. De Long, P.C. Trulove, *Proc. Electrochem. Soc.* 2000, 99-41, 527.
- 23 N. Guo, J. Guo, S. Xiong, *Fushi Kexue Yu Fanghu Jishu* 1998, 10, 290.
- 24 M.R. Ali, A. Nishikata, T. Tsuru, *Electrochim. Acta* 1997, 42, 2347.
- 25 T. Tsuda, Y. Ito, *Proc. Electrochem. Soc.* 2000, 99-41, 100.
- 26 J.S.-Y. Liu, I.-W. Sun, *J. Electrochem. Soc.* 1997, 144, 140.
- 27 M.K. Carpenter, M.W. Verbrugge, *J. Mater. Res.* 1994, 9, 2584.
- 28 M.K. Carpenter, M.W. Verbrugge, US patent 92-926103 (1993).
- 29 M. Lipsztajn, R.A. Osteryoung, *Inorg. Chem.* 1985, 24, 3492.
- 30 D.A. Habboush, R.A. Osteryoung, *Inorg. Chem.* 1984, 23, 1726.
- 31 C.L. Hussey, personal communication.
- 32 A.F. Tsatsulnikov, S.V. Ivanov, P.S. Kopev, I.L. Krestnikov, A.K. Kryganovskii, N.N. Ledentsov, M.V. Maximov, B.Y. Meltser, P.V. Nekludov, A.A. Suvorova, A.N. Titkov, B.V. Volovik, M. Grundmann, D. Bimberg, Z.I. Alferov, A. F. Ioffe, *Microelectron. Eng.* 1998, 43/44, 85.
- 33 E. G.-S. Jeng, I.-W. Sun, *J. Electrochem. Soc.* 1997, 144, 2369.
- 34 B. Gregory, J.L. Stickney *J. Electroan. Chem.* 1994 365, 87.
- 35 M.A.M Noel, R.A. Osteryoung, *J. Electroan. Chem.* 1996, 293, 139.
- 36 P.-Y. Chen, I.-W. Sun, *Electrochim. Acta* 2000, 45, 3163.

- 37 C.L. Hussey, L.A. King, R.A. Carpio, *J. Electrochem. Soc.* **1979**, *126*, 1029.
- 38 C. Nanjundiah, R.A. Osteryoung, *J. Electrochem. Soc.* **1983**, *130*, 1312.
- 39 B.J. Tierney, W.R. Pitner, J.A. Mitchell, C.L. Hussey, *J. Electrochem. Soc.* **1998**, *145*, 3110.
- 40 P.-Y. Chen, I.-W. Sun, *Proc. Electrochem. Soc.* **1998**, *98-11*, 55.
- 41 X.-H. Xu, C.L. Hussey, *J. Electrochem. Soc.* **1992**, *139*, 1295.
- 42 F. Endres and W. Freyland, *J. Phys. Chem. B* **1998**, *102*, 10,229.
- 43 Y. Katayama, S. Dan, T. Miura, T. Kishi, *J. Electrochem. Soc.* **2001**, *148*, C102.
- 44 W. Schindler, D. Hofmann, J. Kirschner, *J. Electrochem. Soc.* **2001**, *148*, C124–C130.
- 45 J.A. Mitchell, W.R. Pitner, C.L. Hussey, G.R. Stafford, *J. Electrochem. Soc.* **1996**, *143*, 3448.
- 46 W.R. Pitner, C.L. Hussey, G.R. Stafford, *J. Electrochem. Soc.* **1996**, *143*, 130.
- 47 C.A. Zell, W. Freyland, F. Endres, *Progress in Molten Salt Chemistry* **2000**, *1*, 597, Elsevier, ISBN: 2-84299-249-0.
- 48 C.A. Zell, W. Freyland, *Chem. Phys. Lett.* **2001**, *337*, 293.
- 49 H.C. De Long, J.S. Wilkes, R.T. Carlin, *J. Electrochem. Soc.* **1994**, *141*, 1000.
- 50 X.-H. Xu, C.L. Hussey, *Proc. Electrochem. Soc.* **1992**, *16*, 445.
- 51 E.R. Schreiter, J.E. Stevens, M.F. Ortwerth, R.G. Freeman, *Inorg. Chem.* **1999**, *38*, 3935.
- 52 W.R. Pitner, C.L. Hussey, *J. Electrochem. Soc.* **1997**, *144*, 3095.
- 53 X.-H. Xu, C.L. Hussey, *J. Electrochem. Soc.* **1993**, *140*, 618.
- 54 R.K. Pandey, S.N. Sahu, S. Chandra, "Handbook of Semiconductor Electrodeposition", Marcel Dekker, Inc., **1996**, ISBN 0-8247-9701-9.
- 55 A. Raza, R. Engelken, B. Kemp, A. Siddiqui, O. Mustafa, *Proc. Arkansas Acad. Sci.* **1995**, *49*, 143
- 56 S.P. Wicelinski, R.J. Gale, *Proc. Electrochem. Soc.* **1987**, *134*, 262.
- 57 M.K. Carpenter, M.W. Verbrugge, *J. Electrochem. Soc.* **1987**, *87-7*, 591.
- 58 M.-C. Lin, P.-Y. Chen, I.-W. Sun, *J. Electrochem. Soc.* **2001**, *148(10)*, C653.
- 59 F. Endres, C. Schrodt, *Phys. Chem. Chem. Phys.* **2000**, *24*, 5517.
- 60 F. Endres, *Phys. Chem. Chem. Phys.* **2001**, *3*, 3165.
- 61 O. Leifeld, A. Beyer, E. Müller, D. Grützmacher, K. Kern, *Thin Solid Films* **2000**, *380*, 176.
- 62 G. Binnig, H. Rohrer, *Helv. Phys. Acta* **1982**, *55*, 726.
- 63 R. Sonnenfeld, P.K. Hansma, *Science* **1986**, *232*, 211.
- 64 "Scanning Tunneling Microscopy and Spectroscopy: Theory, Techniques and Applications" ( D.A. Bonnelli ed.), John Wiley & Sons, **2000**, ISBN: 0-471-24824-X.
- 65 C.A. Zell, F. Endres, W. Freyland, *Phys. Chem. Chem. Phys.* **1999**, *1*, 697.
- 66 T. Will, M. Dietterle, D.M. Kolb in ref. 1, p. 137–162.
- 67 F. Endres, A. Schweizer, *Phys. Chem. Chem. Phys.* **2000**, *2*, 5455.
- 68 S. Ingre, B. MacLaurin, *J. Vac. Sci. Technol., A* **1984**, *2*, 358.



## 7

### Polymer Synthesis in Ionic Liquids

*Adrian J. Carmichael and David M. Haddleton*

#### 7.1

##### Introduction

Ambient-temperature ionic liquids have received much attention in both academia and industry, due to their potential as replacements for volatile organic compounds (VOCs) [1–3]. These studies have utilized the ionic liquids as direct replacements for conventional solvents and as a method to immobilize transition metal catalysts in biphasic processes.

Many organic chemical transformations have been carried out in ionic liquids: hydrogenation [4, 5], oxidation [6], epoxidation [7], and hydroformylation [8] reactions, for example. In addition to these processes, numerous synthetic routes involve a carbon-carbon (C–C) bond-forming step. As a result, many C–C bond-forming procedures have been studied in ambient-temperature ionic liquids. Among those reported are the Friedel–Crafts acylation [9] and alkylation [10] reactions, allylation reactions [11, 12], the Diels–Alder reaction [13], the Heck reaction [14], and the Suzuki [15] and Trost–Tsuji coupling [16] reactions.

The C–C bond-forming reaction that has received most attention in ionic liquids is the dimerization of simple olefins (such as ethene, propene, and butene) [17–20]. An existing commercial procedure, the Dimersol process [21], is widely used for the dimerization of simple olefins, producing approximately  $3 \times 10^6$  tonnes per annum. The technology in this process has been adapted to function under biphasic conditions by use of the ternary ionic liquid system [BMIM][Cl–AlCl<sub>3</sub>–EtAlCl<sub>2</sub>] (where BMIM is 1-butyl-3-methylimidazolium) as a solvent for the nickel catalysts [17, 18, 22]. Improvements in catalyst activity, better selectivity, and simple removal of pure products allowing easy recycling of the ionic liquid and catalyst are the benefits offered over the conventional process.

In these reactions the system is tuned, for example by adjustment of the reaction temperature and time and modification of the catalyst structure to maximize the quantity of the desired dimers produced, and to minimize the production of higher molecular weight oligomers and polymers. In other reactions it is the opposite

that is true: higher weight products are desired. The most industrially useful C–C bond-forming reaction is addition polymerization. This is used to obtain polymers that are used for a multitude of applications: in, for example, coatings, detergents, adhesives, plastics, etc. The use of ambient-temperature ionic liquids as solvents for the preparation of polymers has received little attention, especially in comparison with studies concerning their use in other synthetic areas. This chapter surveys the polymerization reactions carried out in ionic liquids thus far.

## 7.2

### Acid-catalyzed Cationic Polymerization and Oligomerization

Strong Brønsted acids that have non-nucleophilic anions (such as  $\text{HClO}_4$  and  $\text{CF}_3\text{CO}_2\text{H}$ ) are capable of initiating cationic polymerization with vinyl monomers that contain an electron-donating group adjacent to a carbon-carbon double bond, (such as vinyl ethers, isobutylene, styrene, and dienes). Lewis acids are also used as initiators in cationic polymerization with the formation of high molecular weight polymers. These Lewis acids include metal halides (such as  $\text{AlCl}_3$ ,  $\text{BF}_3$ , and  $\text{SbCl}_5$ ), organometallic species (such as  $\text{EtAlCl}_2$ ), and oxyhalides (such as  $\text{POCl}_3$ ). Lewis acids are often used in the presence of a proton source (such as  $\text{H}_2\text{O}$ ,  $\text{HCl}$ , or  $\text{MeOH}$ ) or a carbocation source (such as  $t\text{BuCl}$ ), which produces an acceleration in the rate of polymerization [23].

The chloroaluminate(III) ionic liquids –  $[\text{EMIM}][\text{Cl-AlCl}_3]$ , for example (where EMIM is 1-ethyl-3-methylimidazolium) – are liquid over a wide range of  $\text{AlCl}_3$  concentrations [24]. The quantity of  $\text{AlCl}_3$  present in the ionic liquid determines the physical and chemical properties of the liquid. When the mole fraction,  $X(\text{AlCl}_3)$ , is below 0.5, the liquids are referred to as basic. When  $X(\text{AlCl}_3)$  is above 0.5, the liquids are referred to as acidic, and at an  $X(\text{AlCl}_3)$  of exactly 0.5 they are referred to as neutral.

Studies have shown that when protons (from  $\text{HCl}$  as the source) are dissolved at ordinary temperatures and pressures in the acidic ionic liquid  $[\text{EMIM}][\text{Cl-AlCl}_3]$  ( $X(\text{AlCl}_3) = 0.55$ ) they are superacidic, with a strength similar to that of a liquid  $\text{HF}/\text{Lewis acid}$  mixture [25]. The precise Brønsted acidity observed depends on proton concentration and on ionic liquid composition. The ambient-temperature chloroaluminate(III) ionic liquids are extremely sensitive to moisture, reacting exothermically to give chlorooxoaluminate(III) species and generating  $\text{HCl}$ . Since moisture is ever present, even in the most carefully managed systems, chloroaluminate(III) ionic liquids generally possess superacidic protons. In addition, acidic chloroaluminate(III) ionic liquids contain Lewis acid species [26] ( $[\text{Al}_2\text{Cl}_7]^-$ , for example), so it is unsurprising that, with the combination of these factors, acidic chloroaluminate(III) ionic liquids catalyze the cationic oligomerization and polymerization of olefins.

Studies on the dimerization and hydrogenation of olefins with transition metal catalysts in acidic chloroaluminate(III) ionic liquids report the formation of higher molecular weight fractions consistent with cationic initiation [17, 20, 27, 28]. These

studies ascribe the occurrence of the undesired side reaction to both the Lewis acid- and the proton-catalyzed routes. Attempts to avoid these side reactions resulted in the preparation of alkylchloroaluminate(III) ionic liquids and buffered chloroaluminate(III) ionic liquids [17, 20, 28].

Attempts to bring the benefits of ionic liquid technology, drawing on this inherent ability of the chloroaluminate(III) ionic liquids, to catalysis of cationic polymerization reactions, as opposed to their minimization, were patented by Ambler et al. of BP Chemicals Ltd. in 1993 [29]. They used acidic  $[\text{EMIM}][\text{Cl-AlCl}_3]$  ( $X(\text{AlCl}_3) = 0.67$ ) for the polymerization of butene to give products that have found application as lubricants. The polymerization could be carried out by bubbling butene through the ionic liquid, the product forming a separate layer that floated upon the ionic liquid and was isolated by a simple process. Alternatively, the polymerization could be carried out by injecting the ionic liquid into a vessel charged with butene. After a suitable settling period, the poly(butene) was isolated in a similar fashion. The products from these reactions are best described as oligomers as opposed to polymers, as the product is still in the liquid form. Chain transfer to impurities, ionic liquid, monomer, and polymer will terminate the propagation reaction, resulting in the low-mass products.

Synthesis of higher molecular weight polymers by cationic polymerization requires the formation of charged centers that live for long enough to propagate without chain transfer or termination. For this to occur, stabilization of the propagating species by solvation is generally required. In addition, low temperatures are usually employed, in an attempt to reduce side reactions that destroy the propagating centers. Use of a pure isobutene feedstock gives poly(isobutene) with properties that depend upon the reaction temperature. As the temperature is reduced, the molecular weight of the product is reported to increase dramatically, which is a result of the rates of the side reactions and the rate of polymerization being reduced (Table 7.2-1) [29].

Ionic liquid-catalyzed polymerization of butene is not limited to the use of pure alkene feedstocks, which can be relatively expensive. More usefully, the technology can be applied to mixtures of butenes, such as the low-value hydrocarbon feedstocks raffinate I and raffinate II. The raffinate feedstocks are principally C4 hydrocarbon mixtures rich in butenes. When these feedstocks are polymerized in the presence of acidic chloroaluminate(III) ionic liquids, polymeric/oligomeric products with

**Table 7.2-1:** Polymerization of isobutene in the acidic ionic liquid  $[\text{EMIM}]\text{Cl}/\text{AlCl}_3$  ( $X(\text{AlCl}_3) = 0.67$ ) [29].

Reaction temperature (°C)	Yield (% w/w)	Molecular weight of product (g mol <sup>-1</sup> )
-23	26	100,000 <sup>a</sup>
0	75	3000 and 400 <sup>b</sup>

<sup>a</sup> Polystyrene equivalents. <sup>b</sup> Bimodal.

molecular weights higher than those obtained by conventional processes are produced, even though higher reaction temperatures are used. With the ionic liquid-catalyzed process, although isobutene conversion is much higher than *n*-butene conversion, the produced polymers have a much higher incorporation of *n*-butenes than would be possible from conventional cationic polymerization processes (Table 7.2-2) [29].

The ionic liquid process has a number of advantages over traditional cationic polymerization processes such as the Cosden process, which employs a liquid-phase aluminium(III) chloride catalyst to polymerize butene feedstocks [30]. The separation and removal of the product from the ionic liquid phase as the reaction proceeds allows the polymer to be obtained simply and in a highly pure state. Indeed, the polymer contains so little of the ionic liquid that an aqueous wash step can be dispensed with. This separation also means that further reaction (e.g., isomerization) of the polymer's unsaturated  $\omega$ -terminus is minimized. In addition to the ease of isolation of the desired product, the ionic liquid is not destroyed by any aqueous washing procedure and so can be reused in subsequent polymerization reactions, resulting in a reduction of operating costs. The ionic liquid technology does not require massive capital investment and is reported to be easily retrofitted to existing Cosden process plants.

Further development of the original work in which [EMIM][Cl-AlCl<sub>3</sub>] ( $X(\text{AlCl}_3) = 0.67$ ) was used as the ionic liquid has found that replacement of the ethyl group attached to the imidazolium ring with alkyl groups of increasing length (e.g., octyl, dodecyl, and octadecyl) produces increased catalytic activity towards the oligomerization of the olefins in the ionic liquid. Thus, the longer the alkyl chain, the greater the degree of polymerization achieved [31]. This provides an additional method for altering the product distribution. Increased polymer yield with the raffinate I feedstock was achieved by the use of an [EMIM][Cl-AlCl<sub>3</sub>] ionic liquid containing a small proportion of the quaternary ammonium salt [NEt<sub>4</sub>]Cl. The ternary ionic liquid [NEt<sub>4</sub>]Cl/[EMIM][Cl-AlCl<sub>3</sub>] of mole ratio 0.08:0.25:0.67, used under the same reaction conditions as the binary ionic liquid [EMIM][Cl-AlCl<sub>3</sub>] ( $X(\text{AlCl}_3) = 0.67$ ), produced ~70 % of a polymer/oligomer mixture, as opposed to ~40 % polymer/oligomer produced with the original binary system. Both systems produced oligomers with  $M_n = 1,000 \text{ g mol}^{-1}$  [32]. These examples demonstrate the capability to tune the ionic liquids' properties by changing the ancillary substituents. This allows the solvent to be adapted to the needs of the reaction, as opposed to altering the reaction to the needs of the solvent.

<i>Raffinate I feedstock</i>		
<i>Olefin fraction</i>	<i>Concentration (% w/w)</i>	<i>Reacted (% w/w)</i>
Isobutene	46	91
1-Butene	25	47
<i>trans</i> -2-Butene	8	34
<i>cis</i> -2-Butene	3	37

**Table 7.2-2:** Polymerization of Raffinate I in the acidic ionic liquid [EMIM]Cl/AlCl<sub>3</sub> ( $X(\text{AlCl}_3) = 0.67$ ): conversion of the individual components [29].

This technology has been utilized by BP Chemicals for the production of lubricating oils with well defined characteristics (for example, pour point and viscosity index). It is used in conjunction with a mixture of olefins (i.e., different isomers and different chain length olefins) to produce lubricating oils of higher viscosity than obtainable by conventional catalysis [33]. Unichema Chemie BV have applied these principals to more complex monomers, using them with unsaturated fatty acids to create a mixture of products [34].

Apart from one mention in the original patent of the synthesis of a high molecular weight poly(isobutene) (see Table 7.2-1) [29], the remaining work has until recently been concerned with the preparation of lower weight oligomers. In 2000, Symyx Technologies Inc. protected a method for the production of high molecular weight poly(isoolefins) without the use of very low temperatures [35]. Symyx used the [EMIM][Cl-AlCl<sub>3</sub>] ionic liquid to produce poly(isobutene)s with weight average molecular weights ( $M_w$ s) in excess of 100,000 g mol<sup>-1</sup> which are of use in the automotive industry due to their low oxygen permeability and mechanical resilience (Table 7.2-3). The table shows that polymers with molecular weights higher than half a million are obtained at temperatures as high as -40 °C. As would be expected, when the temperature is increased the molecular weight decreases. In all cases the yield is less than 50 %. If the reaction is performed under biphasic conditions, reducing the concentration of isobutene and adding ethylaluminium(III) dichloride, however, the reaction yield becomes quantitative, (Table 7.2-4). This shows that, in addition to the use of temperature to control the molecular weight of the product, control can also be achieved through the quantity of ethylaluminium(III) dichloride added to the reaction: the more alkylaluminum(III) that is added, the lower the molecular weight of the product. It might be expected that the ethylaluminium(III) dichloride would act as a proton scavenger, which should stop the polymerization, thus it seems it acts either/both as a strong Lewis acid or/and as an alkylating agent promoting polymerization.

For the results reported in both Table 7.2-3 and Table 7.2-4, the only reported detail concerning the ionic liquid was that it was [EMIM][Cl-AlCl<sub>3</sub>]. No details of the aluminium(III) chloride content were forthcoming. As with most of the work presented in this chapter, data are taken from the patent literature and not from peer reviewed journals, and so many experimental details are not available. This lack of clear reporting complicates issues for the synthetic polymer chemist. Simpler and cheaper chloroaluminate(III) ionic liquids prepared by using cations derived from the reaction between a simple amine and hydrochloric acid (e.g., Me<sub>3</sub>N·HCl and

**Table 7.2-3:** Polymerization of isobutene to high molecular weight poly(isobutene)s in the ionic liquid [EMIM]Cl/AlCl<sub>3</sub> [35].

Quantity of ionic liquid (μl)	Quantity of isobutene (μl)	Temperature (°C)	Yield (%)	$M_w$ (g mol <sup>-1</sup> )
10	483	-40	38	526,000
10	483	-30	33	302,000
10	483	-20	45	128,000



**Table 7.2-4:** Polymerization of isobutene to high molecular weight poly(isobutene)s in the ionic liquid [EMIM]Cl/AlCl<sub>3</sub> under biphasic conditions [35].

Quantity of ionic liquid (μl)	Quantity of hexane (μl)	Quantity of isobutene (μl)	Quantity of EtAlCl <sub>2</sub> (μl)	Yield (%)	M <sub>w</sub> (g mol <sup>-1</sup> )
50	321	25	11	100	276,000
50	310	25	23	100	235,000
50	298	25	34	100	186,000

Conditions: temperature = -30 °C; [EtAlCl<sub>2</sub>] = 1 M solution in hexane.

Bu<sub>2</sub>NH·HCl) have successfully been used in the polymerization of isobutene and styrene [36]. Although these ionic liquids have much higher melting points than their imidazolium analogues, they are liquid at temperatures suitable for their use in the preparation of low molecular weight oligomers (i.e., 1000 to 4000 g mol<sup>-1</sup>). This reduces one of the barriers to exploitation of the technology, the relatively high expense of the imidazolium halide salts.

### 7.3

#### Free Radical Polymerization

Free radical polymerization is a key method used by the polymer industry to produce a wide range of polymers [37]. It is used for the addition polymerization of vinyl monomers including styrene, vinyl acetate, tetrafluoroethylene, methacrylates, acrylates, (meth)acrylonitrile, (meth)acrylamides, etc. in bulk, solution, and aqueous processes. The chemistry is easy to exploit and is tolerant to many functional groups and impurities.

The first use of ionic liquids in free radical addition polymerization was as an extension to the doping of polymers with simple electrolytes for the preparation of ion-conducting polymers. Several groups have prepared polymers suitable for doping with ambient-temperature ionic liquids, with the aim of producing polymer electrolytes of high ionic conductance. Many of the prepared polymers are related to the ionic liquids employed: for example, poly(1-butyl-4-vinylpyridinium bromide) and poly(1-ethyl-3-vinylimidazolium bis(trifluoromethanesulfonyl)imide) [38–41].

Noda and Watanabe [42] reported a simple synthetic procedure for the free radical polymerization of vinyl monomers to give conducting polymer electrolyte films. Direct polymerization in the ionic liquid gives transparent, mechanically strong and highly conductive polymer electrolyte films. This was the first time that ambient-temperature ionic liquids had been used as a medium for free radical polymerization of vinyl monomers. The ionic liquids [EMIM][BF<sub>4</sub>] and [BP][BF<sub>4</sub>] (BP is *N*-butylpyridinium) were used with equimolar amounts of suitable monomers, and polymerization was initiated by prolonged heating (12 hours at 80 °C) with benzoyl



peroxide. Suitable monomers for this purpose were those that dissolved in the ionic liquid solvent to give transparent, homogeneous solutions (Table 7.3-1), with unsuitable monomers phase-separating and therefore not being subjected to polymerization. Of all the monomers found to give transparent homogeneous solutions, only vinyl acetate failed to undergo polymerization. In all other polymerizations, with the exception of that of 2-hydroxyethyl methacrylate (HEMA), the polymer was insoluble in the ionic liquid and phase-separated. The compatibility of HEMA with the ionic liquids resulted in its use for the preparation of polymer electrolyte films, which were found to be highly conductive. For film formation, the reaction mixtures were simply spread between glass plates and heated; no degassing procedures were carried out. Analysis of the films found that the amount of unreacted monomer was negligible, indicating fast polymerization. No characterization of the polymers, or indeed analysis of the polymerization reactions, was reported in any of the reactions described by Noda and Watanabe [42].

More recent studies by May and by ourselves have looked into the kinetics and the types of polymers formed by the free radical polymerization reactions of vinyl monomers with ambient-temperature ionic liquids as solvents [43, 44]. The free radical polymerization of methyl methacrylate (MMA) in [BMIM][PF<sub>6</sub>], initiated by 2,2'-azobisisobutyronitrile (AIBN) at 60 °C, proceeds rapidly, causing a large increase in viscosity that hampers efficient stirring of the reaction mixture. The polymerization reactions produce poly(methyl methacrylate) (PMMA) with very high molecular weights (see Table 7.3-2) [44]. In comparison with a free radical polymerization in a conventional organic solvent, toluene in this case, both conversion and  $M_n$  are increased by approximately one order of magnitude. This could be due to one of two reasons. Firstly, the rate of bimolecular termination either by disproportionation or by combination could be suppressed, which might be due in part to the large increase in viscosity of the reaction medium. In this case termination would be dominated by chain transfer either to solvent or to monomer. The molecular weights observed are consistent with this explanation. Alternatively, the rate constant of propagation,  $k_p$ , may be increased in the ionic liquid due to local environment effects.

**Table 7.3-1:** Compatibility of the ionic liquids [EMIM][BF<sub>4</sub>] and [BP][BF<sub>4</sub>] with monomers and their polymers [42].

	[EMIM][BF <sub>4</sub> ]		[NBPY][BF <sub>4</sub> ]	
	Monomer	Polymer	Monomer	Polymer
Methyl methacrylate	X	–	O	X
Acrylonitrile	O	X	O	X
Vinyl acetate	O	no reaction	O	no reaction
Styrene	X	–	X	–
2-Hydroxyethyl methacrylate	O	ρ	O	ρ

Legend: O, transparent homogenous solution; X, phase-separated; ρ, translucent gel.

Table 7.3-2: Free radical polymerization of MMA in the ionic liquid [BMIM][PF<sub>6</sub>] [44].

Reaction media	[AIBN] (w/v %)	Conversion (%)	$M_n$ (g mol <sup>-1</sup> )	PDI
[BMIM][PF <sub>6</sub> ]	1	25	669,000	1.75
[BMIM][PF <sub>6</sub> ]	2	27	600,000	1.88
[BMIM][PF <sub>6</sub> ]	4	36	416,000	2.22
[BMIM][PF <sub>6</sub> ]	8	56	240,000	2.59
Toluene	1	3	58,300	1.98

Conditions: temperature = 60 °C; time = 20 min; 20 % v/v monomer in ionic liquid.

The effects of increasing the concentration of initiator (i.e., increased conversion, decreased  $M_n$ , and broader PDI) and of reducing the reaction temperature (i.e., decreased conversion, increased  $M_n$ , and narrower PDI) for the polymerizations in ambient-temperature ionic liquids are the same as observed in conventional solvents. May et al. have reported similar results and in addition used <sup>13</sup>C NMR to investigate the stereochemistry of the PMMA produced in [BMIM][PF<sub>6</sub>]. They found that the stereochemistry was almost identical to that for PMMA produced by free radical polymerization in conventional solvents [43]. The homopolymerization and copolymerization of several other monomers were also reported. Similarly to the findings of Noda and Watanabe, the polymer was in many cases not soluble in the ionic liquid and thus phase-separated [43, 44].

## 7.4

### Transition Metal-catalyzed Polymerization

The previous sections show that certain ionic liquids, namely the chloroaluminate(III) ionic liquids, are capable of acting both as catalyst and as solvent for the polymerization of certain olefins, although in a somewhat uncontrolled manner, and that other ionic liquids, namely the non-chloroaluminate(III) ionic liquids, are capable of acting as solvents for free radical polymerization processes. In attempts to carry out polymerization reactions in a more controlled manner, several studies have used dissolved transition metal catalysts in ambient-temperature ionic liquids and have investigated the compatibility of the catalyst towards a range of polymerization systems.

#### 7.4.1

##### Ziegler–Natta Polymerization of Ethylene

Ziegler–Natta polymerization is used extensively for the polymerization of simple olefins (such as ethylene, propene, and 1-butene) and is the focus of much academic attention, as even small improvements to a commercial process operated on

this scale can be important. Ziegler–Natta catalyst systems, which in general are early transition metal compounds used in conjunction with alkylaluminium compounds, lend themselves to study in the chloroaluminate(III) ionic liquids, especially those of acidic composition.

During studies into the behavior of titanium(IV) chloride in chloroaluminate(III) ionic liquids, Carlin et al. carried out a brief study to investigate whether Ziegler–Natta polymerization was possible in an ionic liquid [45]. They dissolved  $\text{TiCl}_4$  and  $\text{EtAlCl}_2$  in  $[\text{EMIM}][\text{Cl-AlCl}_3]$  ( $X(\text{AlCl}_3) = 0.52$ ) and bubbled ethylene through for several minutes. After quenching, poly(ethylene) with a melting point of 120–130 °C was isolated in very low yield, thus demonstrating that Ziegler–Natta polymerization works in these liquids, albeit not very well.

The same ionic liquid was employed, giving higher yields of poly(ethylene), with bis( $\eta$ -cyclopentadienyl)titanium(IV) dichloride in conjunction with  $\text{Me}_3\text{Al}_2\text{Cl}_3$  as catalyst [46]. However, the catalytic activities are still low when compared to other homogeneous systems, which may be attributed to, among other things, low solubility of ethylene in the ionic liquids or the presence of alkylimidazole impurities that coordinate and block the active titanium sites. In chloroaluminate(III) ionic liquids of basic composition, no catalysis was observed. This was ascribed to the formation of the inactive  $[\text{Ti}(\eta\text{-C}_5\text{H}_5)_2\text{Cl}_3]^-$  species. In comparison, the zirconium and hafnium analogues  $[\text{Zr}(\eta\text{-C}_5\text{H}_5)_2\text{Cl}_2]$  and  $[\text{Hf}(\eta\text{-C}_5\text{H}_5)_2\text{Cl}_2]$  showed no catalytic activity towards the polymerization of ethylene either in acidic or in basic ionic liquids. This is presumably due to the presence of stronger M–Cl bonds that preclude the formation of a catalytically active species.

#### 7.4.2

##### Late Transition Metal-catalyzed Polymerization of Ethylene

The surge in development of late transition metal polymerization catalysts has been due, in part, to the need for systems that can copolymerize ethylene, and related monomers, with polar co-monomers under mild conditions. Late transition metals have lower oxophilicity than early transition metals, and therefore a higher tolerance for a wider range of functional groups (e.g.,  $-\text{COOR}$  and  $-\text{COOH}$  groups) [47]. A recent study reports the use of the nickel complex **1** (Figure 7.4-1) for the homopolymerization of ethylene in an ambient-temperature ionic liquid [48]. Compound **1** was used under mild biphasic conditions with the ternary ionic liquid  $[\text{BMIM}][\text{Cl-AlCl}_3\text{-EtAlCl}_2]$  (1.0:1.0:0.32,  $X(\text{Al}) = 0.57$ ) and toluene, producing poly(ethylene) which was easily isolated from the reaction mixture by decanting the upper toluene layer. This allowed the ionic liquid and **1** to be recycled for use in further polymerizations. Before reuse, however, trimethylaluminium(III) was added to overcome the loss of free alkylaluminium species into the separated organic phase [48]. The characteristics of the isolated poly(ethylene) depend upon several reaction conditions. On increasing the reaction temperature from  $-10$  to  $+10$  °C, the melting point decreases from 123 to 85 °C due to a greater amount of chain branching, and a decrease in the  $M_w$  from 388,000 to 280,000  $\text{g mol}^{-1}$  also results. Reuse of the catalyst/ionic liquid solution also has an effect, with subsequent reactions giv-

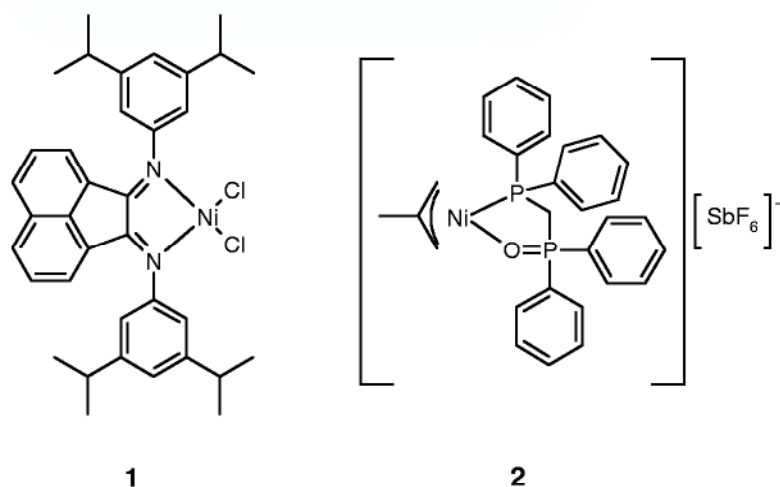

**Figure 7.4-1:** Nickel catalysts used for the polymerization and oligomerization of ethylene in ambient-temperature ionic liquids [48, 49].

ing a progressive shift from crystalline to amorphous polymer, with a period that gives rise to bimodal product distributions. This change is due to the changing composition of the ionic liquid, as fresh co-catalyst is added after each polymerization run, giving rise to the formation of different active species.

A related study used the air- and moisture-stable ionic liquids [RMIM][PF<sub>6</sub>] (R = butyl-decyl) as solvents for the oligomerization of ethylene to higher  $\alpha$ -olefins [49]. The reaction used the cationic nickel complex **2** (Figure 7.4-1) under biphasic conditions to give oligomers of up to nine repeat units, with better selectivity and reactivity than obtained in conventional solvents. Recycling of the catalyst/ionic liquid solution was possible with little change in selectivity, and only a small drop in activity was observed.

### 7.4.3

#### Metathesis Polymerization

Acyclic diene molecules are capable of undergoing intramolecular and intermolecular reactions in the presence of certain transition metal catalysts: molybdenum alkylidene and ruthenium carbene complexes, for example [50, 51]. The intramolecular reaction, called ring-closing olefin metathesis (RCM), affords cyclic compounds, while the intermolecular reaction, called acyclic diene metathesis (ADMET) polymerization, provides oligomers and polymers. Alteration of the dilution of the reaction mixture can to some extent control the intrinsic competition between RCM and ADMET.

Gürtler and Jautelat of Bayer AG have protected methods that use chloroaluminate(III) ionic liquids as solvents for both cyclization and polymerization reactions of acyclic dienes [52]. They employed the neutral ionic liquid [EMIM][Cl-AlCl<sub>3</sub>]

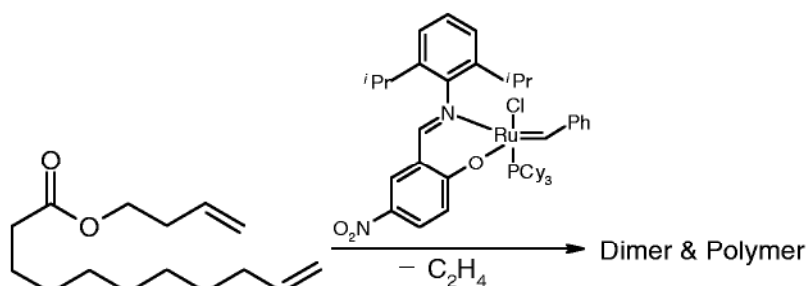

**Figure 7.4-2:** Acyclic diene metathesis polymerization (ADMET) reaction carried out in the neutral ionic liquid [EMIM]Cl/AlCl<sub>3</sub> ( $X(\text{AlCl}_3) = 0.5$ ) [52].

( $X(\text{AlCl}_3) = 0.5$ ) to immobilize a ruthenium carbene complex for biphasic ADMET polymerization of an acyclic diene ester (Figure 7.4-2). The reaction is an equilibrium process, and so removal of ethylene drives the equilibrium towards the products. The reaction proceeds readily at ambient temperatures, producing mostly polymeric materials but also ~10 % dimeric material.

#### 7.4.4

##### Living Radical Polymerization

As discussed in Section 7.3, conventional free radical polymerization is a widely used technique that is relatively easy to employ. However, it does have its limitations. It is often difficult to obtain predetermined polymer architectures with precise and narrow molecular weight distributions. Transition metal-mediated living radical polymerization is a recently developed method that has been developed to overcome these limitations [53, 54]. It permits the synthesis of polymers with varied architectures (for example, blocks, stars, and combs) and with predetermined end groups (e.g., rotaxanes, biomolecules, and dyes).

A potential limitation to commercialization of this technology is that relatively high levels of catalyst are often required. Indeed, it is common that one mole equivalent is required for each growing polymer chain to achieve acceptable rates of polymerization, making catalyst removal and reuse problematic. In order to overcome this problem, a range of approaches have been reported, including supported catalysts [55], fluorous biphasic reactions [56], and more recently the use of ionic liquids [57, 44]. It was found that copper(I) bromide in conjunction with *N*-propyl-2-pyridylmethanimine as ligand catalyzes the living radical polymerization of MMA in the neutral ionic liquid [BMIM][PF<sub>6</sub>]. The reaction progressed in a manner consistent with a living polymerization: that is, good first-order kinetic behavior and evolution of number-average molecular weight ( $M_n$ ) with time were observed, and a final product with low  $M_n$  and PDI values was obtained [57]. Polymerization in the ionic liquid proceeded much more rapidly than that in conventional organic solvents; indeed, polymerization occurred at 30 °C in [BMIM][PF<sub>6</sub>] at a rate comparable to that found in toluene at 90 °C.

The cationic nature of the copper(I) catalyst means that it is immobilized in the ionic liquid. This permits the PMMA product to be obtained, with negligible copper contamination, by a simple extraction procedure with toluene (in which the ionic liquid is not miscible) as the solvent. The ionic liquid/catalyst solution was subsequently reused.

The technique of copper(I) bromide-mediated living radical polymerization is compatible with other ambient-temperature ionic liquids. It proceeds smoothly in hexyl- and octyl-3-methylimidazolium hexafluorophosphate and tetrafluoroborate ionic liquids. However, use of [BMIM][BF<sub>4</sub>] for the polymerization of MMA generates a product with a bimodal product distribution. Figure 7.4-3 shows the trace, together with a trace from a similar reaction carried out in [BMIM][PF<sub>6</sub>] [44]. The mass distribution for [BMIM][PF<sub>6</sub>] shows a single, narrow, low molecular weight peak consistent with living radical polymerization, whereas the mass distribution for [BMIM][BF<sub>4</sub>] shows a similar peak, but also an additional peak that is broad and at high molecular weight. This high molecular weight peak is consistent with the results observed for conventional free radical polymerization in ionic liquids, as discussed in Section 7.3. This anomalous result can be explained in terms of the synthetic method used to prepare the ionic liquids. Of all the ionic liquids used, [BMIM][BF<sub>4</sub>] was the only one in the study that was miscible with water. It was therefore the only one not subjected to an aqueous workup, and so was contaminated with halide salts [58]. The halide salts might poison the catalyst, with subsequent polymerization proceeding by two different mechanisms. Alternatively, it might be that, under living polymerization conditions, the terminal halide atom on the propagating polymer chain does not fully separate from the polymer during propagation, creating a “caged-radical” that undergoes propagation. Under appropriate conditions, separation occurs, resulting in irreversible homolytic fission and the production of free radicals. Conventional free radical polymerization ensues in competition with the atom-transfer mechanism, giving high conversion and high-mass polymer alongside the low-mass polymer from the living mechanism. This

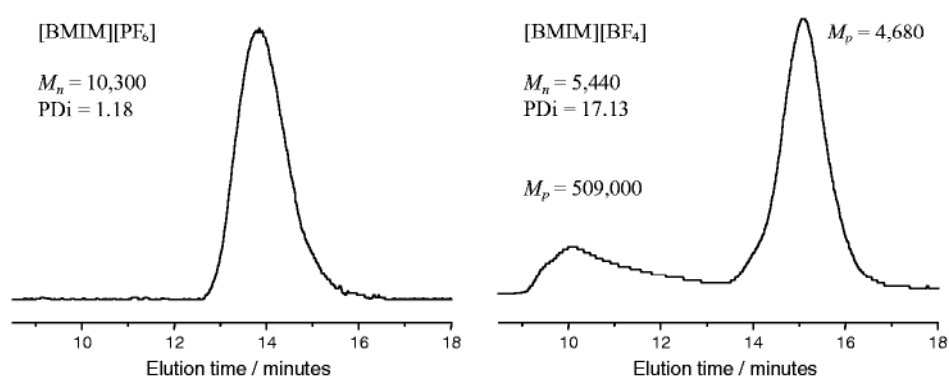

Figure 7.4-3: SEC traces for the Cu(I)Br-mediated living radical polymerization of MMA in the ionic liquids [BMIM][X] (X = [PF<sub>6</sub>] or [BF<sub>4</sub>] [44].



implies that the rate of termination in conventional radical propagation is drastically reduced, maybe by coordination with the cation or anion from the ionic liquid, which also prevents recombination with the halide atom.

In a related study, Kubisa has investigated the Atom-transfer Radical Polymerization (ATRP) of acrylates in [BMIM][PF<sub>6</sub>] [59]. The solubility of the monomer in the ionic liquid chosen depends very much upon the substituent on the monomer. Homogeneous polymerization of methyl acrylate gave living polymerization, with narrow polydispersity polymers and good molecular weight control. Higher order acrylates gave heterogeneous reactions, with the catalyst remaining in the ionic liquid phase. Although deviations from living polymerization behavior were observed, butyl acrylate showed controlled polymerization. The same group is currently extending this work and also looking at cationic vinyl polymerization and various ring-opening polymerization reactions.

## 7.5

### Preparation of Conductive Polymers

Electronically conducting polymers have a number of potential applications, including as coatings for semiconductors [60], in electrocatalysis [61], and as charge-storage materials [62]. Of these, poly(*para*-phenylene) (PPP), the simplest of the poly(arene) classes, possesses properties that include excellent thermal stability, high coke number, and good optical and electrophysical characteristics [63]. For PPP to be utilizable in devices and advanced materials, it should have a high relative molecular mass ( $M_r$ ), a homogenous structure, and good submolecular packing.

Poly(*para*-phenylene) can be prepared by a variety of chemical routes, but the polymers obtained are generally of low quality due to low masses and the occurrence of polymerization through 1,2-linkages, resulting in a disruption of molecular packing. They are obtained as powders and are often contaminated with oxygen and chlorine products and catalyst residues. The chemical synthesis of PPP can be carried out in ambient-temperature ionic liquids. The oxidative dehydropolycondensation of benzene was carried out in the acidic ionic liquid [BP]Cl/AlCl<sub>3</sub> ( $X(\text{AlCl}_3) = 0.67$ ) with CuCl<sub>2</sub> as the catalyst [64, 65]. This gave PPP with relative molecular masses considerably higher than those obtained in conventional solvents, and  $M_r$  could be tuned by varying the benzene concentration. The high  $M_r$  values observed were attributed to greater solubility of PPP in the ionic liquid, permitting a greater degree of polymerization before phase separation occurred. The electrochemical synthesis of PPP reduces many of the disadvantages of the chemical route. The same group carried out the electrochemical polymerization of benzene in the same ionic liquid, preparing PPP as conductive films that were flexible and transparent. The films were prepared with very high relative molecular masses, with degrees of polymerization of up to 200 being observed [65, 66]. The electrochemical polymerization of benzene to PPP has not been carried out exclusively in [BP][Cl-AlCl<sub>3</sub>] ionic liquids. Other reports use [BP]Cl/AlCl<sub>2</sub>(OEt),

[CTP]Cl/AlCl<sub>3</sub> (CTP is *N*-cetylpyridinium), and [EMIM][Cl-AlCl<sub>3</sub>], with the best results having been observed in the traditional aluminium(III) chloride ionic liquids [67–69].

The electrochemical oxidation of fluorene in [EMIM][Cl-AlCl<sub>3</sub>] ionic liquids of acidic or neutral compositions gives poly(fluorene) films that are more stable and have less complicated electrochemical behavior than those prepared in acetonitrile, the usual solvent. Basic ionic liquids cannot be used, as chloride ions are more easily oxidized than fluorene [70]. A number of aromatic compounds containing heteroatoms, such as pyrrole, aniline, and thiophene, can also be oxidized electrochemically in chloroaluminate(III) ionic liquids to give polymer films [71–74]. In ionic liquids of acidic composition, electrochemical polymerization of the nitrogen- and sulfur-containing compounds is either more difficult or not possible at all, due to the formation of adducts with AlCl<sub>3</sub> [75]. Any interactions between benzene and AlCl<sub>3</sub> are not significant enough to influence its polymerization to PPP [69].

## 7.6

### Conclusions

It is readily apparent that the volume of research concerning polymerization of any type in ionic liquids is sparse. It is not immediately clear why this is the case, and the field has not really started as yet. Ionic liquid technology has brought a number of benefits to polymer synthesis. For example, the application of chloroaluminate(III) ionic liquids as both solvent and catalyst for the cationic polymerization of olefins has provided a system that not only produces cleaner polymers than traditional processes but permits the recovery and reuse of the ionic liquid solvent/catalyst. Ionic liquids have allowed the preparation of high molecular weight conducting polymers such as poly(*para*-phenylene), and have been useful for the immobilization of transition metal polymerization catalysts, thus offering a potential solution to a problem that prevents the commercialization of transition metal-mediated living radical polymerization.

The use of neutral ionic liquids for free radical polymerization highlights one of their problems: their relatively high viscosity. The viscosity of the reaction mixture has a significant effect on the outcome of polymerization reactions, and these liquids can have viscosities much higher than those of conventional organic solvents. The free radical polymerization of MMA in [BMIM][PF<sub>6</sub>] generates polymers with high molecular weights, which, when combined with the reduced fluidity of the ionic liquid, causes the reaction mixture to set after a very short time. This problem can be avoided in polymerization reactions if phase-separation of the product occurs, as with, for example, the free radical polymerization of MMA in [BP][BF<sub>4</sub>], or, if the reaction is operated under biphasic conditions, for example, the reported ADMET polymerization of an acyclic diene ester.

As well as viscosity, other factors to be aware of include the purity of the ionic liquids. The presence of residual halide ions in neutral ionic liquids can poison transition metal catalysts, while different levels of proton impurities in chloroalumi-

nate(III) ionic liquids can alter the product distribution of the reaction. The reduced temperatures required for many polymerization reactions in ionic liquids, together with the reduced solubility of oxygen in ionic liquids compared to that in conventional solvents, means that two of the most common quenching methods are reduced in effectiveness. If detailed studies are being carried out, in particular kinetic studies, it is necessary to stop further reaction completely so that accurate data may be obtained.

The controlled synthesis of polymers, as opposed to their undesired formation, is an area that has not received much academic interest. Most interest to date has been commercial, and focused on a narrow area: the use of chloroaluminate(III) ionic liquids for cationic polymerization reactions. The lack of publications in the area, together with the lack of detailed and useful synthetic information in the patent literature, places hurdles in front of those with limited knowledge of ionic liquid technology who wish to employ it for polymerization studies. The expanding interest in ionic liquids as solvents for synthesis, most notably for the synthesis of discrete organic molecules, should stimulate interest in their use for polymer science.

Even within the small numbers of studies conducted to date, we are already seeing potentially dramatic effects. Free radical polymerization proceeds at a much faster rate and there is already evidence that both the rate of propagation and the rate of termination are effected. Whole polymerization types – such as ring-opening polymerization to esters and amides, and condensation polymerization of any type (polyamides, polyesters, for example) – have yet to be attempted in ionic liquids. This field is in its infancy and we look forward to the coming years with great anticipation.

## References

- 1 J. D. Holbrey, K. R. Seddon, *Clean Products and Processes* **1999**, *1*, 223–236.
- 2 T. Welton, *Chem. Rev.* **1999**, *99*, 2071–2083.
- 3 P. Wasserscheid, W. Keim, *Angew. Chem., Int. Ed. Engl.* **2000**, *39*, 3772–3789.
- 4 C. J. Adams, M. J. Earle, K. R. Seddon, *J. Chem. Soc., Chem. Commun.* **1999**, 1043–1044.
- 5 Y. Chauvin, L. Mussmann, H. Olivier, *Angew. Chem., Int. Ed. Engl.* **1995**, *34*, 2698–2700.
- 6 J. Howarth, *Tetrahedron Lett.* **2000**, *41*, 6627–6629.
- 7 G. S. Owens, M. M. Abu-Omar, *J. Chem. Soc., Chem. Commun.* **2000**, 1165–1166.
- 8 C. C. Brasse, U. Englert, A. Salzer, H. Waffenschmidt, P. Wasserscheid, *Organometallics* **2000**, *19*, 3818–3823.
- 9 C. J. Adams, M. J. Earle, G. Roberts, K. R. Seddon, *J. Chem. Soc., Chem. Commun.* **1998**, 2097–2098.
- 10 C. E. Song, W. H. Shim, E. J. Roh, J. H. Choi, *J. Chem. Soc., Chem. Commun.* **2000**, 1695–1696.
- 11 W. Chen, L. Xu, C. Chatterton, J. Xiao, *J. Chem. Soc., Chem. Commun.* **1999**, 1247–1248.
- 12 C. M. Gordon, A. McCluskey, *J. Chem. Soc., Chem. Commun.* **1999**, 1431–1432.
- 13 M. J. Earle, P. B. McCormac, K. R. Seddon, *Green Chemistry* **1999**, *1*, 23–25.

- 14 A. J. Carmichael, M. J. Earle, J. D. Hollbrey, P. B. McCormac, K. R. Seddon, *Org. Lett.* **1999**, *1*, 997–1000.
- 15 C. J. Mathews, P. J. Smith, T. Welton, *J. Chem. Soc., Chem. Commun.* **2000**, 1249–1250.
- 16 C. de Bellefon, E. Pollet, P. Grenouillet, *J. Mol. Catal. A-Chemical* **1999**, *145*, 121–126.
- 17 Y. Chauvin, B. Gilbert, I. Guibard, *J. Chem. Soc., Chem. Commun.* **1990**, 1715–1716.
- 18 Y. Chauvin, S. Einloft, H. Oliver, *Ind. Eng. Chem. Res.* **1995**, *34*, 1149–1155.
- 19 S. Einloft, F. K. Dietrich, R. F. de Souza, J. Dupont, *Polyhedron* **1996**, *15*, 3257–3259.
- 20 B. Ellis, W. Keim, P. Wasserscheid, *J. Chem. Soc., Chem. Commun.* **1999**, 337–338.
- 21 D. Commereuc, Y. Chauvin, G. Leger, J. Gaillard, *Revue de L'Institut Français du Pétrole* **1982**, *37*, 639–649.
- 22 D. Commereuc, Y. Chauvin, F. Hugues, L. Saussine, A. Hirschauer, *French Patent* **1988**, FR 2,611,700.
- 23 G. Odian, *Principles of Polymerization*, Wiley, New York, **1991**.
- 24 A. A. Fannin, D. A. Floreani, L. A. King, J. S. Landers, B. J. Piersma, D. J. Stech, R. L. Vaughn, J. S. Wilkes, J. L. Williams, *J. Phys. Chem.* **1984**, *88*, 2614–2621.
- 25 G. P. Smith, A. S. Dworkin, R. M. Pagni, S. P. Zingg, *J. Am. Chem. Soc.* **1989**, *111*, 5075–5077.
- 26 J. A. Boon, J. A. Levisky, J. L. Pflug, J. S. Wilkes, *J. Org. Chem.* **1986**, *51*, 480–483.
- 27 P. A. Suarez, J. E. L. Dullius, S. Einloft, R. F. de Souza, J. Dupont, *Polyhedron* **1996**, *15*, 1217–1219.
- 28 P. Wasserscheid, W. Keim, *World Patent* **1998**, WO 98/47616.
- 29 P. W. Ambler, P. K. G. Hodgson, N. J. Stewart, *European Patent* **1993**, EP 0558187.
- 30 K. Weissermel, H. -J. Arpe, *Industrial Organic Chemistry*, VCH, Weinheim, **1997**.
- 31 A. A. K. Abdul-Sada, P. W. Ambler, P. K. G. Hodgson, K. R. Seddon, N. J. Stewart, *World Patent* **1995**, WO 95/21871.
- 32 A. A. K. Abdul-Sada, K. R. Seddon, N. J. Stewart, *World Patent* **1995**, WO 95/21872.
- 33 P. M. Atkins, M. R. Smith, B. Ellis, *European Patent* **1997**, EP 0791643.
- 34 G. Roberts, C. M. Lok, C. J. Adams, K. R. Seddon, M. J. Earle, J. Hamill, *World Patent* **1998**, WO 98/07679.
- 35 V. Murphy, *World Patent* **2000**, WO 00/32658.
- 36 F. G. Sherif, L. J. Shyu, C. P. M. Lacroix, A. G. Talma, *US Patent* **1998**, US 5731101.
- 37 G. Moad, D. H. Solomon, *The Chemistry of Free Radical Polymerization*, Pergamon, Oxford, **1995**.
- 38 M. Watanabe, S. Yamada, N. Ogata, *Electrochimica Acta* **1995**, *40*, 2285–2288.
- 39 J. Fuller, A. C. Breda, R. T. Carlin, *J. Electrochem. Soc.* **1997**, *144*, L67–L70.
- 40 M. Hirao, K. Ito-Akita, H. Ohno, *Polym. Adv. Technol.* **2000**, *11*, 534–538.
- 41 H. Ohno, *Electrochimica Acta* **2001**, *46*, 1407–1411.
- 42 A. Noda, M. Watanabe, *Electrochimica Acta* **2000**, *45*, 1265–1270.
- 43 H. Zhang, L. Bu, M. Li, K. Hong, J. W. Mays, R. D. Rogers, *ACS Symposium series chapter, in press* **2001**.
- 44 A. J. Carmichael, D. A. Leigh, D. M. Haddleton, *ACS Symposium series chapter, in press* **2002**.
- 45 R. T. Carlin, R. A. Osteryoung, J. S. Wilkes, J. Rovang, *Inorg. Chem.* **1990**, *29*, 3003–3009.
- 46 R. T. Carlin, J. S. Wilkes, *J. Mol. Cat.* **1990**, *63*, 125–129.
- 47 S. D. Ittel, L. K. Johnson, M. Brookhart, *Chem. Rev.* **2000**, *100*, 1169–1203.
- 48 M. F. Pinheiro, R. S. Mauler, R. F. de Souza, *Macromol. Rapid Commun.* **2001**, *22*, 425–428.
- 49 P. Wasserscheid, C. M. Gordon, C. Hilgers, M. J. Muldoon, I. R. Dunkin, *J. Chem. Soc., Chem. Commun.* **2001**, 1186–1187.
- 50 A. Fürstner, *Angew. Chem., Int. Ed. Engl.* **2000**, *39*, 3012–3043.
- 51 M. R. Buchmeiser, *Chem. Rev.* **2000**, *100*, 1565–1604.

- 52 C. Gürtler, M. Jautelat, *European Patent* **2000**, EP 1035093.
- 53 K. Matyjaszewski, *J. Macromol. Sci., Pure Appl. Chem.* **1997**, *10*, 1785–1801.
- 54 K. Matyjaszewski, J. Xia, *Chem. Rev.* **2001**, *101*, 2921–2990.
- 55 D. M. Haddleton, D. Kukulj, A. P. Radigue, *J. Chem. Soc., Chem. Commun.* **1999**, 99–100.
- 56 D. M. Haddleton, S. G. Jackson, S. A. F. Bon, *J. Am. Chem. Soc.* **2000**, *122*, 1542–1543.
- 57 A. J. Carmichael, D. M. Haddleton, S. A. F. Bon, K. R. Seddon, *J. Chem. Soc., Chem. Commun.* **2000**, 1237–1238.
- 58 K. R. Seddon, A. Stark, M. J. Torres, *Pure Appl. Chem.* **2000**, *12*, 2275–2287.
- 59 T. Biedron, P. Kubisa, *Macromol. Rapid Commun.* **2001**, *22*, 1237–1242.
- 60 A. J. Frank, K. Honda, *J. Phys. Chem.* **1982**, *86*, 1933–1935.
- 61 R. A. Bull, F. R. Fran, A. J. Bard, *J. Electrochem. Soc.* **1983**, *130*, 1636–1638.
- 62 B. J. Feldman, P. Burgmayer, R. W. Murray, *J. Am. Chem. Soc.* **1985**, *107*, 872–878.
- 63 P. Kovacic, M. B. Jones, *Chem. Rev.* **1987**, *87*, 357–379.
- 64 V. M. Kobryanskii, S. A. Arnautov, *J. Chem. Soc., Chem. Commun.* **1992**, 727–728.
- 65 V. M. Kobryanskii, S. A. Arnautov, *Synth. Met.* **1993**, *55*, 1371–1376.
- 66 S. A. Arnautov, V. M. Kobryanskii, *Macromol. Chem. Phys.* **2000**, *201*, 809–814.
- 67 S. A. Arnautov, *Synth. Met.* **1997**, *84*, 295–296.
- 68 D. C. Trivedi, *J. Chem. Soc., Chem. Commun.* **1989**, 544–545.
- 69 L. M. Goldenberg, R. A. Osteryoung, *Synth. Met.* **1994**, *64*, 63–68.
- 70 L. Janiszewska, R. A. Osteryoung, *J. Electrochem. Soc.* **1988**, *135*, 116–122.
- 71 P. G. Pickup, R. A. Osteryoung, *J. Am. Chem. Soc.* **1984**, *106*, 2294–2299.
- 72 J. Tang, R. A. Osteryoung, *Synth. Met.* **1991**, *45*, 1–13.
- 73 L. Janiszewska, R. A. Osteryoung, *J. Electrochem. Soc.* **1987**, *134*, 2787–2794.
- 74 R. T. Carlin, R. A. Osteryoung, *J. Electrochem. Soc.* **1994**, *141*, 1709–1713.
- 75 T. A. Zawodzinski, L. Janiszewska, R. A. Osteryoung, *J. Electroanal. Chem.* **1988**, *255*, 111–117.

## 8

### Biocatalytic Reactions in Ionic Liquids

*Udo Kragl, Marrit Eckstein, and Nicole Kaftzik*

#### 8.1

##### Introduction

Biocatalytic reactions and production processes have been established as useful tools for several decades. The Reichstein process for the oxidation of D-sorbitol to L-sorbose by the use of whole microorganisms, which is still in use, was introduced as early as 1934 [1]. Several years ago, BASF introduced a lipase-catalyzed process for the kinetic resolution of chiral amines [2]. During the history of biocatalysis, alternative reaction conditions have been investigated with the goals of overcoming such problems as substrate solubility, selectivity, yield, or catalyst stability. Some progress has been made through the use of organic solvents [3, 4], the addition of high salt concentrations [5], and the use of microemulsions [6] or supercritical fluids [7]. Recently the methods of gene technology – site-directed mutagenesis and directed evolution – have added new and powerful tools for the development of better biocatalysts [8, 9]. It was thus unsurprising that researchers in the field of biocatalysis have begun to focus on ionic liquids as novel solvents in order to find new solutions to known problems.

In this chapter, we try to summarize the work so far reported in this field. We first give a short introduction into the different forms of biocatalytic reactions, highlighting some special properties of biocatalysts.

#### 8.2

##### Biocatalytic Reactions and their Special Needs

Biotechnological processes may be divided into fermentation processes and biotransformations. In a fermentation process, products are formed from components in the fermentation broth, as primary or secondary metabolites, by microorganisms or higher cells. Product examples are amino acids, vitamins, or antibiotics such as penicillin or cephalosporin. In these cases, co-solvents are sometimes used for *in situ* product extraction.



The term “biotransformation” or “biocatalysis” is used for processes in which a starting material (precursor) is converted into the desired product in just one step. This can be done by use either of whole cells or of (partially) purified enzymes. Product examples range from bulk chemicals (such as acrylamide) to fine chemicals and chiral synthons (chiral amines or alcohols, for example). There are several books and reviews dealing with the use of biotransformations either at laboratory or at industrial scales [1, 10–13].

Biocatalysts in nature tend to be optimized to perform best in aqueous environments, at neutral pH, temperatures below 40 °C, and at low osmotic pressure. These conditions are sometimes in conflict with the need of the chemist or process engineer to optimize a reaction with respect to space-time yield or high product concentration in order to facilitate downstream processing. Furthermore, enzymes and whole cells are often inhibited by products or substrates. This might be overcome by the use of continuously operated stirred tank reactors, fed-batch reactors, or reactors with *in situ* product removal [14, 15]. The addition of organic solvents to increase the solubility of substrates and/or products is a common practice [16].

Generally, there are three ways to use organic solvents or ionic liquids in a biocatalytic process:

1. as a pure solvent,
2. as a co-solvent in aqueous systems, or
3. in a biphasic system.

When either the organic solvent or the ionic liquid is used as pure solvent, proper control over the water content, or rather the water activity, is of crucial importance, as a minimum amount is necessary to maintain the enzyme’s activity. For ionic liquids, a reaction can be operated at constant water activity by use of the same methods as established for organic solvents [17]. [BMIM][PF<sub>6</sub>] or [BMIM][(CF<sub>3</sub>SO<sub>2</sub>)<sub>2</sub>N], for example, may be used as pure solvents and in biphasic systems. Water-miscible ionic liquids, such as [BMIM][BF<sub>4</sub>] or [MMIM][MeSO<sub>4</sub>], can be used in the second case.

It should be noted that, despite the success of the application of conventional organic solvents, there is no general rule as to which solvent is “enzyme friendly”. To a certain extent, the log P concept, based on the distribution coefficient between water and octanol, can be used as guideline [18]. In general, solvents with a log P value greater than 3, such as xylene (3.1) or hexane (3.9), are less deactivating than those with a low log P value, such as ethanol (−0.24). Certainly, the hydrophilicity of the co-solvent is important, as it allows interaction with and breaking of hydrogen bonds that stabilize the tertiary structure of the protein. Such interactions are very likely to occur with ionic liquids as well. Surprisingly, enzymes and even whole cells are active in various ionic liquids, as shown in Section 8.3. So far, ionic liquids have not been treated according to the log P concept. However, the polarities of ionic liquids have been investigated by different groups [19–22]. The polarities of different ionic liquids such as [BMIM][PF<sub>6</sub>] or [EMIM][(CF<sub>3</sub>SO<sub>2</sub>)<sub>2</sub>N] are similar to those of polar solvents such as ethanol or *N*-methylformamide. On Reichardt’s normalized polarity scale, ranging from 0 for tetramethylsilane to 1 for water, ionic liquids have

polarities around 0.6. Toluene (0.1) and MTBE (0.35) are less polar [22, 21] (for more details on the polarity of ionic liquids see Section 3.5). Both of these solvents are commonly used as water-immiscible solvents in enzyme catalysis. When used with whole cells, organic solvents often damage the cell membrane. So far, only little is known about the toxicity of ionic liquids, although LD<sub>50</sub> values of 1400 mg kg<sup>-1</sup> in female Wistar rats have recently been reported for 3-hexyloxymethyl-1-methylimidazolium tetrafluoroborate [23]. From this the authors concluded that tetrafluoroborates could be used safely.

When starting our first experiments with available ionic liquids, in screening programs to identify suitable systems, we encountered several difficulties such as pH shifts or precipitation. More generally, the following aspects should be taken into account when ionic liquids are used with biocatalysts:

- In some cases, impurities in the ionic liquids resulted in dramatic pH shifts, causing enzyme inactivation. This could sometimes be overcome simply by titration or higher buffer concentrations. In other cases, purification of the ionic liquid or an improved synthesis might be necessary.
- Enzymatic reactions are often performed in aqueous buffer solution; addition of increasing amounts of ionic liquids sometimes caused precipitates of unknown composition.
- To maintain enzymatic activity a minimal amount of water has to be present, best described by the water activity. However, water present in the reaction system may cause hydrolysis of some ionic liquids.
- Some enzymes require metal ions – such as cobalt, manganese or zinc – for their activity; if these are removed by the ionic liquid by complexation, enzyme inactivation may occur.
- Impurities or the ions of the liquid themselves may act as reversible or irreversible enzyme inhibitors.
- For kinetic investigations and for activity measurements, either photometric assays or – because of the higher complexity of the reactants converted by biocatalysts – HPLC methods can often be used. Here the ionic liquid itself or impurities may interfere with the analytical method.
- Unlike in the case of conventional organic solvents, most research groups prepare the ionic liquids themselves. This may be the reason why different results are sometimes obtained with the same ionic liquids. Park and Kazlauskas performed a washing procedure with aqueous sodium carbonate and found improved reaction rates, but this might also be related to a more precisely defined water content/water activity in the reaction system [22].

As with organic solvents, proteins are not soluble in most of the ionic liquids when they are used as pure solvent. As a result, the enzyme is either applied in immobilized form, coupled to a support, or as a suspension in its native form. For production processes, the majority of enzymes are used as immobilized catalysts in order to facilitate handling and to improve their operational stability [24–26]. As support, either inorganic materials such as porous glass or different organic polymers are used [27]. These heterogeneous catalyst particles are subject to internal and external

mass transport limitations, which are strongly influenced by the viscosity of the reaction medium. For [BMIM][(CF<sub>3</sub>SO<sub>2</sub>)<sub>2</sub>N], a dynamic viscosity of 52 mPa s at 20 °C has been reported [19]. For comparison, MTBE has a viscosity of only 0.34 mPa s. The viscosity can be reduced to a large extent by increasing the temperature or by addition of small amounts of an organic solvent [28] (for more information on viscosity of ionic liquids, see Section 3.2). This important aspect of the use of ionic liquids in biocatalysis warrants further study.

### 8.3

#### Examples of Biocatalytic Reactions in Ionic Liquids

Thanks to their special properties and potential advantages, ionic liquids may be interesting solvents for biocatalytic reactions to solve some of the problems discussed above. After initial trials more than 15 years ago, in which ethylammonium nitrate was used in salt/water mixtures [29], results from the use of ionic liquids as pure solvent, as co-solvent, or for biphasic systems have recently been reported. The reaction systems are summarized in Tables 8.3-1 and 8.3-2, below. Table 8.3-1 compiles all biocatalytic systems except lipases, which are shown separately in 8.3-2. Some of the entries are discussed in more detail below.

#### 8.3.1

##### Whole-cell Systems and Enzymes other than Lipases in Ionic Liquids

In 1984, Magnuson et al. (Entry 1) investigated the influence of ethylammonium/water mixtures on enzyme activity and stability [29]. At low [H<sub>3</sub>NEt][NO<sub>3</sub>] concentrations, an increased activity of alkaline phosphatase was found. The same ionic liquid was used by Flowers and co-workers, who found improved protein refolding after denaturation (Entry 2) [30].

So far only two groups have reported details of the use of ionic liquids with whole-cell systems (Entries 3 and 4) [31, 32]. In both cases, [BMIM][PF<sub>6</sub>] was used in a two-phase system as substrate reservoir and/or for *in situ* removal of the product formed, thereby increasing the catalyst productivity. Scheme 8.3-1 shows the reduction of ketones with bakers' yeast in the [BMIM][PF<sub>6</sub>]/water system.

The recovery of *n*-butanol from a fermentation broth in a similar way has been investigated by *in situ* extraction with [BMIM][PF<sub>6</sub>] (Entry 5) [33].

In the first publication describing the preparative use of an enzymatic reaction in ionic liquids, Erbedinger et al. reported the use of the protease thermolysin for the synthesis of the dipeptide Z-aspartame (Entry 6) [34]. The reaction rates were comparable to those found in conventional organic solvents such as ethyl acetate. Additionally, the enzyme stability was increased in the ionic liquid. The ionic liquid was recycled several times after the removal of non-converted substrates by extraction with water and product precipitation. Recycling of the enzyme has not been reported. It should be noted, however, that according to the log P concept described in the previous section, ethyl acetate – with a value of 0.68 – may interfere with the pro-

Table 8.3-1: Whole-cell systems and enzymes other than lipases in ionic liquids.

Entry	Biocatalyst	Ionic liquid	Reaction system	Ref.
1	Alkaline phosphatase <i>E. coli</i>	[H <sub>3</sub> NEt][NO <sub>3</sub> ]	Enzyme activity and stability assayed by hydrolysis of <i>p</i> -nitrophenol phosphate	29
2	Hen egg white lysozyme	[H <sub>3</sub> NEt <sub>3</sub> ][NO <sub>3</sub> ]	Protein renaturation	30
3	Whole cells of <i>Rhodococcus</i> R312	[BMIM][PF <sub>6</sub> ]/buffer (two-phase)	Biotransformation of 1,3-dicyanobenzene; extraction of erythromycin	31
4	Whole cells of bakers' yeast	[BMIM][PF <sub>6</sub> ]/buffer (two-phase)	Reduction of ketones	32
5	Whole cells of yeast	[BMIM][PF <sub>6</sub> ]/buffer (two-phase)	Recovery of <i>n</i> -butanol from fermentation broth	33
6	Thermolysin	[BMIM][PF <sub>6</sub> ]	Synthesis of <i>Z</i> -aspartame	34
7	$\alpha$ -Chymotrypsin	[OMIM][PF <sub>6</sub> ]	Transesterification of <i>N</i> -acetyl-L-phenylalanine ethyl ester with 1-propanol	35
8	$\alpha$ -Chymotrypsin	[BMIM][PF <sub>6</sub> ] [EMIM][BF <sub>4</sub> ] [EMIM][(CF <sub>3</sub> SO <sub>2</sub> ) <sub>2</sub> N] [BMIM][BF <sub>4</sub> ]	Transesterification of <i>N</i> -acetyl-L-tyrosine ethyl ester with 1-propanol	36
9	$\beta$ -Galactosidase subtilisin	[MTOA][CF <sub>3</sub> SO <sub>2</sub> ] <sub>2</sub> N [BMIM][BF <sub>4</sub> ]/buffer (one-phase)	Hydrolytic activity	37
10	$\beta$ -Galactosidase <i>Bacillus circulans</i>	[MMIM][MeSO <sub>4</sub> ]/buffer (one-phase)	Synthesis of <i>N</i> -acetyl-lactosamine	38
11	Peptide amidase $\beta$ -Galactosidase <i>Bacillus circulans</i>	[BMIM][MeSO <sub>4</sub> ] [MMIM][MeSO <sub>4</sub> ]	Amidation of H-Ala-Phe-OH; Synthesis of lactose by reverse hydrolysis	39
12	Formate dehydrogenase	[MMIM][MeSO <sub>4</sub> ] [4-MBP][BF <sub>4</sub> ]	Regeneration of NADH	41

Scheme 8.3-1

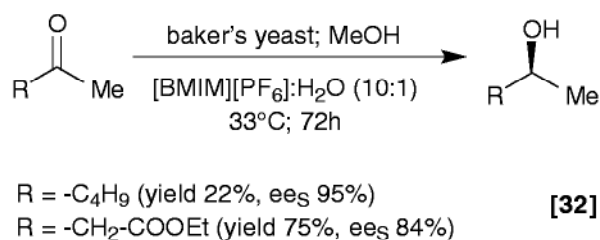

tein in an undesired way. The commercial production process for aspartame uses the soluble enzyme in an aqueous system [1].

The protease  $\alpha$ -chymotrypsin has been used for transesterification reactions by two groups (Entries 7 and 8) [35, 36]. *N*-Acetyl-L-phenylalanine ethyl ester and *N*-acetyl-L-tyrosine ethyl ester were transformed into the corresponding propyl esters (Scheme 8.3-2).

Laszlo and Compton used [OMIM][PF<sub>6</sub>] and [BMIM][PF<sub>6</sub>] and compared the results with those obtained with other organic solvents such as acetonitrile or hexane (Entry 7) [35]. They also investigated the influence of the water content on enzyme activity, as well as on the ratio of transesterification and hydrolysis. They found that, as with polar organic solvents, a certain amount of water was necessary to maintain enzymatic activity. For both ionic liquids and organic solvents, the rates were of the same order of magnitude. No data concerning the recycling of the enzyme or its stability were given.

Iborra and co-workers (Entry 8) examined the transesterification of *N*-acetyl-L-tyrosine ethyl ester in different ionic liquids and compared their stabilizing effect relative to that found with 1-propanol as solvent [36]. Despite the fact that the enzyme activity in the ionic liquids tested reached only 10 to 50 % of the value in 1-propanol, the increased stability resulted in higher final product concentrations. Fixed water contents were used in both studies.

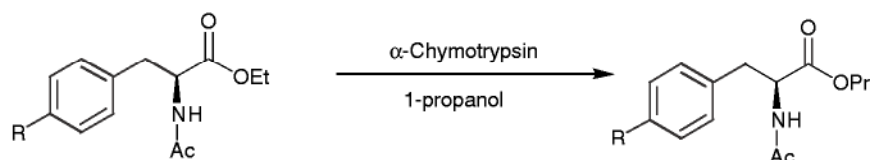

**[35]:** ionic liquid (up to 1.0% v/v H<sub>2</sub>O); 40°C

R = H

*N*-acetyl-L-phenylalanine  
ethyl ester

**[36]:** ionic liquid (2% v/v H<sub>2</sub>O); 50°C

R = OH

*N*-acetyl-L-tyrosine  
ethyl ester

Scheme 8.3-2

Husum et al. found that the hydrolytic activities of  $\beta$ -galactosidase from *E. coli* and the protease subtilisin in a 50 % aqueous solution of the water-miscible ionic liquid [BMIM][BF<sub>4</sub>] were comparable to those in 50 % aqueous solutions of ethanol or acetonitrile (Entry 9) [37].

We have studied transfer galactosylation with  $\beta$ -galactosidase from *Bacillus circulans* for the synthesis of *N*-acetyl-lactosamine, starting from lactose and *N*-acetylglucosamine (Entry 10) [38]. When the reaction is performed in an aqueous system, the problem of this approach is the secondary hydrolysis of the product by the same enzyme. As a consequence, yields are less than 30 %, and it is important to separate enzyme and product when the maximum yield is obtained. Through the addition of 25 % v/v of [MMIM][MeSO<sub>4</sub>] as a water-miscible co-solvent, the secondary hydrolysis of the product formed is effectively suppressed, resulting in a doubling of the yield to almost 60 %! Kinetic studies demonstrated that the enzyme activity was not influenced by the presence of the ionic liquid. The enzyme is stable under the conditions employed, allowing its repeated use after filtration with a commercially available ultrafiltration membrane. Further studies to explain the observed effect through analysis of the water activity are underway.

Entries 7, 8, and 10 describe so-called kinetically controlled syntheses starting from activated substrates such as ethyl esters or lactose. In two reaction systems it was possible to demonstrate that ionic liquids can also be useful in a thermodynamically controlled synthesis starting with the single components (Entry 11) [39]. In both cases, as with the results presented in entry 6, the ionic liquids were used with addition of less than 1 % water, necessary to maintain the enzyme activity. The yields observed were similar or better than those obtained with conventional organic solvents.

In order to broaden the field of biocatalysis in ionic liquids, other enzyme classes have also been screened. Of special interest are oxidoreductases for the enantioselective reduction of prochiral ketones [40]. Formate dehydrogenase from *Candida boidinii* was found to be stable and active in mixtures of [MMIM][MeSO<sub>4</sub>] with buffer (Entry 12) [41]. So far, however, we have not been able to find an alcohol dehydrogenase that is active in the presence of ionic liquids in order to make use of another advantage of ionic liquids: that they increase the solubility of hydrophobic compounds in aqueous systems. On addition of 40 % v/v of [MMIM][MeSO<sub>4</sub>] to water, for example, the solubility of acetophenone is increased from 20 mmol L<sup>-1</sup> to 200 mmol L<sup>-1</sup>.

### 8.3.2

#### Lipases in Ionic Liquids

The majority of enzymes reported so far to be active in ionic liquids belong to the class of lipases, the “work horses” of biocatalysis [11]. Designed in nature to work at aqueous/organic interfaces for the cleavage of fats and oils, making the cleavage products accessible as nutrients, lipases in general tolerate and are active in pure organic solvents. This concept has been pioneered by Klibanov and co-workers [16, 42].



Table 8.3-2: Lipases in ionic liquids.

Entry	Biocatalyst	Ionic liquid	Reaction system	Ref.
13	Lipase <i>Candida antarctica</i>	[BMIM][PF <sub>6</sub> ] [BMIM][BF <sub>4</sub> ]	Alcoholysis, aminolysis, perhydrolysis	43
14	Screening of eight lipases and two esterases	10 different ionic liquids	Kinetic resolution of ( <i>R,S</i> )-1-phenylethanol	44
15	Lipases <i>Candida antarctica</i> <i>Pseudomonas cepacia</i>	[EMIM][PF <sub>6</sub> ] [BMIM][PF <sub>6</sub> ]	Kinetic resolution of sec. alcohols	45
16	Lipase <i>Candida antarctica</i>	[EMIM][BF <sub>4</sub> ] [BMIM][(CF <sub>3</sub> SO <sub>2</sub> ) <sub>2</sub> N] [BMIM][PF <sub>6</sub> ] [EMIM][(CF <sub>3</sub> SO <sub>2</sub> ) <sub>2</sub> N] [BMIM][PF <sub>6</sub> ]	Synthesis of butyl butyrate by transesterification	46
17	Lipases <i>Candida antarctica</i> <i>Pseudomonas cepacia</i> <i>Candida rugosa</i> porcine liver	[BMIM][PF <sub>6</sub> ] [BMIM][CF <sub>3</sub> SO <sub>3</sub> ] [BMIM][BF <sub>4</sub> ] [BMIM][(CF <sub>3</sub> SO <sub>2</sub> ) <sub>2</sub> N] [BMIM][SbF <sub>6</sub> ]	Kinetic resolution of allylic alcohols	47
18	Lipases <i>Pseudomonas cepacia</i> <i>Candida antarctica</i>	Several ionic liquids; washing with aqueous sodium carbonate	Kinetic resolution of ( <i>R,S</i> )-1-phenylethanol; acylation of $\beta$ -glucose	22
19	Three lipases	[BMIM][PF <sub>6</sub> ] [BMIM][BF <sub>4</sub> ] [BMIM][(CF <sub>3</sub> SO <sub>2</sub> ) <sub>2</sub> N]	Synthesis of simple esters	37
20	Lipase <i>Pseudomonas sp.</i>	[BMIM][(CF <sub>3</sub> SO <sub>2</sub> ) <sub>2</sub> N]	Kinetic resolution of ( <i>R,S</i> )-1-phenylethanol; influence of water activity and temperature	38 48

The report from Sheldon and co-workers was the second publication demonstrating the potential use of enzymes in ionic liquids and the first one for lipases (Entry 13) [43]. They compared the reactivity of *Candida antarctica* lipase in ionic liquids such as [BMIM][PF<sub>6</sub>] and [BMIM][BF<sub>4</sub>] with that in conventional organic solvents. In all cases the reaction rates were similar for all of the reactions investigated: alcoholysis, ammoniolysis, and perhydrolysis.

Lipases and esterases are often used for kinetic resolution of racemates, variously by hydrolysis, esterification, or transesterification of suitable precursors. Scheme 8.3-3 illustrates the principal for the resolution of a secondary alcohol by esterification with vinyl acetate.

The kinetic resolution of 1-phenylethanol was investigated in our group for a set of eight different lipases and two esterases in ten ionic liquids with MTBE as reference (Entry 14) [44]. Vinyl acetate was used for the transesterification. No activity was observed for the esterases, but for the lipases from *Pseudomonas sp.* and *Alcaligenes sp.*, an improved enantioselectivity was observed in [BMIM] [(CF<sub>3</sub>SO<sub>2</sub>)<sub>2</sub>N] as solvent, in comparison to MTBE. The best results were obtained for *Candida antarctica* lipase B in [BMIM][CF<sub>3</sub>SO<sub>3</sub>], [BMIM][(CF<sub>3</sub>SO<sub>2</sub>)<sub>2</sub>N], and [OMIM][PF<sub>6</sub>]. Almost no activity was observed in [BMIM][BF<sub>4</sub>] and [BMIM][PF<sub>6</sub>], contrary to findings of other groups. This might be due to the quality of the ionic liquids we were using at that time. Other groups investigating the same system observed good activities in these ionic liquids (Entries 15–18) [22, 45–47], Park and Kazlauskas even demonstrating the influence of additional washing steps on the enzyme activity [22]. All groups reported excellent enantioselectivities. In addition to our own work, several groups reported the repeated use of the lipase after the workup procedure. In all cases the remaining substrates and formed products were extracted by use either of ether or of hexane. As a consequence of the use of these conditions, there was a slight reduction in enzyme activity after each cycle.

One particular feature of ionic liquids lies in their solvation properties, not only for hydrophobic compounds but also for hydrophilic compounds such as carbohydrates. Park and Kazlauskas reported the regioselective acylation of glucose in 99 % yield and with 93 % selectivity in [MOEMIM][BF<sub>4</sub>] (MOE = CH<sub>3</sub>OCH<sub>2</sub>CH<sub>2</sub>), values much higher than those obtained in the organic solvents commonly used for this purpose (Entry 18) [22] (Scheme 8.3-4).

Further studies of *Pseudomonas sp.* lipase revealed a strong influence of the water content of the reaction medium (Entry 20) [48]. To be able to compare the enzyme activity and selectivity as a function of the water present in solvents of different polarities, it is necessary to use the water activity ( $a_w$ ) in these solvents. We used the

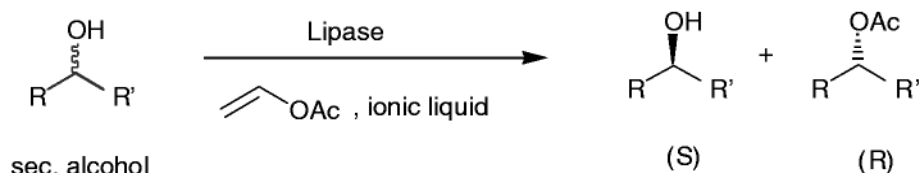

Scheme 8.3-3

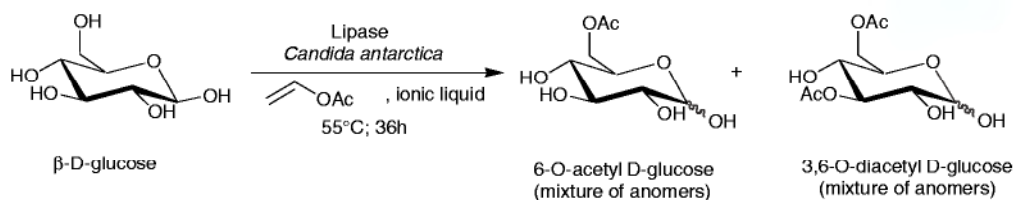

example: 1-Methoxyethyl-3-methylimidazolium ([MOEMIM]) [BF<sub>4</sub>] dissolves ~5mg/ml glucose at 55°C  
 yield 99%; selectivity: 93% 6-O-acetyl D-glucose [22]

Scheme 8.3-4

method of water activity equilibration over saturated salt solutions [49] and were able to demonstrate that, in contrast to MTBE, which is commonly used for this type of reaction, the enantioselectivity of the lipase was less influenced either by the water content or by the temperature when the reaction was performed in [BMIM][(CF<sub>3</sub>SO<sub>2</sub>)<sub>2</sub>N].

## 8.4

### Conclusions and Outlook

The results reported so far clearly demonstrate the potential of ionic liquids as solvents for biotransformations. The possible variations for tailor-made solvents may have an impact similar to that of the pioneering work of Klivanov in the use of enzymes in pure organic solvents [42]. Further studies are necessary to identify the reasons for the effects observed, such as better stability, selectivity, or suppression of side reactions. Because of their ionic nature, ionic liquids might interact with charged groups in the enzyme, either in the active site or at its periphery, causing changes in the enzyme's structure. To use ionic liquids in biocatalytic reactions in some cases requires special properties or purities, in order – for example – to avoid changes in the pH of the reaction medium.

When ionic liquids are used as replacements for organic solvents in processes with nonvolatile products, downstream processing may become complicated. This may apply to many biotransformations in which the better selectivity of the biocatalyst is used to transform more complex molecules. In such cases, product isolation can be achieved by, for example, extraction with supercritical CO<sub>2</sub> [50]. Recently, membrane processes such as pervaporation and nanofiltration have been used. The use of pervaporation for less volatile compounds such as phenylethanol has been reported by Crespo and co-workers [51]. We have developed a separation process based on nanofiltration [52, 53] which is especially well suited for isolation of non-volatile compounds such as carbohydrates or charged compounds. It may also be used for easy recovery and/or purification of ionic liquids.

There is still a long way to go before ionic liquids can become commonly used in biocatalysis. This will require:

- demonstration of stability and recyclability over prolonged periods of times under the reaction conditions applied,
- investigation of mass transport limitations for biocatalysts immobilized on heterogeneous supports, and
- the development of suitable methods for product isolation if they are of limited or no volatility.

## References

- 1 A. Liese, K. Seelbach, C. Wandrey, *Industrial Biotransformations*, Wiley-VCH, Weinheim, 2000.
- 2 F. Balkenhol, K. Ditrich, B. Hauer, W. Lander, *J. Prakt. Chem.* **1987**, 339, 381.
- 3 G. Carrea, S. Riva, *Angew. Chem. Int. Ed.* **2000**, 39, 2226.
- 4 J. M. S. Cabral, M. R. Aires-Barros, H. Pinheiro, D. M. F. Prazeres, *J. Biotechnol.* **1997**, 59, 133.
- 5 A. M. Blinkorsky, Y. L. Khmelnitzky, J. S. Dordick, *J. Am. Chem. Soc.* **1999**, 116, 2697.
- 6 B. Orlich, R. Schomäcker, *Biotechnol. Bioeng.* **1999**, 65, 357.
- 7 T. Hartmann, E. Schwabe, T. Scheper, "Enzyme catalysis in supercritical fluids" in R. Patel, *Stereoselective Biocatalysis*, Marcel Dekker, 2000, 799.
- 8 U. T. Bornscheuer, M. Pohl, *Curr. Opin. Chem. Biol.* **2001**, 5, 137.
- 9 F. Arnold, *Nature* **2001**, 409, 253.
- 10 K. Faber, *Biotransformations in Organic Chemistry*, Springer, Berlin, 2000.
- 11 U. T. Bornscheuer, R. J. Kazlauskas, *Hydrolases in Organic Synthesis*, Wiley-VCH, Weinheim, 1999.
- 12 R. Patel, *Stereoselective Biocatalysis*, Marcel Dekker, 2000.
- 13 A. Schmid, J. S. Dordick, B. Hauer, A. Kiener, M. Wubbolts and B. Witholt, *Nature* **2001**, 409, 258.
- 14 J. E. Bailey and D. F. Ollis, *Biochemical Engineering Fundamentals*, McGraw-Hill, New York, 1986.
- 15 U. Kragl, and A. Liese, in *Encyclopedia of Bioprocess Technology*, edited by M. C. Flickinger and S. W. Drew, Wiley, New York, 454, 2000.
- 16 A. Klibanov, *Nature* **2001**, 409, 241.
- 17 R. H. Valivety, P. J. Halling, *Biochim. Biophys. Acta* **1992**, 1118, 218.
- 18 C. Laane, S. Boeren, R. Hilhorst and C. Veeger, in *Biocatalysis in organic media* (C. Laane, J. Tramper, M. D. Lilly eds.), Elsevier, Amsterdam, 1987.
- 19 P. Bonhôte, A. P. Dias, K. Papageorgiou, M. Grätzel, *Inorg. Chem.* **1996**, 35, 1168.
- 20 A. J. Carmichael, K. R. Seddon, *J. Phys. Org. Chem.* **2000**, 13, 591.
- 21 S. Aki, J. Brenneke, A. Samanta, *Chem. Comm.* **2001**, 413.
- 22 S. Park, R. J. Kazlauskas, *J. Org. Chem.* **2001**, 66, 8395.
- 23 J. Pernak, A. Czepukowicz, R. Pozniak, *Ind. Eng. Chem. Res.* **2001**, 40, 2379.
- 24 U. Kragl, L. Greiner and C. Wandrey, in *Encyclopedia of Bioprocess Technology* (M. C. Flickinger, S. W. Drew eds.), Wiley, New York, 1064, 2000.
- 25 W. Tischer, V. Kasche, *Trends Biotechnol.* **1999**, 17, 326.
- 26 E. Katchalski-Katzip, D. M. Kraemer, *J. Mol. Cat. B* **2000**, 10, 157.
- 27 W. Keim and B. Driessen-Hölscher in *Handbook of Heterogeneous Catalysis* (G. Ertl, H. Knözinger, J. Weitkamp eds.), Wiley-VCH, Weinheim, 231, 1997.
- 28 P. Wasserscheid, W. Keim, *Angew. Chem. Int. Ed.* **2000**, 112, 3926.
- 29 D. K. Magnuson, J. W. Bodley, D. F. Evans, *J. Solution Chem.* **1984**, 13, 583.
- 30 C. A. Summers, R. A. Flowers, *Protein Science* **2000**, 9, 2001.
- 31 S. G. Cull, J. D. Holbrey, V. Vargas-Mora, K. R. Seddon, G. J. Lye, *Biotechnol. Bioeng.* **2000**, 69, 227.
- 32 J. Howarth, P. James, J. Dai, *Tetrahedron Lett.* **2001**, 42, 7517.
- 33 A. G. Fadeev, M. M. Meagher, *Chem. Comm.* **2001**, 295.

- 34 M. Erbdinger, A. J. Mesiano, A. J. Russel, *Biotechnol. Prog.* **2000**, *16*, 1129.
- 35 J. A. Laszlo, D. L. Compton, *Biotechnol. Bioeng.* **2001**, *75*, 181.
- 36 P. Lozano, T. de Diego, J.-P. Guegan, M. Vaultier, J. L. Iborra, *Biotechnol. Bioeng.* **2001**, *75*, 563.
- 37 T. L. Husum, C. T. Jorgensen, M. W. Morten, O. Kirk, *Biocatal. Biotransform.* **2001**, *19*, 331.
- 38 U. Kragl, N. Kaftzik, S. H. Schöfer, M. Eckstein, P. Wasserscheid, C. Hilgers, *CHIMICA OGGI/Chemistry Today* **2001**, *7/8*, 22–24.
- 39 N. Kaftzik, S. Neumann, M.-R. Kula, U. Kragl, submitted.
- 40 M. R. Kula, U. Kragl, "Dehydrogenases in the synthesis of chiral compounds" in R. Patel, *Stereoselective Biocatalysis*, Marcel Dekker, **2000**, 839.
- 41 N. Kaftzik, unpublished results.
- 42 A. M. Klivanov, *CHEMTECH* **1986**, *16*, 354.
- 43 R. Madeira Lau, F. van Rantwijk, K. R. Seddon, R. A. Sheldon, *Org. Lett.* **2000**, *2*, 4189.
- 44 S. Schöfer, N. Kaftzik, P. Wasserscheid, U. Kragl, *Chem. Comm.* **2001**, 425.
- 45 K.-W. Kim, B. Song, M.-Y. Choi, M.-J. Kim, *Org. Lett.* **2001**, *3*, 1507.
- 46 P. Lozano, T. de Diego, D. Carrie, M. Vaultier, J. L. Iborra, *Biotechnol. Lett.* **2001**, *23*, 1529.
- 47 T. Itoh, E. Akasaki, K. Kudo, S. Shirakami, *Chem. Lett.* **2001**, 262.
- 48 M. Eckstein, P. Wasserscheid, U. Kragl, *Biotechnol. Lett.* **2002**, *24*, 763.
- 49 H. L. Goderis, G. Ampe, M. P. Feyten, B. L. Fouwe, W. M. Guffens, S. M van Cauwenberg, P. P. Tobback, *Biotechnol. Bioeng.* **1987**, *30*, 258.
- 50 L. A. Blanchard, J. F. Brennecke, *Ind. Eng. Chem. Res.* **2001**, *40*, 287.
- 51 T. Schäfer, C. M. Rodrigues, C. A. M. Afonso, J. G. Crespo, *Chem. Comm.* **2001**, 1622.
- 52 G. Dudziak, S. Fey, L. Hasbach, U. Kragl, *J. Carbohydr. Chem.* **1999**, *18*, 41.
- 53 J. Kröckel, unpublished results.

## 9

### Outlook

*Peter Wasserscheid and Tom Welton*

It has been our intention in the eight preceding chapters to provide the essential information for a deep understanding of the nature of ionic liquids as well as a comprehensive review of all different synthetic applications that have so far benefited from ionic liquid technology. For some areas the use of ionic liquids seems to be still in its infancy and – despite some promising results – absolute proof of superiority over existing technology is still lacking. In other areas, however, substantial advantages in the replacement of common catalysts or solvents with ionic liquids have already been demonstrated. We now wish to look to the future. However, it is difficult, and probably foolish, to try to predict what will be discovered in the next few years. In fact, the most exciting part of any new science is its ability to cause surprises. So we have taken the approach of trying to answer the questions that we are most commonly asked when telling people about ionic liquids for the first time.

*What is going to be the first area of broad, commercial ionic liquid application?* This is probably the question most frequently asked of everybody who is active in developing ionic liquid methodology. The answer is not easy to give. Some petrochemical processes are ready to be licensed or are in pilot plant development (as described in Section 5.2), but there is still some time needed to bring these applications on stream and to claim a broad replacement of existing technologies by ionic liquids in this area. For some non-synthetic applications, in contrast, the lead time from the first experiments to full technical realization is much shorter.

For example, Novasina S.A. ([www.novasina.com](http://www.novasina.com)), a Swiss company specializing in the manufacture of devices to measure humidity in air, has developed a new sensor based on the non-synthetic application of an ionic liquid. The new concept makes simple use of the close correlation between the water uptake of an ionic liquid and its conductivity increase. In comparison with existing sensors based on polymer membranes, the new type of ionic liquid sensor shows significantly faster response times (up to a factor of 2.5) and less sensitivity to cross contamination (with alcohols, for example). Each sensor device contains about 50  $\mu\text{l}$  of ionic liquid, and the new sensor system became available as a commercial product in 2002. Figure 9-1 shows a picture of the sensor device containing the ionic liquid, and Figure 9-2 displays the whole humidity analyzer as commercialized by Novasina S.A..



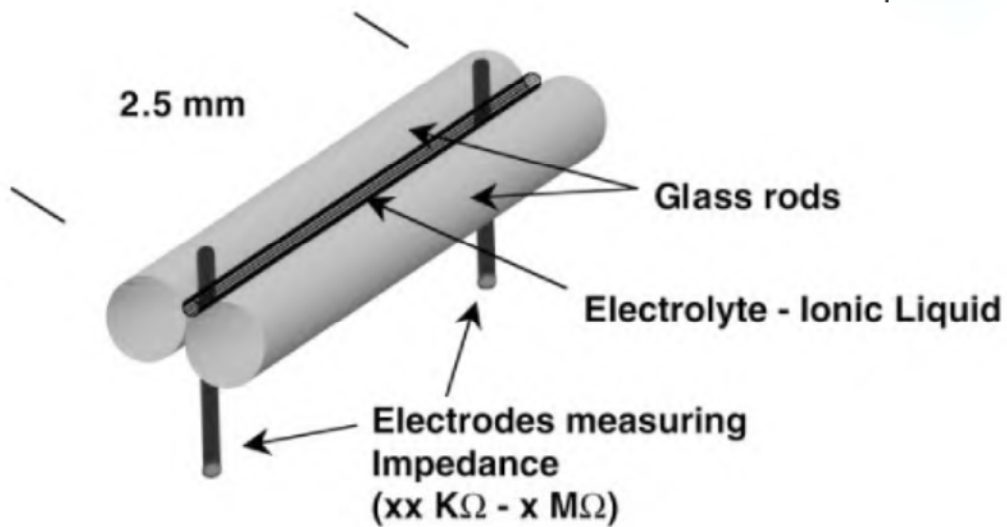

**Figure 9-1:** Sensor device for measurement of relative humidity, containing an ionic liquid as electrolyte (with permission of Novasina S.A.)

This is only one of some very promising potential non-synthetic applications of ionic liquids that have emerged recently. Many others – some more, some less fully documented in patent or scientific literature – have been published. Table 9-1 gives a few examples, showing that most of the non-synthetic applications of ionic liquids can be grouped into three areas. Electrochemical applications benefit from the wide electrochemical window of ionic liquids and/or from the distinct variation of con-

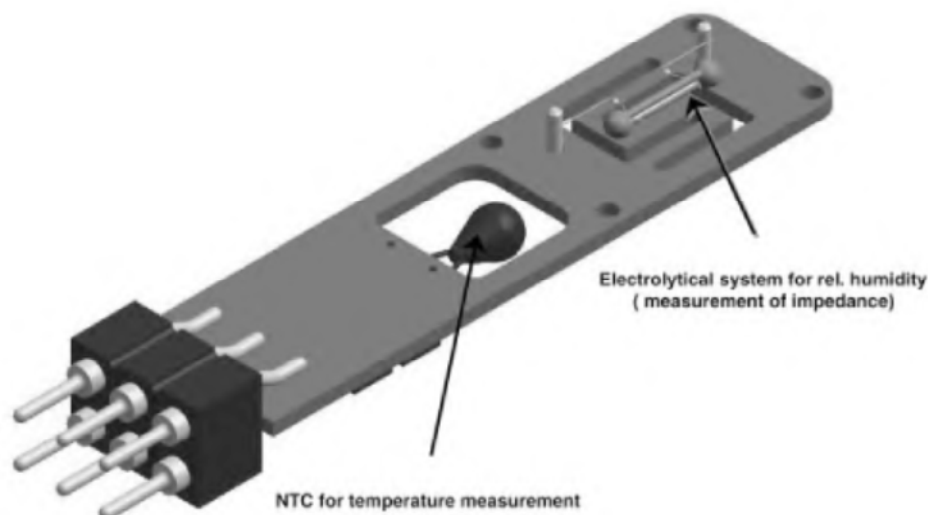

**Figure 9-2:** High-precision CC-1 measurement cell for measurement of relative humidity and temperature including an ionic liquid as “sensing” electrolyte, as commercialized by Novasina S.A. (with permission of Novasina S.A.).

ductivity if substances are dissolved in them. Analytical applications often profit from the special solubility properties of ionic liquids. Applications in which ionic liquids are used as novel “engineering fluids” are based on their solubility properties, their thermal properties, their mechanical properties, or the special mixture of all these that is provided by some ionic liquids. All applications displayed in Table 9-1 make use – to a greater or lesser extent – of the nonvolatile character of the ionic liquids.

Actually, it is quite likely that the first area of broader technical ionic liquid use will indeed be a non-synthetic application. Why? Certainly not because non-synthetic applications have shown more potential, more performance, or more possibilities, but because many of these are relatively simple, with clearly defined technical targets. The improvement over existing technology is often based on just one or a very few specific properties of the ionic liquid material, whereas for most synthetic appli-

**Table 9-1:** Non-synthetic application of ionic liquids – selected examples and references.

<i>Application</i>	<i>Research group</i>	<i>Reference</i>
<i>Electrochemical applications</i>		
Ionic liquids as active component in sensors	Dai et al.	1
Ionic liquids as electrolyte in batteries	Caja et al.	2
Electrodeposition of metals from ionic liquids	Endres	3
<i>Analytic applications</i>		
Ionic liquid as matrix for mass spectroscopy	Armstrong et al.	4
Ionic liquid as stationary phase for gas chromatography	Armstrong et al.	5, 6
<i>“Engineering liquids”</i>		
Ionic liquid as heat carrier and thermofluid	Wilkes et al.	7
Ionic liquid as lubricant	Liu et al.	8
Ionic liquid as antistatic	Pernak et al.	9
Ionic liquids as liquid crystals	Seddon, Holbrey, Gordon et al.	10, 11
Ionic liquids as solvents for extraction	<i>Ionic liquid/aqueous</i>	
	Rogers et al.	12, 13, 14, 15
	Dietz et al.	16
	Dai et al.	17
Ionic liquid as active layer in supported liquid phase membranes for gas separation	<i>Ionic liquid/hydrocarbon</i>	
	Jess et al.	18
Ionic liquid as active layer in supported liquid phase membranes for gas separation	Melin, Wasserscheid, et al.	19, 20

cations a complex mixture of physicochemical properties in dynamic mixtures has to be considered. So the question of why non-synthetic applications of ionic liquids today look so promising with regard to their technical development can be answered in that these are just quicker and easier to develop, since they do not require the same degree of knowledge about the complex nature of the ionic liquid material.

At this stage of development, knowledge of ionic liquid properties is patchy, to say the least. For some applications only limited, very specific information is needed to allow the translation of a research project into technical reality (mostly non-synthetic applications). For others (mostly synthetic applications), a lot more detailed information, skills, and data are required to make the technology feasible. This process takes time, even though the ever growing ionic liquid community has already added a lot of information to the ionic liquid “toolbox”.

Several of the examples in Table 9-1 are looking quite promising for technical realization on a short to medium timescale. Other ideas are still in their infancy, and there is still a lot of potential for the development of other new non-synthetic applications of ionic liquids in the years to come.

*How does one identify a promising non-synthetic application for ionic liquid technology?* We basically expect that, in all non-synthetic, high value-adding applications, in which the application of an ionic liquid achieves some unique and superior performance of a technical device, ionic liquid technology may have a very good chance of quick and successful introduction.

In this book we have decided to concentrate on purely synthetic applications of ionic liquids, just to keep the amount of material to a manageable level. However, we think that synthetic and non-synthetic applications (and the people doing research in these areas) should not be treated separately for a number of reasons. Each area can profit from developments made in the other field, especially concerning the availability of physicochemical data and practical experience of development of technical processes using ionic liquids. In fact, in all production-scale chemical reactions some typically non-synthetic aspects (such as the heat capacity of the ionic liquid or product extraction from the ionic catalyst layer) have to be considered anyway. The most important reason for close collaboration by synthetic and non-synthetic scientists in the field of ionic liquid research is, however, the fact that in both areas an increase in the understanding of the ionic liquid material is the key factor for successful future development.

*Why is lack of understanding still the major limitation for the development of ionic liquid methodology?* After having read the preceding eight chapters you will probably agree that ionic liquids are complex liquid materials. The detailed study of ionic liquids is still in its infancy, and there has simply been insufficient time to accumulate large amounts of good quality data on a wide range of liquids. Also, the fact that we are beginning to understand more about the basic nature of these materials in their pure form still does not answer the question of what happens to substances dissolved in the ionic liquid. This, though, is what all chemical reactions in ionic liquids are about. To give a very simplistic idea of this important point we can consider that a pure ionic liquid may be regarded – more or less – as big packages of cations

and anions (see self-diffusion measurements and electrical conductivity measurements in Chapters 3 and 4). However, a very dilute solution of an ionic liquid in a molecular solvent (or substrate or product) will probably be much more like ion-pairs dissolved in the solvent. Is this still an ionic liquid then? Probably not. Can it still have some of the typical ionic liquid features (such as activation, solvation of ionic species, etc.)? Maybe. This leads to questions such as: what is the critical concentration of the ionic liquid in such a solution (e.g., with the substrate/product during a chemical reaction) for the system to display ionic liquid-like behavior? Or how do the physicochemical properties of the pure ionic liquid change in the reaction mixture when reactants are dissolved in the medium?

A few examples from the literature should illustrate this aspect further. Seddon et al., for example, have described the great influence of relatively small amounts of impurities on the physicochemical properties of ionic liquids [21]. Chauvin found that traces of  $\text{Cl}^-$  ion impurities prevented rhodium-catalyzed hydrogenation of olefins [22], whereas Welton found that the same impurities were needed in order to allow the Suzuki reaction to proceed [23]. Song et al. reported significant activation of an Mn(salen) complex in a solution consisting of 20 volume% of ionic liquid in  $\text{CH}_2\text{Cl}_2$  versus pure  $\text{CH}_2\text{Cl}_2$  [24]. Wasserscheid et al. found that the strength of diastereomeric interactions between a chiral ionic liquid and a chiral substrate was strongly dependent on the concentration of the substrate in the ionic liquid [25].

Of course, these concentration effects will be highly dependent on the nature of the substrate dissolved in the ionic liquid, as well as on the nature of the ionic liquid's cation and anion. Given the enormous opportunity to vary these last two, it becomes clear that a detailed understanding of the role of the ionic liquid in reaction mixtures is far from complete. Clearly, this limited understanding is currently restricting our opportunities to benefit from the full potential of an ionic liquid solvent in a given synthetic application.

One frequently discussed idea by which to overcome the lack of available data and understanding on a short time range is to pick one, "universal" ionic liquid and to study this one in very great detail, instead of developing many new systems (combined with an obvious lack in detailed information about these).

*Is there a "universal" ionic liquid at the present state of development?* The answer is clearly no. Many of the ionic liquids commonly in use have very different physical and chemical properties (see Chapter 3) and it is absolutely impossible that one type of ionic liquid could be used for all synthetic applications described in Chapters 5–8. In view of the different possible roles of the ionic liquid in a given synthetic application (e.g., as catalyst, co-catalyst, or innocent solvent) this point is quite obvious. However, some properties, such as nonvolatility, are universal for all ionic liquids. So the answer becomes, if the property that you want is common to all ionic liquids, then any one will do. If not, you will require the ionic liquid that meets your needs.

Nevertheless, a certain process of focussing can be expected in the future. The authors expect that this process will give rise to two different groups of ionic liquids that will be routinely used throughout academia and industry.

The first group is expected to fall under the definition of “bulk ionic liquids”. This means a class of ionic liquids that is produced, used, and somehow consumed in larger quantities (>100 liter ionic liquid consumption per application unit per year). Applications for these ionic liquids are expected to be as solvents for organic reactions, homogeneous catalysis and biocatalysis, and other synthetic applications with some ionic liquid consumption: heat carriers, lubricants, additives, new surfactants, new phase-transfer catalysts, extraction solvents, solvents for extractive distillation, antistatics, etc. These “bulk ionic liquids” would be relatively cheap (around €30 per liter), halogen-free (e.g., for easy disposal of spent ionic liquid) and toxicologically well characterized (a preliminary study about the acute toxicity of a non-chloroaluminate ionic liquid has recently been published [9]). We expect that, of all ionic liquids meeting these requirements, only a very limited number of candidates will be selected for the described applications. However, these candidates will become well characterized and – because of their larger production quantities – readily available.

On the other hand, we also anticipate a wider range of highly specialized ionic liquids that will be produced and consumed in smaller quantities (<100 liter ionic liquid consumption per application unit per year). Fields of applications for these highly specialized ionic liquids are expected to be as special solvents for organic synthesis, homogeneous catalysis, biocatalysis and all other synthetic applications with very low ionic liquid consumption (due, for example, to very efficient multiphase operation), catalytically active ionic liquids with low catalyst consumption, analytic devices (stationary or mobile phases for chromatography, matrixes for MS, etc.), sensors, batteries, electrochemical baths for electrodeposition, etc. This group will contain all sophisticated and relatively expensive ionic liquids, such as task-specific ionic liquids, chiral ionic liquids, expensive fluorine-containing anions, etc. Here we expect that the ionic liquid will be designed and optimized for the best performance in each specific high-value-adding application. Consequently, only scientists’ imaginations will limit the number of ionic liquids used in this group.

*Which type of reaction should be studied in an ionic liquid?* This is another frequently asked question, which is of course closely related to the question of which ionic liquid to use. As mentioned before, not all chemistry will make sense in all types of ionic liquid.

We are far here from aiming to advise anybody about future research projects. The only message that we would like to communicate is that a chemical reaction is not necessarily surprising or important because it somehow works as well in an ionic liquid. One should look for those applications in which the specific properties of the ionic liquids may allow one to achieve something special that has not been possible in traditional solvents. If the reaction can be performed better (whatever *you* may mean by that) in another solvent, then use that solvent. In order to be able to make that judgement, it is imperative that we all include comparisons with molecular solvents in our studies, and not only those that we know are bad, but those that are the best alternatives.

*What reaction can be carried out in an ionic liquid that is not possible in organic solvents or water?* Many convincing examples have been described in Chapters 5–8.



These should not be repeated here. To identify new examples, the easiest way is probably to start from a detailed understanding of the special properties of the ionic liquid material and to identify promising research fields from this point. Two successful examples from the past should illustrate this approach in more detail.

The fact that ionic liquids with weakly coordinating anions can combine, in a unique manner, relatively high polarity with low nucleophilicity allows biphasic catalysis with highly electrophilic, cationic Ni-complexes to be carried out for the first time [26].

The wide electrochemical windows of ionic liquids, in combination with their ability to serve as solvents for transition metal catalysts, opens up new possibilities for a combination of electrochemistry and transition metal catalysis. A very exciting first example has recently been published by Bedioui et al. [27].

There is still a lot of potential for new and somehow unique synthetic chemistry in ionic liquids, but understanding is crucial to develop the right ideas. We are still at the very beginning. A lot of exciting chemistry is still to be done in ionic liquids!

## References

- 1 S. Dai, C. Liang, *Abstracts of Papers, 222nd ACS National Meeting, Chicago, IL, United States, August 26–30 2001*, ANYL.
- 2 J. Caya, T. D. J. Dunstan, D. M. Ryan, V. Katovic, *Proc. Electrochem Soc.* **2000**, 99-41 (Molten Salts XII), 150.
- 3 F. Endres, *Phys. Chem. Chem. Phys.* **2001**, 3, 3165–3174.
- 4 D. W. Armstrong, L.-K. Zhang, L. He, M. L. Gross, *Anal. Chem.* **2001**, 73(15), 3679–3686.
- 5 D. W. Armstrong, L. He, Y.-S. Liu, *Anal. Chem.* **1999**, 71(17), 3873–3876.
- 6 A. Berthod, L. He, D. W. Armstrong, *Chromatographia* **2001**, 53(1/2), 63–68.
- 7 M. L. Mutch, J. S. Wilkes, *Proc. Electrochem. Soc.* **1998**, 98-11 (Molten Salt XI), 254.
- 8 C. Ye, W. Liu, Y. Chen, L. Yu, *Chem. Commun.* **2001**, 2244–2245.
- 9 J. Pernak, A. Czepukowicz, R. Pozniak, *Ind. Eng. Chem. Res.* **2001**, 40, 2379–2383.
- 10 J. D. Holbrey, K. R. Seddon, *J. Chem. Soc., Dalton Trans.* **1999**, 13, 2133–2140.
- 11 C. M. Gordon, J. D. Holbrey, A. R. Kennedy, K. R. Seddon, *J. Mater. Chem.* **1998**, 8(12), 2627–2736.
- 12 J. G. Huddleston, R. D. Rogers, *Chem. Commun.* **1998**, 1765–1766.
- 13 A. E. Visser, R. P. Swatloski, S. T. Griffin, D. H. Hartman, R. D. Rogers, *Sep. Technol.* **2001**, 36, 785–804.
- 14 A. E. Visser, R. P. Swatloski, W. M. Reichert, J. H. Davis, Jr., R. D. Rogers, R. Mayton, S. Sheff, A. Wierzbicki, *Chem. Commun.* **2001**, 135–136.
- 15 A. E. Visser, R. P. Swatloski, M. W. Reichert, S. T. Griffin, R. D. Rogers, *Ind. & Eng. Res.* **2000**, 39(10), 3596–3604.
- 16 M. L. Dietz, J. A. Dzielawa, *Chem. Commun.* **2001**, 2124–2125.
- 17 S. Dai, Y. H. Ju, C. E. Barnes, *J. Chem. Soc., Dalton Trans.* **1999**, 8, 1201–1202.
- 18 A. Bösmann, L. Datsevitch, A. Jess, A. Lauter, C. Schmitz, P. Wasserscheid, *Chem. Commun.* **2001**, 2494–2495.
- 19 M. Medved, P. Wasserscheid, T. Melin, *Proceedings of the 8th Aachener Membran Kolloquium*, **2001**, II-123.



- 20 M. Medved, P. Wasserscheid, T. Melin, *Chem.-Ing.-Techn.* **2001**, *73*, 715.
- 21 K. R. Seddon, A. Stark, M.-J. Torres, *Pure Appl. Chem.* **2000**, *72*, 2275–2287.
- 22 Y. Chauvin, L. Mussmann, H. Olivier, *Angew. Chem., Int. Ed. Engl.* **1995**, *34*, 2698–2700.
- 23 C. Mathews, P. J. Smith, T. Welton, *Chem. Commun.* **2000**, 1249–1250.
- 24 E. C. Song, E. J. Roh, *Chem. Commun.* **2000**, 837–838.
- 25 P. Wasserscheid, A. Bösmann, C. Bolm, *Chem. Commun.* **2002**, 200–201.
- 26 P. Wasserscheid, C. M. Gordon, C. Hilgers, M. J. Muldoon, I. R. Dunkin, *Chem. Commun.* **2001**, 1186–1187.
- 27 L. Gaillon, F. Bedioui, *Chem. Commun.* **2001**, 1458–1459.